



PCE Americas Inc.
711 Commerce Way
Suite 8
Jupiter
FL-33458
USA
From outside US: +1
Tel: (561) 320-9162
Fax: (561) 320-9176
info@pce-americas.com

PCE Instruments UK Ltd.
Units 12/13
Southpoint Business Park
Ensign way
Hampshire / Southampton
United Kingdom, SO31 4RF
From outside UK: +44
Tel: (0) 2380 98703 0
Fax: (0) 2380 98703 9
info@industrial-needs.com

www.pce-instruments.com/english
www.pce-instruments.com

Manual

Colorimeter PCE-CSM 7



Version 1.1
Date of creation: 05.10.2015
Date of last change: 27.12.2016

Contents

1	Introduction	3
2	Safety notes	3
3	Specification	4
3.1	Technical specifications	4
3.2	Contents of delivery	4
4	System description	5
4.1	Button description	5
4.2	Interfaces	5
4.3	Battery	6
4.4	Change the measuring aperture	7
5	Operation	8
5.1	Turn on the device	8
5.2	Take a measurement	8
5.3	Additional functions	9
5.3.1	Records	9
5.3.2	Calibration	10
5.3.3	Connection to a PC	11
5.3.4	Tolerances	11
5.3.5	Delete recorded data	11
5.3.6	Averaging	12
5.3.7	Display mode	12
5.3.8	Date/Time setting	12
5.3.9	Light source	13
5.3.10	Specular reflection	13
5.3.11	Language	13
6	Settings	13
6.1	Colour offset	13
6.2	Auto save	13
6.3	Aperture settings	13
6.4	Colour difference formula	13
6.5	Backlight	14
6.6	Contrast	14
6.7	Restore factory set	14
7	Optional Accessories	15
7.1	Powder test box PCE-CSM PTB	15
7.1.1	Structure	15
7.1.2	Operation	15
7.2	Measuring device for liquids, pastes and powders PCE-CSM UTC	16
7.2.1	Structure	16
7.2.2	Operation	17
8	Contact	19
8.1	PCE Instruments UK	19
8.2	PCE Americas	19

1 Introduction

Thank you for purchasing a colour meter from PCE Instruments.

The colour meter PCE-CSM 7 is an ideal measuring device for application in quality control and offers high accuracy. When using the colour meter, there are different colour spaces available (CIE L*a*b*C*h, L*a*b, XYZ, RGB, L*u*v, C*H). The colour meter PCE-CSM 7 also comes with two different measuring apertures (Ø4 mm and Ø8 mm) for different applications. After a measurement with the PCE-CSM 7, the reading can be used as a standard value. Other readings can be recorded as a sample and later be compared to the reference value. In addition to the individual colour space coordinates, the deviation between the readings is also displayed. On the internal memory of the colour meter, you can store up to 100 reference values and up to 20,000 samples. The measured data can also be transferred to a PC via USB and analysed with the included PC software.

2 Safety notes

Please read this manual carefully and completely before you use the device for the first time. The device may only be used by qualified personnel and repaired by PCE Instruments personnel. There is no warranty of damages or injuries caused by non-observance of the manual.

- This colour meter is a precise measuring device. Please avoid strong changes in the environmental conditions. This includes flickering lights as well as changes of the air temperature or air humidity.
- The device may only be used in the approved temperature range.
- Make sure the device is standing right on the measuring spot. Do not move it while the measuring procedure is in progress. Avoid shocks.
- Do not expose the device to water. Only use it in areas which fulfil the permitted environmental conditions.
- Keep the device clean and prevent dust or other particles from entering the measuring aperture.
- To clean the device, use a damp cloth. Do not use solvent-containing materials for cleaning.
- The case should only be opened by qualified personnel of PCE Instruments.
- You must not make any technical changes to the device.
- The instrument should never be placed with the user interface facing an object (e. g. keyboard side on a table).
- Only use the battery which is included in the package (3.7 V, 0.5 A).
- If you do not need the device for a longer period of time, please reset the white calibration and store it in the carrying case.

This user's handbook is published by PCE Instruments without any guarantee.

We expressly point to our general guarantee terms which can be found in our general terms of business.

If you have any questions please contact PCE Instruments.

3 Specification

3.1 Technical specifications

Measuring aperture	Ø 8 mm / Ø 4 mm
Measuring geometry	8°/d
Sensor	Silicon photoelectric diode
Colour spaces	CIE L*a*b*C*h CIE L*a*b CIE XYZ CIE RGB CIE L*u*v CIE*C*H Whiteness & yellowness Colour fastness Staining fastness
Colour difference formula	ΔE^*ab , ΔL^*ab , ΔE^*C^*H , ΔE_{CIE94} , ΔE_{Hunter}
Observer	CIE 10°
Measuring range	L: 0 ... 100
Errors between devices	$\leq 0.40 \Delta E^*ab$
Standard deviation	Within ΔE^*ab 0.06
Repeatability	Average of 30 measurements of standard white plate
Light source	D65, D50, A
Lamp life	5 years, more than 1.6 million measurements
Display	TFT 2.8 " (16:9)
Storage	100 reference values (standards), 20,000 samples
Interface	USB
Power supply	Rechargeable lithium-ion battery 3.7 V at 3,200 mAh
Charging time	2 h (8 h at first use)
Battery life	>3,000 measurements
Operating conditions	Temperature: 0 ... +40 °C Humidity: 0 ... 85 % RH, non-condensing
Storing conditions	Temperature: 0 ... +50 °C Humidity: 0 ... 85 % RH, non-condensing
Dimensions	205 x 70 x 100 mm
Weight	500 g

3.2 Contents of delivery

- 1 x colour meter PCE-CSM 7
- 1 x 4 mm aperture
- 1 x 8 mm aperture
- 1 x USB cable
- 1 x aluminium carrying case
- 1 x lithium-ion battery
- 1 x battery charger
- 1 x mains adaptor
- 1 x calibration cover
- 1 x PC software
- 1 x instruction manual

4 System description

4.1 Button description



4.2 Interfaces



- Power button: Press this button to turn on the device (button lock in place). Press the button again to turn off the device (button unlocks).
- DC interface: Only use the mains adaptor included in the package. If it breaks down, only use substitutions with the following characteristics: output 5 V DC, 2 A.
- USB/RS-232 interface: By using the USB interface, you can transfer data from the colour meter to a PC. The baud rate is 115,200 bps.

4.3 Battery

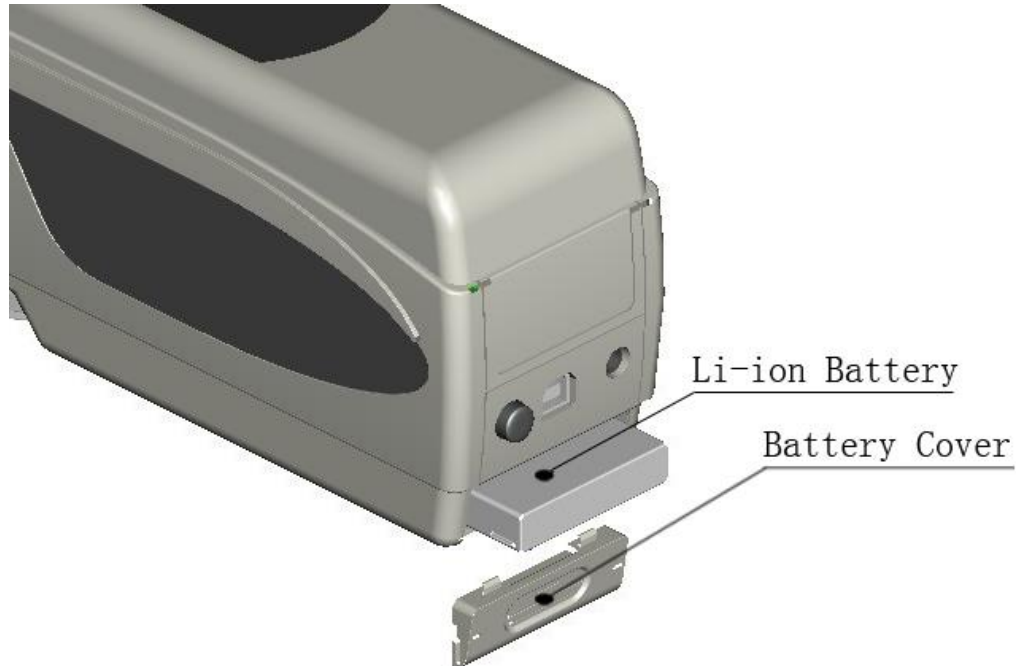

Installing the battery

1. Make sure that the colour meter is turned off.
2. Open the cover of the battery compartment.
3. Insert the battery into the allocated space.
4. Close the cover of the battery compartment.

Charging the battery

The battery can only be charged when the colour meter is connected to a PC or to the mains adaptor. When charging the battery, a dynamic charging indication appears in the top right corner of the display.

Note: If the battery is damaged, the device can still be used via an external power source (PC / mains adaptor).

4.4 Change the measuring aperture

Remove the measuring aperture

To remove the measuring aperture, turn it counter-clockwise by about 20 degrees and pull it off (see picture below).



Install the measuring aperture

To install the measuring aperture, put it in the allocated space and turn it clockwise by about 20 degrees (see picture below).



Note: After switching the measuring aperture, you have to adjust the settings (see chapter 6.3).

5 Operation

5.1 Turn on the device

1. Make sure the battery is installed or the device is connected to an external power source.
2. Put the device on the supplied calibration cover (for more information see chapter 5.3.2 "Calibration").
3. Turn on the device by pressing the power button. After a few seconds, you are automatically directed to the "Standard Measurement" screen. The default setting for this measuring mode is $L^*a^*b^*C^*h$.

5.2 Take a measurement

When you turn on the device, you are directed to the "Standard Measurement" screen. To take a measurement, follow these steps:

1. Press and hold the testing button. A light cone will then appear to help you aim at the measuring point.
2. Move the device as close to the measuring point as possible.
3. Release the testing button. The colour meter now takes a measurement.

Alternatively, you can also press the Up button \uparrow . This activates the integrated camera. You can now see the position of the measuring hole on the display. Once you are done with positioning, just press the testing button.

After the measuring procedure is finished, you can see the results on the following screen:

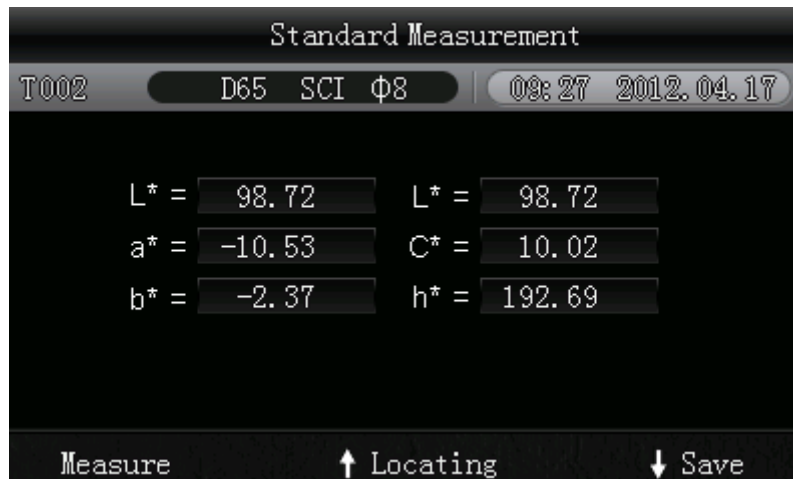

A reading which has been determined by using the “Standard Measurement” automatically serves as a reference value. You can add one or more sample measurements to this reading. To do so, you have to switch to the “Sample Measurement” screen:

1. Press the Enter button \blacktriangleright when you are in the result screen of the standard measurement function. Now you get to the “Sample Measurement” screen.
2. Take a measurement (just like a standard measurement).
3. Now you can see the results and the deviation to the standard in the following screen:

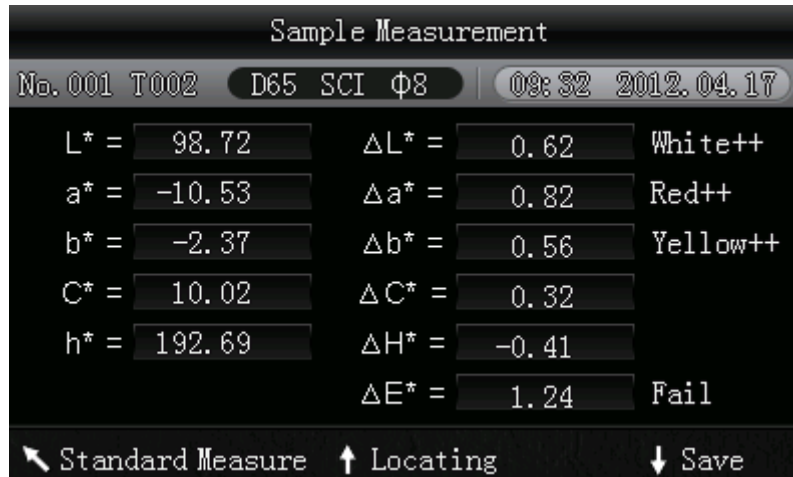

Note: While the measurement is in progress (time duration: ~ 1 second), all buttons are inactive.

To go back to the standard measurement screen, press Back \blacktriangleleft .







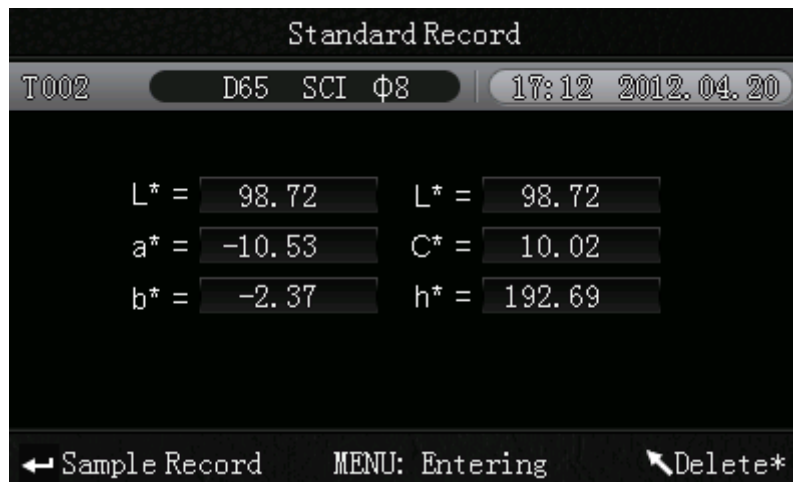

5.3 Additional functions

5.3.1 Records

All measuring results are recorded and saved to the internal memory of the colour meter (if auto save is active). To view the recorded data, press the Menu button \equiv , select “Record” and press Enter to confirm. Now, you get to the following screen:



Here you can navigate between the different readings by using the arrow keys (\blacktriangleup and \blacktriangledown).

- If any samples are assigned to a standard, you can view them by pressing Enter . If there is more than one sample, you can use the arrow keys ( and ) for selection.
- If you want to delete a sample, select it and hold the Back button  for approx. 3 seconds. If you press Back  briefly, you get back to the main screen of the record function.
- If you want to add samples to an existing standard, select the standard and press the Menu button . You will now be redirected to the standard measurement screen. Press Enter  to go to the sample measurement screen. Now you can perform a sample measurement which will automatically be added to the selected standard.
- If you want to turn a sample into a standard, select the standard which the sample is assigned to and press Enter . Now, select the sample and press the Menu button . The sample has now turned into a standard.

5.3.2 Calibration

Auto calibration

During start-up, the PCE-CSM 7 automatically performs a white and black calibration. For this purpose, the device comes with a calibration cover which should be used at every startup. You just have to place the device on top of it and make sure that the calibration plate is located under the measuring aperture. If the auto calibration was successful, you automatically get to the main screen (standard measurement). You can now remove the calibration cover.



If the auto calibration was not successful, the display shows a screen where you have the option to restart the white calibration or to skip it. If you choose skip, the PCE-CSM 7 uses the last white and black calibration.

We do not recommend skipping the auto calibration.

Manual calibration

To get to the calibration menu, press the Menu button , select "Calibrate" and press Enter .



Here you can select between white and black calibration. Use the arrow keys ( and ) to make a selection and press Enter  to confirm. A confirmation screen with instructions will appear.

White calibration

If you want to perform a white calibration, place the device on the calibration cover. Make sure that the sensor is located above the calibration plate. After that, press the Testing button to start the calibration.

Black calibration

If you wish to perform a black calibration, remove the calibration plate and hold the device with the measuring aperture pointing upwards. Make sure that this calibration is carried out in a dark environment.

Additionally, keep the device at least 3 meters away from reflecting objects like walls, tables or other objects. To start the calibration process, press the Testing button.

Note: A calibration is only reasonable in the following cases: when first using the device, after strong changes in the environmental conditions, when the device has been used for a long time or when the measurement results are inaccurate.

5.3.3 Connection to a PC

To connect the device to a PC, press the Menu button \equiv , select "Comm" and press Enter \leftarrow . Now, you will get to the communication screen.

After that, use the USB cable to connect the device to a PC and press Enter \leftarrow . If the connection was successful, the screen shows "Communicating..."

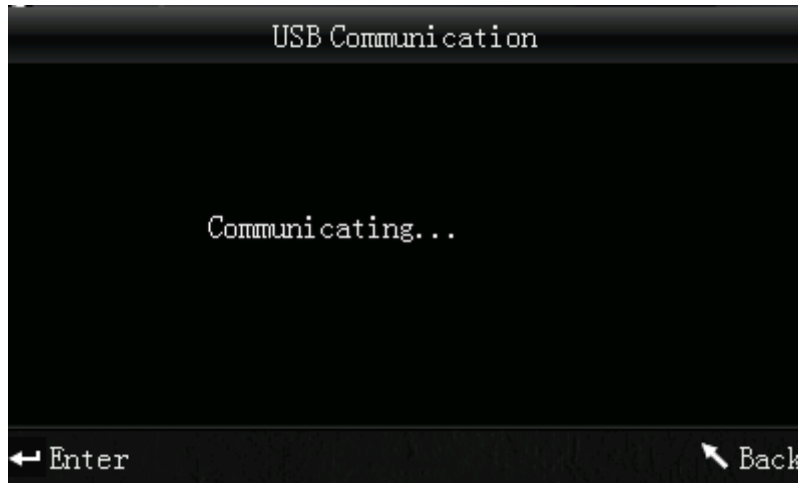

5.3.4 Tolerances

To set up or adjust tolerances, press the Menu button \equiv , select "Tolerance" and press Enter \leftarrow . Now, you get to the tolerance screen.

Here you can activate / deactivate different tolerances. To do so, select the desired option by using the arrow keys (\uparrow and \downarrow) and press Enter \leftarrow . If you activate a tolerance, you get to an input display where you can set the desired threshold value. To do so, use the arrow keys (\uparrow and \downarrow) to adjust the selected digit. Press Enter \leftarrow to go to the next digit. After confirming the last digit by pressing Enter \leftarrow , the tolerance is set up.

Note: The threshold value refers to the „ ΔE “ value in the sample measurement display. It specifies the maximum acceptable value of the deviation. If the measured value exceeds the threshold value, you can see a "Fail" indication in the display. Otherwise, the display will show "Pass".

5.3.5 Delete recorded data

To delete the recorded data, press the Menu button \equiv , select "Delete" and press Enter \leftarrow . Now, you get to the deletion screen.

Here you have two different options. You can either delete all sample measurements ("Delete ALL Samples") or all records ("Delete ALL Records").

Select the desired option by using the arrow keys (\uparrow and \downarrow) and press Enter \leftarrow . A confirmation screen appears. Press Enter \leftarrow to confirm or Back \leftarrow to cancel.

Note: If you delete all records, all sample measurements will be deleted as well.

5.3.6 Averaging

You can set the number of measurements which are performed during the measuring procedure. From these particular measurement results, the average value is generated.

To get to the averaging settings, press the Menu button \equiv , select “Average” and press Enter \leftarrow . Here, you can set the number of measurements. Use the arrow keys (\uparrow and \downarrow) to adjust the selected digit. Press Enter \leftarrow to go to the next digit. After confirming the last digit by pressing Enter \leftarrow , the averaging is set.

Note: If you set “00” or “01”, there will be no averaging.

5.3.7 Display mode

To change the display mode, press the Menu button \equiv , select “Display” and press Enter \leftarrow . Now, you get to the display mode settings.

Here you have the following options: CIE L*a*b*C*H*, CIE L*a*b*, CIE XYZ, CIE RGB, CIE L*U*V*, L*a*b* whiteness & yellowness, colour fastness and staining fastness. Use the arrow keys (\uparrow and \downarrow) to select the desired option and press Enter \leftarrow to confirm.

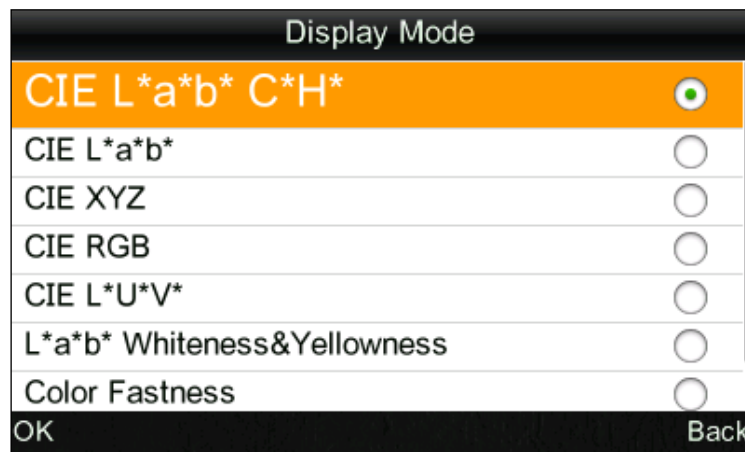

*Note: CIE L*a*b*C*H* is set by default.*

5.3.8 Date/Time setting

To set the time and date of the colour meter, press the Menu button \equiv , select “Time” and press Enter \leftarrow . Now you get to the time and date settings.

Here you can set the time (“Set time”), date (“Set date”) and how time and date are displayed (“Time format” / “Date format”). Select the desired option by using the arrow keys (\uparrow and \downarrow) and press Enter \leftarrow to confirm.

Set time / date

Select “Set time” for time settings or “Set date” for date settings. Here you can set the individual digits of the time and date. Adjust the selected digit by using the arrow keys (\uparrow and \downarrow) and press Enter \leftarrow to get to the next digit. After confirming the last digit by pressing Enter \leftarrow , the time / date is set.



Time format

Here you can choose between 24 h format and 12 h format. Use the arrow keys (\uparrow and \downarrow) for selection and press Enter \leftarrow to confirm.



Date format

Here you can choose between year-month-day, month-day-year and day-month-year. Use the arrow keys (\uparrow and \downarrow) for selection and press Enter \leftarrow to confirm.



5.3.9 Light source

To change the light source, press the Menu button , select "Light" and press Enter . Now you get to the light source settings.

Here you can choose between D65, D50 and A.





Use the arrow keys ( and ) to select an option and press Enter  to confirm.

5.3.10 Specular reflection

To get to the specular reflection settings, press the Menu button , select "SCI/SCE" and press Enter .



Here you can set if the specular reflection is taken into account during the measurement (SCI – specular reflection included) or not (SCE – specular reflection excluded).

5.3.11 Language



To adjust the language of the colour meter, press the Menu button , select "Language" and press Enter . Now you get to the language selection. You can choose between English and Chinese. Select an option by using the arrow keys ( and ) and press Enter  to confirm.

6 Settings





To get to the settings, press the Menu button , select "Setting" and press Enter .

Here you have different options. Use the arrow keys ( and ) to navigate and confirm the selection by pressing Enter .



6.1 Colour offset

Here you can choose if the colour offset is displayed or not. Select an option by using the arrow keys ( and ) and press Enter  to confirm.

6.2 Auto save

Here you choose if the measured data are recorded automatically or not. Choose the desired option by using the arrow keys ( and ) and press Enter  to confirm. If auto save is inactive, you can manually save the data by pressing the Down/Save button .



6.3 Aperture settings

Here you can set which measuring aperture is currently attached to the colour meter. Use the arrow keys ( and ) to select an option and press Enter  to confirm.

Note: Please make sure that the correct measuring aperture is set. If not, this can cause inaccurate readings.

Every time you switch the measuring aperture, you should perform a white and black calibration.

6.4 Colour difference formula

Here you can choose the colour difference formula. You can choose between CIE1976, CIE94 and Hunter. Select an option by using the arrow keys ( and ) and press Enter  to confirm.

6.5 Backlight

Here you can choose for how long the backlight is active. Choose the desired option by using the arrow keys (↑ and ↓) and press Enter ↵ to confirm.

6.6 Contrast

Here you can adjust the contrast of the display. Use the arrow keys (↑ and ↓) to select an option and press Enter ↵ to confirm.

6.7 Restore factory set

Here you can restore the factory settings. To do so, press Enter ↵ in the confirmation screen. Press Back ↶ to cancel.

7 Optional Accessories

7.1 Powder test box PCE-CSM PTB

With the optional powder test box PCE-CSM PTB you can determine the colorimetric parameters of powders.

7.1.1 Structure

The PCE-CSM PTB consists of a base plate (1), a measuring plate with a powder compartment (2), a lens (3) and a mounting ring (4).

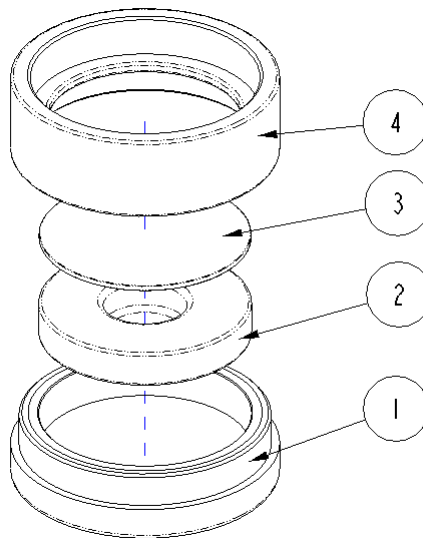

7.1.2 Operation

1. **Calibration:** Put the lens on the white calibration plate and perform a white calibration. After that, perform a black calibration.
2. **Fill in the powder:** Fill the powder into the powder compartment of the measuring plate.

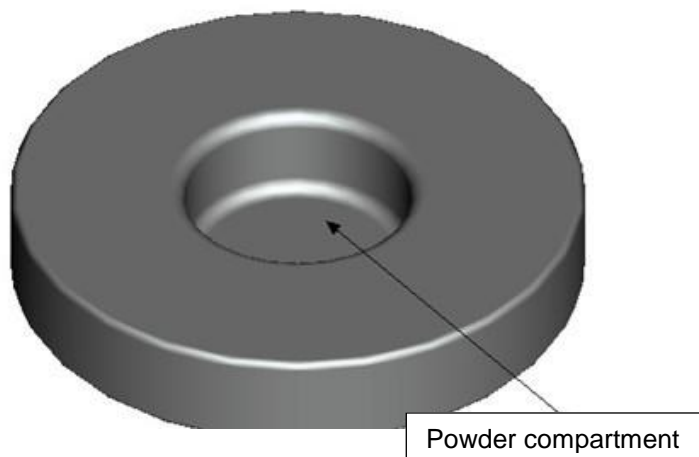

After that, put the powder test box back together (see 7.1.1). Make sure the screw joint is straight.

3. **Measure:** Place the measuring hole of the colour meter on the hole of the powder test box and perform a measurement. Make sure the colour meter is stable.
4. **Clean the test box:** After using the powder test box, disassemble and clean it. If needed, you can use alcohol for cleaning. After the cleaning, let the box dry and store it properly until the next use.

7.2 Measuring device for liquids, pastes and powders PCE-CSM UTC

With the optional measuring device PCE-CSM UTC, you can determine the colorimetric parameters of liquids, pastes and powders.

7.2.1 Structure

The PCE-CSM UTC consists of a base plate (1), an alignment plate for the colour meter (2), a measuring chamber (3) with a measuring hole (31), a tank with filling level indication (4), a cover plate (5) and an adjustment plate (6) with safety screws (7).

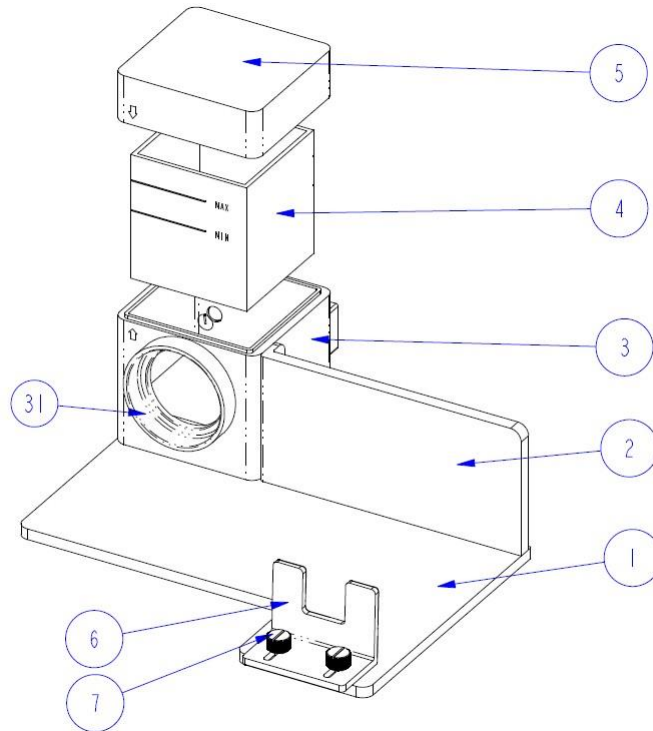

7.2.2 Operation

1. Put the colour meter into the measuring device PCE-CSM UTC (as seen on the picture below) and tighten it by using the adjustment plate (6) and the safety screws (7). The measuring hole should align with the measuring hole of the measuring chamber (3). Make sure that the colour meter is in the right place and tightened properly before moving on.

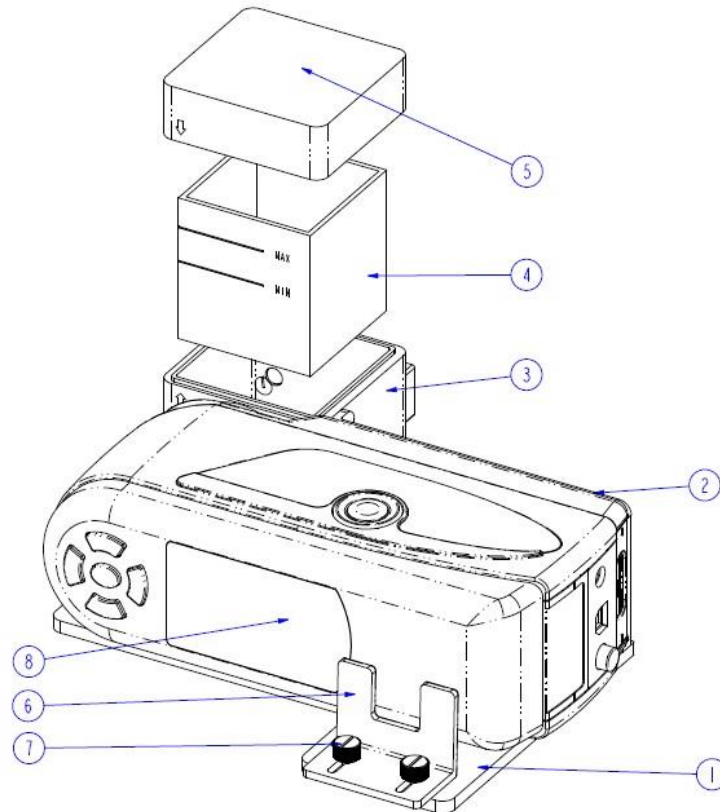

2. Fill the tank (4) with the medium to be measured and put it into the measuring chamber (3). Make sure the filling level lies between the MIN and the MAX indication of the tank. The tank has two sides with a dull surface. Only touch it on those two sides to prevent measurement errors due to dirt.

- Put the cover plate (5) on the measuring chamber of the PCE-CSM UTC. There is an indication on the cover plate, as well as on the measuring chamber. Please make sure that these indications are aligned properly (see picture below).

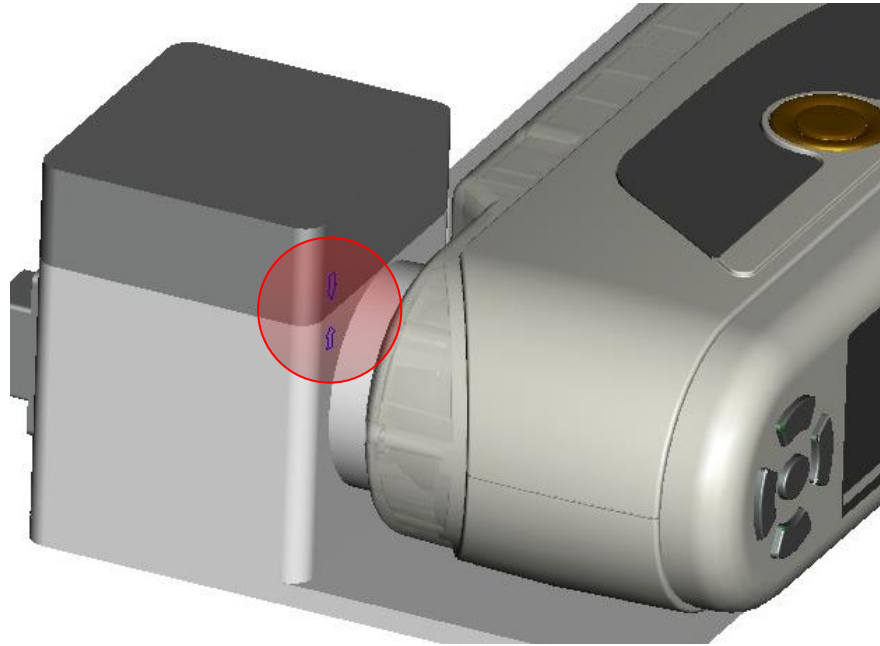

- Perform a measurement with the colour meter.
- Clean the measuring device before each use. Do not use abrasive or corrosive materials to prevent the tank from being scratched. After cleaning, put the cover plate back on the measuring chamber to keep it clean during storage.

8 Contact

If you have any questions about our range of products or measuring instruments please contact PCE Instruments.

8.1 PCE Instruments UK

By post:

PCE Instruments UK Ltd.
Units 12/13 Southpoint Business Park
Ensign Way, Southampton
Hampshire

United Kingdom, SO31 4RF

By phone:

02380 987 035

8.2 PCE Americas

By post:

PCE Americas Inc.
711 Commerce Way
Suite 8
Jupiter
33458 FL
USA

By phone:

561 320 9162

