



# User Manual

PCE-LRF 600 Laser Distance Meter



User manuals in various languages (français, italiano, español, português, nederlands, türk, polski, русский, 中文) can be found by using our product search on: [www.pce-instruments.com](http://www.pce-instruments.com)

Last change: 10 August 2018  
v1.0



## Contents

<b>1</b>	<b>Safety notes</b> .....	<b>1</b>
<b>2</b>	<b>Introduction</b> .....	<b>2</b>
<b>3</b>	<b>Device description</b> .....	<b>2</b>
3.1	Device .....	2
3.2	Delivery contents .....	2
3.3	LCD .....	3
<b>4</b>	<b>Technical specifications</b> .....	<b>4</b>
<b>5</b>	<b>Operation</b> .....	<b>4</b>
5.1	Distance mode .....	5
5.2	Speed mode .....	5
5.3	Changing the unit .....	6
5.4	Auto Power Off .....	6
5.5	Changing the battery .....	6
<b>6</b>	<b>Warranty</b> .....	<b>6</b>
<b>7</b>	<b>Disposal</b> .....	<b>6</b>

## 1 Safety notes

Please read this manual carefully and completely before you use the device for the first time. The device may only be used by qualified personnel and repaired by PCE Instruments personnel. Damage or injuries caused by non-observance of the manual are excluded from our liability and not covered by our warranty.

- The device must only be used as described in this instruction manual. If used otherwise, this can cause dangerous situations for the user and damage to the meter.
- The instrument may only be used if the environmental conditions (temperature, relative humidity, ...) are within the ranges stated in the technical specifications. Do not expose the device to extreme temperatures, direct sunlight, extreme humidity or moisture.
- Do not expose the device to shocks or strong vibrations.
- The case should only be opened by qualified PCE Instruments personnel.
- Never use the instrument when your hands are wet.
- You must not make any technical changes to the device.
- The appliance should only be cleaned with a damp cloth. Use only pH-neutral cleaner, no abrasives or solvents.
- The device must only be used with accessories from PCE Instruments or equivalent.
- Before each use, inspect the case for visible damage. If any damage is visible, do not use the device.
- Do not use the instrument in explosive atmospheres.
- The measurement range as stated in the specifications must not be exceeded under any circumstances.
- Don't cleanse the outside of the lens with hands, please cleanse the lens with appropriate lens-cloth. The outside lens should be cleansed with soft cloth.
- Observe correct battery polarity.
- The battery should be taken out if the DMT isn't in use for a long time.
- The PCE-LRF 600 should be stored in a dry place when not in use.
- Non-observance of the safety notes can cause damage to the device and injuries to the user.

We do not assume liability for printing errors or any other mistakes in this manual.

We expressly point to our general guarantee terms which can be found in our general terms of business.

If you have any questions please contact PCE Instruments. The contact details can be found at the end of this manual.

## 2 Introduction

The PCE-LRF 600 is a metric-only rangefinding distance meter that measures distance and determines the speed of moving objects. This laser rangefinding meter is Ideal for hunting, shooting, golfing and more and is often purchased as a gift for sports and outdoor enthusiasts.

## 3 Device description

### 3.1 Device

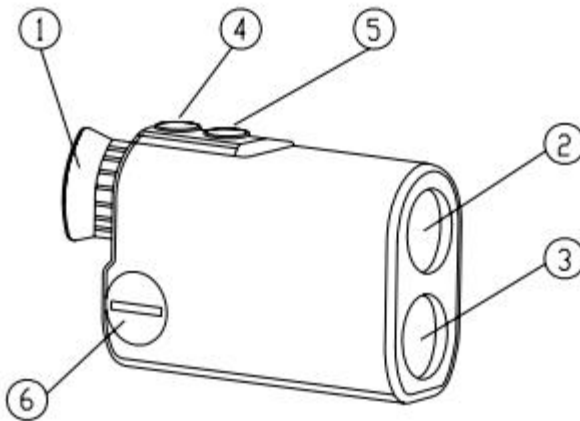

1. Telescope eyepiece (inner—distance display) / adjustment wheel
2. Lens of the meter
3. Laser lens
4. Start key
5. Mode key
6. Battery compartment

### 3.2 Delivery contents

- 1 x PCE-LRF 600 laser rangefinding distance meter
- 1 x Carrying bag
- 1 x Wrist strap
- 1 x Cleaning cloth
- 1 x Battery
- 1 x User manual

### 3.3 LCD

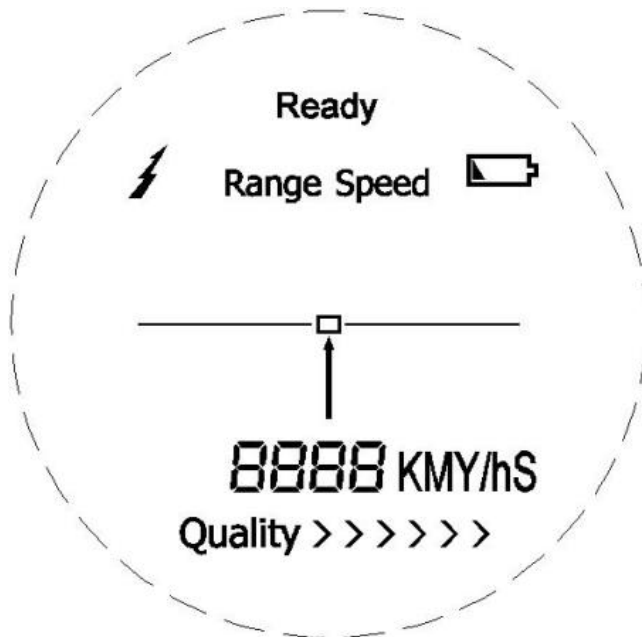

1) „Ready“ – Device is ready for measurement



2) “ – low battery level

3) „Range“ – Mode for distance measurement

4) „Speed“ – Mode for speed measurement

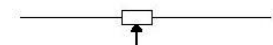

5) “ – Targeting aid



6) “ – shows if laser is active

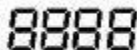

7) “ – distance / speed / faulty measurement

8) „KMY“ – distance unit; M = metre and Y = Yard;

9) „Quality>>>>>“ - Quality of measurement

10) „Km/h; m/s“ – speed units

## 4 Technical specifications

<b>Distance</b>	
Measurement range	6 ... 800 m
Accuracy	±1 m; ±0.2 %
Resolution	1 m
<b>Speed</b>	
Measurement range	0 ... 300 km/h
Accuracy	1 km/h
Resolution laser type	905 nm
<b>Binoculars</b>	
Ocular / eyepiece size	16 mm
Objective lens size	24 mm
Relative brightness	15.21 mm
Exit pupil size	3.9 mm
Magnification power	6x
Field of view	7°
Adjustment of ocular	± 4
<b>General</b>	
Operating temp.	-20 ... 50°C / -4 ... 122°F
Power supply	1 x CR2 3V battery
Approx. weight	185 g / < 1 lb
Approx. dimensions	104 x 72 x 41 mm / 4.09 x 2.83 x 1.61 in

## 5 Operation

1. Adjust the monocular until you see your target clearly.
2. The PCE-LDF 600 has two keys: the Start key and the Mode key.  
You can start the meter by pressing the Start key for a second. You will see the following display:

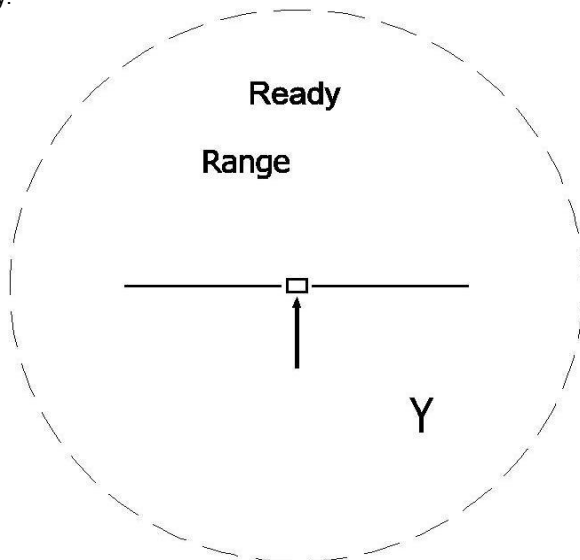

The meter has two modes of measurement: distance and speed. Press the Mode key to select.

## 5.1 Distance mode

After selecting distance mode by means of the Mode key, the word "Range" will appear in the upper left-hand corner of the display. Press and release the Start key to start a measurement. The measured data will appear in the in the bottom area of the display. By pressing the Start key continuously, you will see all the current data on the LCD. When you release the Start key, you will return to the same interface as before the measurement. The  icon flashes when the laser is scanning. If the measuring distance is too long and the reflectance of the object to be measured is too low, the LCD will show "- - -". If the measuring distance is acceptable, the LCD will display "Quality >>>>>". The more ">" you see, the more the stronger the reflection of the measured object and the higher is the quality of the measurement. The maximum is 6, see the following picture:

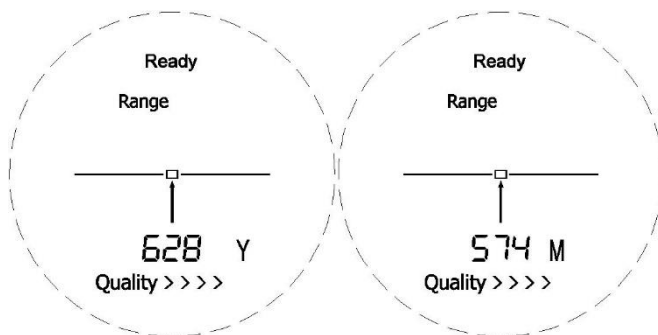

## 5.2 Speed mode

After selecting speed mode by means of the Mode key, the word "Speed" will appear in the upper left-hand corner of the display. Press and release the Start key to start a measurement. The measured data will appear in the in the bottom area of the display after approx. three seconds. If "- - -" appears instead of values, this means that the reflectance of the object to be measured was too weak and that the meter was not able to determine a value. Make sure to target the moving object when making a measurement, without interruption. Also try to stand as parallel to the object as possible. If this is not observed, the reading might be falsified, which is partly due to the changing angle. During the speed measurement,  will flash. The quality indication will then appear and the data will be displayed in the lower part of the LCD. During the speed measurement, the display will look as follows:

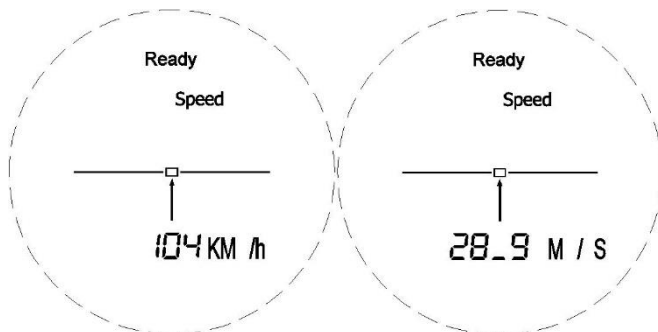



### 5.3 Changing the unit

“M” stands for metres and “Y” stands for Yards. These units can be changed by pressing and holding the Mode key when you are in distance mode.

“Km/h” stands for kilometres per hour and “m/s” stands for metres per second. These units can be changed by pressing and holding the Mode key when you are in speed mode. The resolution for the readings in m/s is 0.1. The decimal sign is a “\_” instead of a “.” Example: “12\_8 M/S” means “12.8 m/s”.

### 5.4 Auto Power Off

The meter will automatically turn off when not used for more than 20 seconds. This function cannot be disabled.

### 5.5 Changing the battery

When the battery symbol flashes, the battery must be replaced. To do so, open the battery compartment cover by pulling it down (away from the eyepiece). Take out the old battery and replace it by a new one. Observe correct polarity. Re-install the battery compartment cover.

## 6 Warranty

You can read our warranty terms in our General Business Terms which you can find here: <https://www.pce-instruments.com/english/terms>.

## 7 Disposal

For the disposal of batteries in the EU, the 2006/66/EC directive of the European Parliament applies. Due to the contained pollutants, batteries must not be disposed of as household waste. They must be given to collection points designed for that purpose.

In order to comply with the EU directive 2012/19/EU we take our devices back. We either re-use them or give them to a recycling company which disposes of the devices in line with law.

For countries outside the EU, batteries and devices should be disposed of in accordance with your local waste regulations.

If you have any questions, please contact PCE Instruments.





## PCE Instruments contact information

### Germany

PCE Deutschland GmbH  
Im Langel 4  
D-59872 Meschede  
Deutschland  
Tel.: +49 (0) 2903 976 99 0  
Fax: +49 (0) 2903 976 99 29  
info@pce-instruments.com  
www.pce-instruments.com/deutsch

### France

PCE Instruments France EURL  
23, rue de Strasbourg  
67250 SOULTZ-SOUS-FORETS  
France  
Téléphone: +33 (0) 972 3537 17  
Numéro de fax: +33 (0) 972 3537 18  
info@pce-france.fr  
www.pce-instruments.com/french

### Spain

PCE Ibérica S.L.  
Calle Mayor, 53  
02500 Tobarra (Albacete)  
España  
Tel. : +34 967 543 548  
Fax: +34 967 543 542  
info@pce-iberica.es  
www.pce-instruments.com/espanol

### United States of America

PCE Americas Inc.  
711 Commerce Way suite 8  
Jupiter / Palm Beach  
33458 FL  
USA  
Tel: +1 (561) 320-9162  
Fax: +1 (561) 320-9176  
info@pce-americas.com  
www.pce-instruments.com/us

### United Kingdom

PCE Instruments UK Ltd  
Unit 11 Southpoint Business Park  
Ensign Way, Southampton  
Hampshire  
United Kingdom, SO31 4RF  
Tel: +44 (0) 2380 98703 0  
Fax: +44 (0) 2380 98703 9  
info@industrial-needs.com  
www.pce-instruments.com/english

### Italy

PCE Italia s.r.l.  
Via Pesciatina 878 / B-Interno 6  
55010 LOC. GRAGNANO  
CAPANNORI (LUCCA)  
Italia  
Telefono: +39 0583 975 114  
Fax: +39 0583 974 824  
info@pce-italia.it  
www.pce-instruments.com/italiano

### The Netherlands

PCE Brookhuis B.V.  
Institutenweg 15  
7521 PH Enschede  
Nederland  
Telefoon: +31 (0)53 737 01 92  
Fax: +31 53 430 36 46  
info@pcebenelux.nl  
www.pce-instruments.com/dutch

### Chile

PCE Instruments Chile S.A.  
RUT: 76.154.057-2  
Santos Dumont 738, local 4  
Comuna de Recoleta, Santiago, Chile  
Tel. : +56 2 24053238  
Fax: +56 2 2873 3777  
info@pce-instruments.cl  
www.pce-instruments.com/chile

### Hong Kong

PCE Instruments HK Ltd.  
Unit J, 21/F., COS Centre  
56 Tsun Yip Street  
Kwun Tong  
Kowloon, Hong Kong  
Tel: +852-301-84912  
jyi@pce-instruments.com  
www.pce-instruments.cn

### China

PCE (Beijing) Technology Co.,Ltd  
1519 Room, 6 Building  
Men Tou Gou Xin Cheng,  
Men Tou Gou District  
102300 Beijing  
China  
Tel: +86 (10) 8893 9660  
info@pce-instruments.cn  
www.pce-instruments.cn

### Turkey

PCE Teknik Cihazları Ltd.Şti.  
Halkalı Merkez Mah.  
Pehlivan Sok. No.6/C  
34303 Küçükçekmece - İstanbul  
Türkiye  
Tel: 0212 471 11 47  
Faks: 0212 705 53 93  
info@pce-cihazlari.com.tr  
www.pce-instruments.com/turkish