

PCE Americas Inc.  
711 Commerce Way  
Suite 8  
Jupiter  
FL-33458  
USA  
From outside US: +1  
Tel: (561) 320-9162  
Fax: (561) 320-9176  
info@pce-americas.com

PCE Instruments UK Ltd.  
Units 12/13  
Southpoint Business Park  
Ensign way  
Hampshire / Southampton  
United Kingdom, SO31 4RF  
From outside UK: +44  
Tel: (0) 2380 98703 0  
Fax: (0) 2380 98703 9  
info@pce-instruments.com

[www.pce-instruments.com/english](http://www.pce-instruments.com/english)  
[www.pce-instruments.com](http://www.pce-instruments.com)

# Manual Hygrometer PCE-330



## CONTENTS

---

TITLE	PAGE
<b>1. SAFETY INFORMATION</b> .....	1
<b>2. GENERAL DESCRIPTION</b> .....	1
<b>3. FEATURE</b> .....	1
<b>4. SPECIFICATIONS</b> .....	1
<b>5. SYMBOL BUTTONS AND FUNCTIONS</b> .....	3
<b>6. DATA LOGGER</b> .....	6
<b>7. SETTING THE TIME</b> .....	7
<b>8. POWER PREPARATION</b> .....	7
<b>9. COMMUNICATION WITH A PC</b> .....	8
Testlink PCE-330 Software .....	8
<b>10. MAINTENANCE</b> .....	12
<b>11.CONNECTION BETWEEN PROBE AND MAIN UNIT</b> .....	12

## 1. SAFETY INFORMATION

Read the following safety information carefully before attempting to operate or service the meter. Use the meter only as specified in this manual; otherwise the protections provided by the meter may be impaired.

### ENVIRONMENT CONDITIONS:

- Altitude up to 2000 meters
- Relatively humidity: 90% max
- Operation ambient temperature: 0 to 40°C

### MAINTENANCE & CLEARING:

- Repairs or servicing not covered in this manual should only be performed by qualified personnel.
- Periodically wipe the case with a dry cloth. Do not use abrasives or solvents on this instrument.

### SAFETY SYMBOLS:



When servicing, use only specified replacement parts.

## 2. GENERAL DESCRIPTION

Thank you for choosing our Data Logger Hygro-Thermometer. To ensure the safety and the best performance of this instrument, we recommend you to read and follow the manual carefully before any operation.

Measurement settings and results are shown on the backlit LCD panel.

Data can be stored in the meter or directly saved on a computer through PC interface. Recorded data can be further processed on a computer.

## 3. FEATURE

- Interchangeable digital probes
- Thermistor sensor for temperature measurement, fast response time
- Dual display
- Dew point measurement
- 16,000 Records Data Logger
- PC Interface
- With Windows software
- Auto power off for battery saving

## 4. SPECIFICATIONS

**Sensor type:** Electronic capacitance polymer film sensor / NTC

**Relative humidity range:** 0 to 100%RH

**Temperature range:** -20 to 60°C (- 4 to 140°F)

**Dew point temperature range:** -20 to 60°C (- 4 to 140°F)

**Resolution:** 0.1%RH, 0.1°C, 0.1°F

**Accuracy:** (at 23°C)

**<Probe: RP-32>**

<10%RH, >90%RH	±4.0%RH
10%RH to 90%RH	±2.0%RH
-20 to 60°C (-4 to 140°F)	±0.8°C (±1.5°F)

**<Probe: RP-31>**

<10%RH >90%RH	±5.0%RH
10%RH to 90%RH	±3.0%RH
15 to 35°C (60 to 95°F)	±0.8°C (±1.5°F)
<15°C (60°F), >35°C (95°F)	Refer to chart

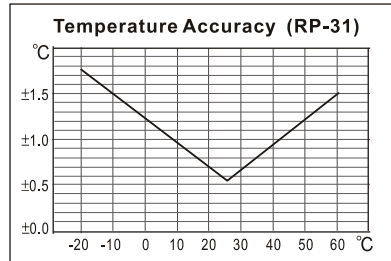

**Response time:** (@ t90; in slowly moving air) ; Humidity: 60 sec. ; Temperature: 10 sec.

**Sensor hysteresis:** <1.5%RH

**Temperature coefficient:** 0.1 x (specified accuracy) per 1°C (<23°C or >23°C)

**Sample rate:** 2 times per second

**Battery type:** 9V Battery

**Battery lifetime:** Approx. 80 hours (alkaline battery)

**AC adapter:** 9V DC(7~10V Max.)/20mA Min (Plug Diameter: 3.5mmx1.35mm)

**Operation temperature:** 0 to 40°C (32 to 104°F)

**Operation humidity:** 10 to 90%RH

**Storage temperature:** -10 to 60°C (14 to 140°F)

**Storage humidity:** 10 to 75%RH

**Dimensions:**

Meter: 185mm(L) × 65mm(W) × 36mm(H)

Probe: **RP-32:** 15mm Diameter x 94mm(L); **RP-31:** 15mm Diameter x 82mm(L)

**Weight:** Approx. 285g

**Standard Accessories:**

Instruction manual, 9V Battery, windows software, carrying case, USB cable.

**Optional Accessories:**

AC adapter, RS-232 Cable, Extension cables, 33%RH/ 75%RH humidity standard.

## 5. SYMBOL BUTTONS AND FUNCTIONS

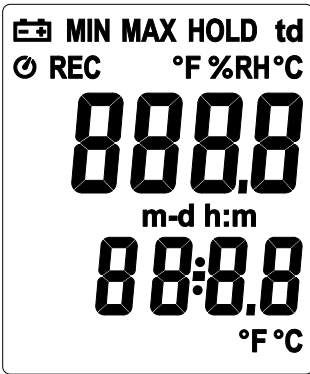

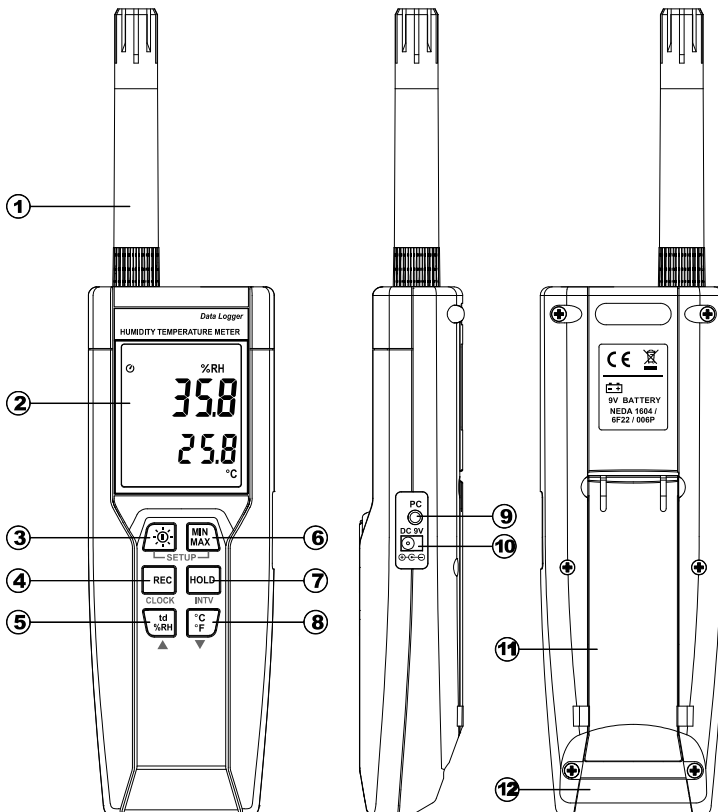

	: Low battery indicator
	: Auto power off indicator
<b>MAX MIN</b>	: Minimum / maximum indicator
<b>188.8</b>	: Relative Humidity reading
<b>REC</b>	: Recording data logger indicator
<b>td</b>	: Dew point temperature
<b>HOLD</b>	: Data hold indication
<b>m-d</b>	: Month-day
<b>h:m</b>	: Hour: minute
<b>188.8</b>	: Temperature reading
<b>°C°F</b>	: Temperature measurement units



**FUNCTIONS:**

- ① **Sensor probe**
- ② **Display screen**
- ③ **Power / Backlight button**



**Power on/off:**

Press the  button to turn on the unit. To turn the unit off, press and hold  button down until the screen shows “**OFF 3, 2, 1, 0,**” then the LCD screen goes off.

**Note:**

*When the unit is on, the LCD will show the following initial information before entering the main function: **Available memory → Current date → Current time → Entering main function***

**LCD backlight on/off:**

Press  button to turn on the LCD backlight, making it easier to read in dark environment. Press  button again to turn off backlight. The backlight will turn itself off automatically after 30 seconds to save battery power.





**Auto power off:**

To save battery life, by default, every time the unit is powered on, it is under auto power off mode. The unit will power itself off after 30 minutes if no key operation.



Auto power off will be automatically disabled under the following 2 circumstances:

- When connecting to PC.
- When data logger function is on process.



**Disabled auto power off:**

- (1) Turn off the unit.
- (2) Press and hold  button, and keep holding  button.
- (3) Press  button to turn on the unit.
- (4) The LCD shows the initial information and then enters main function.
- (5) Release  button.
- (6) Make sure the auto power off  symbol disappears from display screen.

- ④ **REC button**

Press  button to start recording data. The **REC** symbol will display on the screen. To stop recording, press  button again.





- ⑤ **Relative Humidity/Dew Point Temperature switch**

By default, the LCD displays Relative Humidity when the unit is powered on. To display dew point (DP) temperature, press  button. Press  button again to switch back to Relative Humidity.

- ⑥ **MAX/MIN mode**

Under this mode, the unit simultaneously monitors and stores the maximum and minimum value (both humidity and temperature) in the memory. The unit will keep updating/refreshing the data.

**To start:**

- (1) Press  button. **MAX** symbol lights up on LCD, the reading shows the maximum data.
- (2) Press  button again to show minimum data; the **MIN** symbol lights up on LCD.
- (3) Press  button again, the **MAX** and **MIN** symbol blinks together. The reading shows present humidity and temperature.
- (4) Press  button again, **MAX** symbol lights up, and the mode returns to (1).



**To exit:**

Press and hold  button for 2 seconds to stop storing maximum and minimum data.

**Note:** When the unit is in the MAX/MIN mode,  button is disabled.

**⑦ Data-Hold mode**

Press  button to freeze the data shows on the LCD screen. Press again to exit Data-Hold mode.

**Note:** When the unit is in the Data-Hold mode, the , , and  buttons are disabled.

**⑧ Selecting temperature units**

By default, each time the unit is powered on, the scale is set to the Celsius (°C). Press the  button to switch between Celsius (°C) and Fahrenheit (°F).

**⑨ PC Interface**

The PC jack signal output is a 9600 bps N 8 1 serial interface. Use the USB cable (standard accessory) to connect with a computer.

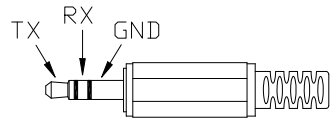
**⑩ External DC 9V power supply jack**







Connect the AC adapter (optional accessory) to use external power.

**⑪ Tilt stand****⑫ Battery Compartment**

## 6. DATA LOGGER

This section will explain how to store data (data logger) in memory and how to recall data from memory.

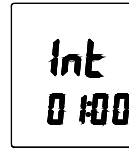

### 6.1 SETTING INTERVAL TIME FOR DATA STORING:

- (1) Turn off the unit.
- (2) Enter SETUP mode by pressing and holding  button and then press  power button to turn on the unit. "SET" blinks on the LCD screen.
- (3) Press **INTV**  button to set interval time.
- (4) Press  ( $\frac{td}{\%RH}$ ) or  ( $\frac{^{\circ}C}{^{\circ}F}$ ) to adjust the interval minute, press **INTV**  button again to adjust second.
- (5) When finished, press **INTV**  button to exit SETUP mode.



**Note:** To abort during the process, press power button to exit SETUP mode.





### 6.2 START DATA LOGGER (STORING DATA IN THE MEMORY):

- (1) Press  button to start data logger (storing the measured values in built-in memory).
- (2) **REC** symbol lights up on LCD screen.
- (3) Press  button again to stop recording.

**Note:**

- During recording period, most of the buttons are disabled, such as the  $\frac{td}{\%RH}$ ,  $^{\circ}C/^{\circ}F$ , etc. All other settings must be made before starting the data logger function.
- When the memory is full (16000 recorders), **REC** symbol will blink on the LCD screen. The data logger stops.
- When battery power low  symbol lights up on the screen), data logger cannot be started. If during data logger, the battery starts running low, data logger will stop automatically.

### (3) CLEARING DATA:









- (1) Turn off the unit.
- (2) Press and hold  button and then press  power button to turn on the unit.
- (3) Keep holding  button, then LCD will show "CLR" and "SURE 5, 4...1, 0" until clean the memory. (To abort, release  button before "SURE 0".)



## 7. SETTING THE TIME

The unit incorporates a clock so that the data logger function can also record the data and time along with the measurement value in the memory.

### 7.1 SETTING DATE AND TIME:

- (1) Turn off the unit.
- (2) Enter SETUP mode by pressing and holding  button and then press  power button to turn on the unit. "SET" blinks on the LCD screen.
- (3) Press **CLOCK** () button to set clock.
- (4) Press  () or  () to adjust year, press **CLOCK**() button to adjust next value (**month → date → hour → minute**).
- (5) When finish, press **CLOCK** () button to exit SETUP mode.

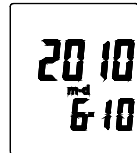

#### Note:

- To abort during the process, press power button to exit SETUP mode.
- An internal backup battery supplies power for the clock.

## 8. POWER PREPARATION

### 8.1 Battery Loading

Remove the battery cover on the back and insert one 9V battery.

### 8.2 Battery Replacement

When the battery voltage drops below the operating voltage, Low battery indicator  will appear. Replace a 9 Volt battery immediately to ensure the unit functions properly.

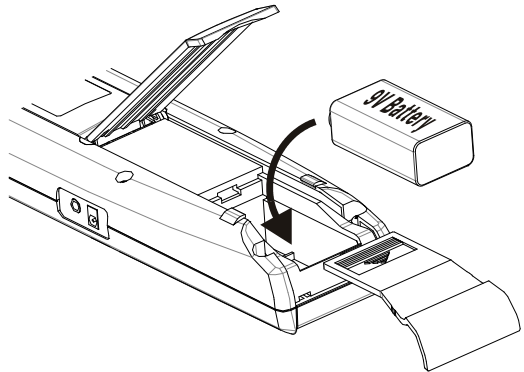

### 8.3 AC Adapter Connection

When the AC adapter is used, insert the plugs of the adapter into the DC9V connector on the side panel.

#### Note:

*When the AC adapter is connected while battery is inserted, the unit will be powered from the adapter (the AC adapter has priority).*

## 9. COMMUNICATION WITH A PC

Users can transfer data from the built-in memory on the instrument to a PC through SE318 software. The communication requires a USB or RS-232 serial connection.

### TESTLINK PCE-330 SOFTWARE

#### (1) The SE-318 package contains:

- Software CD disk
- Custom designed USB cable for SE318

#### (2) System Required:

Windows XP/ VISTA/ Windows 7 / Windows 8

#### (3) Minimum Hardware Required:

- PC or NoteBook with Pentium 800MHz or higher, 128 MB RAM
- At least 50 MB hard disk space available to install SE318
- Recommended screen resolution 1024X768 or above

#### (4) Install PCE-330 and USB-120 connector driver:

1. We recommend close all other application before installing SE318.
2. Insert setup CD disk to CD disk drive to display install screen. You may also run MainSetup.exe in the directory of the CD.
3. Click Install to begin installation.
4. It will install USB-120 connector driver first:
5. While installing, it will show this window below, just click “next” to continue.(see Fig.1)
6. Select “Launch the CP210x VCP Driver Installer” option, and then click Finish. (see Fig.2)

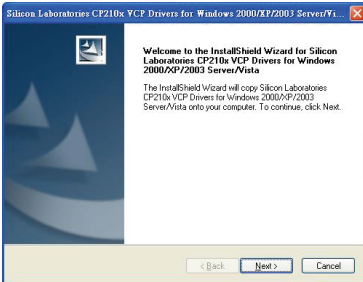

(Fig.1)

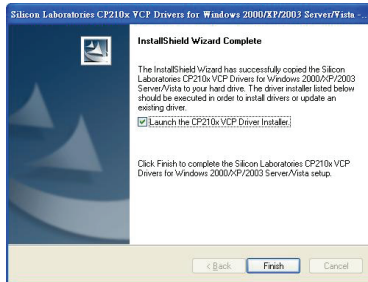

(Fig.2)

7. Click Install.

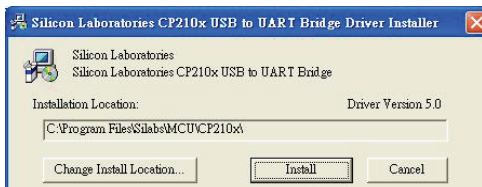

8. After finish installing USB-120 connector driver, it will install SE318 software automatically. it will copy SE318.exe ( executable file ) and help file to your hard disk ( default is c:\program files\SE318.
9. After finish installation, plug USB-120 connector to PC usb port, execute.
10. "start"→ "My Computer", then choose "View System Information" on the left top of the window, the window below will show up.

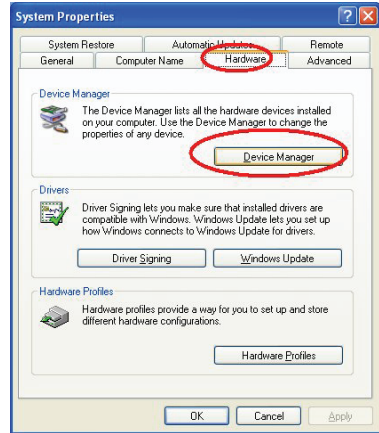



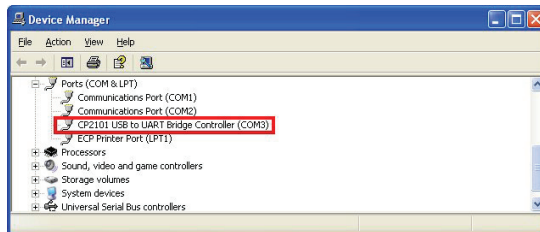



11. Choose "Hardware" option and click "Device Manager" button, click "+" symbol on the left side of Ports(COM &LPT), if the device "CP2101 USB to UART Bridge Controller(COMx)" is in the list, the connector is ready to work.



### (5) Main menu and buttons:



-  **Open** - Retrieve files from the disk
-  **Save** - Save the present data to the disk
-  **Print** - Send data in the present table to the printer
-  **Pause** - Stop data recording
-  **Run** - Start data recording
-  **Output To Graph** - Send tabular data to another graph
-  **New** - Reset all the data

**Option** - Setup dialog to set attributions of graph. (You can also double click on the graph.)

**Sampling Rate** - Time interval between each data to be recorded. If you want to change it, move mouse cursor to the digit you want to change and click, then input the new sampling rate. The change will be effective immediately. It will keep up to 5000 data points, when data points exceed this limit, the oldest 100 points will be replaced sequentially.

### (6) Real Time Graph:

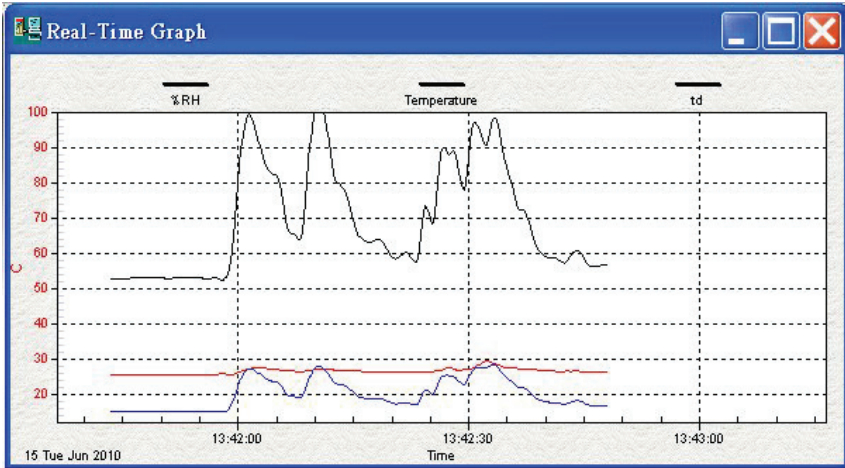

You can Zoom this graph by using mouse:

#### To Zoom:

1. Press and hold the Shift key
2. Press the left mouse button and drag the cursor to select the new extents
3. Release the mouse button

#### To Undo the Zoom:

Press the Alt+U key or click Undo Zoom button

**Note:** Zooming method is not allowed in Real Time Graph Window.

### (7) Tabular:

NO	DATE	TIME	RH	T	td	UNIT
58	2010/6/15	13:42:40	58.5	26.6	17.6	C
59	2010/6/15	13:42:41	58.5	26.4	17.4	C
60	2010/6/15	13:42:42	57.2	26.4	17.1	C
61	2010/6/15	13:42:43	59.5	26.4	17.7	C
62	2010/6/15	13:42:44	60.4	26.4	18.0	C
63	2010/6/15	13:42:45	57.0	26.3	17.0	C
64	2010/6/15	13:42:46	56.1	26.2	16.6	C
65	2010/6/15	13:42:47	56.5	26.2	16.7	C
66	2010/6/15	13:42:48	56.4	26.2	16.7	C

The Tabular window can be used to record real time data in a table format. The maximum number of records that the Tabular window can keep will be depending on how many available memory and hard disk space of the connected computer.

**(8) Data Logger**

When you have thermometer connected to computer, select "Load Data" to start loading the recorded data from the thermometer. There will be a progress indicator to show the loading progress.

If error occurs, just click "Load Data" again.

After the data has been successfully loaded to computer, the left side window shows how many data sets were loaded and their detailed information (start date, start time, recording rate, and record numbers).

**For example:**

It will transfer the first data set to graph and tabular on the right side window once you finish loading recorded data from the thermometer. You can click on at any data set to show its graph and tabular on the right side window. You can choose a rectangle area on the graph to zoom in for detail.

The vertical dash line in the graph will match the highlight row in the tabular. When clicking on another row in the tabular, the vertical dash line will move to the corresponding position to match the time.

Data Sets				
Set	DATE	TIME	Rate	Nums
1	2010/5/7	下午 07:42:18	08:33	1
2	2010/5/7	下午 07:55:39	20:59	1
3	2010/6/25	下午 01:37:57	20:59	1
4	2010/6/25	下午 01:38:01	20:59	1
5	2010/6/25	下午 01:38:03	20:59	1
6	2010/6/25	下午 01:38:05	20:59	1
7	2010/6/25	下午 01:38:07	20:59	1
8	2010/6/25	下午 01:38:14	20:59	1
9	2010/6/25	下午 01:38:17	20:59	1
10	2010/6/25	下午 01:38:30	20:59	1
11	2010/6/25	下午 01:38:32	20:59	1

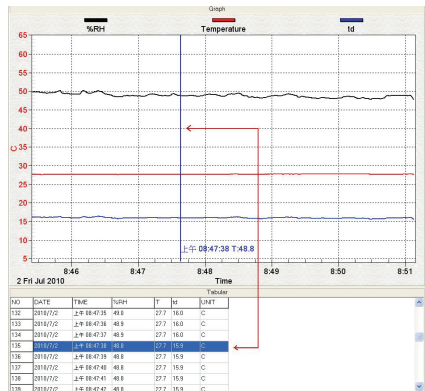

**(9) Frequently Asked Question:**

**Q:** I have connected thermometer to computer serial port and turned thermometer on, but it still shows "NO CONNECTION" ?

**A:** It could be caused by that all serial port are occupied by other applications. Close all application, restart your computer, and run SE318 again.

**Q:** In TABULAR window, I saved a file. Can I use EXCEL to open this file?

**A:** If the decimal separator is comma (,) in your area, you cannot use CSV file because CSV file use comma to separate data. This will cause confusion (for example 23,6,C,24,6,C).

However, you can use TXT files instead. It uses tab to separate to data.

(For example: 23.6 C 24.6 C) and it can be accepted in EXCEL.

**Q:** How to uninstall SE318?

**A:** Uninstall SE318 by launching the Add/Remove Programs applet out of the Control Panel, highlighting the SE318, and clicking on the Add/Remove... button, then it will remove the SE318 folder and files from your computer.

## 10. MAINTENANCE

In order to ensure the accuracy of the thermometer for a longer period of time you should calibrate it once a year.

Clean the device and the window of the display with a clean, lint-free, antistatic and dry cleaning cloth.

**⚠** *Do not use cleaning agents that contain carbon or benzenes, alcohol or anything similar to clean the product since these substances damage the surface of the measuring instrument. Moreover, these fumes are hazardous to health and explosive. Do not use tools with sharp edges, screwdrivers, metal brushes or anything similar to clean the device.*

## 11. CONNECTION BETWEEN PROBE AND MAIN UNIT:

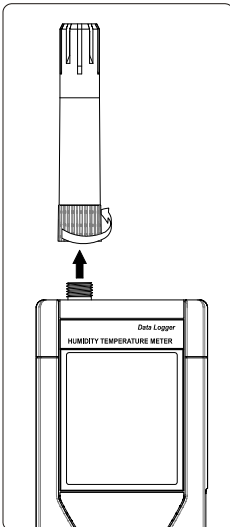

The probe can be connected or disconnected from the main unit by the fastening screw as shown in the graph. Rotate only the fastening screw rather than the probe body to prevent damage the probe.



---

---

PCE Instruments

---

---

GCBPCE318-02000