



PCE Americas Inc.
711 Commerce Way
Suite 8
Jupiter
FL-33458
USA
From outside US: +1
Tel: (561) 320-9162
Fax: (561) 320-9176
info@pce-americas.com

PCE Instruments UK Ltd.
Unit 11
Southpoint Business Park
Ensign way
Hampshire / Southampton
United Kingdom, SO31 4RF
From outside UK: +44
Tel: (0) 2380 98703 0
Fax: (0) 2380 98703 9
info@pce-instruments.co.uk

www.pce-instruments.com/english
www.pce-instruments.com

PCE-CRM 40

Chroma Meter

User Manual



CONTENT

I	Product Overview	1
1.1	Front Side.....	1
1.2	Reverse Side.....	2
II	Basic Operation.....	3
2.1	Starting Page	3
2.2	Home Page	4
2.3	System Settings	5
2.3.1	Time Setting	5
2.3.2	Power Management.....	6
2.3.3	Language.....	7
2.3.4	Version	7
2.4	Test Setup	8
2.4.1	Developer Tools	8
2.4.2	Measurement unit selection.....	9
2.4.3	Integral Time	10
2.4.4	Standard Illumination settings.....	10
2.5	Parameter description.....	10
III	Measurement.....	12
3.1	Measuring Operation.....	12
3.2	Operation during Measuring	15
3.3	Color Difference Value and Chromaticity Coordinates.....	16
3.4	View Data.....	19
3.5	Maximum Measuring	20
3.6	Batch Data Processing.....	21
IV	Attentions and Basic Maintenance.....	27
4.1	Attentions in use.....	27
4.2	How to clean	28
V	Specifications	29

I Product Overview

PCE-CRM 40

1.1 Front Side

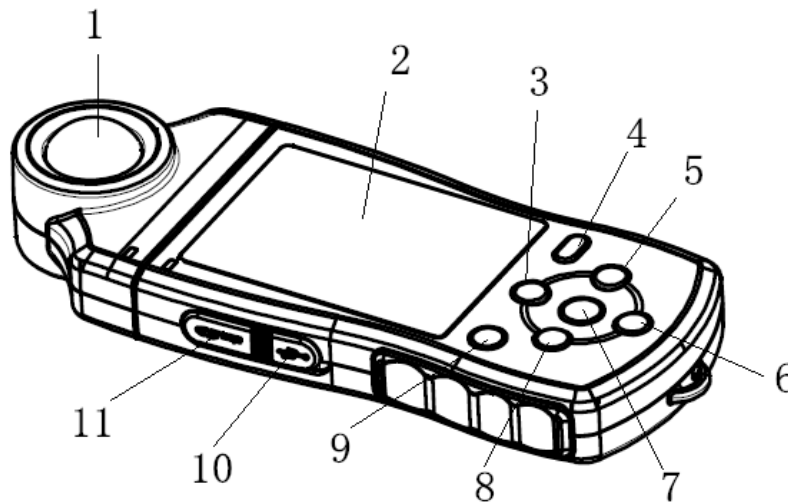

- | | |
|------------------------|---|
| 1 Measuring lens | |
| 2 Display Screen | |
| 3 UP key | Move up |
| 4 MAX key | Maximum value |
| 5 OK key | Confirm |
| 6 DOWN key | Move down |
| 7 MENU key | Moves to the main measurement screen from other screens and submenus. |
| 8 BACK key | Moves back one level in the menu structure. |
| 9 POWER key | Power |
| 10 USB MICRO Interface | Connected with power adapter to realize the charging, connected with computer to realize data transmission. |
| 11 SD slot | Install SD card into this slot. |

1.2 Reverse Side

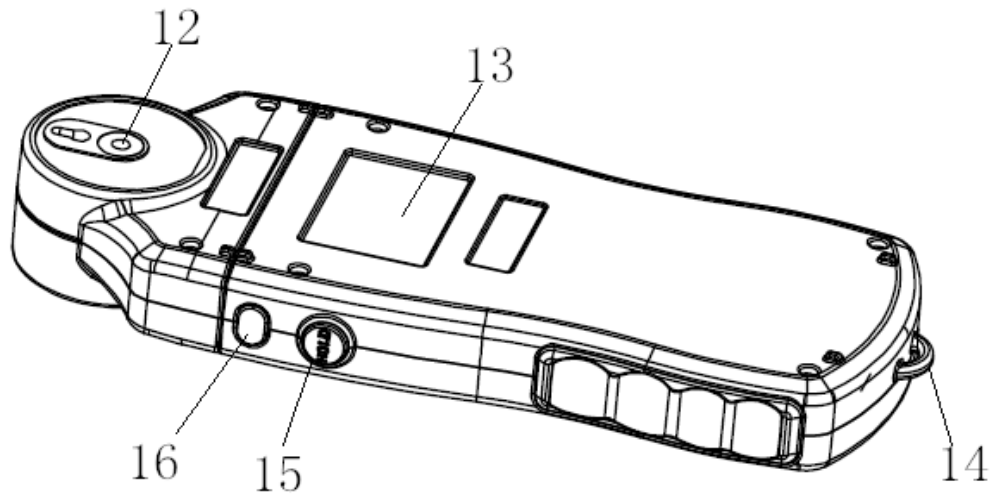

12 Tripod jack

13 Nameplate

14 Wrist Strap Hook

15 HOLD key

Press the button, the device would pause and save the latest data, and word 'hold' shows on the screen in the top left corner;

Press the button once again, and the device would continue working.

16 Measuring Lens Uninstall button The button is set for manufacturer maintenance. It is strictly prohibited to disassemble privately in any case, avoiding causing irreversible damage.

II Basic Operation

2.1 Starting Page



Press the power button  for 1-2 seconds, after the beep, the device starts up and shows the starting page.

After the starting process, the measuring page shows directly as below:

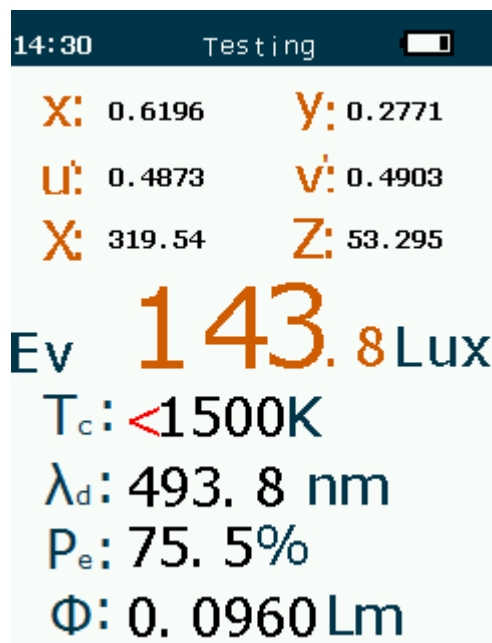

Press the button 'MENU' to jump into home page and operate other buttons to set up the device for measuring.



2.2 Home Page

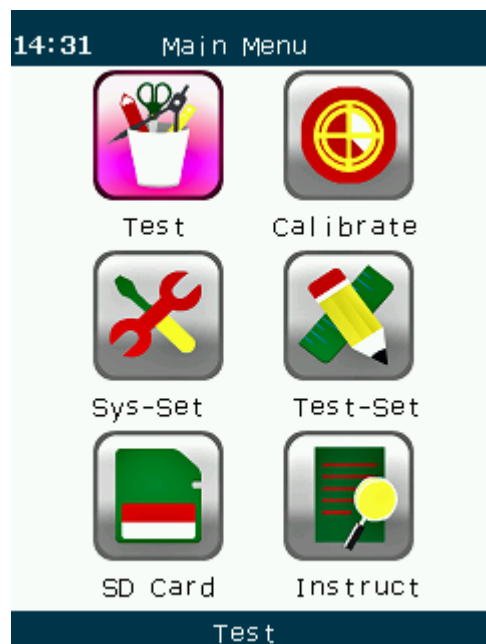

2.3 System Settings

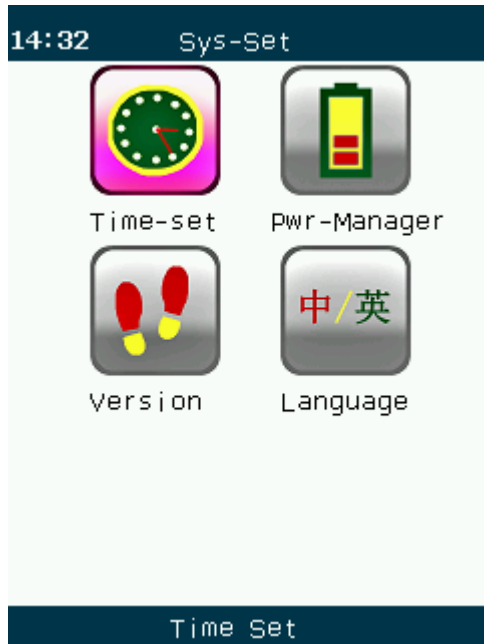

Get into the system settings, the factory date has been set as Beijing Time. Power management and language are default, users can change if necessary.

2.3.1 Time Setting

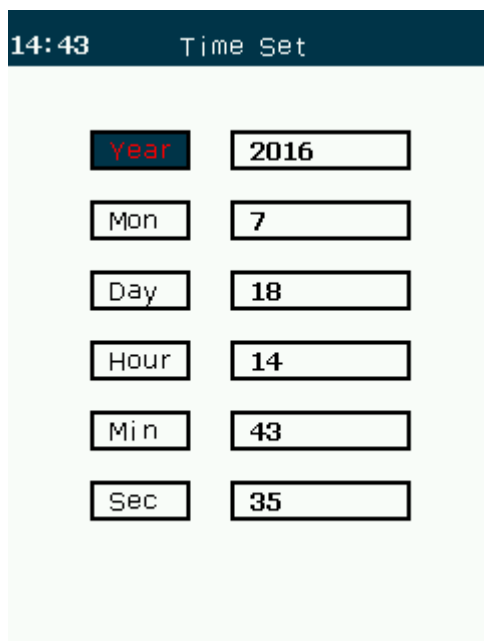

Time setting can be accurate to seconds, which has already been set in Beijing Time. No

need to change if not necessary.

2.3.2 Power Management

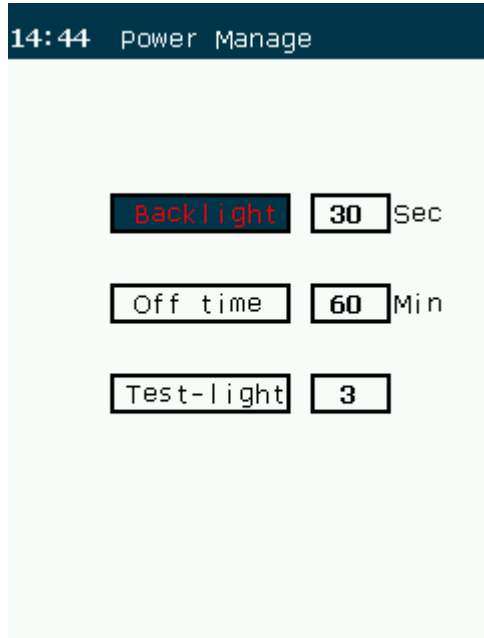

There are functions include screen backlighting time setting, auto-shut off time setting and backlight brightness adjustment.

LCD backlighting time is set for 30 seconds in default, and the auto-shut off is set for 30 minutes.

Backlight brightness adjustment function has 3 optional levels, corresponding to the dark, medium and bright. It is set in first level in default.

2.3.3 Language



Device provides two operating languages in Chinese and English. Customers can choose according to need.

2.3.4 Version



User can view version number and identification S/N code in the page.

2.4 Test Setup



2.4.1 Developer Tools

Developer tools are provided for developers only, the function is not open during the use of device. The details are provided in 4.3.

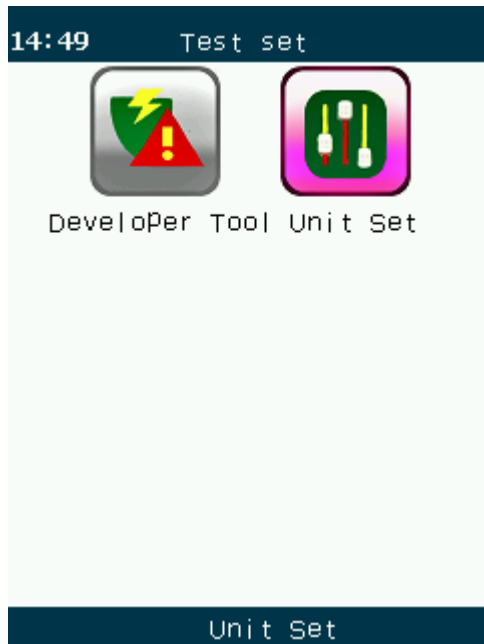

2.4.2 Measurement unit selection

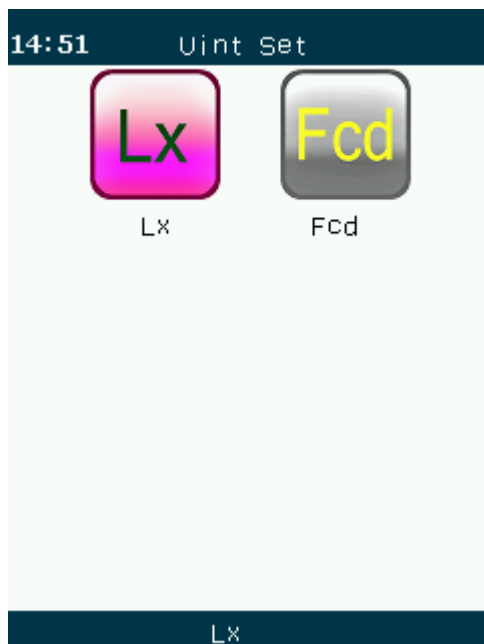

Two optional units of illumination are provided, Lx and Fcd.

2.4.3 Integral Time



This menu included two unit settings:

Integral Time unit setting, can choose Evh/Evm, corresponding Integral Time unit Hour/Minute respectively.

2.4.4 Standard Illumination Settings

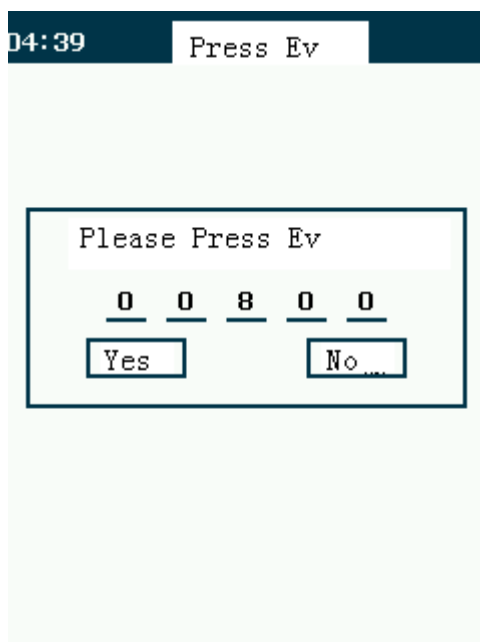

This function sets a standard illumination value. After entering this screen, press UP/DOWN button to firm a number within 0-9. After completing a set, cursor will move to another position to choose. Completed five blank positions setting, press UP/DOWN button to choose the weight of issue, or re-input a standard illumination value.

This function is used for helping field test, especially for a known standard range, to get a rapid and accurate detection.

2.5 Parameter description

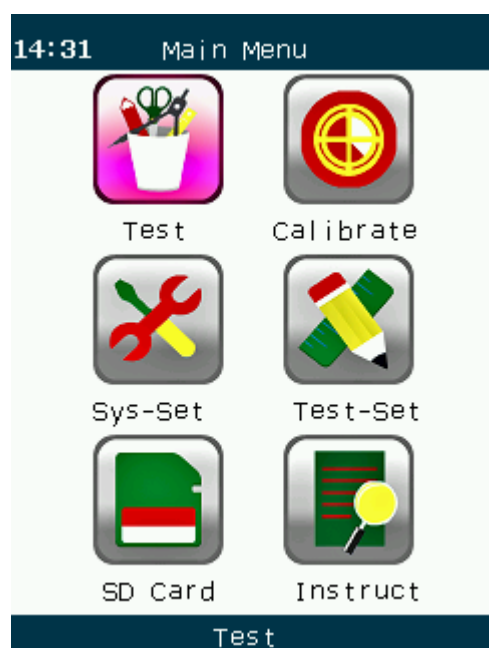

Select the option of parameter description, press the OK to jump into menu below.

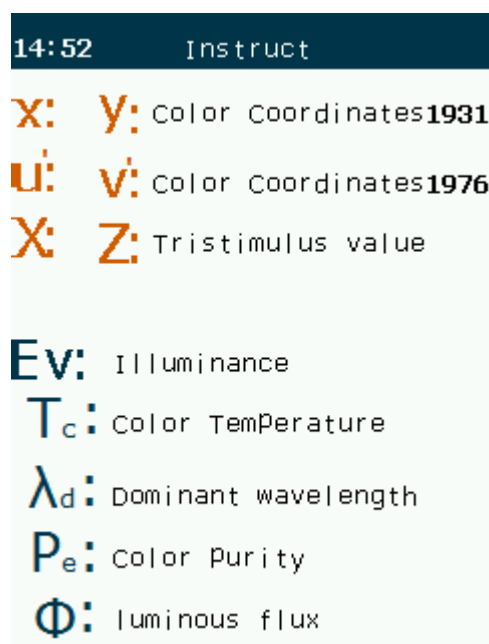

The definition of photometric and colorimetric symbols are provided in the page for operation.

III Measurement

3.1 Measuring Operation

After the startup-setting finished, pointing the photosensitive lens at light source to be measured directly and it starts measuring immediately.

The data shows on the display screen.

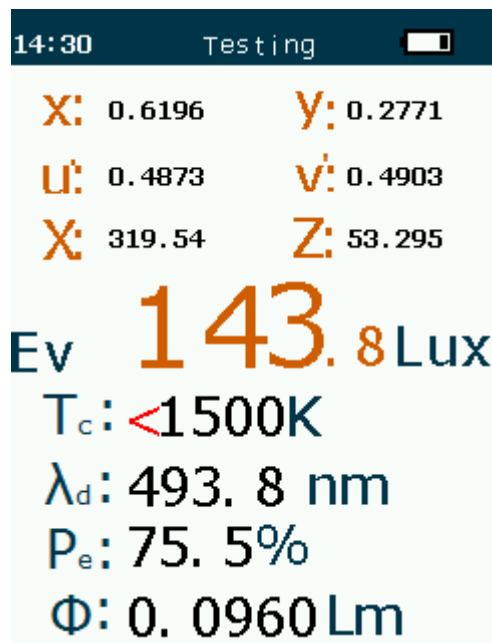

Measuring screen shows all real-time measured values, can be easily seen the measured Light Source parameter values.

There are 6 measured screens, press UP/DOWN to switch screen, all data are real-time measuring values.

The measuring order is switched as followed:

Illumination curve and Parameters screen 1:

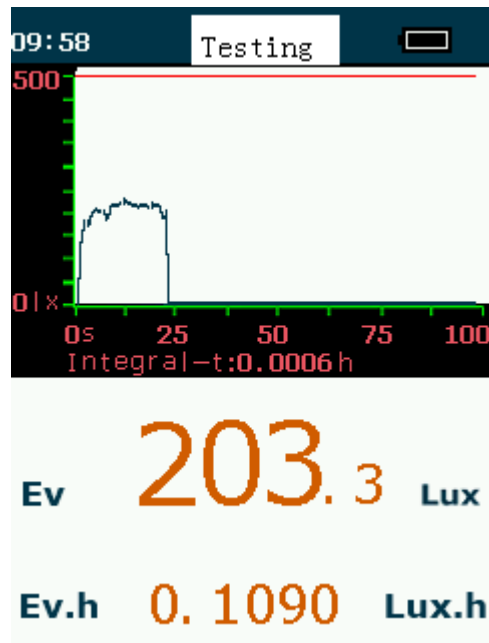

Red line is a standard illumination value. It can be set according to 2.3.

Real-time illumination curve

Real-time illumination

Real-time integration illumination

Illumination curve and Parameters screen 2:



Red line is a standard illumination value. It can be set according to 2.3.

Real-time illumination

Standard illumination

Illumination Difference value

Illumination ratio

CIE1931: .

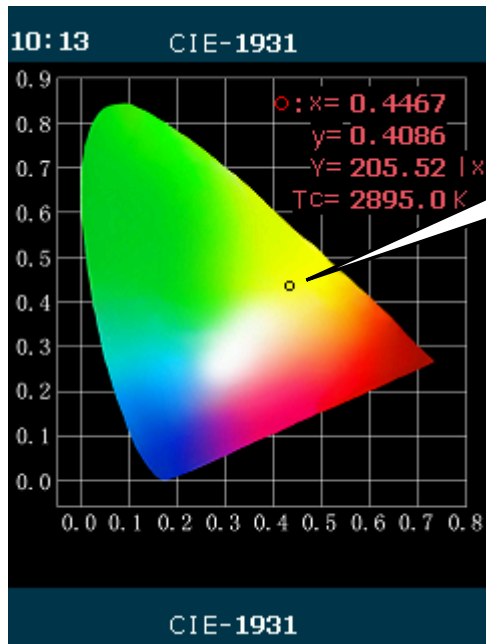

CIE1931 Real-time color coordinate and color range

(x,y)CIE1931 chroma coordinate
Y: Illumination value
Tc: Color temperature value

CIE1976:

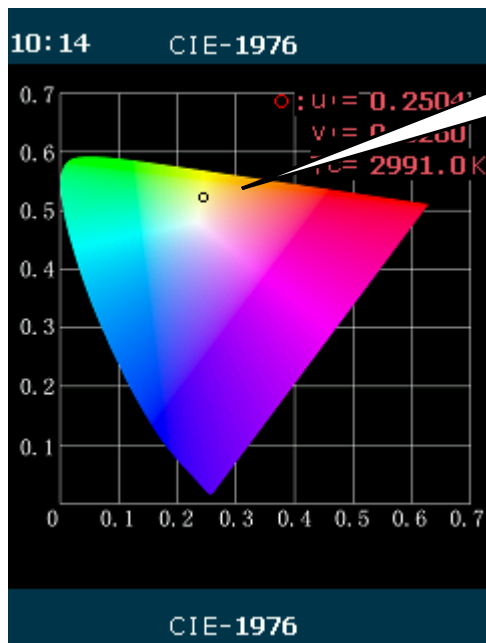

CIE1976 Real-time color coordinate and color range

(u',v')CIE1976 chroma coordinate
Tc: Color temperature value

3.2 Operation during Measuring

Press the 'hold' key until the word 'hold' shows on the upper right corner of the screen, then the measuring process would end, the test data would be stored in SD card automatically.

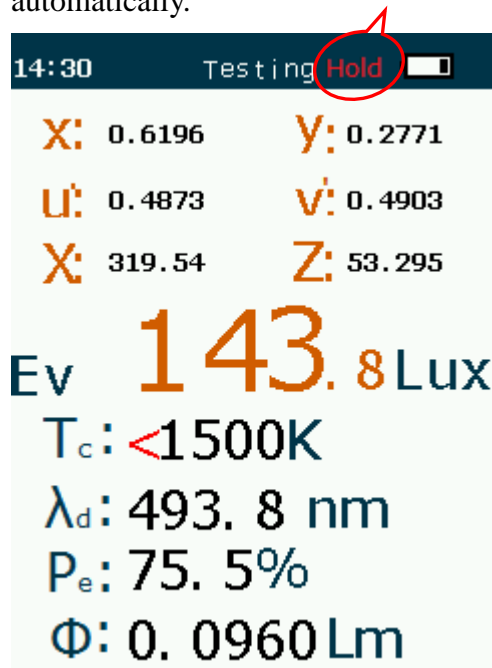

Press the 'hold' key again and measuring process starts again, as below:

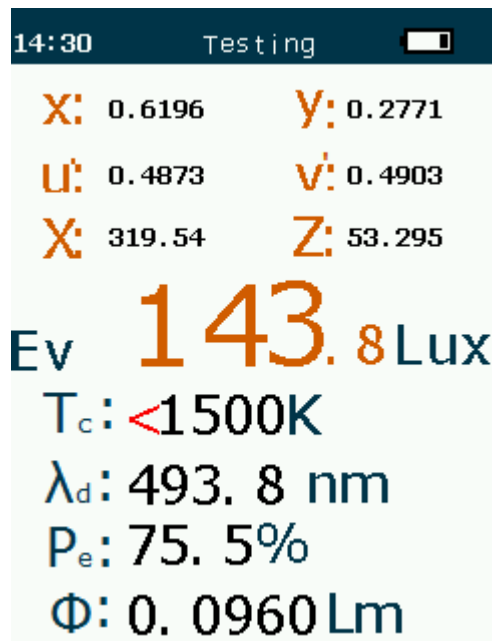

When a device complete a set of data testing, user can press 'MENU' key to jump into homepage and perform other operations. If press 'MENU' again, the page would

return to measuring page.

3.3 Color Difference Value and Chromaticity Coordinates

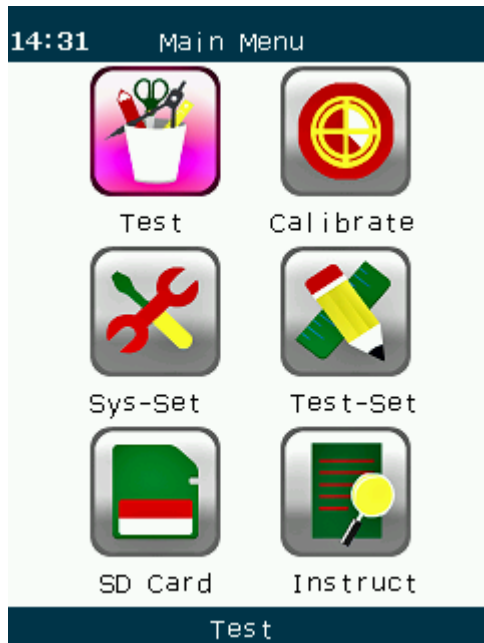

When we press the 'ok' key, it jumps into testing menu. User can check for color difference value, chromaticity diagram and RGB value.

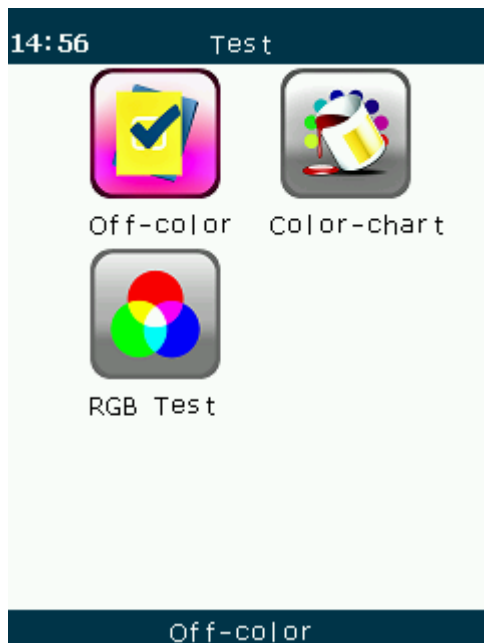

PCE-CRM 40 Chroma Meter

User can look up the latest one data of color difference value in the color difference value option, including $\Delta(XYZ)$, $\Delta(Evxy)$, $\Delta(Evuv)$, ΔEv ΔTc Δuv

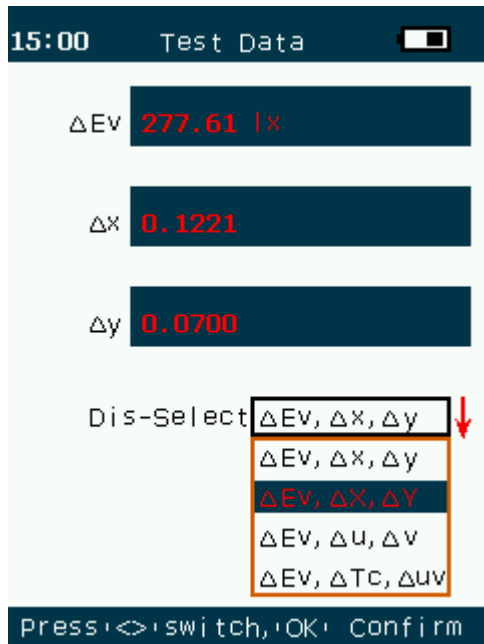

Chromaticity diagram is consisted with two coordinate graphs, CIE1931 and CIE1976

CIE1931

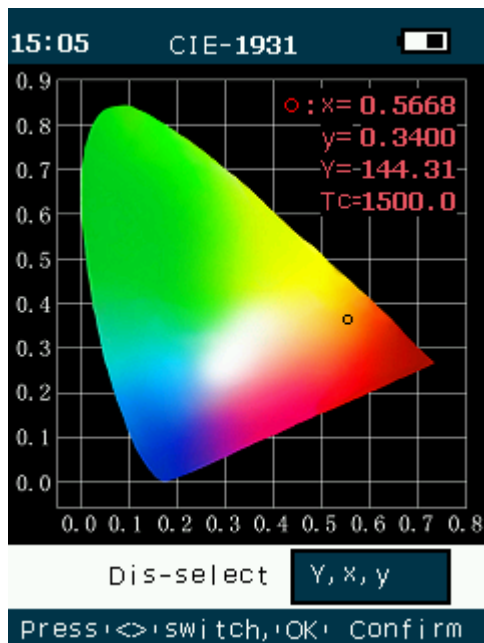

CIE1976

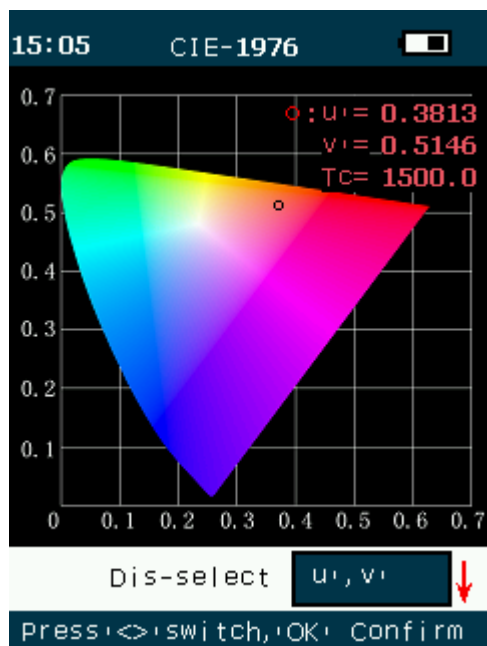

RGB Value

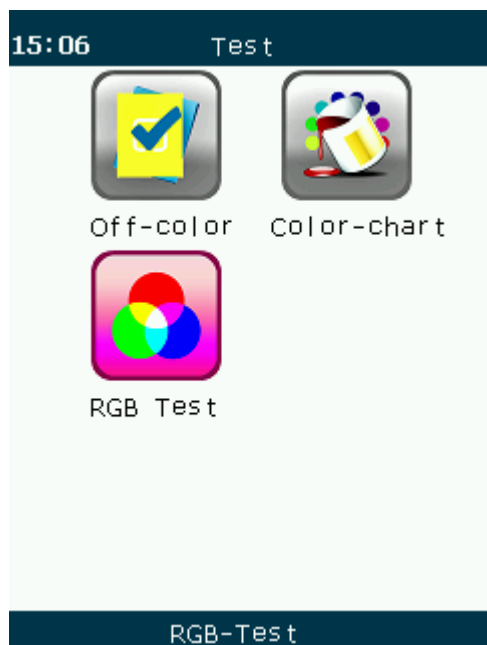

Select RGB test to view the RGB graph.

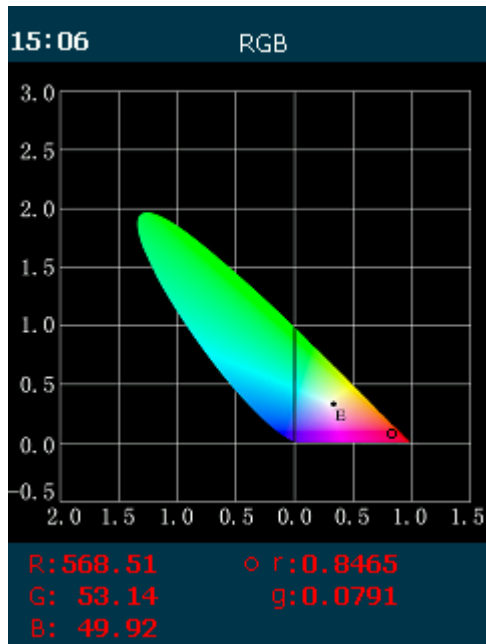

3.4 View Data

Enter the homepage, select the 'SD store', user can view the latest nine measurement data.

Select and press 'OK' key to get in the list of historical data.



Data list is sorted by time, and device only stores latest nine data. New data would cover previous data automatically.

User can view the history by selecting time and pressing 'OK' key.

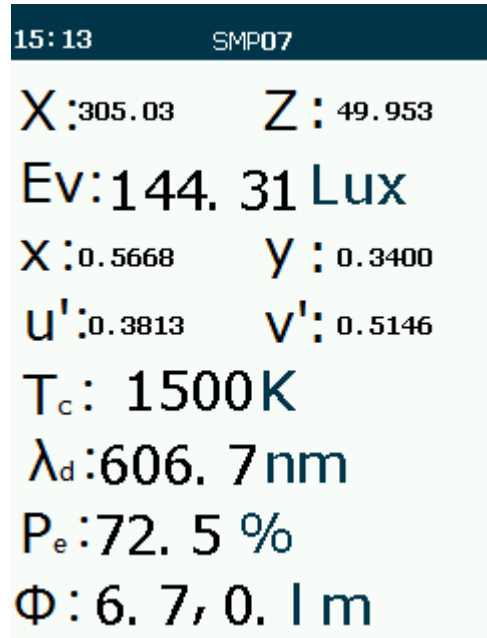

3.5 Maximum Measuring

Press the 'MAX' key, keep the device still and don't move, it starts measuring automatically.



Every data will be stored into SD card under "MAX" measuring condition. Measuring screen is showed as followed:

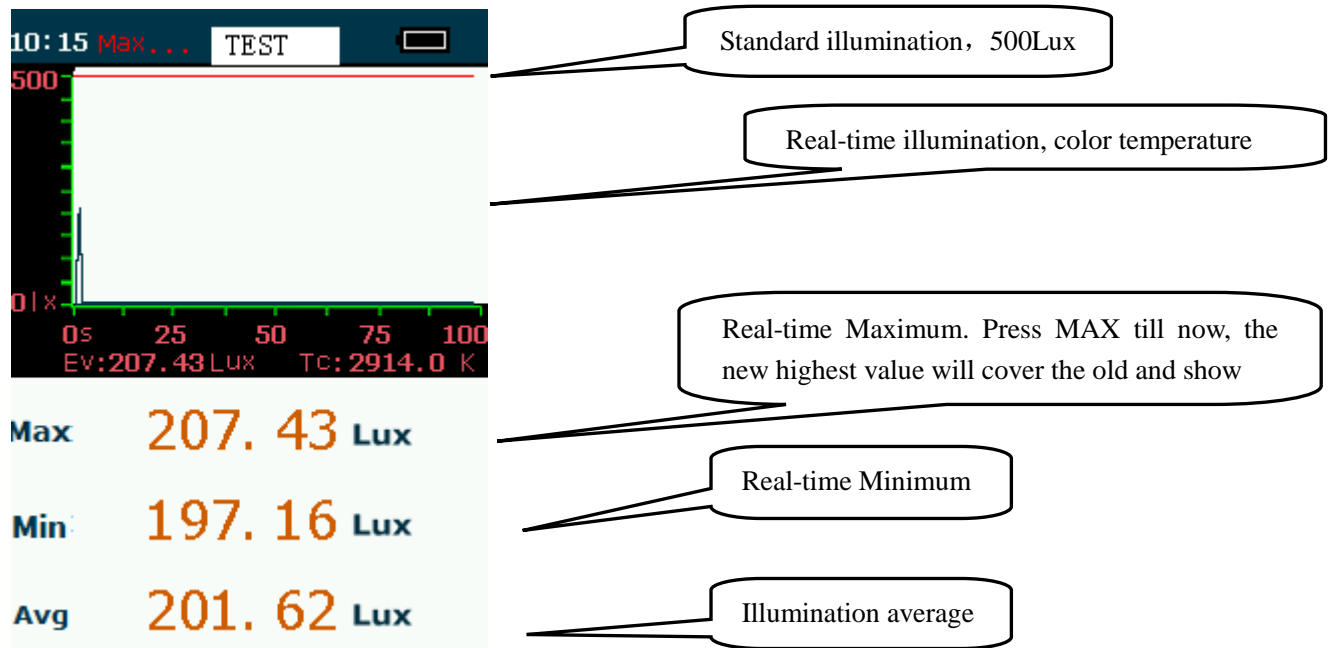

Under the “MAX” condition, Press the ‘HOLD’ key, the device stop measuring and keep the screen still, then give the tips about the appearing time of Maximum and Minimum value. See as followed:

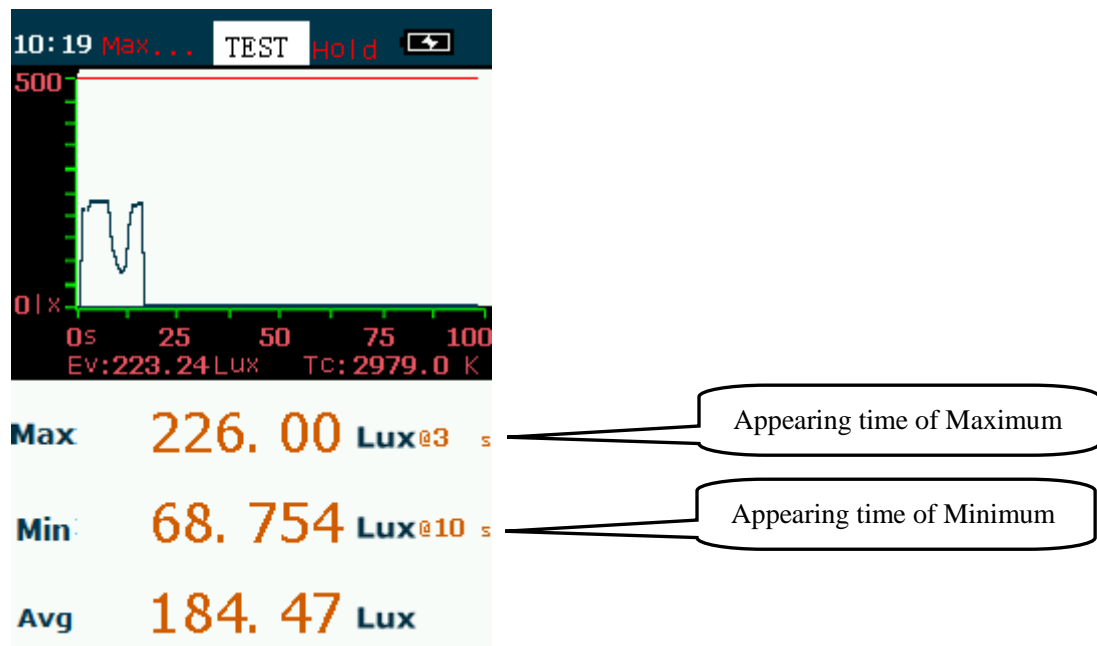

Press ‘MAX’ one more time to cancel the maximum measuring mode and return to normal measuring page.

3.6 Batch Data Processing

Either by connecting the computer with data line or taking out the SD card in device, user can do data batch processing. Txt file would be saved by device, and if imported into PC, the file would show as excel format, which is benefit for data management.

Import the txt file in SD card into PC software:

Select file and click import, click the data of certain point of time user can view the number of measuring times.

TIP: software run in win7 or more advanced operating system.

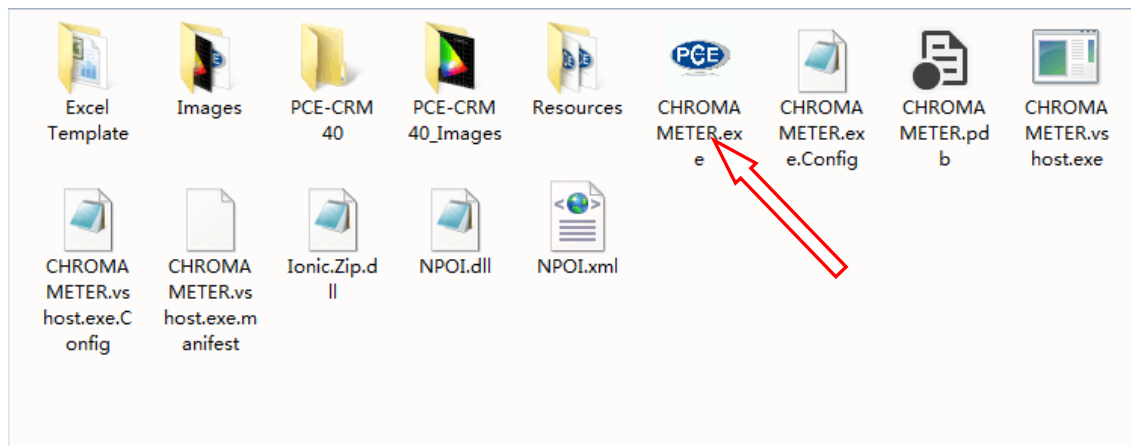

CHROMA METER--Parameter Settings

PCE

Product model PCE-CRM 40

Test equipment *****

Tester *****

Test institution *****

Temperature *****

Humidity *****

Manufacturer *****

OK Cancel

Select file and click export button to get the excel file of data from PC.

PCE-CRM 40 Chroma Meter

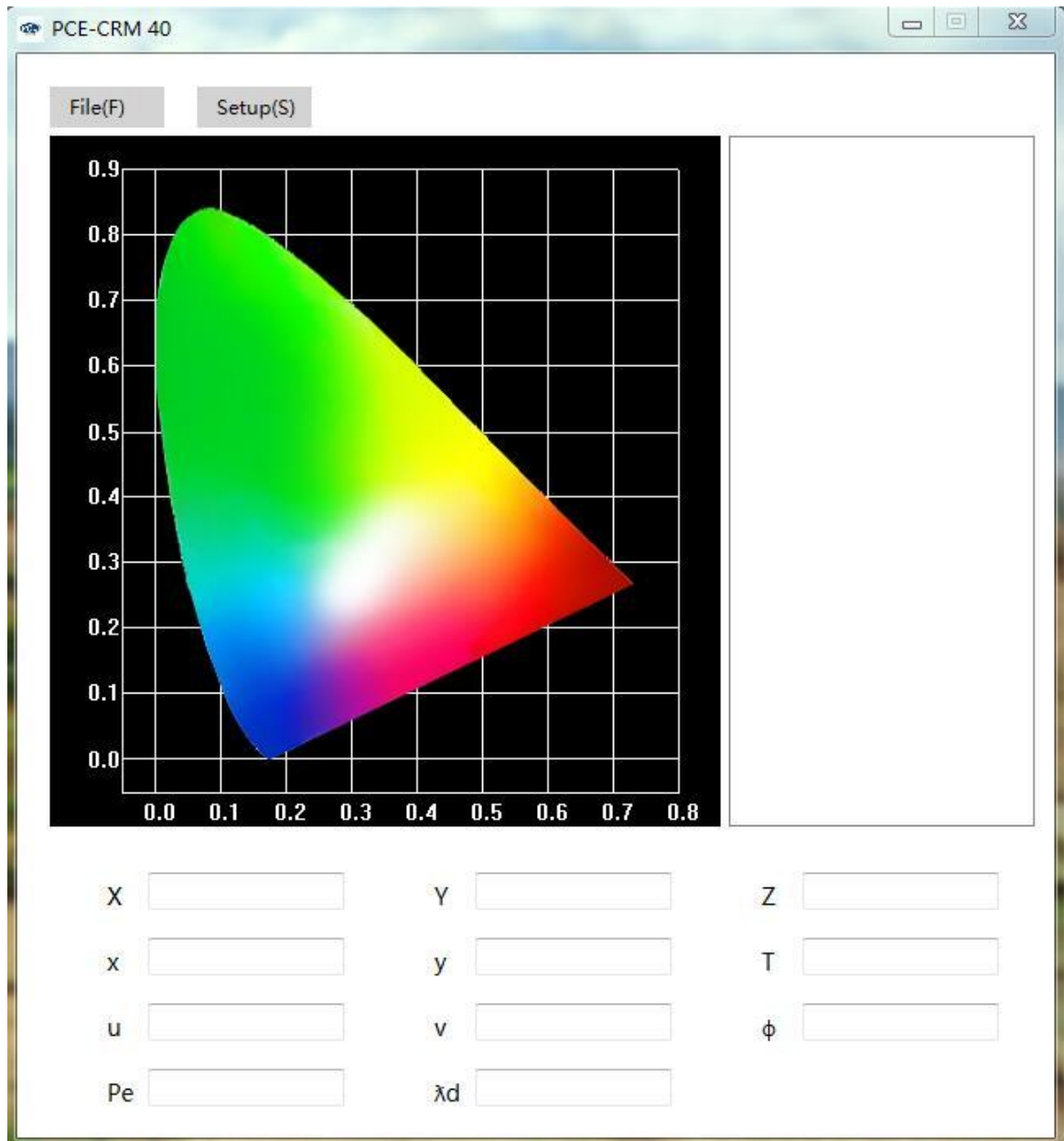

PCE-CRM 40 Chroma Meter

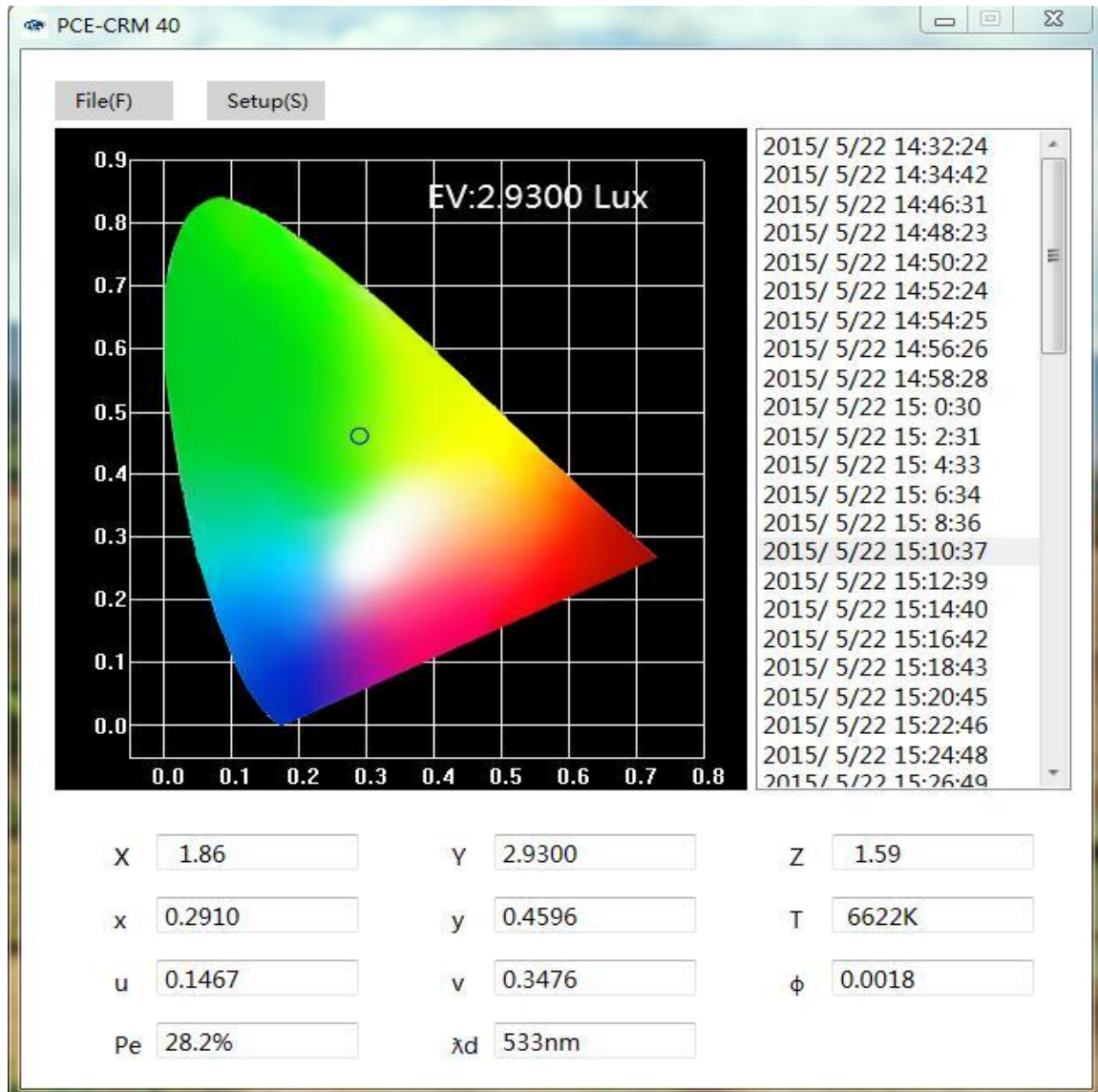

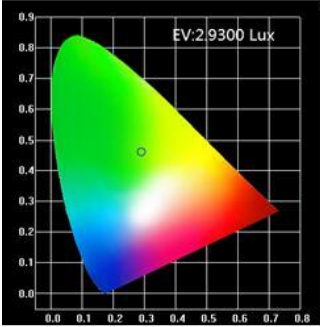
Color temperature light meter				
Test Project	Color temperature illumination Analysis			
Test Device	*****			
Test mark	Product model:PCE-CRM 40	Humidity:*****		
	Temperature:*****	Tester:*****		
	Manufacturer:*****			
	Test institution:*****			
	Measurement date:2015/ 5/22 15:10:37	Processing date:2017/1/19 14:07:20		
	Processing result:			
	Illumination Y	2.9300	Chroma T	6622K
	u	0.1467	v	0.3476
	x	0.2910	y	0.4596
	Pe	28.2%	λd	533nm
X	1.86	Φ	0.0018	
CIE1931	Z	1.59		

It is possible to modify the contents of the output file according to the user needs.

Find the template.xls file, change the content you want and save.

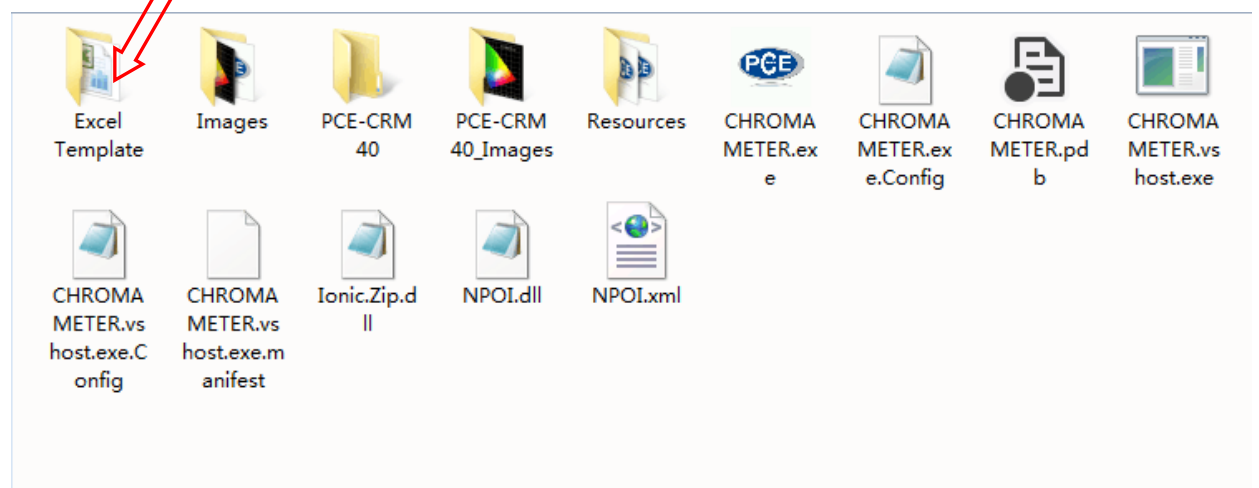

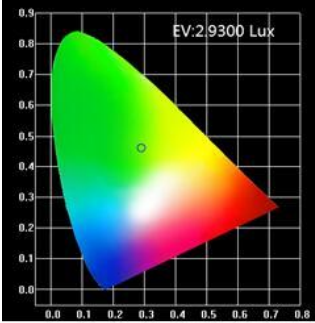
Color temperature light meter				
Test Project	Color temperature illumination Analysis			
Test Device	*****			
Test mark	Product model:PCE-CRM 40	Humidity:*****		
	Temperature:*****	Tester:*****		
	Manufacturer:*****			
	Test institution:*****			
	Measurement date:2015/ 5/22 15:10:37	Processing date:2017/1/19 14:07:20		
	Processing result:			
	Illumination Y	2.9300	Chroma T	6622K
	u	0.1467	v	0.3476
	x	0.2910	y	0.4596
	Pe	28.2%	λd	533nm
X	1.86	Φ	0.0018	
CIE1931	Z	1.59		

IV Attentions and Basic Maintenance

4.1 Attentions in use

- It is a high-precision instrument, must carried by hand and used carefully.
- Please read this instruction thoroughly before first time use.
- Please keep it power off before you remove or install the measuring lens.
- Please protect the measuring lens carefully and keep the lens clean. Don't wipe it and put the cover on the lens after use.
- Don't press the screen hard and keep it out of any external impact or heavy pressure.
- Please use the device in the temperature between -10°C to 40°C , in the humidity less than 85% (35°C).
- Notice that it is normal the device would become warm if you put it under the direct sunlight or it is surrounded by relative hot instrument. Please protect the device carefully under those circumstance.
- The apex of the sphere of the measuring lens is used as a lighting related plane.
- It is possible that strong electromagnetic field would have a strong effect on internal microprocessor of instrument. Please turn off the power of device and AC adaptor, then power on and restart the device,
- Don't use it in the area with altitude higher than 2000 meters.
- If you want to use the AC adaptor, please make sure that you use the power supply thar

we have specified.

- The instrument is set for grade II pollution products, please do not use in the area with high concentration of metal particle dust.
- Please put the device into the protection package after use. Keep it out of too hot, too cold and vibration.



4.2 How to clean

- Please use dry cloth or silicon cloth to wipe the dust on the lens. Don't use solvents such as diluent and benzene.
- If there are a lot of dust on the lens, please use soft dry cloth to wipe out. If the dust cannot be wipe out or the lens has been scratched, please contact the after-sale service center nearby immediately.
- If the device is out of order, don't disassemble it privately or try to fix it by yourself. Please contact the after-sale service personnel immediately.

How to place

- Don't place the device in the environment with high temperature and humidity.
- Don't place the device in the rear glass or in the trunk of the car. The temperature will rise so that the instrument can be deformed or damaged.
- If you won't use the device in 2 weeks or longer period of time, please turn off the power thoroughly
- Don't wrap the device with cable around or the connector and the root of the cable may be under excessive force, thereby causing the disconnection.

V Specifications

Model	PCE-CRM40
Range	Illumination: 0.1-200000lx, 0.01-20000 fcd Color Temperature: 1500-25000K Range: (5lx, >0.5fcd) automatically switch in four gears
Accuracy	Ev(linear): $\pm 2\%$ of reading xy: ± 0.003 (500lx, Standard light source A)
Repeatability	Ev: $\pm 2\% + 1$ decimal digits (2σ) xy: ± 0.0005 (500lx, Standard light source A)
Correlative-spectral sensitivity	Consistent with CIE standard observer curve
Test Channel	Optional multiple channels, adapt to different lighting sources and applications; optional self-calibration channel.
Cosine correction (f2)	Ev: <3%
Parameters	Three stimulus values: XYZ Chroma value: Evxy; Evuv; Ev; Illumination: Ev, integral illumination; Illumination curve and multi-points setting, standard illumination setting; Maximum, Minimum, Average Correlative color temperature: Tc; Color temperature curve and multi-points setting; Standard Color temperature setting; Maximum, Minimum, Average Chromatic aberration: $\Delta(XYZ)$, $\Delta(Evxy)$, $\Delta(Evuv)$, $\Delta Ev \Delta Tc \Delta uv$ Chromaticity coordinates: ICE1931(x, y), ICE1976(u, v); Main wavelength: λd Color purity: Pe Luminous flux: Φ RGB Value MAX function
Other Functions	Multiple channel、Multiple standard sample、Large capacity data storage (more than 1000 times); User-calibration; Automatic shutdown; Auto turn off backlight
Display Interface	One screen display: illumination Ev, CIE1931(x, y), CIE1976(u, v), Color temperature Tc, Main wavelength λd , Chroma purity Pe, Luminous flux Φ Multi-screen Real-time measuring show: Real-time

PCE-CRM 40 Chroma Meter

	illumination, color temperature curve, CIE1931, CIE1976 real-time show
Language	Simplified Chinese, English
Interface	Micro USB 2.0
Power	Micro USB data line; 2200mAh large capacity lithium battery
Operating Temperature and Humidity Range	-10-40° C, Correlative humidity <85%(35° C), No condensation
Storage temperature and humidity range	-10-40° C, Correlative humidity <85%(35° C), No condensation
Size	210*80*35mm
Weight	235g
Standard Accessories	Dust Cover, Power adapter, USB data line, data management software disc, Host Rope, anti-lost lens cover rope, device leather bag, baffle.