

PQ3100 POWER QUALITY ANALYZER Measurement Guide

Thank you for purchasing the Hioki PQ3100 Power Quality Analyzer. This guide introduces the instrument's basic measurement procedure to first-time users with Quick Set. Before using the instrument, be sure to read the Instruction manual carefully.

HIOKI



EN

July 2017 Revised edition 1
Printed in Japan PQ3100A971-01 17-07H

Quick Set for **Easy** Setting

Try to check for the power supply malfunction in a 3-phase 4-wire 230 V line.

You will need



Model PQ3100



Model L1000-05 Voltage Cord

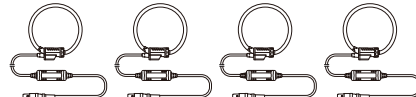

Model Z1002 AC Adapter

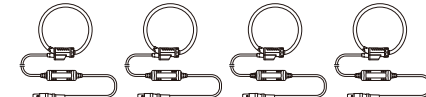

Model CT7045 AC Flexible Current Sensor (optional)



Colored clips for current sensors



Model Z1003 Battery Pack



Model Z4001 SD Memory Card 2GB (optional)

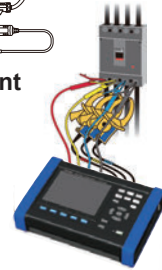

(Wiring image)

1. Preparations

1 Install the Battery Pack.

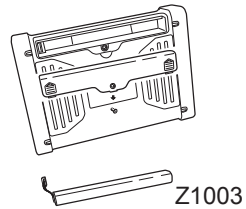

2 Wind the clips of the same color as the channels around the leads.

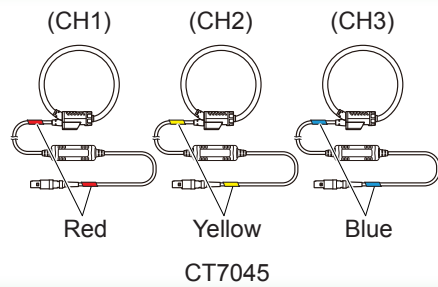

3 Insert the SD memory card.

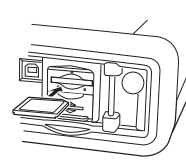

4 Connect the AC adapter.

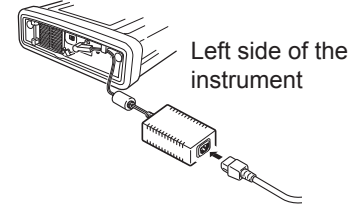

Left side of the instrument

Right side of the instrument

Refer to Chapter 2 on the Instruction Manual.

2. Starting Quick Set

1 Turn on the instrument.

(Language, clock and measuring frequency are required to be set only during the first setting. Refer to the Instruction Manual.)

2 Press the **QUICK SET** key.

3 Press the **ENTER** key.

Refer to Chapter 3 on the Instruction Manual.

To exit in the middle of settings

Press any of the other screen switching keys. All the settings before the exit are saved.

3. Basic Settings

1 Settings for the wiring.

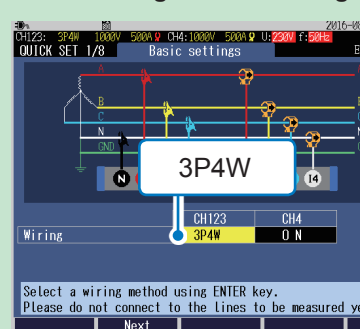

2 Press the **F2 (Next)** key.

Refer to Section 1.6 on the Instruction Manual.

1. Move cursor
2. Display drop-down list
3. Select wiring
4. Settle setting

4. Connections with the Instrument

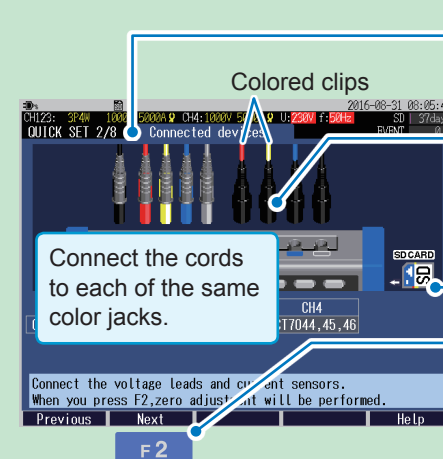

- 1 Connect the voltage cords to the voltage input jacks.
- 2 Connect the current sensors to the current input jacks. The current sensors will be automatically identified.
- 3 Check that the SD memory card is inserted.
- 4 Without connecting the voltage cords and current sensors to the measuring lines, press the **[F2] (Next)** key. Zero adjustment will be automatically performed.

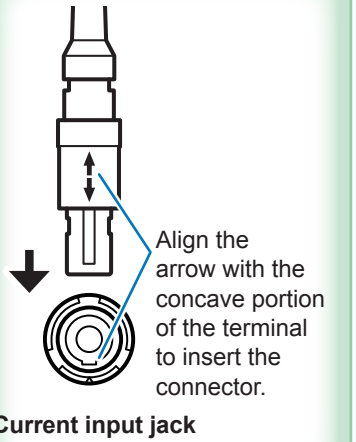

Current input jack

Refer to Sections 4.3 through 4.5 on the Instruction Manual.

5. Wiring Voltage Cords to the Measuring Object

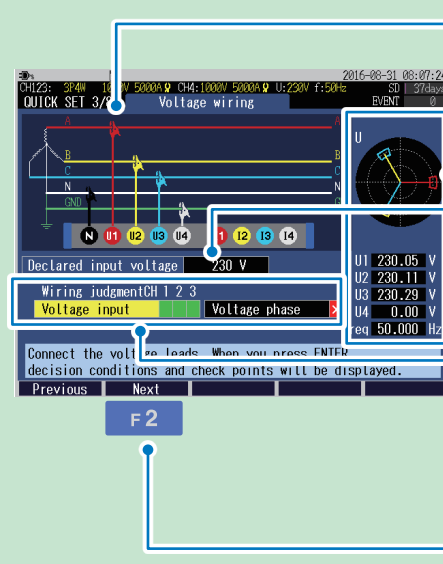

- 1 Refer to the wiring diagram to check the locations to which the voltage cords have to be connected.
- 2 Attach the voltage cords to the secondary side of the breaker.
- 3 Check the vectors and measured values.
- 4 Check the declared input voltage. In completion of the wiring, values will be set automatically. If the values are different from the actual values, change the values.
- 5 Check the wiring judgment.
 - If **red** or **yellow** is displayed:
 1. Move the cursor to the **red** or **yellow** items.
 2. Press the **[ENTER]** key.
 3. Refer to the key points shown in the dialog to correct the wiring.
 - If all the items are judged to be **green**: (You can proceed to the next step even with **red** or **yellow**.)
- 6 Press the **[F2] (Next)** key.

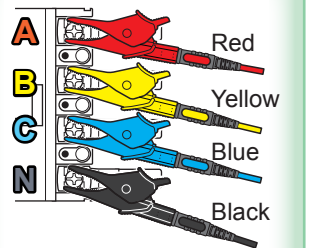

For a bus bar, pinch the metal part.

Refer to Section 4.6 on the Instruction Manual.

6. Wiring Current Sensors to Measuring Object

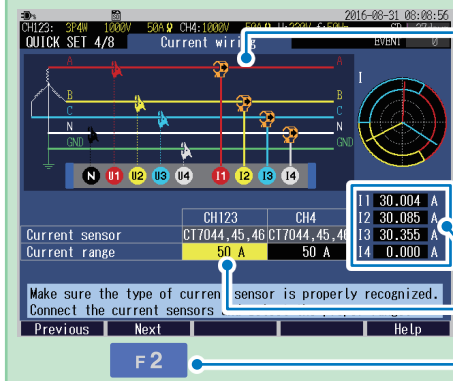

- 1 Refer to the wiring diagram to check the locations to which the current sensors have to be connected.
- 2 Attach the current sensors around the wires connected to the secondary side of the breaker.
- 3 Verify that the measured values are displayed.
- 4 Set the current range.
- 5 Press the **[F2] (Next)** key.

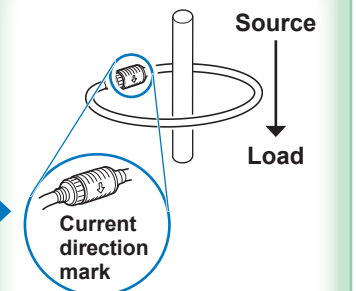

Attach the sensor around only one of the conductor.

Refer to Sections 4.7 and 4.8 on the Instruction Manual.

Tip

Set the current range based on the maximum load current expected to flow during the measurement period. (Consult the operating status, load rating, breaker rating, and other data to make this determination.) If the range is too low, the instrument will experience an overrange event during measurement. The error component increases if the range is too high. Current cannot be measured accurately in any of the above cases.

7. Wiring Check

1 Check the measured values and vectors.

Check the wiring in the following cases.

- Measured values of the channels are low, or active power **Psum** shows a negative value.
 - Displacement power factor **DPFsum** is below 0.5.
 - The vector position is outside the PASS range.
- Refer to Section 4.9 on the Instruction Manual.



2 Check the wiring judgment.

- If ■ (red) or ■ (yellow) is displayed:

- Move the cursor to the item in ■ (red) or ■ (yellow) item.
- Press the **[ENTER]** key.
- Refer to the key points shown in the dialog to correct the wiring.

- If all the items are judged to be ■ (green):

- The color was ■ (yellow) but the wiring check did not indicate any problems:

3 Press the **[F2]** (Next) key.

8. Event Settings

1 Check the declared input voltage.

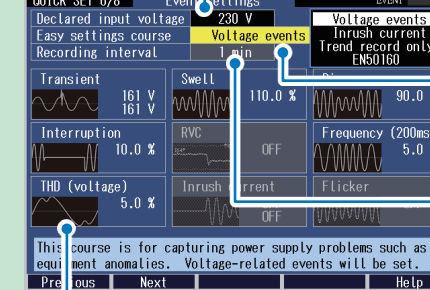

2 Select the easy settings course.

3 Check the recording interval.

Voltage events

1 min

Changes can be made in "Step 9. Recording Settings".

4 Press the **[F2]** (Next) key.

Events that can be measured with the selected menu are displayed. (Events are displayed with light color cannot be measured.)

Voltage events

This is used to investigate the cause of power supply abnormalities such as equipment malfunction. Voltage components (swell, dip, interruption) and frequency are monitored. The recording interval will be set to 1 minute.

Inrush current

This is used to measure the inrush current. Event thresholds for inrush current is set to 200% of current RMS and the recording interval to 1 minute.

Trend record only

This is used to record measured values over an extended period of time. All the event settings (effective only for manual events, recording start events, and recording stop events) are set to OFF and recording interval is set to 10 minutes.

EN50160

This is used to measure in conformance to the European Norm EN50160. The recording interval is set to 10 minutes. (The recording interval is fixed to 10 minutes. Cannot be changed.)

Refer to Section 5.3 on the Instruction Manual.

Easy settings course

Threshold values for events and recording interval will be automatically configured. To make any change to the event settings, press the **[SETUP]** key after completion of Quick Set to display the **Event Settings** screen.

9. Recording Settings

1 Configure the Recording start and Recording stop.

Interval: Recording will start at a well-defined time in accordance with the **Recording interval**.

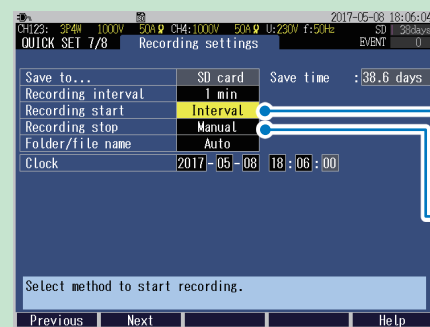

Tip

If the **Save time** is less than the measurement period, the following methods can be used to increase the save time:

- Recording interval:** Lengthened
- SD memory card: Delete unnecessary data, and format it. (Exit the Quick Set and use the **FILE** screen.)

2 Press the **[F2]** (Next) key.

Refer to Section 5.2 on the Instruction Manual.

10. Checking Settings and Recording

Refer to Chapter 7 on the Instruction Manual.

1 Check the settings.

To make any changes to the settings, press the **[F1]** (Previous) key to return to applicable screen.

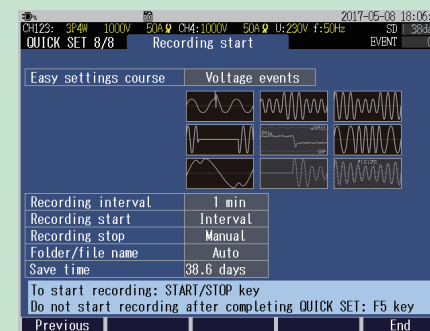

2 Press the **START/STOP** key.

START/STOP LED



The instrument enters the standby state. (START/STOP LED: Blinking)

The recording will start at the time set by the interval*.

The instrument enters the recording state. (START/STOP LED: On)

To start recording after setting the items that are not listed in Quick Set.

Press the **[F5]** (End) key.

The settings configured up to this point will be saved.

*: Interval

In case of **Recording interval:** 5 min

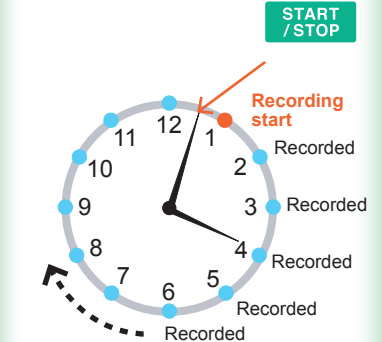

3 Press the **START/STOP** key.

The recording stop dialog will be displayed.

4 Press the **ENTER** key.

Recording will be stopped. (START/STOP LED: Off)

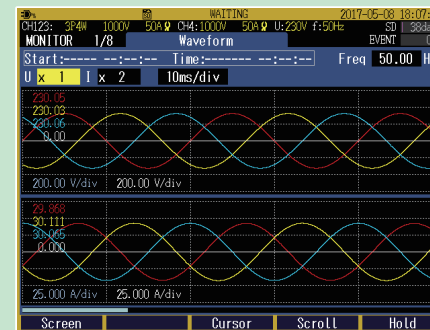

Fluctuations in measured values during recording can be monitored.

Press the **[TREND]** key to display the **TREND** screen.

The measured items in the form of a time series graph can be observed.



Refer to "8. Verifying the Trends (Fluctuations) in Measured Values" on the Instruction Manual for details.

Event occurrence status during recording can be monitored.

Press the **[EVENT]** key to display the **EVENT** screen.

Event occurrence status can be checked.

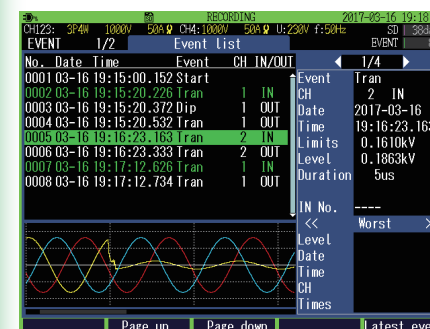

Refer to "9. Checking Events" on the Instruction Manual for details.

Recorded data can be post-analyzed with a computer.

Data after completion of recording can be analyzed with a computer using the supplied PC application software.

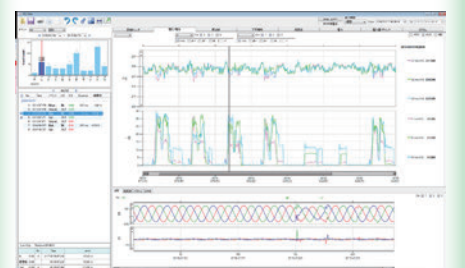

Functions:

- Observing time series data, event data, and event waveform
- Observing statistics data
- Creating reports

Refer to "11. Analysis (with Computer)" on the Instruction Manual for details.