

PS4660T and PS5560T User Manual



Touchboards

205 Westwood Ave, Long Branch, NJ 07740
Phone: 866-94 BOARDS (26273) / (732)-222-1511
Fax: (732)-222-7088 | E-mail: sales@touchboards.com

PLANARTM

Copyright © 9 May 2013 by Planar Systems, Inc. All rights reserved.

Contents of this publication may not be reproduced in any form without permission of Planar Systems, Inc.

Trademark Credits

Windows™ is a trademark of Microsoft Corp.

All other names are trademarks or registered trademarks of their respective companies.

Disclaimer

The information contained in this document is subject to change without notice. Planar Systems, Inc. makes no warranty of any kind with regard to this material. While every precaution has been taken in the preparation of this manual, the Company shall not be liable for errors or omissions contained herein or for incidental or consequential damages in connection with the furnishing, performance, or use of this material.

Part Number: 020-1222-01A

Table of Contents

- Introduction**1
 - Safety Information2
 - Safety Precautions.....2
 - Recommended Usage4
 - VESA Mounts, General Description6
 - Cleaning the PS4660T/PS5560T7
 - Ambient Light Recommendations7

- Package Contents**8
 - Unpacking the PS4660T/PS5560T8

- Dimensions** 11
 - PS4660T - Front and Side 11
 - PS4660T - Rear 12
 - PS5560T - Front and Side 12
 - PS5560T - Rear 13

- Installing a PS4660T/PS5560T** 14
 - Before You Begin..... 14
 - Connectivity 15

- Operating the PS4660T/PS5560T** 16
 - OSD Keypad..... 16
 - Remote Control Receiver 17
 - LED Indicators..... 17
 - Using the Display in Portrait Mode 18

Using the Remote Control	19
Using the Touch Screen	22
Multi-Touch Functions	24
Turning the PS4660T/PS5560T On	25
Turning the PS4660T/PS5560T Off	25
Adjusting the Volume	25
Selecting the Input Source	25
OSD Menu Functions.....	26
OSD Menus	28
Navigating Through the Menus.....	31
Default Settings.....	43
Signal Compatibility	44
Specifications.....	45
Troubleshooting	47
Accessing Planar’s Technical Support Website.....	48
Downloading Additional Documentation and Firmware.....	48
Downloading Utility Software	48

Introduction

The PS4660T/PS5560T is a 46" or 55" diagonal edge-lit LED LCD touchscreen display that can be wall mounted, ceiling mounted or mounted on a stand. The display can be portrait or landscape.

The PS4660T/PS5560T is ultra slim and has an aspect ratio of 1.77 (16:9). The PS4660T/PS5560T has a native HD (1920 x 1080) resolution.

Additional features of the Planar PS4660T/PS5560T include six-point touch, ambient light control, and display control through RS232. These displays also provide superior energy efficiency in a lightweight design.

Caution: This manual is intended for use by qualified service persons and end users with experience installing LCD displays.

Safety Information

Before using the PS4660T/PS5560T, please read this manual thoroughly to help protect against damage to property, and to ensure personnel safety.

- Be sure to observe the following instructions.
- For your safety, be sure to observe ALL the warnings detailed in this manual.
- For installation or adjustment, please follow this manual's instructions, and refer all servicing to qualified service personnel.

Safety Precautions

- **If water is spilled or objects are dropped inside the display, remove the power plug from the outlet immediately.** Failure to do so may result in fire or electrical shock. Contact your dealer for inspection.
- **If the display is dropped or the chassis is damaged, remove the power plug from the outlet immediately.** Failure to do so may result in fire or electrical shock. Contact your dealer for inspection.

WARNING! Wall mounts must be secure.

- **If the display is hung on a wall, the wall must be strong enough to hold it.** Simply mounting it to wallboard or wall paneling won't be adequate or safe.

Caution: The screen could be damaged by heavy pressure.

- **If the power cord or plug is damaged or becomes hot, turn off the main power switch of the display. Make sure the power plug has cooled down and remove the power plug from the outlet.** If the display is still used in this condition, it may cause a fire or an electrical shock. Contact your dealer for a replacement.

Important Safety Instructions

- 1** Read these instructions.
- 2** Keep these instructions.
- 3** Heed all warnings.
- 4** Follow all instructions.
- 5** Do not use the display near water.
- 6** Clean the LCD screens with an LCD screen cleaner or LCD wipes.
- 7** Do not install near any heat sources such as radiators, heat registers, stoves or other apparatus (including amplifiers) that produce heat.
- 8** Do not defeat the safety purpose of the polarized or grounding type plug. A polarized plug has two blades with one wider than the other. A grounding type plug has two blades and a third grounding prong. The wide blade or the third prong is provided for your safety. When the provided plug does not fit into your outlet, consult an electrician for the replacement of the obsolete outlet.
- 9** Protect the power cord from being walked on or pinched, particularly at plugs, convenience receptacles and the point where they exit from any of the displays.
- 10** Only use the attachments/accessories specified by the manufacturer.
- 11** Unplug all displays during lightning storms or when unused for long periods of time.
- 12** You must follow all National Electrical Code regulations. In addition, be aware of local codes and ordinances when installing your system.
- 13** Refer all servicing to qualified service personnel. Servicing is required when any of the displays have been damaged in any way. For example, if the AC power cord or plug is damaged, liquid has been spilled or objects have fallen into a display, the displays have been exposed to rain or moisture, do not operate normally or have been dropped.
- 14** Keep the packing material in case the equipment should ever need to be shipped.
- 15** Wall mounts must be secure. The wall must be strong enough to hold all of the displays, brackets and cables.

Recommended Usage

In order to get the most out of your LCD, use the following recommended guidelines to optimize the display.

Burn-In Versus Temporary Image Retention

Burn-in causes the screen to retain an image essentially forever, with little or no way to correct the problem. Under normal use, an LCD will not experience burn-in, as plasma displays do, nor will it retain images in any way.

Normal use of an LCD is defined as displaying continuously changing video patterns or images. However, LCDs can experience *temporary* image retention when recommended usage guidelines are not followed.

What is Temporary Image Retention?

Temporary image retention (TIR) can occur when a static image is displayed continuously for extended periods of time (12 hours or longer). An electrical charge differential may build up between the electrodes of the liquid crystal, which causes a negative-color video image (color-inverted and brightness-inverted version of the previous image) to be retained when a new image is displayed. This behavior is true for any LCD device from any LCD manufacturer.

TIR is not covered under warranty. See standard warranty terms and conditions for details. Here are some guidelines to help you avoid TIR:

- Use the LCD to show a screen saver, moving images or still pictures that change regularly. When using high-contrast images, reposition the images frequently.
- Turn off the LCD when it is not in use. To use your source computer's Power Options Properties, set up your computer to turn off the display when not in use.

Caution: For optimal performance, we suggest turning off the backlight power on the PS4660T/PS5560T for six hours per day.

European Union Disposal Information

English

- Disposal of old Electrical & Electronic Equipment (Applicable throughout the European Union and other European countries with separate collection programs)

This symbol found on your product or on its packaging, indicates that this product should not be treated as household waste when you wish to dispose of it. Instead, it should be handed over to an applicable collection point for the recycling of electrical and electronic equipment. By ensuring this product is disposed of correctly, you will help prevent potential negative consequences to the environment and human health, which could otherwise be caused by inappropriate disposal of this product. The recycling of materials will help to conserve natural resources.



This symbol is only valid in the European Union. If you wish to discard this product, please contact your local authorities or dealer and ask for the correct method of disposal.

Español

- Deshecho de equipos eléctricos y electrónicos (aplicable a la Unión Europea y a otros países europeos con programas de reciclaje independientes)

La presencia de este símbolo en el propio producto o en su material de embalaje, indica que no se debe tratar como residuo doméstico cuando desee deshacerse de él. En su lugar, debe entregarlo en el punto limpio correspondiente de reciclaje de equipos eléctricos y electrónicos. Asegurándose de que este producto se desecha de forma correcta, ayudará a evitar posibles consecuencias negativas para la conservación del medioambiente y la salud humana, consecuencias que podrían darse si se desecha del producto de forma inadecuada. El reciclado de materiales ayuda a conservar los recursos naturales.



Este símbolo solamente es válido en la Unión Europea. Si desea deshacerse de este producto, póngase en contacto con las autoridades locales o con su distribuidor y pida información sobre el método de disposición adecuado.

Português

- Eliminação de equipamentos eléctricos e electrónicos usados (aplicável na União Europeia e noutros países europeus com programas próprios de recolha destes equipamentos)

Este símbolo, colocado no produto ou na respectiva embalagem, indica que o produto não deve ser tratado como lixo doméstico aquando da sua eliminação. Em vez disso, deve ser entregue num ponto de recolha de equipamentos eléctricos e electrónicos para posterior reciclagem. Ao garantir a correcta eliminação deste produto, estará a evitar consequências potencialmente negativas tanto para o ambiente como para a saúde humana. A reciclagem de materiais ajuda a preservar os recursos naturais.



Este símbolo apenas é válido na União Europeia. Se quiser eliminar este produto, contacte as entidades locais ou o seu fornecedor para ficar a saber qual o método de eliminação correcto.

Svenska

- Avfall av förbrukad elektrisk och elektronisk utrustning (Tillämplbart i hela Europeiska unionen och andra europeiska länder med separata samlingsprogram)

Den här symbolen som finns på din produkt eller på dess förpackning påvisar att produkten inte ska behandlas som hushållsavfall när du vill slänga bort den. Istället ska den lämnas över till en lämplig uppsamlingspunkt för återvinning av elektriska och elektroniska utrustningar. Genom att tillförsäkra att den här produkten återvinns på ett riktigt sätt hjälper du till med att förhindra möjliga negativa konsekvenser för miljön och mänsklig hälsa. Det kan annars orsakas på grund av olämplig sophantering av den här produkten. Återvinning av material kommer att hjälpa till att bevara naturtillgångar.



Den här symbolen är endast giltig inom den Europeiska unionen. Om du vill slänga bort den här produkten ska du kontakta lokala myndigheter eller återförsäljare, och fråga efter lämplig avfallsmetod.

Français

- Mise au rebut des équipements électriques et électroniques usagés (Valable dans l'ensemble de l'Union Européenne ainsi que dans les pays européens disposant de programmes distincts de collecte des déchets)

Ce symbole appliqué sur votre produit ou sur son emballage indique que ce produit ne doit pas être traité comme un déchet ménager lorsque vous voulez le mettre au rebut. Il doit au contraire être remis à un site de collecte agréé pour le recyclage des équipements électriques et électroniques. En veillant à ce que ce produit soit mis au rebut de façon adéquate, vous contribuerez à prévenir les conséquences potentiellement négatives sur l'environnement et sur la santé humaine qui risqueraient de se produire en cas de mise au rebut inappropriée de ce produit. Le recyclage des matériaux contribuera également à économiser les ressources naturelles.



Ce symbole n'est valable que dans l'Union Européenne. Si vous souhaitez mettre ce produit au rebut, veuillez prendre contact avec les autorités locales ou avec votre revendeur et renseignez-vous sur la méthode de mise au rebut correcte.

Italiano

- Smaltimento delle attrezzature elettriche ed elettroniche usate (applicabile in tutta la Comunità Europea ed altri Paesi Europei che applicano programmi di raccolta differenziata)

Il simbolo trovato sul prodotto, o sulla sua confezione, indica che il prodotto non può essere trattato come i domestici quando è il momento di smaltirlo. Al contrario, deve essere consegnato ad un centro di raccolta specializzato nel riciclaggio di attrezzature elettriche ed elettroniche. Assicurando che il corretto smaltimento di questo prodotto, si aiuterà a prevenire potenziali conseguenze negative sull'ambiente e sulla salute umana, che possono essere provocate da uno scorretto smaltimento di questa attrezzatura. I materiali riciclati aiuteranno a conservare le risorse naturali.



Questo simbolo è valido solo nell'Unione Europea. Per smaltire questo prodotto, mettersi in contatto con le autorità locali - o con il rivenditore - e chiedere informazioni sul corretto metodo di smaltimento.

Polski

- Usowanie zużytego sprzętu elektrycznego i elektronicznego (Dotyczy krajów Unii Europejskiej i innych krajów europejskich z oddzielnymi programami zbiórki odpadów)

Obecność tego symbolu na produkcie lub na opakowaniu z produktem oznacza, że tego produktu nie można wyrzucić razem z odpadkami domowymi. Należy go przekażać do punktu zbiórki w celu poddania recyklingowi podzespołów elektrycznych i elektronicznych. Usunięcie tego produktu w prawidłowy sposób, pomoże w zabezpieczeniu przed negatywnym wpływem odpadów na środowisko i zdrowie ludzi, powodowanym przez niewłaściwe usuwanie produktu. Przetwarzanie materiałów pomaga w zachowaniu zasobów naturalnych.



Ten symbol obowiązuje wyłącznie w krajach Unii Europejskiej. Informacje dotyczące prawidłowej metody usunięcia tego produktu, można uzyskać u władz lokalnych lub u dostawcy.

Suomi

- Vanhjojen sähkö- ja elektroniikkalaitteiden hävittäminen (Soveltuva kaikilla Euroopan unionin alueella, sekä muissa Euroopan maissa, joilla on erilliset keräysohjelmat)

Jos tuotteesta tai sen pakkauksessa on tämä symboli, sitä ei pidä hävittäässä käsitellä tavallisenä kotitalousjätteenä, vaan se kuuluu toimittaa sähkö- ja elektroniikkalaitteiden kierrätyspisteeseen. Varmistamalla, että tämä tuote hävitetään asiaankuuluvalla tavalla autat estämään mahdollisia ympäristölle ja ihmisille kotiväestön negatiivisia seuraamuksia, joita sen vääränlainen hävittäminen voi aiheuttaa. Materiaalien kierrättäminen auttaa säilyttämään luonnonvarjoja.



Tämä symboli on voimassa ainoastaan Euroopan unionin alueella. Jos haluat hävittää tämän tuotteen, ota yhteyttä paikallisiin viranomaisiin tai jälleenmyyjään ja tiedustele asiaankuuluvia hävittäistapoja.

Deutsch

- Entsorgung von elektrischen & elektronischen Altgeräten (geltend für die europäische Gemeinschaft und andere europäische Länder mit separaten Sammelprogrammen)

Dieses Symbol, zu finden auf Ihrem Produkt oder dessen Verpackung, macht Sie darauf aufmerksam, dass dieses Produkt bei der Entsorgung nicht als Hausmüll behandelt werden darf. Statt dessen sollte es an eine Sammelstelle zum Recycling von elektrischen und elektronischen Altgeräten gegeben werden. Helfen Sie mit, potenziell schädliche Einflüsse auf Umwelt und Gesundheit, die durch eine unsachgemäße Entsorgung dieses Produktes entstehen können, zu vermeiden und entsorgen Sie dieses Produkt ordnungsgemäß. Recycling hilft, natürliche Rohstoffe einzusparen.



Dieses Symbol ist nur innerhalb der europäischen Gemeinschaft gültig. Wenn Sie dieses Produkt entsorgen möchten, wenden Sie sich bitte an Ihre örtliche Behörde und fragen Sie nach der ordnungsgemäßen Entsorgungsmethode.

Nederlands

- Verwijderen van oude elektrische en elektronische apparatuur (toepasbaar in de volledige Europese Unie en andere Europese landen met afzonderlijke programma's voor afvalverzameling)

Dit symbool dat op het product of zijn verpakking is aangebracht, geeft aan dat dit product niet mag worden behandeld als huishoudelijk afval als u het wilt wegwerpen. U moet het afgeven bij een specifiek verzamelpunt voor de recycling van elektrische en elektronische apparatuur. Door te garanderen dat u dit product op de correcte manier wegwerpt, helpt u potentiële negatieve gevolgen voor het milieu en de menselijke gezondheid, die zouden kunnen worden veroorzaakt door een onrechtmatig wegwerpen van het product, te voorkomen. De recycling van materialen helpt het behoud van natuurlijke bronnen.



Dit symbool is alleen geldig in de Europese Unie. Als u dit product wenst weg te gooien, dient u contact op te nemen met uw lokale instanties voor details over de gepaste methode voor afvalverwijdering.

Waste Electrical and Electronic Equipment (WEEE) Directive In the European Union, this label indicates that this product should not be disposed of with household waste. It should be deposited at an appropriate facility to enable recovery and recycling. EEE complies with Directive 'Regulation on the Restriction of the Use of Certain Hazardous Substances in Electrical and Electronic Equipment'

Waste Electrical and Electronic Equipment (WEEE) Directive In the European Union, this label indicates that this product should not be disposed of with household waste. It should be deposited at an appropriate facility to enable recovery and recycling. EEE complies with Directive 'Regulation on the Restriction of the Use of Certain Hazardous Substances in Electrical and Electronic Equipment'

Waste Electrical and Electronic Equipment (WEEE) Yönergeleri Avrupa Birliği'nde bu etiket, ürünün ev elektroniği aletleri atıkları ile imha edilemeyeceğini gösterir. Kurtarmak ve geri dönüşümünü sağlamak için uygun şartlarda saklanması gerekir. EEE Yönetmeliğine Uygun Durum Ve Elektronik Eşyalarda Bazı Zararlı Maddelerin Kullanımının Sinirlendirilmesine Dair Yönetmelik.

Waste Electrical and Electronic Equipment (WEEE) Yönergeleri Avrupa Birliği'nde bu etiket, ürünün ev elektroniği aletleri atıkları ile imha edilemeyeceğini gösterir. Kurtarmak ve geri dönüşümünü sağlamak için uygun şartlarda saklanması gerekir. EEE Yönetmeliğine Uygun Durum Ve Elektronik Eşyalarda Bazı Zararlı Maddelerin Kullanımının Sinirlendirilmesine Dair Yönetmelik.

Normal Usage Guidelines

Normal use of the LCD is defined as operating in the open air to prevent heat buildup, and without direct or indirect heat sources such as lighting fixtures, heating ducts, or direct sunlight that can cause the modules to experience high operating temperatures. For all modules, do not block fans or ventilation openings. If the LCD module will be installed in a recessed area with an LCD surround or enclosure, ensure adequate openings are applied for proper air flow and ventilation.

At 2000 meters or below, the maximum ambient operating temperature for the LCD module cannot be above 40° C nor below the minimum ambient operating temperature of 5° C. If one of these conditions exists, it is up to the installer to ensure that module placement is changed, thermal shielding is provided and/or additional ventilation is provided to keep the display within its nominal operating parameters.

Cooling Requirements

For optimal performance, active cooling by the installer should be planned for when the ambient temperature at the top of the wall is predicted to be above the specified ambient temperature for the panel. Cooling may be done behind the displays and depending on the wall configuration, it may be helpful to place air ducts (AC) at every third display tall.

VESA Mounts, General Description

VESA mounts are used to secure the PS4660T/PS5560T for display. The PS4660T/PS5560T can be installed using a variety of VESA mounts available through Planar. If you do not have a VESA mount and would like to purchase one, contact Planar.

If you purchased a VESA mount, you should have received a separate box with mounting supplies and an Installation manual. Follow these instructions carefully.

Keep in mind the following general installation guidelines:

- Screw length is crucial and will vary depending on the type of mount you use. Total screw length will include the penetration length plus the length required by the type of VESA mount in use.

Caution: Shorter screws will result in insufficient mounting strength and longer screws could puncture parts inside the display.

- Prior to installation, make sure you know where all of the mounting points are located.
- Follow all safety precautions outlined in the VESA Installation manual.
- Verify the parts received with the list shown in the VESA Installation manual.

Cleaning the PS4660T/PS5560T

If dust has collected on the power plug, removed the plug from the outlet and clean off the dust. Dust build-up may cause a fire.

Remove the power plug before cleaning. Failure to do so may result in electrical shock or damage.

Keep the following points in mind when cleaning the surface of the display:

- When the surface becomes dirty, wipe the surface lightly with a soft clean cloth.
- If the surface requires additional cleaning, use LCD screen cleaner or LCD wipes, which are available at most electronics stores.
- Do not let cleaner seep into the display, as it may cause electrical shock or damage.

Ambient Light Recommendations

Due to the optical nature of touch screens, installations close to windows and/or glass doors are not recommended. Doing so may reduce touch reliability due to direct and/or indirect sunlight interference.

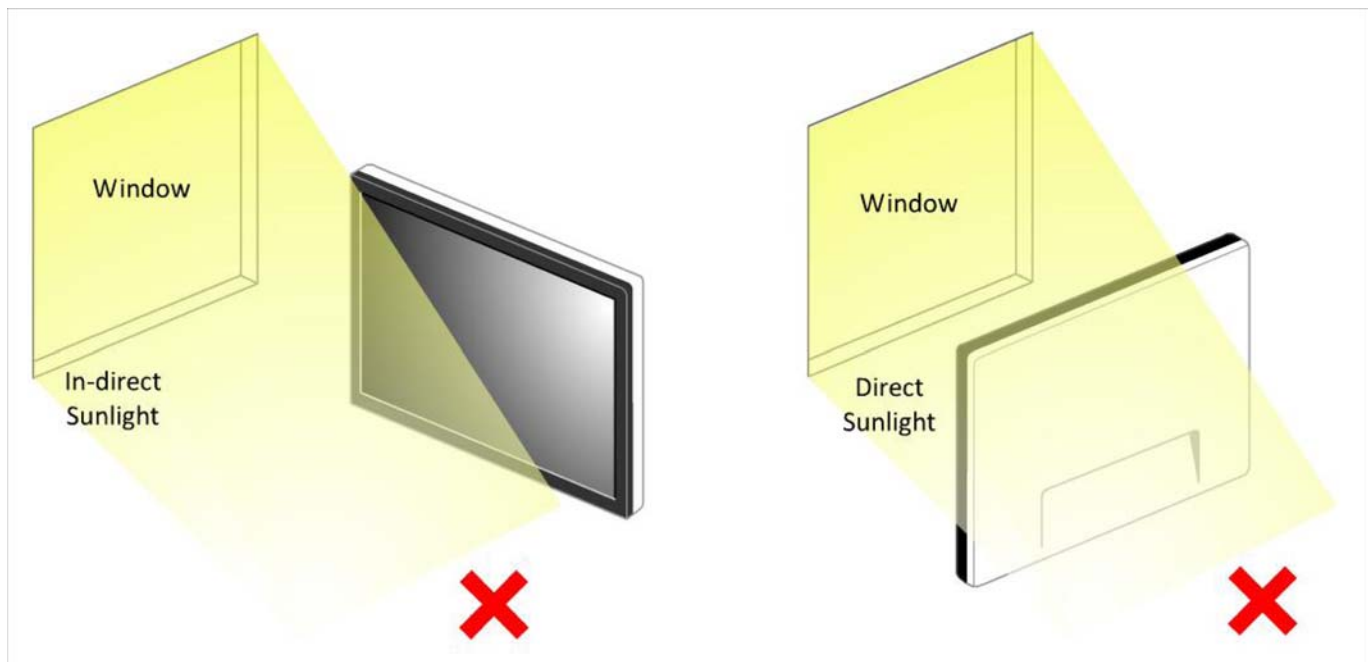

Note: Avoid installation close to windows. Direct and indirect sunlight may affect touch performance.

Package Contents

Unpacking the PS4660T/PS5560T

The PS4660T/PS5560T is packed in a cardboard box and may be banded as part of two types of custom pallets, depending on the number of displays shipped. The PS4660T/PS5560T is packed using foam to protect it during shipping.

Before unpacking the display, prepare a stable, level and clean surface near a wall outlet.

Place the LCD panel box in an upright position and open it from the top of the box before removing the top shipping foam.





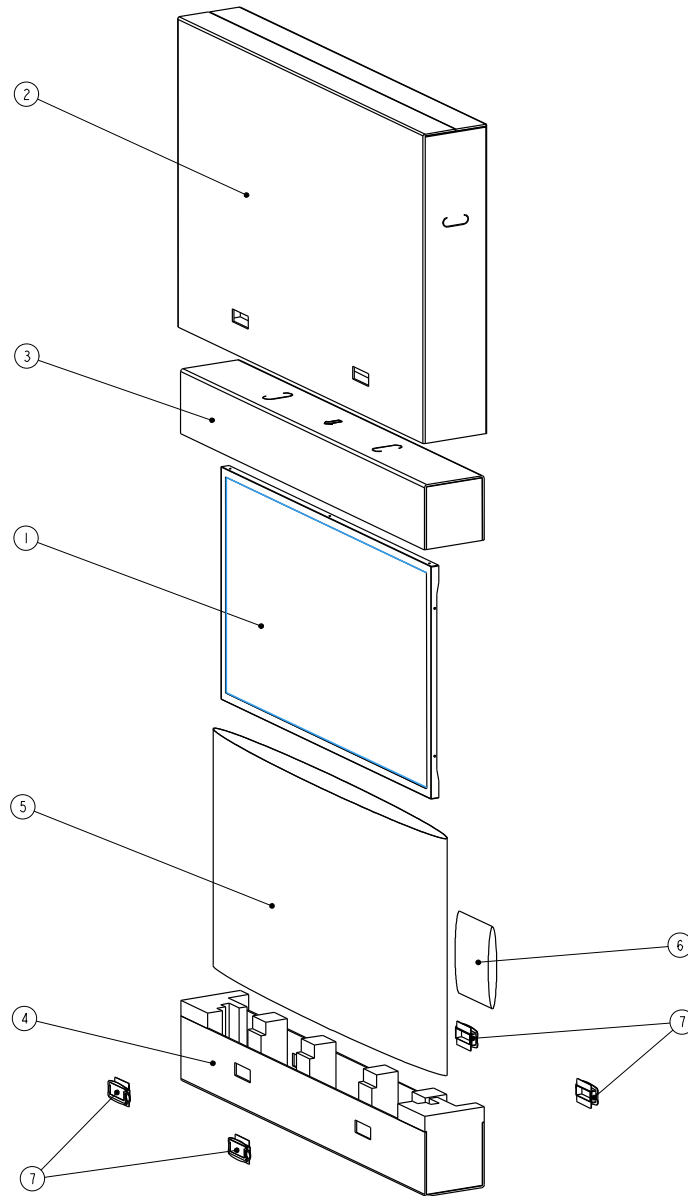

- 1** Remove the white handle and cut the banding.

2 Remove the top shipping foam, accessory bag and packing list.



Item	Description	Quantity
1	LCD panel	1
2	Carton	1
3	Foam Cushion Top	1
4	Foam Cushion Bottom	1
5	Polyurethane Bag	1
6	Accessory Bag	1
7	Carton Lock	4

Contents of the Accessory Kit

Part	Picture	Quantity
VGA Cable (D-sub)		1
USB Drive		1
Power cord		1
IR extender cable		1
OSD Remote (AAA batteries included)		1
USB cable		1

Dimensions

PS4660T - Front and Side

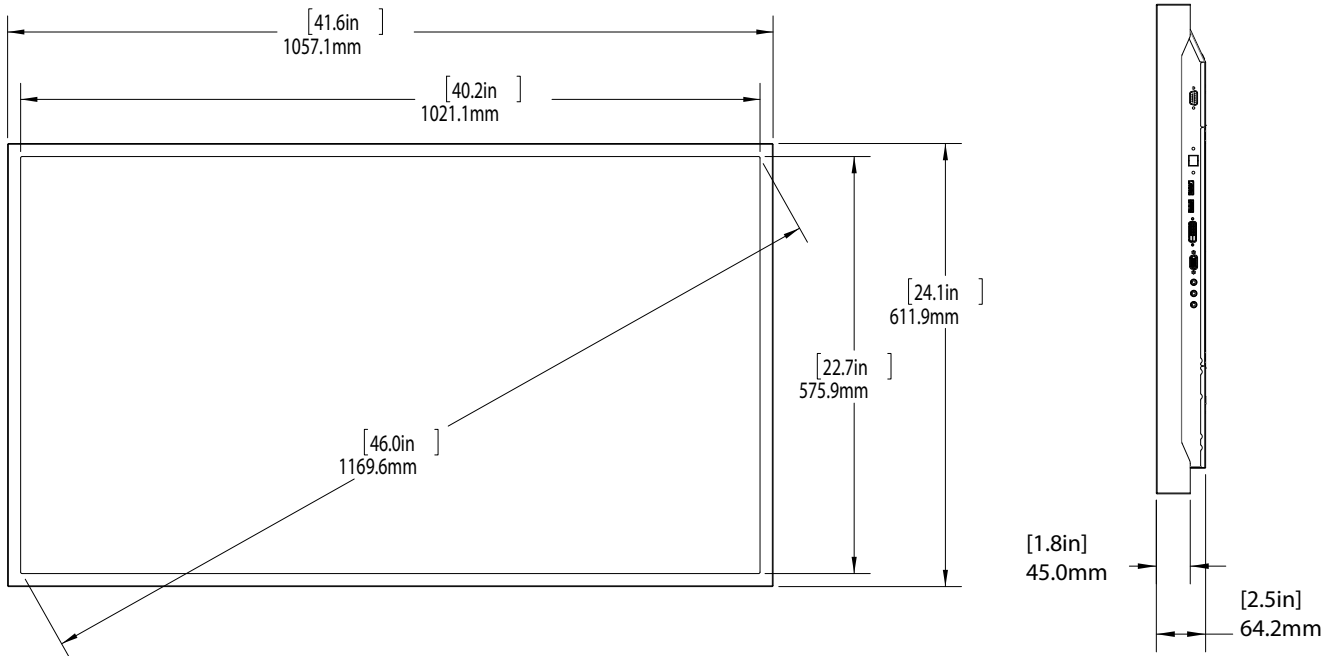

PS4660T - Rear

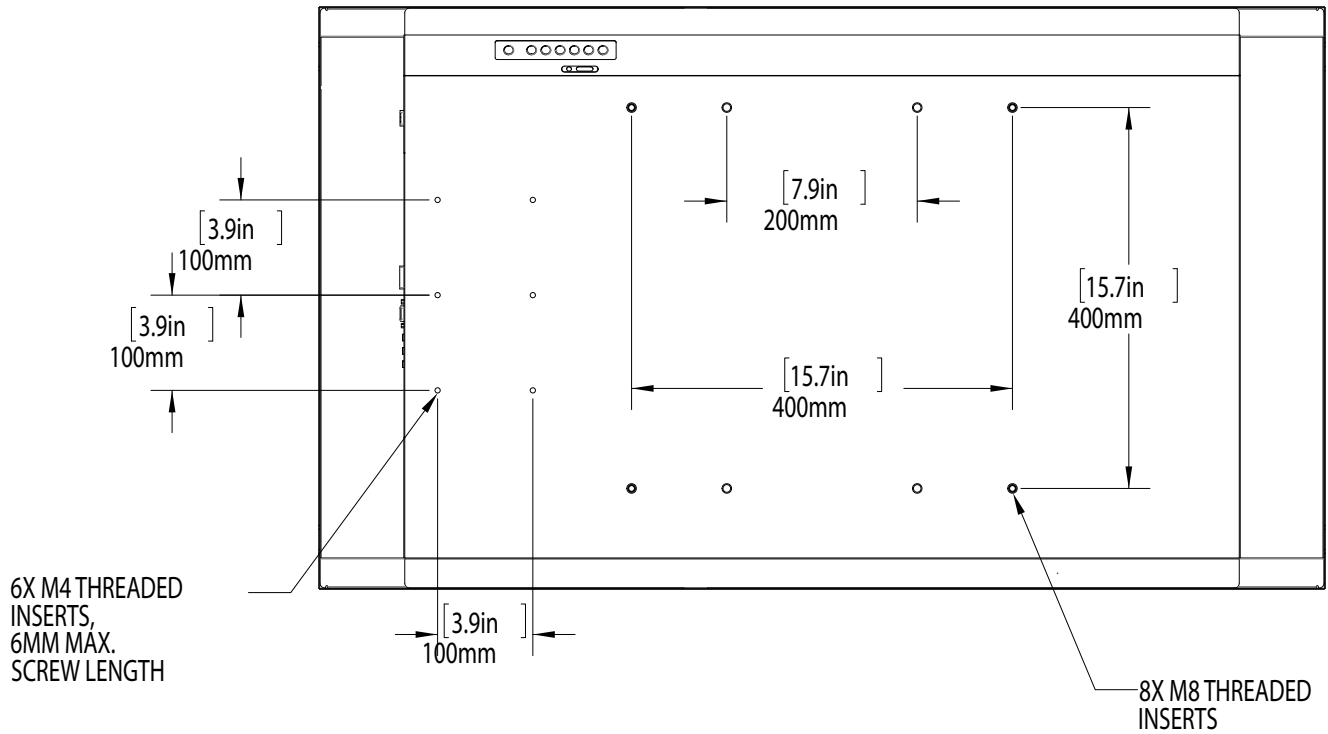

PS5560T - Front and Side

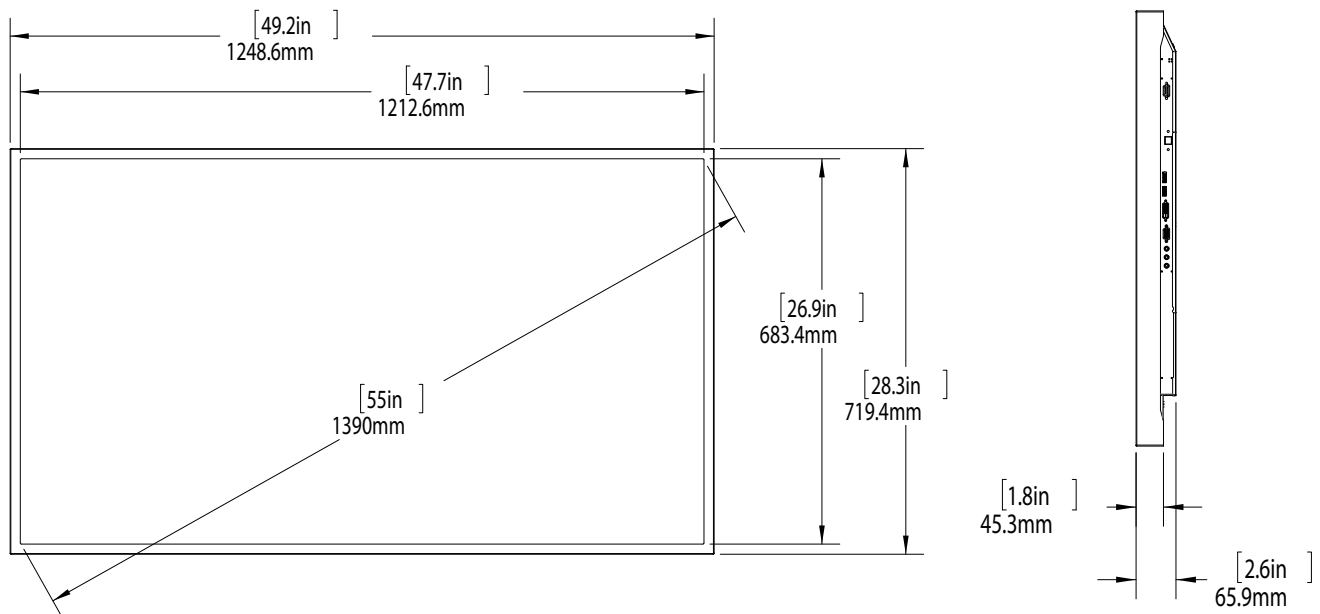

PS5560T - Rear

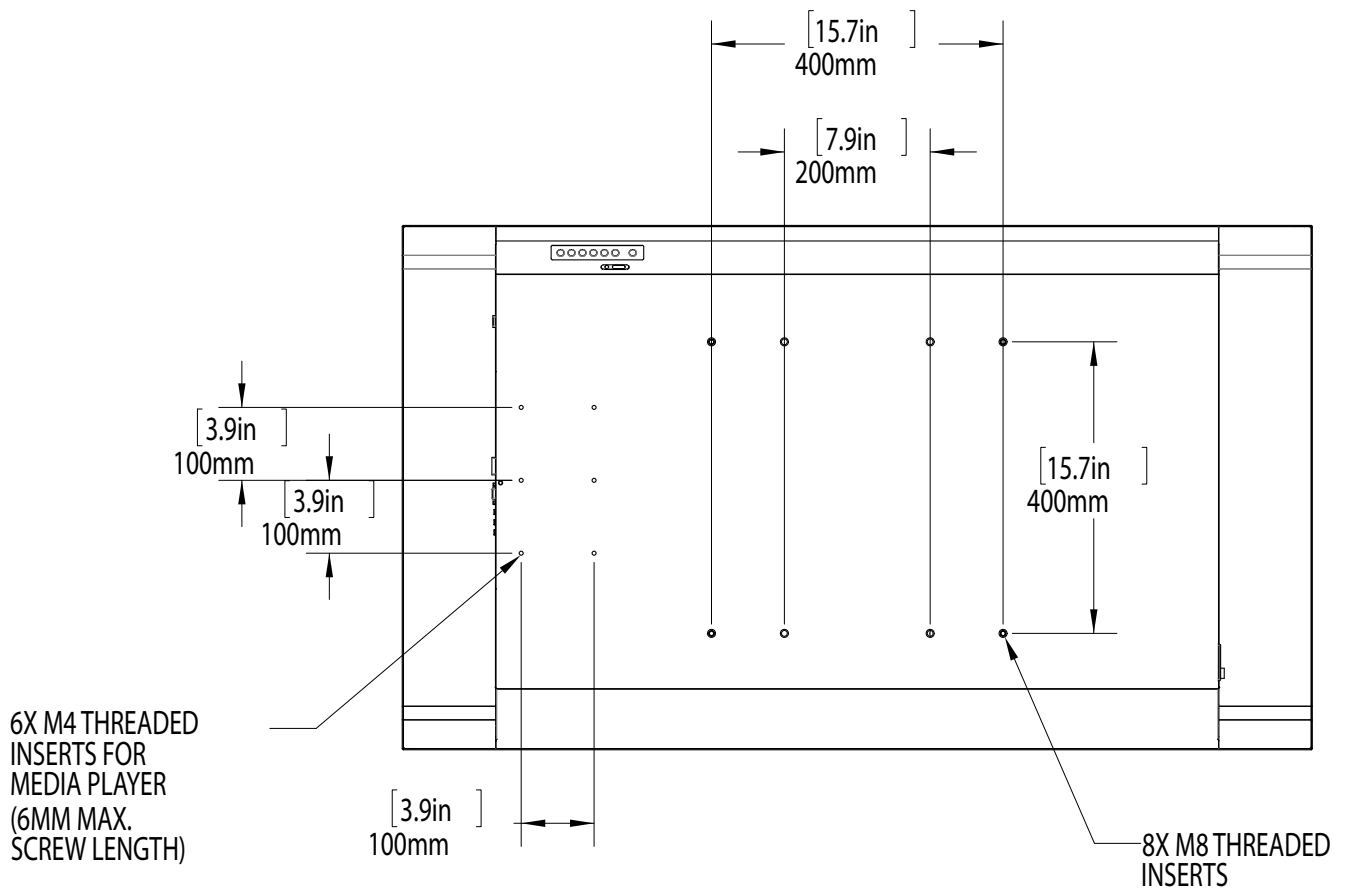

Installing a PS4660T/PS5560T

This section explains how to install an PS4660T/PS5560T. We suggest that you read the entire section before you attempt to install the unit.

Before You Begin

Make sure you have all the items in these lists before you begin unpacking and installing your displays.

Tools/Equipment List

Depending on your installation, you may need one or more of the following items:

- String/string level
- Digital/laser level
- Ladders/lift
- Back brace
- Stud finder (if hanging display on a wall)

Other Things You May Need

- LCD screen cleaner or LCD wipes - available at most electronics stores
- At least two very strong people to help lift units into place

Plan Your Installation

You should have a detailed plan of how the units are to be configured. The plan should include calculations for the following:

- Power (maximum of five units per 20A circuit for 115V operation)
- Cable runs
- Ventilation and cooling requirements
- If hanging display on a wall, location of studs in the wall

Prepare Your Installation Location

You should have prepared the area where you will install the unit. If custom enclosures are part of the installation, they must be fully designed to accommodate the installation of the displays, as well as the installed unit and ventilation and cooling requirements.

If your installation included a lot of construction or dust, it is **highly recommended** that you clean all of the screens and vents after the wall installation and configuration are complete.

Connectivity

Source inputs are located on the rear of the display.

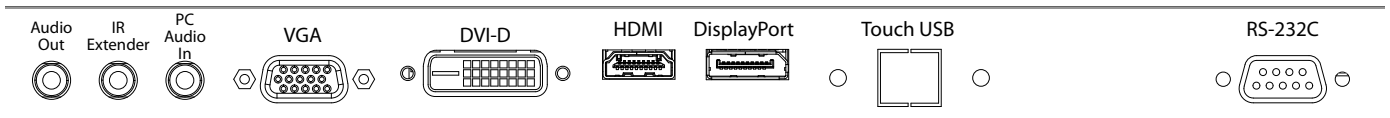

	Name	Connector
	Audio Out	Mini jack
	IR Extender	Mini jack
	PC Audio In	Mini jack
	VGA (PC) input1	D-Sub 15-pin
	DVI-D input	D-Sub 24-pin
	HDMI input	HDMI
	DisplayPort	DisplayPort
	Touch USB	USB type B
	RS-232C	D-Sub 9-pin

Operating the PS4660T/PS5560T

OSD Keypad

The OSD keypad is located on the rear of the display.

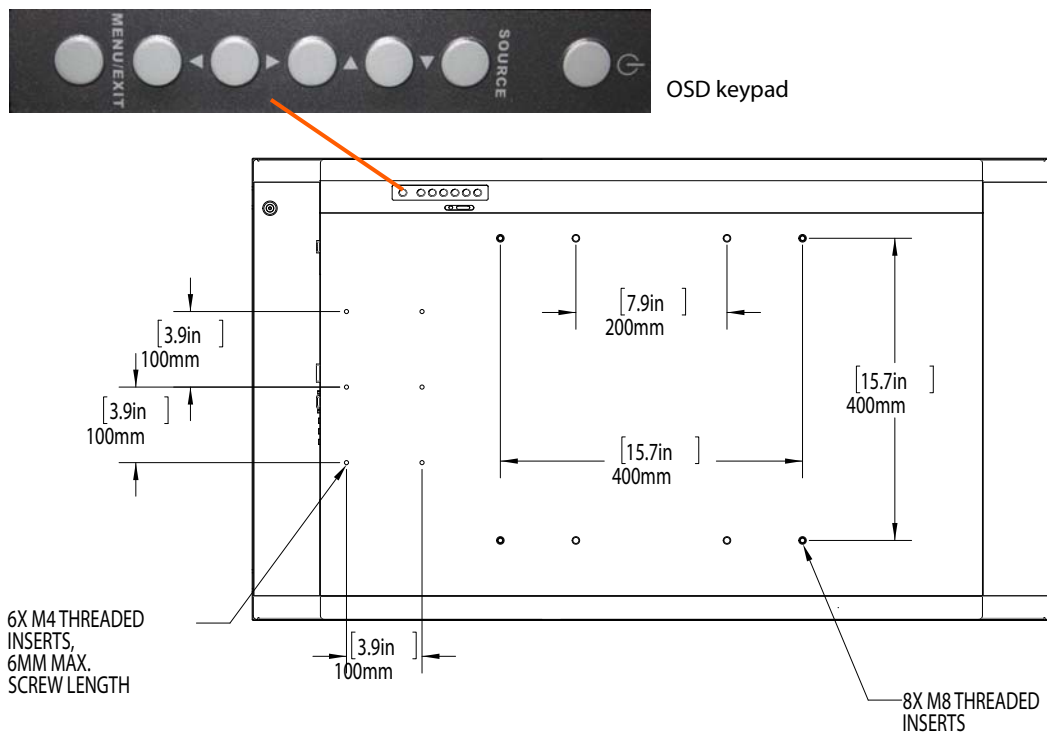

OSD Keypad Buttons

Key	Descriptions
Power	Power on/Power off
Source	Source selection (toggle)
▶	Menu Right/Increase value
◀	Menu Left/Decrease value
▲	Menu Up
▼	Menu Down
Menu/Exit	Menu/Exit

Remote Control Receiver

The remote control receiver is located near the keypad on the rear of the display. Use the IR extender cable for operating the remote from the front of the display.

Power ON standby
indicator

Remote control receiver

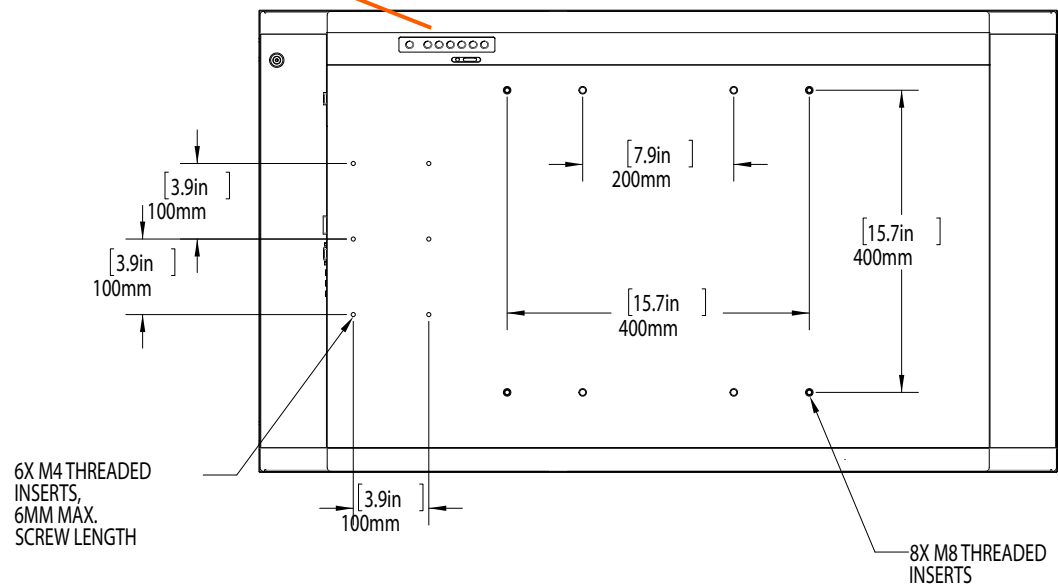

LED Indicators

The LED indicator light is located on the rear of the display near the keypad. The following table explains what the different colors and blink patterns mean.

LED On

Power Status	Condition
Green	Power on
Blinking Orange	No signal
Orange	Power saving mode
Off	AC off
	Power off

Using the Display in Portrait Mode



When using the display in the portrait position and looking at the rear of the display, it should be rotated according to the arrow stickers on the back of the display. This will allow for proper ventilation. Then select the OSD rotation of landscape or portrait on the OSD menu (MAIN MENU > BASIC > OSD ROTATION).

Caution: Improper ventilation may shorten the life of the display.

Using the Remote Control

See the following page for descriptions all of the buttons on the remote control.



Num	Function	Description
1		Turns the display on and off
2	INFO	Provides source and resolution information
3	VGA	Selects the PC's RGB source
	DVI	Selects the PC's DVI source
	HDMI 1	Selects the HDMI source
4	COMP	Not available
	AV (VIDEO)	Not available
	HDMI 2	Not available
5	PIP position	Not available
	Display port	Selects the display port source
	HD-SDI 1	Not available
6	PIP	Not available
	S-V	Not available
	HD-SDI 2	Not available
7	SWAP	Not available
8	P-SOURCE	Not available
9	MENU	Opens the on-screen menu system. When the menu system is already open, pressing this button will select the previous submenu.
		Navigates through submenus and settings
10	EXIT	Closes the menu system
11	ENTER	Selects highlighted menu choices
12	SCALING	Toggles between different aspect ratios (Auto, Fullscreen and PillarBox)
	FREEZE	Not available
	MUTE	Turns off the sound
	BRIGHT	Adjusts the brightness
	CONTRAST	Adjusts the contrast

Num	Function	Description
12 cont.	AUTO	Synchronizes the display to the source
	SOURCE	Allows selection of the different sources
	VOLUME -	Decreases the sound volume
	VOLUME +	Increases the sound volume

Locking/Unlocking the OSD Menus

You can lock or unlock the OSD menus by pressing a series of key commands on the remote control. To **lock** the menu, press the following keys on the remote in the order listed: ENTER, ENTER, EXIT, EXIT, ENTER and EXIT. To **unlock** it, simply follow the same sequence.

Depending on whether you locked or unlocked the menu, you will see one of the following messages on the screen.

Key Unlocked

Key Locked

Changing the Remote Control Battery

- 1 Remove the battery cover.**
Slide back and remove the battery cover in the direction of the arrow.

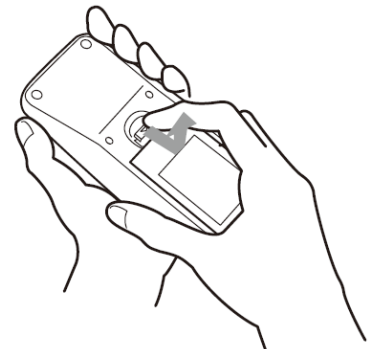

- 2 Insert the batteries.**
Align and insert two AAA batteries according to their plus and minus ports (as indicated in the remote control).

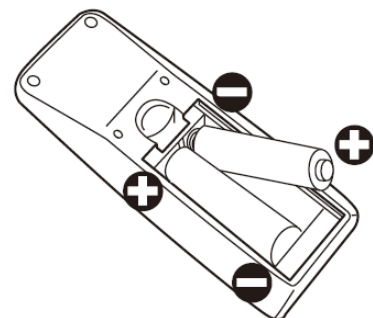

3 Close the battery cover.

Replace the battery cover in the direction of the arrow and snap it back into place.

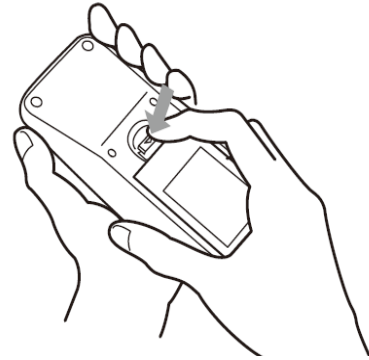

Using the Touch Screen



You can use the optical touch screen to control your operating system. The touch screen can emulate basic mouse functions and supports multi-touch functions for Windows 7*. The following table shows a list of functions you can use on the touch screen.

Note: *Ensure that you have installed the USB cable on the display to a computer.

Performing Basic Functions

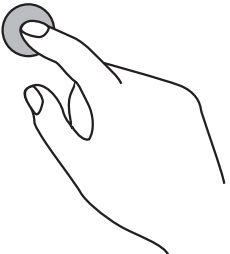
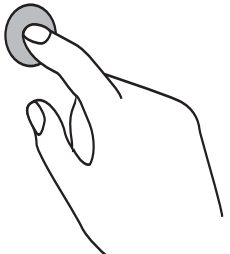
The following table shows how to perform basic tasks using the touch screen for Windows 7, Vista, XP, Mac OSX and Linux.

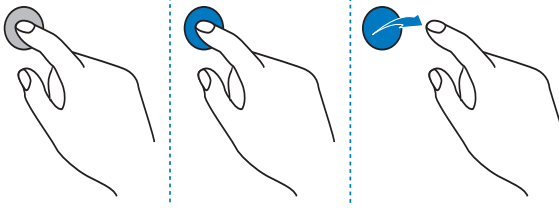
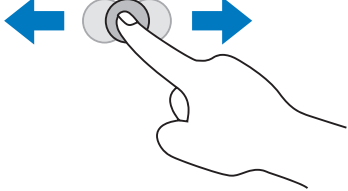
Function	Action	
Click	Tap the screen once.	
Double-click	Tap the screen twice.	

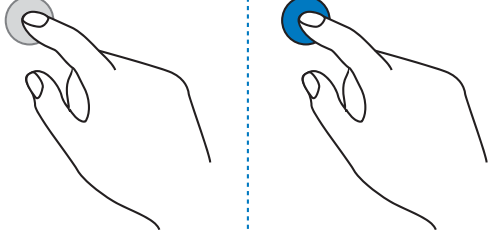
Right-click	Press on the target. Hold and wait for a blue ring to appear. Release your finger.	
Drag or select	Drag one finger left or right.	
Pan up/down/back /forward	Quickly drag your finger (flick) in a desired direction.	
Wake up from Windows sleep mode (S3)	Press and hold for four seconds.	

Multi-Touch Functions

The following table shows how to perform multi-touch tasks using the touch screen for Windows 7 - Home Premium, Professional, Enterprise and Ultimate versions.

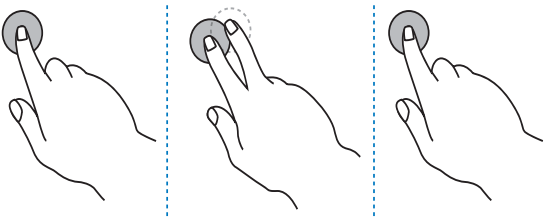
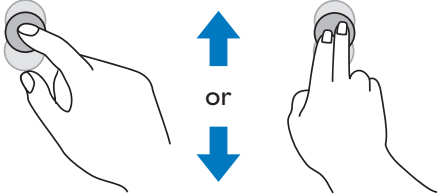
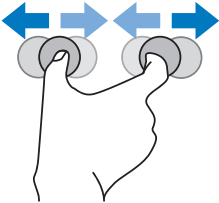
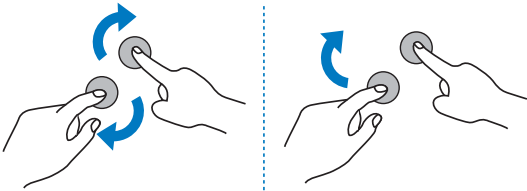
Function	Action	
Right-click	Press on the target. Tap the screen with another finger. Release the second finger.	
Scrolling	Drag one or two fingers up or down.	
Zoom	Move two fingers apart or toward each other.	
Rotate	<ul style="list-style-type: none"> • Move two fingers in opposing directions. • Use one finger to pivot around the other. 	

Turning the PS4660T/PS5560T On

- 1 Insert the power cord into the display and the power outlet.
- 2 Ensure the AC switch is set to “—”.
- 3 Press the power button on the remote or side control panel.

Turning the PS4660T/PS5560T Off

With the power on, press the power button on the remote or side control panel to put the LCD panel in a standby mode. To turn off power completely, turn the AC switch to “O” or disconnect the AC power cord from the power outlet.

Note: If there is no signal for a certain period of time, the LCD panel will automatically go into standby mode.

Adjusting the Volume

- 1 Using the remote, press the VOLUME - or VOLUME + to increase or decrease the volume.
- 2 Press the MUTE button to temporarily turn off all sound. To restore the sound, press the MUTE button again.

Selecting the Input Source

- 1 Do one of the following:
 - Using the remote, press the desired source button (VGA, HDMI, DVI or DISPLAYPORT).
 - Press the source button on the PS4660T/PS5560T’s keypad. Use the arrow buttons (▲ ▼) to select one of the following input sources and press ENTER: VGA, HDMI, DVI or DISPLAYPORT.

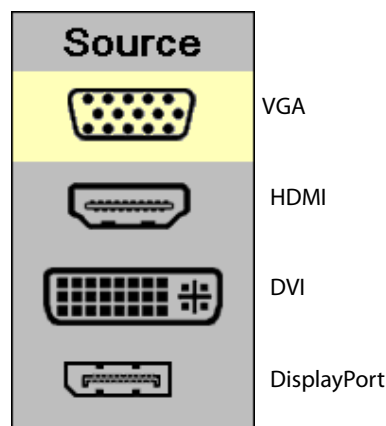

OSD Menu Functions

There are two menu modes: Graphics (DVI and VGA) and Video (HDMI and DisplayPort). Any differences are noted in the table.

Main Menu	Field	Submenu	Description	Setting
Video	Scheme		In Video mode, select the scheme Note: Disabled in Graphics mode	User, Vivid, Cinema, Game, Sport
	Brightness		Adjust the brightness of the screen	0~100
	Contrast		Adjust the contrast of the screen	0~100
	Sharpness		Adjust the sharpness of the screen	0~8
	Saturation		Adjust the saturation of the screen Note: Disabled in Graphics mode	0~100
	Hue		Adjust the hue of the screen Note: Disabled in Graphics mode	0~100
	Backlight		Adjust the backlight	0~100
	Color Temperature & Gamma		Select the gamma (which compensates for the human eye's perception of an image) and color temperature for this display.	
		Gamma	Select the gamma setting or turn it off.	2.2, Off
		Color Temperature	Select the color temperature (in Kelvin) for which you want the display to operate. Selecting user applies default color settings.	5000K, 6500K, 7500K, 9300K, User
		Red Gain	Select the Red Gain	128~383
		Green Gain	Select the Green Gain	128~383
		Blue Gain	Select the Blue Gain	128~383
		Red Offset	Select the Red Offset	-50~50
		Green Offset	Select the Green Offset	-50~50
		Blue Offset	Select the Blue Offset	-50~50
	Aspect Ratio		Adjust the aspect ratio of the screen	Full screen, Pillar Box, Auto
	Auto Scan		Select the Auto scan function	Off, On
	Select Source		Select the main input source	VGA, HDMI, DisplayPort or DVI
Audio	Volume		Adjust the volume	0~100
	Bass		Adjust the Bass volume	-6~6
	Treble		Adjust the Treble volume	-6~6
	Balance		Adjust the balance of the screen	-6~6
	HDMI Audio Input		Audio input control	HDMI/PC

Main Menu	Field	Submenu	Description	Setting
	DP Audio Input		Audio input control	DisplayPort/PC
	Internal Speakers			Off, On
Basic	OSD Transparent		Adjust the OSD transparent function	0~12
	OSD Location		Adjust the OSD location	►, ◄, ▲, ▼
	OSD Rotation		Adjust the OSD rotation	Landscape/Portrait
	OSD Language		Select the OSD language	English/ Chinese
	OSD Timeout		Select the OSD timeout seconds	5~120 sec.
	Power LED		LED on rear of display shows powered on/off or standby mode	Off, On
	Real Time Clock (RTC)		Set up Date & Time	
		Current Time	Change the current time	
		Timer Mode	Setup schedule	User, Work Days, All Days
Advanced	Auto Adjustment		Select the Auto adjustment function	Off, On
	Image Position		► -50~50 ◄ -50~50 ▲ according to resolution ▼ according to resolution	
	Phase		0~63	According to resolution
	Clock		0~100	According to resolution
	IRFM		Select the anti burn-in mode function	Off, On
	Baud Rate		Setting the baud rate of the display	115200, 38400, 19200, 9600
	Smart Light Control		Select one of the Backlight control functions: <i>DCR (Dynamic contrast)</i> – from the input source <i>Light Sensor</i> – from ambient light	Off, DCR, Light Sensor
	Wake Up From Sleep		Energy-saving function	Never Sleep VGA Only VGA, Digital, RS-232
	Factory Reset		Reset to the factory default setting	Yes, No
System	Channel Information	Source	Show the name of the input source	
	Resolution		Show the current resolution	
	Firmware Version		Show the firmware of the display	

OSD Menus

Video Menus

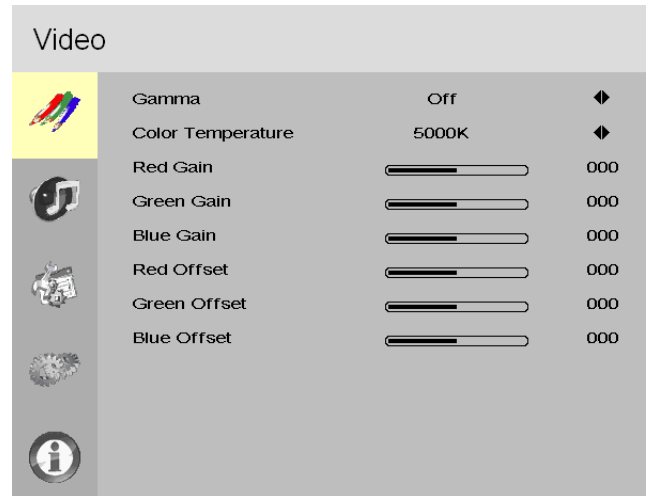
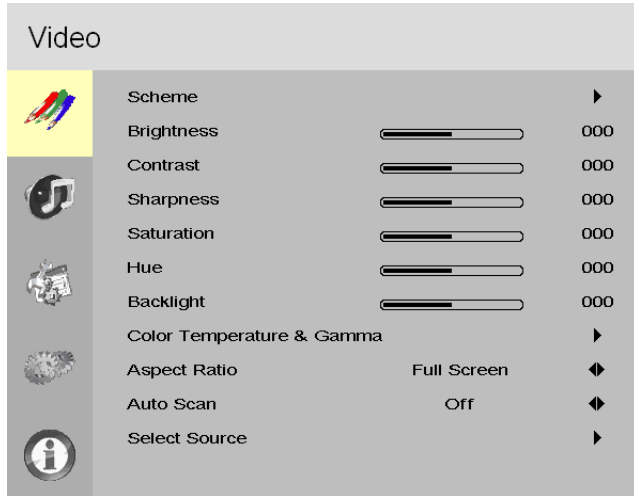

Audio Menu

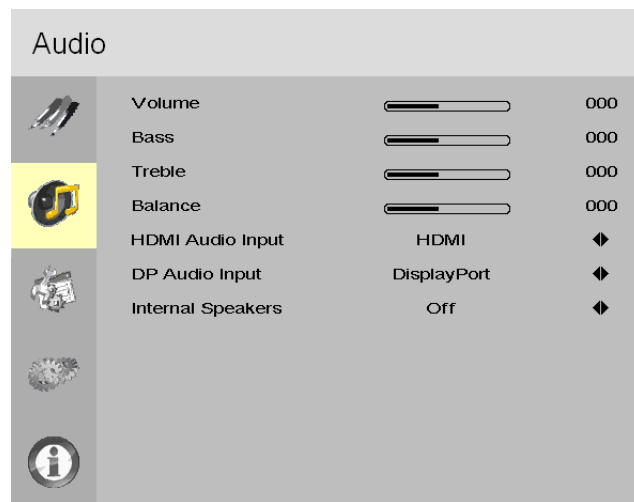

Basic Menus

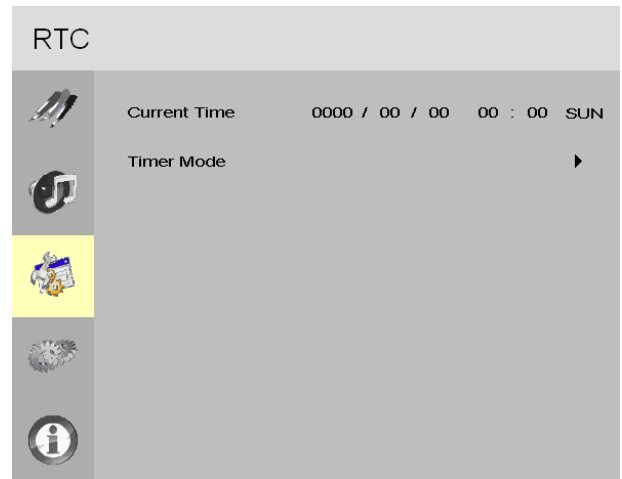
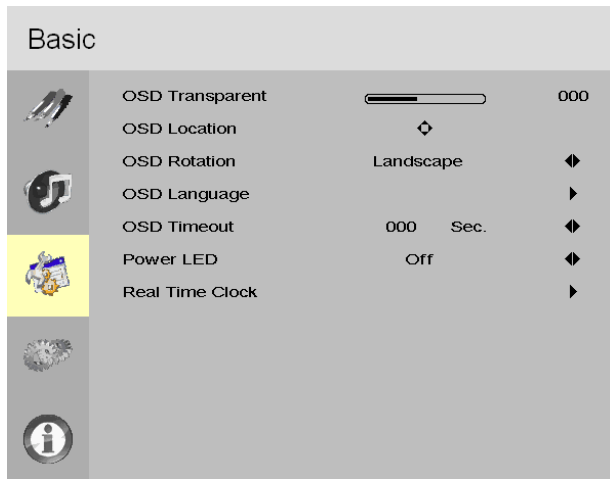

RTC Submenus

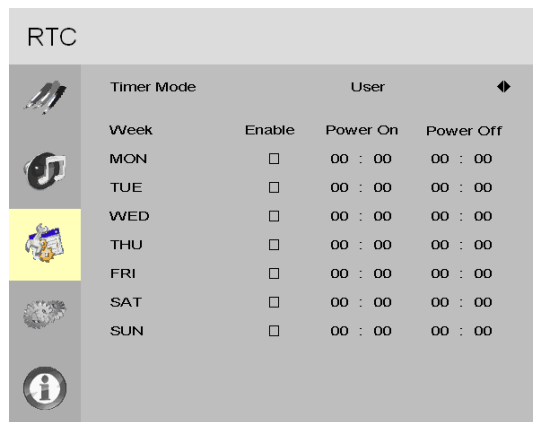

User Mode

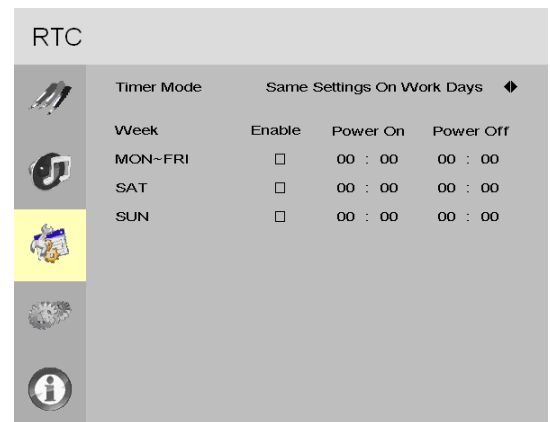

Same Settings On Work Days Mode

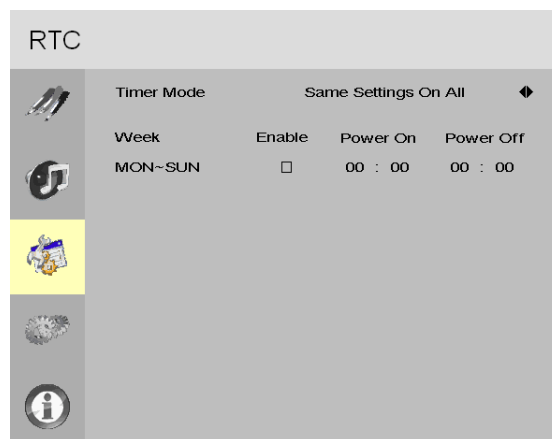

Same Settings On All Mode

Advanced Menu

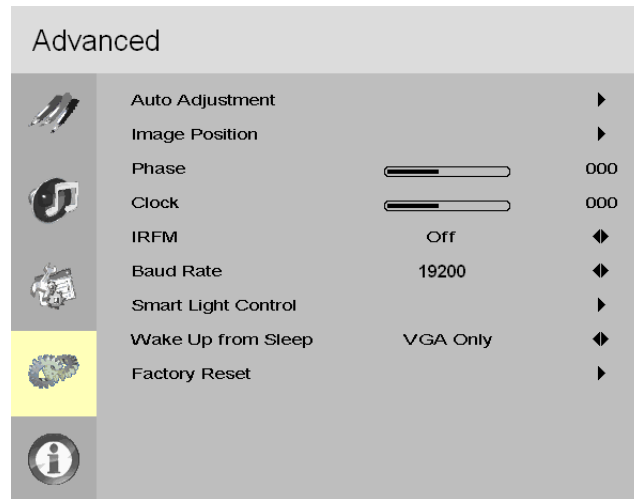

System Menu

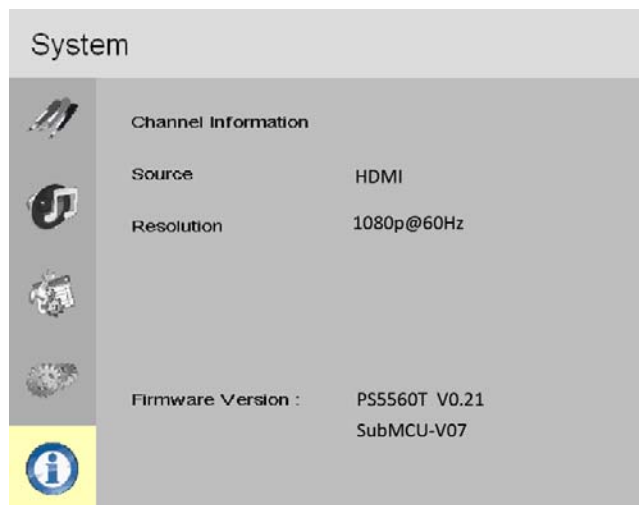

Navigating Through the Menu

- 1 With the power on, press MENU. The VIDEO menu appears.
- 2 Within the menu, use ▲, ▼, ◀, ▶ and ENTER to navigate through the menus and adjust options.
- 3 Press MENU to return to the previous menu. To exit the menu system, press EXIT.

Video Menu

This menu is used for making common image adjustments.

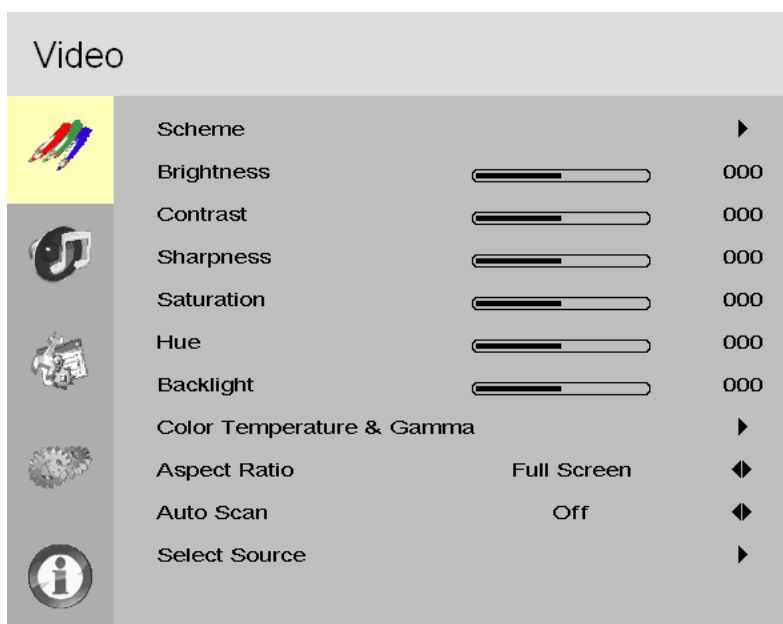

Scheme	<p>Press ◀ or ▶ to select one of the following: Options: User, Vivid, Cinema, Game, Sport Default: User</p>
Brightness	<p>Increases or decreases the brightness of the picture. Press ◀ or ▶, select the desired level, and press ENTER. Range: 0~100; Default: 50</p>
Contrast	<p>Increases or decreases the contrast of the picture. Press ◀ or ▶, select the desired level, and press ENTER. Range: 0~100; Default: 50</p>

Sharpness	Adjusts the definition of the picture. Press ◀ or ▶, select the desired level, and press ENTER. Range: 0~8; Default: 6
Saturation	Adjusts the brilliance and brightness (Video Mode only). Press ◀ or ▶, select the desired level, and press ENTER. Range: 0~100; Default: 50
Hue	Increases or decreases the green hue (Video Mode only). Press ◀ or ▶, select the desired level, and press ENTER. Range: 0~100; Default: 50
Backlight	Range: 0~100; Default: 80
Color Temp & Gamma	Adjusts red, green, blue gain and red, green blue offsets.

Color Temperature & Gamma Menu

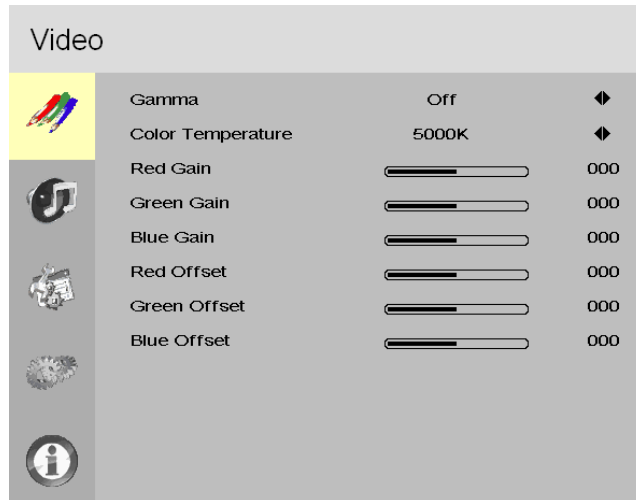

Gamma	Options: Off, 2.2 Default: 2.2
Color Temperature	Options: User, 5000K, 6500K, 7500K and 9300K. Default: 9300K

Red Gain	Set Color Temperature to "User Mode" to adjust this setting. Range: 128~383 Default: 256
Green Gain	Set Color Temperature to "User Mode" to adjust this setting. Range: 128~383 Default: 256
Blue Gain	Set Color Temperature to "User Mode" to adjust this setting. Range: 128~383 Default: 256
Red Offset	Set Color Temperature to "User Mode" to adjust this setting. Range: -50~50 Default: 0
Green Offset	Set Color Temperature to "User Mode" to adjust this setting. Range: -50~50 Default: 0
Blue Offset	Set Color Temperature to "User Mode" to adjust this setting. Range: -50~50 Default: 0

Audio Menu

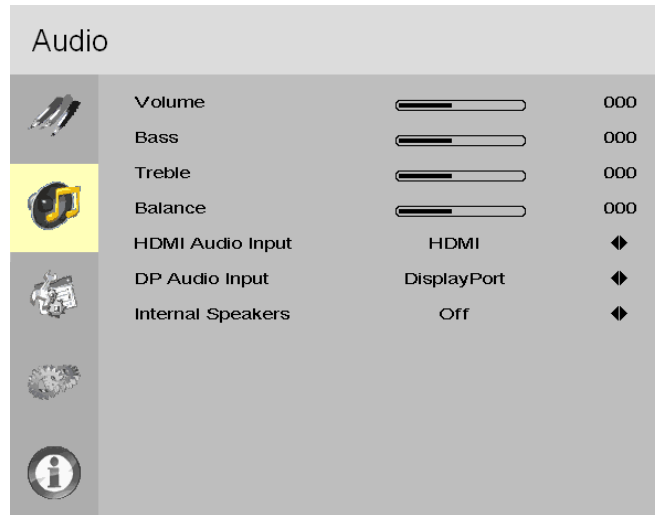

Volume	Adjust the sound. Press ◀ or ▶, select the desired level, and press ENTER. Range: 0~100 Default: 50
Bass	Adjust the low tones (bass). Press ◀ or ▶, select the desired level, and press ENTER. Range: -6~6
Treble	Adjust the high tones (treble). Press ◀ or ▶, select the desired level, and press ENTER. Range: -6~6
Balance	Adjust the balance of the left and right speakers. Press ◀ or ▶, select the desired level, and press ENTER. Range: -6~6
HDMI Audio Input	Select HDMI or PC audio input mode. Default: HDMI
DP Audio Input	Select DisplayPort or PC audio input mode. Default: DisplayPort

Internal Speakers

Disable or enable internal audio speakers.

Default: Off

Basic Menu

This menu is used to make initial setup adjustments to the OSD (On-Screen Display) menu and other on-screen messages.

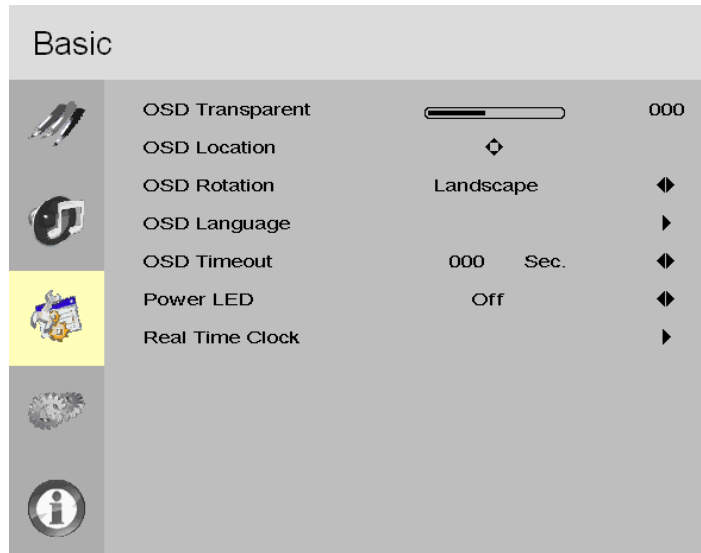
**OSD Transparent**

Set the menu transparency. Press ◀ or ▶ to select the desired level, and press ENTER.

Range: 0~12

Default: 0

OSD Location

Adjust the menu location (Up, Down, Left, Right).

OSD Rotation

Select the OSD Rotation. Press ◀ or ▶ to select the rotation.

Options: Landscape or Portrait

Default: Landscape

OSD Language

Options: English and Chinese

Default: English





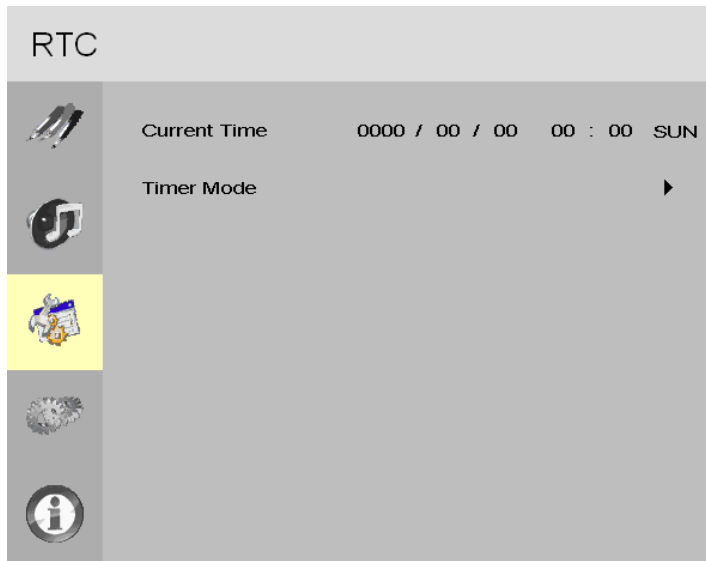

OSD Timeout	
	Options: 5~120 Default: 30
Power LED	
	Options: Off, On
Real Time Clock	
	Options: Current Time, Timer Mode

Basic Menu/RTC (Real Time Clock) Menu



Real Time	
	Current time setting Year/Month/Date, Hour: Minutes
Timer Mode	
	Timer mode selection Power on and Power off timer setup

RTC Timer Mode - User

RTC				
Timer Mode	Week	Enable	Power On	Power Off
	MON	<input type="checkbox"/>	00 : 00	00 : 00
	TUE	<input type="checkbox"/>	00 : 00	00 : 00
	WED	<input type="checkbox"/>	00 : 00	00 : 00
	THU	<input type="checkbox"/>	00 : 00	00 : 00
	FRI	<input type="checkbox"/>	00 : 00	00 : 00
	SAT	<input type="checkbox"/>	00 : 00	00 : 00
	SUN	<input type="checkbox"/>	00 : 00	00 : 00

Timer Mode	
User mode	<p>Select the power on/off timer and specify the on/off times for each day of the week.</p> <p>For each day of the week, you have the following options: Enable or Disable the schedule of the day Options: Disable, Enable Default: Disable</p> <p>Power On/Power Off timer setup. Power On: Use the arrow keys to specify the time you want the display to turn on for the selected day. Power Off: Use the arrow keys to specify the time you want the display to turn off for the selected day.</p>

RTC Timer Mode - Work Days

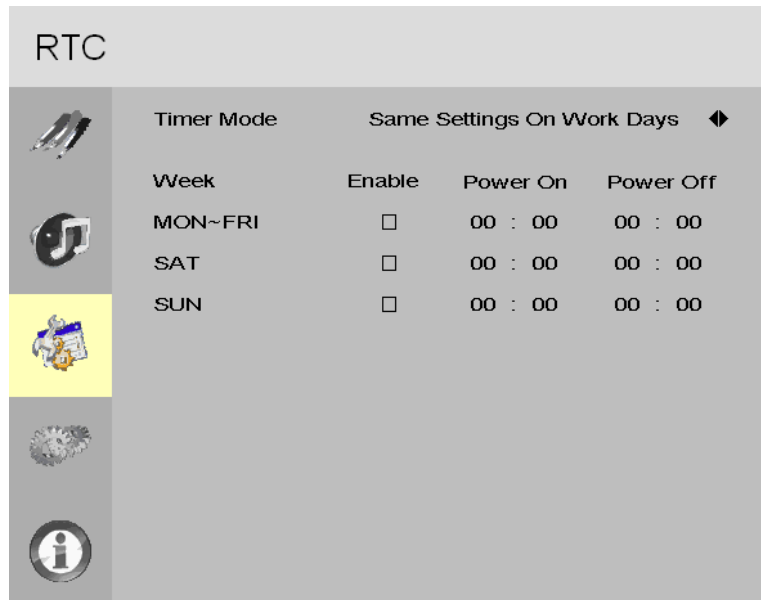

Timer Mode	
Work Days mode	<p>For Monday-Friday, Saturday or Sunday, you have the following options: Enable or Disable the schedule of the work days or individual weekend days. Options: Disable, Enable Default: Disable</p> <p>For all days, you have the following options: Enable or Disable the schedule for Monday-Friday, Saturday and Sunday. Options: Disable, Enable Default: Disable</p> <p>Power On/Power Off timer setup. Power On: Use the arrow keys to specify the time you want the display to turn on for Monday-Friday, Saturday or Sunday. Power Off: Use the arrow keys to specify the time you want the display to turn off for Monday-Friday, Saturday or Sunday.</p>

RTC Timer Mode - All Days

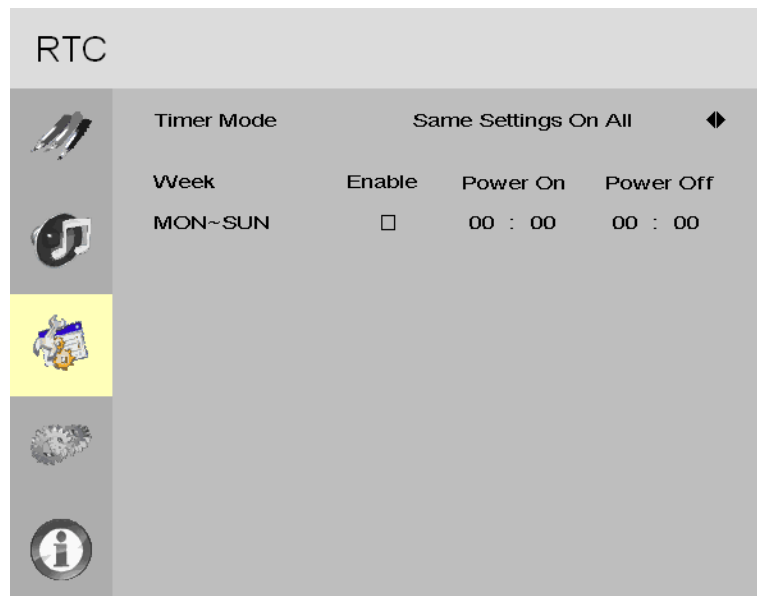
**Timer Mode****All Days** mode

Select all days of the week power on/off timer.

For all days, you have the following options:
Enable or Disable the schedule for all days of the week

Options: Disable, Enable

Default: Disable

Power On/Power Off timer setup.

Power On: Use the arrow keys to specify the time you want the display to turn on for all days of the week.

Power Off: Use the arrow keys to specify the time you want the display to turn off for all days of the week.

Advanced Menu

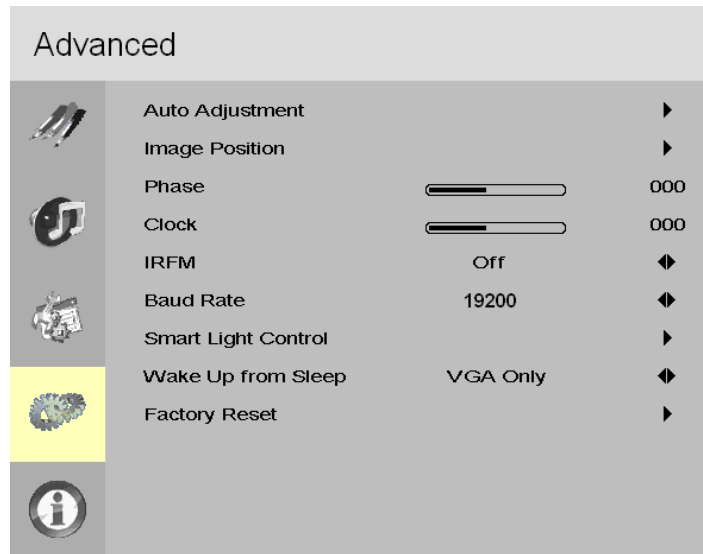

Auto Adjustment	<p>Forces the display to reacquire and lock to the input signal. This is useful when the signal quality is marginal.</p> <p>Note: This feature does not continually reacquire the signal. It only does so each time you select this option.</p> <p>Options: No, Yes Default: No</p>
Image Position	<p>Adjust the image location (VGA Mode only).</p> <p>Options: Up, Down, Left, Right</p>
Phase	<p>Range: 0~63 (VGA Mode only)</p>
Clock	<p>Range: 0~100 (VGA Mode only)</p>
IRFM	<p>Creates slight frame motion to help avoid image retention.</p> <p>Options: On Default: Off</p>

Baud Rate	<p>Options: 115200, 38400, 19200, 9600 Default: 19200</p>
Smart Light Control	<p>Options: Off, DCR, Light Sensor Default: Off</p>
Wake Up From Sleep	<p>Allows you to configure the display to “wake up” when it receives a digital signal through the DisplayPort, HDMI or DVI connectors. With VGA Only, the display can only “wake up” by sending an analog video signal through the VGA connector.</p> <p>Options: <u>Never Sleep</u> - The display will never enter a power saving mode. <u>VGA Only</u> - The display will enter a power saving mode if it cannot sync for five minutes with the DisplayPort, HDMI or DVI. If the sync is present, the display will “wake up” again. <u>VGA, Digital, RS-232</u> - The display will enter a power saving mode if it cannot sync for five minutes with any source.</p> <p>Default: VGA Only</p>
Factory Reset	<p>Restores all settings to their defaults.</p> <p>Options: No, Yes Default: No</p>

System Menu

This read-only menu provides information about the active sources and the latest firmware version.

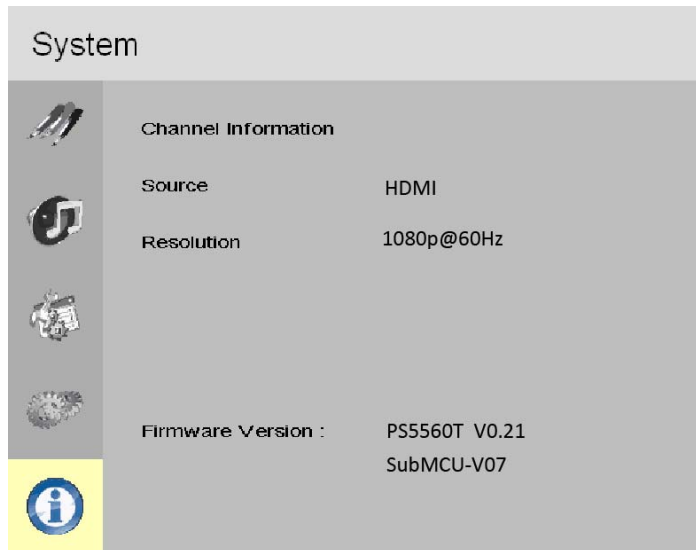

Default Settings

The following table shows the default settings for the LCD.

Item	Default
Power switch	Off
Scheme	User
Brightness	50
Sharpness	6
Backlight	80
Contrast	50
Color temperature	9300K
Source auto detection	On
OSD language	English
Smart light control	Off
IRFM	Off
Baud rate	19,200
OSD rotation	Landscape
Wake up from sleep	VGA only

Signal Compatibility

Timing		fH (KHz)	fV (Hz)	Dot clock (MHz)	HDMI	VGA	DVI	Display Port
VESA	VGA 640 x 480	31.469	59.94	25.175	○	○	○	○
	SVGA 800 x 600	35.156	56.25	36	○	○	○	○
		37.879	60.317	40	○	○	○	○
	XGA 1024 x 768	48.363	60.004	65	○	○	○	○
	WXGA1366 x 768	47.72	59.799	84.75	○	○	-	-
	1280 x 720	44.444	59.98	64	○	○	○	○
		44.772	59.86	74.5	○	○	○	○
	1280 x 768	47.776	59.87	79.5	○	○	○	○
		47.396	59.995	68.25	○	○	○	○
	1280 x 800	49.306	59.91	71	○	○	○	○
		49.702	59.81	83	○	○	○	○
	SXGA 1280 x 1024	63.981	60.02	108	○	○	○	○
	SXGA+ 1400 x 1050	64.744	59.95	101	○	-	-	○
		65.317	59.98	121.75	○	○	○	○
	1440 x 900	55.469	59.901	88.75	○	○	○	○
		55.935	59.88	106.5	○	○	○	○
	WSXGA+ 1680 x 1050	64.674	59.883	119	-	○	○	○
65.29		59.954	146.25	-	○	○	○	
UXGA 1600 x 1200	75	60	162	○	○	○	○	
1920 x 1080	66.587	59.93	138.5	○	○	○	○	
EDTV	480p	31.5	60	27.03	○	-	○	○
	576p	31.25	50	27	○	-	○	○
HDTV	720p	37.5	50	74.25	○	-	○	○
	1280 x 720	44.995	59.94	74.176	○	-	○	○
		45	60	74.25	○	-	○	○
	1080i	28.13	50	74.25	○	-	○	○
		1920 x 1080	33.716	59.94	74.176	○	-	○
	33.75		60	74.25	○	-	○	○
	1080p 1920 x 1080	67.433	59.94	148.352	○	-	○	○
67.5		60	148.5	○	-	○	○	

Specifications

Item		Specification
LCD panel	Resolution	1920 x 1080
	Brightness (Typ.) PS4660T PS5560T	500 cd/m ² 450 cd/m ²
	Contrast Ratio	Typical 4000:1
	Response Time PS4660T PS5560T	6.5 ms 6.5ms
	Aspect Ratio	16:9
	Horizontal Sync.	Positive/Negative
	Vertical Sync.	Positive/Negative
	Connectors	DisplayPort/HDMI/VGA/DVI/PC Audio in/IR Extender/Audio out
Power Source	Input Voltage/Frequency	AC 100V~240V, 50-60 Hz
Power Consumption	Operation Mode (Typ.) PS4660T PS5560T	145W (BTU calculation: 145W x 3.42 = 495.5 BTU/hr) 165W (BTU calculation: 165W x 3.42 = 564.3 BTU/hr)
	Power Saving Mode (Max)	< 0.5W (Wake up from sleep must be VGA only)
Physical	Standard Dimensions (W x H x D) PS4660T PS5560T	41.6" (W) x 24.1" (H) x 2.5" (D) 1057mm (W) x 612mm (H) x 64mm (D) 49.2" (W) x 28.3" (H) x 2.5" (D) 1249mm (W) x 719mm (H) x 63mm (D)
	Net Weight PS4660T PS5560T	68.6 lbs (31.1 kg) 90.8 lbs (41.2 kg)
	Gross Weight w/ packing PS4660T PS5560T	79.1 lbs (35.9 kg) 106.3 lbs (48.2 kg)

Item		Specification
Environment	Storage Temperature	Min -4°F ~ Max 140° F (-20°C ~ Max 60°C)
	Operating Temperature	Min 41°F ~ 95°F (5°C ~ Max 35°C)
	Humidity	80% RH @ 104°F (40°C)
Function	Plug and Play	DDC 2B Compliance
	RS232	D-Sub 9-pin
	OSD key	7 keys (⏻, SOURCE, ▲, ▼, ◀, ▶, MENU/EXIT)
	Wall mount	400 x 400, 400 x 200 VESA standard
Touch	Touch points	Up to six simultaneous touches
	Touch technology	Optical
	Touch interface	USB
	OS Compatibility	Windows 7, Windows Vista, Windows XP, Mac OSX and Linux

Troubleshooting

Before calling service personnel, please check the following table for a possible cause of the problem you are experiencing. Please note the following:

- Perform the adjustments according to "Operating the PS4660T/PS5560T" on page 16.
- If the problem you have experienced isn't described below or you can't correct the problem, stop using the PS4660T/PS5560T and contact Planar's Technical Support Department. (See "Accessing Planar's Technical Support Website" on page 48)

Issue	Check for the following
No image is displayed	Make sure the correct source is selected.
	Make sure the main power switch is turned ON.
	Check that the source equipment is operating correctly.
	Make sure the input signal is compatible with this display.
The image is not centered	Make sure the input signal is compatible with this display.
The remote control doesn't work	Make sure the batteries are new and are installed correctly. Ensure the remote is aimed at the IR sensor.
	Make sure the remote control sensor is plugged in correctly.
	Make sure the remote is aimed towards the back of the display, where the sensor is located.
The picture color looks poor	Check the picture settings. Reset the display.
Touch is not working	Ensure the USB cable is installed correctly on both ends. Also make sure that you are using one of the supported operating systems.

Accessing Planar's Technical Support Website

- 1 Go to www.planarpartners.com
- 2 Once you enter your login and password, you can access downloadable utility software, new firmware and user manuals.

Downloading Additional Documentation and Firmware

Some of the other documents for the PS4660T/PS5560T, which are or will be available on www.planar.com, are listed below:

Document Name	Contents
User Guide	Information for installers and end users to install and use displays.
RS232 Codes User Manual	Technical information about the product, such as display mode information and how to use RS232 commands to control displays.

Downloading Utility Software

- 1 Go to www.planarpartners.com.
- 2 Enter your login and password information.
- 3 Under the Service heading on the left pane, select the Software/Firmware subheading. Then select the LCD Displays tab and scroll until you find updates related to the PS series.
- 4 From the list of available software, click on the tool you need.