

Operating Instructions Network Operations

Touch Screen LCD Display For business use



205 Westwood Ave, Long Branch, NJ 07740
Phone: 866-94 BOARDS (26273) / (732)-222-1511
Fax: (732)-222-7088 | E-mail: sales@touchboards.com

Model No.	TH-80BF1U	80-inch model
	TH-65BF1U	65-inch model
	TH-50BF1U	50-inch model
	TH-80BF1E	80-inch model
	TH-65BF1E	65-inch model
	TH-50BF1E	50-inch model
	TH-80BF1W	80-inch model
	TH-65BF1W	65-inch model
	TH-50BF1W	50-inch model

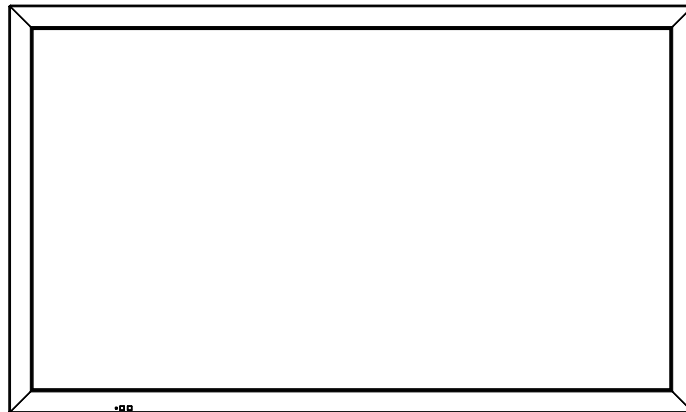

* This manual is common to all the models regardless of suffixes of the model number.

U : for US, Canada and Mexico

E : for EU and CIS

W : for South East Asia and Middle East Asia

English

Please read these instructions before operating your set and retain them for future reference.

HDMI

DPQP1035ZA/X1

Contents

Before use

- Illustrations and screens in this Operating Instructions are images for illustration purposes, and may be different from the actual ones.
- Descriptive illustrations in this Operating Instructions are created mainly based on the 50 inch model.

Read this first!	3
Request Regarding Security	5
What you can do	6
Notes on Using Wireless Connection	8
Notes on Using Wired LAN	9
Check your computer	10
Necessary environment for computers to be connected	10
Connection	11
Example of Network Connection (Wired LAN)	11
Example of Network Connection (DIGITAL LINK)	12
Network settings	13
Displaying the Network settings menu	13
Wired LAN	14
Wireless LAN	15
MIRRORING	20
Name change	21
Network control	22
WEB control	22
AMX D.D.	22
Crestron Connected™	22
Network Status	23
Password	23
Multi-Live	23
Live mode cut in	24
DIGITAL LINK status	24
DIGITAL LINK menu	24
DIGITAL LINK mode	25
Extron XTP	25
Reset	25
Connecting with Wired LAN	26
Computer operation	26
Connecting with Wireless LAN	26
Computer operation	26
Using Web Browser Control	27
Before Using Web Browser Control	27
Accessing from the Web browser	28
PJLink™ Protocol	40

Read this first!

FCC STATEMENT

This equipment has been tested and found to comply with the limits for a class A digital device, pursuant to Part 15 of the FCC Rules. These limits are designed to provide reasonable protection against harmful interference when the equipment is operated in a commercial environment. This equipment generates, uses and can radiate radio frequency energy and, if not installed and used in accordance with the instructions manual, may cause harmful interference to radio communications. Operation of this equipment in a residential area is likely to cause harmful interference in which case the user will be required to correct the interference at his own expense.

FCC CAUTION:

To assure continued compliance, follow the attached installation instructions and use only the provided power supply cord. Any changes or modifications not expressly approved by Panasonic Corp. of North America could void the user's authority to operate this device.

FCC and Industry Canada (IC) RF Exposure Warning:

- **This Display is provided with built-in transmitter: Wireless LAN Adapter with FCC ID: H8N-WLU5150/IC ID:1353A-WLU5150;**
- **This transmitter complies with FCC and IC radiation exposure limits set forth for an uncontrolled environment for mobile use with minimum 8 inches (20 cm) spacing requirement between transmitter and all person's body (excluding extremities of hands, wrist and feet) during wireless modes of operation.**
- **Other third-party wireless transmitters should not be used as they have not been RF exposure evaluated for use with this Display and may not comply with RF exposure requirements.**

<Only for wireless LAN if capable of transmission in the 5.15 ~ 5.25 GHz frequency band>

This product is restricted to indoor use due to its operation in the 5.15 to 5.25 GHz frequency range.

IC requires this product to be used indoors for the frequency range 5.15 to 5.25 GHz to reduce the potential for harmful interference to co-channel Mobile Satellite systems. High power radars are allocated as primary users of the 5.25 to 5.35 GHz and 5.65 to 5.85 GHz bands. These radar stations can cause interference with and/or damage this product.

Declaration of Verification

Model No.	TH-80BF1U, TH-65BF1U, TH-65BF1U
Responsible Party:	Panasonic Corporation of North America Two Riverfront Plaza, Newark, New Jersey 07102-5490
Contact Source:	Panasonic System Communications Company of North America 1-877-655-2357
General Contact:	http://shop.panasonic.com/support

This device complies with Part 15 of the FCC Rules and all applicable IC RSS standards. Operation is subject to the following two conditions: (1) This device may not cause harmful interference, and (2) this device must accept any interference received, including interference that may cause undesired operation.

Read this first!

LCD Display



Declaration of Conformity (DoC)

“Hereby, Panasonic Corporation declares that this Display is in compliance with the essential requirements and other relevant provisions of the Directive 1999/5/EC.”

If you want to get a copy of the original DoC of this Display, please visit the following website:
<http://www.doc.panasonic.de>

Authorized Representative:
Panasonic Testing Centre
Panasonic Marketing Europe GmbH
Winsbergring 15, 22525 Hamburg, Germany

This Display is intended to be used in the following countries.
Albania, Austria, Belgium, Bulgaria, Cyprus, Czech Republic, Denmark, Estonia, Finland, France, Germany, Greece, Hungary, Italy, Iceland, Latvia, Lithuania, Luxembourg, Malta, Netherlands, Norway, Poland, Portugal, Romania, Slovakia, Slovenia, Spain, Sweden, Switzerland, Turkey, United Kingdom

The wireless LAN feature of this Display shall exclusively be used inside buildings.

UAE

UAE-TRA
REGISTERED No:
ER0081229/12
DEALER No:
DA0052708/10

Singapore

Complies with
IDA Standards
DB01017

Thailand

“เครื่องโทรคมนาคมและอุปกรณ์นี้มีความสอดคล้องตาม
มาตรฐานทางเทคนิค เลขที่ กทข. มท. 1012-2551”

■ About built-in wireless LAN

CAUTION:

Be aware of the following limits before using the Wireless LAN Module.

- To use the Wireless LAN Module, an access point needs to be obtained.
- Do not use the Wireless LAN Module to connect to any wireless network (SSID*) for which you do not have usage rights. Such networks may be listed as a result of searches. However, using them may be regarded as illegal access.
*SSID is a name for identifying a particular wireless network for transmission.
- Do not subject the Wireless LAN Module to high temperatures, direct sunlight or moisture.
- Do not bend, or subject the Wireless LAN Module to strong impacts.
- Do not disassemble or alter the Wireless LAN Module in any way.
- Do not attempt to install the Wireless LAN Module in any incompatible device.
- Do not remove the Wireless LAN Module from the host product during operations.
- Data transmitted and received over radio waves may be intercepted and monitored.
- To avoid malfunctions caused by radio wave interface, keep the host product away from the devices such as other wireless LAN devices, microwaves and the devices that use 2.4 GHz and 5 GHz signals when using the Wireless LAN Module.
- When noises occur due to the static electricity, etc., the host product might stop operating for the protection of the devices. In this case, turn the host product Off with Mains power On / Off switch, then turn it On again.
- Depending on the area, this Wireless LAN Module may not be available.

Request Regarding Security

When using this product, security breaches of the type described below are conceivable.

- Leakage of your private information via this product
- Illegal operation of this product by a malicious third-party
- Harm to or cessation of operation of this product by a malicious third-party

Be sure to implement sufficient security measures.

- Set passwords, and limit the users that are permitted login access.
- Make sure the password is as hard to guess as possible.
- Change the password periodically.
- Panasonic Corporation and its affiliated companies never directly ask customers for their password. Do not give out your password even if directly asked by a third-party representing themselves as Panasonic Corporation.
- Always use on a network that has safety protection such as a firewall implemented.

About Wireless LANs

The advantage of a wireless LAN is that information can be exchanged between a PC or other such equipment and an access point using radio waves as long as you are within range for radio transmissions.

On the other hand, because the radio waves can travel through obstacles (such as walls) and are available everywhere within a given range, problems of the type listed below may occur if security-related settings are not made.

- A malicious third-party may intentionally intercept and monitor transmitted data including the content of e-mail and personal information such as your ID, password, and/or credit card numbers.
- A malicious third-party may access your personal or corporate network without authorization and engage in the following types of behavior.
 - Retrieve personal and/or secret information (information leak)
 - Spread false information by impersonating a particular person (spoofing)
 - Overwrite intercepted communications and issue false data (tampering)
 - Spread harmful software such as a computer virus and crash your data and/or system (system crash)

Since most wireless LAN adapters or access points are equipped with security features to take care of these problems, you can reduce the possibility of these problems occurring when using this product by making the appropriate security settings for the wireless LAN device.

Some wireless LAN devices may not be set for security immediately after purchase. To decrease the possibility of occurrence of security problems, before using any wireless LAN devices, be absolutely sure to make all security-related settings according to the instructions given in the operation manuals supplied with them.

Depending on the specifications of the wireless LAN, a malicious third-party may be able to break security settings by special means.

Please contact Panasonic if you need help taking care of security settings or other such.

If you cannot perform security settings for your wireless LAN by yourself, please contact the Panasonic Support Center.

Panasonic asks customers to thoroughly understand the risk of using this product without making security settings, and recommends that the customer make security settings at their own discretion and responsibility.

What you can do

This unit supports wired LAN and wireless LAN enabling the network functions as below.

<WEB control> (See page 27)

The following operations are possible when using Web Browser.

- Setting and adjusting the Display
- Displaying the Display status

<PJLink> (See page 40)

Compatible with PJLink Class 1. The following operations can be performed from a computer when PJLink protocol is used.

- Setting the Display
- Querying the Display status

<Command control>

Network function of the unit can control the unit in the same way as serial control from a network.

Supported commands

Commands used in the serial control are supported. (See “Operating Instructions, Display Operations”)

Notes

- When using “WEB control”, “PJLink” and “Command control”, enable LAN in “Network control” and “DIGITAL LINK mode” in the “Network settings” menu, and set “WEB control” to “On”. (See pages 22 and 25)
- When using “WEB control” wirelessly, enable wireless LAN in “Wireless LAN”, and set “WEB control” to “On”. (See pages 15 to 17)

● Wireless Manager (Windows/Mac)

Software for sending the computer screen via wireless/wired LAN.

To use this function, a specialized software is required. Please install this software from the supplied CD-ROM.

Note

- This unit does not support the following functions.
 - Virtual remote control function
 - USB display function

● Wireless Projector for iOS (Panasonic Wireless Projector for iOS)

Software for sending PowerPoint® files / PDF files, images, etc. saved in an iPad/iPhone/iPod touch to this unit via wireless LAN (Wi-Fi).

For more information, see the website below.

<http://panasonic.net/prodisplays/download/software/index.html>

● Wireless Projector for Android (application guide for Android)

Software for sending snapshots, PowerPoint®/Excel®/Word®/PDF files or JPEG/PNG images saved in an Android device (tablet/smartphone) to this unit via wireless LAN (Wi-Fi).

For more information, see the website below.

<http://panasonic.net/prodisplays/download/software/index.html>

● Early Warning Software

This unit supports “Early Warning Software” which monitors the statuses of devices (projectors or flat-panel displays) connected to an intranet, reports failures of devices and gives advance warning by detecting a predicted abnormality.

The maximum number of devices that can be registered to monitor differs according to the type of license. Up to 2048 devices can be registered and used for free for a maximum of 90 days after the installation to PC has completed.

For more details, visit the following web site.

<http://panasonic.net/prodisplays/products/et-swa100/index.html>

What you can do

● Multi Monitoring & Control Software

This unit supports “Multi Monitoring & Control Software” which monitors and controls devices (projectors or flat-panel displays) connected to an intranet.

For details, see the following website.

<http://panasonic.net/prodisplays/download/software/index.html>

Note

- This unit is not compatible with content list distribution function.

Notes on Using Wireless Connection

Wireless connection function of the Display uses radio waves in the 2.4 GHz and 5 GHz bands. A radio station license is not required, but be sure to read and fully understand the following items before use.

■ Do not use near other wireless equipment.

The following equipment may use radio waves in the same band as the Display. When the Display is used near these devices, radio wave interference may make communication impossible, or the communication speed may become slower.

- Microwave ovens, etc.
- Industrial, chemical and medical equipment, etc.
- In-plant radio stations for identifying moving objects such as those used in factory manufacturing lines, etc.
- Designated low-power radio stations

■ If at all possible, avoid the use of cellular phones, TV sets or radios near the Display.

Cellular phones, TV sets, radios and similar devices use different radio bands from the Display, so there is no effect on wireless communication or the transmission and reception of these devices. However, radio waves from the Display may produce audio or video noise.

■ Wireless communication radio waves cannot penetrate steel reinforcements, metal, concrete, etc.

Communication is possible through walls and floors made from materials such as wood and glass (except glass containing wire mesh), but not through walls and floors made from steel reinforcements, metal, concrete, etc.

■ Avoid using the Display in locations prone to static electricity.

If the Display is used in a location prone to static electricity, such as on a carpet, the wireless LAN or wired LAN connection may be lost.

If this happens, eliminate the source of static electricity or electromagnetic noise and reconnect to the wireless LAN or wired LAN.

■ Using the Display outside the country

It is forbidden to take the Display outside the country or region where you purchased it, so use it only in the said country or region. Also, note that depending on countries or regions there are restrictions on the channels and frequencies at which you can use the wireless LAN.

■ Available wireless LAN channels

The channels (frequency range) that can be used differ according to the country or region and the connecting method of the wireless LAN. Refer to the table below.

For MIRRORING mode

(When the connecting method is "MIRRORING" (Display Operations: see page 59))

Country or region	Standard	Channels used	Frequency band (Center frequency)
For Europe and CIS	IEEE802.11b/g/n	1 - 11	2.412 GHz - 2.462 GHz
	IEEE802.11a/n	36 / 40 / 44 / 48	5.180 GHz - 5.240 GHz
The power supplies are below 140 V (Except for Europe and CIS)	IEEE802.11b/g/n	1 - 11	2.412 GHz - 2.462 GHz
	IEEE802.11a/n	36 / 40 / 44 / 48 149 / 153 / 157 / 161	5.180 GHz - 5.240 GHz 5.745 GHz - 5.825 GHz
The power supplies are above 190 V (Except for Europe and CIS)	IEEE802.11b/g/n	1 - 11	2.412 GHz - 2.462 GHz

For M-DIRECT mode

(When the connecting method is "M-DIRECT" of "Panasonic APPLICATION" (see page 16))

Country or region	Standard	Channels used	Frequency band (Center frequency)
For Europe and CIS	IEEE802.11b/g/n	1 - 13	2.412 GHz - 2.472 GHz
The power supplies are below 140 V (Except for Europe and CIS)	IEEE802.11b/g/n	1 - 11	2.412 GHz - 2.462 GHz
	IEEE802.11a/n	36 / 40 / 44 / 48 149 / 153 / 157 / 161 / 165	5.180 GHz - 5.240 GHz 5.745 GHz - 5.825 GHz
The power supplies are above 190 V (Except for Europe and CIS)	IEEE802.11b/g/n	1 - 13	2.412 GHz - 2.472 GHz

Notes on Using Wireless Connection

For USER mode

(When the connecting method is "USER1"/"USER2"/"USER3" of "Panasonic APPLICATION" (see page 17))

Country or region	Standard	Channels used	Frequency band (Center frequency)	Scanning type
For Europe and CIS	IEEE802.11b/g/n	1 - 13	2.412 GHz - 2.472 GHz	Active scanning
	IEEE802.11a/n	36 / 40 / 44 / 48	5.180 GHz - 5.240 GHz	Active scanning
		52 / 56 / 60 / 64	5.260 GHz - 5.320 GHz	Passive scanning
		100 / 104 / 108 / 112 / 116 / 120 / 124 / 128 / 132 / 136 / 140	5.500 GHz - 5.700 GHz	Passive scanning
The power supplies are below 140 V (Except for Europe and CIS)	IEEE802.11b/g/n	1 - 11	2.412 GHz - 2.462 GHz	Active scanning
	IEEE802.11a/n	36 / 40 / 44 / 48	5.180 GHz - 5.240 GHz	Active scanning
		52 / 56 / 60 / 64	5.260 GHz - 5.320 GHz	Passive scanning
		100 / 104 / 108 / 112 / 116 / 120 / 124 / 128 / 132 / 136 / 140	5.500 GHz - 5.700 GHz	Passive scanning
		149 / 153 / 157 / 161 / 165	5.745 GHz - 5.825 GHz	Active scanning
The power supplies are above 190 V (Except for Europe and CIS)	IEEE802.11b/g/n	1 - 13	2.412 GHz - 2.472 GHz	Passive scanning
	IEEE802.11a/n	149 / 153 / 157 / 161	5.745 GHz - 5.805 GHz	Passive scanning

* The frequency and channel differ depending on the country.

* The passive scanning is performed by changing radio to the channel being scanned in each country.

* Please use the wireless LAN feature in compliance with the laws of each country.

■ For North America

This device is restricted to indoor use when operated in the 5.15 to 5.25 GHz frequency range (Channels 36 to 48).

■ For EU

This device is restricted to indoor use when operated in the 5.15 to 5.35 GHz frequency range (Channels 36 to 64).

■ For Mexico

Operation of this equipment is subject to the following two conditions:

- (1) this equipment might not have a harmful interference and
- (2) this equipment must accept any interference, including one that might cause it to malfunction

■ For Jamaica

- This product contains Type Approved Modules by Jamaica.

Notes on Using Wired LAN

Use straight or crossover LAN cable that is compatible with category 5 or above.

* Whether straight cable, crossover cable or both can be used varies depending on the system configuration. For details, consult your system administrator.

When setting up the Display at a place, where electric static occurs often, take a sufficient anti-static measure before start using.

* When the Display is used at a location, where static electricity occurs often, such as on a carpet, communications of the DIGITAL LINK and the wired LAN are disconnected more often. In that case, remove static electricity and the noise source that may cause problems with an antistatic mat, and re-connect the DIGITAL LINK and the wired LAN.

* In rare cases, the LAN connection is disabled due to static electricity or noise. In that case, turn off the power of the Display and the connected devices once and then re-turn on the power. Connect the DIGITAL LINK and the LAN.

The Display may not work properly due to strong radiowave from the broadcast station or the radio.

* If there is any facility or equipment, which outputs strong radiowave, near the installation location, set up the Display at a location sufficiently far from the source of the radiowave. Or, wrap the LAN cable connected to the DIGITAL LINK/LAN terminal by using a piece of metal foil or a metal pipe, of which is grounded at both ends.

Check your computer

Necessary environment for computers to be connected

- First, check your computer to see whether or not it has a wired LAN or a built-in wireless LAN function.
- Before connecting the Display to the computer, be sure to check the following settings.
- Operation is not guaranteed for all wireless LAN adapters and built-in wireless LAN adapters.

■ Wired LAN

Check 1 For LAN cable

- Is the cable properly connected?
- Use LAN cable that is compatible with category 5 or above.

Check 2 Wired LAN settings

<Computer with a built-in wired LAN function>

- Is your wired LAN switched on?

<Computer without a built-in wired LAN function>

- Is your wired LAN adapter properly recognized?
- Is your wired LAN adapter switched on?
- Install the wired LAN adapter driver beforehand.

For details on how to install the driver, refer to the instructions accompanying the wired LAN adapter.

■ Wireless LAN

Check 1 Wireless LAN settings

<Computer with a built-in wireless LAN function>

- Is your wireless LAN switched on?

<Computer without a built-in wireless LAN function>

- Is your wireless LAN adapter properly recognized?
- Is the wireless LAN adapter switched on?
- Install the wireless LAN adapter driver beforehand.

For details on how to install the driver, refer to the instructions accompanying the wireless card.

Check 2 Computer's settings

- When security (firewall) software and utilities for network cards are installed, these may prevent connection of the Display.

<Windows>

- Is Network Bridge enabled?
- Has your firewall been disabled?

■ For Web Browser

- Web Browser is necessary to use WEB control. Check in advance that WEB Browser is available.

OS	Compatible Web Browser
Windows	Internet Explorer 8.0/9.0/10.0/11.0
Mac OS	Safari 6.0/7.0/8.0

Connection

Example of Network Connection (Wired LAN)

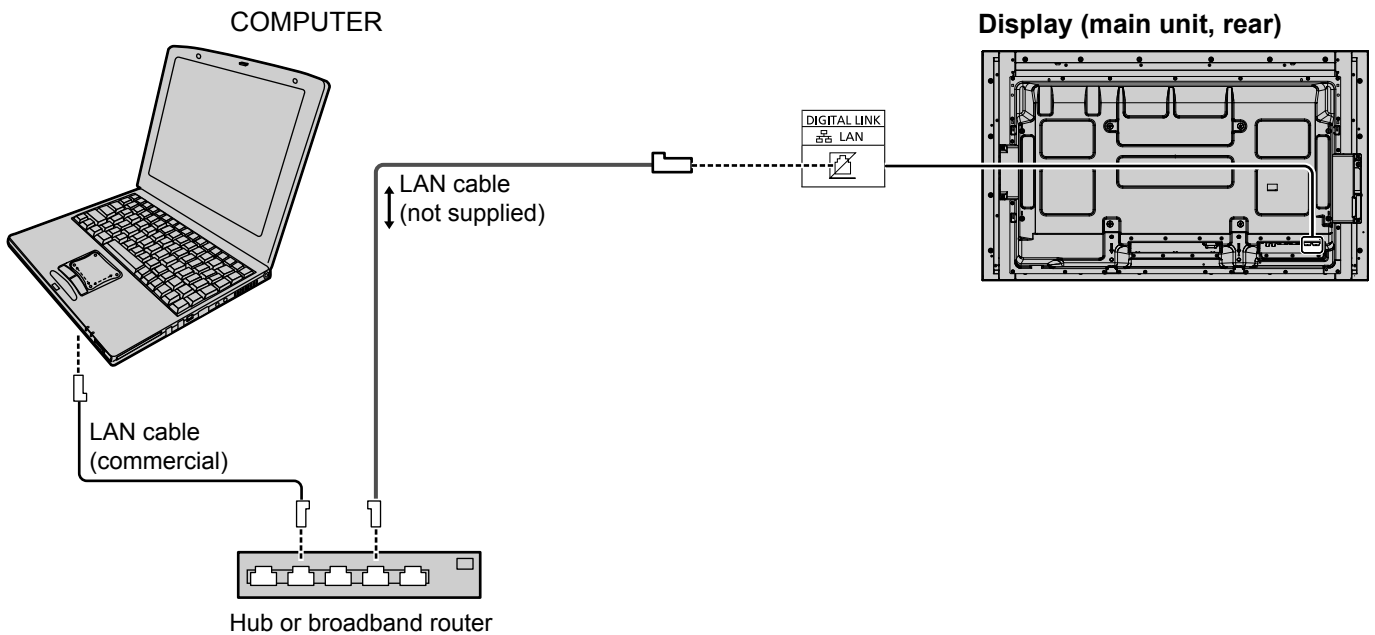

Notes

- When using network, set "Network settings" - "Network control" to "On". (see page 22)
When the unit enters the standby mode from power on (Picture is displayed.) status, the network function is disabled for approx. 1 minute.
- Make sure the broadband router or hub supports 100BASE-TX.
- Use a LAN cable between the twisted pair cable transmitter and the device that conforms to the following conditions.
 - It meets or exceeds CAT5e standards
 - It is a shielded cable (with a connector)
 - It is a straight cable
 - It is a single wire
- When laying the cable(s), use an instrument such as a cable tester or cable analyzer and check whether the cable characteristics are CAT5e or above.
- Touching the LAN terminal with a statically charged hand (body) may cause damage due to its discharge.
Do not touch the LAN terminal or a metal part of the LAN cable.
- For instructions on how to connect, consult your network administrator.

Connection

Example of Network Connection (DIGITAL LINK)

A twisted pair cable transmitter, such as the Panasonic device that supports DIGITAL LINK output (ET-YFB100G, ET-YFB200G) uses twisted pair cables to transmit inputted video and audio signals, and these digital signals can be input to the Display via the DIGITAL LINK terminal.

Network connections via DIGITAL LINK terminal

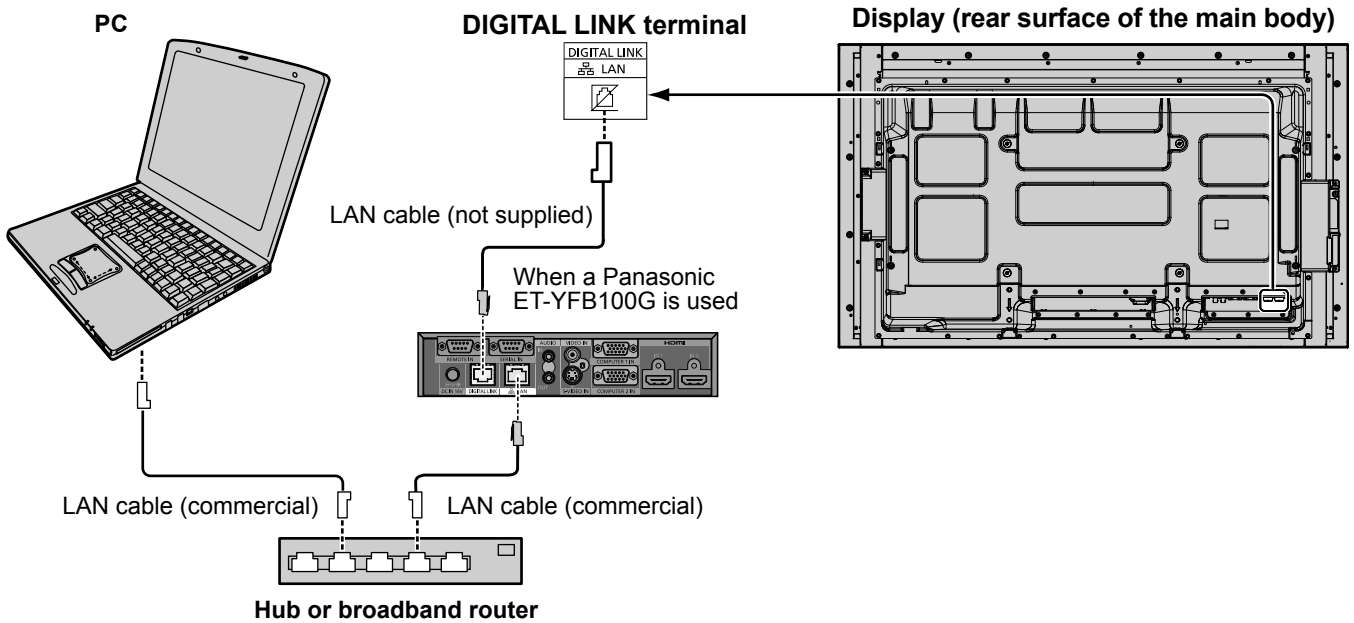

Note

- Configure the settings in “Network settings” when using a DIGITAL LINK connection. (see pages 22 to 25)

Precautions for use while connecting with a twisted pair cable transmitter

Installing / Connecting

- Ask the dealer or a qualified technician to carry out the cable wiring work for DIGITAL LINK connections. Insufficient wiring work may cause the inability to apply the cable transmission characteristics and cropped or fuzzy images and sounds.
- The transmission distance between the twisted pair cable transmitter and the device is up to 100 meters. Exceeding this distance can cause cropped images or sounds, as well as LAN communication errors.
- Do not use a hub between the twisted pair cable transmitter and the Display.
- When connecting to the Display using the twisted pair cable transmitter (receiver) of other maker, do not use another twisted pair cable transmitter between the twisted pair cable transmitter of other maker and this device. The images and sounds may be interrupted or become unstable.
- If possible, lay the cable so that it is extended and not coiled in order to minimize both external and internal noise.
- Lay out cables of the twist pair cable transmitter and this product away from other cables, especially from the power supply cable.
- When laying multiple cables, keep them as close together as possible running parallelly and not bundled.
- After laying the cable(s), make sure that the signal quality in “DIGITAL LINK status” is -12 dB or below.

Twisted pair cables

- Use a LAN cable between the twisted pair cable transmitter and the device that conforms to the following conditions.
 - It meets or exceeds CAT5e standards
 - It is a straight cable
 - It is a shielded cable (with a connector)
 - It is a solid cable
- When laying the cable(s), use an instrument such as a cable tester or cable analyzer and check whether the cable characteristics are CAT5e or above. When using a relay connector along the path, also include this in the measurements.
- Do not pull cables hard. Also avoid forcefully bending or folding them.

Other

- This device is compatible with Panasonic devices that support DIGITAL LINK output (ET-YFB100G, ET-YFB200G). For the twisted pair cable transmitter of other manufacturers, see the web site: <http://panasonic.net/prodisplays/support/digitallink.html>
- Panasonic has tested other manufacturers’ devices according to our check items. This will not guarantee all the operations. For operation and performance defects caused by other manufacturers’ devices, contact each manufacturer.

Network settings

Make the various settings to use the network function.

Notes

- For network settings, contact your network administrator.
- For “Network settings”, remote control operation or touch operation is used. The unit buttons cannot be used for operation.
- Concerning the touch operation, see “Operating Instructions, Display Operations”.

Displaying the Network settings menu

1 Press  to display “Setup” menu.

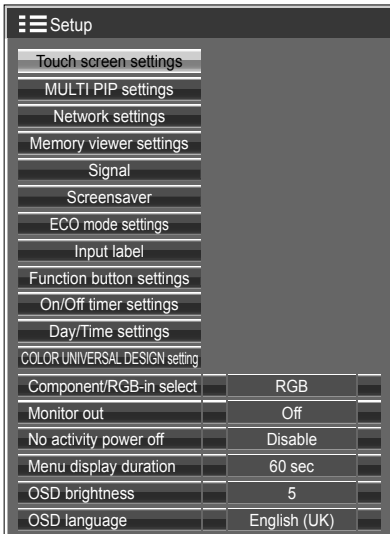

“Starting up the network”

It takes some time for the network to start up just after the Display power is turned on. During that time, “Network settings” in the “Setup” menu is grayed out and cannot be set.

2 Select “Network settings” with the ▲▼ and press  button.
The “Network settings” menu appears.

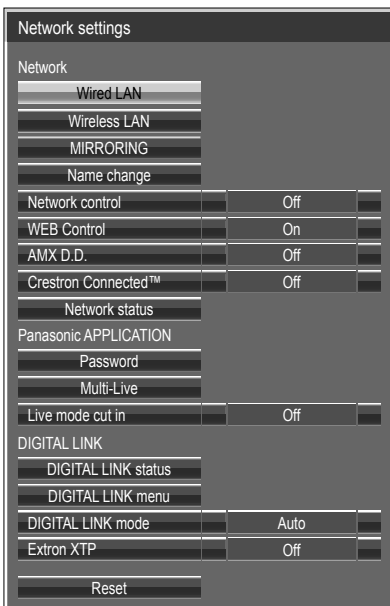



3 Press ▲▼ to select the item and set with ◀▶.
Press  to display sub menu.

Network settings

Wired LAN

Detailed network settings for the LAN established via the LAN terminal of the Display or twisted pair cable transmitter can be configured.

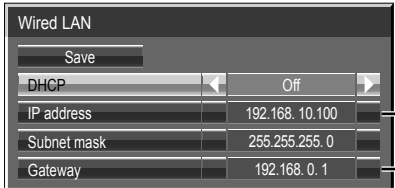

1 Select “Wired LAN” in “Network settings” menu and press button.

① Select the item and press  button.

② Delete the current numbers. (“Delete” or “All delete”)

③ Enter numbers and dots using numeric keypad on the screen.

④ Select “Ok” and press  button.
To cancel changing the address, select “Cancel” and press .

2 Set “DHCP”.

When “Off” is selected, IP address and other settings can be set manually.

DHCP (DHCP client function)	On: If a DHCP server exists in the network to which the display is connected, the IP address will automatically be acquired. Off: If a DHCP server does not exist in the network to which the display is connected, additionally set “IP address”, “Subnet mask” and “Gateway”.
IP address (Display of IP address and setting)	Enter the IP address if DHCP server is not used.
Subnet mask (Displaying and setting the subnet mask)	If not using a DHCP server, enter the subnet mask.
Gateway (Display of gateway address and setting)	Enter the gateway address if DHCP server is not used.

Note

- If “DHCP” is set to “On”, the IP address and other items are not displayed. Check the “Network Status” page for the current IP address and other items. (See page 23)

3 Select “Save” and press button.

Save the current network settings.

If message indicating a duplicate IP address is displayed in “Network Status” (see page 23), check the same IP address is not used within the same network.

Notes

- Before using the DHCP server, make sure the DHCP server is already functioning.
- For details of IP address, subnet mask, and gateway, ask the network administrator.
- A wired LAN and wireless LAN cannot be used in the same segment.

Default wired LAN settings

The following settings are set before the Display leaves the factory.

DHCP	Off
IP address	192.168.10.100
Subnet mask	255.255.255.0
Gateway	192.168.10.1

Network settings

Wireless LAN

You can make detailed wireless LAN settings. (You cannot select AD HOC mode with this display.)

Setting network number

1 Select “Wireless LAN” in “Network settings” menu and press  button.

2 Select the number to be connected for “Wireless LAN”.

- “Disable”, “Simple”, “S-DIRECT”, “M-DIRECT”, “USER1” - “USER3”
- “Simple”



Direct connection mode that can be compatible with all OS (Windows / Mac / iOS / Android etc.).

Use the wireless LAN function via the application software which supports “Wireless Manager ME6.3”, iPad / iPhone / iPod touch and Android devices. Switch the input to “Panasonic APPLICATION”, the idle screen will appear. You can confirm the SSID and KEY. The factory default value of the KEY can be changed. For details, refer to the following “Configuration of Wireless LAN “Simple””.

Notes

- Selecting “Disable” disables the wireless LAN.
- Network number: “S-DIRECT” is available only when connecting via wireless LAN with the application software the “Wireless Manager”. For details, refer to the operation manual of the “Wireless Manager”.
- Displays that can be connected to “Simple”, “S-DIRECT” or “M-DIRECT” are up to 10.

You can configure more precise network settings, if you select “Simple”, “M-DIRECT” or “USER1” - “USER3” (user) for “Wireless LAN”.

Configuration of Wireless LAN “Simple”

Compatible with Windows / Mac OS / iOS / Android and direct connection is possible.

1 Select “Simple” in “Wireless LAN”.

2 Press  to go to the next item.

Key	Set the key used for “Simple”. Input either 8 to 15 alphanumeric.
Wireless network standby (TH-80BF1U, TH-65BF1U, TH-50BF1U, TH-80BF1W, TH-65BF1W, TH-50BF1W)	Set to “On” when using the wireless web control or command control to turn the power “Off”/“On”. When set to “On”, the power consumption in standby is higher than when set to “Off”. (This function is not supported by TH-80BF1E, TH-65BF1E, TH-50BF1E.)
Wireless WEB control	Set to “On” when controlling the display from a web browser on a PC connected via wireless LAN.

3 Select “Save” and press  button.

Save the current network settings.

Default settings of “Simple”

The following settings as “Simple” in the “Wireless LAN” are set before the Display leaves the factory.

Key	proj + The last 4 digits of the network ID
Wireless network standby	Off (TH-80BF1U, TH-65BF1U, TH-50BF1U, TH-80BF1W, TH-65BF1W, TH-50BF1W)
Wireless WEB control	Off

Note

- “Network ID” can be confirmed in “Network status”. (see page 23)

Network settings

Configuration of Wireless LAN "M-DIRECT"

Even if there is no access point, you can still connect the Display to computer via the infrastructure. In addition, the connection with the iPad / iPhone / iPod touch is much easier. For more information, see the website below.

<http://panasonic.net/prodisplays/download/software/index.html>

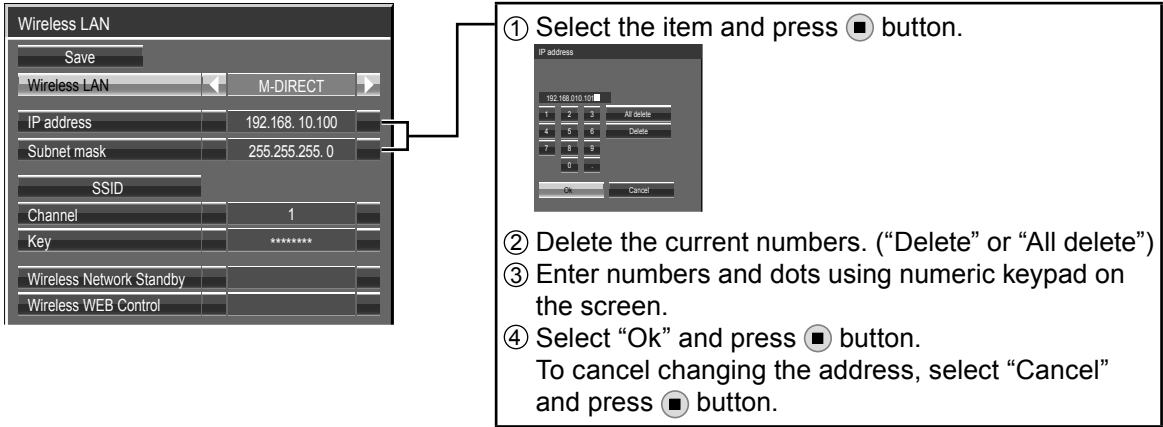

1 Select "M-DIRECT" for "Wireless LAN".



① Select the item and press  button.

② Delete the current numbers. ("Delete" or "All delete")

③ Enter numbers and dots using numeric keypad on the screen.

④ Select "Ok" and press  button.
To cancel changing the address, select "Cancel" and press  button.

2 Press to go to the next item.

IP address (Displaying and setting the IP address)	Enter the IP address.
Subnet mask (Displaying and setting the subnet mask)	Enter the subnet mask.
SSID	Select "M-DIRECT" in "Wireless LAN", then the SSID can be set. Entering characters ➡ page 21
Channel	Select "M-DIRECT" in "Wireless LAN", then the Channel can be set. Select a channel for the access point (➡ page 8).
Key	Select "M-DIRECT" in "Wireless LAN", then the Key can be set Setting a key for the access point. Input either 8 to 63 alphanumeric or a 64 digit string in the hexadecimal format.
Wireless network standby (TH-80BF1U, TH-65BF1U, TH-50BF1U, TH-80BF1W, TH-65BF1W, TH-50BF1W)	Set to "On" when using wireless web control or command control to turn the power off/on. When set to "On", power consumption in standby is higher than when set to "Off". (This function is not supported by TH-80BF1E, TH-65BF1E, TH-50BF1E.)
Wireless WEB control	Set to "On" when controlling the display from a web browser on a PC connected via wireless LAN.

3 Select "Save" and press button.

Save the current network settings.

■ Default settings of "M-DIRECT"

The following settings as "M-DIRECT" in the "Wireless LAN" are set before the Display leaves the factory.

IP address	192.168.12.100
Subnet mask	255.255.255.0
SSID	M-DIRECT + The last 4 digits of the Network ID
Channel	1
Key	The same string as the SSID
Wireless network standby	Off (TH-80BF1U, TH-65BF1U, TH-50BF1U, TH-80BF1W, TH-65BF1W, TH-50BF1W)
Wireless WEB control	Off

Network settings

Notes

- The authentication method is WPA2-PSK, and the encryption method is AES. Both methods are fixed.
- When you need to change initial configuration of “M-DIRECT”, please contact your network administrator.
- Make sure the initial Key is changed for safety.
- As the DHCP server is already functioning, select “ON” before connecting a computer.
- The “Key” may be displayed with the password of SSID depending on the devices.
- “Network ID” can be confirmed in “Network status”. (see page 23)

Configuration of Wireless LAN “USER1” - “USER3”

1 Select “USER1” – “USER3” for “Wireless LAN”.

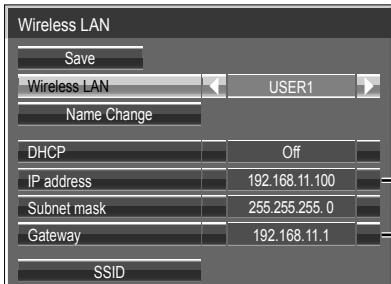

① Select the item and press button.

② Delete the current numbers. (“Delete” or “All delete”)

③ Enter numbers and dots using numeric keypad on the screen.

④ Select “Ok” and press button.
To cancel changing the address, select “Cancel” and press button.

2 Set “DHCP”.

When “Off” is selected, IP address and other settings can be set manually.

Name change	You can change the user name. Entering characters ➡ page 21
DHCP (DHCP client function)	On: If a DHCP server exists in the network to which the display is connected, the IP address will automatically be acquired. Off: If a DHCP server does not exist in the network to which the display is connected, additionally set “IP address”, “Subnet mask” and “Gateway”.
IP address (Display of IP address and setting)	Enter the IP address if DHCP server is not used.
Subnet mask (Displaying and setting the subnet mask)	If not using a DHCP server, enter the subnet mask.
Gateway (Display of gateway address and setting)	Enter the gateway address if DHCP server is not used.

Notes

- If “DHCP” is set to “On”, the IP address and other items are not displayed. Check the “Network Status” page for the current IP address and other items. (See page 23)
- Before using the DHCP server, make sure the DHCP server is already functioning.
- For details of IP address, subnet mask, and gateway, ask the network administrator.
- A wired LAN and wireless LAN cannot be used in the same segment.

Network settings

3 Press ▼ to go to the next item.

Make the settings related to the wireless connection between the Display and the network.



- **SSID** : Enter the SSID registered at the access point.
Entering characters ➡ page 21

Notes

- SSID has to be entered in alphanumeric letters.
- You cannot set “any” or “ANY” for SSID.

- **Authentication** : Set the user authentication method used by the network to be connected.
 - Open : Select when the access point authentication method is OpenSystem.
 - Shared : Select when the access point authentication method is Shared Key.
 - WPA-PSK
 - WPA2-PSK
 - WPA-EAP/
 - WPA2-EAP
 - WPA-EAP
 - WPA2-EAP

- **Encryption** : Select the encryption method to be used for communication between the Display and the network.
 - None : Select when transmit without encryption. It is selectable only when “Authentication” is “Open” or “Shared”.
 - WEP : Select when Encryption is WEP.
 - TKIP : Select when Encryption is TKIP.
Selectable when “Authentication” is either “WPA-PSK”, “WPA2-PSK”, “WPA-EAP”, “WPA2-EAP”.
 - AES : Select when Encryption is AES.
Selectable when “Authentication” is either “WPA-PSK”, “WPA2-PSK”, “WPA-EAP”, “WPA2-EAP”.

Note

- Important video/audio data is protected because AES encryption programming takes place in advance for all network numbers, even if “Encryption” is set to “None”.

Network settings

4 Press ▼ to go to the next item.

In addition, further perform the following setting depending on “Authentication” and “Encryption” settings.

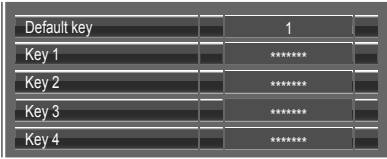

● **When setting “Open” or “Shared” as authentication and setting “WEP” as the encryption method:**

- Default key : Set 1 – 4 numerals for the default key.
- Key1 – 4 : Set a WEP key to the key number selected with “Default key”.
 Either the 64-bit or 128-bit WEP key can be set. For the 64-bit key, input five alphanumerics (or a 10-digit string for the hexadecimal format) for the 128-bit key, input 13 alphanumerics (or a 26-digit string for the hexadecimal format).

● **When using “WPA-PSK” or “WPA2-PSK” :**

Set a key.
 Input either 8 to 63 alphanumerics or a 64 digit string in the hexadecimal format.

● **When the authentication method is “WPA-EAP/WPA2-EAP”, “WPA-EAP”, “WPA2-EAP”:**

Set “EAP”, “User name”, and “Password”.

- EAP: Select the EAP setup in the RADIUS server. Types of EAP that can be selected are as follows.
 PEAP (MS-CHAPv2), PEAP (GTC), EAP-TTLS (MD5),
 EAP-TTLS (MS-CHAPv2), EAP-FAST (MS-CHAPv2), EAP-FAST (GTC)
- User name: Input a user name used for authentication (excluding spaces) (maximum 64 characters).
- Password: Input a password used for authentication (maximum 64 characters).

Entering characters ➡ page 21

Notes

- If you are unable to connect to the wireless LAN through the access point, contact the manufacturer of the access point.
- When using EAP, the display needs to be set according to the setting of the RADIUS server. Check with the network administrator for the setting of the RADIUS server.
- When using an EAP together with an access point with invalid SSID broadcast, select WAP-EAP or WAP2-EAP for the authentication method even if the authentication method of the access point is WPA-EAP/WPA2-EAP.

5 Select “Save” and press button.

Save the current network settings.

■ **Default settings of “USER1” - “USER3”**

The following settings as “USER1” - “USER3” in the “Wireless LAN” are set before the Display leaves the factory.

SSID	Panasonic Display
DHCP	Off
IP address	192.168.11.100
Subnet mask	255.255.255.0
Gateway	192.168.11.1

Authentication	Open
Encryption	None

Network settings

MIRRORING

You can make detailed settings of the MIRRORING function.

- 1 Select “MIRRORING” in “Network settings” menu and press  button.
- 2 Set each item in “MIRRORING”.

“Autonomous group owner”	Sets the display to be or not to be the autonomous group owner via Intel® WiDi / Intel® Pro WiDi / Miracast connection. Once the display is set to be the autonomous group owner, “Managed meetings” or “Channel” can be selected.
“On”	Sets the display to be the autonomous group owner.
“Off”	Sets the display not to be the autonomous group owner.
“Managed meetings”	Enables / disables the managed meeting of Intel® WiDi or Intel® Pro WiDi.
“On”	Enables the managed meeting.
“Off”	Disables the managed meeting.
“Channel”	Selects the communication channels used by Intel® WiDi / Intel® Pro WiDi / Miracast.
“Connection type”	Selects the connection type for the MIRRORING function.
“PIN”	A PIN (8-digit number) will be displayed in the idle screen of the MIRRORING function, and then makes connection by entering the PIN on the device.
“Auto”	If the PIN connection is supported on the device, do the PIN connection. If it is not supported, do the connection without a PIN.
“Lower bandwidth mode”	Enables / disables the lower bandwidth mode of Intel® WiDi or Intel® Pro WiDi.
“Off”	Disables the lower bandwidth mode.
“On”	Enables the lower bandwidth mode. The bit rate will decrease, and the image quality will reduce.

- 3 Select “Save” and press  button.
Save the MIRRORING settings.

Notes

- Even if the “Autonomous group owner” is set to “Off”, it may set to the autonomous group owner depending on the connected device.
- If you cannot connect to the display, or the display is not existed in the available connection device list, you can try to switch the “Autonomous group owner” to “Off” or “On”.
- For more information about Intel® WiDi or Intel® Pro WiDi conference mode, please refer to the HELP of Intel® WiDi or Intel® Pro WiDi application, or visit the Intel Corporation website.
- It could be connected by switching “Options” - “Mobile connection” to “Off”.

Network settings

Name change

You can change the Display name to be displayed on the network.

1 Select “Name change” in “Network settings” menu and press button.

The keyboard is displayed.

Up to 8 characters can be entered for the Display name.

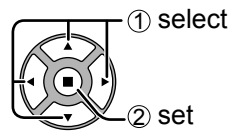
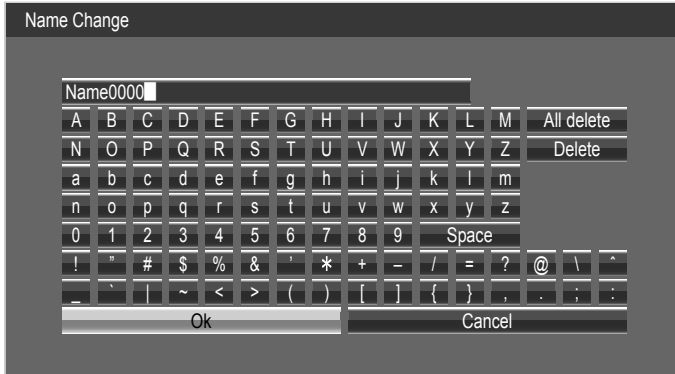

“Entering characters”

To enter text, select characters in the on-screen keyboard.

Example: Specifying “LCD 01”

① Select “All delete”.



All text is deleted.

To delete individual characters, select “Delete”.

② Select “L”.



Repeat this process to enter the next character.

③ Select “C” and “D”.



④ Select “Space”.



⑤ Select “0” and “1”.



2 When you finished entering the Display name, select “Ok” and press .

To cancel saving the Display name, select “Cancel”.

Network settings

Network control

Set when controlling with the unit's DIGITAL LINK / LAN terminal.

1 Select "Network control" in "Network settings" menu and press  button.

2 Select "On" or "Off".

On:

Controls via LAN using the LAN terminal of the Display or twisted pair cable transmitter or via RS-232C using the SERIAL (RS-232C) terminal of twisted pair cable transmitter. The power indicator lights purple when the power is turned off with the remote control (standby).

Off:

Invalidates control with DIGITAL LINK / LAN terminal.

(In this case, the power consumption of Standby condition (when the power is turned off with the remote control) will be slightly reduced.)

Notes

- Even when "Off" is selected, when the power is turned on, HDMI communication via twisted pair cable transmitter becomes possible.
- For the case of "On", see "DIGITAL LINK mode" (see page 25)
- When this is set to "On" and "DIGITAL LINK(RS-232C)" is selected in "DIGITAL LINK mode", it is not possible to control with the unit's SERIAL terminal.

WEB control

Set to "On" when controlling the display from a web browser on a PC connected via wired LAN.

1 Select "WEB control" in "Network settings" menu and press  button.

2 Select "On" or "Off".

Note

- When using "WEB control" wirelessly, enable wireless LAN in "Wireless LAN" in the "Network settings" menu, and set "Wireless WEB control" to "On". (See pages 15 to 17)

AMX D.D.

This function allows the Display to be detected by AMX Device Discovery. For more details, visit the following website.

<http://www.amx.com/>

Crestron Connected™

When this function is set to on, the Display can be monitored or controlled via the network using equipment and application software of Crestron Electronics, Inc.

This Display supports the following application software from Crestron Electronics, Inc.

- RoomView® Express
- Fusion RV®
- RoomView® Server Edition

"Crestron Connected™" is a function to connect to a system developed by Crestron Electronics, Inc. which manages and controls multiple system devices connected to the network.

- For details of "Crestron Connected™", refer to the Crestron Electronics, Inc. website (Provided only in English).

<http://www.crestron.com/>

For the download of "RoomView® Express", refer to the Crestron Electronics, Inc. website (Provided only in English).

<http://www.crestron.com/getroomview>

Network settings

Network Status

Displays the current network status.

Select “Network Status” in “Network settings” menu and press  button.

The Display information, settings of wired LAN and wireless LAN are displayed.

Password

Set to “On” to perform password check when connecting with the Display using “Wireless Manager”.

By controlling connection with password setting, it is possible to prevent an external device from accidentally connecting and interrupting images, etc.

1 Select “Password” in “Network settings” menu and press  button.

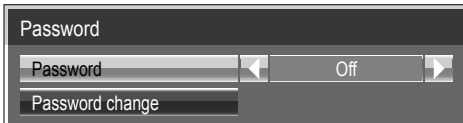

2 Select “On” or “Off” for “Password”.

Password change

Password can be registered or changed. No password is set in the default setting.

1 Select “Password change” and press  button.

The keyboard is displayed.

Up to 8 characters can be entered for the password.

Entering characters ➡ page 21

2 When you finished entering the password, select “Ok” and press .

To cancel saving the password, select “Cancel”.

Note

- It is recommended to change password on a regular basis for keeping it private.

Multi-Live

Switch to the MULTI-LIVE mode when using the “Wireless Manager”. See the “Wireless Manager” operation manual for details.

When using Panasonic APPLICATION input, select “Multi-Live” in “Network settings” menu and press  button.

Network settings

Live mode cut in

Set this “ON” to allow interrupt of the Live mode by other users while the Live mode is active (sending image) by the “Wireless Manager”. For details, refer to “Wireless Manager” operating manual.

- 1 Select “Live mode cut in” in “Network settings” menu and press  button.
- 2 Select “On” or “Off”.

DIGITAL LINK status

Display the DIGITAL LINK connection environment.

Select “DIGITAL LINK status” in “Network settings” menu, and press .

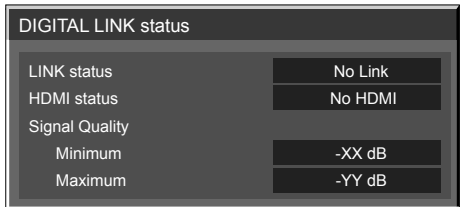

LINK status : Either “No link”, “DIGITAL LINK”, or “Ethernet” will be displayed.
 No link : No LAN connection, etc.
 DIGITAL LINK : Connected to the DIGITAL LINK device by LAN
 Ethernet : The PC is connected to the DIGITAL LINK terminal of this product and is LAN connected

HDMI status : Either “No HDMI”, “HDMI ON”, or “HDCP ON” will be displayed.
 No HDMI : DIGITAL LINK not connected
 HDMI ON : DIGITAL LINK connected
 HDCP ON : A signal with an HDCP is flowing with a DIGITAL LINK connection.

Signal quality : It is the quantified minimum and maximum numbers of errors that have occurred. The display colors are red, yellow, or green, depending on the number.
 The number is represented by yellow or red if the LAN cable is disconnected or the cable is not shielded. This signal quality shows figures between the twisted pair cable transmitter that is connected and the display.

Signal Quality	Display Colors	Reception Status
-12dB or below	Green	The reception is normal
-11 to -8dB	Yellow	Part of the received data is corrupted
-7dB or above	Red	There are reception difficulties

DIGITAL LINK menu

In “Network settings”, select “DIGITAL LINK menu” and press  to switch to the setup menu of Panasonic device that supports DIGITAL LINK output.

Note

- This function can only be selected when the Panasonic device that supports DIGITAL LINK output (ET-YFB100G, ET-YFB200G) is connected to a LAN terminal and its power is on.

Network settings

DIGITAL LINK mode

You can switch the setting of DIGITAL LINK/LAN terminal.

LAN: Enables LAN communication via the Display's LAN terminal.

Auto (LAN): Enables automatic selection between LAN communication via the Display's LAN terminal and HDMI/LAN communication via the twisted pair cable transmitter.

DIGITAL LINK (LAN): Enables HDMI/LAN communication via the twisted pair cable transmitter.

DIGITAL LINK (RS-232C): Enables HDMI/RS-232C communication via the twisted pair cable transmitter.

Notes

- To use the control methods shown in pages 27 to 40, select “LAN”, “Auto (LAN)” or “DIGITAL LINK (LAN)”.
- Power consumption during standby is slightly larger if you set to any other setting than “LAN”.

Extron XTP

To carry out connection settings with XTP Transmitter made by Extron. Visit the following website for details.
<http://www.extron.com>

Reset

You can reset the network setting to the factory default of the Display.

- 1 Select “Reset” in “Network settings” menu and press  button.

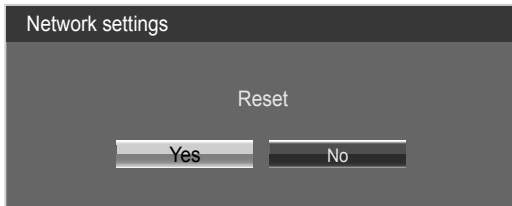

- 2 Select “Yes” and press .

Note

- It takes some time to restart network while the network settings are initialized. During that time, “Network settings” in the “Setup” menu is grayed out and cannot be set.

Connecting with Wired LAN

Note

- To use the network function, make the necessary settings in “Network settings” and be sure to set LAN to enabled in “Network control” and “DIGITAL LINK mode”. (See page 22 and 25)

Computer operation

Connection can be made with wired LAN. However, confirm to your system administrator on network settings before changing any settings.

1 Turn on the computer.

2 Make the network setting according to your system administrator.

If the Display settings are the default settings (See page 14), the computer can be used with the following network settings.

IP address	192.168.10.101
Subnet mask	255.255.255.0
Gateway	192.168.10.1

Connecting with Wireless LAN

Computer operation

1 Make the network setting according to your system administrator.

- If you select “M-DIRECT” for “Wireless LAN” in the “Network settings” menu, the IP address will automatically be acquired.
- If you select default settings of “USER1” - “USER3” for “Wireless LAN” in the “Network settings” menu (see page 19), then the computer can be used with the following network settings.

IP address	192.168.11.101
Subnet mask	255.255.255.0
Gateway	192.168.11.1

2 Connect to the wireless network that has the same “SSID” set with the Display.

When you select default settings of “M-DIRECT” for “Wireless LAN” in the “Network settings” menu, the SSID is “M-DIRECT + The last 4 digits of the Network ID”.

When you select default settings of “USER1” - “USER3” for “Wireless LAN” in the “Network settings” menu, the SSID is “Panasonic Display”.

Notes

- If you use any wireless utility other than Windows “Wireless Network Connection”, follow its operation procedure for connection.
- If you use the access point, configure the Display and each network setting of the computer following the instruction of the network administrator.

Using Web Browser Control

You can use a Web browser to control the unit and set up a network and password.

Before Using Web Browser Control

To use the Web browser control, the unit and computer set ups are required.

■ About Web Browser

Set each item in “Network settings” and be sure to set “Network control” to “On”. (see page 22)

■ Computer Setup

Disable the proxy server settings and enable JavaScript.

- The setting procedure differs depending on the software version.
Please refer to description in HELP, etc. of the software.

(Windows)

Windows 7 is used as an example.

Disable proxy server settings

- 1 Display “Internet Properties” window.
Click “Start” - “Control Panel” - “Network and Internet” - “Internet Options”.
 - If the on screen display looks different, please set “View by:” to “Category”.
- 2 Click the “Connections” tab and then “LAN Settings”.
- 3 Deselect the “Use automatic configuration script” and “Use a proxy server for your LAN” boxes.
- 4 Click “OK”.

Enable JavaScript

- 1 Display “Internet Properties” window.
Click “Start” - “Control Panel” - “Network and Internet” - “Internet Options”.
 - If the on screen display looks different, please set “View by:” to “Category”.
- 2 Set the security level on the “Security” tab to “Default Level”. Alternatively enable “Active scripting” from the “Custom Level” button.

(Macintosh)

Disable proxy server settings

- 1 From the “Safari” menu, click “Preferences”.
General screen is displayed.
- 2 From the “Advanced” tab, click the “Change Settings...” button next to “Proxies”.
Click “Proxies” and set up a proxy server.
- 3 Deselect the “Web Proxy” and “Automatic Proxy Configuration” boxes.
- 4 Click “Apply Now”.

Enable JavaScript

- 1 Display “Security” of Safari.
- 2 Select “Enable JavaScript” under “Web content”.

Using Web Browser Control

Accessing from the Web browser

- 1 Activate the Web browser in the personal computer.
- 2 Enter the IP address set in “Network settings” of the unit. (see page 14)



- 3 Enter your “User name” and “Password”.

The factory default settings are user1 (user privileges) or admin1 (administrator privileges) for the user name and panasonic for the password.



- 4 Click “OK” to display the Display status page.

“Display status” page is displayed.

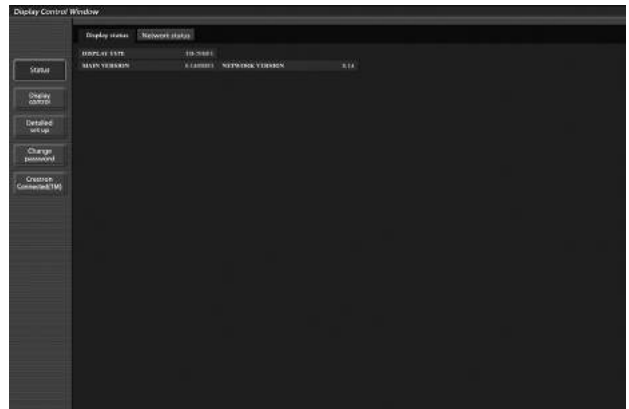

Notes

- Avoid activating two or more Web browser simultaneously to work out setting or control actions.
- Change the password first of all.
- Administrator privileges enable the use of all functions. User privileges enable the use of only “Display status”, “Network status”, “Basic control”, “Advanced control”, and “Change password”.
- If the password is incorrectly entered three times in a row, the lock is set for several minutes.
- If you want to control the Display using a Web browser, set “WEB control” in “Network settings” menu to “On”.

Using Web Browser Control

■ Description of each item

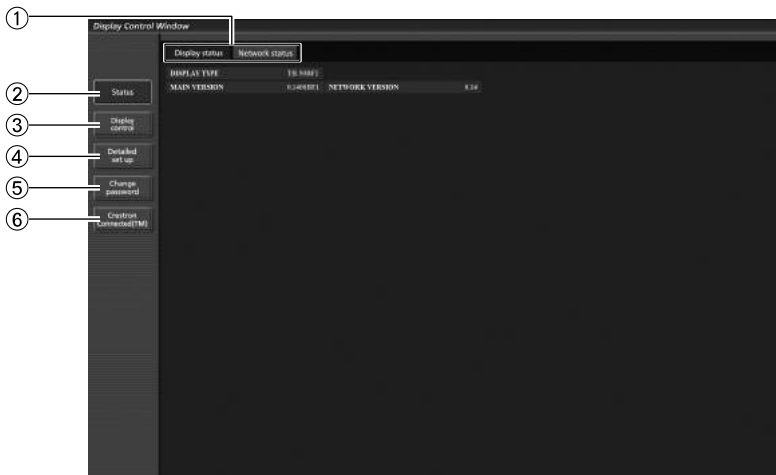

- ① Page tab
Click these to switch pages.
- ② Status
Click this item, and the status of the Display is displayed.
- ③ Display control
Click this item to display the Display control page.
- ④ Detailed set up
Click this item to display the advanced settings page.
- ⑤ Change password
- ⑥ Click this item to display the Crestron Connected™ operation page.

Display status page

Click "Status", then "Display status" to display the Status information page. This page displays the Display statuses established for the items shown below.

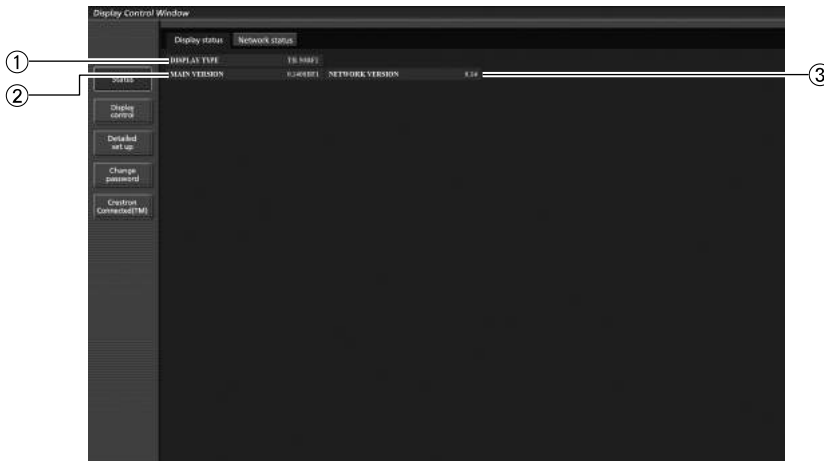

- ① Displays the type of Display.
- ② Displays the firmware version of the Display main unit.
- ③ Displays the firmware version of the network.

Using Web Browser Control

Network status page

Click “Status”, then “Network status” to display the Status information page.
Displays the current configuration information of the network.

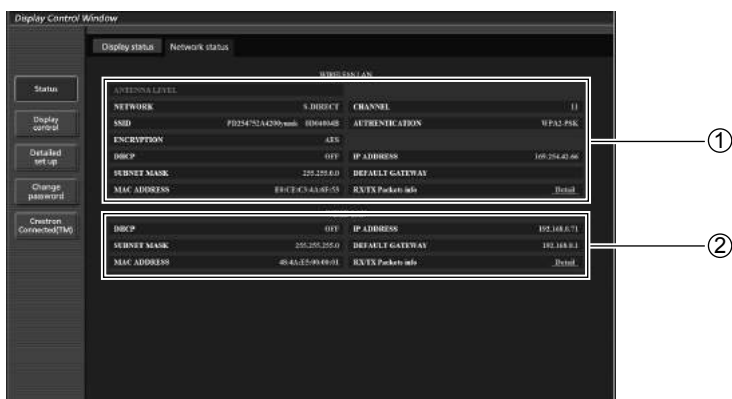

① Displays the configuration details of wireless LAN.

② Displays the configuration details of wired LAN.

Using Web Browser Control

Basic control page

To move from another page, click “Display control”, then “Basic control”.



- ① Power On/Off control
 - ② Use these to select the input signals
 - ③ Operation of AV mute
 - ④ Switches aspect mode
- The button display changes depending on the connection status of video equipment.

Notes

The following points will be different when connected wirelessly.

- Switching to MIRRORING and MEMORY VIEWER input will not be possible.
- Control will not be possible with Crestron Connected™.

TH-80BF1U, TH-65BF1U, TH-50BF1U, TH-80BF1W, TH-65BF1W, TH-50BF1W

- When “Wireless network standby” is off, operation for turning the power on/off will not be shown.

TH-80BF1E, TH-65BF1E, TH-50BF1E

- “Wireless network standby” function is not supported, and operation for turning the power on/off will not be shown.

Detail control page

Click “Display control”, then “Advanced control” to display the Detail control page.

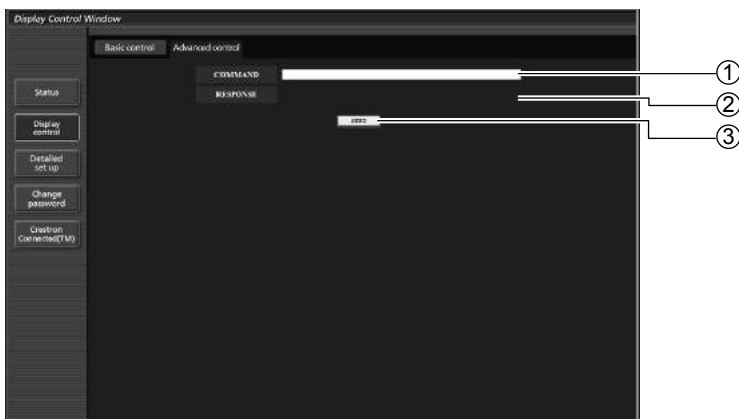

- ① Enter a command. Use the same command used for the serial control. (refer to “Operating Instructions, Display Operations”)
- ② Response from the unit is displayed.
- ③ Command is sent and run.

Note

- After the settings are changed, it may take a while till the display status is displayed.

Using Web Browser Control

Change Password page

Click "Change password".



- ① Administrator
- ② User

Administrator mode

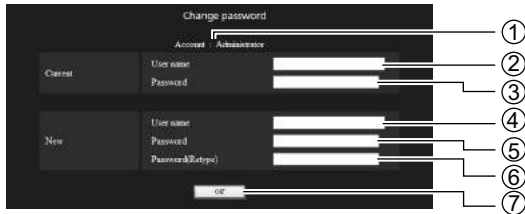

- ① Account
- ② Current user name input field
- ③ Current password input field
- ④ New user name input field
- ⑤ New password input field
- ⑥ New password input field (re-enter for confirmation)
- ⑦ Button for executing password change

User account



- ① Account
- ② New user name input field
- ③ New password input field
- ④ New password input field (re-enter for confirmation)
- ⑤ Button for executing password change

User mode

A user can change password only.

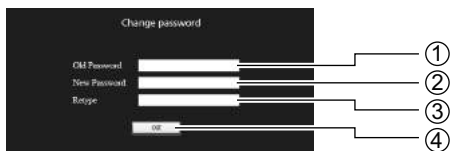

- ① Current password input field
- ② New password input field
- ③ New password input field (re-enter for confirmation)
- ④ Button for executing password change

Notes

- When changing the administrator account, both "Current user name" and "Current password" are required.
- The default password is "panasonic".
- Up to 16 alphanumeric characters can be used for a password.
- When the password is changed properly, "Password has changed." message is displayed.

Using Web Browser Control

Network config page

You can make detail network settings on Display, when connecting without the administrator authority or when connecting with Wireless LAN.

LAN settings

- 1 Click “Detailed set up” in the menu.
- 2 Select the items to change and click “Next”.
The settings window appears, showing the current settings.
 - To change the LAN settings, click “Change”.
 - To return to the previous window, click “Back”.

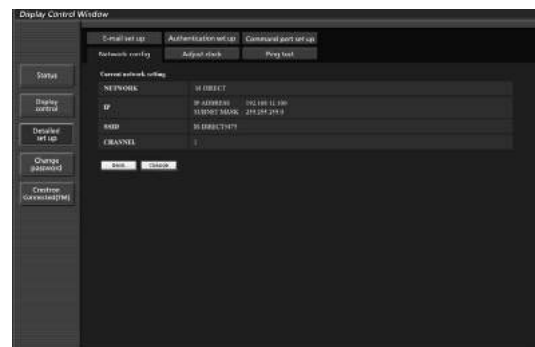
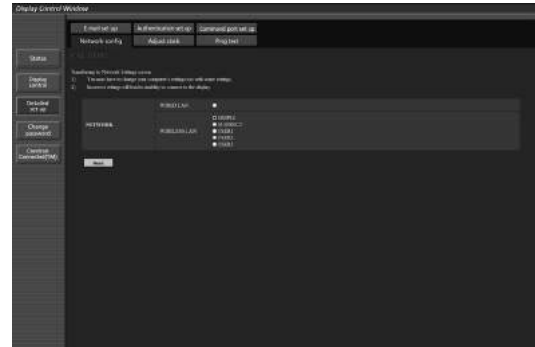

- 3 Complete the detailed settings and click “Next”.

When “Next” is clicked, the next page appears, enabling you to complete the detailed settings as desired.

Settings performed here are the same as the settings performed with the “Network settings” menu of the Display.

- Wired LAN (See page 14)
- Wireless LAN (See page 15)

After all required items have been entered, a confirmation window appears.

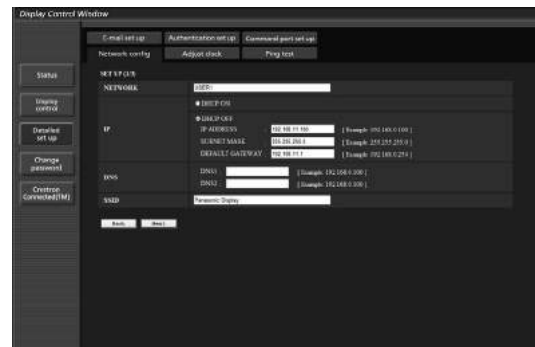

(Wireless LAN screen)

Using Web Browser Control

4 Click "Submit".

The settings will be registered.

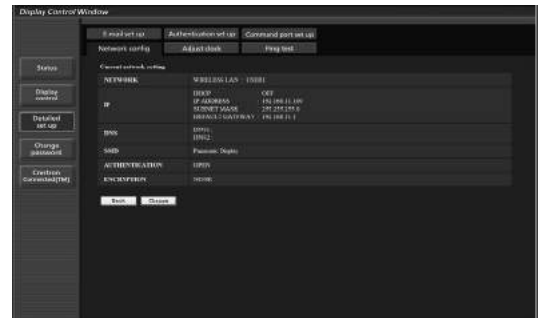

(Wireless LAN screen)

■ Making the above settings effective (Only for wireless LAN)

Select "Wireless LAN" in "Network settings" menu of the Display, and select the network set in this page.

Notes

- Important video/audio data is protected because AES encryption processing takes place.
- Changing the setting of LAN while connected with LAN might disconnect the connection.

Adjust clock page

Click "Detailed set up", then "Adjust clock" to display the Adjust clock page.

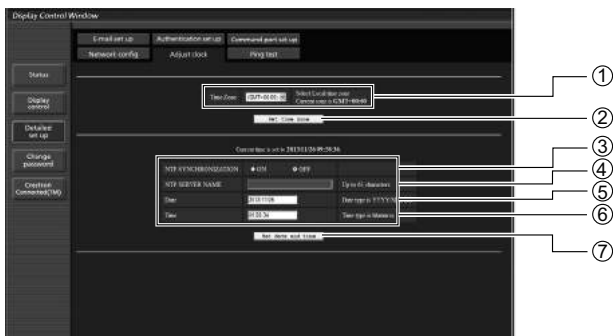

- ① Time zone selection
- ② Button to update time zone setting
- ③ Turn this "ON" to set the date and time automatically.
- ④ When setting the date and time automatically, input the IP address or name of the NTP server. (When inputting the server name, the DNS server must be set.)
- ⑤ New date field
- ⑥ New time field
- ⑦ Button to update time and date settings

Note

- If the time becomes incorrect immediately after setting the correct time, contact the dealer where you bought the Display.

Using Web Browser Control

Ping test page

This page makes it possible to check whether the network is connected to the DNS server, etc. Click “Detailed set up”, then “Ping test” to display the Ping test page.

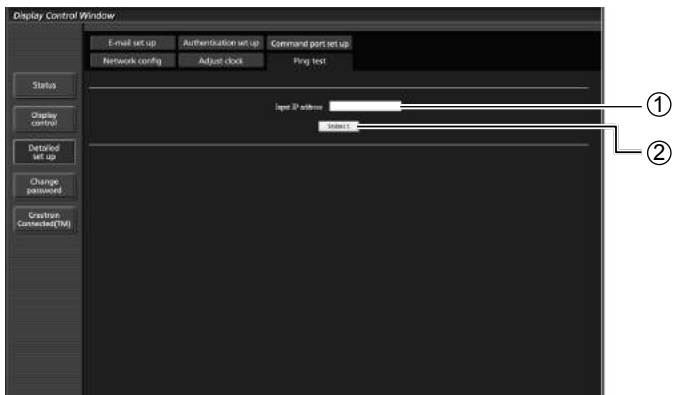

Display which appears when the connection was successful.

```
PING 192.168.0.78 (192.168.0.78) 56(84) bytes of data.  
64 bytes from 192.168.0.78: icmp_seq=1 ttl=64 time=6.90 ms  
64 bytes from 192.168.0.78: icmp_seq=2 ttl=64 time=1.02 ms  
64 bytes from 192.168.0.78: icmp_seq=3 ttl=64 time=0.979 ms  
64 bytes from 192.168.0.78: icmp_seq=4 ttl=64 time=1.04 ms  
  
--- 192.168.0.78 ping statistics ---  
4 packets transmitted, 4 received, 0% packet loss, time 3000ms  
rtt min/avg/max/mdev = 0.979/2.486/6.902/2.599 ms
```

Display which appears when the connection failed.

```
PING 192.168.0.60 (192.168.0.60) 56(84) bytes of data.  
  
--- 192.168.0.60 ping statistics ---  
4 packets transmitted, 0 received, 100% packet loss, time 3003ms
```

- ① Enter the IP address of the server to be tested.
- ② Button for conducting the test.

Command port set up page

Set the port number to be used with command control. Click “Detailed set up” → “Command port set up”.

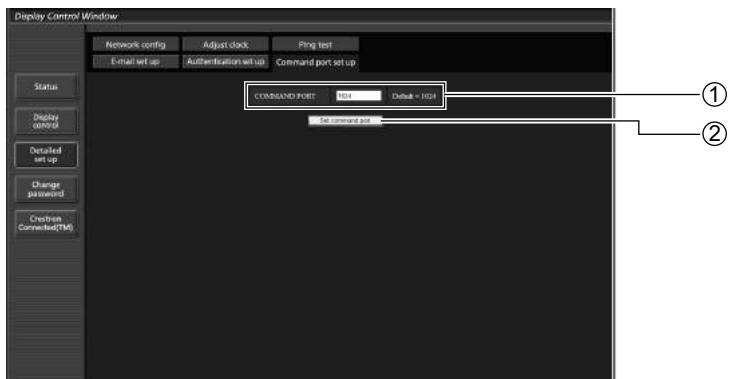

- ① Input the port number to be used with command control
- ② Setting update button

Using Web Browser Control

E-mail set up page

You can send image data displayed by the whiteboard function using an E-mail.
Click “Detailed set up” → “E-mail set up”.

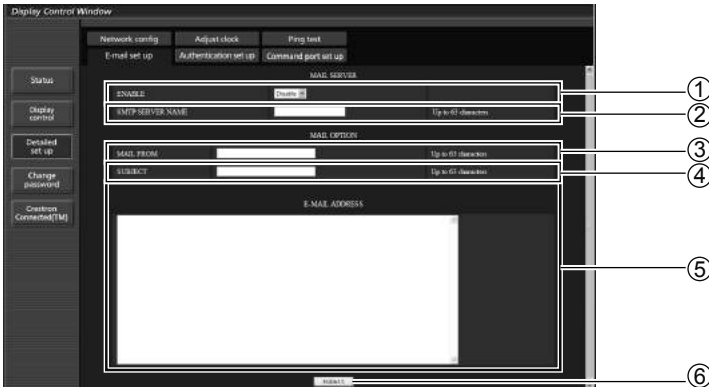

① **“ENABLE”**

Select “Enable” to use the e-mail function.

② **“SMTP SERVER NAME”**

Enter the IP address or the server name of the e-mail server (SMTP). To enter the server name, the DNS server needs to be set up. (Up to 63 single-byte characters)

③ **“MAIL FROM”**

Enter the e-mail address of the display. (Up to 63 single-byte characters)

④ **“SUBJECT”**

Enter the subject of the e-mail. (Up to 63 single-byte characters)

⑤ **“E-MAIL ADDRESS”**

Enter the recipient email addresses. Up to 64 addressees can be registered using up to 2048 characters. Separate each e-mail address by a comma. A list of set addresses is displayed through the e-mail function of the whiteboard function and is available for sending e-mails.

⑥ **“SUBMIT”**

Update the settings.

Using Web Browser Control

Authentication server setup page

Set the authentication items for the server necessary to send an e-mail.
Click “Detailed set up” → “Authentication set up”.

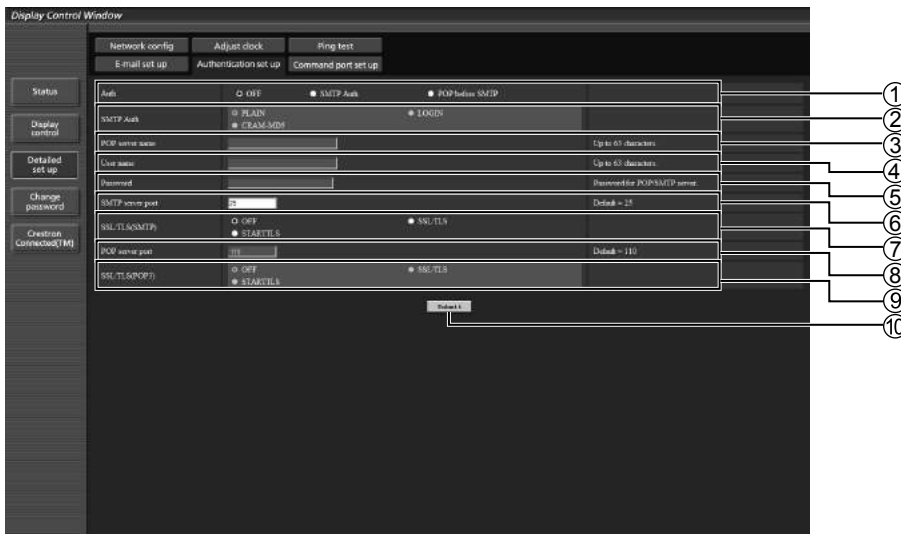

① “Auth”

Select the authentication method specified by your network administrator. (OFF, SMTP Auth, POP before SMTP)

② “SMTP Auth”

Set when the SMTP authentication is selected. (PLAIN, LOGIN, CRAM-MD5)

③ “POP server name”

Enter the POP server name. (Up to 63 single-byte characters)

Allowed characters:

Alphanumerics (A - Z, a - z, 0 - 9) Minus sign (-) and period (.)

④ “User name”

Enter the user name for the POP server or the SMTP server. (Up to 63 single-byte characters)

⑤ “Password”

Enter the password for the POP server or the SMTP server. (Up to 63 single-byte characters)

⑥ “SMTP server port”

Enter the port number of the SMTP server. (25, 465, 587, etc.)

⑦ “SSL/TLS(SMTP)” (SMTP encryption method)

Set the encryption method for SMTP communication.

⑧ “POP server port”

Enter the port number of the POP server. (25, 110, 465, 587, 995, etc.)

⑨ “SSL/TLS(POP)” (POP encryption method)

Set the encryption method for POP communication.

⑩ “Submit”

Update the settings.

Note

- This e-mail transmission function does not support communication with mail servers using the SSL protocol or STARTTLS.

Using Web Browser Control

Crestron Connected™ page

You can monitor or control the Display using Crestron Connected™.

When you click “Crestron Connected™”, the Crestron Connected™ operation page is displayed.

If Adobe Flash Player is not installed in your computer, or if the browser does not support Flash, this page does not appear. In this case, return to the previous page by clicking “Back” in the operation page.

Operation page



① Tools, Info, Help

Switches the pages for tools, information, help using the tab.

② POWER

Switches between on and off of the power.

③ VOL DOWN, AV MUTE, VOL UP

Sets the volume, AV mute. When the power of the Display is turned off, VOL DOWN, AV MUTE and VOL UP are not available.

④ Input Select

Sets the input selection. When the power of the Display is turned off, this operation is not available.

⑤ Operation buttons on the menu screen

Operates on the menu screen.

⑥ Image quality adjustments

Operate items related to image quality.

⑦ Back

Returns to the previous page.

Tools page

Click Tools on the operation page.

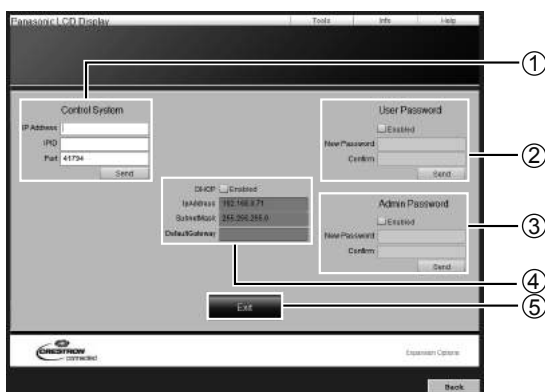

① Control system

Sets the information required for the communication with the controller that is connected to the Display.

② User Password

Sets the password for the user rights in the operation page of Crestron Connected™.

③ Admin Password

Sets the password for the administrator rights in the operation page of Crestron Connected™.

④ Network status

Displays the setting of LAN.

DHCP: Displays the value in the current setting.

IpAddress: Displays the value in the current setting.

SubnetMask: Displays the value in the current setting.

DefaultGateway: Displays the value in the current setting.

⑤ Exit

Return to the operation page.

Note

- When you monitor or control the Display using Crestron Connected™, set “Crestron Connected™” to “On” in the “Network settings” menu. (see page 22)

Using Web Browser Control

Info page

Click Info on the operation page.

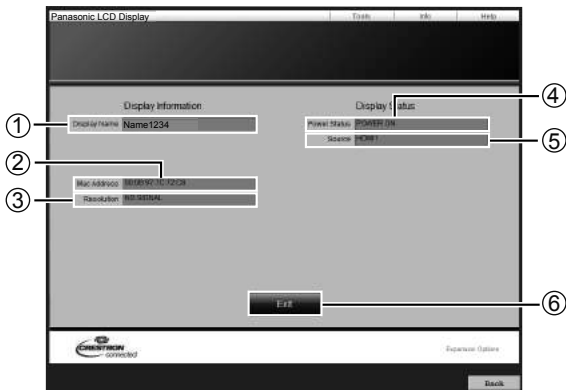

- ① **Display Name**
Displays the name of the Display.
- ② **Mac address**
Displays the MAC address.
- ③ **Resolution**
Displays the resolution of the Display.
- ④ **Power Status**
Displays the status of the power.
- ⑤ **Source**
Displays the selected video input.
- ⑥ **Exit**
Return the operation page.

Help page

Click Help on the operation page.

The Help Desk screen is displayed.



- ① **Help Desk**
Sends or receive messages to the administrator who uses Crestron Connected™.

PJLink™ Protocol

The network function of the unit conforms with PJLink™ class 1 and you can operate the following actions from your computer using PJLink™ protocol.

- Display setup
- Display status query

Supported commands

Commands to control the unit with PJLink™ protocol are shown in the table below.

Command	Control	Remark
POWR	Power control	Parameter 0 = Standby 1 = Power "On"
POWR?	Power status query	Parameter 0 = Standby 1 = Power "On"
INPT	Input switch	Parameter
INPT?	Input switch query	See the parameter for command INST?
AVMT	Shutter control	Parameter 10 = Picture On (picture mute deactivated), 11 = Picture Off (picture on mute) 20 = Audio On (audio mute deactivated), 21 = Audio Off (audio on mute) 30 = Shutter mode Off (picture and audio mute deactivated) 31 = Shutter mode On (picture and audio on mute)
AVMT?	Shutter control query	Parameter 11 = Picture Off (picture on mute) 21 = Audio Off (audio on mute) 30 = Shutter mode Off (picture and audio mute deactivated) 31 = Shutter mode On (picture and audio on mute)
ERST?	Error status query	Parameter First byte: Means fan error. 0 or 2. Second byte: 0 Third byte: 0 Fourth byte: 0 Fifth byte: 0 Sixth byte: Means other error. 0 or 2. Meaning of the 0 – 2 settings: 0 = Error is not detected, 2 = Error
LAMP?	Lamp status query	Not supported
INST?	Input switch list query	■INST ?Command %1INST=11 12 13 21 22 31 32 33 34 35 51 52 53 11: PC 12: SLOT INPUT or SLOT INPUT A 13: SLOT INPUT B 21: VIDEO 31: HDMI1 33: DVI-D 35: WHITEBOARD 52: Panasonic APPLICATION 22: COMPONENT 32: HDMI2 34: DIGITAL LINK 51: MIRRORING 53: MEMORY VIEWER
NAME?	Display name query	The name set for "Name change" in "Network settings" is returned.
INF1?	Manufacturer name query	Returns "Panasonic"
INF2?	Model name query	Returns "80BF1U" / "65BF1U" / "50BF1U" (U model) Returns "80BF1E" / "65BF1E" / "50BF1E" (E model) Returns "80BF1W" / "65BF1W" / "50BF1W" (W model)
INFO?	Other information query	Returns version number
CLSS?	Class information query	Returns "1"

PJLink™ security authentication

When using PJLink with security authorization, either of the password set for administrator privileges and the password set for user privileges with Web browser control can be used as the password for PJLink (See page 28). When using PJLink without security authorization, set use without the password for administrator privileges and the password for user privileges of Web browser control.

- PJLink™ is a pending trademark in Japan, the United States, and other countries and regions.
Concerning the specification of PJLink™, see the website of Japan Business Machine and Information System Industries Association (JBMIA) below:
<http://pjlink.jbmia.or.jp/english/index.html>

Trademark Credits

- HDMI, the HDMI Logo, and High-Definition Multimedia Interface are trademarks or registered trademarks of HDMI Licensing LLC in the United States and other countries.
- RoomView, Crestron RoomView are registered trademarks of Crestron Electronics, Inc. Crestron Connected™ and Fusion RV are trademarks of Crestron Electronics, Inc.
- Wi-Fi®, Wi-Fi Direct™ and Miracast™ are registered trademarks or trademarks of Wi-Fi Alliance.
- Windows, Windows Vista, Internet Explorer, PowerPoint, Microsoft Word and Microsoft Excel are registered trademarks or trademarks of Microsoft Corporation in the United States and other countries.
- Mac, Mac OS, OS X, iPad, iPhone, iPod touch and Safari are trademarks of Apple Inc., registered in the United States and other countries.
- iOS is a trademark and registered trademark of Cisco in the United States and other countries and is used under license.
- Android is a trademark of Google Inc.
- Adobe, Adobe Flash Player and Adobe Reader are trademarks or registered trademarks of Adobe Systems Inc. in the United States and/or other countries.
- Intel and the Intel logo are trademarks of Intel Corporation in the U.S. and/or other countries.

Even if no special notation has been made of company or product trademarks, these trademarks have been fully respected.

USA only: Disposal may be regulated in your community due to environmental considerations. For disposal or recycling information, please visit Panasonic website: <http://www.panasonic.com/environmental> or call 1-888-769-0149.

Customer's Record

The model number and serial number of this product can be found on its rear panel. You should note this serial number in the space provided below and retain this book, plus your purchase receipt, as a permanent record of your purchase to aid in identification in the event of theft or loss, and for Warranty Service purposes.

Model Number _____

Serial Number _____

For TH-80BF1U, TH-65BF1U and TH-50BF1U

Panasonic System Communications Company of North America

Unit of Panasonic Corporation of North America

Executive Office :

Two Riverfront Plaza, Newark, New Jersey 07102-5490

Panasonic Canada Inc.

5770 Ambler Drive
Mississauga, Ontario
L4W 2T3

For TH-80BF1E, TH-65BF1E and TH-50BF1E

Panasonic Testing Centre

Panasonic Service Europe, a division of Panasonic Marketing Europe GmbH

Winsbergring 15, 22525 Hamburg, F.R. Germany

Panasonic Corporation

Web Site : <http://panasonic.com>

© Panasonic Corporation 2016

M0416TS0 -PB