

Home Installation

COMPLETE LINE OF AUDIO VISUAL SOLUTIONS FOR RESIDENTIAL APPLICATIONS



205 Westwood Ave, Long Branch, NJ 07740
Phone: 866-94 BOARDS (26273) / (732)-222-1511
Fax: (732)-222-7088 | E-mail: sales@touchboards.com



UNIVERSAL ULTRA SLIM WALL MOUNTS

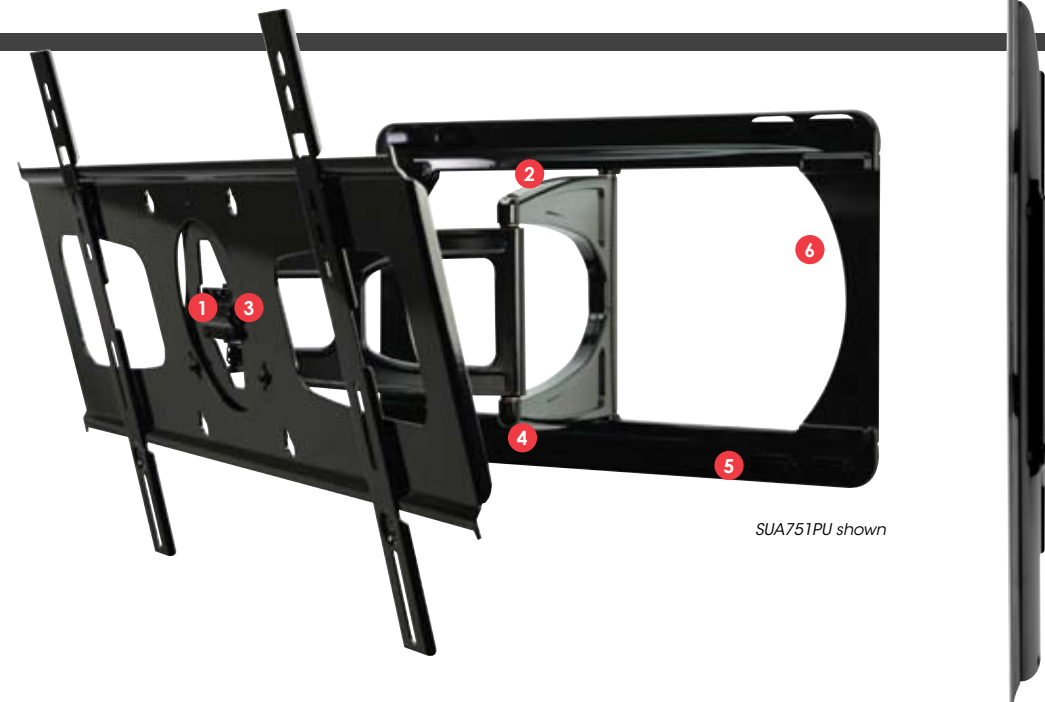
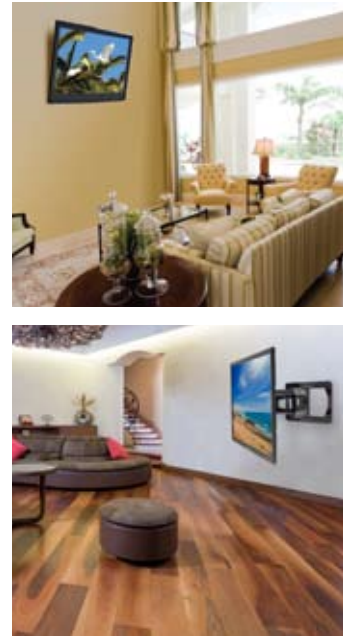

- 1. INNOVATIVE TILT**
+15°/-5° One-Touch™ tilt allows for ideal viewing angles without the use of tools
- 2. FULL EXTENSION**
Arm retracts to 1.34" (34mm) and extends up to 24.19" (615mm) from the wall
- 3. POST INSTALLATION LEVELING**
±5° of roll offers a simple way to horizontally level the display
- 4. 180° OF VIEWING POSSIBILITIES**
Up to ±90° full side-to-side motion for flat panel displays up to 55"
- 5. 1-2-3 INSTALLATION**
Pre-assembled design for a quick and easy install
- 6. OPEN ARCHITECTURE**
Open wall plate design increases cable management and power options

Designed for use with ultra thin displays that are less than 2" (50.8mm) deep

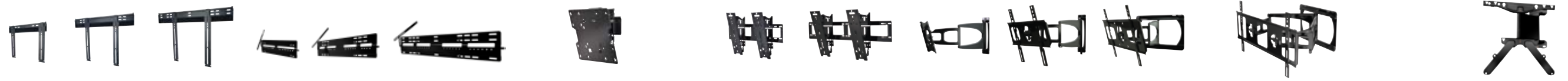

	SUF640P SUF650P SUF660P	SUF641 SUF651 SUF661	SUT632P	SUT645P SUT660P	SUA737 SUA746PU SUA751PU	SUA765PU	MM746PU
	UNIVERSAL ULTRA SLIM FLAT WALL MOUNTS COLOR: Gloss black	UNIVERSAL ULTRA SLIM FLAT WALL MOUNTS COLOR: Gloss black	UNIVERSAL ULTRA SLIM TILT WALL MOUNT COLOR: Gloss black	UNIVERSAL ULTRA SLIM TILT WALL MOUNTS COLOR: Gloss black	UNIVERSAL ULTRA SLIM ARTICULATING WALL MOUNTS COLOR: Gloss black	UNIVERSAL ULTRA SLIM ARTICULATING WALL MOUNT COLOR: Gloss black	ULTRA SLIM MOTORIZED WALL MOUNT COLOR: Black
	<ul style="list-style-type: none"> Universal display adapters easily hook onto wall plate for fast installation Patented industrial strength Velcro® latching system holds display in place against the wall plate preventing accidental bump-off or horizontal adjustment Mounts to wood studs, concrete, cinder block or metal studs (metal stud accessory required)* 	<ul style="list-style-type: none"> Ultra slim design holds displays only 0.19" (5mm) from the wall Locking arm holds flat panel in place and prevents accidental bump-offs and unwanted horizontal adjustments Theft-resistant security screw for locking arm Easy three-step installation: mount the wall plate, hang the flat panel display and insert the locking arm 	<ul style="list-style-type: none"> Display adapter easily hook onto wall plate for fast installation Display extends from the wall allowing for hands-free installation access to the back of the display Mounts to wood studs, concrete, cinder block or metal studs (metal stud accessory required)* 	<ul style="list-style-type: none"> Universal display adapters easily hook onto wall plate for fast installation Display extends from the wall allowing for hands-free installation access to the back of the display Open wall plate architecture increases cable management options Mounts to wood studs, concrete, cinder block or metal studs (metal stud accessory required)* 	<ul style="list-style-type: none"> One-Touch™ tilt mechanism allows adjustment of +15°/-5° without the use of tools Up to ±90° of side-to-side swivel ±5° of roll for post-installation display leveling 	<ul style="list-style-type: none"> Dual arm design enhances the stability of the articulating motion One-Touch™ tilt mechanism allows tilt adjustment of +15°/-5° without the use of tools Up to ±72.5° of side-to-side swivel ±1° of roll for post-installation display leveling 	<ul style="list-style-type: none"> Arm retracts to 1.375" (35mm) and extends up to 8.375" (213mm) from the wall Pivots up to 40° (20° in each direction) Remote control operation with preset positions Automatic display centering and wall detection Near silent (25dB) motor operation
	* ACC215 for SUF640P ACC415 for SUF650P ACC415/ ACC615 for SUF660P	ACC952 (Security Accessory) *in 25mm increments	*ACC215	*ACC415 for SUT645P ACC615 for SUT660P			
Accessories	page 24						
Display size	SUF640P: 23"-46" SUF650P: 32"-56" SUF660P: 37"-65"	SUF641: 23"-46" SUF651: 32"-56" SUF661: 37"-65"	22"-40"	SUT645P: 32"-46" SUT660P: 37"-60"	SUA737: 32"-46" SUA746PU: 32"-46" SUA751PU: 37"-55"	42"-65"	23"-46"
VESA® pattern	SUF640P: up to 400 x 400mm SUF650P: up to 600 x 400mm SUF660P: up to 800 x 400mm	SUF641: 200, 400mm SUF651: 200, 400, 600mm SUF661: 200, 400, 600 and 800mm	75, 100, 200 x 100 and 200 x 200mm	SUT645P: up to 600 x 400mm SUT660P: up to 800 x 400mm	SUA737: 200 x 100, 200 x 200mm SUA746PU: up to 400 x 400mm SUA751PU: up to 800 x 400mm	up to 800 x 400mm	200 x 200, 300 x 300 & 400 x 400mm
Adjustable mounting pattern (W x H)	SUF640P: 450 x 402mm (17.73" x 15.82") SUF650P: 742 x 449mm (29.23" x 17.67") SUF660P: 825 x 449mm (32.48" x 17.67")	SUF641: 75-425mm* SUF651: 100-400mm & 550-700mm* SUF661: 100-400mm & 550-800mm*	—	SUT645P: 603 x 408mm (23.75" x 16.06") SUT660P: 801 x 408mm (31.53" x 16.06")	SUA746PU: 450 x 402mm (17.73" x 15.81") SUA751PU: 811 x 464mm (31.92" x 18.25")	854 x 439mm (33.60" x 17.27")	—
Distance from the wall	0.33" (8mm)	0.19" (5mm)	0.68"-3.88" (17-98mm)	0.68"-5.88" (17-149mm)	SUA737: 1.29"-24.17" (33-614mm) SUA746PU: 1.27"-24.15" (32-613mm) SUA751PU: 1.34"-24.19" (34-615mm)	1.24"-23.35" (32-591mm)	1.375"-8.375" (35-213mm)
Tilt swivel roll	—	—	+17.5°/-5° — —	+17.5°/-5° — —	+15°/-5° ±90° ±5°	+15°/-5° ±72.5° ±1°	— ±20° —
Horizontal display adjustment	SUF640P: up to 6" (152mm) SUF650P/660P: up to 8" (203mm)	Yes	—	up to 8" (203mm)	SUA746PU: up to 9" (229mm) SUA751PU: up to 24" (610mm)	Up to 29" (737mm)	—
Max load	150lb (68kg)	150lb (68kg)	60lb (27kg)	100lb (45kg)	SUA737: 60lb (27kg) SUA746PU: 60lb (27kg) SUA751PU: 100lb (45kg)	100lb (45kg)	110lb (50kg)
Listings	UL, CE, RoHS, USA	UL, CE, RoHS, USA	UL, CE, RoHS, USA	UL, CE, RoHS, USA	SUA737/SUA746PU: UL, CE, RoHS, USA SUA751PU: UL, CE, RoHS, USA	RoHS, USA	—

UNIVERSAL FLAT, TILT & ARTICULATING WALL MOUNTS

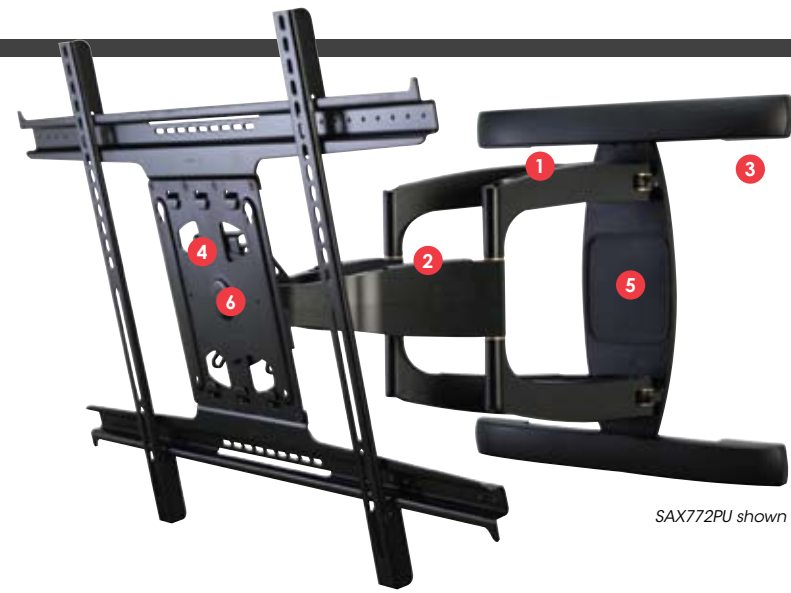

SAX772PU shown

- CLEAN AND CONCEALED INSTALLATION**
Internal cable management system keeps cables concealed and organized
- VIEWING FLEXIBILITY**
Arm extends up to 26.54" (674mm) from the wall for SAX762PU and SAX772PU
- CLEAN APPEARANCE**
Open wall plate design for installation flexibility
- POST-INSTALLATION LEVELING**
±5° of roll
- WALL PLATE KNOCKOUT**
Increased cable and power management options with optional in-wall accessory for powering flat panel display and routing low-voltage cables through the wall
- LANDSCAPE TO PORTRAIT ROLL**
Rotate the flat panel 90° without removing the display



SMARTMOUNT XT

INTEGRATED PARTNER PROGRAM

Contact your Peerless-AV sales representative for more information

Accessories page 24

	SFX645(P)	SFX650(P)	SFX660(P)	STX645(P)(L)	STX650(P)(L)	STX660(P)(L)	SAX755PU	SAX762PU	SAX772PU
Display size	32"-46"	32"-55"	46"-70"	32"-46"	32"-55"	46"-70"	40"-52"	40"-63"	50"-71"
VESA® pattern	up to 400 x 400mm	up to 600 x 400mm	up to 800 x 400mm	up to 400 x 400mm	up to 600 x 400mm	up to 800 x 400mm	up to 600 x 400mm	up to 600 x 400mm	up to 800 x 600mm
Adjustable mounting pattern (W x H)	up to 452 x 433mm (17.79"W x 17.04"H)	up to 744 x 433mm (29.29"W x 17.04"H)	up to 827 x 433mm (32.54"W x 17.04"H)	up to 431 x 433mm (16.96"W x 17.04"H)	up to 723 x 433mm (28.46"W x 17.04"H)	up to 805 x 433mm (31.71"W x 17.04"H)	Up to 661 x 449mm (26.03"W x 17.69"H)	Up to 661 x 449mm (26.03"W x 17.69"H)	Up to 813 x 607mm (32.03"W x 23.91"H)
Distance from the wall	1.21" (31mm)	1.21" (31mm)	1.21" (31mm)	1.69" (43mm)	1.69" (43mm)	1.69" (43mm)	2.54"-26.41" (65-671mm)	2.60"-26.54" (66-674mm)	2.60"-26.54" (66-674mm)
Tilt swivel roll	—	—	—	+15°/-5° One-Touch™ tilt with IncreLok™ tilt lock	+15°/-5° One-Touch™ tilt with IncreLok™ tilt lock	+15°/-5° One-Touch™ tilt with IncreLok™ tilt lock	+15°/-5° One-Touch™ tilt ±90° 90°	+15°/-5° One-Touch™ tilt ±90° 90°	+15°/-5° One-Touch™ tilt ±90° 90°
Horizontal display adjustment	Up to 13" (330mm)	Up to 25" (635mm)	Up to 24" (610mm)	Up to 13" (330mm)	Up to 24" (610mm)	Up to 23" (584mm)	up to 18" (461mm)	up to 18" (461mm)	up to 24" (613mm)
Landscape to portrait	—	—	—	—	—	—	Yes	Yes	Yes
Max load	80lb (36kg)	120lb (54kg)	150lb (68kg)	80lb (36kg)	120lb (54kg)	150lb (68kg)	80lb (36kg)	110lb (50kg)	135lb (61kg)
Listings	UL RoHS USA OSHPD Approval Pending			UL RoHS USA OSHPD Approval Pending			UL RoHS USA OSHPD Approval Pending		

UNIVERSAL FLAT WALL MOUNTS

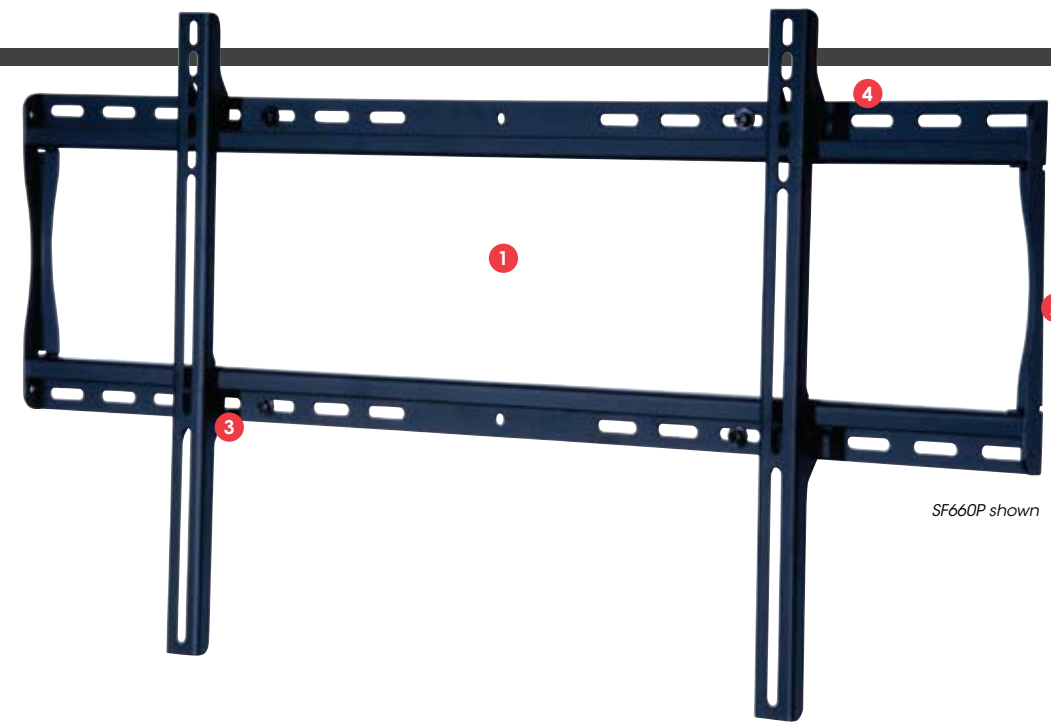
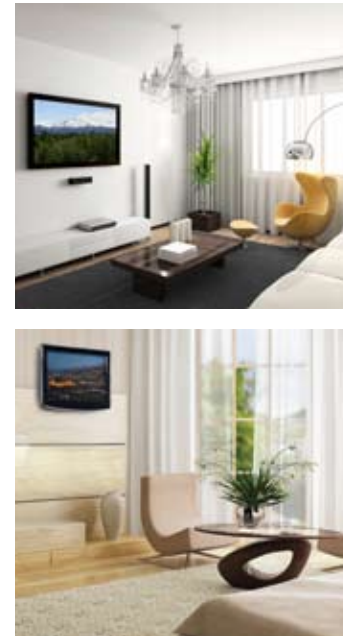

- 1. OPEN ARCHITECTURE**
Offers outstanding flexibility in mount placement by easily accommodating cables, cords, and electrical gang boxes
- 2. FINISHED END PANEL**
Unique end panel design creates a clean appearance by hiding screws from view
- 3. SECUREMENT SCREWS**
Assures the display is secured to the wall plate preventing the display from accidentally being dislodged
- 4. LOW-PROFILE DESIGN**
Keeps display close to the wall for a discreet installation



SmartMount®

Accessories page 24

	SF630P(S)	SF632P(S)	SF640P(S)	SF650P(S)	SF660P(S)	SF670P(S)	SF680P(S)
	UNIVERSAL FLAT WALL MOUNT COLOR: Black or silver	UNIVERSAL FLAT WALL MOUNT COLOR: Black or silver	UNIVERSAL FLAT WALL MOUNT COLOR: Black or silver	UNIVERSAL FLAT WALL MOUNT COLOR: Black or silver	UNIVERSAL FLAT WALL MOUNT COLOR: Black or silver	UNIVERSAL FLAT WALL MOUNT COLOR: Black or silver	UNIVERSAL FLAT WALL MOUNT COLOR: Black or silver
	<ul style="list-style-type: none"> Display adapter plate simply hooks onto the wall plate for quick and easy installation Includes hardware for installation to wood stud, concrete, cinder block and metal stud (metal stud accessory required)* 	<ul style="list-style-type: none"> Display adapter plate simply hooks onto the wall plate for quick and easy installation Includes hardware for installation to wood stud, concrete, cinder block and metal stud (metal stud accessory required)* 	<ul style="list-style-type: none"> Open wall plate design allows for total wall access, increasing electrical access and cable management options Universal adapters easily hook onto wall plate for fast installation Includes hardware for installation to wood stud, concrete, cinder block and metal stud (metal stud accessory required)* Comes with Peerless-AV fastener pack with all necessary display attachment hardware 	<ul style="list-style-type: none"> Open wall plate design allows for total wall access, increasing electrical access and cable management options Universal adapters easily hook onto wall plate for fast installation Includes hardware for installation to wood stud, concrete, cinder block and metal stud (metal stud accessory required)* Comes with Peerless-AV fastener pack with all necessary display attachment hardware 	<ul style="list-style-type: none"> Open wall plate design allows for total wall access, increasing electrical access and cable management options Universal adapters easily hook onto wall plate for fast installation Includes hardware for installation to wood stud, concrete, cinder block and metal stud (metal stud accessory required)* Comes with Peerless-AV fastener pack with all necessary display attachment hardware 	<ul style="list-style-type: none"> Universal adapters easily hook onto wall plate for fast installation Easy-Glide™ design ensures display is securely attached to wall plate Mounts to wood studs, concrete, cinder block or metal studs (metal stud accessory required)* Comes with Peerless-AV fastener pack with all necessary display attachment hardware 	<ul style="list-style-type: none"> Universal adapters easily hook onto wall plate for fast installation Easy-Glide™ design ensures display is securely attached to wall plate Mounts to wood studs, concrete, cinder block or metal studs (metal stud accessory required)* Comes with Peerless-AV fastener pack with all necessary display attachment hardware
	*ACC215	*ACC215	*ACC415	*ACC415	*ACC415	*ACC415	*ACC615
Display size	10"-24"	22"-40"	23"-46"	32"-56"	37"-63"	42"-71"	61"-102"
VESA® pattern	75/100mm <i>Additional adapter plates also available</i>	75,100, 200 x 100 and 200 x 200mm <i>Additional adapter plates also available</i>	up to 400 x 300mm	up to 600 x 400mm	up to 800 x 400mm	up to 800 x 400mm	up to 1000 x 600mm
Adjustable mounting pattern (W x H)	—	—	450 x 329mm (17.73" x 12.94")	742 x 433mm (29.23" x 17.05")	825 x 433mm (32.48" x 17.05")	908 x 503mm (35.75" x 19.79")	1111 x 745mm (43.75" x 29.31")
Distance from the wall	.96" (24mm)	1.02" (26mm)	1.2" (30mm)	1.7" (43mm)	1.25" (32mm)	1.73" (44mm)	1.83" (46mm)
Horizontal display adjustment	—	—	up to 6" (152mm)	up to 8" (203mm)	up to 8" (203mm)	up to 12" (304mm)	up to 12" (304mm)
Max load	80lb (36kg)	115lb (52kg)	150lb (68kg)	175lb (79kg)	200lb (90kg)	250lb (113kg)	350lb (158kg)
Listings							

UNIVERSAL TILT WALL MOUNTS

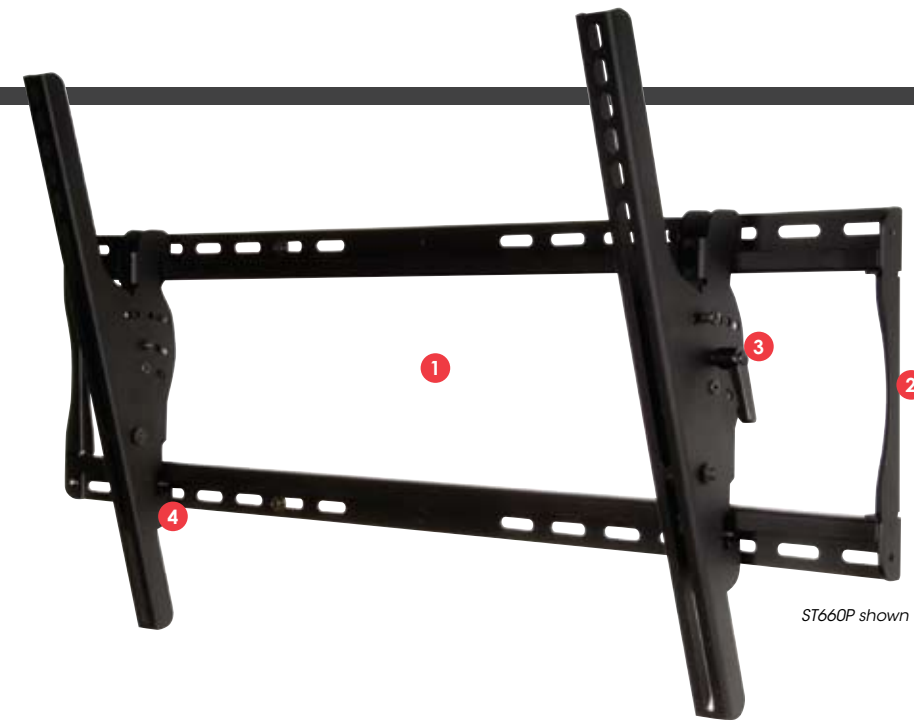

ST660P shown

- 1. OPEN ARCHITECTURE**
Offers outstanding flexibility in mount placement by easily accommodating cables, cords, and electrical gang boxes
- 2. FINISHED END PANEL**
Unique end panel design creates a clean appearance by hiding screws from view
- 3. EASY TILT ADJUSTMENT**
The display is supported by pre-tensioned tilt adapters that allow for +15°/-5° tilt adjustment in one easy motion
- 4. SECUREMENT SCREWS**
Assures the display is secured to the wall plate preventing the display from accidentally being dislodged



SmartMount®

Accessories page 24

	ST630P(S)	ST632P(S)	ST635P(S)	ST640P(S)	ST650P(S)	ST660P(S)	ST670P(S)	ST680P(S)
	UNIVERSAL TILT WALL MOUNT COLOR: Black or silver	UNIVERSAL TILT WALL MOUNT COLOR: Black or silver	UNIVERSAL TILT WALL MOUNT COLOR: Black or silver	UNIVERSAL TILT WALL MOUNT COLOR: Black or silver	UNIVERSAL TILT WALL MOUNT COLOR: Black or silver	UNIVERSAL TILT WALL MOUNT COLOR: Black or silver	UNIVERSAL TILT WALL MOUNT COLOR: Black or silver	UNIVERSAL TILT WALL MOUNT COLOR: Black or silver
	<ul style="list-style-type: none"> Display adapter plate simply hooks onto the wall plate for quick and easy installation Includes hardware for installation to wood stud, concrete, cinder block and metal stud (metal stud accessory required)* 	<ul style="list-style-type: none"> Display adapter plate simply hooks onto the wall plate for quick and easy installation Includes hardware for installation to wood stud, concrete, cinder block and metal stud (metal stud accessory required)* 	<ul style="list-style-type: none"> Open wall plate design allows for total wall access, increasing electrical access and cable management options Universal adapters easily hook onto wall plate for fast installation Includes hardware for installation to wood stud, concrete, cinder block and metal stud (metal stud accessory required)* Comes with Peerless-AV fastener pack with all necessary display attachment hardware 	<ul style="list-style-type: none"> Open wall plate design allows for total wall access, increasing electrical access and cable management options Universal adapters easily hook onto wall plate for fast installation Includes hardware for installation to wood stud, concrete, cinder block and metal stud (metal stud accessory required)* Comes with Peerless-AV fastener pack with all necessary display attachment hardware 	<ul style="list-style-type: none"> Open wall plate design allows for total wall access, increasing electrical access and cable management options Universal adapters easily hook onto wall plate for fast installation Includes hardware for installation to wood stud, concrete, cinder block and metal stud (metal stud accessory required)* Comes with Peerless-AV fastener pack with all necessary display attachment hardware 	<ul style="list-style-type: none"> Open wall plate design allows for total wall access, increasing electrical access and cable management options Universal adapters easily hook onto wall plate for fast installation Includes hardware for installation to wood stud, concrete, cinder block and metal stud (metal stud accessory required)* Comes with Peerless-AV fastener pack with all necessary display attachment hardware 	<ul style="list-style-type: none"> Universal adapters easily hook onto wall plate for fast installation Easy-Glide™ design ensures display is securely attached to wall plate Mounts to wood studs, concrete, cinder block or metal studs (metal stud accessory required)* Comes with Peerless-AV fastener pack with all necessary display attachment hardware 	<ul style="list-style-type: none"> Universal adapters easily hook onto wall plate for fast installation Easy-Glide™ design ensures display is securely attached to wall plate Mounts to wood studs, concrete, cinder block or metal studs (metal stud accessory required)* Comes with Peerless-AV fastener pack with all necessary display attachment hardware
	*ACC215	*ACC215	*ACC415	*ACC415	*ACC415	*ACC415	*ACC615	*ACC615
Display size	10"-24"	22"-40"	13"-37"	23"-46"	32"-56"	37"-63"	42"-71"	61"-102"
VESA® pattern	75/100mm <small>Additional adapter plates also available</small>	75,100, 200 x 100 and 200 x 200mm <small>Additional adapter plates also available</small>	75,100, 200 x 100 and 200 x 200mm	up to 400 x 300mm	up to 600 x 400mm	up to 800 x 400mm	up to 800 x 400mm	up to 1000 x 600mm
Adjustable mounting pattern (W x H)	—	—	245 x 241mm (9.65" x 9.48")	458 x 329mm (18.02" x 12.94")	750 x 449mm (29.52" x 17.67")	832 x 449mm (32.75" x 17.67")	915 x 503mm (36.04" x 19.8")	1119 x 745mm (44.04" x 29.31")
Distance from the wall	1.58"-2.23" (40-57mm)	1.66"-2.91" (42-74mm)	2.63"-4.38" (67-111mm)	2.63"-4.87" (67-124mm)	2.63"-5.71" (67-145mm)	2.63"-5.71" (67-145mm)	3.04"-6.41" (77-163mm)	3.04"-8.77" (77-223mm)
Tilt	+15°/-5°	+15°/-5°	+15°/-5°	+15°/-5°	+15°/-5°	+15°/-5°	+15°/-5°	+15°/-5°
IncreLok™	—	—	-5°, 0°, 5°, 10°, 15°	-5°, 0°, 5°, 10°, 15°	-5°, 0°, 5°, 10°, 15°	-5°, 0°, 5°, 10°, 15°	-5°, 0°, 5°, 10°, 15°	-5°, 0°, 5°, 10°, 15°
Horizontal display adjustment	—	—	—	up to 6" (152mm)	up to 8" (203mm)	up to 8" (203mm)	up to 12" (304mm)	up to 12" (304mm)
Max load	80lb (36kg)	115lb (52kg)	125lb (56kg)	150lb (68kg)	175lb (79kg)	200 lb (90kg)	250lb (113kg)	350lb (158kg)
Listings	UL, CE, RoHS, US, OSHPD Approval Pending			UL, CE, RoHS, US, osdp		UL, CE, RoHS, US, osdp with max load 200lb (90kg)		

IN-WALL MOUNTS

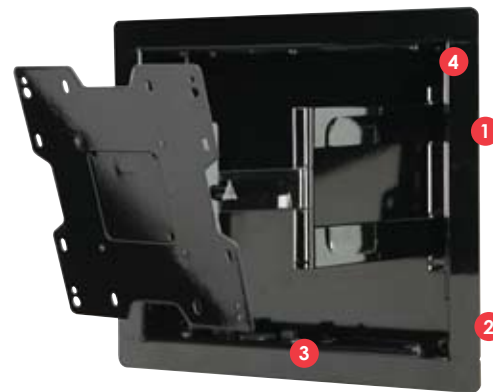

IM740P shown

- 1. DISCREET DESIGN**
In retracted position, .08" (2 mm) from the wall, the mount's profile becomes virtually invisible
- 2. SIMPLIFIED INSTALLATION**
Stud locating tabs self-adjust to create a snug fit for variation in stud spacing
- 3. EASE OF CONNECTIVITY**
Multiple removable gang box and cable management access plates make it easy to run signal and power to the mounted display
- 4. IDEAL DISPLAY POSITIONING**
Three height adjustment points in box making it easy to position display at the desired height



IB40(-S)(-W)	IM740P(-S)	IM760P(U)(-S)
IN-WALL BOX COLOR: Gloss black, gloss silver or white	IN-WALL MOUNT COLOR: Gloss black or gloss silver	IN-WALL MOUNT COLOR: Gloss black or gloss silver
<ul style="list-style-type: none"> Compatible with PA730, PA740, PP730 and PP740 models Three height adjustment points in box to set display at desired vertical position Installs between 16" (406mm) wood stud centers Stud-locating tabs adjust 1/4" (6mm) left or right to accommodate stud spacing Removable gang box and cable management access plates make installation easy Includes hardware for installation to wood stud 	<ul style="list-style-type: none"> Includes PA740 mount for up to 40" flat panel displays Three height adjustment points in box to set display at desired vertical position Installs between 16" (406mm) wood stud centers Stud-locating tabs adjust 1/4" (6mm) left or right to accommodate stud spacing Removable gang box and cable management access plates make installation easy Includes hardware for installation to wood stud 	<ul style="list-style-type: none"> Decorative trim ring included for a clean look Installs between 16" (406mm) wood stud centers Stud-locating tabs adjust 1/4" (6mm) left or right to accommodate stud spacing Removable gang box and cable management access plates make installation easy Includes hardware for installation to wood stud

Accessories page 24

OUTDOOR MOUNTS

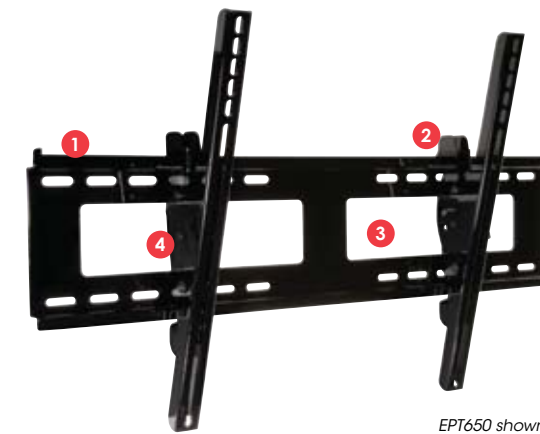

EPT650 shown

- 1. EASY DISPLAY CENTERING**
8" (203mm) of horizontal adjustment for ideal display position
- 2. SIMPLE SET-UP**
Hook-and-hang design helps attach enclosure to mount and hold the weight load while fine-tuning adjustments
- 3. EASY ACCESS**
Open wall plate design provides easy access and pass through of cables to internal and external power and content sources
- 4. VIEWING ANGLE FLEXIBILITY**
Incremental tilt settings enable the best viewing angle



EPT650(-S)	ESA746PU(-S)	ESA763PU
UNIVERSAL OUTDOOR TILT WALL MOUNT COLOR: Black or stone gray	CORROSION RESISTANT ARTICULATING MOUNT COLOR: Black or stone gray	CORROSION RESISTANT ARTICULATING MOUNT COLOR: Black
<ul style="list-style-type: none"> Constructed from corrosion resistant materials, primed with an E-coat and comes with stainless steel hardware Double stud mounting with 16", 20" and 24" stud placements Security hardware and optional lock down channels to add a pad lock for additional security Wood, concrete or cinder block mounting hardware included 	<ul style="list-style-type: none"> Constructed from corrosion resistant materials, primed with an E-coat and comes with stainless steel hardware Cable management to conceal cables and wires 20.92" (531mm) arm extension; collapsed 4.34" (110mm) from the wall Display side and wall side security hardware included Wood, concrete or cinder block mounting hardware included 	<ul style="list-style-type: none"> Constructed from corrosion resistant materials, primed with an E-coat and comes with stainless steel hardware Cable management to conceal cables and wires 27.55" (700mm) arm extension; collapsed 4.43" (113mm) from the wall Display side and wall side security hardware included Wood, concrete or cinder block mounting hardware included

Accessories page 24

Display size	up to 40"	22"-40"	32"-71" <i>IM760P models</i> 32"-65" <i>IM760PU models</i>
VESA® pattern	Refer to compatible Peerless-AV wall mount	75, 100, 200 x 100 and 200 x 200mm <i>Additional adapter plates also available</i>	100, 200 x 100 and 200 x 200mm <i>IM760P models</i>
Adjustable mounting pattern (W x H)	—	—	730 x 433mm (28.75" x 17.05") <i>IM760PU models</i>
Distance from the wall	0.08" (2mm)	0.08"-12.05" (2-306mm)	2.14"-19.88" (54-505mm)
Tilt swivel roll	Refer to compatible Peerless-AV wall mount	+15/-5° ±45° ±5°	+10/-5° ±45° ±7°
Landscape to portrait	—	—	Yes
Max load	80lb (36kg)	80lb (36kg)	200lb (90kg)
Listings	RoHS MADE IN USA	UL RoHS MADE IN USA	UL RoHS MADE IN USA

Display size	32"-55"	26"-46"	37"-63"
VESA® pattern	up to 600 x 400mm	up to 400 x 400mm	up to 600 x 400mm
Adjustable mounting pattern (W x H)	738 x 449mm (29.04"W x 17.67"H)	432 x 408mm (17.00"W x 16.06"H)	687 x 439mm (27.06"W x 17.29"H)
Distance from the wall	2.58" (66mm)	4.34"-20.92" (110-531mm)	4.43"-27.55" (113-700mm)
Tilt swivel roll	+15°/-5°	+15°/-5° ±90° ±5°	+15°/-5° ±90° ±5°
Horizontal display adjustment	8" (203mm)	—	up to 4.5" (114mm)
Landscape to portrait	—	—	Yes
Max load	175lb (79kg)	80lb (36kg)	200lb (91kg)
Listings	RoHS MADE IN USA os hpd	RoHS MADE IN USA os hpd	RoHS MADE IN USA os hpd

UNIVERSAL CEILING MOUNTS



PC930B shown

- 1. ACHIEVE IDEAL PLACEMENT**
Adjustable height ranges for optimal display placement
- 2. CLEAN LOOK**
Internal cable management channels conceal signal and power cables for a clean installation
- 3. ADDED PEACE-OF-MIND**
Built-in safety catch ensures proper use of height adjustment feature



LCC-18-(C)(S) | LCC-36-(C)(S)

CEILING MOUNT

COLOR: Black or silver

- Adjustable height ranges in 1" (25mm) increments
- Display can be mounted in standard position or face-down
- Optional cable management covers ("C" models only)
- .75" extension pipe for low profile appearance and includes adapter to 1.5" NPT pipe

PLCM-UNL-CP

CEILING MOUNT

COLOR: Black

- 0°-20° adjustable tilt and 360° swivel
- Integrated cable management for clean look
- Uses standard 1.5" NPT pipe
- Mount display vertical or horizontal
- Simple hook and hand installation

PC930A/B/C(-S)(-W) PC932A/B/C(-S)(-W)

CEILING MOUNT

COLOR: Black, silver or white

- Comes in three adjustable height ranges for optimal viewing height
- Internal cable management allows cables to be routed through extension column for a clean, clutter-free installation
- Safety catch design in extension channel
- Swivel adjustment within ceiling plate

Accessories page 24

FLOOR & TABLETOP STANDS

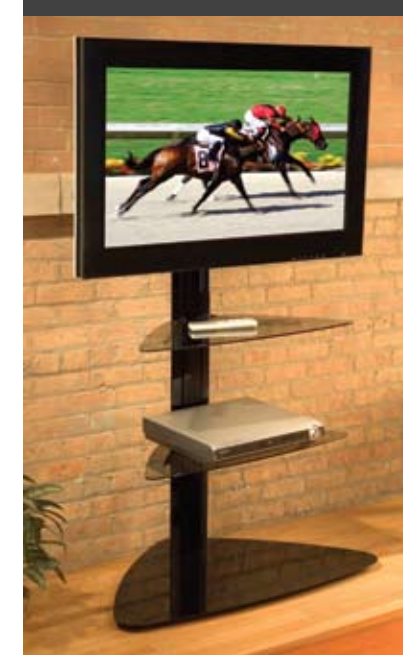

SS550P shown

- 1. NO WALL, NO PROBLEM!**
Complementing the décor of any environment, this stand is the ideal addition when mounting to a wall is not an option
- 2. SIMPLE ADJUSTMENT**
Continuous vertical adjustment makes it easy to position the display and AV shelving to its ideal height
- 3. SPACE-SAVING CORNER PLACEMENT**
Triangle base allows for snug corner placement
- 4. DURABLE COMPONENT SHELVING**
Supports the heaviest of AV components, up to 50lb (22kg) per shelf



FPZ-646 | FPZ-655

FLOOR STAND

COLOR: Black

- 8" of display height adjustment in 2" increments
- Set the perfect viewing angle with 360° swivel
- Built-in cable management provides a clean look in any application
- 8mm tempered glass shelf with height adjustability along the height of the stand
- Lightweight and easy to assemble

PLT-BLK

TABLETOP STAND

COLOR: Black

- Base can rest in a fixed position or swivel 360°
- Adjustable 10° forward and 5° backward tilt at the turn of a knob
- Internal cord management to keep cables out of the way
- Felt bottom protects tabletop surfaces

SS550P(-S) | SGLB01 | SGLS01

FLOOR STAND

COLOR: Gloss black or silver

- Provides tilt and vertical adjustment features to achieve the ideal viewing angle
- Incremental tilt of -2°, 0° and +5° to achieve the ideal display viewing angle
- Vertical display adjustment feature for optimal viewing height
- Internal cable management neatly hides all cords and cables for a clean, clutter-free look
- Adjustable glass shelving for AV components and accessories hold up to 50lb

Accessories page 24

- Display size
- VESA® pattern
- Adjustable mounting pattern (W x H)
- Distance from the ceiling
- Tilt | swivel
- Increlock™
- Landscape to portrait
- Max load
- Listings

Display size	13"-29"	32"-65"	15"-24" <small>PC930A/B/C models</small>	15"-40" <small>PC932A/B/C models</small>
VESA® pattern	75/100mm <small>Additional non-VESA® adapter plates also available</small>	up to 600 x 400mm	75/100mm <small>PC930A/B/C models</small>	200 x 100 and 200 x 200mm <small>PC932A/B/C models</small>
Adjustable mounting pattern (W x H)	—	731 x 433mm (28.76" x 17.05")	—	—
Distance from the ceiling	19.3"-32.3" (491-822mm) <small>LCC-18-(C)(S)</small>	36.8"-49.8" (936-1266mm) <small>LCC-36-(C)(S)</small>	33.34" (847mm)	9.8"-13.9" (249-353mm) <small>PC930A/932A</small>
Tilt swivel	+20°/-5° 360°	+20° 360°	+15°/-5° 360°	13.7"-21.8" (350-556mm) <small>PC930B/932B</small>
Increlock™	—	—	-5°, 0°, 5°, 10°, 15°	20.2"-34.0" (514-864mm) <small>PC930C/932C</small>
Landscape to portrait	Yes	—	Yes	—
Max load	40lb (18kg)	200lb (90kg)	50lb (22kg)	80lb (36kg)
Listings				

- Display size
- VESA® pattern
- Adjustable mounting pattern (W x H)
- Tilt | swivel | roll
- Horizontal display adjustment
- Landscape to portrait
- Max load
- Listings

Display size	32"-46" <small>FPZ-646</small>	37"-55" <small>FPZ-655</small>	30"-50"	32"-65"
VESA® pattern	up to 400 x 300mm <small>FPZ-646</small>	up to 600 x 400mm <small>FPZ-655</small>	—	up to 600 x 400mm
Adjustable mounting pattern (W x H)	438 x 329mm (17.25" x 12.94") <small>FPZ-646</small>	730 x 433mm (28.75" x 17.04") <small>FPZ-655</small>	PLP-UNV sold separately	729 x 433mm (28.75" x 17.05")
Tilt swivel roll	— 360° —	+10°/-5° 360° —	—	+5°/-2° — —
Horizontal display adjustment	8"	with PLP-UNV	—	Yes
Landscape to portrait	Yes	—	—	Yes
Max load	150lb (68kg) <small>Display: 100lb (45kg) Shelf: 50lb (22kg)</small>	150lb (68kg)	—	250lb (113kg) <small>Display: 150lb (68kg) Shelf: 50lb (22kg)</small>
Listings				

UNIVERSAL TABLET MOUNTS

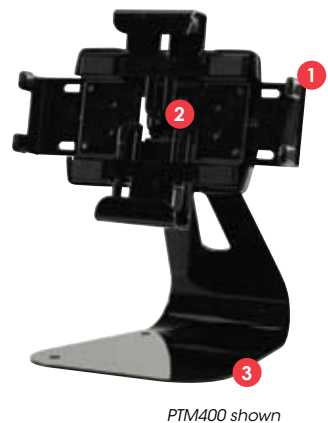

PTM400 shown

- 1. UNIVERSAL**
Adjustable height and width, providing a universal fit for most tablets
- 2. VERSATILE**
±30° of One-Touch™ tilt and swivel and 360° of roll to achieve virtually any viewing angle
- 3. SLEEK AND STYLISH**
Two color options available for coordinating with tablet aesthetics
- 4. SECURE**
Option to place on desk or secure down with theft resistant security screws



PTM200(-S)



PTM400(S)(-W)

UNIVERSAL TABLET CRADLE
COLOR: Black or silver

- Adjustable height and width, providing a universal fit for most tablets
- Stylish cover for improved aesthetics
- Easily attaches to any 75 x 75mm VESA® mount
- Two color options available for coordinating with tablet aesthetics

UNIVERSAL DESKTOP TABLET MOUNT
COLOR: Black or white

- Adjustable height and width, providing a universal fit for most tablets
- Stylish cover for improved aesthetics
- ±30° of One-Touch™ tilt and swivel
- 360° of roll for versatile placement options
- Option to place on desk or secure down with theft-resistant security screws
- Provides wide range of adjustment for ideal image alignment
- Two color options available for coordinating with tablet aesthetics

Tablet size	7.68" to 13.75" (195-349mm) <small>* tablet must be between 0.3"-0.75" deep</small>	7.68" to 13.75" (195-349mm) <small>* tablet must be between 0.3"-0.75" deep</small>
VESA® pattern	75 x 75mm	—
Distance from the wall	—	—
Tilt swivel roll	—	±30° One-Touch™ tilt ±30° 360°
Landscape to portrait	—	Yes
Max load	5lb (2.27kg)	5lb (2.27kg)

UNIVERSAL PROJECTOR MOUNTS



PRG-EXA shown

- 1. ACHIEVE IDEAL PLACEMENT**
Continuous channel design for uninterrupted drop length or wall extension adjustments
- 2. ADDED PEACE-OF-MIND**
Incorporates safety catch design into extension channels to ensure user and equipment safety
- 3. PIN-POINT IMAGE ALIGNMENT**
Includes PRG Precision Gear Projector Mount that provides pin-point image alignment with its unique gearing system by simply adjusting two knobs
- 4. UNIVERSAL COMPATIBILITY**
Includes the Spider® Universal Adapter Plate which extends up to 17.63" (448mm) to fit most projector models



PPA/PPB/PPC(-S)(-W)



PRS-EXA/EXB/EXC(-S)(-W)



PRG-EXA/EXB/EXC(-S)(-W)

ADJUSTABLE CEILING/WALL PROJECTOR MOUNT
COLOR: Black, silver or white

- Continuous channel design for uninterrupted drop length or wall extension adjustments
- Safety catch designed into extension to ensure user and equipment safety
- Mounts to ceiling or wall (depending on model) with included wall mount interface
- Provides wide range of adjustment for ideal image alignment
- Internal cable management conceals cables and cords for a clean look

PRG ADJUSTABLE PROJECTOR CEILING/WALL MOUNT KIT
COLOR: Black, silver or white

- Includes PRS Series Projector Mount
- Continuous channel design for uninterrupted drop length or wall extension adjustments
- Safety catch designed into extension to ensure user and equipment safety
- Mounts to ceiling or wall (depending on model) with included wall mount interface
- Internal cable management conceals cables and cords for a clean look
- Accessories available

PRS ADJUSTABLE PROJECTOR CEILING/WALL MOUNT KIT
COLOR: Black, silver or white

- Includes PRG Series Projector Mount
- Continuous channel design for uninterrupted drop length or wall extension adjustments
- Safety catch designed into extension to ensure user and equipment safety
- Mounts to ceiling or wall (depending on model) with included wall mount interface
- Internal cable management conceals cables and cords for a clean look
- Accessories available

Accessories page 24

Adjustable mounting pattern	up to 17.63" (448mm)	up to 17.63" (448mm)	up to 17.63" (448mm)
Distance from the ceiling	PPA: 11.5"-15.6" (293-397mm) PPB: 15.5"-23.5" (322-525mm) PPC: 21.9"-35.7" (589-908mm)	PRS-EXA: 8.7"-12.8" (221-325mm) PRS-EXB: 12.6"-20.6" (322-525mm) PRS-EXC: 19.1"-32.9" (486-836mm)	PRG-EXA: 8.7"-12.8" (221-325mm) PRG-EXB: 12.6"-20.6" (322-525mm) PRG-EXC: 19.1"-32.9" (486-836mm)
Distance from the wall	PPA: 9.9"-14" (253-356mm) PPB: 13.9"-20.9" (354-533mm)	PRS-EXA: 9.7"-13.8" (247-352mm) PRS-EXB: 13.7"-21.7" (349-552mm)	PRG-EXA: 9.7"-13.8" (247-352mm) PRG-EXB: 13.7"-21.7" (349-552mm)
Tilt swivel roll	+30°/-5° 360° (±20° at mount) ±20°	+5°/-20° 360° ±10°	±20° 360° ±10°
Max load	50lb (22kg)	25lb (11kg)	50lb (22kg)
Listings	os hpd CE RoHS US	os hpd CE RoHS US	os hpd CE RoHS US

UNIVERSAL PROJECTOR MOUNTS



PRG-UNV shown

1. PATENT PENDING PRECISION GEARS
Reduces installation time and delivers pin-pointing image alignment

2. PIN-POINT IMAGE ALIGNMENT
Achieve pin-point image alignment by simply turning the adjustment knobs by hand or with a Philips screwdriver

3. UNIVERSAL COMPATIBILITY
Spider® universal adapter plate extends from 17.63" (448 mm) to fit most projector models

4. SIMPLE FLUSH INSTALLATION
Enable fast and easy flush mounting installation with horizontal wrench access slots



	PPF[-S][-W]	PJF2-UNV[-S]	PAG-UNV-MU	PAG-UNV	PRS-UNV[-S][-W]	PRG-UNV[-S][-W]
FLUSH CEILING PROJECTOR MOUNT COLOR: Black, silver or white	<ul style="list-style-type: none"> Provides wide range of adjustment for ideal image alignment Comes with hardware for installation to wood joist or concrete Accessories available 	PJF2 PROJECTOR MOUNT COLOR: Black or silver	PAG PROJECTOR MOUNT COLOR: Black	PAG PROJECTOR MOUNT COLOR: Black	PRS PROJECTOR MOUNT COLOR: Black, silver or white	PRG PRECISION GEAR PROJECTOR MOUNT COLOR: Black, silver or white
	<ul style="list-style-type: none"> Provides wide range of adjustment for ideal image alignment 	<ul style="list-style-type: none"> Single point of adjustment for quick image alignment Cable management with use of supplied extension column Comes with hardware for installation to wood joist or concrete Accessories available 	<ul style="list-style-type: none"> Patent gear technology enables effortless adjustment No tools required for image alignment, dual knob design provides hassle free adjustment Cable management with use of supplied extension column Two thumb screws allow for easy projector removal and maintenance Comes with hardware for installation to wood joist or concrete Accessories available 	<ul style="list-style-type: none"> Patent gear technology enables effortless adjustment No tools required for image alignment, dual knob design provides hassle free adjustment Cable management with use of supplied extension column Two thumb screws allow for easy projector removal and maintenance Comes with hardware for installation to wood joist or concrete Accessories available 	<ul style="list-style-type: none"> Three axes of independent adjustment enable precise image alignment Cable management allows cables to be routed through projector mount out of sight Low profile design allows flush mounting Quick-release for easy projector removal and maintenance Comes with hardware for installation to wood joist or concrete Accessories available 	<ul style="list-style-type: none"> Precision gearing provides pin-point projector image alignment Two adjustment knobs control tilt and roll alignment Horizontal wrench access slots make flush mounting installations fast and easy Cable management allows cables to be routed through projector mount out of sight Quick-release for easy projector removal and maintenance Comes with hardware for installation to wood joist or concrete Accessories available

Accessories page 24

Adjustable mounting pattern	up to 17.6" (448mm)	up to 17.6" (448mm)	up to 17.6" (448mm)	up to 17.6" (448mm)	up to 17.6" (448mm)	up to 17.6" (448mm)
Distance from the ceiling	6.8"-7.8" (173-199mm)	4.2"-5.2" (107-133mm)	3.5"-6.1" (88-155mm)	4.5"-7.1" (114-181mm)	3.4"-4.4" (88-113mm)	3.6"-4.6" (94-119mm)
Distance from the wall	—	—	—	—	—	—
Tilt swivel roll	+30/-5° ±20° ±20°	±15° 360° ±15°	±25° 360° ±25°	±25° 360° ±25°	+5/-20° 360° (±30° when flush mounted) ±10°	±20° 360° (±15° when flush mounted) ±10°
Max load	50lb (22kg)	50lb (22kg)	25lb (11kg)	50lb (22kg)	25lb (11kg)	50lb (22kg)
Listings	UL, CE, EN 50495, RoHS, USA	UL, CE, EN 50495, RoHS, USA	UL, RoHS	UL, RoHS	UL, os, h, pd, CE, EN 50495, RoHS, USA	UL, os, h, pd, CE, EN 50495, RoHS, USA

HD FLOW™ WIRELESS MULTIMEDIA SOLUTIONS

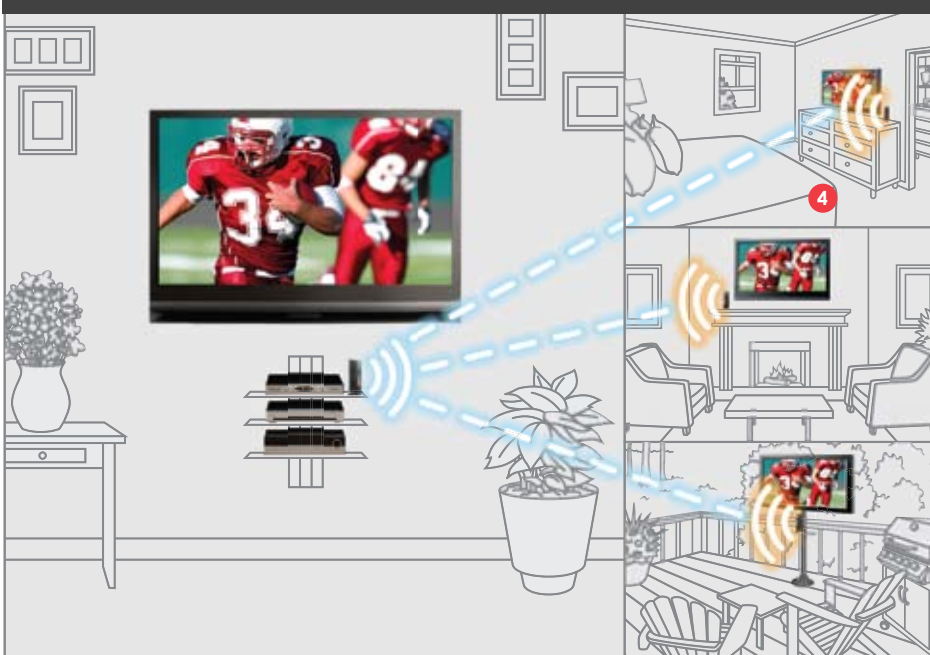

- 1. READY TO ENTERTAIN**
Confirms that the 802.11n private network has been set up and is ready for wireless signal transfer up to 131ft
- 2. PLUG-AND-PLAY**
Plug-in up to 4 AV components and easily switch between them with the included remote
- 3. TOTAL CONTROL**
Built-in IR controls source devices without need for line-of-sight device placement
- 4. DISCREET APPEARANCE**
Small and sleek footprint makes it easy to fit HD Flow receiver(s) into any environment



HDS100[-2][-3][-4]

HD FLOW™ WIRELESS MULTIMEDIA KIT
COLOR: Gloss Black

- Full HD 1080p* (60Hz) (24/30/60 fps) signal flow ideal for ultra-fast signal transfer
- Long range, high-quality streaming up to 131ft with no reduction of picture quality
- Broadcast up to 4 wireless HD Receivers**
- Instant real-time transmission of HD media with no latency
- Transmits through walls and ceilings for multi-room capability
- HD Flow's (802.11n) private network resists interference and network sharing from nearby wireless routers
- Built-in IR does not require line-of-sight placement to control source devices such as DVR/set-top box, satellite box, Blu-ray/DVD player, media server, VHS, game console
- Plug-and-play setup requires no software or driver installation

* 720p Resolution when transmitting to more than one TV
** HDS100-2: HD Flow Multimedia Kit for viewing of two TVs
HDS100-3: HD Flow Multimedia Kit for viewing of three TVs
HDS100-4: HD Flow Multimedia Kit for viewing of four TVs

HDS-S

WALL SHELF FOR USE WITH HD FLOW™ WIRELESS MULTIMEDIA KIT
COLOR: Gloss Black

- Slim design makes it easy to integrate an HD Flow Wireless Multimedia receiver near a TV in any application
- Provides main path for air flow, keeping the HD Flow unit at the optimal operating temperature
- Cable management cut-out routes cables keeping them neatly organized and virtually out of sight
- Ventilation Maximizing Risers provide ample space for air circulation around the unit
- Front slip guard keeps HD Flow unit from being accidentally bumped off the shelf
- Mounts to 1/2" or thicker drywall with included wall anchors for virtually limitless placement options
- Hardware included for quick and easy installation

Max load



—

FULL HD 1080P



Full HD 1080p* (60Hz) (24/30/60 fps) signal flow ideal for ultra-fast signal transfer



Transmits through walls and ceilings for multi-room capability



Broadcast up to 4 wireless HD Receivers**

Plug-and-play setup requires no software or driver installation

* 720p Resolution when transmitting to more than one TV
** HDS100-2: HD Flow Multimedia Kit for viewing of two TVs
HDS100-3: HD Flow Multimedia Kit for viewing of three TVs
HDS100-4: HD Flow Multimedia Kit for viewing of four TVs

3lb (1.36kg)

AV COMPONENT RACK SYSTEM



- 1. CLEAN APPEARANCE**
Integrated cable management
- 2. COMPONENT PLACEMENT**
Sturdy shelves accommodate most components
- 3. EASY MOBILITY**
Rubber wheels for easy movement from location to location



AVM

15U AV COMPONENT RACK SYSTEM
COLOR: Black

- Fully assembled reduces installation time
- Integrated cable management clips assist with routing multiple bundles of cables
- Sturdy shelves accommodate most components
- Rubber wheels for easy movement from location to location
- Includes three 2U shelves



AVL

30U AV COMPONENT RACK SYSTEM
COLOR: Black

- Fully assembled reduces installation time
- Integrated cable management clips assist with routing multiple bundles of cables
- Sturdy shelves accommodate most components
- Rubber wheels for easy movement from location to location
- Includes four 2U shelves, one 5U shelf

Max load



500lb (227kg)

1000lb (453kg)

Listings

RoHS

RoHS



AV-SHL

5U LARGE SHELF



AV-SHM

2U MEDIUM SHELF











AV-VSP1









2U VENTED SEAL PANEL



ACCESSORIES

AV ACCESSORIES

							
<p>PS200</p> <p>ADJUSTABLE SHELF COLOR: Black</p> <ul style="list-style-type: none"> • Double-stud installation allows AV equipment to be centered directly underneath flat panel display • Adjustable width up to 18" (457mm) and depth range of 15" to 23" (381-584mm) accommodate even the components • Snap-on covers conceal all mounting hardware • Adjustment knobs allow for easy leveling of components • Embossed arms with screw holes secure components to shelf 	<p>ESHV10</p> <p>SINGLE AV WALL SHELF COLOR: Black</p> <ul style="list-style-type: none"> • Durable aluminum shelf can be adjusted to accommodate AV components of any height • Cable management system helps keep cables concealed and organized • Supports 30lb • Bubble level helps make installation quick and easy 	<p>ESHV20</p> <p>SINGLE AV WALL SHELF WITH GLASS COLOR: Black</p> <ul style="list-style-type: none"> • Strong, tempered glass shelf can be vertically adjusted to accommodate AV components of any height • Cable management system helps keep cables concealed and organized • Supports 30lb • Bubble level helps make installation quick and easy 	<p>ESHV30</p> <p>DUAL AV WALL SHELF WITH GLASS COLOR: Black</p> <ul style="list-style-type: none"> • Strong, tempered glass shelves can be vertically adjusted to accommodate AV components of any height • Cable management system helps keep cables concealed and organized • Supports 30lb per shelf • Bubble level helps make installation quick and easy 	<p>IBA2(-W) IBA3(-W)</p> <p>RECESSED CABLE MANAGEMENT & POWER STORAGE ACCESSORY BOX COLOR: Black or white</p> <ul style="list-style-type: none"> • Low-profile design fits behind the thinnest mounts and flat panel displays • Routes low-voltage component cables inside the wall • Sleek design makes outside cable covers unnecessary • Heavy gage rolled steel construction • Cable ties and grommet included for an organized finish • Installs between 16" stud centers 	<p>IIBA2AC(-W) IBA3AC(-W)</p> <p>RECESSED CABLE MANAGEMENT & POWER STORAGE ACCESSORY BOX WITH SURGE PROTECTED DUPLEX RECEPTACLE COLOR: Black or white</p> <ul style="list-style-type: none"> • 15 Amp/125 Volt duplex receptacle power source with surge protection with NEMA 5-15R • Low-profile design fits behind the thinnest mounts and flat panel displays • Routes low-voltage component cables inside the wall • Sleek design makes outside cable covers unnecessary • Heavy gage rolled steel construction • Cable ties and grommet included • Installs between 16" stud centers 	<p>IBA4-W</p> <p>EASY MOUNT RECESSED LOW VOLTAGE CABLE PLATE COLOR: White</p> <ul style="list-style-type: none"> • Low-profile design fits behind the thinnest mounts and flat panel displays • Routes low voltage component cables inside the wall • Makes outside cable covers unnecessary • Wing design eliminates the need for low voltage mounting brackets • Installation template included 	<p>IBA5-W</p> <p>RECESSED LOW VOLTAGE MEDIA PLATE WITH DUPLEX SURGE SUPPRESSOR COLOR: White</p> <ul style="list-style-type: none"> • 15 Amp/125 Volt duplex receptacle power source with surge suppressor protection • Low-profile design fits behind the thinnest mounts and flat panel displays • Routes low voltage component cables inside the wall • Makes outside cable covers unnecessary • Wing design eliminates the need for low voltage mounting brackets • Installation template included

<p>Max load  100lb (45kg)</p> <p>Listings </p>	<p>30lb (13.6kg)</p> <p>—</p>	<p>30lb (13.6kg)</p> <p>—</p>	<p>30lb (13.6kg) per shelf</p> <p>—</p>	<p>Max load  25lb (11kg)</p> <p>Listings </p>	<p>25lb (11kg)</p> <p></p>	<p>—</p> <p></p>	<p>—</p> <p></p>
--	-------------------------------	-------------------------------	---	---	---	---	---

	 				 
<p>DEB-CV05/10/15/20</p> <p>HIGH PERFORMANCE COMPONENT AUDIO VIDEO CABLE</p> <ul style="list-style-type: none"> • Exacting cable geometry delivers outstanding sound quality and clarity • HD 1080i/720p compatible • 24K gold-plated contacts for superior signal transfer • Color coded connector ends identify red, green or blue signal conductor • PCOFC oxygen free conductors minimize signal loss and distortion • Braided PCOFC outer shielding and Aluminum foil inner shielding for protection against external electrical (EMI) and radio (RF) interference • PVC outer jacket for enhanced durability • Foamed PE dielectric further enhances performance 	<p>DEW-HD05 DEB-HD10/15/20</p> <p>HIGH SPEED HDMI® CABLE WITH ETHERNET</p> <ul style="list-style-type: none"> • 3DTV compatible (stereo 1080p image resolution) • Ethernet channel for connecting Internet-enabled AV devices minimizing cabling • Audio return channel eliminates need for additional audio cable between TV with integrated receiver and amplifier • Supports 4k x 2k image resolutions (2160p) and FULL HD (1080p) compatible • Increased color profile support for digital cameras • Exacting cable geometry delivers high speed data transfer rates • 24K gold-plated contacts for superior signal transfer • PCOFC oxygen free conductors minimize signal loss and distortion • Braided PCOFC outer shielding and Aluminum foil inner shielding for protection against external electrical (EMI) and radio (RF) interference 	<p>DEW-RR05 DEB-RR10/15/20</p> <p>HIGH PERFORMANCE STEREO AUDIO CABLE</p> <ul style="list-style-type: none"> • Exacting cable geometry delivers outstanding sound quality and clarity • 24K gold-plated contacts for superior signal transfer • Color coded connector housings show signal polarity • PCOFC oxygen free conductors minimize signal loss and distortion • Braided PCOFC outer shielding and Aluminum foil inner shielding for protection against external electrical (EMI) and radio (RF) interference • PVC outer jacket for enhanced durability • Foamed PE dielectric prevents distortion of high frequency audio signals 	<p>DEW-JR05</p> <p>HIGH PERFORMANCE PORTABLE STEREO AUDIO CABLE</p> <ul style="list-style-type: none"> • Exacting cable geometry delivers outstanding sound quality and clarity • 24K gold-plated contacts for superior signal transfer • Color coded connector ends show correct signal polarity • PCOFC oxygen free conductors minimize signal loss and distortion • Braided PCOFC outer shielding and Aluminum foil inner shielding for protection against external electrical (EMI) and radio (RF) interference • PVC outer jacket for enhanced durability • Foamed PE dielectric prevents distortion of high frequency audio signals • Ideal for use with iPod®, iPhone®, MP3 players and other portable audio devices 	<p>DEW-JJ05</p> <p>HIGH PERFORMANCE PORTABLE STEREO AUDIO CABLE</p> <ul style="list-style-type: none"> • Exacting cable geometry delivers outstanding sound quality and clarity • 24K gold-plated contacts for superior signal transfer • PCOFC oxygen free conductors minimize signal loss and distortion • Braided PCOFC outer shielding and Aluminum foil inner shielding for protection against external electrical (EMI) and radio (RF) interference • PVC outer jacket for enhanced durability • Foamed PE dielectric prevents distortion of high frequency audio signals • Ideal for use with iPod®, iPhone®, MP3 players and other portable audio devices 	<p>SLW-HDRU05 SLW-HDRZ05</p> <p>HIGH SPEED HDMI® CABLES WITH ETHERNET FOR REAR MOUNTED CONNECTIONS</p> <ul style="list-style-type: none"> • Right-angled HDMI® connector projects only 14mm from rear of TV screen's HDMI socket (plug inserted) • Ultra slim flat cable 3mm • Right angled (90°) HDMI connection fits the vast majority of flat panel screens with a horizontal HDMI socket (SLW-HDRU05) • Right angled (270°) HDMI connection fits the vast majority of flat panel screens with side mounted HDMI sockets (SLW-HDRZ05) • 100Mbps Ethernet Channel for connecting Internet-enabled AV devices minimizing cabling • Audio Return Channel eliminates need for additional audio cable between TV with integrated receiver and Amplifier • Supports 4k x 2k image resolutions (2160p) @ 24Hz and FULL HD (1080p) compatible
<p>Lengths 16' (5m) / 32' (10m) / 49' (15m) / 65' (20m)</p>	<p>16' (5m) / 32' (10m) / 49' (15m) / 65' (20m)</p>	<p>16' (5m) / 32' (10m) / 49' (15m) / 65' (20m)</p>	<p>16' (5m)</p>	<p>16' (5m)</p>	<p>16' (5m)</p>

							
<p>PVP4000-PL10</p> <p>TEN OUTLET SURGE PROTECTOR</p> <ul style="list-style-type: none"> • IR Signal Indicator – Any IR remote will turn on all 7 switched outlets • Display – Shows total current of switched outlets in real-time • Protection Indicator Lights – Green and red LED indicator lights confirm components are protected • DSS/Coax Connectors – Gold-plated connectors provide surge protection for cable, DSS, and cable modems • Un-Switched Outlets – 3 continuously powered outlets • Switched Power Save Outlets – Outlets automatically turn off when maximum power consumption is below 30% 	<p>PVP3000-PL8</p> <p>EIGHT OUTLET SURGE PROTECTOR</p> <ul style="list-style-type: none"> • Protection Indicator Lights – Green and red LED indicator lights confirm components are protected • Master Outlet – Continuously powered and controls both power save outlets • Energy Saver Outlets – Powered based on master outlet status • Network/Phone (RJ45/RJ11) Combo Jacks – Network or phone line surge protection • DSS/Coax Connectors – Gold-plated connectors provide surge protection for cable, DSS and cable modems • EMI/RFI Noise Filter – Noise filtering for enhanced component performance 	<p>PVP2000-PL4</p> <p>FOUR OUTLET SURGE PROTECTOR</p> <ul style="list-style-type: none"> • Protection Indicator Lights – Green and red LED indicator lights confirm components are protected • Master Outlet – Continuously powered and controls both power and saver outlets • Energy Saver Outlets – Powered based on master outlet status • Outlet Expansion – Expands outlet to support up to 4 plugs • Network/Phone (RJ45/RJ11) Combo Jacks – Network or phone line surge protection 	<p>PVP1000-PL6</p> <p>SWIVELING OUTLET SURGE PROTECTOR</p> <ul style="list-style-type: none"> • Swiveling Outlets – Each side turns up to 90-degrees for low-profile, convenient access • Protection Indicator Lights – Green and red LED indicator lights confirm components are protected • Outlet Expansion – Expands outlet to support up to 6 plugs • EMI/RFI Noise Filter – Noise filtering for enhanced component performance 	<p>PSP2(-W)/PSP5(-W)</p> <p>SPEAKER MOUNT COLOR: Black or white</p> <ul style="list-style-type: none"> • Mounts to wall or ceiling • Universal design fits most brands • Easy tilt, pivot and rotation adjustment • Ceiling extensions included • 1-, 2-, and 4-hole mounting adapters • Includes installation and speaker attachment hardware • Available in 2-pack (PSP2) or 5-pack (PSP5) 	<p>SPK811(W)</p> <p>SPEAKER MOUNT COLOR: Black or white</p> <ul style="list-style-type: none"> • Ball and socket design for multi-directional positioning • 120° range of adjustment in all directions • Speaker wires can be hidden for an aesthetically appealing installation • Concealed mounting screws • Can be assembled as a flush mount or used with a 3" (76mm) extension • Hardware for wood studs, metal studs, concrete and drywall • Fastener pack contains hardware for mounting most commercially available speakers 	<p>PCC(-B)-(-S)</p> <p>CABLE MANAGEMENT CHANNEL COLOR: White, black or silver</p> <ul style="list-style-type: none"> • Keeps cables and cords out of sight for clean, professional appearance • Paintable surface to match any décor • 4.5" (137.6mm) long with ability to customize to desired length • Measures 1" (25mm) from wall for low-profile installation • 90° corner connector to route cables in any direction • Wall-attachment clips designed with built-in channels to keep cables in place 	<p>CL-SCG200</p> <p>SCREEN CLEANING GEL FOR FLAT-PANEL TVs, COMPUTER MONITORS, SMARTPHONES AND MORE</p> <ul style="list-style-type: none"> • Alcohol-free ammonia-free formula cleans without damaging the screen's protective coating • Gel cleaning formula and MicroFiber™ Cleaning Cloth safely and gently polish and remove debris from the screen • Liquid gel formula will not run into delicate electronics • Reusable soft MicroFiber™ Cloth for long lasting screen cleaning • 200ml bottle with 7-5/8" x 7-5/8" cloth included

<p>Number of Outlets 10</p>	<p>8</p>	<p>4</p>	<p>6</p>	<p>Max load  8lb (3kg)</p>	<p>20lb (9kg)</p>	<p>—</p>	<p>—</p>
-----------------------------	----------	----------	----------	---	-------------------	----------	----------

ACCESSORIES

ACC215/ACC415/ACC615



Metal Stud Fastener Kit - 2/4/6 toggles

ACC560



Ceiling Plate

ACC570(S)[W]



Round Ceiling Plate

CMJ500R1



Lightweight Suspended Ceiling Kit

WSP700/701



Metal Stud Wall Plate for SA/SP730P/735P/740P/746PU

WSP756



Metal Stud Wall Plate for SA752P(U)/763PU/771P(U)

WSP815/820/824



Metal Stud Wall Plate for SP850-UNL models

ACC912/ACC556



Cathedral Ceiling Adapter

ACC954



Theft Resistant Security Kit for PTM400 and PTM200

ACC-EXC(S)[W]



Extension Column for EXC Extension Kit

AEC models



Adjustable Extension Column

ALU models



Adjustable Aluminum Extension Column

ACC952



Above Display SUF Security Lock Accessory

ACC-SB



Soundbar/Center Channel Accessory Mount for SAU745PU, SUA750PU and SUA765PU

ACC955



Component Shelf Accessory for PP740, PA740, SP740P and SA740P

ACCXT101

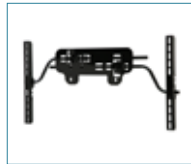

Left/Right Speaker Accessory for PP740, PA740, SP740P and SA740P

ACCXT201



Soundbar Speaker Accessory for PP740, PA740, SP740P and SA740P

ACCXT301



Video Conferencing Shelf Accessory for PP740, PA740, SP740P and SA740P

ACCXT400/402



SmartMountXT™ Recessed Power Outlet with Low Voltage In-Wall Cable Routing
ACCXT400 for SAX762PU and SAX772PU
ACCXT402 for SFX and STX models

ACC953



SmartMountXT™ Component Shelf Accessory for SAX755PU, SAX762PU and SAX772PU

ACCXT100



SmartMountXT™ Left/Right Speaker Accessory for SAX755PU, SAX762PU and SAX772PU

ACCXT200



SmartMountXT™ Soundbar Speaker Accessory for SAX755PU, SAX762PU and SAX772PU

ACCXT300



SmartMountXT™ Video Conferencing Shelf Accessory for SAX755PU, SAX762PU and SAX772PU

ACCXT302



SmartMountXT™ Video Conferencing Shelf Accessory for SFX645(P), SFX650(P), SFX660(P), STX645(P)(L), STX650(P)(L) and STX660(P)(L)

peerless-AV™

