

**Planar<sup>®</sup> UltraRes<sup>™</sup> X Series**

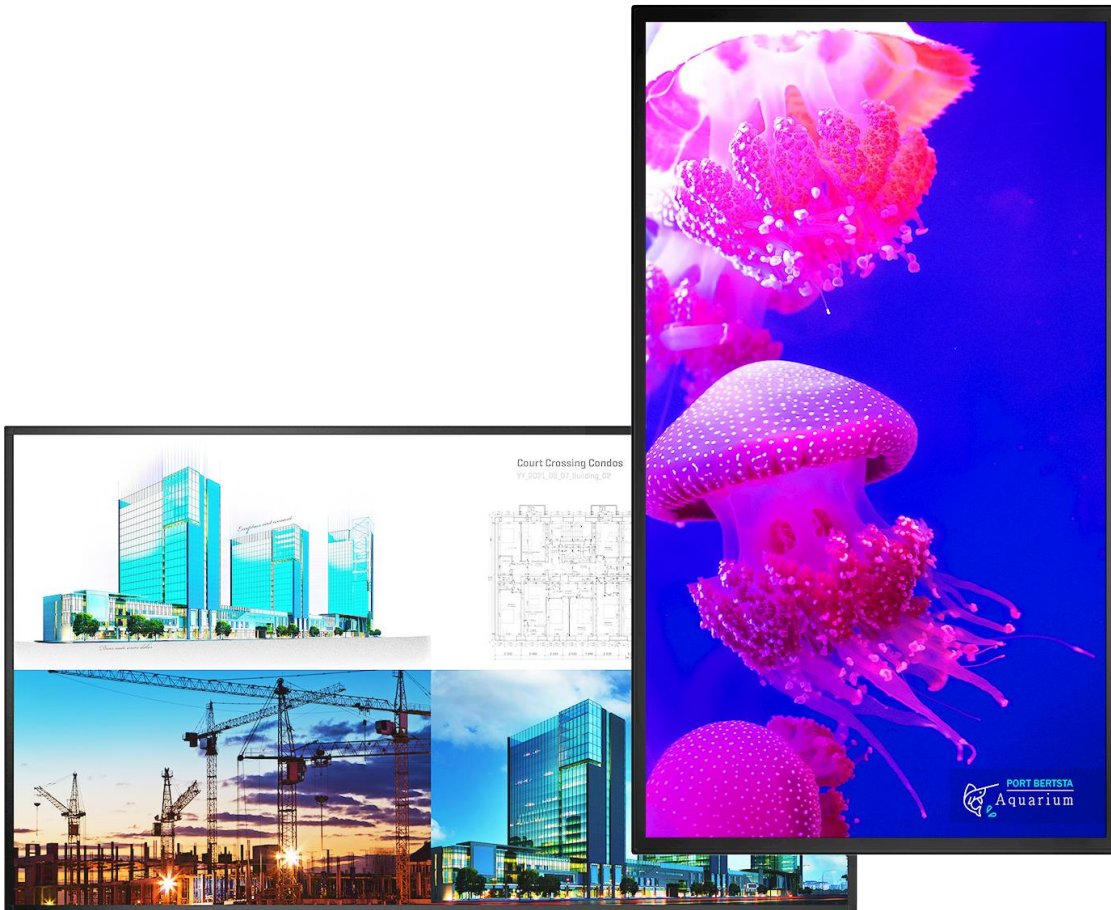

- URX75**
- URX75-ERO**
- URX75-ERO-T**
- URX85**
- URX85-ERO**
- URX85-ERO-T**
- URX100**
- URX100-ERO**
- URX100-ERO-T**

Copyright © September 2022 by Planar Systems, Inc.  
All rights reserved.

This document may not be copied in any form without permission from Planar. Information in this document is subject to change without notice.

#### Trademark Credits

Windows™ is a trademark of Microsoft Corp.  
All other companies are trademarks or registered trademarks of their respective companies.

#### Disclaimer

The information contained in this document is subject to change without notice. Planar Systems, Inc. makes no warranty of any kind with regard to this material. While every precaution has been taken in the preparation of this manual, the Company shall not be liable for errors or omissions contained herein or for incidental or consequential damages in connection with the furnishing, performance, or use of this material.

#### Warranty and Service Plans

Planar warranty and service plans will help you maximize your investment by providing great support, display uptime, and performance optimization. From post-sale technical support, to a full suite of depot services, our services are performed by trained employees. When you purchase a Planar product, you get more than a display; you get the service and support you need to maximize your investment. To find the latest warranty and service information regarding your Planar product, please visit <http://www.planar.com/support>

#### RoHS Compliance Statement

The Planar UltraRes X Series is fully RoHS compliant.

Part Number: 020-1396-01A

# Table of Contents

|  |           |
|--|-----------|
| <b>Introduction .....</b>  | <b>5</b>  |
| 1. Safety Information.....                                       | 6         |
| 2. Safety Precautions.....                                       | 6         |
| 2.1 Important Safety Instructions.....                           | 7         |
| 3. Recommended Usage .....                                       | 8         |
| 3.1 Burn-In Versus Temporary Image Retention.....                | 8         |
| 3.2 Warranty Coverage.....                                       | 8         |
| 3.3 Important Waste Disposal Information.....                    | 9         |
| 3.4 Normal Usage Guidelines .....                                | 9         |
| 4. Cleaning the Display .....                                    | 10        |
| <b>Unpacking and Checking Accessories.....</b>                   | <b>11</b> |
| 5. Package Contents.....   | 11        |
| 6. Accessory Kit.....  | 12        |
| 7. Planar UltraRes X Series – Standard Inputs .....              | 13        |
| <b>Installing the Display .....</b>                              | <b>16</b> |
| 8. Before You Begin .....  | 16        |
| 8.1 Tools/Equipment List.....                                    | 16        |
| 8.2 Other Things You May Need .....                              | 17        |
| 8.3 Plan Your Installation.....                                  | 17        |
| 8.4 Prepare Your Installation Location.....                      | 17        |
| 8.5 Cable Length Recommendations .....                           | 17        |
| 9. Mounting with a VESA Mount.....                               | 18        |
| 10. Installing the Optional Planar Profile Mounting System ..... | 19        |
| 10.1 Using the Lifting Eyes .....                                | 27        |
| 11. Installing OPS Expansion (Optional) .....                    | 29        |
| <b>Operating the Display .....</b>                               | <b>30</b> |
| 12. OSD Keypad.....  | 30        |
| 13. Remote Control Receiver.....                                 | 31        |
| 14. LED Indicators .....   | 32        |
| 15. Using the Display in Portrait Mode .....                     | 32        |
| 16. Using the Display in Flat or Tilted Orientation.....         | 32        |
| 17. Using the Remote Control.....                                | 33        |
| 18. IR Command Protocol .....                                    | 34        |
| 18.1 Locking the Keypad and IR Remote.....                       | 37        |
| 18.2 Unlocking the Keypad and IR Remote .....                    | 37        |
| 18.3 Changing the IR Remote Code Set.....                        | 37        |
| 18.4 Turning the Display On.....                                 | 37        |
| 18.5 Turning the Display Off.....                                | 38        |
| 18.6 Adjusting the Volume .....                                  | 38        |
| 18.7 Selecting Layouts and Input Sources .....                   | 38        |
| 18.8 Navigating Through the Menus .....                          | 39        |
| 19. Inputs and Views Menu.....                                   | 40        |
| 19.1 Image Adjust Menu .....                                     | 42        |
| 19.2 Audio Menu.....   | 45        |
| 19.3 Presets Menu.....   | 46        |

|  |  |            |
|--|--|------------|
| 19.4   | Advanced Settings Menu .....   | 47         |
| 19.5   | Information Menu .....   | 69         |
| 20.  | Using the Touch Screen .....   | 72         |
| <b>Planar UltraRes X Series Remote Monitoring Software .....</b> |  | <b>73</b>  |
| 21.  | Remote Monitoring Home .....   | 73         |
| 22.  | Remote Monitoring System Information .....                             | 75         |
| 23.  | Remote Monitoring Inputs and Views .....                               | 76         |
| 24.  | Remote Monitoring Audio .....  | 77         |
| 25.  | Remote Monitoring Presets .....  | 78         |
| 26.  | Remote Monitoring Panel Brightness and Power .....                     | 79         |
| 27.  | Remote Monitoring Notifications .....                                  | 80         |
| 28.  | Remote Monitoring System Settings .....                                | 82         |
| 29.  | Remote Monitoring Access Control .....                                 | 83         |
| <b>External Control .....</b>                                    |  | <b>84</b>  |
| <b>HDR .....</b>   |  | <b>85</b>  |
| <b>Signal Compatibility .....</b>                                |  | <b>86</b>  |
| <b>Color Subsampling Report .....</b>                            |  | <b>90</b>  |
| <b>Power Consumption .....</b>                                   |  | <b>91</b>  |
| <b>Specifications .....</b>                                      |  | <b>92</b>  |
| <b>Dimensions .....</b>  |  | <b>95</b>  |
| 30.  | URX75 .....  | 95         |
| 30.1   | URX75 Standard .....   | 95         |
| 30.2   | URX75-ERO .....  | 96         |
| 30.3   | URX75-ERO-T .....  | 97         |
| 31.  | URX85 .....  | 98         |
| 31.1   | URX85 Standard .....   | 98         |
| 31.2   | URX85-ERO .....  | 99         |
| 31.3   | URX85-ERO-T .....  | 100        |
| 32.  | URX100 .....   | 101        |
| 32.1   | URX100 Standard .....  | 101        |
| 32.2   | URX100-ERO .....   | 102        |
| 32.3   | URX100-ERO-T .....   | 103        |
| <b>Troubleshooting During Installation .....</b>                 |  | <b>104</b> |
| 33.  | Error Codes .....  | 104        |
| 34.  | Symptoms, Possible Causes and Solutions .....                          | 105        |
| 34.1   | Symptom: Display Doesn't Respond to External Control System .....      | 105        |
| 34.2   | Symptom: Can't Get PC to Output 4K @ 24/30/60 Hz .....                 | 105        |
| 34.3   | Symptom: Can't Get PC to Output 4K @ 24/30/60 Hz .....                 | 106        |
| 34.4   | Symptom: Can't Select OPS or HDMI 1 .....                              | 106        |
| 34.5   | Symptom: IR Isn't Working Properly .....                               | 107        |
| 34.6   | Symptom: Touch Has Broken Response Near Middle/Bottom of Display ..... | 107        |
| <b>Accessing Planar's Technical Support Website .....</b>        |  | <b>108</b> |

# Introduction

The Planar® UltraRes X™ Series is a line of 75", 85" and 100" 4K resolution (3840 x 2160) professional LCD displays with 700-nit brightness and wide color gamut perfect for High Dynamic Range (HDR) content.

The displays offer superior visual performance with multi-source viewing and advanced processing ideal for applications ranging from collaborative meeting spaces to high-impact digital signage and media rooms. Models ruggedized with Planar® ERO-LCD™ (Extended Ruggedness and Optics™) are available, as well as extremely responsive interactive models with up to 20-point touch.

The Planar UltraRes X Series supports native 4K resolution at up to 60Hz via HDMI 2.0 and DisplayPort 1.2, enabling smooth motion video and mouse tracking. The displays' HDMI 2.0 inputs are also HDCP 2.2 compliant. It features redundant power and Crestron drivers for versatility.

Features of the Planar UltraRes X Series displays include:

- 75", 85" and 100" 4K LCD displays
- Bright 700 nits
- Wide color gamut
- HDR compatible
- Optional thin-profile mounting system
- Optional responsive touch screen
- Optional Planar ERO-LCD protective glass
- Multi-source viewing with Planar MediaPlex Plus processing

# 1. Safety Information

Before using the Planar UltraRes X Series, please read this manual thoroughly to help protect against damage to property, and to ensure personnel safety.

- Be sure to observe the following instructions.
- For your safety, be sure to observe ALL the warnings detailed in this manual.
- For installation or adjustment, please follow this manual's instructions, and refer all servicing to qualified service personnel.

# 2. Safety Precautions

- **If water is spilled or objects are dropped inside the display, remove the power plug from the outlet immediately.** Failure to do so may result in fire or electrical shock. Contact your dealer for inspection.
- **If the display is dropped or the chassis is damaged, remove the power plug from the outlet immediately.** Failure to do so may result in fire or electrical shock. Contact your dealer for inspection.

**WARNING!** Wall mounts must be secure.

- **If the display is hung on a wall, the wall must be strong enough to hold it.** Simply mounting it to wallboard or wall paneling won't be adequate or safe.

**Caution:** For Non-ERO Models:

- The front polarizer of non-ERO URX models is soft and subject to scratches from sharp objects.
- Slight pressure on the LCD of non-ERO URX models will cause distortion of the image. Heavier pressure will cause permanent damage.

**Caution:** For All URX Models:

- Displays should be mounted where viewers cannot insert small objects in the openings that will create hazards by contacting bare conductive parts.
- If the power cord or plug is damaged or becomes hot, turn off the main power switch of the display. Make sure the power plug has cooled down and remove the power plug from the outlet. If the display is still used in this condition, it may cause a fire or an electrical shock. Contact your dealer for a replacement.

## 2.1 Important Safety Instructions

1. Read these instructions.
2. Keep these instructions.
3. Heed all warnings.
4. Follow all instructions.
5. Do not use the display near water.
6. Clean the LCD screens with an LCD screen cleaner or LCD wipes.
7. Do not install near any heat sources such as radiators, heat registers, stoves or other apparatus (including amplifiers) that produce heat.
8. Do not defeat the safety purpose of the polarized or grounding type plug. A polarized plug has two blades with one wider than the other. A grounding type plug has two blades and a third grounding prong. The wide blade or the third prong is provided for your safety. When the provided plug does not fit into your outlet, consult an electrician for the replacement of the obsolete outlet.
9. Protect the power cord from being walked on or pinched, particularly at plugs, convenience receptacles and the point where they exit from any Planar large format LCD display.
10. Only use the attachments/accessories specified by the manufacturer.
11. Unplug all displays during lightning storms or when unused for long periods of time.
12. In instances where a power surge has occurred and a display no longer has an image, the display power will need to be reset.
13. You must follow all National Electrical Code regulations. In addition, be aware of local codes and ordinances when installing your system.
14. Refer all servicing to qualified service personnel. Servicing is required when any of the displays have been damaged in any way. For example, if the AC power cord or plug is damaged, liquid has been spilled or objects have fallen into a display, the displays have been exposed to rain or moisture, do not operate normally or have been dropped.
15. Keep the packing material in case the equipment should ever need to be shipped.
16. Wall mounts must be secure. The wall must be strong enough to hold displays brackets, cables and accessories. Seismic engineers should be consulted in areas prone to earthquakes.
17. **Caution:** There is a risk of explosion if the battery is replaced with incorrect type. Dispose of used batteries according to local regulations.

## 3. Recommended Usage

In order to get the most out of your LCD, use the following recommended guidelines to optimize the display.

### 3.1 Burn-In Versus Temporary Image Retention

Burn-in causes the screen to retain an image essentially forever, with little or no way to correct the problem. Under normal use, an LCD will not experience burn-in, as plasma displays do, nor will it retain images in any way.

Normal use of an LCD is defined as displaying continuously changing video patterns or images. However, LCDs can experience *temporary* image retention when recommended usage guidelines are not followed.

#### What is Temporary Image Retention?

Temporary image retention (TIR) can occur when a static image is displayed continuously for extended periods of time (12 hours or longer). An electrical charge differential may build up between the electrodes of the liquid crystal, which causes a negative-color video image (color-inverted and brightness-inverted version of the previous image) to be retained when a new image is displayed. This behavior is true for any LCD device from any LCD manufacturer.

TIR is not covered under warranty. See standard warranty terms and conditions for details. Here are some guidelines to help you avoid TIR:

- Use the LCD to show a screen saver, moving images or still pictures that change regularly. When using high-contrast images, reposition the images frequently.
- Turn off the LCD when it is not in use. To use your source computer's Power Options Properties, set up your computer to turn off the display when not in use.

### 3.2 Warranty Coverage

The following models are warranted for **24 x 7** usage:

- 75": URX75, URX75-ERO, URX75-ERO-T
- 85": URX85, URX85-ERO, URX85-ERO-T
- 100": URX100, URX100-ERO, URX100-ERO-T

Planar recommends turning off the power for **4 hours per day** for optimal performance.

For complete warranty details, please visit <http://www.planar.com/warranty>.



### 3.3 Important Waste Disposal Information

Please recycle or dispose of all electronic waste in accordance with local, state, and federal laws. Additional resources can be found online at <http://www.planar.com/about/green/>.

The crossed-out wheelee bin symbol is to notify consumers in areas subject to Waste Electrical and Electronic Equipment (WEEE) Directive 2012/19/EU that the product was placed on the market after August 13, 2005 and must not be disposed of with other waste. Separate collection and recycling of electronic waste at the time of disposal ensures that it is recycled in a manner that minimizes impacts to human health and the environment. For more information about the proper disposal of electronic waste, please contact your local authority, your household waste disposal service, or the seller from whom you purchased the product.



### 3.4 Normal Usage Guidelines

Normal use of the LCD is defined as operating in the open air to prevent heat buildup, and without direct or indirect heat sources such as lighting fixtures, heating ducts, or direct sunlight that can cause the displays to experience high operating temperatures. For all displays, do not block fans or ventilation openings. If the LCD display will be installed in a recessed area with an LCD surround or enclosure, ensure adequate openings are applied for proper air flow and ventilation.

It is up to the installer to ensure that display placement is changed, thermal shielding is provided and/or additional ventilation is provided to keep the display within its nominal operating parameters. Maximum ambient operating temperatures for the Planar UltraRes X Series are:

- 75" and 100" Planar UltraRes X Series models: 0-40°C at up to 3000 meters
- 85" Planar UltraRes X Series models: 0-40°C at up to 1500 meters and 0-35°C at up to 3000 meters

#### Cooling Requirements

For optimal performance, active cooling by the installer should be planned for when the ambient temperature anywhere in the wall is predicted to be above the specified ambient temperature for the display.

## 4. Cleaning the Display

If dust has collected on the power plug, remove the plug from the outlet and clean off the dust. Dust build-up may cause a fire.





Remove the power plug before cleaning. Failure to do so may result in electrical shock or damage.

Keep the following points in mind when cleaning the surface of the display:







- When the surface of the display becomes dirty, wipe the surface lightly with a soft clean cloth.
- If the surface requires additional cleaning, use LCD screen cleaner or LCD wipes, which are available at most electronics stores.
- Do not let cleaner seep into the display, as it may cause electrical shock or damage.
- Refer to the Planar Display Cleaning Guidelines for more information.

# Unpacking and Checking Accessories

## 5. Package Contents

| Part  | Description  | Number  | Picture   |
|---|--|---|---|
| LCD Display   | One per box.   | 1   |   |
| Planar UltraRes X Profile Mount Brackets (optional)         | For hanging of Planar UltraRes X products.   | 2<br><b>Note:</b><br>75" portrait products come with only a single mount bracket. |  |
| Planar UltraRes X Service Brackets (optional)               | For placing a Planar UltraRes X product in service mode and locking the panel in place when installed. | 2   |  |
| Planar UltraRes X Profile Mount Install Template (optional) | For use when installing Planar UltraRes X Profile Mounts.  | 1   |  |

## 6. Accessory Kit

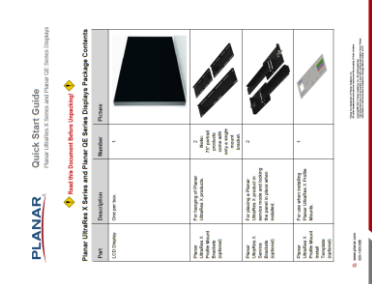
| Part   | Description  | Number | Picture   |
|--|--|--------|---|
| AC power cord  | Power cord   | 1      |    |
| IR sensor  | Used to receive signals from the remote control.   | 1      |    |
| HDMI cable   | HDMI cable.  | 1      |    |
| USB cable  | Connects to a PC for touch functionality (touch models only) and serial commands (all models). | 1      |    |
| Remote control   | Used to control the display. Two AAA batteries are included but not installed.                 | 1      |   |
| Carrying Strap   | For lifting and carrying the display using three people.                                       | 2      |  |
| Planar® TouchMark™ Single License Key Card   | Annotation and whiteboarding software (touch models only)                                      | 1      |  |
| Quick Start Guide: Planar UltraRes X Series, Planar UltraRes P Series, and Planar QE Series Displays |  | 1      |  |

# 7. Planar UltraRes X Series – Standard Inputs

## 7.1 URX75 / URX75-ERO / URX75-ERO-T

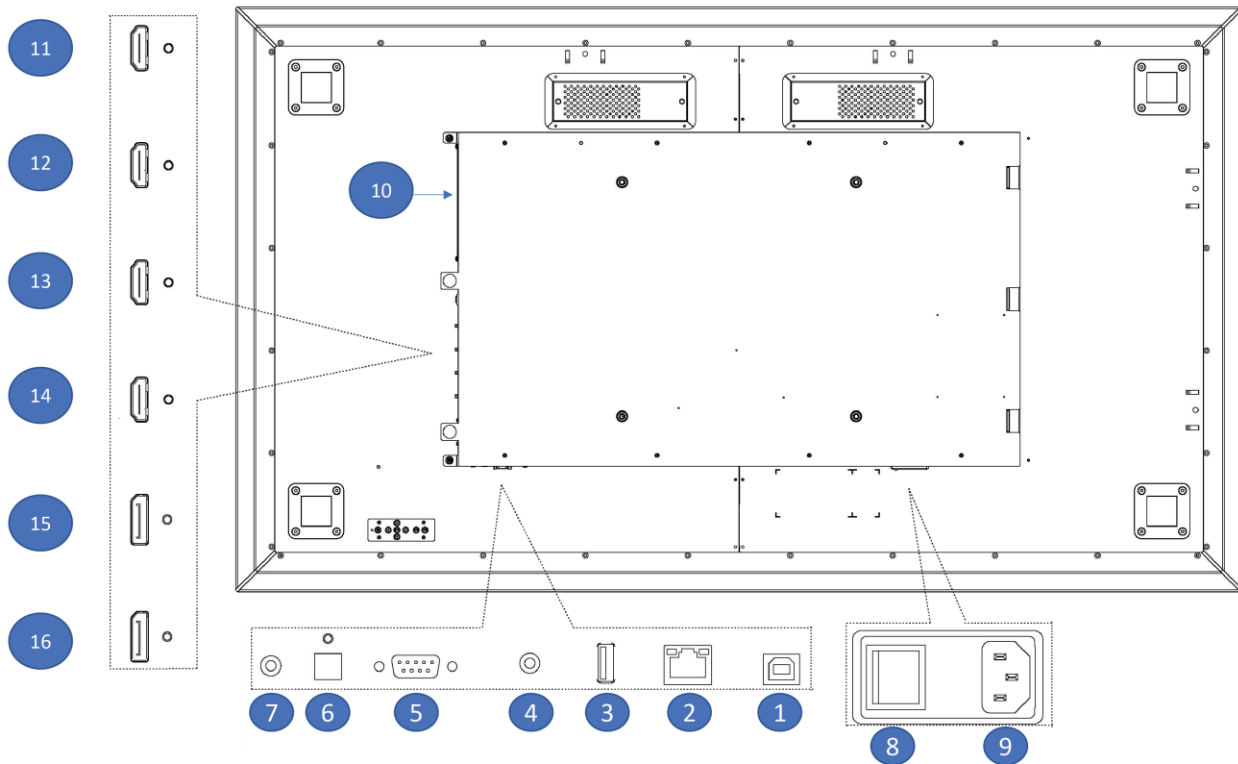

| URP75 / URP75-ERO / URP75-ERO-T | Description                          |
|---------------------------------|--------------------------------------|
| 1                               | USB-B: Touch                         |
| 2                               | LAN                                  |
| 3                               | USB-A: Service                       |
| 4                               | IR: 2.5mm TRS (female)               |
| 5                               | RS232: DB9 (female)                  |
| 6                               | SPDIF Audio Out                      |
| 7                               | Line Audio Out: 2.5mm TRS (female)   |
| 8                               | AC ON/OFF                            |
| 9                               | AC IN: IEC C14                       |
| 10                              | OPS: 4K/60Hz, HDR                    |
| 11                              | HDMI 1: HDMI, 4K/60Hz, HDCP 2.2, HDR |
| 12                              | HDMI 2: HDMI, 4K/60Hz, HDCP 2.2, HDR |
| 13                              | HDMI 3: HDMI, 4K/30Hz, HDCP 1.4      |
| 14                              | HDMI 4: HDMI, 4K/30Hz, HDCP 1.4      |
| 15                              | DP IN: DisplayPort In: 4K/60Hz       |
| 16                              | DP OUT: DisplayPort Out              |

## 7.2 URX85 / URX85-ERO / URX85-ERO-T

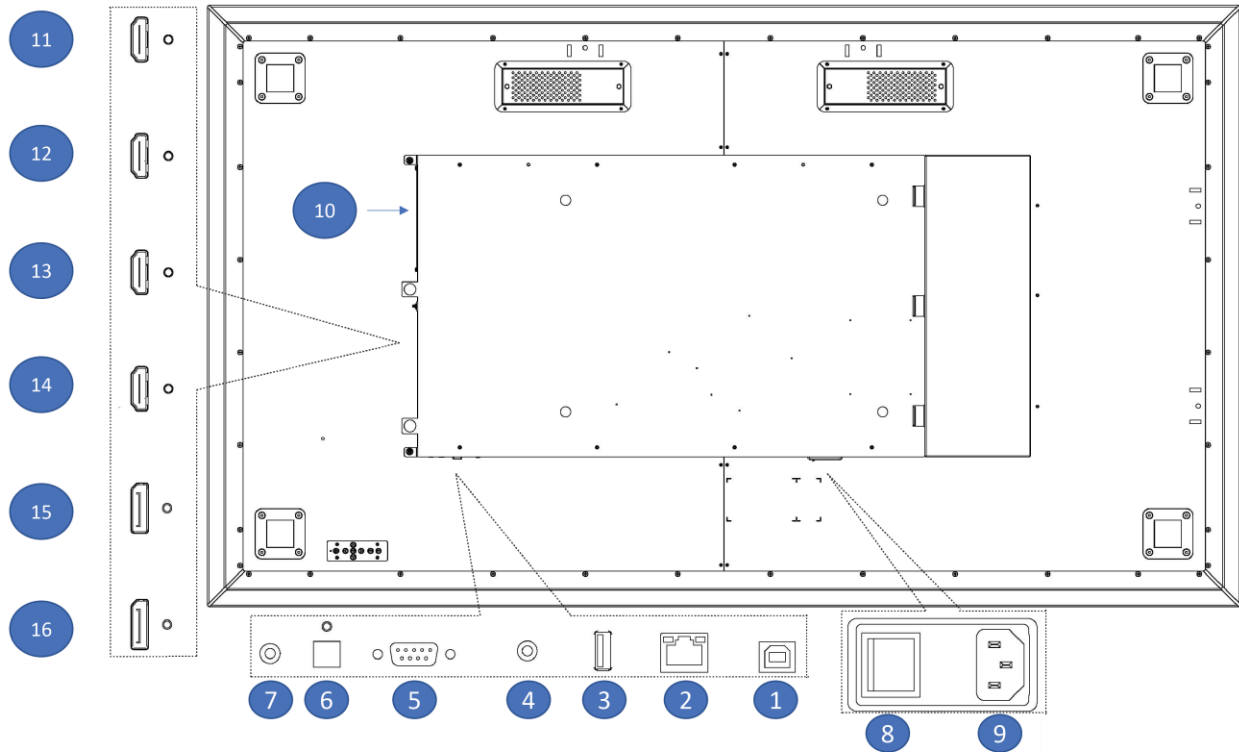

| URP85 / URP85-ERO / URP85-ERO-T | Description                          |
|---------------------------------|--------------------------------------|
| 1                               | USB-B: Touch                         |
| 2                               | LAN                                  |
| 3                               | USB-A: Service                       |
| 4                               | IR: 2.5mm TRS (female)               |
| 5                               | RS232: DB9 (female)                  |
| 6                               | SPDIF Audio Out                      |
| 7                               | Line Audio Out: 2.5mm TRS (female)   |
| 8                               | AC ON/OFF                            |
| 9                               | AC IN: IEC C14                       |
| 10                              | OPS: 4K/60Hz, HDR                    |
| 11                              | HDMI 1: HDMI, 4K/60Hz, HDCP 2.2, HDR |
| 12                              | HDMI 2: HDMI, 4K/60Hz, HDCP 2.2, HDR |
| 13                              | HDMI 3: HDMI, 4K/30Hz, HDCP 1.4      |
| 14                              | HDMI 4: HDMI, 4K/30Hz, HDCP 1.4      |
| 15                              | DP IN: DisplayPort In: 4K/60Hz       |
| 16                              | DP OUT: DisplayPort Out              |

### 7.3 URX100 / URX100-ERO / URX100-ERO-T

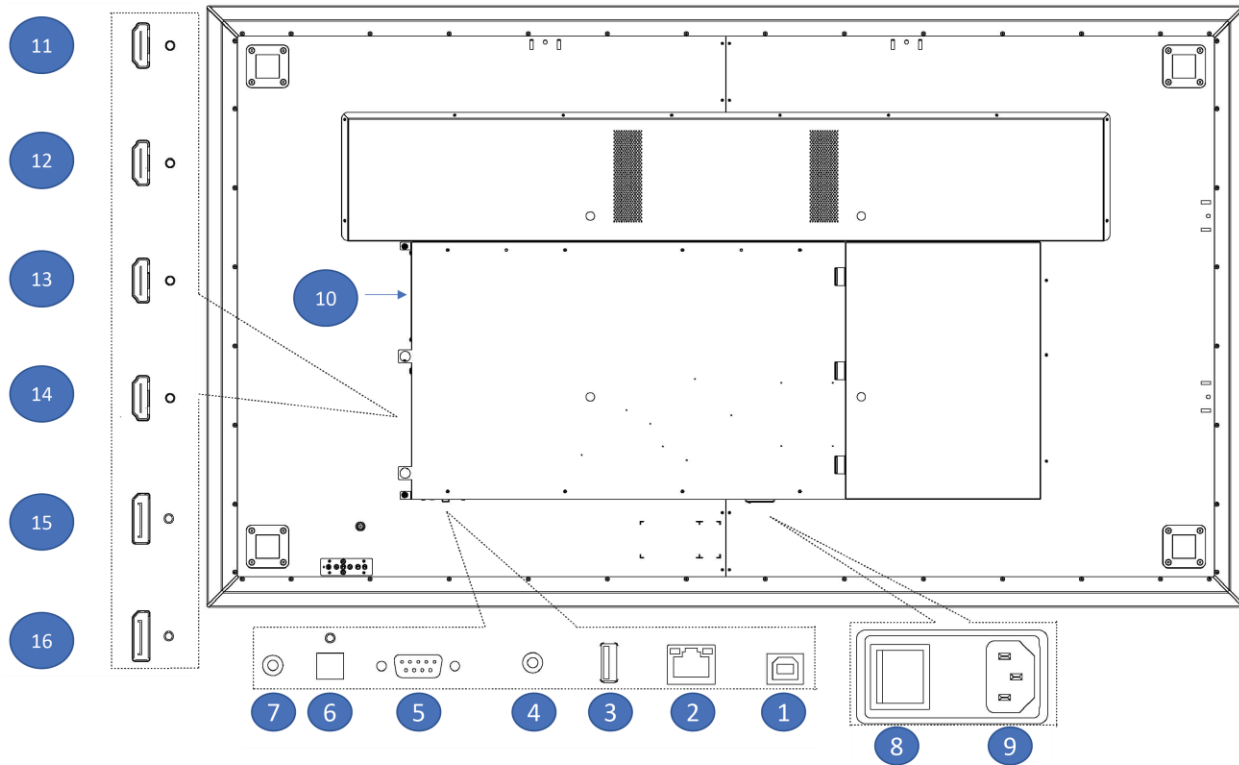

| URP100 / URP100-ERO / URP100-ERO-T | Description                          |
|------------------------------------|--------------------------------------|
| 1                                  | USB-B: Touch                         |
| 2                                  | LAN                                  |
| 3                                  | USB-A: Service                       |
| 4                                  | IR: 2.5mm TRS (female)               |
| 5                                  | RS232: DB9 (female)                  |
| 6                                  | SPDIF Audio Out                      |
| 7                                  | Line Audio Out: 2.5mm TRS (female)   |
| 8                                  | AC ON/OFF                            |
| 9                                  | AC IN: IEC C14                       |
| 10                                 | OPS: 4K/60Hz, HDR                    |
| 11                                 | HDMI 1: HDMI, 4K/60Hz, HDCP 2.2, HDR |
| 12                                 | HDMI 2: HDMI, 4K/60Hz, HDCP 2.2, HDR |
| 13                                 | HDMI 3: HDMI, 4K/30Hz, HDCP 1.4      |
| 14                                 | HDMI 4: HDMI, 4K/30Hz, HDCP 1.4      |
| 15                                 | DP IN: DisplayPort In: 4K/60Hz       |
| 16                                 | DP OUT: DisplayPort Out              |

# Installing the Display

This section explains how to install your display. We suggest that you read the entire section before you attempt to install the unit.

## 8. Before You Begin

Before installation, keep the following points in mind:

- The Planar UltraRes X Series displays are heavy. Be sure that the structure has adequate design to support the weight of each display to be mounted.
- Be sure the structure the unit will be mounted to is sufficiently engineered to support the total weight of the display and any peripheral equipment that may be attached to the display. Use properly sized hardware for the weight to be supported as well as suited to the type of structure to which the mounts will be attached.
- If the display is a touch model, it is important the touch frame is not used to lift or support the display or touch performance may be compromised.
- Any mount must be secured per the manufacturer's recommendations to a structure that has been properly designed to hold the weight of all components that will be attached. Additionally, proper hardware engineered to be used in conjunction with the structure material and able to support the weight of all components must be used.
- If the Planar® Profile Mounting System was ordered, a template will be part of the kit to assist in proper location of all mount components referencing the center point of the display.
- The Planar Profile Mounting System must be mounted to a solid flat surface.
- The Planar Profile Mounting System have common components among all models except for when mounting any URX75 in portrait orientation. The main hanging support bar will be different; however, the process for installing is the same.
- For touch model best performance, the display must be mounted in a vertical to slightly tilted back orientation. Displays tilted forward can cause touch beam interference from the glass bowing slightly away from the display and into the IR path.

Make sure you have all the items in these lists before you begin unpacking and installing your display(s).

### 8.1 Tools/Equipment List

Depending on your installation, you may need one or more of the following items:

- String/string level
- Digital/laser level
- Ladders/lift
- Power tools
- Back brace
- Stud finder (if hanging display on a wall)



## 8.2 Other Things You May Need

- LCD screen cleaner or LCD wipes – available at most electronics stores
- At least two very strong people to help lift unit into place

## 8.3 Plan Your Installation

You should have a detailed plan of how the units are to be configured. The plan should include calculations for the following:

- Power maximums reference below by display size:

| Model  | Max Current @ 115VAC | Max Current @ 230VAC |
|--------|----------------------|----------------------|
| URX75  | 3.9A                 | 1.7A                 |
| URX85  | 4.9A                 | 2.2A                 |
| URX100 | 5.9A                 | 2.5A                 |

- Cable runs
- Ventilation and cooling requirements
- If hanging display on a wall, location of studs in the wall
- For touch model best performance, the display must be mounted in a vertical to slightly tilted back orientation.
- If the display is a touch model, it is important that the touch frame is not used to lift or support the display or touch performance may be compromised. Displays tilted forward can cause touch beam interference from the glass bowing slightly away from the display and into the IR path (URX75-ERO-T, URX85-ERO-T and URX100-ERO-T models only).

## 8.4 Prepare Your Installation Location

- Prepare the area where you will install the unit. If custom enclosures are part of the installation, they must be fully designed to accommodate the installation of the displays, the installed units, and ventilation and cooling requirements.
- If your installation includes a lot of construction or dust, it is **highly recommended** that you clean all of the screens after the wall installation and configuration are complete.

## 8.5 Cable Length Recommendations

Cable length performance may vary between different cables and sources. The recommended maximum cable lengths are as follows:

### HDMI

- 4K @ 50/60Hz: 5m (15 ft) maximum
- 4K @ 24/25/30Hz: 15m (50 ft) maximum
- 1080p @ 60Hz and lower resolutions: 20m (65 ft) maximum

### DisplayPort

- DP 1.2: 3m (10 ft) maximum
- DP 1.1: 5m (15 ft) maximum

## 9. Mounting with a VESA Mount

The Planar UltraRes X Series can be mounted with the Planar Profile Mounting System (see page 13) or with a VESA mount, available from Planar or other manufacturers.

If you purchased a VESA mount, you should have received a separate box with mounting supplies and an Installation manual. Follow these instructions carefully.

Keep in mind the following general installation guidelines:

- Screw length is crucial and will vary depending on the type of mount you use. Total screw length will include the penetration length plus the length required by the type of VESA mount in use.
- Mount spacers may be required to accommodate the protruding back panel of the OPS slot.

**Caution:** Screws not sized to the depth specified can result in inadequate mounting strength or damage to the internal components in the display. To prevent injury, this device must be securely attached to the wall in accordance with the installation instructions supplied with the mount. The mount must be secured to the Planar UltraRes X Series display using the four M8-1.25 VESA mounting locations, and 10mm -15mm thread engagement is required for secure mounting. Select the correct screw/spacer combination for the mount.

- Prior to installation, make sure you know where all of the mounting points are located.
- Follow all safety precautions outlined in the VESA Installation manual.
- Verify the parts received with the list shown in the VESA Installation manual.

## 10. Installing the Optional Planar Profile Mounting System

For Planar Profile kits, a template has been supplied in the kit to simplify installation of the Planar Profile components. If the template has been misplaced or lost, refer to the product outline drawing for pertinent dimensions on the location of the Planar Profile mount component locations. The following steps describe the use of the template to locate components.

**Note:** The mounting instructions below show a 75" landscape display; however, any size is similar in procedure.

1. Determine and mark a vertical and horizontal line of the center display of the unit. For mount location verification, it is optional to continue the line or mark the left and right most edge of the display as well as the top.

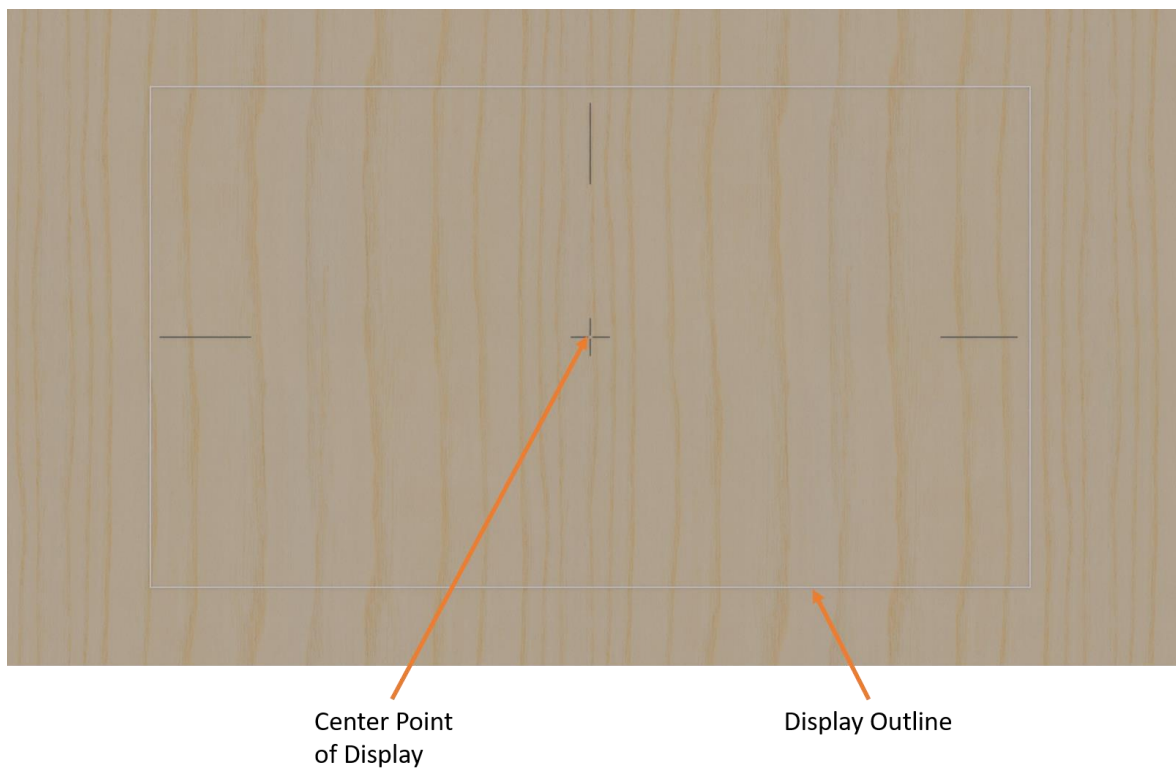

- Using the dimensions on the template for the model being installed, mark the location of the upper-left mount position.

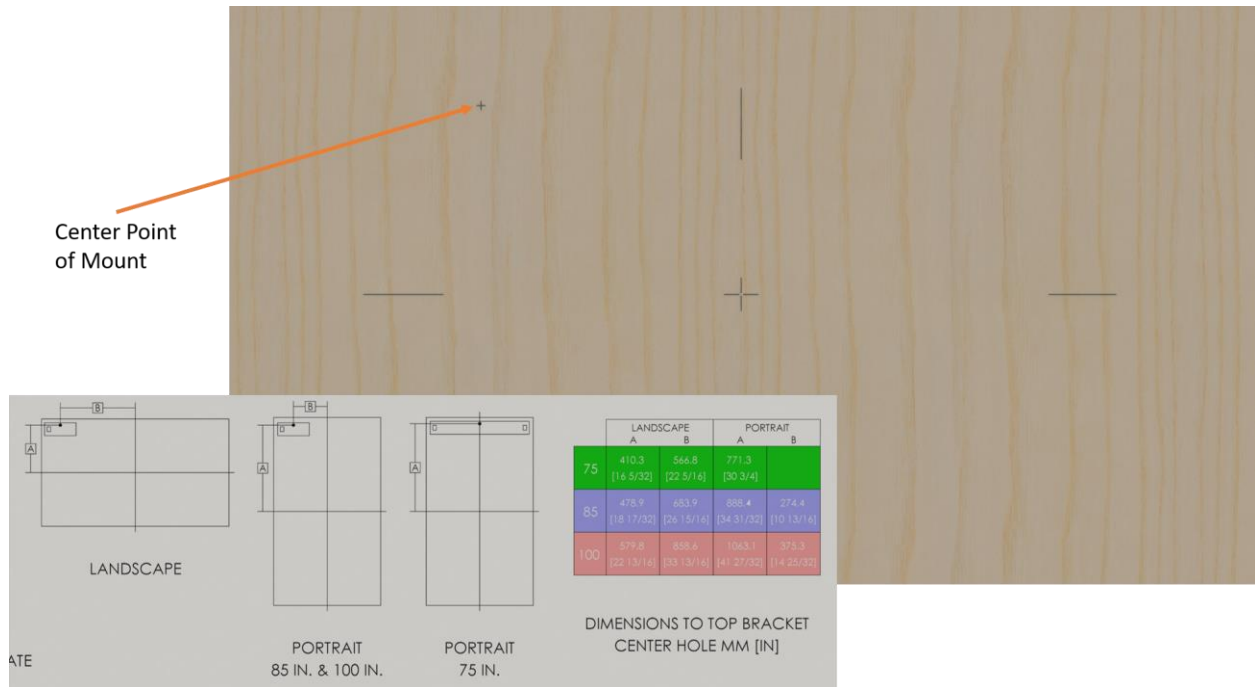

- Install the left mount as indicated. The marked position is the location of the center hole on the mount.



4. Level and install the main support screws. At minimum, two pieces of mounting hardware must be used on a single hanging mount component.



**Note:** When mounting, it is best practice to install hardware on either side of the hook to distribute the load both vertically and horizontally. Failure to do this may result in the panel flexing outward from the wall.

5. Place the opening in the template over the hook of the installed mount so it is resting against the back of the mount, level, and slightly pull to the right to find the labeled hole position for the model and orientation of the display being mounted. Mark this location on the structure.

**Note:** The “V” notch in the template labeled for the model being installed can be used to verify the center marks made in step 1 are correct. A slight variation in this location is okay due to being able to slightly move the display horizontally once installed.



6. Remove the template and install the right mount in the location marked. The marked position is again the location of the center hole on the mount.
7. Level and install the main support screws. At minimum, two pieces of mounting hardware must be used on a single hanging mount component.



8. Place template vertically on either hook of the installed hanging mounts.



9. Plumb the template, slightly pull down and mark the three locations of the service mounts attachment locations for the model product being installed.

**Note:** The “V” notch in the template labeled for the model being installed can be used to verify the center marks made in step 1 are correct.

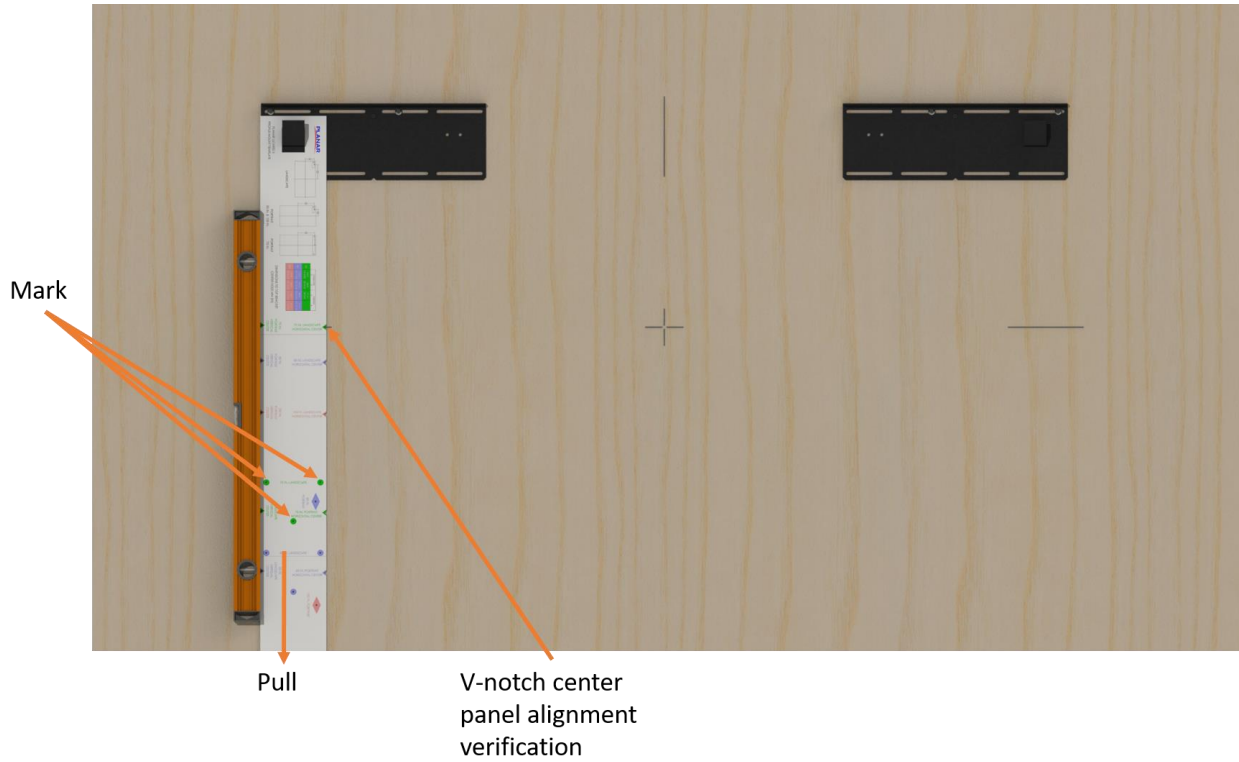

10. Remove the template and repeat steps 8-9 for the other hanging mount.



11. Install the service mounts where marked.

**Note:** Two of the side mount attachment locations are slotted, in case when the panel is installed there needs to be a slight vertical adjustment in location.

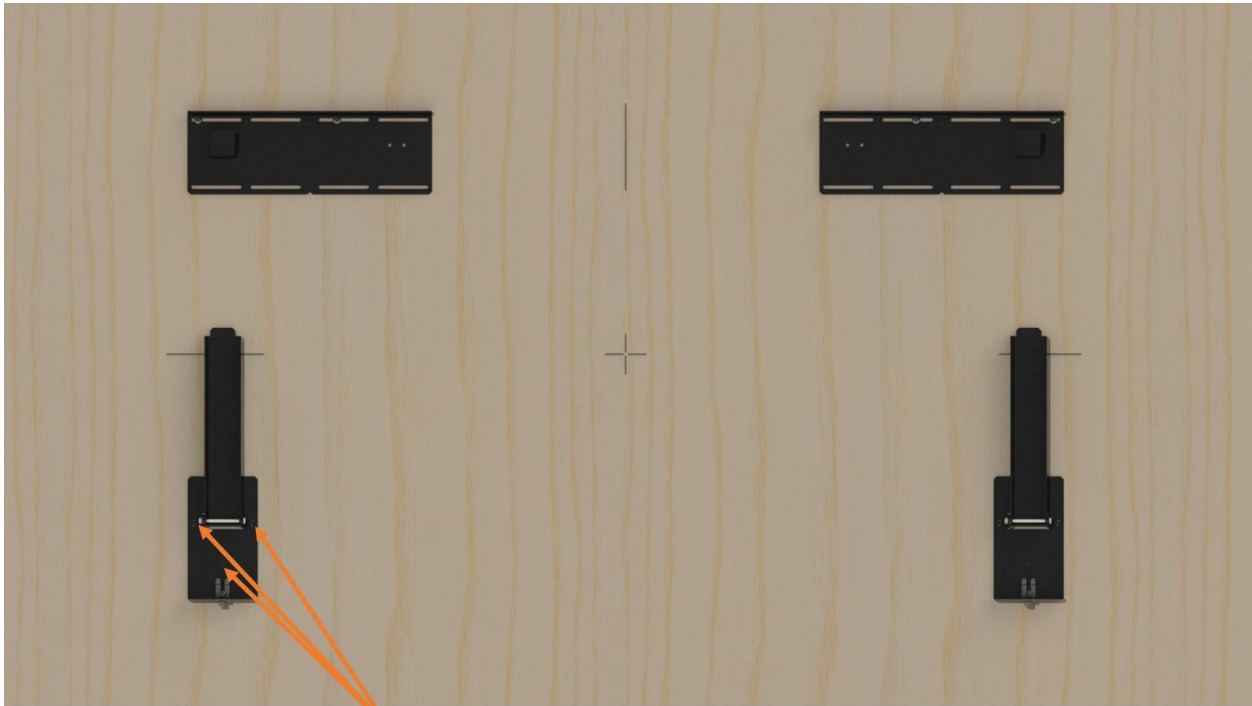

Install Hardware

12. Release the locking tabs on the service mounts so they do not interfere with the display installation.



Unscrew and  
let hang free



13. Hang the display on the mounting hooks where circled.

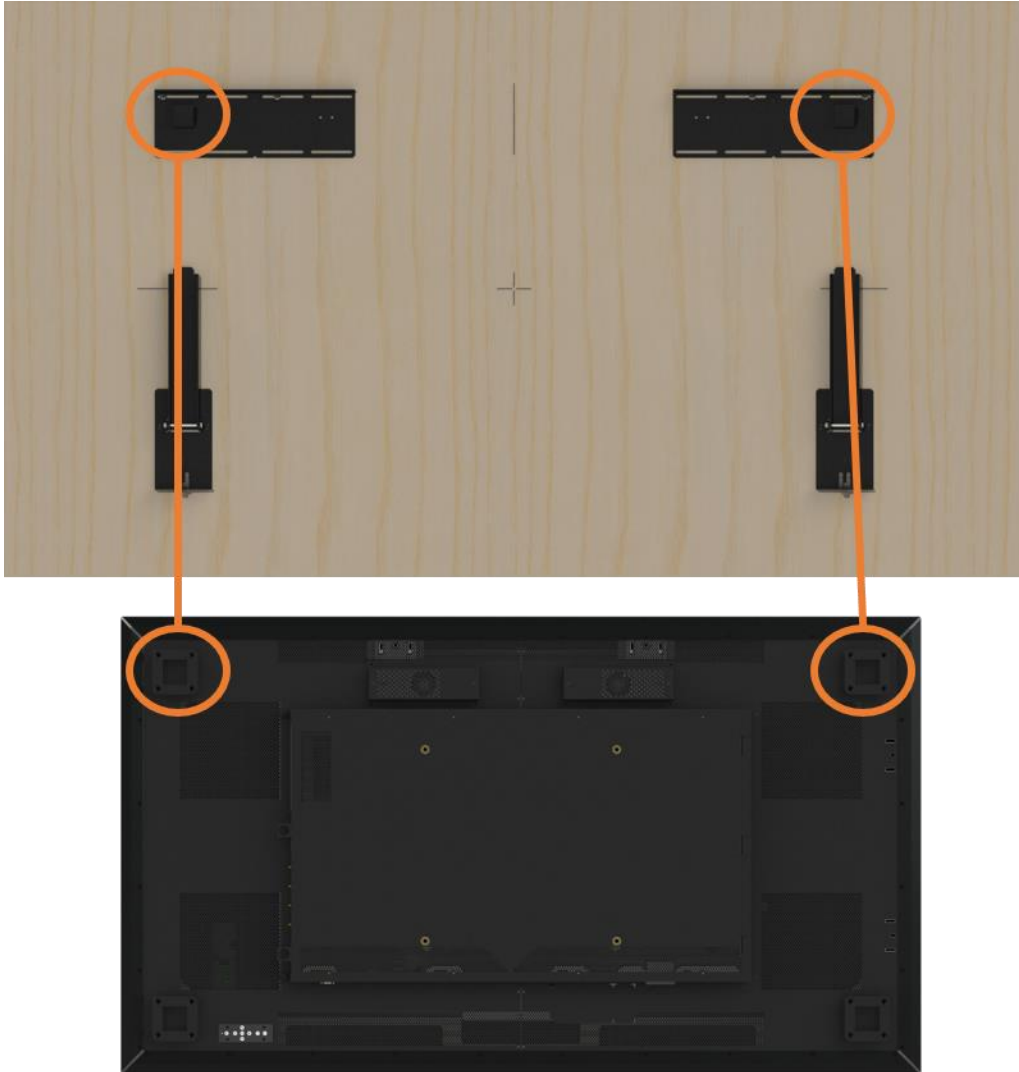

**Note:** It is recommended that capable lift equipment be used to install the displays due to their weight. Planar provides lifting eyes (sold separately) for use with capable equipment (see “Using the Lifting Eyes” on page 27). If mechanical equipment is unavailable or impractical, Planar supplies lifting straps for use with lifting displays.

**Caution:** Displays may be very heavy, make sure enough resources are available to lift displays into place on the mount structure.

14. If the panel interferes with the locking tabs or the locking tabs are unable to engage, adjust the vertical position of the service mounts to accommodate. Remove the center screw to make this adjustment.
15. Once the display is able to lay flat and the locking tabs engage with the bottom display mount brackets, the locking tabs may be re-tightened to the service mounts to keep the panel from being pulled out.

16. To gain easy access to the rear of the display to connect cables, use the kickstands on the service mounts. Rotate the kickstand down after pulling the panel out. The kickstands will nest into the lower panel mount brackets.

**Caution:** Use both kickstands. Using only one will cause stresses in the panel that can cause damage.

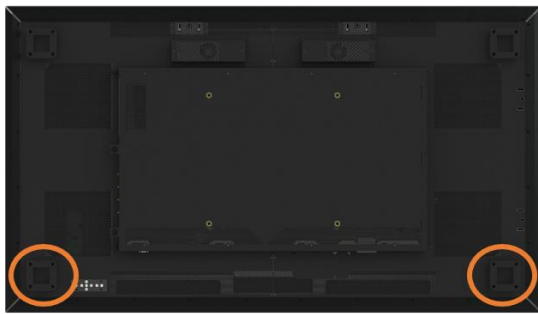

## 10.1 Using the Lifting Eyes

1. Slide the eye assemblies upward into the slots where shown. There will be a click when they are fully seated.

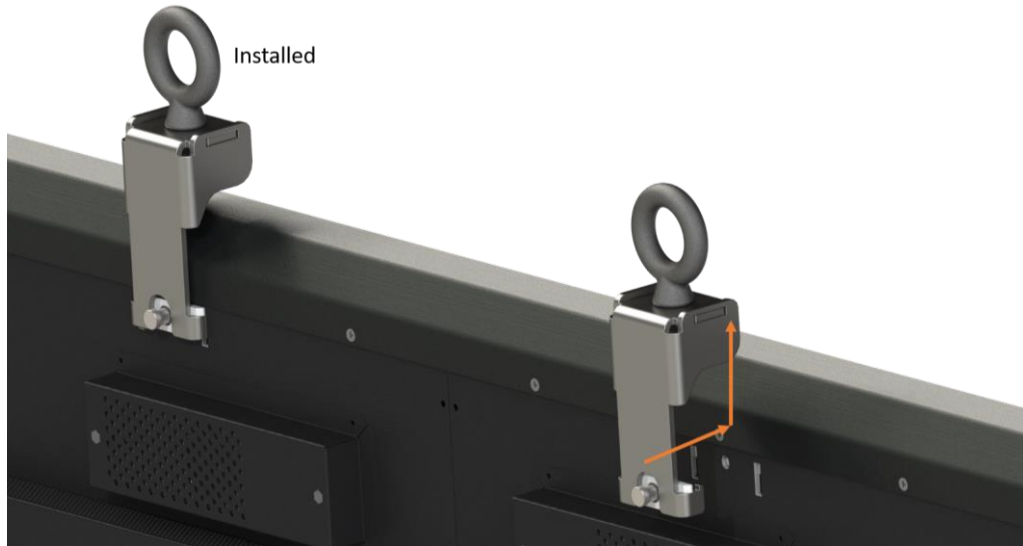

2. Securely attach the lift mechanism and note the requirements below for spacing. For a spreader bar application, the bar should be a minimum of 200mm (7.9") from the edge of the display. For a single point lifting application, the angle of the line between the eyehooks and the display must be 45° or greater.

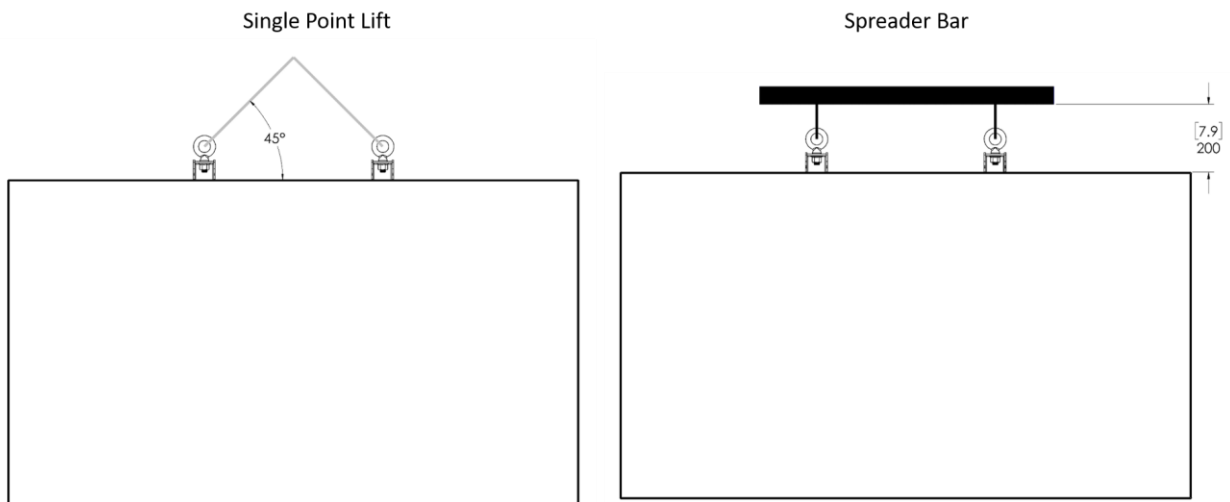

3. Lift the panel into place.
4. Remove the lift mechanism attached to the lifting eyes.

5. Remove the lifting eyes by pulling out the retaining pin, allowing the lifting eyes to slide down.

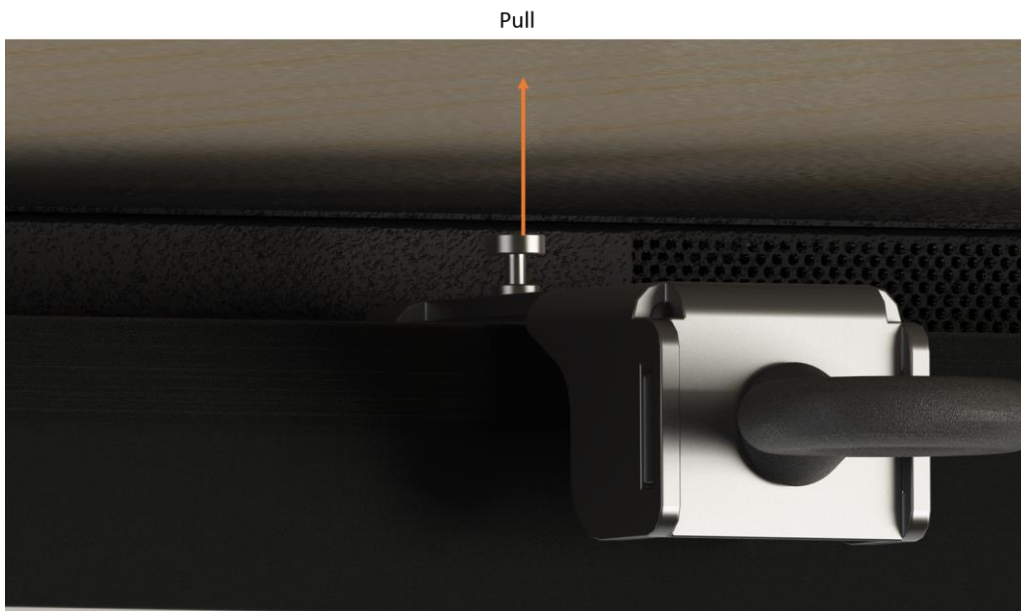

**Note:** To completely remove, it may be required to slide the lifting eyes horizontally past the hanging mounts after disengaging from the panel.

## 11. Installing OPS Expansion (Optional)

Planar UltraRes X Series displays are equipped with an expansion slot that supports the Intel® Open Pluggable Specification (OPS). The slot will support OPS devices such as PC's, SDI modules, HDBaseT receivers, etc.

To install an OPS device, remove the protective cover on the display and slide the device firmly into position. When installed, the OPS device will be connected internally to the display. No external video or power cables are required.

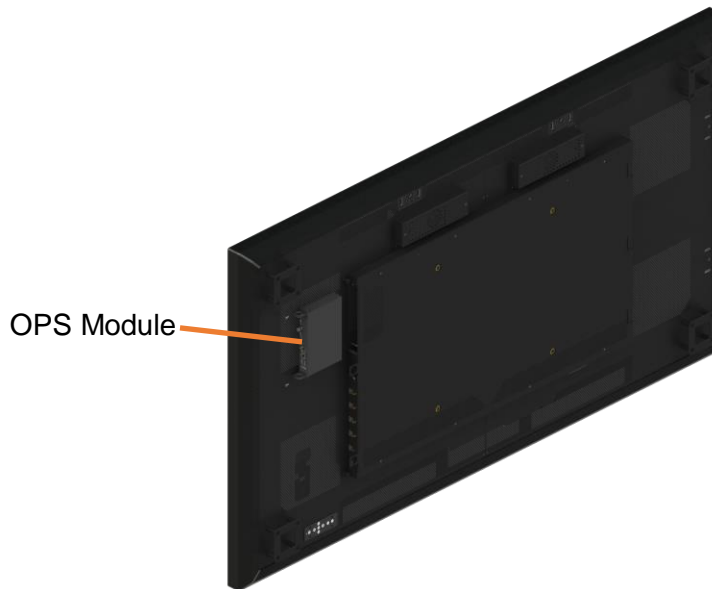

# Operating the Display

## 12. OSD Keypad

The OSD keypad is located on the rear of the display.

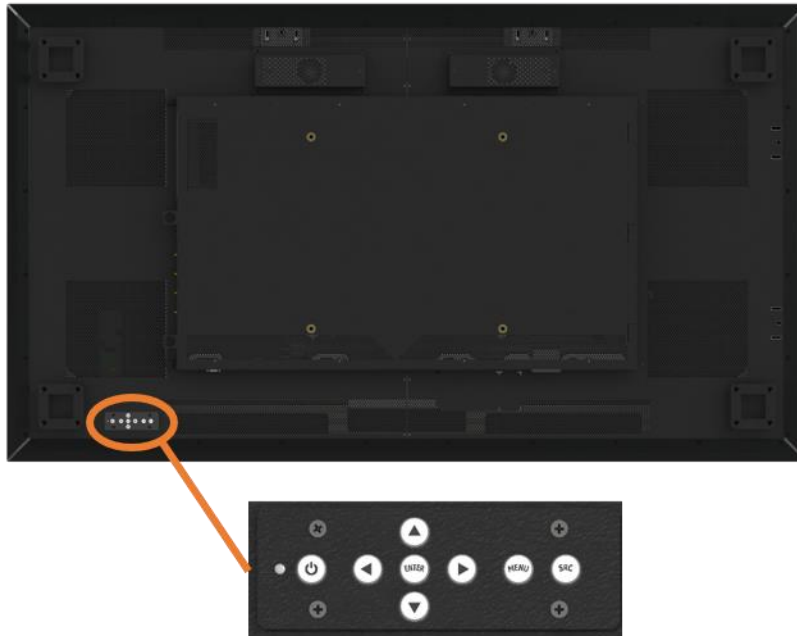

**OSD Keypad Buttons**

| Key       | Descriptions              |
|-----------|---------------------------|
| Power     | Power on/Power off        |
| ◀         | Menu Left/Decrease value  |
| ▶         | Menu Right/Increase value |
| ▲         | Menu Up/Increase volume   |
| ▼         | Menu Down/Decrease volume |
| Menu/Exit | Menu/Exit                 |
| Source    | Source selection (toggle) |

## 13. Remote Control Receiver

The remote control receiver is located near the keypad on the rear of the display. Use the IR extender cable for operating the remote from the front of the display.



## 14. LED Indicators

The LED indicator light is located on the rear of the display near the keypad. The following table explains what the different colors and blink patterns mean.

### LED On

| Power Status            | Condition                |
|-------------------------|--------------------------|
| Green                   | Standby mode             |
| Amber                   | Full power mode          |
| Green Flashing (1 Hz)   | AC power on              |
| Green Flashing (0.5 Hz) | Powering on from standby |
| Green Flashing (5 Hz)   | Firmware updating        |
| Amber Flashing (5 Hz)   | Power supply failure     |
| Green and Amber         | Firmware update failure  |

## 15. Using the Display in Portrait Mode

When using the display in the portrait position and looking at the rear of the display, it should be rotated according to the arrow stickers on the back of the display. This will allow for proper ventilation. Then select the OSD rotation of landscape or portrait on the OSD menu (MAIN MENU > ADVANCED SETTINGS > MENUS AND MESSAGES > OSD ROTATION).

For reference, the following list indicates the rotation direction of each display model when placed in portrait mode as viewed from the display side:

- URX75(-ERO)(-T): Clockwise
- URX85(-ERO)(-T): Clockwise
- URX100(-ERO)(-T): Clockwise

**Caution:** Failure to follow these instructions will void the warranty.

## 16. Using the Display in Flat or Tilted Orientation

The display is not recommended for use in flat orientation for tabletop, floor, or ceiling installations. LCD panels of this size are at risk of panel deflection, which can cause cosmetic sagging, brightness uniformity issues, a shortened life span, and malfunction of optional touch sensors. Installations where the display is tilted downward or upward at an angle may also be prone to these issues and are not recommended.

**Note:** Failure to follow these instructions will void the warranty.



## 17. Using the Remote Control

Below is a picture of the remote control and its corresponding Hex codes. See the following page for button descriptions and Hex codes.



## 18. IR Command Protocol

The Planar UltraRes X Series displays accept commands in the form of IR signals that conform to the NEC protocol. Each Planar UltraRes X Series remote control has an NEC control code associated with it. You can use these codes to program a third-party “universal” remote control to work with the Planar UltraRes X Series displays. These third-party products usually come with a computer software application for this purpose. For more information, consult the documentation provided with the remote control.

The IR control codes have the following characteristics:

- Each code consists of the following:
  - A leader pulse (a modulated pulse of 9 ms followed by a non-modulated pulse of 4.5 ms)
  - 16 address bits. The default address is 1785 (0x06F9, binary 00000110 11111001)
  - 16 data bits: eight (8) bits for the command followed by the logical inverse of the command
  - An end pulse (a modulated pulse of 0.56 ms, similar to the modulated pulse in the ‘0’ and ‘1’ bits). The end of the modulated pulse constitutes the end of the data transmission.
  - The carrier frequency is 38 kHz, with the modulated pulses having a 33% duty cycle.
  - Commands are sent at a maximum rate of 9 Hz.

For example, below is the NEC control code for the ON button of the Planar UltraRes X Series remote control (assuming the default address is used).

|                 |                       |                       |                |                                  |
|-----------------|-----------------------|-----------------------|----------------|----------------------------------|
| <b>Hex</b>      | <b>06</b>             | <b>F9</b>             | <b>01</b>      | <b>FE</b>                        |
| <b>Binary</b>   | 00000110              | 11111001              | 00000001       | 11111110                         |
| <b>Function</b> | <b>Address Byte 1</b> | <b>Address Byte 2</b> | <b>Command</b> | <b>Command (Logical Inverse)</b> |
|                 | <b>1</b>              | <b>2</b>              |                |                                  |

The following example shows the pulse train for this command.



| Remote Control Button Name | Address | Data | NEC Data From Remote (Hex Code) | Description            |
|----------------------------|---------|------|---------------------------------|------------------------|
| ON                         | 1785    | 1    | 0x06F901FE                      | Power on               |
| OFF                        | 1785    | 9    | 0x06F909F6                      | Power off              |
| ◀                          | 1785    | 2    | 0x06F902FD                      | Not used               |
| ▶                          | 1785    | 3    | 0x06F903FC                      | Not used               |
| **                         | 1785    | 6    | 0x06F906F9                      | Not used               |
| PRESETS                    | 1785    | 4    | 0x06F904FB                      | Opens the Presets menu |
| PRESET 1                   | 1785    | 5    | 0x06F905FA                      | Applies Preset 1       |
| PRESET 2                   | 1785    | 7    | 0x06F907F8                      | Applies Preset 2       |
| PRESET 3                   | 1785    | 8    | 0x06F908F7                      | Applies Preset 3       |
| PRESET 4                   | 1785    | 10   | 0x06F90AF5                      | Applies Preset 4       |
| 1                          | 1785    | 12   | 0x06F90CF3                      | Number button 1        |
| 2                          | 1785    | 13   | 0x06F90DF2                      | Number button 2        |
| 3                          | 1785    | 14   | 0x06F90EF1                      | Number button 3        |
| 4                          | 1785    | 15   | 0x06F90FF0                      | Number button 4        |
| 5                          | 1785    | 16   | 0x06F910EF                      | Number button 5        |
| 6                          | 1785    | 17   | 0x06F911EE                      | Number button 6        |
| 7                          | 1785    | 20   | 0x06F914EB                      | Number button 7        |
| 8                          | 1785    | 25   | 0x06F919E6                      | Number button 8        |
| 9                          | 1785    | 27   | 0x06F91BE4                      | Number button 9        |
| 0                          | 1785    | 18   | 0x06F912ED                      | Number button 0        |
| VOL +                      | 1785    | 28   | 0x06F91CE3                      | Volume increase        |
| VOL -                      | 1785    | 33   | 0x06F921DE                      | Volume decrease        |
| MUTE                       | 1785    | 32   | 0x06F920DF                      | Audio mute             |
| COLOR                      | 1785    | 19   | 0x06F913EC                      | Not used               |

| Remote Control Button Name | Address | Data | NEC Data From Remote (Hex Code) | Description                              |
|----------------------------|---------|------|---------------------------------|--|
| VIDEO WALL                 | 1785    | 34   | 0x06F922DD                      | Opens the Tiling menu                    |
| MISC                       | 1785    | 11   | 0x06F90BF4                      | Opens the Image Information menu         |
| MENU                       | 1785    | 21   | 0x06F915EA                      | Opens the menu                           |
| PREV                       | 1785    | 22   | 0x06F916E9                      | Returns to the previous menu             |
| ENTER                      | 1785    | 23   | 0x06F917E8                      | Selects the current menu item            |
| UP                         | 1785    | 26   | 0x06F91AE5                      | Navigate up                              |
| LEFT                       | 1785    | 29   | 0x06F91DE2                      | Navigate left                            |
| RIGHT                      | 1785    | 31   | 0x06F91FE0                      | Navigate right                           |
| DOWN                       | 1785    | 24   | 0x06F918E7                      | Navigate down                            |
| TOP                        | 1785    | 30   | 0x06F91EE1                      | Selects the top line in the current menu |
| ZONE 1                     | 1785    | 35   | 0x06F923DC                      | Selects the input for Zone 1             |
| ZONE 2                     | 1785    | 36   | 0x06F924DB                      | Selects the input for Zone 2             |
| ZONE 3                     | 1785    | 38   | 0x06F926D9                      | Selects the input for Zone 3             |
| ZONE 4                     | 1785    | 39   | 0x06F927D8                      | Selects the input for Zone 4             |
| PIP MODE                   | 1785    | 37   | 0x06F925DA                      | Selects the Multi-Source View setting    |
| PIP SWAP                   | 1785    | 40   | 0x06F928D7                      | Swaps the main and PIP windows           |
| HDMI 1                     | 1785    | 41   | 0x06F929D6                      | Selects HDMI 1 for the current zone      |
| HDMI 2                     | 1785    | 42   | 0x06F92AD5                      | Selects HDMI 2 for the current zone      |
| HDMI 3                     | 1785    | 43   | 0x06F92BD4                      | Selects HDMI 3 for the current zone      |
| HDMI 4                     | 1785    | 44   | 0x06F92CD3                      | Selects HDMI 4 for the current zone      |
| DP                         | 1785    | 45   | 0x06F92DD2                      | Selects DP for the current zone          |
| DVI                        | 1785    | 46   | 0x06F92ED1                      | Not used                                 |
| VGA                        | 1785    | 47   | 0x06F92FD0                      | Not used                                 |
| OPS                        | 1785    | 48   | 0x06F930CF                      | Selects OPS for the current zone         |

## 18.1 Locking the Keypad and IR Remote

You can lock the keypad and IR remote functionality on the display. To lock the keypad, go to Main Menu -> Advanced Settings -> System Settings and select Keypad Lock. To lock the IR remote, go to Main Menu -> Advanced Settings -> System Settings and select IR Remote Lock.

## 18.2 Unlocking the Keypad and IR Remote

To unlock the keypad, press the following keys on the keypad in the order listed: UP, UP, RIGHT, LEFT, DOWN. If the IR remote is unlocked, you can also unlock the keypad by using the IR remote to go to Main Menu -> Advanced Settings -> System Settings and uncheck Keypad Lock.

To unlock the IR remote, press the following keys on the IR remote in the order listed: UP, UP, RIGHT, LEFT, DOWN. If the keypad is unlocked, you can also unlock the IR remote by using the keypad to go to Main Menu -> Advanced Settings -> System Settings and uncheck IR Remote Lock.

## 18.3 Changing the IR Remote Code Set

The IR remote code set transmitted by the remote and accepted by the display can be configured. This is useful if there are multiple Planar displays and you would like each remote to work only with one of the displays. It can also be used if IR interference with another device, such as a DVD player, is occurring.

To change the IR code on the remote, use the following procedure:

1. Press and hold the CODE button on the remote control until the LED on the remote lights solid red (approximately five seconds).
2. Enter a new five-digit code between 00000 and 65535. Include leading zeros for codes with four or fewer digits; for example, enter 255 as 00255.
3. The LED turns off to confirm the code change. If you enter an invalid code, the LED flashes for three or four seconds. Try again, entering a valid code.

**Note:** The code must match the IR Remote ID Code setting. See page 68.

## 18.4 Turning the Display On

1. Insert the power cord into the display and into the power outlet.
2. Ensure the AC switch is set to “—“.
3. Press the ON button on the remote or the power button on the keypad.

## 18.5 Turning the Display Off

With the power on, press the OFF button on the remote or the power button on the keypad to put the LCD panel in a standby mode. To turn off power completely, turn the AC switch to “O” or disconnect the AC power cord from the power outlet.

**Note:** The display may automatically turn off the backlight or enter standby mode if no signal is present for a certain period of time. See the description of the Power Saving Mode setting on page 48 for more information.

## 18.6 Adjusting the Volume

1. Using the remote, press the vol + or vol - to increase or decrease the volume. You can also use the Up and Down keys on the remote and keypad to increase or decrease the volume.
2. Press the mute button to temporarily turn off all sound. To restore the sound, press the mute button again.

**Note:** The analog audio out is variable. S/PDIF is fixed.

## 18.7 Selecting Layouts and Input Sources

With Planar MediaPlex Plus Processing, you can show one source at a time or multiple sources simultaneously. Multiple layout options are available and can be selected from the Inputs and Views Menu (see page 36). Once a layout has been designated, you can assign sources to each of the zones in the layout. The selection of sources must be made one at a time by assigning a current zone. To select the current zone, you can navigate through the on-screen menu (see page 36). Alternatively, you can use the remote or keypad as described next.

### Remote

Press the Zone 1, Zone 2, Zone 3, or Zone 4 buttons on the remote. After selecting the desired zone, you can press the source button (DP, HDMI 1, HDMI 2, HDMI 3, HDMI 4, or OPS). This action will also select the active audio source.

For example, to change Zone 3 to OPS, press the Zone 3 button and then press the OPS button.

### Keypad

Press the SRC button. The input source will be toggled in the following order: HDMI 1, HDMI 2, HDMI 3, HDMI 4, DP, OPS).

**Note:** Sources will toggle through the current zone, or last zone to be modified. Current zones can only be re-assigned in the on-screen menu.

## 18.8 Navigating Through the Menus

1. With the power on, press MENU. The MAIN menu appears.

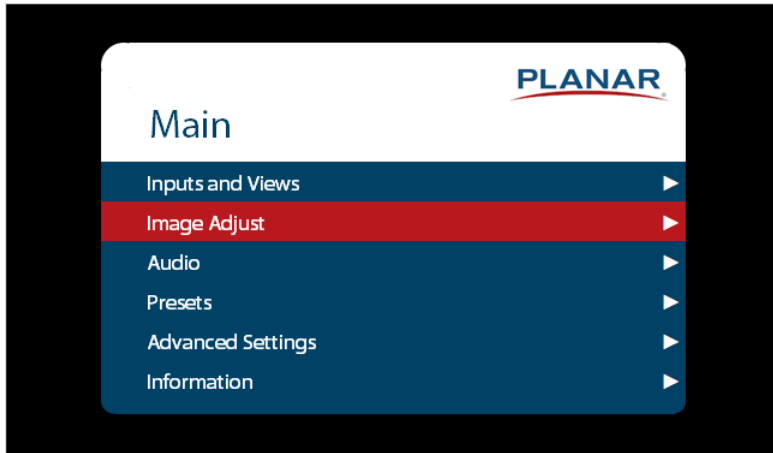

2. Within the menu, use ▲, ▼, ◀, ▶, and ENTER to navigate through the menus and adjust options.
3. Press PREV on the remote control, or MENU on the keypad, to return to the previous menu. To exit the menu system, press MENU on the remote control, or continue to press menu on the keypad until the main menu is reached.

## 19. Inputs and Views Menu

This menu shows how the sources will be laid out on the screen based on the current Multi-Source View and Advanced Layouts selections.

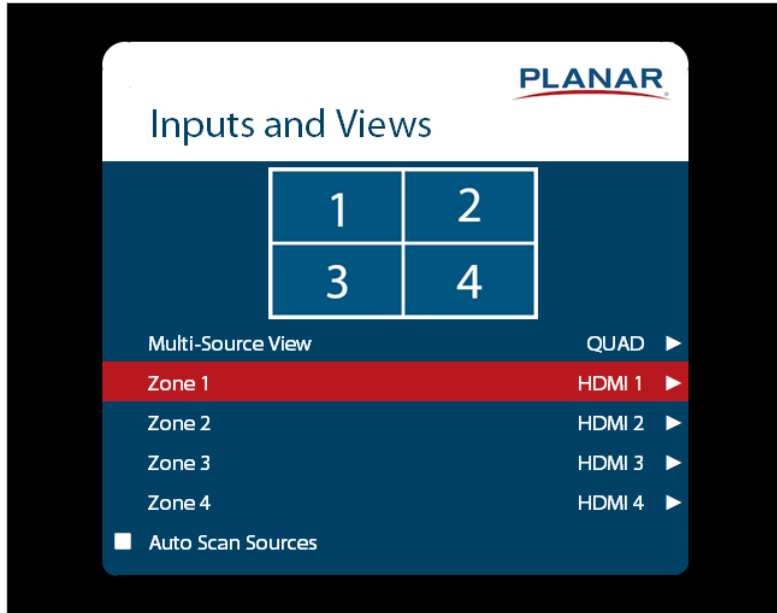

### Multi-Source View

- Select the Multi-Source View mode
- **Options:** Single, Dual, Triple, Quad, PIP; Default: Single
- **Note:** For the Advanced Layouts submenu, refer to page 41.
- **Note:** You can only use 4K/60Hz in Single mode.

### Zone 1

- Select the source displayed in Zone 1
- **Options:** HDMI 1, HDMI 2, HDMI 3, HDMI 4, DP, OPS; **Default:** HDMI 1
- **Note:** If HDMI1 was selected as another source, OPS cannot be selected. If OPS was selected as another source, HDMI1 cannot be selected.

### Zone 2

- Select the source displayed in Zone 2
- **Options:** HDMI 1, HDMI 2, HDMI 3, HDMI 4, DP, OPS; **Default:** HDMI 2
- **Note:** If HDMI1 was selected as another source, OPS cannot be selected. If OPS was selected as another source, HDMI1 cannot be selected.

### Zone 3

- Select the source displayed in Zone 3
- **Options:** HDMI 1, HDMI 2, HDMI 3, HDMI 4, DP, OPS; **Default:** HDMI 3
- **Note:** If HDMI1 was selected as another source, OPS cannot be selected. If OPS was selected as another source, HDMI1 cannot be selected.



## Zone 4

- Select the source displayed in Zone 4
- **Options:** HDMI 1, HDMI 2, HDMI 3, HDMI 4, DP, OPS; **Default:** HDMI 4
- **Note:** If HDMI1 was selected as another source, OPS cannot be selected. If OPS was selected as another source, HDMI1 cannot be selected.

## Auto Scan Sources

- Select whether the display will automatically scan for a valid source on any input or zone that does not have a source currently displayed. Scanning will begin on the currently selected source, and move sequentially through the inputs in the order listed below – stopping once a valid source is obtained.
- **Options:** HDMI 1, HDMI 2, HDMI 3, HDMI 4, DP, OPS

## Advanced Layouts Submenu

This submenu defines the layouts for each multi-source view type.

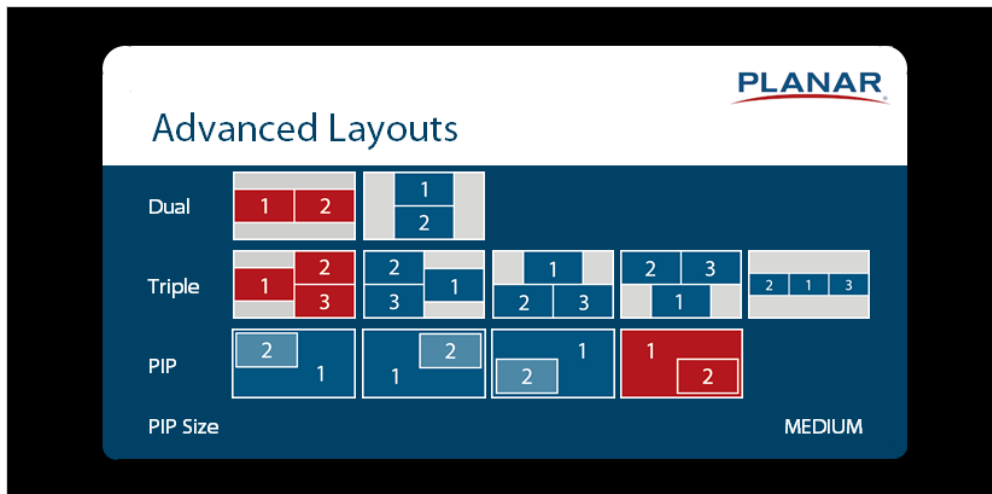

### Dual

- Select from two dual source layout options. The layout in orange will be the active layout displayed when the Multi-Source View is set to Dual.

### Triple

- Select from five triple source layout options. The layout in orange will be the active layout displayed when the Multi-Source View is set to Triple.

### PIP

- Select from four PiP (Picture-in-Picture) layouts. The layout in orange will be the active layout displayed when the Multi-Source View is set to PiP.

### PIP Size

- Select the size of the PiP (Picture-in-Picture) window.

## 19.1 Image Adjust Menu

This menu is used for making common image adjustments for the current zone.

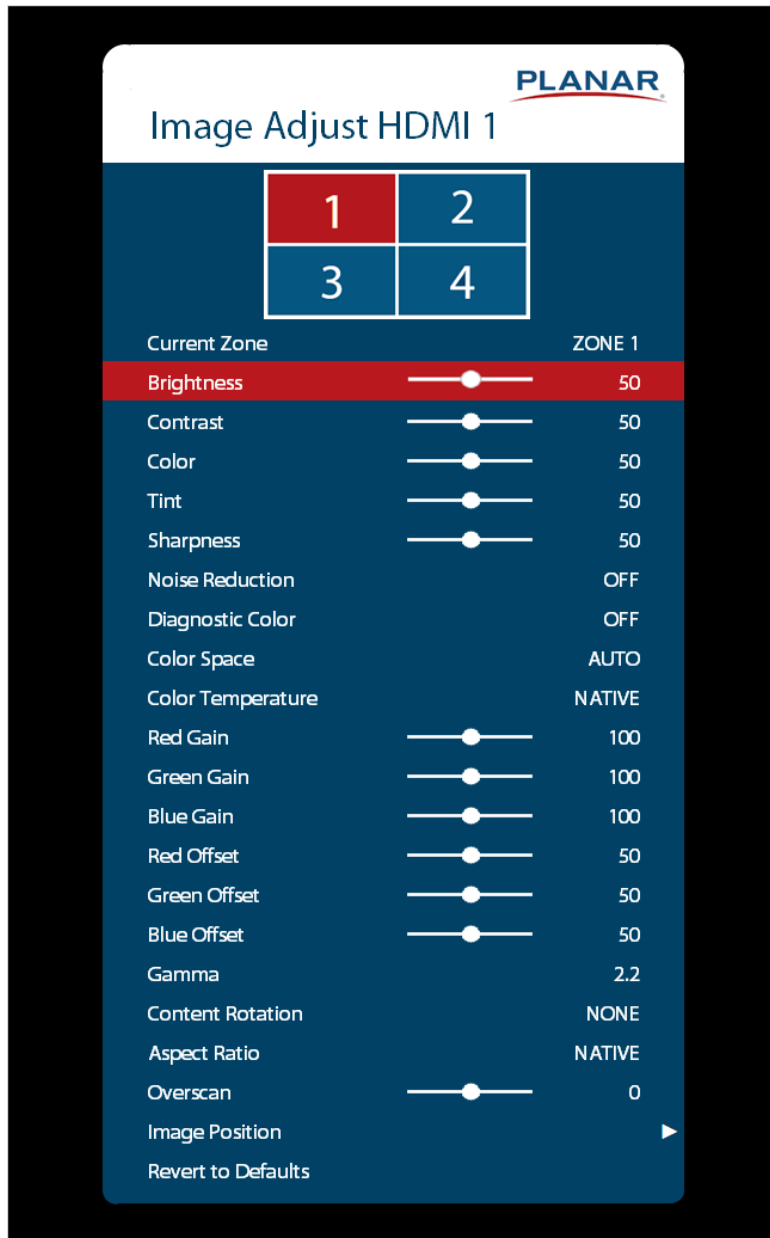

### Current Zone

- The zone that is currently being adjusted. All of the settings in this menu are saved per input. The zone's corresponding input source is shown in the title bar, and the graphic beneath that shows which zone is being adjusted in the current Multi-Source View mode and Advanced Layout setting (if applicable).
- The current zone can be changed via the menu or by using the ZONE 1-4 keys on the remote control.
- **Note:** Changing the Current Zone setting via the ZONE 1-4 keys also changes the Audio Select setting.

## Brightness

- Adjust the black level of the image
- **Range:** 0~100; **Default:** 50

## Contrast

- Adjust the white level of the image
- **Range:** 0~100; **Default:** 50

## Color

- Adjust the saturation of the image
- **Range:** 0~100; **Default:** 50

## Tint

- Adjust the hue of the image
- **Range:** 0~100; **Default:** 50

## Sharpness

- Adjust the sharpness of the image. Higher numbers are sharper
- **Range:** 0~10; **Default:** 5

## Noise Reduction

- Turn on noise reduction processing
- **Options:** Off, Low, Medium, High; **Default:** Off

## Diagnostic Color

- Set the image to monochrome. This setting is for use in adjustments to a test pattern and is not stored.
- **Options:** Off, Red, Green, Blue; **Default:** Off

## Color Space

- Set the color space of the image
- **Options:** REC601, REC709, RGB, RGB Video, Auto; **Default:** Auto

## Color Temperature

- Set the color temperature of the image
- **Options:** 3200K, 5500K, 6500K, 7500K, 9300K, Native; **Default:** Native

## Red Gain

- Adjust the red gain of the image
- **Range:** 0~200; **Default:** 100

## Green Gain

- Adjust the green gain of the image
- **Range:** 0~200; **Default:** 100

## Blue Gain

- Adjust the blue gain of the image
- **Range:** 0~200; **Default:** 100

### Red Offset

- Adjust the red offset of the image
- **Range:** 0~100; **Default:** 50

### Green Offset

- Adjust the green offset of the image
- **Range:** 0~100; **Default:** 50

### Blue Offset

- Adjust the blue offset of the image
- **Range:** 0~100; **Default:** 50

### Gamma

- Set the gamma of the image
- **Options:** 1.5, 1.55, 1.6, 1.65, 1.7, 1.75, 1.8, 1.85, 1.9, 1.95, 2.0, 2.05, 2.1, 2.15, 2.2, 2.25, 2.3, 2.35, 2.4, 2.45, 2.5, 2.55, 2.6, 2.65, 2.7, 2.75, 2.8
- **Default:** 2.2

### Content Rotation

- Rotate the image on the display
- **Options:** None, 90, 180, 270; **Default:** None

### Aspect Ratio

- Set how the source is treated when the aspect ratio of the input is different than the aspect ratio of the zone it is in. If the image does not fill the zone completely, the extra margins are black.
- **Options:** Auto, 16:9, 4:3, Fill Screen, Native, Letterbox; **Default:** Auto

### Overscan

- Set the percentage of the image to remove from each edge
- **Range:** 0~20; **Default:** 0

### Image Position

- Move the image horizontally or vertically. The amount to move is measured in input pixels.
- **Range:** -1000~1000; **Default:** 0

### Revert to Defaults

- Reset all settings in the Image Adjust menu to their factory defaults for the current zone only

## 19.2 Audio Menu

This menu enables you to make audio adjustments to the selected zone.

**Note:** Volume, Bass, Treble and Balance do not apply to the S/PDIF output.

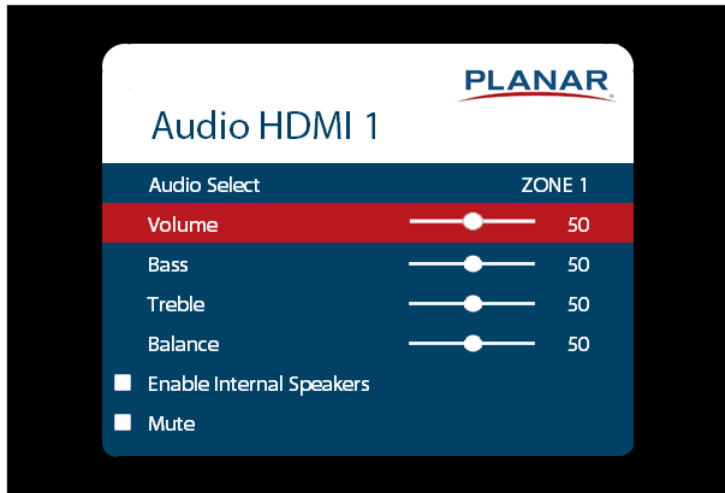

### Audio Select

- The zone that is currently being adjusted and whose audio is being played. The zone's corresponding input source is shown in the title bar.
- **Options:** Zone 1, Zone 2, Zone 3, Zone 4; **Default:** Zone 1
- **Note:** Changing the Audio Select setting via the ZONE 1-4 keys also changes the Current Zone setting.

### Volume

- Set the volume of the audio
- **Range:** 0~100; **Default:** 50

### Bass

- Set the bass level
- **Range:** 0~100; **Default:** 50
- **Note:** This setting applies only to the internal speakers, and cannot be adjusted for the Line Out connector.

### Treble

- Set the treble level
- **Range:** 0~100; **Default:** 50
- **Note:** This setting applies only to the internal speakers, and cannot be adjusted for the Line Out connector.

### Balance

- Set the audio balance
- **Range:** 0~100; **Default:** 50

## Enable Internal Speakers

- Disable or enable the built-in speakers
- **Options:** On, Off; **Default:** On

## Mute

- Mute or unmute the audio
- **Options:** On or Off; **Default:** Off

## 19.3 Presets Menu

This menu enables you to save Inputs and Views settings, Image Adjust settings, Audio settings, the Backlight Intensity setting, the Local Dimming setting, and Tiling settings. You can save up to 10 presets using this menu (more can be saved via the serial command interface). If a preset is saved, it will appear as “Preset 1”, “Preset 2”, and so on. If it is not saved, it will appear as “<Empty>”.



### Recall

- Apply the setup from the selected preset
- **Range:** Preset 1~Preset 10

### Save

- Save the current setup for later recall
- **Range:** Preset 1~Preset 10

### Delete

- Delete the selected preset
- **Range:** Preset 1~Preset 10

## 19.4 Advanced Settings Menu

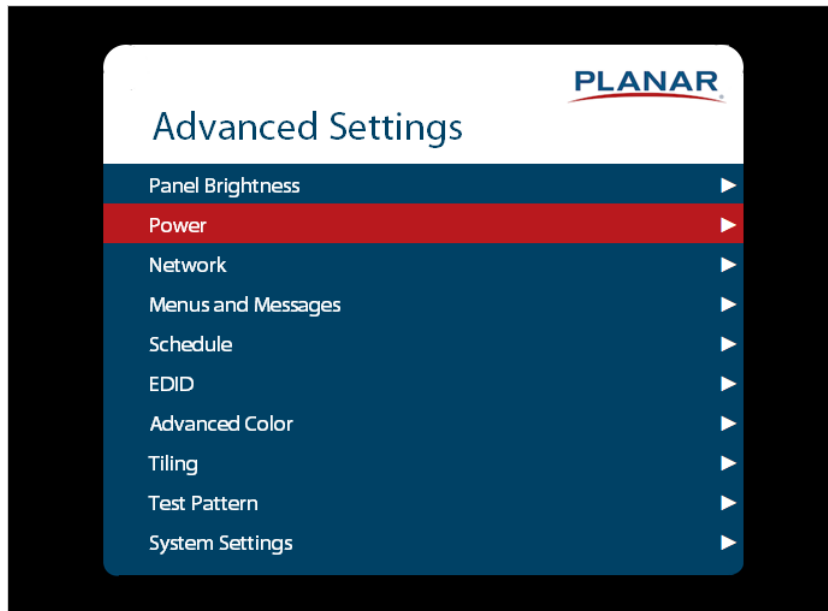

### Panel Brightness Submenu



#### Intensity

- Set the intensity of the LCD backlight
- **Range:** 0~100; **Default:** 75

#### Local Dimming

- Turn on or off the local dimming function, if supported by the display
- **Options:** On, Off; **Default:** On
- **Note:** 75" and 85" models only

## Power Submenu

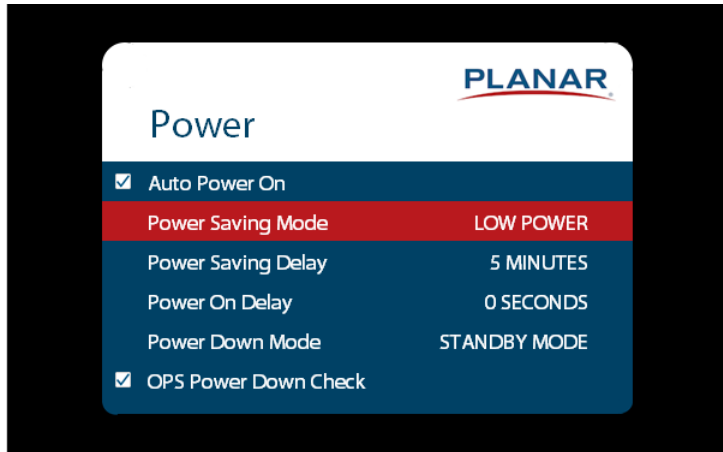

### Auto Power On

- If set to On, the display will automatically leave standby after AC power is applied
- **Options:** On, Off; **Default:** Off

### Power Saving Mode

- Set the action to take if there is no signal detected after the period of time specified by the **Power Saving Delay** setting
- **Options:** Disabled, Power Down, Wake on Signal; **Default:** Disabled
  - **Disabled:** Once powered on, the display will remain on even if no signal is present.
  - **Power Down:** The display will enter a standby state specified by the **Power Down Mode** setting.
  - **Wake On Signal:** The display will enter a standby sleep mode if no signal is detected. The display will wake when signal is restored.
    - **Note:** When signal is restored, a 10-15 second wait is typical to have an image displayed.
    - **Note:** The display must be allowed to enter sleep mode due to lack of signal for **Wake On Signal** to take effect. Sending an OFF command via Keypad, IR, CEC, RS232 or LAN will bypass **Wake On Signal** detection, and the display will enter the power state specified in the **Power Down Mode** setting.
    - **Note:** If **Auto Scan Sources** is enabled in the **Inputs and Views** menu, the display will sequentially scan all inputs before entering sleep mode. The display will leave sleep mode when a signal is detected on any input.
    - **Note:** If **Auto Scan Sources** is disabled in the **Inputs and Views** menu, the display leave sleep mode only when a signal is detected on the last selected input.
    - **Note:** When **Wake On Signal** is selected, the LAN port and **Remote Monitoring** web interface will remain accessible after the display enters sleep mode.



### Power Saving Delay

- Sets the amount of time before initiating the standby state specified in **Power Saving Mode** when no signal is present
- **Options:** 1 Minute, 5 Minutes, 15 Minutes, 30 Minutes, 60 Minutes; **Default:** 5 Minutes

### Power On Delay

- Sets the amount of time to delay between an ON command being received and the display leaving standby. This can be useful when multiple displays are on the same electrical circuit, and it is beneficial to avoid all displays leaving standby simultaneously, causing a large inrush of current.
- **Options:** 0-10 seconds, in 0.1 second increments; **Default:** 0 seconds

### Power Down Mode

- Set the action to take when the display enters standby
- **Options:** Standby Mode, Networked Standby Mode, Fast Start; **Default:** Standby Mode
- **Standby Mode:** The lowest power standby setting. CEC, LAN, DB9 RS232, and USB communication are disabled. IR, Keypad connector will remain active.
  - **Note:** To remove display from standby with the IR remote or keypad, IR Remote Lock or Keypad Lock must be disabled.
  - **Note:** The Turn On action in the Schedule feature will not work if the **Power Down Mode** setting is set to **Standby Mode**. To allow the Turn On action to occur, set **Power Down Mode** to **Networked Standby Mode** or **Fast Start**.
- **Networked Standby Mode:** The display will enter a low power standby state with LAN, DB9 RS232, USB and IR communications active.
- **Fast Start:** The display will enter a standby state with partially reduced power, allowing for 3-5 second wait between an ON command being sent, and image being displayed. IR, Keypad, CEC, LAN, DB9 RS232, and USB communication will remain active.

### OPS Power Down Check

- When enabled, the system will wait for an indication from the OPS module that it has finished its power down sequence, before going into the standby state specified in **Power Down Mode**
- **Options:** Disable, Enable; **Default:** Enable

## Network Submenu

The default static IP values are:

- IP Address: 192.168.12.12
- Subnet Mask: 255.255.255.0
- Default Gateway: 192.168.12.1

The static IP settings that you program will be used if a DHCP server cannot be found.

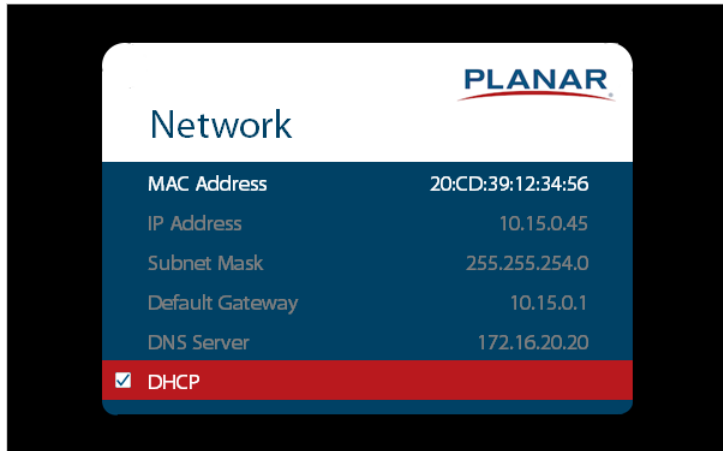

### MAC Address

- The MAC address of the system

### IP Address

- The current network address. You can use the number keys on the remote to enter this information.

### Subnet Mask

- The current subnet mask. You can use the number keys on the remote to enter this information.

### Default Gateway

- The current default gateway. You can use the number keys on the remote to enter this information.

### DNS Server

- The current DNS server. You can use the number keys on the remote to enter this information.
- **Note:** The specified DNS server is used when Use Network Time is checked for the Set Date and Time setting.

### DHCP

- Turn DHCP on or off
- **Options:** On, Off; **Default:** On

## Menus and Messages Submenu

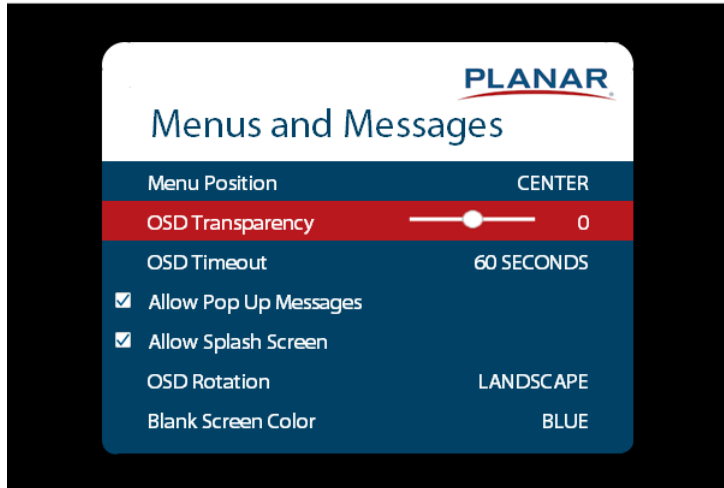

### Menu Position

- Move the OSD menu to a different location on the screen
- **Options:** Center, Upper Left, Upper Right, Lower Left, Lower Right; **Default:** Center

### OSD Transparency

- Set the transparency of the OSD so that the image behind it can be seen. Higher values mean greater transparency.
- **Range:** 0~5; **Default:** 0

### OSD Timeout

- Set the amount of time in seconds since the last keypress before the OSD menu automatically closes. If set to Off, the menu never automatically closes.
- **Options:** Off, 10 Seconds, 30 Seconds, 60 Seconds, 120 Seconds, 240 Seconds; **Default:** 60 Seconds

### Allow Pop Up Messages

- Suppress messages that pop up automatically. When set to No, the source status message and the volume slider bar will not be displayed.
- **Options:** Yes or No; **Default:** Yes

### Allow Splash Screen

- Enable or disable the splash screen during startup
- **Options:** Enable or Disable; **Default:** Enable

### OSD Rotation

- Rotate the OSD menu so that it is readable if the display is mounted in portrait orientation
- **Options:** Landscape or Portrait; **Default:** Landscape

### Blank Screen Color

- Select the color to display when there is no signal in a zone
- **Options:** Black, White, Gray, Red, Green, Blue, Cyan, Magenta, Yellow
- **Default:** Black

## Schedule Submenu

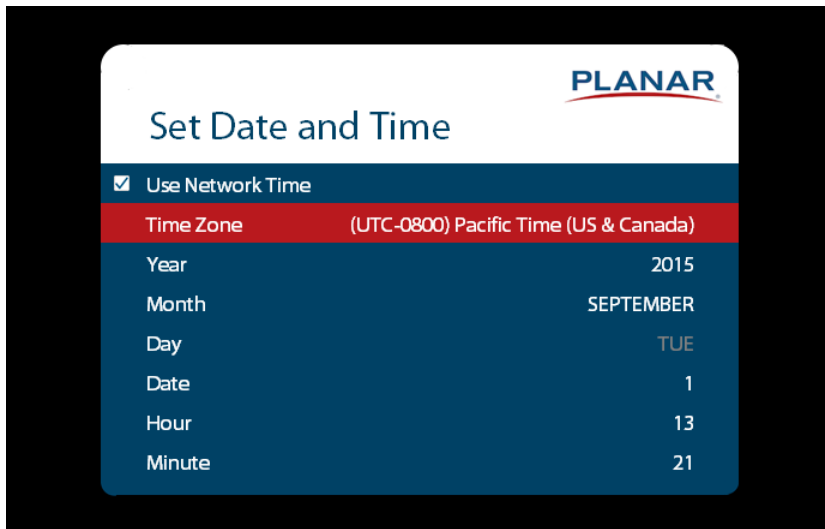
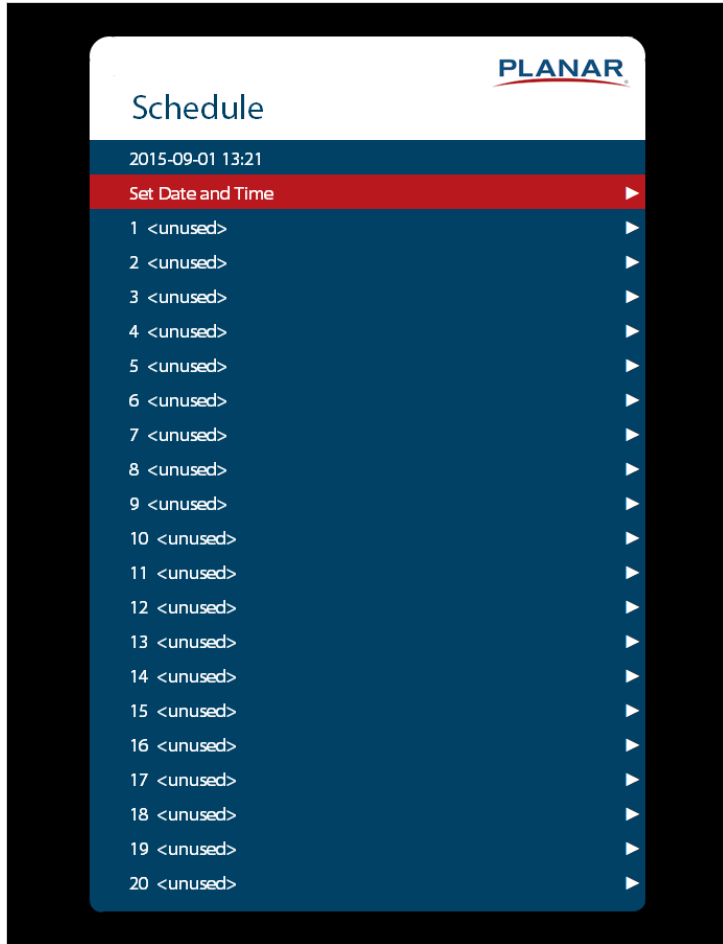

## Set Date and Time

- Set the internal system clock. If Use Network Time is unchecked, you can set the following settings individually: Time Zone, Year, Month, Day, Date, Hour, and Minute.
- **Note:** If Use Network Time is checked and DHCP is unchecked, the display will be unable to obtain the network time unless a DNS server is programmed. This is done via the DNS Server setting in the Network menu or the serial command interface.

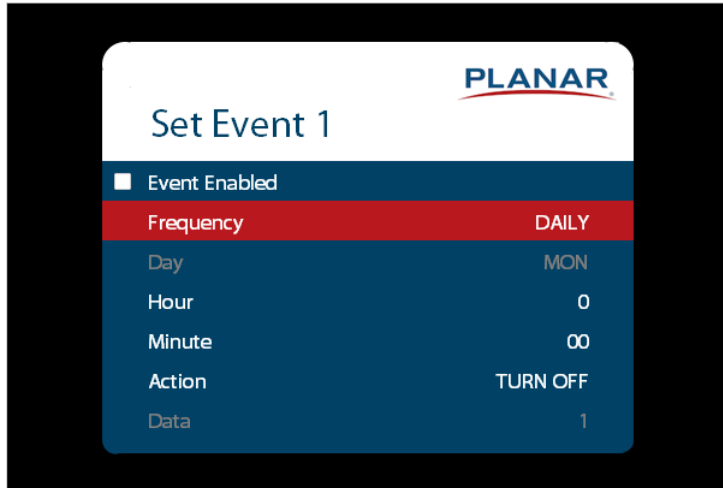

## Set Event 1~Event 20

- **Event Enabled:** Turns on the event. If disabled, the settings are saved so that the event can be re-enabled.
- **Frequency:** The frequency of the event. Options are Daily, Weekly, Weekdays, Weekends.
- **Action:** The action to take for the event. Options are Turn On, Turn Off, Recall, Panel Brightness.
  - **Note:** The Turn On action will not work if the **Power Down Mode** setting is set to **Standby Mode**. To allow the Turn On action to occur, set **Power Down Mode** to **Networked Standby Mode** or **Fast Start**.
- **Data:** The preset to recall when the Action is set to Recall, or the backlight setting when the Action is set to Panel Brightness.

## EDID Submenu

This menu specifies the EDID format and preferred timing for the selected connector.

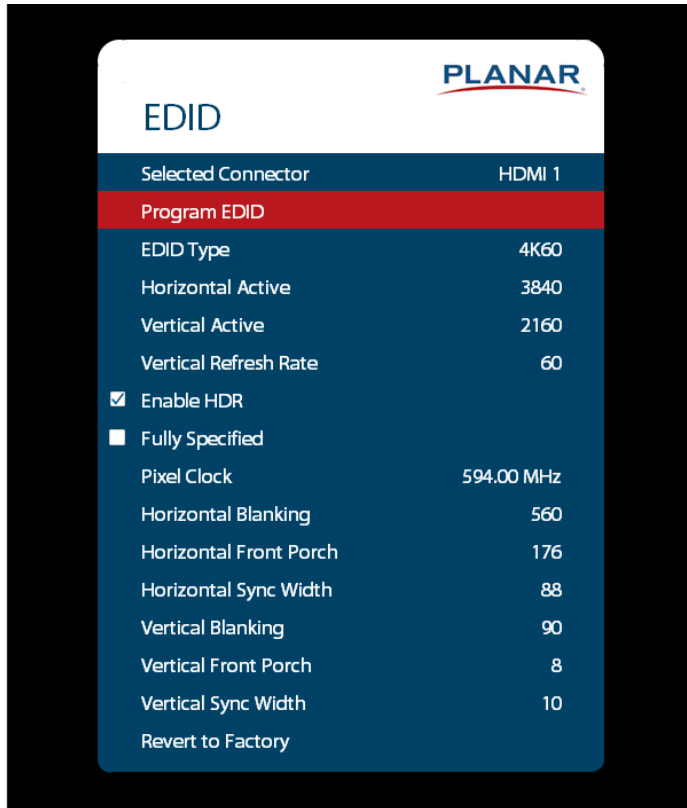

### Selected Connector

- Set which connector is used
- **Options:** HDMI 1, HDMI 2, HDMI 3, HDMI 4, DP, OPS, All

### Program EDID

- Program the EDID information for the selected connector based on the selections in the EDID submenu

### EDID Type

- Set the EDID type to determine the base EDID used for the current connector:
- 4K60 selects an EDID format compliant with HDMI 2.0 and DP 1.2
- 4K30 selects an EDID format compliant with HDMI 1.4b and DP 1.1
- 1080P selects an EDID format compliant with HDMI 1.3 and DP 1.1
- **Options:** 4K60, 4K30, 1080P

### Horizontal Active

- The number of active pixels in a line
- **Range:** 0~4095

### Vertical Active

- The number of active lines in a field
- **Range:** 0~4095

### Vertical Refresh Rate

- The number of fields per second rounded to the nearest Hz
- **Range:** 0~120

### Enable HDR

- Indicate to the source that HDR content is supported
- **Options:** On, Off; **Default:** On
- **Note:** HDR compatible inputs are HDMI 1, HDMI 2 and the OPS.
- **Note:** Displaying HDR content requires an HDR compatible source and HDR encoded content.
- **Note:** HDR sources connected via HDMI require high speed (18Gbps) compatible cables.

### Fully Specified

- Determine how the final detailed timing is calculated. If disabled, it is calculated based on Horizontal Active, Vertical Active, and Vertical Refresh Rate values. If enabled, it is calculated based on all of the EDID values except for Vertical Refresh Rate.
- **Options:** Disabled, Enabled
- **Note:** This setting should only be enabled by advanced users.

### Pixel Clock

- The value of the pixel clock, in megahertz
- **Range:** 0~600.00, in 0.01 increments

### Horizontal Blanking

- The number of non-active pixel clocks in a line
- **Range:** 0~1023

### Horizontal Front Porch

- The number of pixel clocks in the horizontal front porch
- **Range:** 0~1023

### Horizontal Sync Width

- The number of pixel clocks in the horizontal sync pulse
- **Range:** 0~255

### Vertical Blanking

- The number of non-active lines in a field
- **Range:** 0~255

### Vertical Front Porch

- The number of line times in the vertical front porch
- **Range:** 0~255

### Vertical Sync Width

- The number of line times in the vertical sync
- **Range:** 0~255

## Revert to Factory

- Reset the EDID type and timings to the default values for the selected connector

## Advanced Color Submenu

This menu adjusts the color coordinates of the current zone. These controls are used by advanced installers to achieve exact color point targets on the display. In some cases, the target color coordinates may not be achievable. In this case, an asterisk (\*) will appear next to the color coordinate value.

**Note:** The white color point should be adjusted before adjusting the other color points.

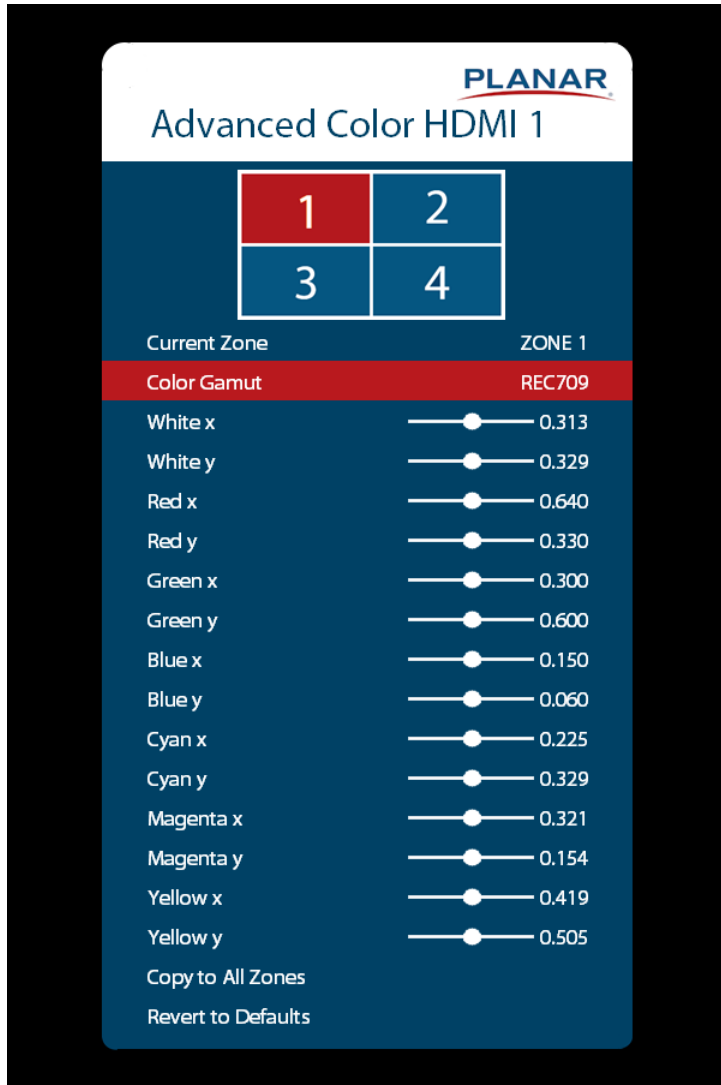

## Current Zone

- The zone that is currently being adjusted. All of the settings in this menu are saved per zone, and all color coordinate values are also saved per Color Gamut setting. The zone's corresponding input source is shown in the title bar, and the graphic beneath that shows which zone is being adjusted in the current Multi-Source View mode and Advanced Layout setting (if applicable).



- The current zone can be changed via the menu or by using the ZONE 1-4 keys on the remote control.
- **Note:** Changing the Current Zone setting via the ZONE 1-4 keys also changes the Audio Select setting.

#### Color Gamut

- Select a preset Color Gamut of the image
- **Options:** REC709, SMPTE C, EBU, DCI, User, Auto, Disable. **Default:** Disable

#### White x

- Adjust the x coordinate of the white color point
- **Range:** 0.000-0.800

#### White y

- Adjust the y coordinate of the white color point
- **Range:** 0.000-0.800

#### Red x

- Adjust the x coordinate of the red color point
- **Range:** 0.000-0.800

#### Red y

- Adjust the y coordinate of the red color point
- **Range:** 0.000-0.800

#### Green x

- Adjust the x coordinate of the green color point
- **Range:** 0.000-0.800

#### Green y

- Adjust the y coordinate of the green color point
- **Range:** 0.000-0.800

#### Blue x

- Adjust the x coordinate of the blue color point
- **Range:** 0.000-0.800

#### Blue y

- Adjust the y coordinate of the blue color point
- **Range:** 0.000-0.800

#### Cyan x

- Adjust the x coordinate of the cyan color point
- **Range:** 0.000-0.800

#### Cyan y

- Adjust the y coordinate of the cyan color point
- **Range:** 0.000-0.800

#### Magenta x

- Adjust the x coordinate of the magenta color point
- **Range:** 0.000-0.800

#### Magenta y

- Adjust the y coordinate of the magenta color point
- **Range:** 0.000-0.800

#### Yellow x

- Adjust the x coordinate of the yellow color point
- **Range:** 0.000-0.800

#### Yellow y

- Adjust the y coordinate of the yellow color point
- **Range:** 0.000-0.800
- Copy to All Zones
- Copy the color coordinate settings for the current zone and the current Color Gamut setting to all other zones

#### Revert to Defaults

- Reset the color coordinate settings for the current zone and the current Color Gamut setting to their default values

## Tiling Submenu

This menu contains controls for using multiple Planar UltraRes X Series displays in a tiled configuration. This is useful when trying to display one image across multiple displays. In addition to setting up the width and height of the tiled wall, each display must have its position within the tiled wall properly selected. Refer to the diagrams below for example setting values in a 3 x 4 tiled wall.

**Note:** When using the Content Rotation feature, the Tiling settings must be adjusted differently in order to display the image properly. Refer to the examples below.

**Example 1:** 0 Degree Rotation, Wall Width = 3, Wall Height = 4

|                             |                             |                             |
|-----------------------------|-----------------------------|-----------------------------|
| Unit Row 1<br>Unit Column 1 | Unit Row 1<br>Unit Column 2 | Unit Row 1<br>Unit Column 3 |
| Unit Row 2<br>Unit Column 1 | Unit Row 2<br>Unit Column 2 | Unit Row 2<br>Unit Column 3 |
| Unit Row 3<br>Unit Column 1 | Unit Row 3<br>Unit Column 2 | Unit Row 3<br>Unit Column 3 |
| Unit Row 4<br>Unit Column 1 | Unit Row 4<br>Unit Column 2 | Unit Row 4<br>Unit Column 3 |



**Example 2:** 180 Degree Rotation, Wall Width = 3, Wall Height = 4

|                             |                             |                             |
|-----------------------------|-----------------------------|-----------------------------|
| Unit Row 4<br>Unit Column 3 | Unit Row 4<br>Unit Column 2 | Unit Row 4<br>Unit Column 1 |
| Unit Row 3<br>Unit Column 3 | Unit Row 3<br>Unit Column 2 | Unit Row 3<br>Unit Column 1 |
| Unit Row 2<br>Unit Column 3 | Unit Row 2<br>Unit Column 2 | Unit Row 2<br>Unit Column 1 |
| Unit Row 1<br>Unit Column 3 | Unit Row 1<br>Unit Column 2 | Unit Row 1<br>Unit Column 1 |



**Example 3:** 90 Degree Rotation, Wall Width = 4, Wall Height = 3

|                             |                             |                             |
|-----------------------------|-----------------------------|-----------------------------|
| Unit Row 3<br>Unit Column 1 | Unit Row 2<br>Unit Column 1 | Unit Row 1<br>Unit Column 1 |
| Unit Row 3<br>Unit Column 2 | Unit Row 2<br>Unit Column 2 | Unit Row 1<br>Unit Column 2 |
| Unit Row 3<br>Unit Column 3 | Unit Row 2<br>Unit Column 3 | Unit Row 1<br>Unit Column 3 |
| Unit Row 3<br>Unit Column 4 | Unit Row 2<br>Unit Column 4 | Unit Row 1<br>Unit Column 4 |



**Example 4:** 270 Degree Rotation, Wall Width = 4, Wall Height = 3

|                             |                             |                             |
|-----------------------------|-----------------------------|-----------------------------|
| Unit Row 1<br>Unit Column 4 | Unit Row 2<br>Unit Column 4 | Unit Row 3<br>Unit Column 4 |
| Unit Row 1<br>Unit Column 3 | Unit Row 2<br>Unit Column 3 | Unit Row 3<br>Unit Column 3 |
| Unit Row 1<br>Unit Column 2 | Unit Row 2<br>Unit Column 2 | Unit Row 3<br>Unit Column 2 |
| Unit Row 1<br>Unit Column 1 | Unit Row 2<br>Unit Column 1 | Unit Row 3<br>Unit Column 1 |



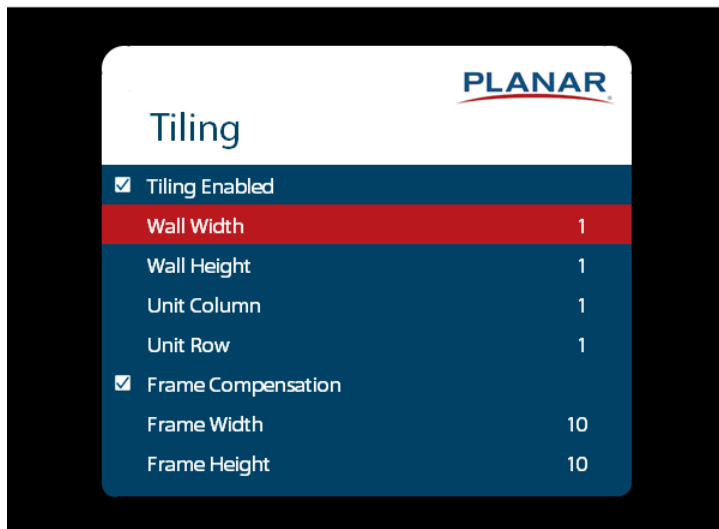

### Tiling Enabled

- When enabled, the tiling parameters in the menu are used
- **Options:** Disable, Enable; **Default:** Disable

### Wall Width, Wall Height

- Select the width and height of the tiled wall
- **Default:** Width=1, Height=1

### Unit Column, Unit Row

- Selects the location of the current display within the tiled wall
- **Default:** Column=1, Row=1

### Frame Compensation

- When enabled, the image is scaled to compensate for the width of the display's bezel, using the Frame Width and Frame Height parameters. See "Frame Compensation Examples" on page 64.
- **Options:** Disable, Enable; **Default:** Disable

### Frame Width, Frame Height

- Selects how many lines/pixels are removed from the image to compensate for the display's bezel

## Frame Compensation Examples

Below are examples with the Frame Compensation feature enabled (left) and disabled (right). Note that the eagle's eye is noticeably different when Frame Compensation is disabled.

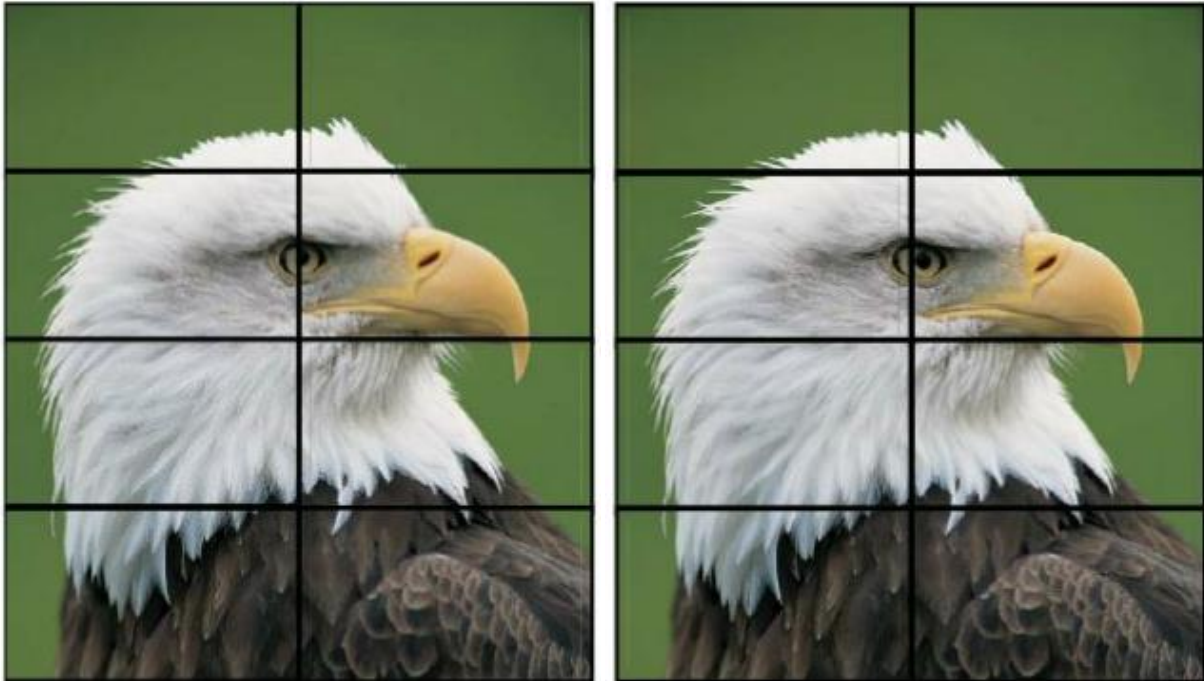



## Test Patterns Submenu

This menu selects a test pattern to show on the display for diagnostic purposes.

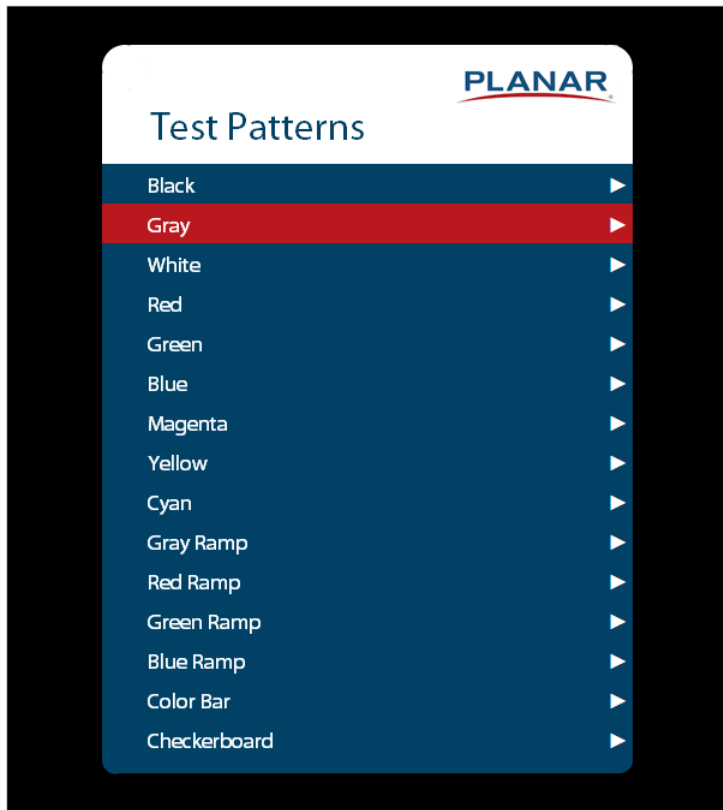

### Test Patterns

- **Options:** Black, Gray, White, Red, Green, Blue, Magenta, Yellow, Cyan, Gray Ramp, Red Ramp, Blue Ramp, Color Bar, Checkerboard

## System Settings Submenu

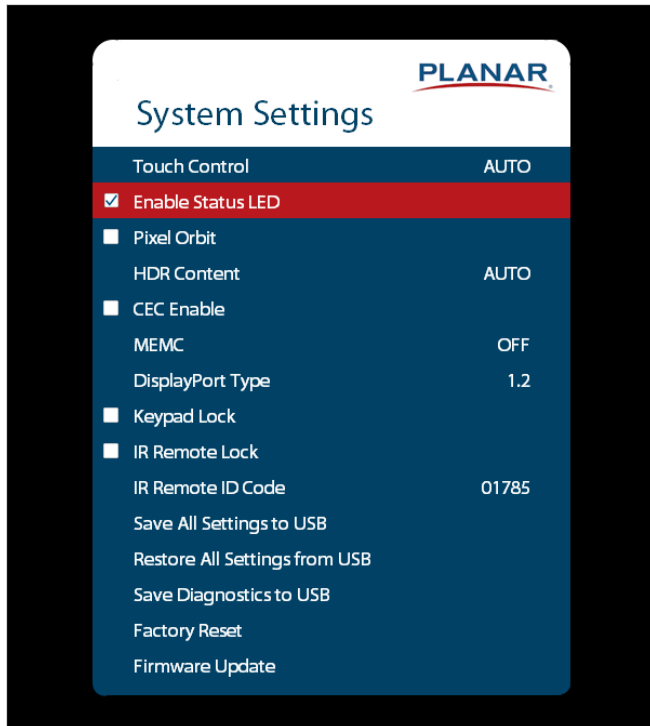

### Touch Control

- Set where the USB commands from the touch panel is routed:
- OPS routes the touch USB commands to the OPS module
- External routes the touch USB command to the USB-B connector
- Auto routes the touch USB commands to the OPS module if the OPS source is selected; otherwise, they are connected to the USB-B connector

### Enable Status LED

- When enabled, the status LEDs on the back of the display behave as indicated on page 28. When disabled, the status LEDs are always turned off.
- **Options:** Disable, Enable; **Default:** Enable

### Pixel Orbit

- Create slight frame motion to help avoid image retention
- **Options:** Enable, Disable; **Default:** Disable

### HDR Content

- Set the action to take when HDR content is received and displayed on HDMI 1, HDMI 2 and the OPS input
- **Options:** Auto, On, Off; **Default:** Auto
  - **Auto:** The display will adjust the image settings to conform to the HDR source metadata.
  - **On:** The display will force all content to be displayed in HDR mode.
    - **Note:** When viewing SDR content in this mode, the image quality will not have the correct appearance.

- **Off:** The display force all content to be displayed in SDR mode.
  - **Note:** When viewing HDR content in this mode, the image quality will not have the correct appearance.
  - **Note:** Due to the performance requirements of HDR, simultaneous viewing HDR and SDR content image appearance will be prioritized based on Zone 1 settings.

#### CEC Enable

- Enables HDMI-CEC (Consumer Electronics Control) with compatible external devices
- **Options:** On, Off; **Default:** Off

The CEC commands listed in the table below are implemented:

| Command                  | Value |
|--------------------------|-------|
| Image View On            | 0x04  |
| Text View On             | 0x0D  |
| Standby                  | 0x36  |
| Routing Change           | 0x80  |
| Active Source            | 0x82  |
| Give Physical Address    | 0x83  |
| Report Physical Address  | 0x84  |
| Request Active Source    | 0x85  |
| Set Stream Path          | 0x86  |
| Give Device Power Status | 0x8F  |
| Report Power Status      | 0x90  |
| Inactive Source          | 0x9D  |
| CEC Version              | 0x9E  |
| Get CEC Version          | 0x9F  |
| Give Features            | 0xA5  |
| Report Features          | 0xA6  |

#### MEMC

- Enable motion estimation motion compensation (frame interpolation). This improves smoothness for fast motion video content.
- **Options:** Off, Low, Medium, High; **Default:** Off

#### DisplayPort Type

- Set the version of DisplayPort that is used by the system
- **Options:** 1.1, 1.2; **Default:** 1.2

#### Keypad Lock

- Lock or unlock the keypad. When it is enabled, all keypad presses will be ignored.
- **Options:** Enable, Disable; **Default:** Disable

## IR Remote Lock

- Lock or unlock the remote control. When it is enabled, all remote control presses will be ignored.
- **Options:** Enable, Disable; **Default:** Disable

## IR Remote ID Code

- Selects the IR remote code set accepted by the display
- **Options:** 00000-65535; **Default:** 01785

## Save All Settings to USB

- Save all settings in the display to a USB flash drive. The saved file will be named Planar-settings.bin and will be saved in the root folder of the USB flash drive.
- **Note:** A USB flash drive must be inserted into the USB-A connector prior to using this feature. The USB flash drive must be formatted as FAT32. This feature will not work with the NTFS file system.

## Restore All Settings from USB

- Restores all settings in the display from a USB flash drive. The settings file must be named Planar-settings.bin and must be located in the root folder of the USB flash drive.
- **Note:** A USB flash drive must be inserted into the USB-A connector prior to using this feature. The USB flash drive must be formatted as FAT32. This feature will not work with the NTFS file system.

## Save Diagnostics to USB

- Save a diagnostic report to a USB flash drive to help Planar Technical Support troubleshoot any issues. The saved file will be named Planar-diagnostics.bin and will be saved in the root folder of the USB flash drive.
- **Note:** A USB flash drive must be inserted into the USB-A connector prior to using this feature. The USB flash drive must be formatted as FAT32. This feature will not work with the NTFS file system.

## Factory Reset

- Return the saved settings in a system to their factory defaults

## Firmware Update

- Update the firmware for the display. Refer to the instructions on the firmware release package for more information.

## 19.5 Information Menu

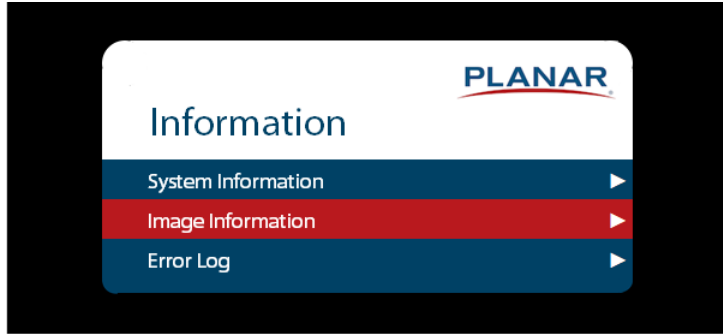

### System Information Submenu

This menu displays version information for all programmable parts in the system. It also contains the model and serial number.

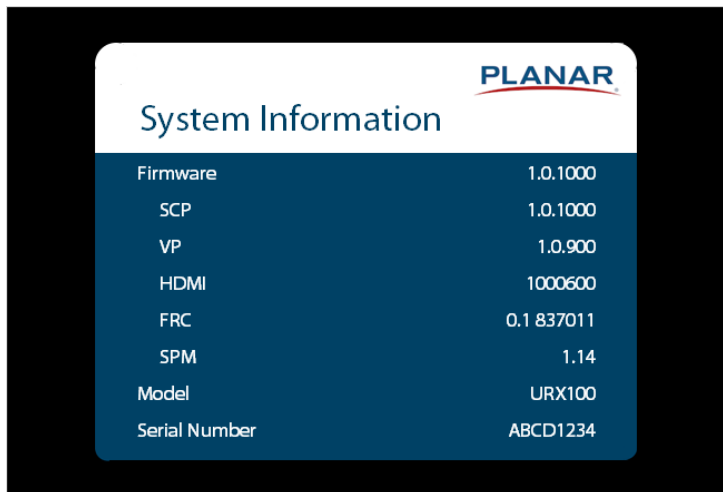

## Image Information Submenu

This menu displays image details for the current zone. If more than one zone is available, you can change zones by setting the **Current Zone** option.

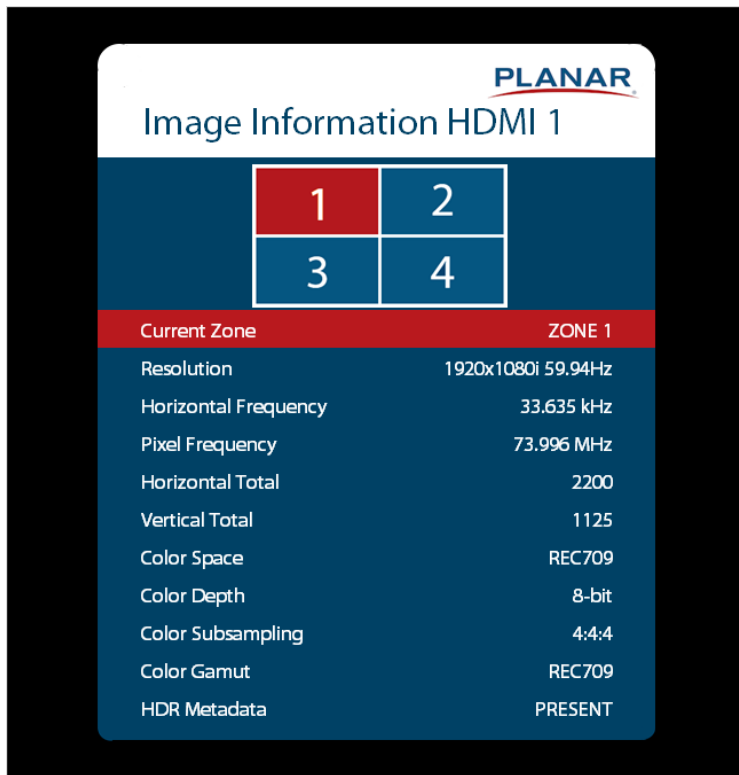

## Error Log Submenu

This menu displays a chronological list of system errors that have occurred. For a list of possible errors, see "Error Codes" on page 104.

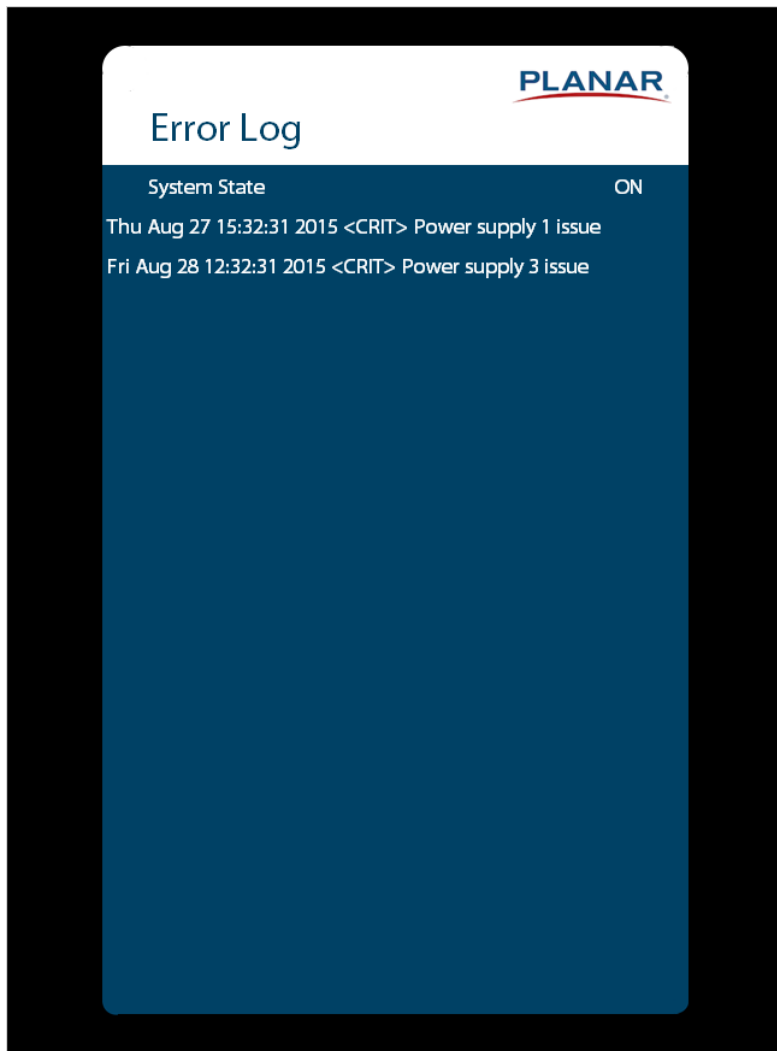

## 20. Using the Touch Screen

You can use the touch screen to control your Windows, Mac or Linux operating system. The Planar UltraRes X Series is HID compliant, delivering up to 20 points of touch on both Windows and Linux without a driver. Single touch only is supported for Mac operating systems. To achieve more than single touch Mac support, drivers will need to be installed, which can be found on <http://www.planar.com/support>.

**Note:** Ensure that you have installed the USB cable on the display to a computer.

**Note:** If an OPS PC is installed in the OPS slot, the OPS PC will automatically be connected internally to the touch system. The touch functionality is configurable via the Touch Control setting.



# Planar UltraRes X Series Remote Monitoring Software

The Planar URX75, URX85, and URX100 models feature a web interface that may be accessed from any web browser. This powerful tool is compatible with computers and mobile devices and can be used to control the display and access most of the settings that are available in the On-Screen Menu.

Additionally, the web interface can be used as an alternative to the IR remote or a 3rd party control system. Certain features can be locked behind Admin level access, preserving only the most essential controls, such as power, volume, brightness, input selection, and multi-source layouts. (See “Remote Monitoring Access Control” on page 83.)

## 21. Remote Monitoring Home

Connect the display to the network. Launch a web browser on your computer or mobile device. Enter the IP address shown in the Network menu (see page 50). If successful, you should see the Remote Monitoring System Information page.

Depending on the resolution and orientation of your browser, the appearance of the interface may vary.

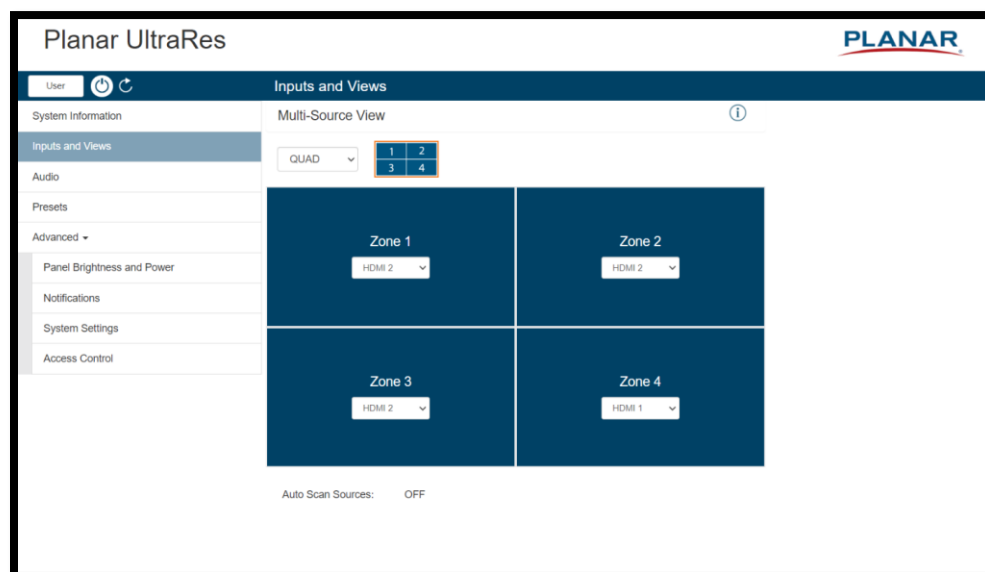

Typical appearance on a desktop or laptop browser

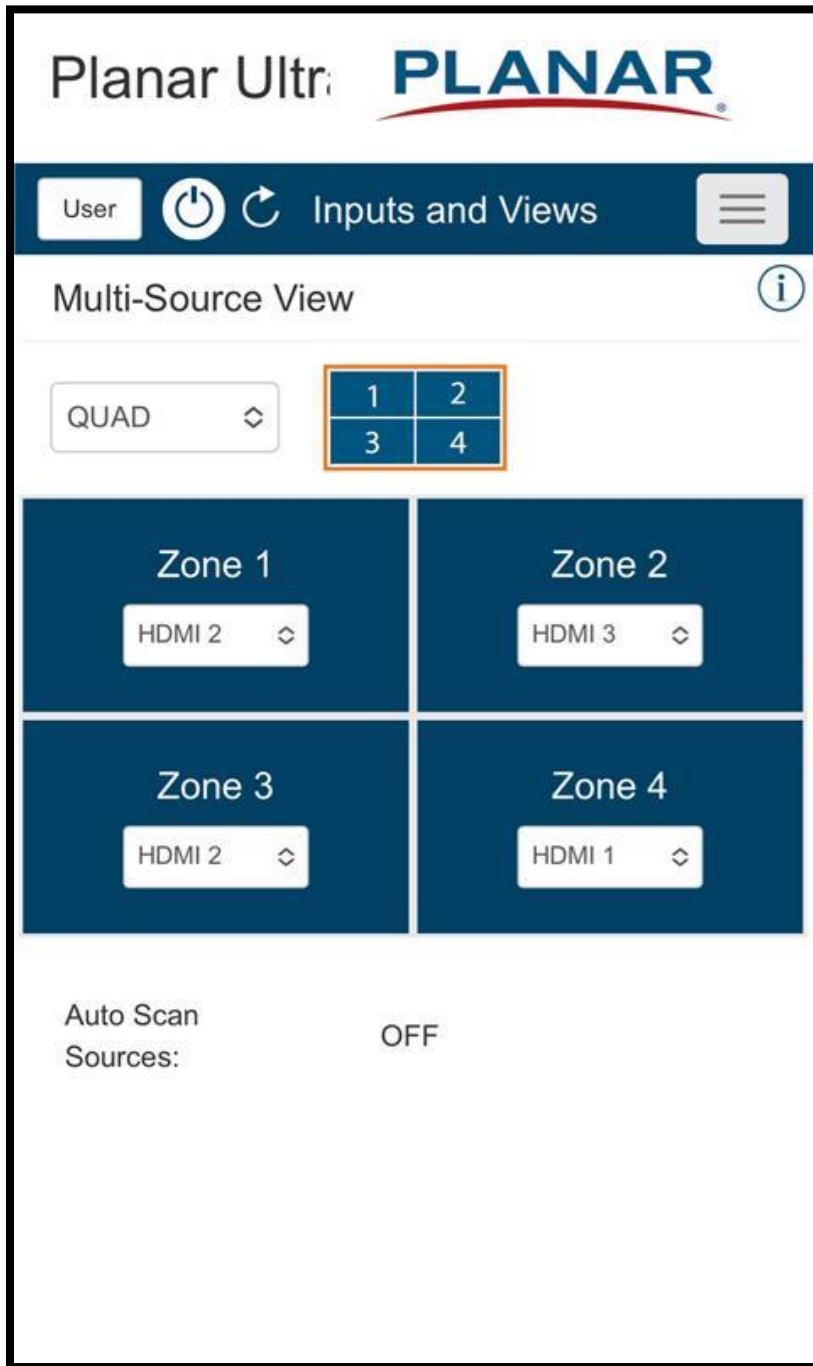



Typical appearance on a mobile device

## 22. Remote Monitoring System Information

This page displays version information for all programmable parts in the system. It also contains the model and serial number.

For the OSD equivalent, refer to "System Settings Submenu" on page 66.

URX85 

Admin   **System Information**

| System Information         | Summary                        |
|----------------------------|--------------------------------|
| Inputs and Views           | System State: ON               |
| Audio                      | Multi-Source View: SINGLE      |
| Presets                    | Audio Input: DP                |
| Advanced ▾                 | Volume: 1                      |
| Panel Brightness and Power | Mute: OFF                      |
| Notifications              | Pattern/OSD On Screen: No      |
| System Settings            | Network IP Address: 10.15.0.81 |
| Access Control             | <b>Product Information</b>     |
|                            | Model: URX85                   |
|                            | Serial:                        |
|                            | <b>Version Information</b>     |
|                            | Firmware: 3.0.1352             |
|                            | SCP: 3.0.1352                  |
|                            | VP: 3.0.1263                   |
|                            | HDMI: 01002100                 |

# 23. Remote Monitoring Inputs and Views

This page shows how the sources will be laid out on the screen based on the current Multi-Source View and Advanced Layouts selections.

For the OSD equivalent, refer to "Inputs and Views Menu" on page 40.

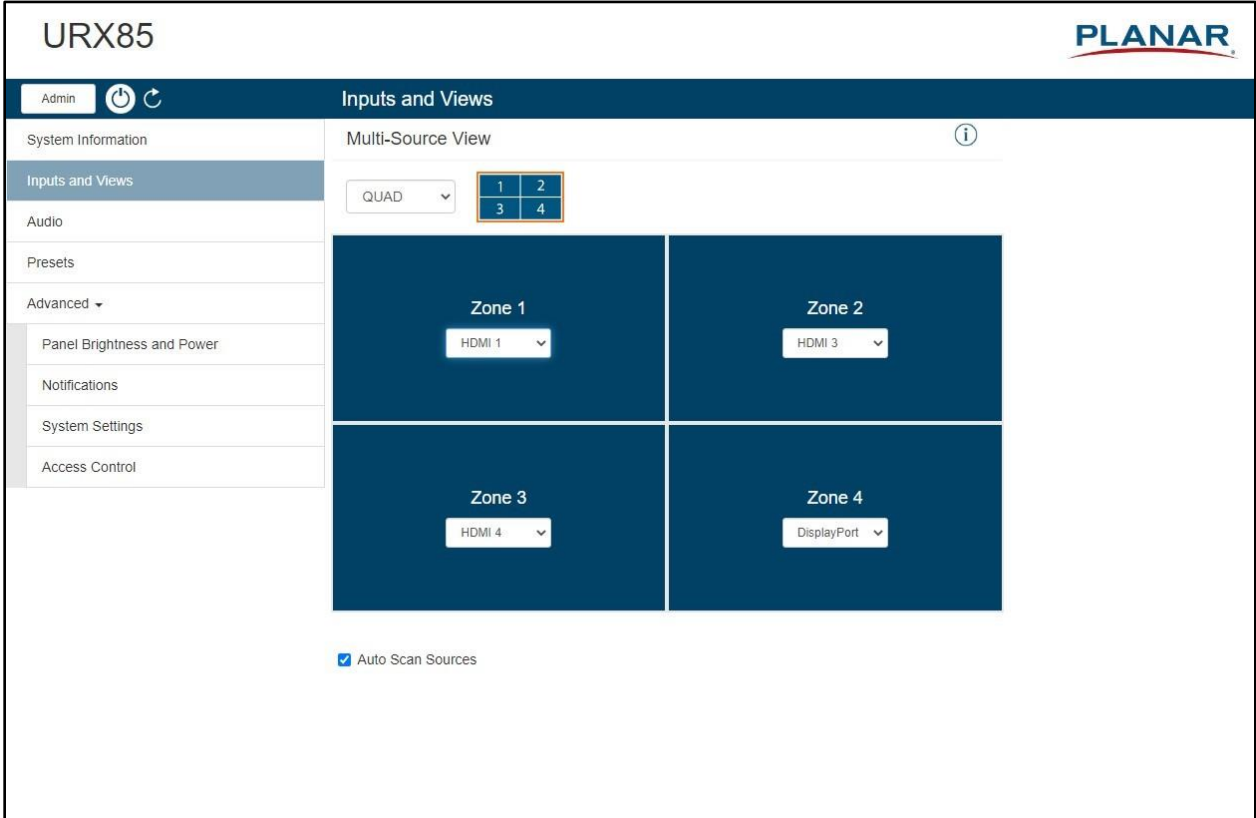

## 24. Remote Monitoring Audio

This page enables you to make audio adjustments to the selected zone.

**Note:** Volume, Bass, Treble and Balance do not apply to the S/PDIF output.

For the OSD equivalent, refer to "Audio Menu" on page 45.

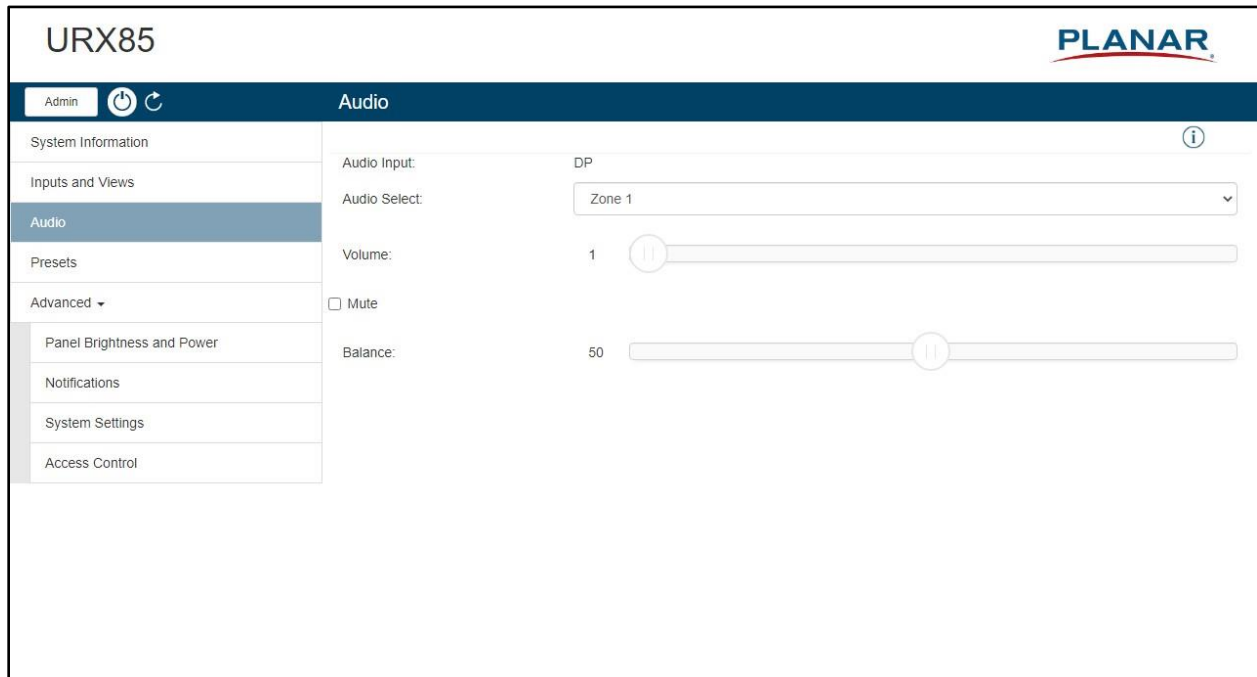

The screenshot displays the URX85 remote monitoring interface. At the top left, the model name "URX85" is shown. At the top right is the "PLANAR" logo. Below the header is a navigation bar with "Admin" and refresh icons. A sidebar on the left lists menu items: System Information, Inputs and Views, Audio (highlighted), Presets, and an "Advanced" dropdown menu containing Panel Brightness and Power, Notifications, System Settings, and Access Control. The main content area is titled "Audio" and includes an information icon. The settings are as follows:

- Audio Input: DP
- Audio Select: Zone 1 (dropdown menu)
- Volume: 1 (slider)
- Mute:
- Balance: 50 (slider)

## 25. Remote Monitoring Presets

This page enables you to save Inputs and Views settings, Image Adjust settings, Audio settings, the Backlight Intensity setting, the Local Dimming setting, and Tiling settings. You can save up to 64 presets using this page (more can be saved via the serial command interface). Only presets that contain saved data are shown in the table, with buttons to recall or delete the corresponding preset.

The controls below the table enable you to save a new preset, or overwrite an existing preset with the current display settings. To save or overwrite a preset, enter the preset number to save or overwrite, optionally enter a custom name for the preset, and then click the **Save** button.

For the OSD equivalent, refer to "Presets Menu" on page 46.

The screenshot shows the 'URX85' interface with the 'PLANAR' logo in the top right. The 'Presets' section is active, showing a table of existing presets and a form for creating a new one.

| # | Name             | Action              |
|---|------------------|---------------------|
| 1 | Video Conference | Recall #1 Delete #1 |
| 2 | Satellite Feed   | Recall #2 Delete #2 |

Below the table, there is a form to create a new preset:

3    New Preset Name    Save #3

## 26. Remote Monitoring Panel Brightness and Power

This page enables you to make adjustments to the brightness and power settings.

For the OSD equivalents, refer to "Panel Brightness Submenu" on page 47 and "Power Submenu" on page 48.

The screenshot displays the URX85 remote monitoring interface. At the top left, the model number "URX85" is shown. At the top right is the "PLANAR" logo. Below the header is a navigation bar with "Admin" and a refresh icon. The main content area is titled "Advanced" and is divided into two columns. The left column contains a sidebar menu with the following items: System Information, Inputs and Views, Audio, Presets, Advanced + (expanded), Panel Brightness and Power (selected), Notifications, System Settings, and Access Control. The right column is split into two sections: "Panel Brightness" and "Power".

**Panel Brightness**

- Intensity: 100 (with a slider control)
- Local Dimming

**Power**

- Auto Power On
- Power Saving Mode: Disabled (dropdown menu)
- Power Saving Delay: 1 Minute (dropdown menu)
- Power On Delay (s): 0 (input field)
- Standby Mode: Fast Startup (dropdown menu)
- OPS Power Down Check

## 27. Remote Monitoring Notifications

This page enables you to send email notifications on certain events.

URX85

PLANAR

Admin

### Notifications

System Information

Inputs and Views

Audio

Presets

Advanced

Panel Brightness and Power

Notifications

System Settings

Access Control

#### Email Account Settings

SMTP Server:

Connection Encryption:

Port:

Authentication:

User Name:

Password:

Email From Address:

#### Notification Events

| Event           | Recipient(s)         | Additional Note      | Enabled                  |
|-----------------|----------------------|----------------------|--------------------------|
| Power On/Off    | <input type="text"/> | <input type="text"/> | <input type="checkbox"/> |
| System Error    | <input type="text"/> | <input type="text"/> | <input type="checkbox"/> |
| Source Detect   | <input type="text"/> | <input type="text"/> | <input type="checkbox"/> |
| Source Lost     | <input type="text"/> | <input type="text"/> | <input type="checkbox"/> |
| Source Selected | <input type="text"/> | <input type="text"/> | <input type="checkbox"/> |

Test Email

**Note:** Obtain this information from your ISP or network administrator.

The options under **Email Account Settings** are:

- **SMTP Server:** The name of the outgoing SMTP server. Obtain this information from your ISP.
- **Connection Encryption:** Selects the appropriate encryption method required by the SMTP server.
- **Port:** Selects the port that the SMTP server uses.
- **Authentication:** Use Auto unless directed by your ISP or network administrator.
- **User Name:** Login username for the SMTP server.



- **Password:** Login password for the SMTP server.
- **Email From Address:** The email address that will be shown in the “From:” field of the notification emails.

The options under **Notification Events** are:

- **Power On/Off:** Occurs when standby mode is entered and when the display is powered on.
- **System Error:** Occurs when the display has detected an error within the system.
- **Source Detect:** Occurs when the display detects and displays a new input signal.
- **Source Lost:** Occurs when the current input signal is no longer detected.
- **Source Selected:** Occurs when a different input source is selected for any of the zones.

**Note:** Each event can be sent to one or more recipients. To add multiple email addresses, separate them by a space.

- **Test Email:** Sends a test of the selected email notification. This is useful for verifying that your email account settings are setup correctly. If the test email fails, you can use the View Last 10 Log Messages button to get more detailed information about the failure.

## 28. Remote Monitoring System Settings

This page enables you to make adjustments to a variety of system settings.

For the OSD equivalent, refer to "System Settings Submenu" on page 66.

The screenshot displays the 'System Settings' page for a Planar URX85 monitor. The interface includes a top navigation bar with 'Admin' and system icons, and a left sidebar with menu items: System Information, Inputs and Views, Audio, Presets, Advanced (expanded), Panel Brightness and Power, Notifications, System Settings (selected), and Access Control. The main content area is titled 'System Settings' and contains several sections:

- Display Name:** A text input field containing 'URX85'.
- Touch Control:** A dropdown menu set to 'AUTO'.
- Enable Status LED:** A checked checkbox.
- Pixel Orbit:** An unchecked checkbox.
- Enable HDR:** A checked checkbox.
- Enable CEC:** A checked checkbox.
- DisplayPort Type:** A dropdown menu set to '1.2'.
- Keypad Lock:** An unchecked checkbox.
- IR Remote Lock:** An unchecked checkbox.
- IR Remote ID Code:** A text input field containing '1785'.
- Security:** A section with 'Enable SNMP' (unchecked) and 'Enable TCP/UDP Commands' (checked).
- Firmware Update:** A section with a 'Choose File' button and the text 'No file chosen', accompanied by an information icon.
- Save Settings:** A section with a 'Generate Settings Package' button and an information icon.
- Restore Settings:** A section with a 'Choose File' button and the text 'No file chosen', accompanied by an information icon.
- Save Diagnostics:** A section with a 'Generate Diagnostics Package' button and an information icon.

## 29. Remote Monitoring Access Control

This page enables you to limit the ability to access certain features in the web server by password protecting them.

The screenshot shows the 'Access Control' page for the URX85 device. The page is divided into two main sections: 'Change Passwords' and 'Remove Passwords'. The 'Change Passwords' section is further divided into 'Admin' and 'User' sections. Each section has a 'New Password' input field, a 'Repeat New Password' input field, and a 'Set Admin Password' or 'Set User Password' button. The 'Remove Passwords' section has a single 'Remove Passwords' button. Information icons (i) are present in the top right of each section.

All functions other than the following require Admin level access:

- Power On/Off
- System Information
- Inputs and Views
  - Multi-Source View
  - Zone inputs
- Presets
  - Recall
- Audio
  - Volume
  - Mute
- Panel Brightness and Power
  - Panel Brightness

With the exception of System Information, all functions listed above require User level access.

The default username is Admin. The default password is the serial number, which can be viewed on the System Information tab. Once logged in, all functions can be accessed, and the password for Admin and User can be changed.

# External Control

In addition to using the Planar UltraRes X Series remote control and display, there are other methods of controlling the Planar UltraRes X Series display externally:

- Using a serial link to send ASCII commands and to receive responses to those commands. The same set of commands can be sent over RS-232, USB, TCP or UDP. See the Planar UltraRes X Series RS232 User Manual for more information.
- Using discrete infrared (IR) codes to program a third-party remote control. See "IR Command Protocol" on page 34.
- Using the Planar UltraRes X Series Remote Monitoring software to access the settings in the OSD as well as some additional features via a web browser. See "Planar UltraRes X Series Remote Monitoring Software" on page 73.
- Using HDMI-CEC with compatible devices. See "CEC" on page 67.

# HDR

To take full advantage of the benefits of expanded color gamut, bit depth and dynamic range, the Planar UltraRes X Series supports content encoded in HDR (High Dynamic Range). When HDR content is present, the image performance will expand beyond the capabilities of standard dynamic range content, allowing for a wider range of colors, bit depth and dynamic range.

HDR compatible inputs: HDMI 1, HDMI 2 and OPS

# Signal Compatibility

| Signal Type | Resolution | Frame rate (Hz) | Line Rate (kHz) | Pixel Rate (MHz) | HDMI 1-2, OPS | HDMI 3-4 | DisplayPort | References                   |
|-------------|------------|-----------------|-----------------|------------------|---------------|----------|-------------|------------------------------|
| PC          | 640x480    | 59.94           | 31.469          | 25.175           | x             | x        | x           | VESA DMT, CEA-861-F Format 1 |
|             | 640x480    | 72              | 37.861          | 31.500           | x             | x        | x           | VESA DMT                     |
|             | 640x480    | 74.99           | 37.500          | 31.500           | x             | x        | x           | VESA DMT                     |
|             | 640x480    | 85              | 43.269          | 36.000           | x             | x        | x           | VESA DMT                     |
|             | 800x600    | 60.32           | 37.890          | 40.000           | x             | x        | x           | VESA DMT                     |
|             | 800x600    | 72              | 48.077          | 50.000           | x             | x        | x           | VESA DMT                     |
|             | 800x600    | 75              | 46.875          | 49.500           | x             | x        | x           | VESA DMT                     |
|             | 800x600    | 85.06           | 53.674          | 56.250           | x             | x        | x           | VESA DMT                     |
|             | 848x480    | 59.659          | 29.830          | 31.500           | x             | x        | x           | VESA CVT                     |
|             | 848x480    | 74.769          | 37.684          | 41.000           | x             | x        | x           | VESA CVT                     |
|             | 848x480    | 84.751          | 42.969          | 46.750           | x             | x        | x           | VESA CVT                     |
|             | 1024x768   | 60              | 48.363          | 65.000           | x             | x        | x           | VESA DMT                     |
|             | 1024x768   | 70              | 56.476          | 75.000           | x             | x        | x           | VESA DMT                     |
|             | 1024x768   | 75.03           | 60.023          | 78.750           | x             | x        | x           | VESA DMT                     |
|             | 1024x768   | 85.03           | 68.677          | 94.500           | x             | x        | x           | VESA DMT                     |
|             | 1152x864   | 70.012          | 63.851          | 94.500           | x             | x        | x           | VESA DMT                     |
|             | 1152x864   | 75              | 67.500          | 108.000          | x             | x        | x           | VESA DMT                     |
|             | 1152x864   | 84.999          | 77.094          | 121.500          | x             | x        | x           | VESA DMT                     |
|             | 1280x768   | 49.929          | 39.593          | 65.250           | x             | x        | x           | VESA CVT                     |
|             | 1280x768   | 59.995          | 47.396          | 68.250           | x             | x        | x           | VESA CVT-R                   |
| 1280x768    | 60         | 47.776          | 79.500          | x                | x             | x        | VESA CVT    |                              |
| 1280x768    | 74.893     | 60.289          | 102.250         | x                | x             | x        | VESA CVT    |                              |

| Signal Type | Resolution | Frame rate (Hz) | Line Rate (kHz) | Pixel Rate (MHz) | HDMI 1-2, OPS | HDMI 3-4 | DisplayPort | References  |
|-------------|------------|-----------------|-----------------|------------------|---------------|----------|-------------|---|
| PC          | 1280x768   | 84.837          | 68.633          | 117.500          | x             | x        | x           | VESA CVT  |
|             | 1280x960   | 60              | 60.000          | 108.000          | x             | x        | x           | VESA DMT  |
|             | 1280x960   | 75              | 75.000          | 126.000          | x             | x        | x           | VESA DMT  |
|             | 1280x960   | 85.002          | 85.938          | 148.500          | x             | x        | x           | VESA DMT  |
|             | 1280x1024  | 60.02           | 63.981          | 108.000          | x             | x        | x           | VESA DMT  |
|             | 1280x1024  | 75.02           | 79.976          | 135.000          | x             | x        | x           | VESA DMT  |
|             | 1280x1024  | 85.02           | 91.146          | 157.500          | x             | x        | x           | VESA DMT  |
|             | 1360x768   | 60              | 47.712          | 85.500           | x             | x        | x           | VESA DMT  |
|             | 1400x1050  | 49.965          | 54.113          | 100.000          | x             | x        | x           | VESA CVT  |
|             | 1400x1050  | 60              | 64.7            | 101.00           | x             | x        | x           | VESA CVT-R  |
|             | 1400x1050  | 60              | 65.317          | 121.750          | x             | x        | x           | VESA CVT  |
|             | 1400x1050  | 74.867          | 82.278          | 156.000          | x             | x        | x           | VESA CVT  |
|             | 1600x1200  | 60              | 75.000          | 162.000          | x             | x        | x           | VESA DMT  |
|             | 1920x1080  | 49.929          | 55.621          | 141.500          | x             | x        | x           | VESA CVT  |
|             | 1920x1080  | 59.963          | 67.158          | 173.000          | x             | x        | x           | VESA CVT  |
|             | 1920x1080  | 59.950          | 66.587          | 138.500          | x             | x        | x           | VESA CVT-R  |
|             | 1920x1200  | 49.932          | 61.816          | 158.250          | x             | x        | x           | VESA CVT  |
|             | 1920x1200  | 59.950          | 74.038          | 154.000          | x             | x        | x           | VESA CVT-R  |
|             | 1680x1050  | 49.974          | 54.121          | 119.500          | x             | x        | x           | VESA CVT  |
|             | 1680x1050  | 59.954          | 65.290          | 146.250          | x             | x        | x           | VESA CVT  |
|             | 1920x2160  | 60              | 135.000         | 297.000          | x             | x        | x           | CEA-861-F, VIC 16, with vertical parameters doubled |
|             | 2560x1440  | 59.951          | 88.787          | 241.500          | x             | x        | x           | VESA CVT-R  |
|             | 2560x1600  | 59.972          | 98.713          | 268.500          | x             | x        | x           | VESA CVT-R  |
| 3840x2160   | 24         | 52.438          | 209.750         | x                | x             | x        | VESA CVT-R  |   |

| Signal Type | Resolution | Frame rate (Hz) | Line Rate (kHz) | Pixel Rate (MHz) | HDMI 1-2, OPS | HDMI 3-4 | DisplayPort | References                              |
|-------------|------------|-----------------|-----------------|------------------|---------------|----------|-------------|---|
| PC          | 3840x2160  | 30              | 65.688          | 262.750          | x             | x        | x           | VESA CVT-R                              |
|             | 3840x2160  | 50              | 110.500         | 442.000          | x             |          | x           | VESA CVT-R                              |
|             | 3840x2160  | 60              | 133.313         | 533.250          | x             |          | x           | VESA CVT-R                              |
| Apple Mac   | 640x480    | 66.59           |                 |                  | x             | x        | x           |   |
|             | 832x624    | 75.087          | 49.107          | 55.000           | x             | x        | x           |   |
|             | 1024x768   | 59.278          | 48.193          | 64.000           | x             | x        | x           |   |
|             | 1024x768   | 74.927          | 60.241          | 80.000           | x             | x        | x           |   |
|             | 1152x870   | 75.062          | 68.681          | 100.000          | x             | x        | x           |   |
| SDTV        | 480i       | 60              |                 |                  | x             | x        | x           | SMPTE 125M, CEA-861-F Formats 6 & 7     |
|             | 576i       | 50              |                 |                  | x             | x        | x           | ITU-R BT.601, CEA-861-F Formats 21 & 22 |
| EDTV        | 480p       | 60              | 31.469          | 27.000           | x             | x        | x           | ITU-R BT.1358, CEA-861-F Format 17 & 18 |
|             | 576p       | 50              | 31.250          | 27.000           | x             | x        | x           | SMPTE 125M, CEA-861-F Format 6 & 7      |
| HDTV        | 1080i      | 50              | 28.125          | 74.500           | x             | x        | x           | SMPTE 274M, CEA-861-F Format 20         |
|             | 1080i      | 60              | 33.750          | 74.250           | x             | x        | x           | SMPTE 274M, CEA-861-F Format 5          |
|             | 720p       | 50              | 37.500          | 74.250           | x             | x        | x           | SMPTE 296M, CEA-861-F Format 19         |
|             | 720p       | 60              | 45.000          | 74.250           | x             | x        | x           | SMPTE 296M, CEA-861-F Format 4          |
|             | 1080p      | 24              | 27.000          | 74.250           | x             | x        | x           | SMPTE 274M, CEA-861-F Format 32         |
|             | 1080p      | 25              | 28.125          | 74.250           | x             | x        | x           | SMPTE 274M, CEA-861-F Format 33         |
|             | 1080p      | 30              | 33.750          | 74.250           | x             | x        | x           | SMPTE 274M, CEA-861-F Format 34         |
|             | 1080p      | 50              | 56.250          | 148.500          | x             | x        | x           | SMPTE 274M, CEA-861-F Format 31         |
|             | 1080p      | 60              | 67.500          | 148.500          | x             | x        | x           | SMPTE 274M, CEA-861-F Format 16         |



| Signal Type | Resolution | Frame rate (Hz) | Line Rate (kHz) | Pixel Rate (MHz) | HDMI 1-2, OPS | HDMI 3-4 | DisplayPort | References                              |
|-------------|------------|-----------------|-----------------|------------------|---------------|----------|-------------|---|
| UHDTV       | 3840x2160  | 24              | 54.000          | 297.000          | x             | x        | x           | CEA-861-F Format 93, HDMI 1.4b VIC 1    |
|             | 3840x2160  | 25              | 56.250          | 297.000          | x             | x        | x           | CEA-861-F Format 94, HDMI 1.4b VIC 2    |
|             | 3840x2160  | 30              | 67.500          | 297.000          | x             | x        | x           | CEA-861-F Format 95, HDMI 1.4b VIC 3    |
|             | 3840x2160  | 50              | 67.500          | 297.000          | x             |          |             | CEA-861-F Format 96, 4:2:0 sub-sampling |
|             | 3840x2160  | 50              | 135.000         | 594.000          | x             |          | x           | CEA-861-F Format 96                     |
|             | 3840x2160  | 60              | 67.500          | 297.000          | x             |          |             | CEA-861-F Format 97, 4:2:0 sub-sampling |
|             | 3840x2160  | 60              | 135.000         | 594.000          | x             |          | x           | CEA-861-F Format 97                     |

# Color Subsampling Report

| Video Timing                | Input         | RGB 4:4:4 Supported | YUV 4:4:4 Supported | YUV 4:2:2 Supported | YUV 4:2:0 Supported |
|-----------------------------|---------------|---------------------|---------------------|---------------------|---------------------|
| 4K @ 50/60 Hz               | DP            | x                   | x                   | x                   |                     |
| 4K @ 50/60 Hz               | HDMI 1-2, OPS | x                   | x                   | x                   | x                   |
| 4K @ 50/60 Hz               | HDMI 3-4      |                     |                     |                     |                     |
| All Other Supported Timings | Any           | x                   | x                   | x                   |                     |

# Power Consumption

The power consumption values stated in the Specifications table are calculated under the typical conditions of viewing a single source with default settings.

Due to the advanced capabilities of the Planar UltraRes X Series, and the widely variable power consumption of user-installed OPS devices, the total maximum power draw of Planar UltraRes X Series is influenced by several factors:

- The use of advanced features such as Multi Source view, tiling and image scaling variables that occur for each source and image configuration
- The use of MEMC (frame interpolation)
- The use of Local Dimming and backlight variables that occur as content changes
- The variable power consumption of an installed OPS device

Given the relatively low likelihood of all the above conditions being met and maximized simultaneously, the “Power Consumption: Backlight Max (Typ.)” value is instead calculated by increasing the default backlight value of 75 to 100, and multiplying the wattage by approximately 1.33. The power consumption would increase above these specified values if the above factors are introduced, and should be taken into account when estimating power consumption.

# Specifications

| Item  | URX75<br>URX75-ERO<br>URX75-ERO-T  | URX85<br>URX85-ERO<br>URX85-ERO-T | URX100<br>URX100-ERO<br>URX100-ERO-T |
|---|--|-----------------------------------|--------------------------------------|
| <b>LCD Panel</b>                              |  |                                   |                                      |
| Display Technology                            | Commercial-Grade VA LCD  |                                   |                                      |
| Resolution                                    | 3840x2160  |                                   |                                      |
| Aspect Ratio                                  | 16:9   |                                   |                                      |
| Screen Size                                   | 75"  | 85"                               | 100"                                 |
| Orientation                                   | Landscape/Portrait   |                                   |                                      |
| Brightness (Typ.)                             | Non-ERO versions: 700 cd/m <sup>2</sup><br>ERO and ERO-T versions: 630 cd/m <sup>2</sup> |                                   |                                      |
| Contrast Ratio (Typ.; local dimming enabled)  | 20,000:1   |                                   | N/A                                  |
| Contrast Ratio (Typ.; local dimming disabled) | 5000:1   | 4000:1                            | 3000:1                               |
| Viewing Angle (Typ.)                          | 178 degrees  |                                   |                                      |
| Response Time (Typ.)                          | 6.5ms  | 8.5ms                             | 6.5ms                                |
| Color Gamut                                   | 88% NTSC   |                                   | 98% NTSC                             |
| Display Color                                 | 1.07 billion (10-bit depth)  |                                   |                                      |
| <b>Connectivity</b>                           |  |                                   |                                      |
| Standard Inputs                               | DisplayPort 1.2, HDMI 2.0 x 2, HDMI 1.4 x 2, OPS   |                                   |                                      |
| HDCP 2.2                                      | Yes (HDMI 2.0)   |                                   |                                      |
| Audio Output                                  | Line out, S/PDIF out   |                                   |                                      |
| Control and Monitoring                        | LAN RJ45, RS232 In, IR, Keypad, Planar® UltraRes X™ Series App                           |                                   |                                      |

| Item                                   | URX75<br>URX75-ERO<br>URX75-ERO-T   | URX85<br>URX85-ERO<br>URX85-ERO-T  | URX100<br>URX100-ERO<br>URX100-ERO-T  |
|--|---|--|---|
| <b>Mechanical</b>                      |   |  |   |
| Display Dimensions                     | URX75: 66.3" x 37.9" x 3.7"<br>(1685.0mm x 963.0mm x 92.9mm)<br>URX75-ERO: 66.3" x 37.9" x 3.7"<br>(1685.0mm x 963.0mm x 92.9mm)<br>URX75-ERO-T: 67.8" x 39.3" x 4.1"<br>(1721.3mm x 999.3mm x 103.9mm) | URX85: 75.6" x 43.3" x 3.7"<br>(1919.0mm x 1100.0mm x 92.8mm)<br>URX85-ERO: 75.6" x 43.3" x 3.7"<br>(1919.0mm x 1100.0mm x 92.8mm)<br>URX85-ERO-T: 77.0" x 44.8" x 4.1"<br>(1956.0mm x 1137.0mm x 103.8mm) | URX100: 89.0" x 50.9" x 3.7"<br>(2261.0mm x 1294.0mm x 92.9mm)<br>URX100-ERO: 89.0" x 50.9" x 3.7"<br>(2261.0mm x 1294.0mm x 92.9mm)<br>URX100-ERO-T: 90.4" x 52.4" x 4.1"<br>(2297.0mm x 1331.0mm x 103.8mm) |
| Display Edge to Active Area            | URX75: 0.7" (17.2mm)<br>URX75-ERO: 0.7" (17.2mm)<br>URX75-ERO-T: 1.4" (35.0mm) left/right; 1.4" (34.4mm) top/bottom   | URX85: 0.9" (23.5mm)<br>URX85-ERO: 0.9" (23.5mm)<br>URX85-ERO-T: 1.6" (40.4mm)   | URX100: 1.1" (28.8mm) left/right; 1.1" (27.4mm) top/bottom<br>URX100-ERO: 1.1" (28.8mm) left/right; 1.1" (27.4mm) top/bottom<br>URX100-ERO-T: 1.9" (47.1mm) left/right; 1.8" (45.7mm) top/bottom              |
| Bezel Width                            | URX75: 0.6" (16.5mm)<br>URX75-ERO: 0.1" (3mm)<br>URX75-ERO-T: 0.7" (18.6mm)   | URX85: 0.9" (23mm)<br>URX85-ERO: 0.1" (3mm)<br>URX85-ERO-T: 0.7" (18.6mm)  | URX100: 1.1" (27.1mm)<br>URX100-ERO: 0.1" (3mm)<br>URX100-ERO-T: 0.7" (18.6mm)  |
| Display Weight                         | URX75: 145 lbs (66 kg)<br>URX75-ERO: 165 lbs (75 kg)<br>URX75-ERO-T: 175 lbs (79 kg)  | URX85: 190 lbs (86 kg)<br>URX85-ERO: 220 lbs (100 kg)<br>URX85-ERO-T: 225 lbs (102 kg)   | URX100: 300 lbs (136 kg)<br>URX100-ERO: 355 lbs (161 kg)<br>URX100-ERO-T: 365 lbs (166 kg)  |
| Mounting                               | Planar Profile Mounting System or VESA 400 mm x 400 mm  | Planar Profile Mounting System or VESA 600 mm x 400 mm   |   |
| Wall Mount Weight                      | 15lb (6.8kg)  |  |   |
| Fanless                                | Yes   |  |   |
| Speakers                               | 10W x 2 built-in  |  |   |
| <b>ERO (ERO and ERO-T models only)</b> |   |  |   |
| Surface Treatment                      | Anti-glare (AG)   |  | Anti-reflective (AR)  |
| Protective Glass                       | 2mm Corning® Gorilla® Glass   |  | 3mm soda-lime   |

| Item                                    | URX75<br>URX75-ERO<br>URX75-ERO-T  | URX85<br>URX85-ERO<br>URX85-ERO-T   | URX100<br>URX100-ERO<br>URX100-ERO-T   |
|---|--|---|--|
| <b>Touch (ERO-T models only)</b>        |  |   |  |
| Touch Technology                        | IR 20-point<br>Standard Writing: 10 points, 8mm minimum tip width<br>Fine Tip Writing: 5 points, 2mm minimum tip width |   | IR 20-point<br>Standard Writing: 10 points, 8mm minimum tip width<br>Fine Tip Writing: 2 points, 3mm minimum tip width |
| Touch Interface                         | USB-B  |   |  |
| Supporting OS                           | Windows 7, 8, 10, 11; Mac OSX, Linux   |   |  |
| <b>Usage</b>                            |  |   |  |
| Recommended Usage                       | Up to 24x7   |   |  |
| Backlight                               | D-LED  |   |  |
| Backlight Life                          | 50,000 hours min   | 70,000 hours min  | 50,000 hours min   |
| <b>Power Source</b>                     |  |   |  |
| Power Consumption (Typ.)                | 180W   | 270W  | 380W   |
| Power Consumption: Backlight Max (Typ.) | 240W   | 360W  | 505W   |
| BTU/hr (Typ.)                           | 180W x 3.42 BTU =<br>616 BTU/hr  | 270W x 3.42 BTU =<br>923 BTU/hr   | 380W x 3.42 BTU =<br>1300 BTU/hr   |
| Standby Power Consumption               | < 0.5W   |   |  |
| Input Voltage / Frequency               | AC 100-240V<br>50-60 Hz  |   |  |
| AC Inlet Type                           | C14  |   |  |
| <b>Environment</b>                      |  |   |  |
| Storage Temperature                     | Min -4°F ~ Max 140°F (-20°C ~ 60°C)  |   |  |
| Operating Temperature                   | Min 32°F ~ Max 104°F<br>(0-40°C) at up to 3000 m   | Min 32°F ~ Max 104°F<br>(0-40°C) at up to 1500 m<br>Min 32°F ~ Max 95°F<br>(0-35°C) at up to 3000 m | Min 32°F ~ Max 104°F<br>(0-40°C) at up to 3000 m   |
| Humidity                                | 20-85% RH  |   |  |
| Approvals                               | FCC Class A, cTUVus, CE  |   |  |



## 30.2 URX75-ERO

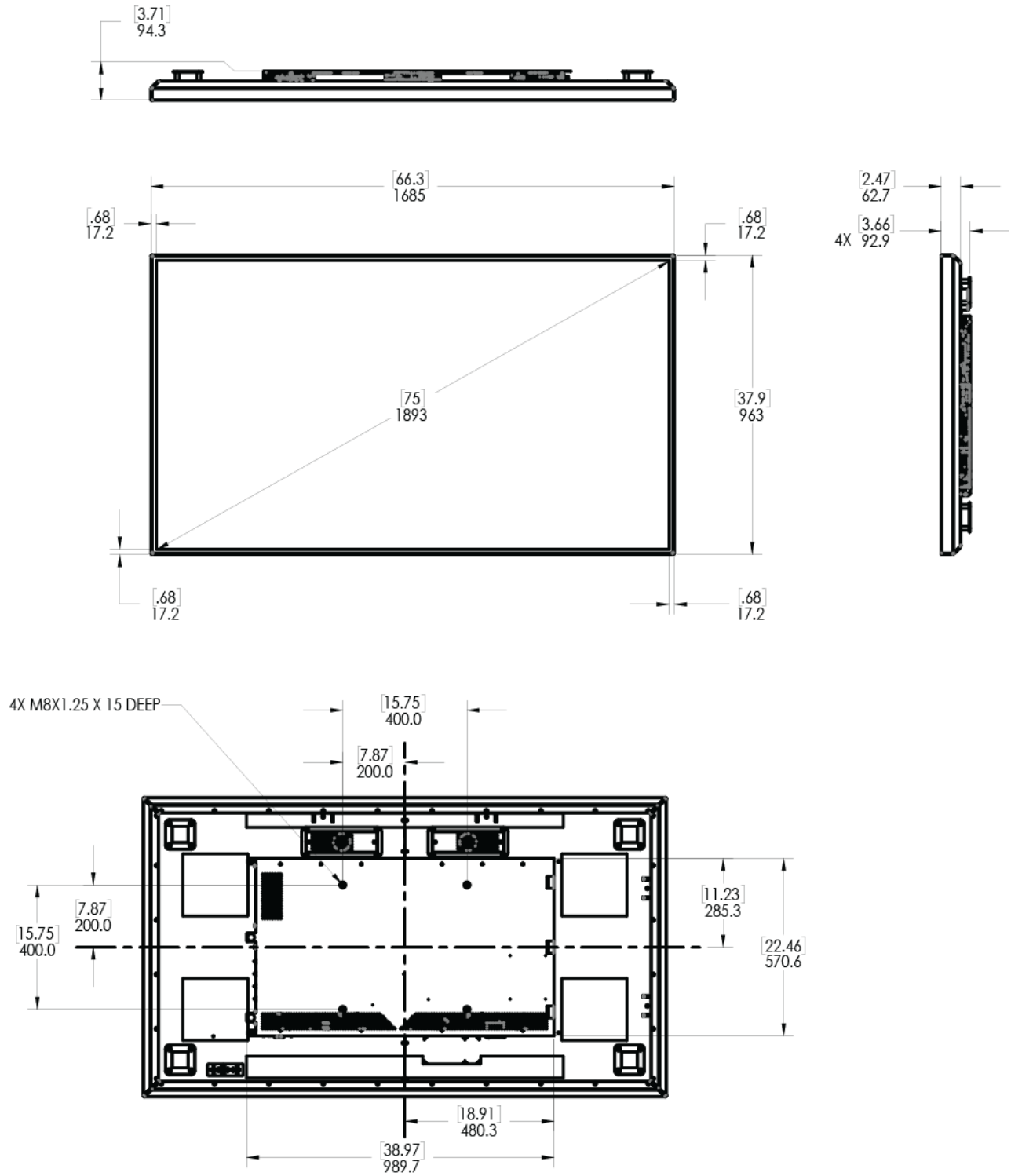



### 30.3 URX75-ERO-T

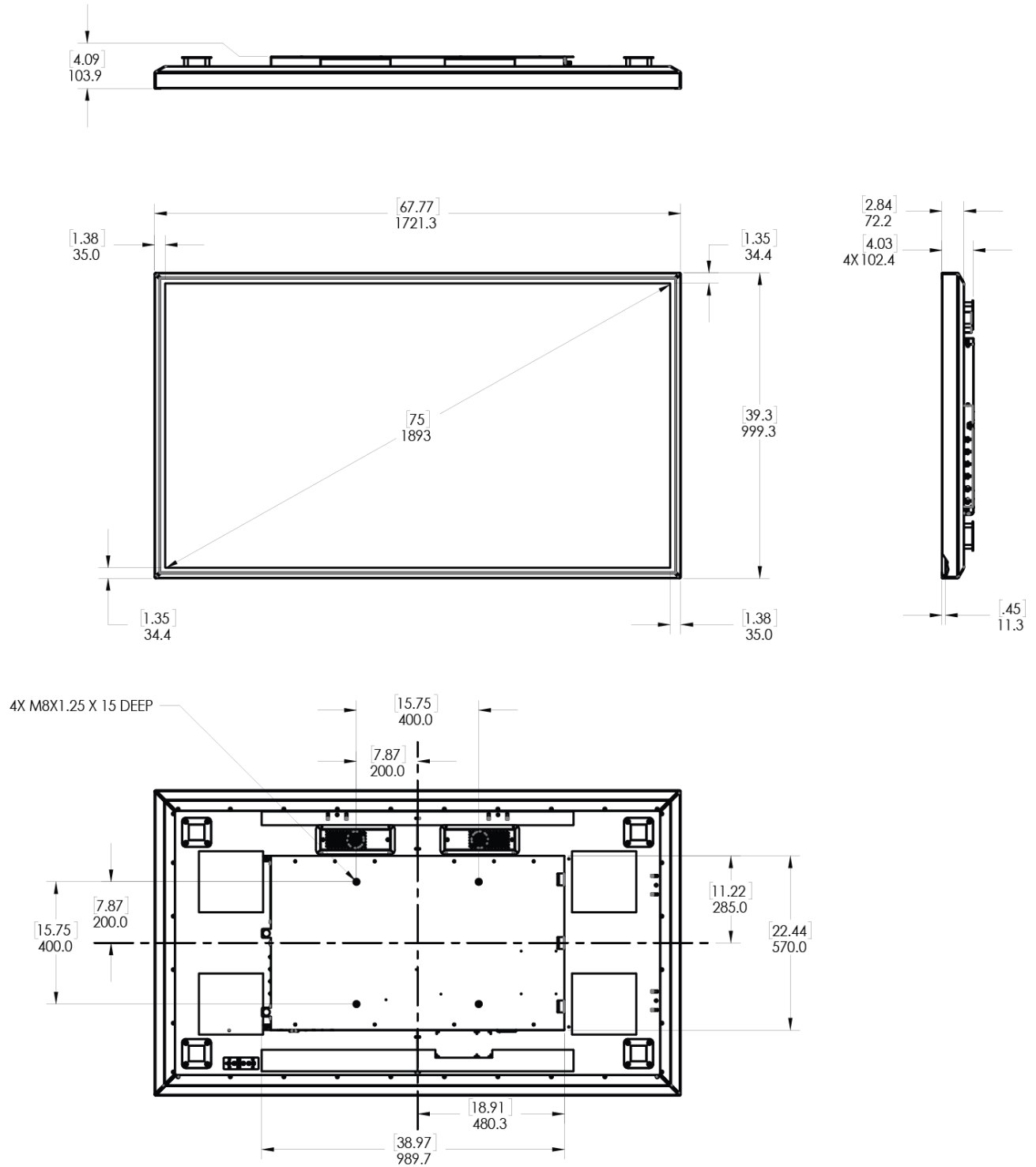

# 31. URX85

## 31.1 URX85 Standard

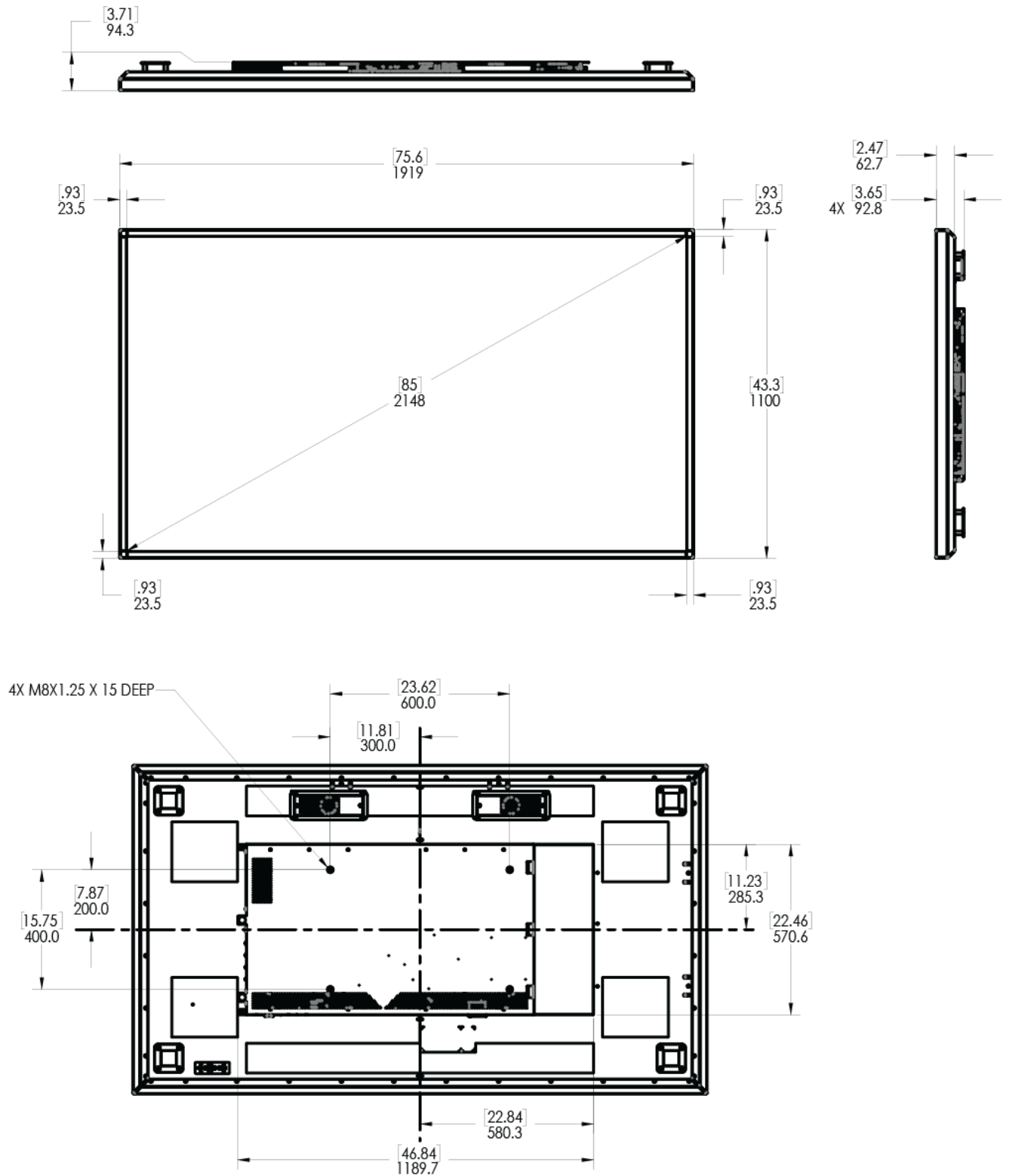

## 31.2 URX85-ERO

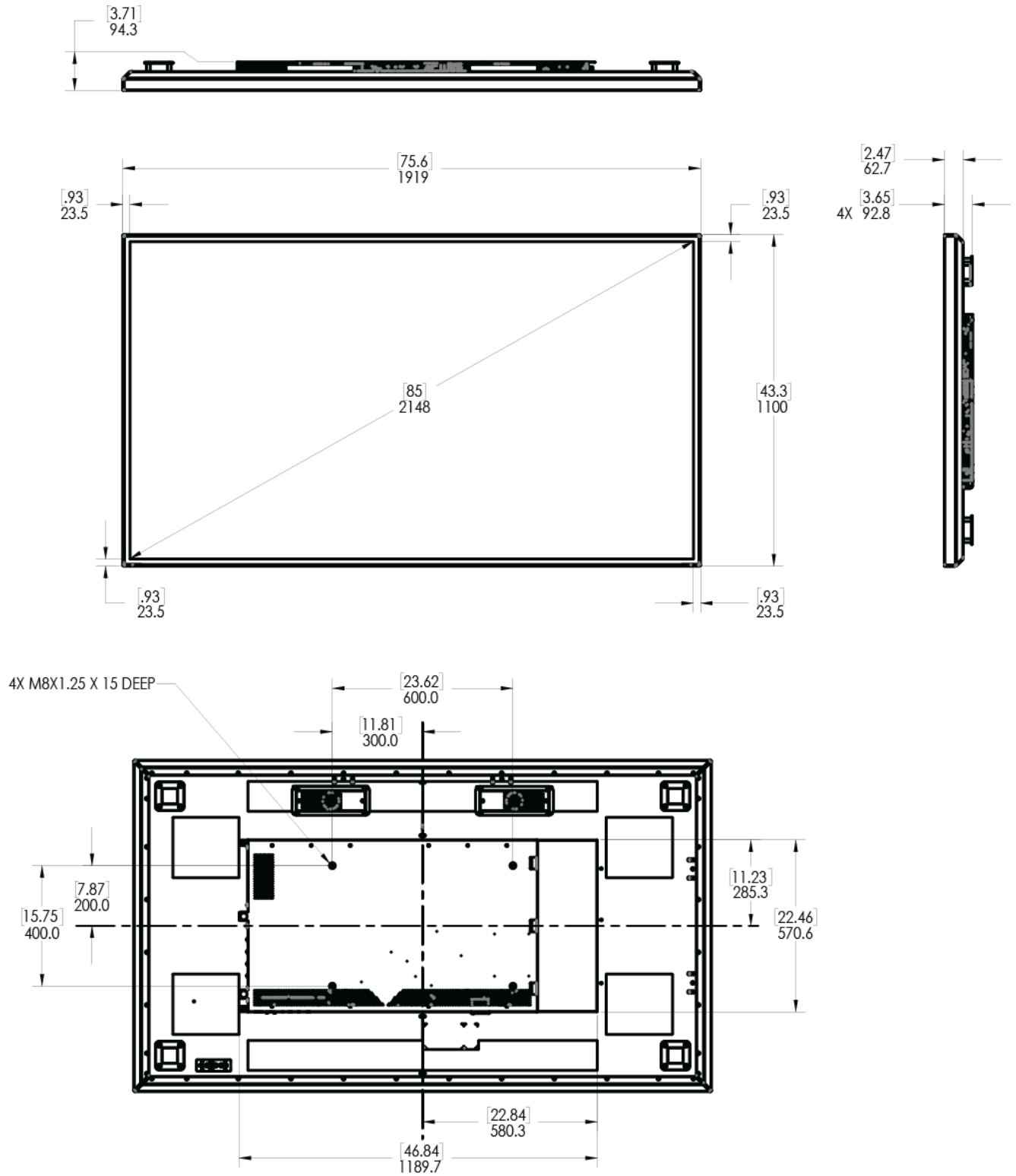

### 31.3 URX85-ERO-T

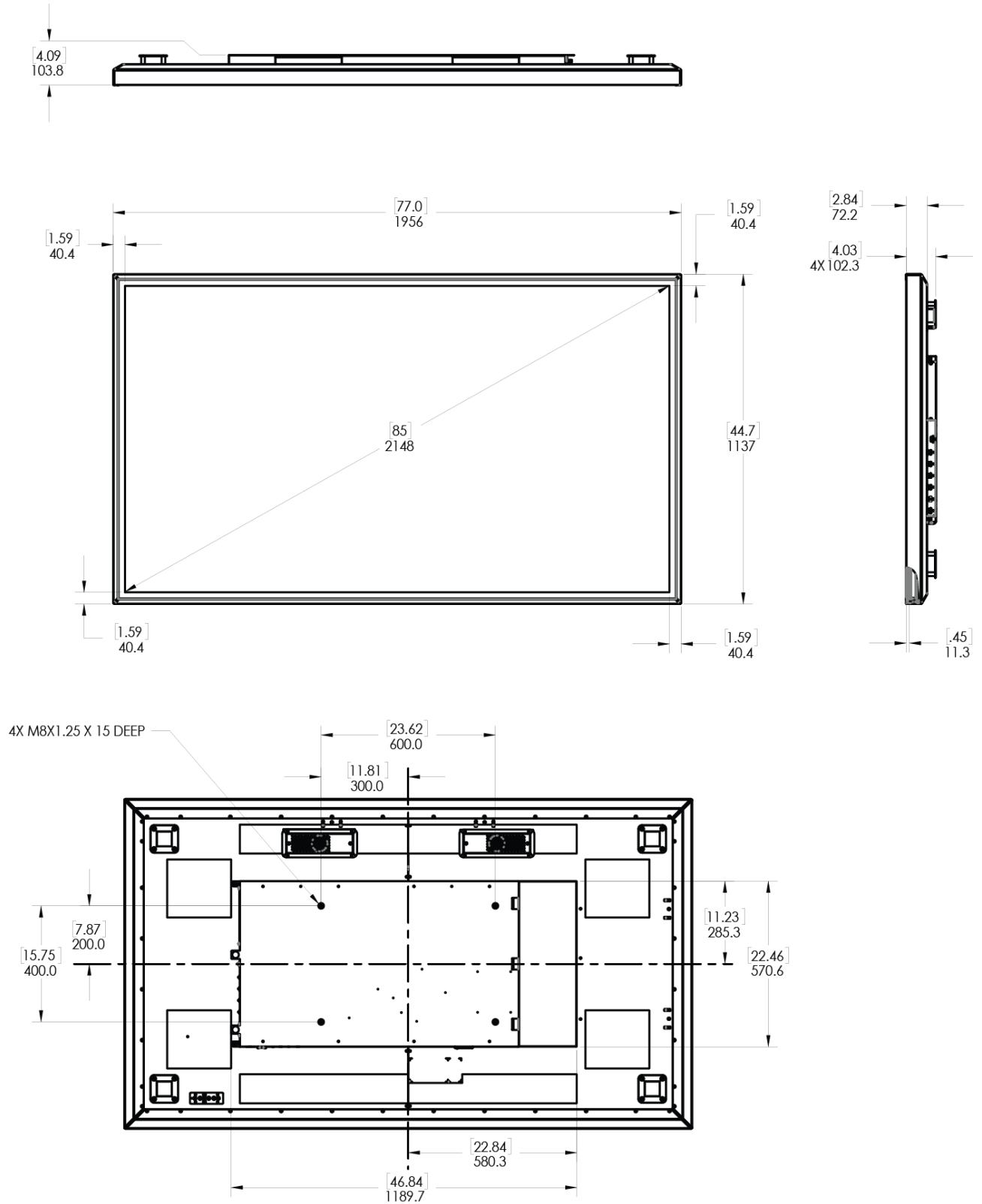

# 32. URX100

## 32.1 URX100 Standard

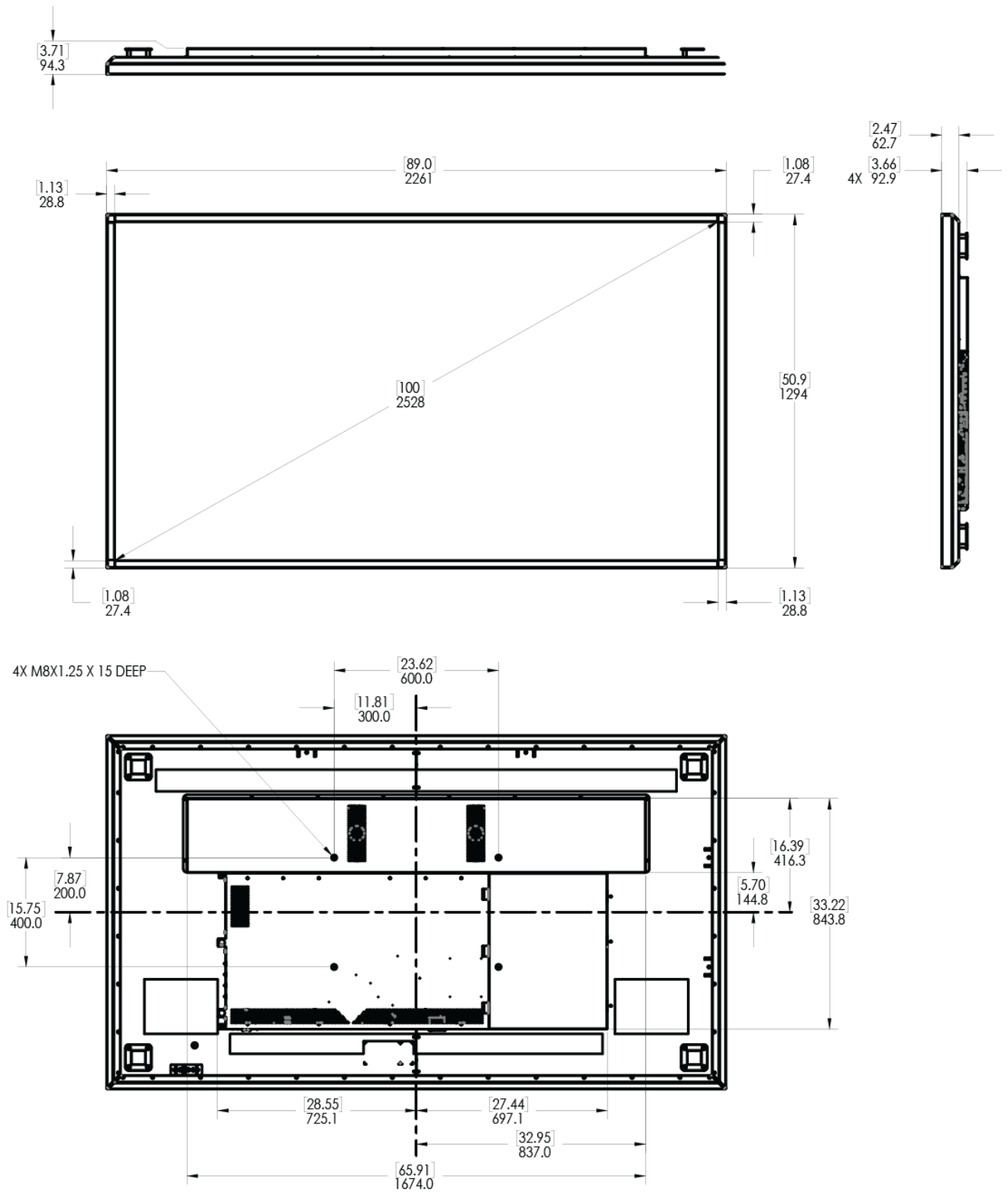

## 32.2 URX100-ERO

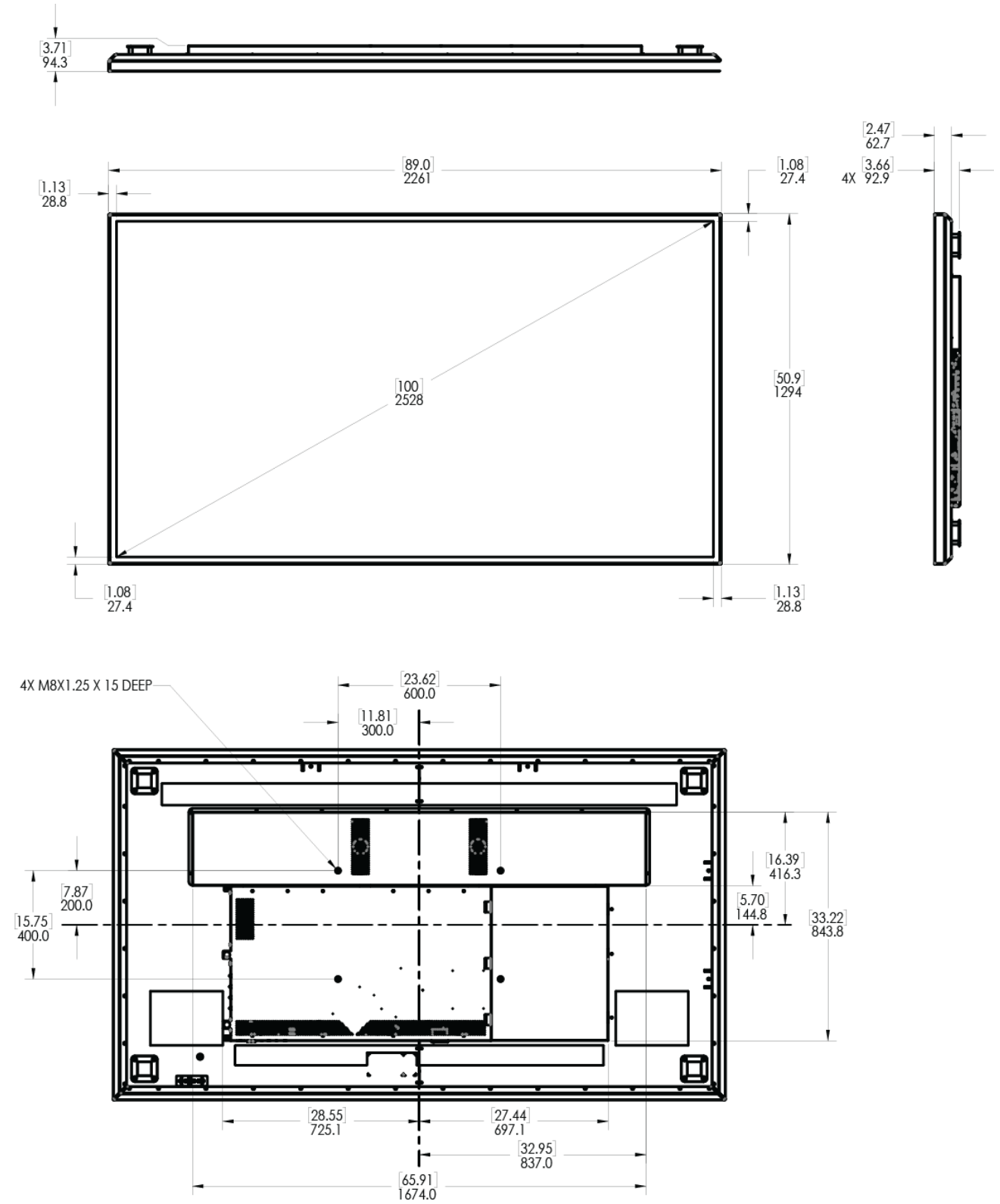

### 32.3 URX100-ERO-T

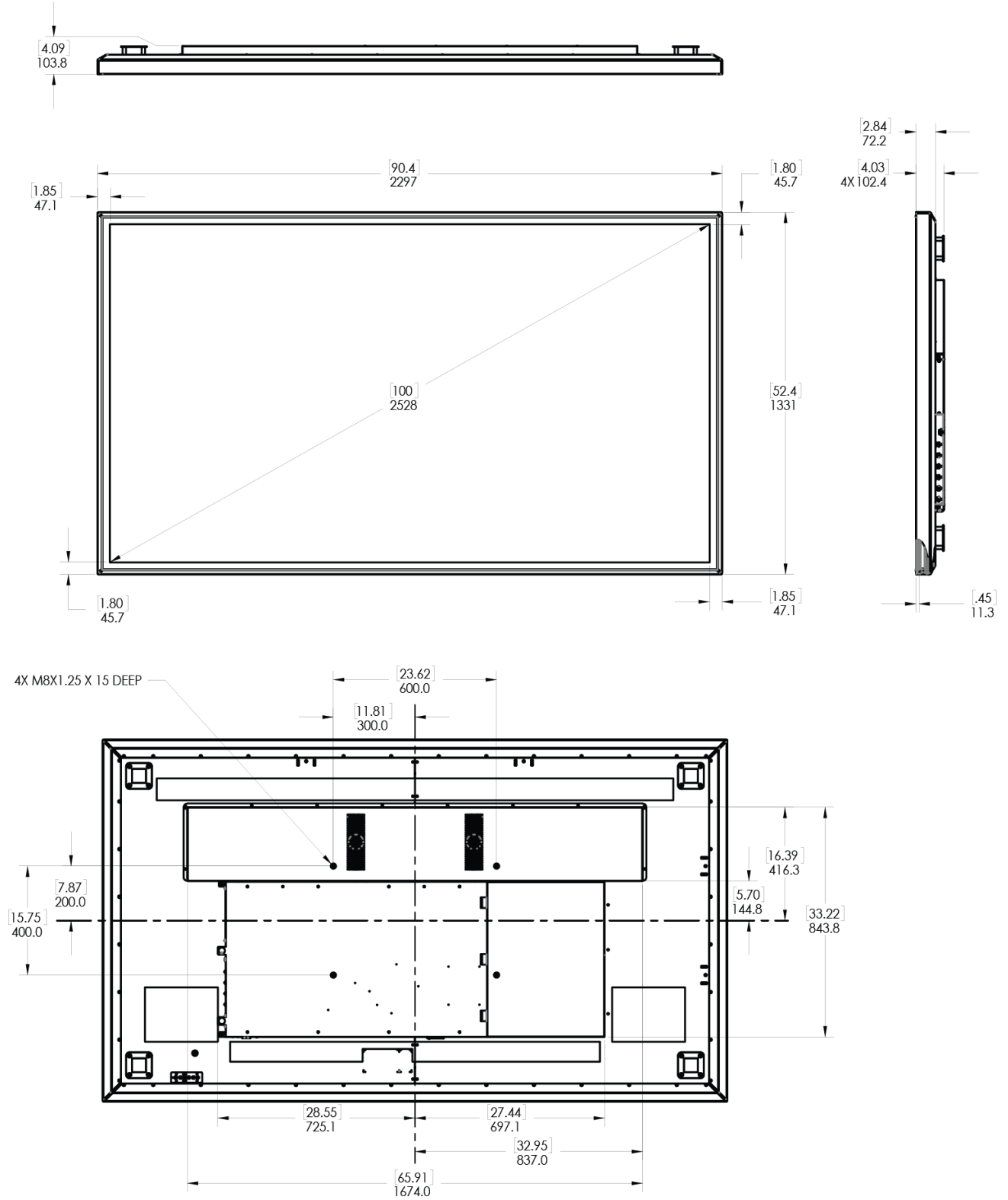

# Troubleshooting During Installation

This section includes troubleshooting information about different issues you may encounter during the installation process or after your display has been running for some time. If you are not able to solve your issue in this section, please contact Planar's Technical Support team for assistance.

## 33. Error Codes

To see the last 50 errors that have occurred, select the Error Log tab in the OSD (MAIN MENU > INFORMATION > ERROR LOG), as shown below.

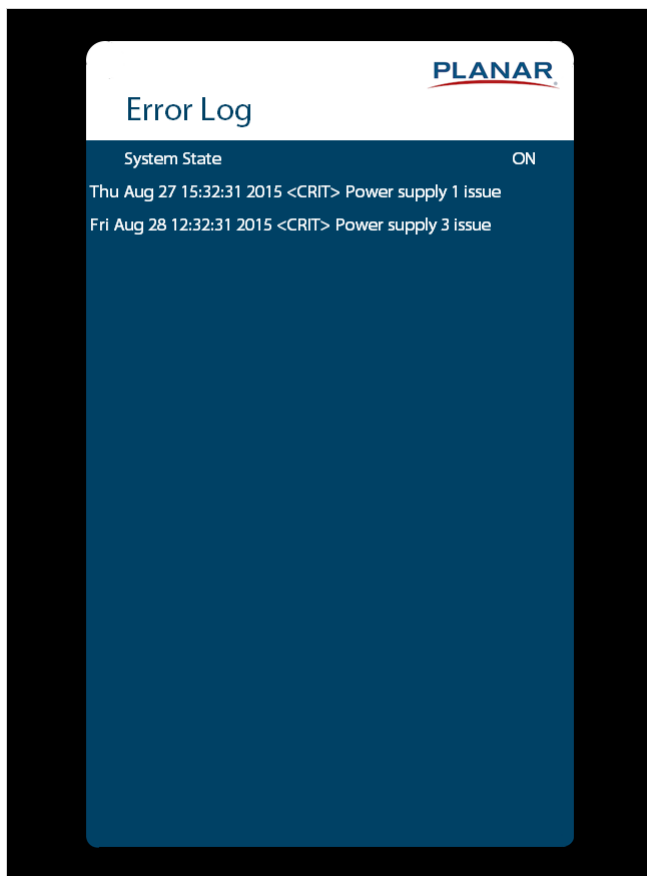



Possible error codes include:

- Power supply 1 issue
- Power supply 2 issue
- Power supply 3 issues do not apply to the 75" models
- Calibration EEPROM board disconnected

Note the following:

- One power supply failure will limit the backlight intensity to 50% maximum and two power supply failures will shut off the display.

## 34. Symptoms, Possible Causes and Solutions

Below are different symptoms that you might encounter as you install your Planar UltraRes X Series display. First look at the different symptoms to see if you can find your issue. And then look at the possible cause and try the suggested solution(s). If you still are not able to resolve your issue, please contact Planar's Technical Support Department.

### 34.1 Symptom: Display Doesn't Respond to External Control System

#### Solution

Confirm the **Power Down Mode** setting. **Networked standby** or **Fast Startup** are required to enable the use of external control devices. **Standby** disables all external control except IR, allowing the display to be in the lowest power setting. See "Power Down Mode" on page 49.

### 34.2 Symptom: Can't Get PC to Output 4K @ 24/30/60 Hz

#### Solution

Confirm that DisplayPort-to-HDMI adapters are not being used. These adapters do not support outputting 4K content.

#### Solution

Make sure you are using a high-speed HDMI or a Certified Premium HDMI cable. Standard HDMI cables might work but are not guaranteed.

#### Solution

Verify that the selected **EDID Type** setting in the OSD is **4K60** or **4K30**. If you change the EDID setting, you may need to disconnect and reconnect the cable.

#### Solution

If you are trying to use 4K @ 60 Hz on HDMI, the display must be connected to HDMI 1 or HDMI 2.

#### Solution

If you are trying to display 4K @ 60 Hz on HDMI 1 or HDMI 2, the Multi-Source View setting must be Single.

### 34.3 Symptom: Can't Get PC to Output 4K @ 24/30/60 Hz

#### Possible Cause

The connector overmold is too large, which can cause the pins not to contact properly on some cards.

#### Solution

If using DisplayPort, make sure the connector overmold isn't too large.



### 34.4 Symptom: Can't Select OPS or HDMI 1

#### Solution

The OPS and HDMI sources cannot be viewed at the same time. If your Multi-Source View setting is not Single, and you select OPS in a zone, any zones that are showing HDMI 1 will automatically change to OPS. Conversely, if you select HDMI 1 in a zone, any zones that are currently showing OPS will automatically change to HDMI 1.

## 34.5 Symptom: IR Isn't Working Properly

### Possible Cause

The wired IR module may not be fully connected.

### Solution

Make sure the IR is fully connected by pressing hard to ensure it is inserted as far as possible.

### Possible Cause

The wired IR module cable is not being used.

### Solution

Make sure that the wired IR module cable is being used.



## 34.6 Symptom: Touch Has Broken Response Near Middle/Bottom of Display

### Possible Cause

The display is mounted tilted forward.

### Solution

Reposition the display so it is vertical to slightly tilted back.

### Possible Cause

There are items blocking the IR sensors from emitting or receiving

### Solution

Clean display and sensor windows around the display.

# Accessing Planar's Technical Support Website

Go to <http://www.planar.com/support/> to access the following support documents and resources:

- User Manual
- RS232 User Manual
- Outline drawings
- Standard warranties
- Planar support hotline number and email
- Firmware (contact Planar support via email or phone)