

# Planar UltraRes Series User Manual



UR7551-MX  
UR8651-MX  
UR9851

**PLANAR**  
A LEYARD Company

Copyright © 19 Dec 2016 by Planar Systems, Inc. All rights reserved.

Contents of this publication may not be reproduced in any form without permission of Planar Systems, Inc.

### Trademark Credits

Windows™ is a trademark of Microsoft Corp.

All other companies are trademarks or registered trademarks of their respective companies.

### Disclaimer

The information contained in this document is subject to change without notice. Planar Systems, Inc. makes no warranty of any kind with regard to this material. While every precaution has been taken in the preparation of this manual, the Company shall not be liable for errors or omissions contained herein or for incidental or consequential damages in connection with the furnishing, performance, or use of this material.

### Warranty and Service Plans

Planar warranty and service plans will help you maximize your investment by providing great support, display uptime, and performance optimization. From post-sale technical support to a full suite of depot services, our services are performed by trained Planar employees. When you purchase a Planar product, you get more than a display, you get the service and support you need to maximize your investment. To find the latest warranty and service information regarding your Planar product, please visit <http://www.planar.com/support>

Part Number: 020-1301-01B

# Contents

<b>Introduction</b> .....	1
Safety Information .....	2
Safety Precautions .....	2
Recommended Usage .....	4
Mounting with a VESA Mount .....	6
Cleaning the Display .....	6
<b>Unpacking and Checking Accessories</b> .....	7
Package Contents .....	7
Accessory Kit .....	8
Planar UltraRes Series - Standard Inputs .....	9
<b>Installing the Displays</b> .....	10
Installing the Planar Profile Mounting System .....	11
Installing OPS Expansion (Optional) .....	24
Supported Graphics Cards .....	25
<b>Operating the Display</b> .....	26
OSD Keypad .....	26
Remote Control Receiver .....	27
LED Indicators .....	28
Using the Display in Portrait Mode .....	28
Using the Display in Flat or Tilted Orientation .....	28
Using the Remote Control .....	29
IR Command Protocol .....	30
Turning the Display On .....	33

Turning the Display Off.....33

Adjusting the Volume .....33

Selecting Layouts and Input Sources.....34

Navigating Through the Menus.....35

Using the Touch Screen .....68

Touchscreen MultiTouch Driver Installation .....68

Touchscreen (PQLabs) MultiTouch Platform Content .....68

Uninstalling the MultiTouch Driver .....69

**Planar UltraRes Remote Monitoring Software .....70**

Remote Monitoring Home.....70

Remote Monitoring System Information .....70

Remote Monitoring Inputs and Views.....71

Remote Monitoring Audio.....72

Remote Monitoring Presets.....73

Remote Monitoring Panel Brightness and Power .....74

Remote Monitoring Notifications .....75

Remote Monitoring System Settings.....76

Remote Monitoring Access Control .....77

**External Control .....78**

**Signal Compatibility .....79**

**Color Subsampling Support .....82**

**Specifications.....83**

**Dimensions .....86**

UR7551-MX.....86

UR7551-MX Touch .....87

UR8651-MX ..... 88

UR8651-MX Touch ..... 89

UR9851 ..... 90

UR9851 Touch ..... 91

**Troubleshooting During Installation..... 92**

    Error Codes ..... 92

    Symptoms, Possible Causes and Solutions ..... 93

**Accessing Planar’s Technical Support Website..... 96**



# Introduction

The Planar® UltraRes™ Series displays raise the bar for commercial 4K. Offered in 75", 86", and 98", these Ultra HD displays produce resolution and picture quality never before seen in large format LCD displays. Designed specifically for resolution-rich commercial applications, Planar UltraRes Series displays offer the image quality, connectivity, industrial design and configuration options required in high profile offices, leading control rooms, collaboration rooms and digital branding installations.

Features of the Planar UltraRes Series displays include:

- Best-in-class image and color quality for native and upscaled content
- Cutting edge video performance supporting up to 4K @ 60Hz with DisplayPort 1.2 and HDMI 2.0
- Planar® MediaPlex™ Plus Processing for advanced multi-source viewing and image adjustment control
- Next generation 4K compatibility
- Advanced design for function and style
- Fully integrated multi-touch models available
- Fanless, whisper-quiet

## Safety Information

Before using the Planar UltraRes Series, please read this manual thoroughly to help protect against damage to property, and to ensure personal safety.

- Be sure to observe the following instructions.
- For your safety, be sure to observe ALL the warnings detailed in this manual.
- For installation or adjustment, please follow this manual's instructions, and refer all servicing to qualified service personnel.

## Safety Precautions

- **If water is spilled or objects are dropped inside the display, remove the power plug from the outlet immediately.** Failure to do so may result in fire or electrical shock. Contact your dealer for inspection.
- **If the display is dropped or the chassis is damaged, remove the power plug from the outlet immediately.** Failure to do so may result in fire or electrical shock. Contact your dealer for inspection.

**WARNING!** Wall mounts must be secure.

- **If the display is hung on a wall, the wall must be strong enough to hold it.** Simply mounting it to wallboard or wall paneling won't be adequate or safe.

**Caution:** The screen could be damaged by heavy pressure.

- **Slight pressure on the LCD will cause distortion of the image.** Heavier pressure will cause permanent damage. Displays should be mounted where viewers cannot touch the screen or insert small objects in the openings that will create hazards by contacting bare conductive parts.

**Caution:** The front polarizer is soft and subject to scratches from sharp objects.

- **The polarizer is a thin sheet of film laminated to the outside layer of glass on the LCD screen.** Take care when handling items near the screen.
- **If the power cord or plug is damaged or becomes hot, turn off the main power switch of the display. Make sure the power plug has cooled down and remove the power plug from the outlet.** If the display is still used in this condition, it may cause a fire or an electrical shock. Contact your dealer for a replacement.



## Important Safety Instructions

- 1** Read these instructions.
- 2** Keep these instructions.
- 3** Heed all warnings.
- 4** Follow all instructions.
- 5** Do not use the display near water.
- 6** Clean the LCD screens with an LCD screen cleaner or LCD wipes.
- 7** Do not install near any heat sources such as radiators, heat registers, stoves or other apparatus (including amplifiers) that produce heat.
- 8** Do not defeat the safety purpose of the polarized or grounding type plug. A polarized plug has two blades with one wider than the other. A grounding type plug has two blades and a third grounding prong. The wide blade or the third prong is provided for your safety. When the provided plug does not fit into your outlet, consult an electrician for the replacement of the obsolete outlet.
- 9** Protect the power cord from being walked on or pinched, particularly at plugs, convenience receptacles and the point where they exit from any of the displays.
- 10** Only use the attachments/accessories specified by the manufacturer.
- 11** Unplug all displays during lightning storms or when unused for long periods of time.
- 12** You must follow all National Electrical Code regulations. In addition, be aware of local codes and ordinances when installing your system.
- 13** Refer all servicing to qualified service personnel. Servicing is required when any of the displays have been damaged in any way. For example, if the AC power cord or plug is damaged, liquid has been spilled or objects have fallen into a display, the displays have been exposed to rain or moisture, do not operate normally or have been dropped.
- 14** Keep the packing material in case the equipment should ever need to be shipped.

## Recommended Usage

In order to get the most out of your LCD, use the following recommended guidelines to optimize the display.

### Burn-In Versus Temporary Image Retention

Burn-in causes the screen to retain an image essentially forever, with little or no way to correct the problem. Under normal use, an LCD will not experience burn-in, as plasma displays do, nor will it retain images in any way.

Normal use of an LCD is defined as displaying continuously changing video patterns or images. However, LCDs can experience *temporary* image retention when recommended usage guidelines are not followed.

#### What is Temporary Image Retention?

Temporary image retention (TIR) can occur when a static image is displayed continuously for extended periods of time (12 hours or longer). An electrical charge differential may build up between the electrodes of the liquid crystal, which causes a negative-color video image (color-inverted and brightness-inverted version of the previous image) to be retained when a new image is displayed. This behavior is true for any LCD device from any LCD manufacturer.

TIR is not covered under warranty. See standard warranty terms and conditions for details. Here are some guidelines to help you avoid TIR:

- Use the LCD to show a screen saver, moving images or still pictures that change regularly. When using high-contrast images, reposition the images frequently.
- Turn off the LCD when it is not in use. To use your source computer's Power Options Properties, set up your computer to turn off the display when not in use.

### Warranty Coverage

The following models are warranted for **24 x 7** usage:

- 75": UR7551-MX, UR7551-MX-ERO, UR7551-MX-ERO-T
- 86": UR8651-MX, UR8651-MX-ERO, UR8651-MX-ERO-T
- 98": UR9851, UR9851-ERO, UR9851-ERO-T

Planar recommends turning off the power for **4 hours per day** for optimal performance.

For complete warranty details, please visit [www.planar.com/warranty](http://www.planar.com/warranty).

## Important Waste Disposal Information

Please recycle or dispose of all electronic waste in accordance with local, state, and federal laws. Additional resources can be found online at <http://www.planar.com/about/green/>.



## Normal Usage Guidelines

Normal use of the LCD is defined as operating in the open air to prevent heat buildup, and without direct or indirect heat sources such as lighting fixtures, heating ducts, or direct sunlight that can cause the displays to experience high operating temperatures. For all displays, do not block fans or ventilation openings. If the LCD display will be installed in a recessed area with an LCD surround or enclosure, ensure adequate openings are applied for proper air flow and ventilation.

It is up to the installer to ensure that display placement is changed, thermal shielding is provided and/or additional ventilation is provided to keep the display within its nominal operating parameters. Maximum ambient operating temperatures for the Planar UltraRes Series are:

- 75" Planar UltraRes models: 0-40°C at up to 1500 meters and 0-35°C at up to 3000 meters
- 86" and 98" Planar UltraRes models: 0-35°C at up to 1500 meters and 0-30°C at up to 3000 meters

### Cooling Requirements

For optimal performance, active cooling by the installer should be planned for when the ambient temperature anywhere in the wall is predicted to be above the specified ambient temperature for the display.

## Mounting with a VESA Mount

The Planar UltraRes Series can be mounted with the Planar Profile Mounting System (see page 11) or with a VESA mount, available from Planar or other manufacturers.

If you purchased a VESA mount, you should have received a separate box with mounting supplies and an Installation manual. Follow these instructions carefully.

Keep in mind the following general installation guidelines:

- Screw length is crucial and will vary depending on the type of mount you use. Total screw length will include the penetration length plus the length required by the type of VESA mount in use.

**Caution:** Shorter screws will result in insufficient mounting strength and longer screws could puncture parts inside the display.

- Prior to installation, make sure you know where all of the mounting points are located.
- Follow all safety precautions outlined in the VESA Installation manual.
- Verify the parts received with the list shown in the VESA Installation manual.

## Cleaning the Display

If dust has collected on the power plug, remove the plug from the outlet and clean off the dust. Dust build-up may cause a fire.



Remove the power plug before cleaning. Failure to do so may result in electrical shock or damage.

Keep the following points in mind when cleaning the surface of the display:







- When the surface of the display becomes dirty, wipe the surface lightly with a soft clean cloth.
- If the surface requires additional cleaning, use LCD screen cleaner or LCD wipes, which are available at most electronics stores.
- Do not let cleaner seep into the display, as it may cause electrical shock or damage.

# Unpacking and Checking Accessories

## Package Contents

Part	Description	Number	Picture
LCD display	One per box.	1	
LCD mounts (optional)	If ordered, this will be inside a separate box inside the LCD box. <b>Note:</b> If you do not use Planar's mounts, you need to ensure the mounts that you purchase can adequately support the display.	1	
Mounting template	Used to line up where the wall mounts will be installed. This is included with Planar's optional LCD mounts.	2	

## Accessory Kit

Part	Description	Number Included	Picture
AC power cord	Power cord.	1	
IR sensor	Used to receive signals from the remote control.	1	
USB drive	Contains the User Manual, touch drivers and USB-to-serial driver.	1	
USB cable	Connects to a PC for touch functionality (touch models only) and serial commands (all models).	1	
Remote control	Used to control the display. 2 AA batteries are included but not installed.	1	
Carrying Strap	For lifting and carrying the display using three people	2	
Planar® TouchMark™ Single License Key Card	Annotation and whiteboarding software (touch models only)	1	

# Planar UltraRes Series - Standard Inputs

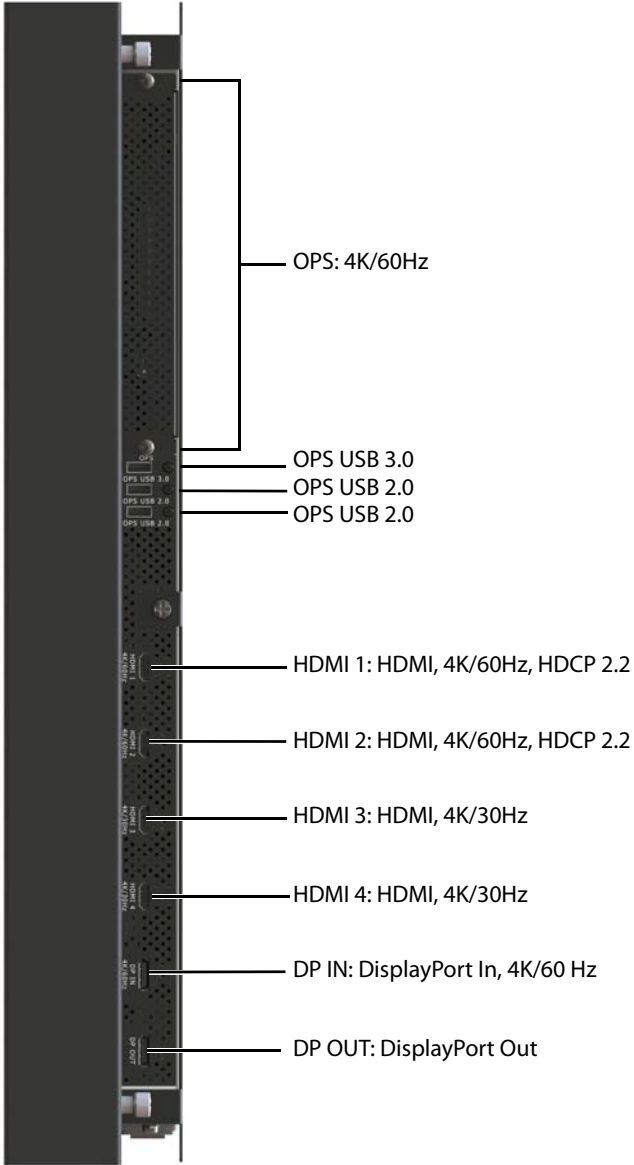

**Note:** Only one HDCP 2.2 source can be displayed at a time. If HDMI 1 and HDMI 2 are both being shown on the display at the same time, only HDMI 1 will support HDCP 2.2 content.

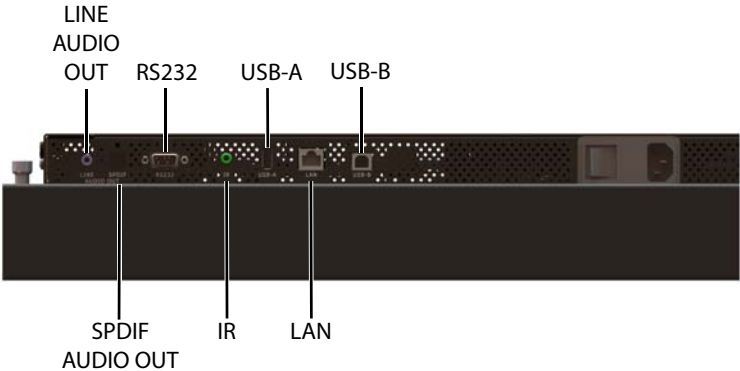

# Installing the Displays

Before installation, keep the following points in mind:

- These displays are heavy. Make sure that you have adequate studs to support the weight of each display if installing on a wall.
- The Planar UltraRes display must be installed on a flat surface.
- If you ordered the optional wall mounts, use the supplied UltraRes mounting template for the center point of the display, as well as for top and bottom bracket installation.
- The wall mounts for a landscape and portrait installation look very similar. The process to install them is almost exactly the same. The only difference is the way in which you use the wall mount template. This will be pointed out in the relevant step.



## Installing the Planar Profile Mounting System

**Caution:** For whatever structure is used to mount the display, be sure that it is sufficiently engineered to handle the weight of the display. Also be sure to purchase the correct hardware needed to support the display mounted to that structure.

**Caution:** If the unit being installed is fitted with a touch input device, it is important that the touch frame is not used to lift the unit. Also, the unit should never be placed on the touch frame to support the unit.

- 1 Find the center point of the display on the wall where you intend to install it.

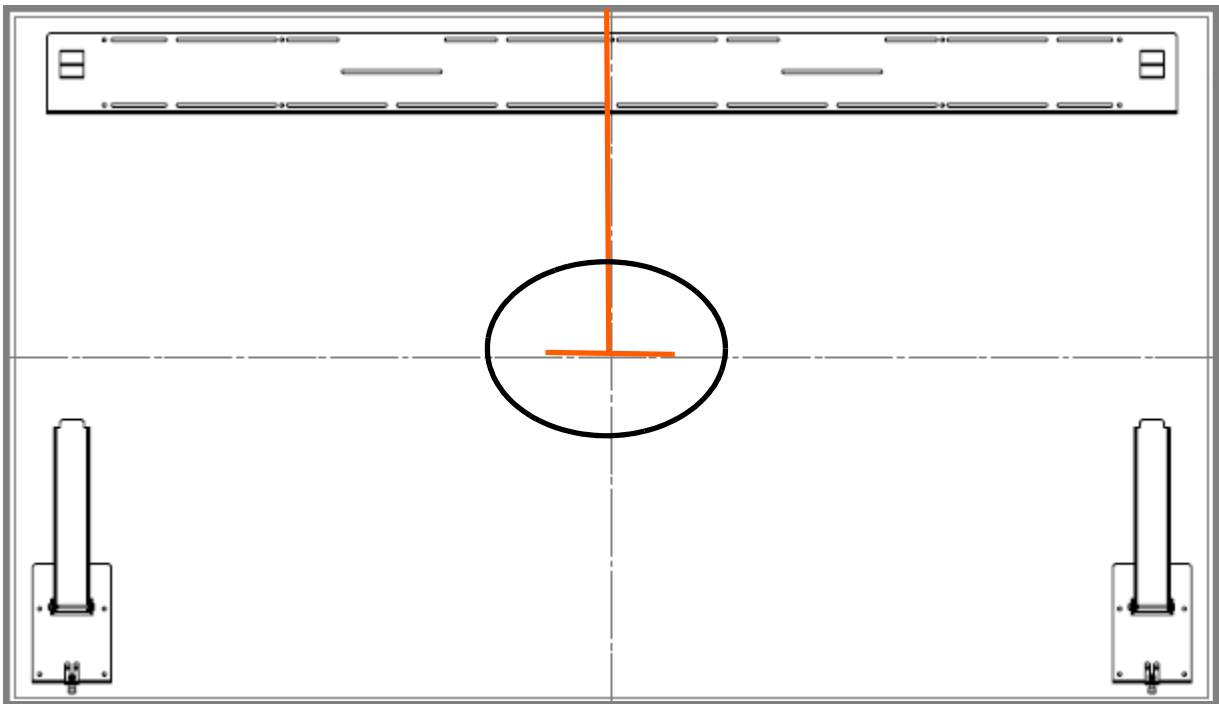

- 2 Draw a short (about 1") horizontal line and then a vertical line to just below the top edge of the display.

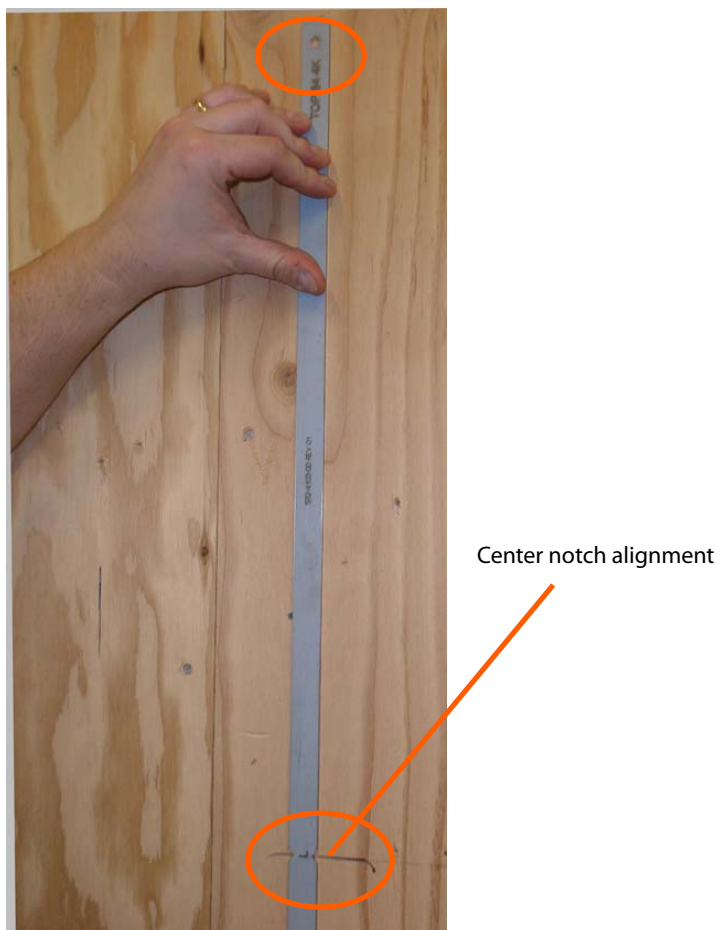

- 3 Use the provided template to determine the center points of the wall mounts. The "V" notches are labeled "Short Center" and "Long Center". Use the "Short Center" hole for a landscape display and the "Long Center" hole for a portrait display. Use the appropriate "V" notch to align with the horizontal line drawn in the previous step.

- 4 In the hole marked "Top" on the template, mark the center of the hole on the wall. Be sure the vertical line runs through the center of the hole and that the template is plumb. You may wish to screw the template in place to make the next steps easier.



**Note:** If you are installing a landscape display and the template is too long, you can break the template at the notch below the "L BTM" hole.

- 5 Let the template hang vertically so it is plumb, as the bottom hole in the template determines where the bottom mount will be installed.
- 6 Mark the center of the hole at the bottom of the template that corresponds with your display orientation.

- 7 If you have screwed the template in place, remove each screw and the template.
- 8 Turn the template horizontally and line the appropriate center hole up with the bottom hole you marked on the wall. This time, use the "LONG CENTER" for a landscape panel and the "SHORT CENTER" for a portrait panel. Ensure that the template is flat against the wall and level.



- 9 Mark hole locations for the bottom mounts. One side should use the next hole in from the "TOP" labeled hole and the other should use the next inward hole from "P BTM" for landscape or "L BTM" for portrait (ignoring the centering holes).

- 10 Line up the middle hole of the top wall mount with the screw hole drilled from the template.



**Note:** This picture shows mounts for a landscape installation.

- 11 Tighten the screw into the mount.
- 12 Use a level to make sure the mount is level.
- 13 Then install additional screws as needed.

**Note:** Screws installed near the mount hooks provide the best support.

- 14 Install the bottom mount brackets such that the holes marked earlier line up with the inner bottom hole on the bottom mount bracket. Ensure the bottom mounts are level and install at least one additional screw in each bottom mount.



- 15** Using three physically capable people, carefully hang the back of the display onto the top wall mount bracket using the square brackets on the back of the display.

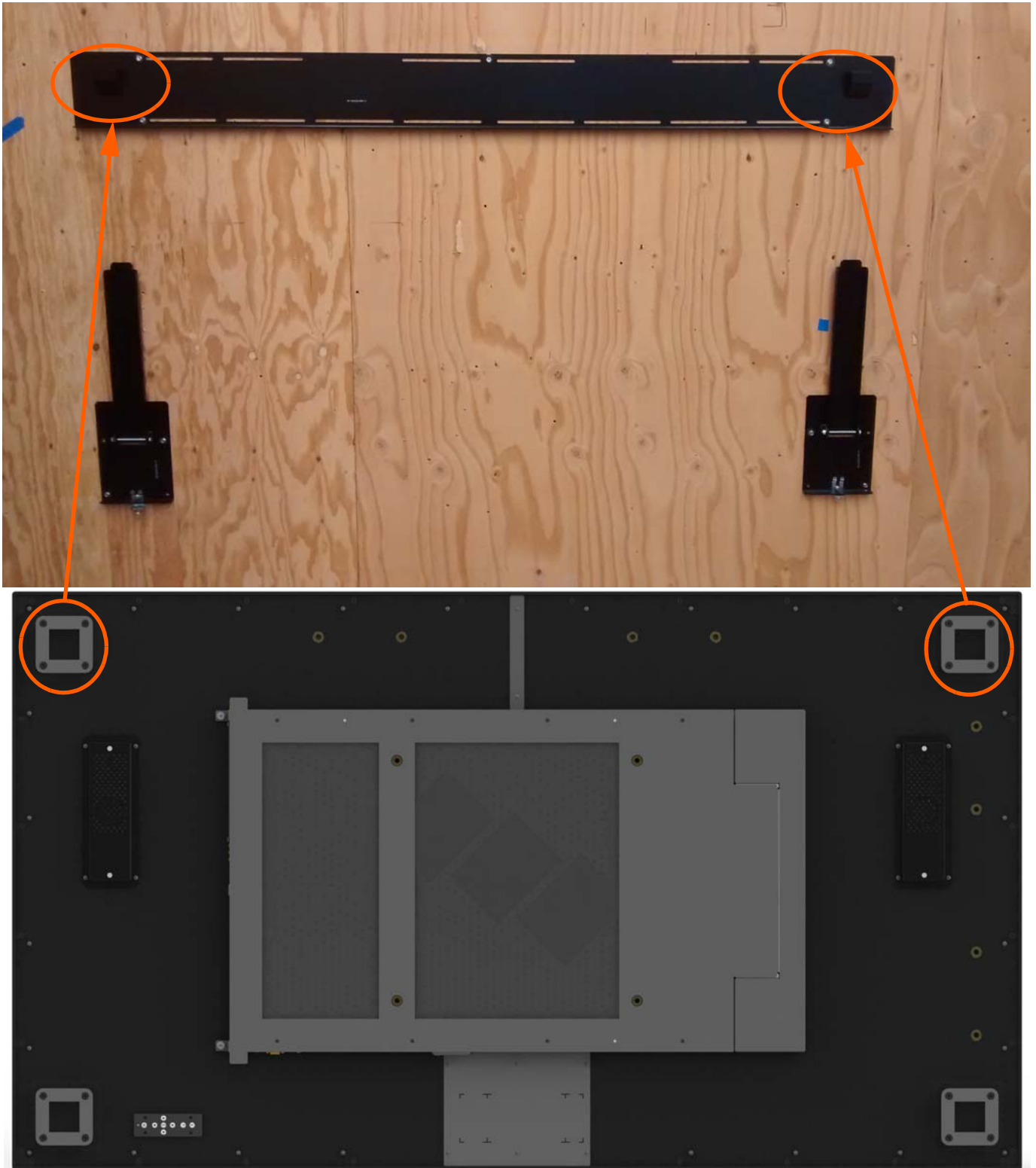



**Caution:** Be sure these are securely hung, as the top of the wall mount will hold all of the weight of the display.

As an alternative, you can use the optional lift blocks along with a lift assist mechanism to lift the panel into place. For details, refer to "Using the Lift Blocks" on page 19.

- 16** On the bottom wall mounts, there is locking hardware on the bottom of each mount. Push the hardware up and finger tighten the captive screws on the bottom to secure the display to the wall.





## Using the Lift Blocks

- 1 Attach the lift blocks to the back of the panel using the provided M8 x 35 pan head screws.
- 2 Securely attach your lift mechanism to the eyehooks:
  - a Spreader bar attachment: A spreader bar allows for a small lift profile and less stress on the panel and eyehooks than a single point attachment. This is the preferred method.

Spreader Bar Lift: Landscape

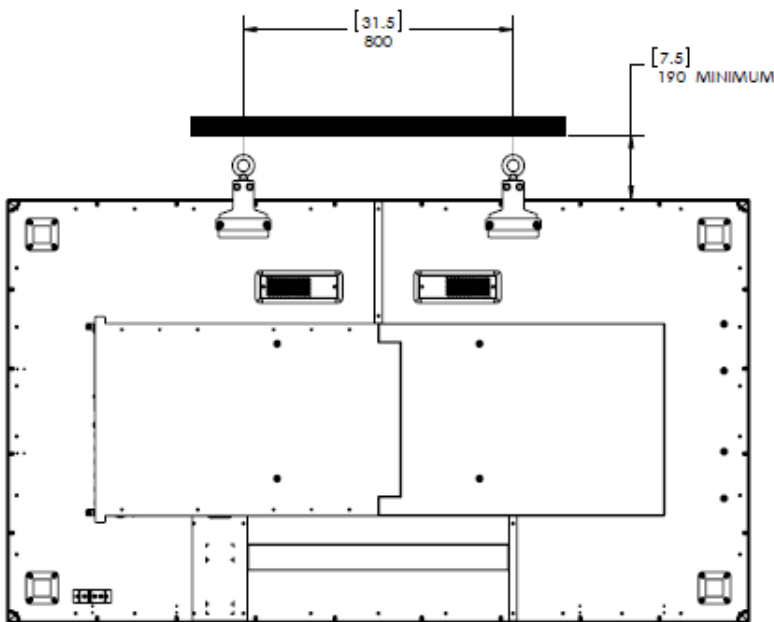

Spreader Bar Lift: Portrait

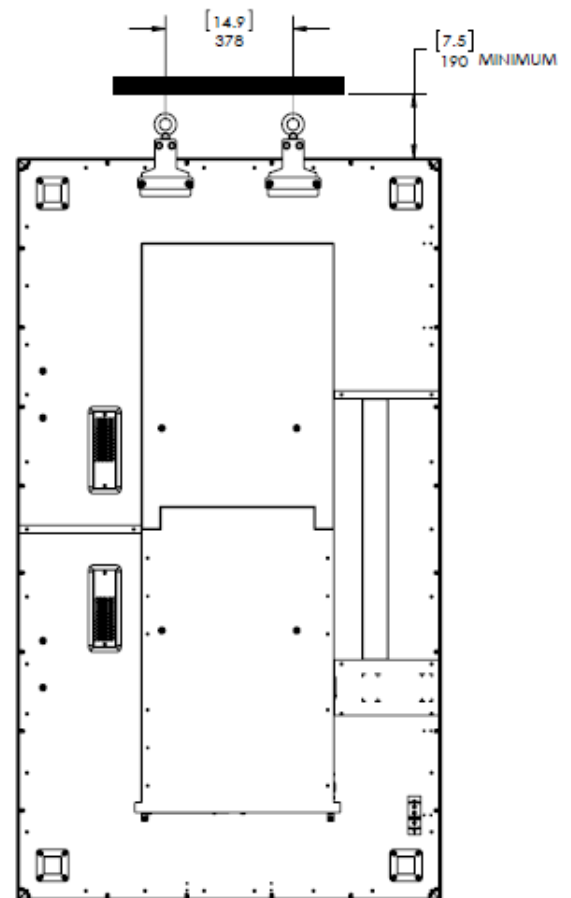

- b** Single point attachment: The angle between the top of the panel and the support lines should not be less than 45 degrees.

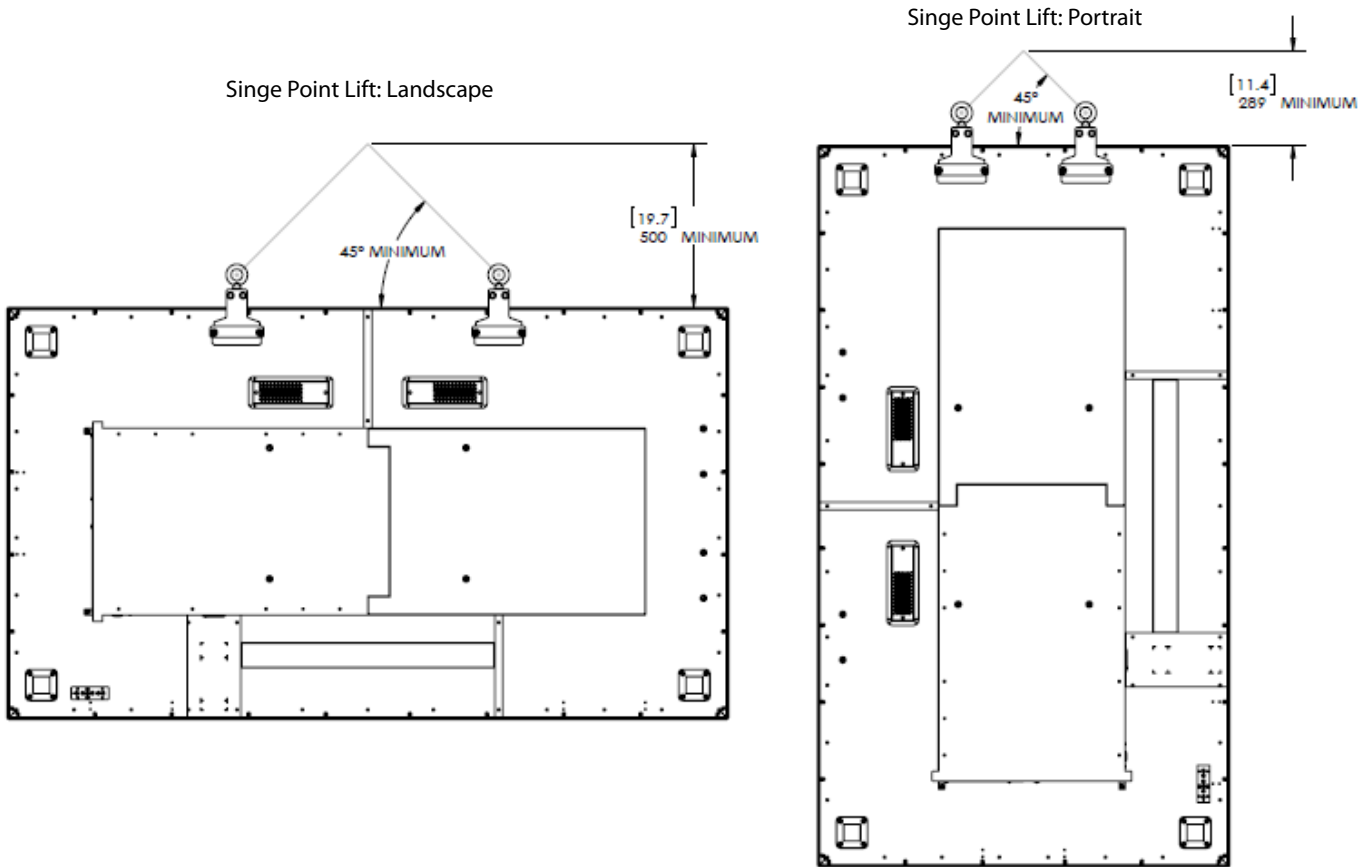

- 3** Lift the panel into place.
- 4** Detach the upper half of the lift block from the lower half by removing the two vertical screws. This leaves the bottom half attached to the panel but hidden.

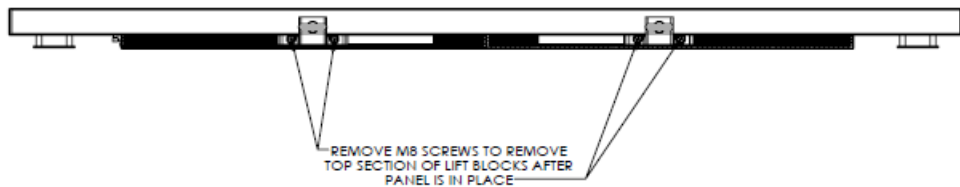

## Using the Kickstand Bracket

The kickstand bracket is used for service mode, without having to remove the display from the wall. Use the following instructions to put the display in service mode.

- 1 Loosen the captive locking screws on both sides of the bottom mount, and let the brackets hang down freely.



- 2 Pull the display out and then swing the kickstands down to hold it in place. The kickstands will nest into the bottom mount brackets. Make sure to use both kickstands as using only one can cause stresses in the panel that could cause damage.

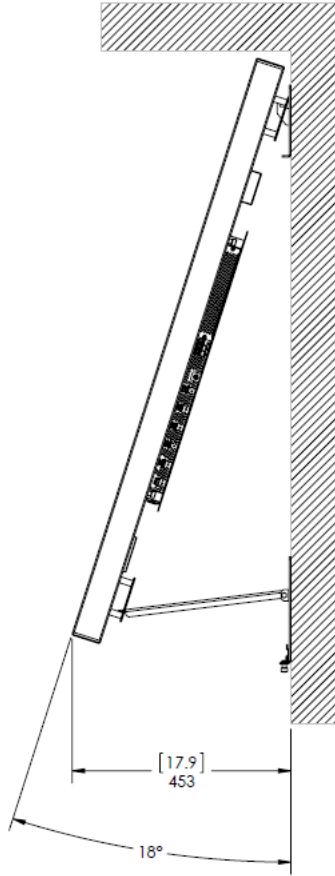

## Cable Length Recommendations

Cable length performance may vary between different cables and sources. The recommended maximum DisplayPort length is 3m for DisplayPort 1.2 and 5m for DisplayPort 1.1. HDMI cable length is recommended as follows:

- 4K @ 50/60Hz: 5m maximum
- 4K @ 24/25/30Hz: 15m maximum
- 1080p @ 60Hz and lower resolutions: 30m maximum

## Installing OPS Expansion (Optional)

Planar UltraRes Series displays are equipped with an expansion slot that supports the Intel® Open Pluggable Specification (OPS). The slot will support OPS devices such as PC's, SDI modules, HDBaseT receivers, etc.

To install an OPS device, remove the protective cover on the display and slide the device firmly into position. When installed, the OPS device will be connected internally to the display. No external video or power cables are required.

For convenience, two Type-A USB 2.0 ports and one Type-A USB 3.0 port are provided on the side I/O panel below the OPS slot. When an OPS device is installed, these USB ports can be used for a keyboard, webcam, USB drive, or other peripherals.

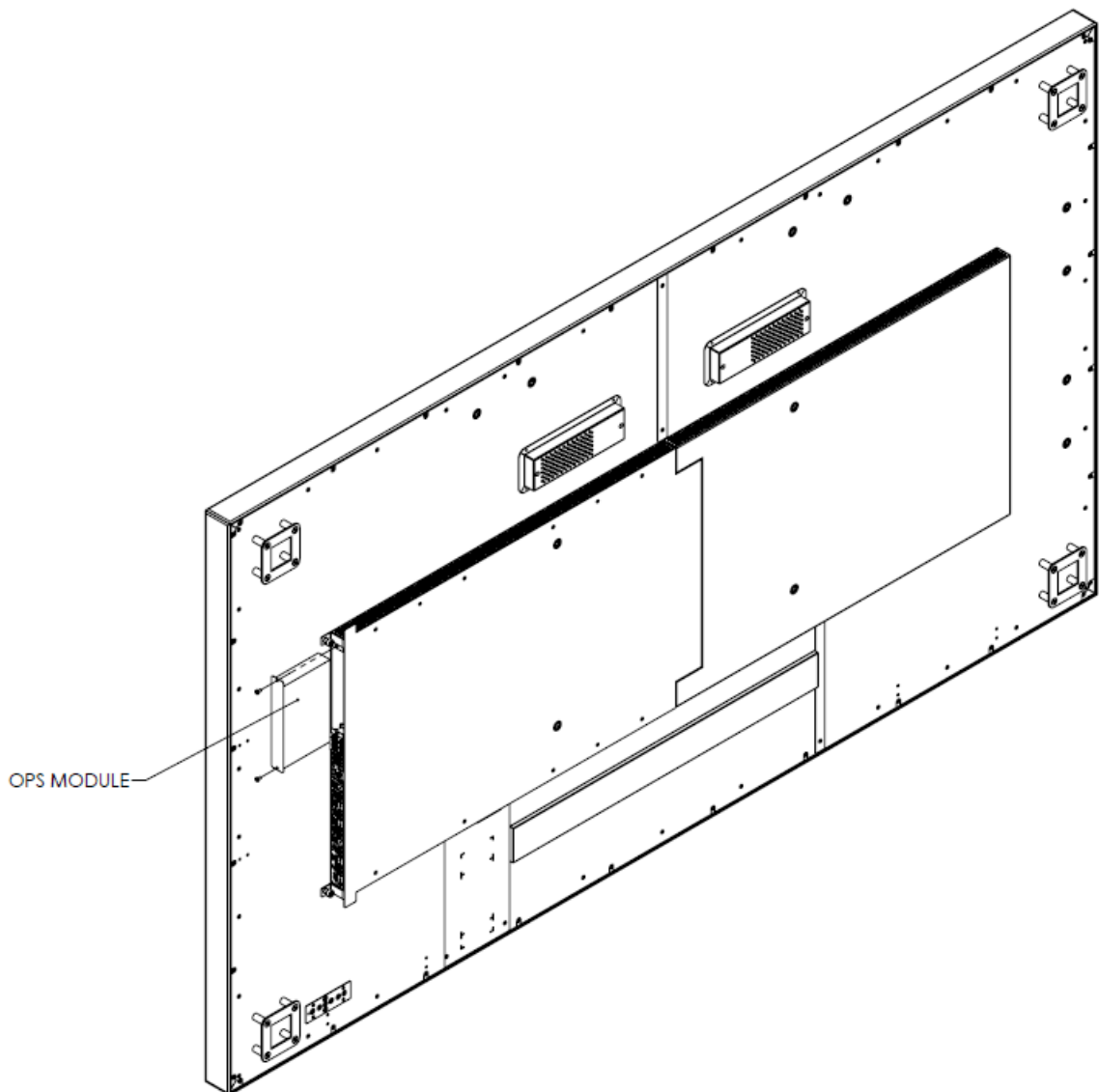

## Supported Graphics Cards

Planar UltraRes Series displays support a variety of graphics cards from leading manufacturers, such as NVIDIA and AMD. In general, you should be looking for graphics cards that have the following features:

- Can output 3840 x 2160 at 24 Hz or 30 Hz over a single DisplayPort or HDMI connection.
- Four-output graphics cards that can output synchronized (genlocked) 1920 x 1080 outputs at up to 60 Hz.
- Cards that support Planar's support timings, as listed in the following section "Signal Compatibility" on page 79.

**Caution:** Before you purchase a graphics card for your source, contact your Sales Representative to get the most current information on Planar's compatibility with leading graphics cards.

# Operating the Display

## OSD Keypad

The OSD keypad is located on the rear of the display.

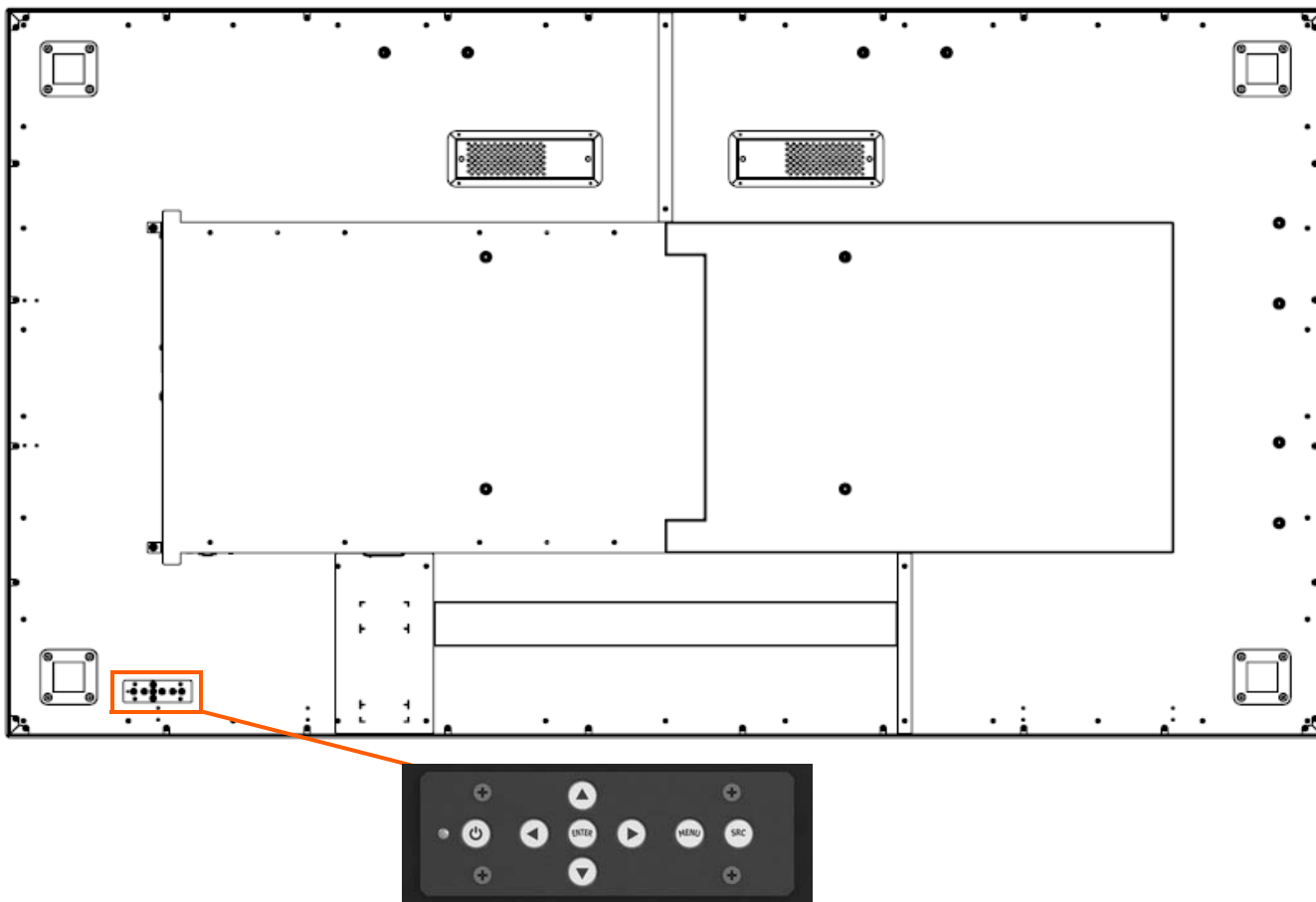

**OSD Keypad Buttons**

Key	Descriptions
Power	Power on/Power off
◀	Menu Left/Decrease value
▶	Menu Right/Increase value
▲	Menu Up/Increase volume
▼	Menu Down/Decrease volume
Menu	Menu/Exit
SRC	Source selection (toggle)



## Remote Control Receiver

The remote control receiver is located near the keypad on the rear of the display. Use the IR extender cable for operating the remote from the front of the display.

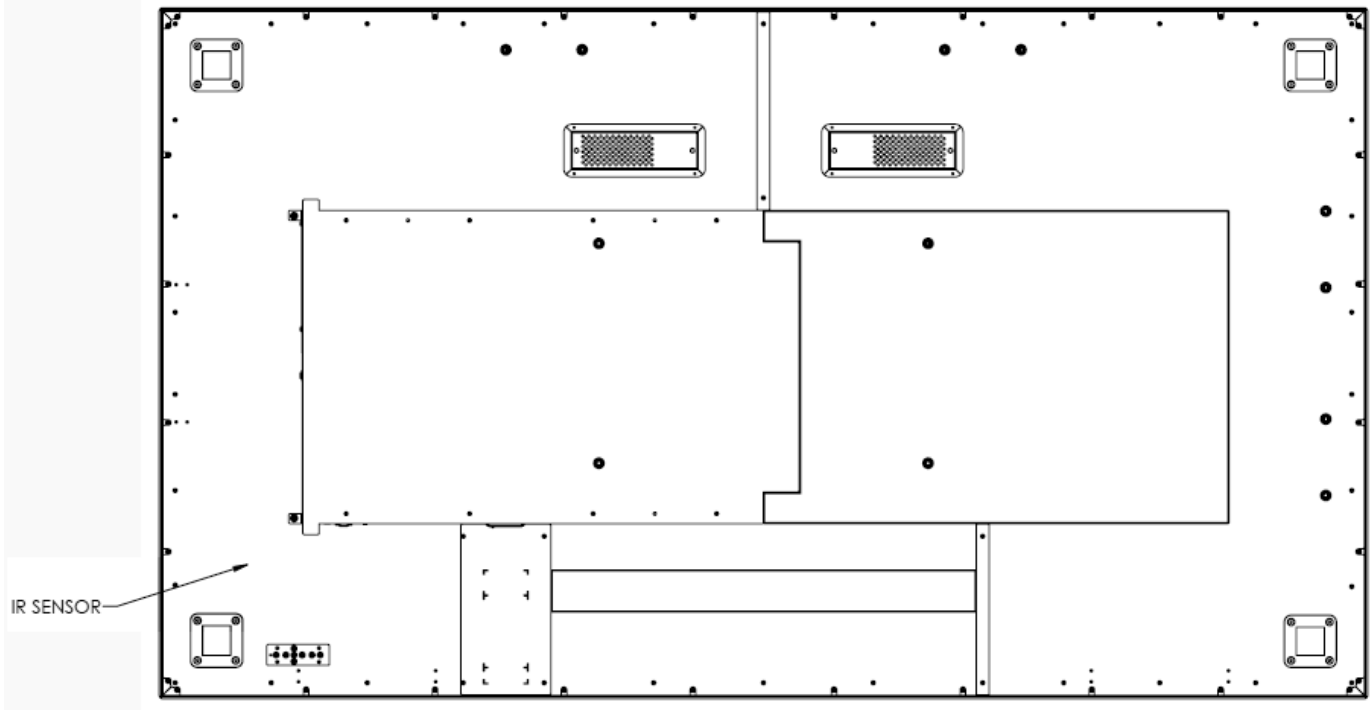

## LED Indicators

The LED indicator light is located on the rear of the display near the keypad. The following table explains what the different colors and blink patterns mean.

**LED On**

Power Status	Condition
Green	Standby mode
Amber	Full power mode
Green Flashing (1 Hz)	AC power on
Green Flashing (0.5 Hz)	Powering on from standby
Green Flashing (5 Hz)	Firmware updating
Amber Flashing (5 Hz)	Power supply failure
Green and Amber	Firmware update failure

## Using the Display in Portrait Mode

When using the display in the portrait position and looking at the rear of the display, it should be rotated according to the arrow stickers on the back of the display. This will allow for proper ventilation. Then select the OSD rotation of landscape or portrait on the OSD menu (MAIN MENU > ADVANCED SETTINGS > MENUS AND MESSAGES > OSD ROTATION).

**Caution:** Improper ventilation may shorten the life of the display.

## Using the Display in Flat or Tilted Orientation

The display is not recommended for use in flat orientation for tabletop, floor, or ceiling installations. LCD panels of this size are at risk of panel deflection, which can cause cosmetic sagging, brightness uniformity issues, a shortened life span, and malfunction of optional touch sensors. Installations where the display is tilted downward or upward at an angle may also be prone to these issues and are not recommended.

## Using the Remote Control

Below is a picture of the remote control. See the following page for button descriptions and Hex codes.



## IR Command Protocol

The Planar UltraRes displays accept commands in the form of IR signals that conform to the NEC protocol. Each Planar UltraRes remote control has an NEC control code associated with it. You can use these codes to program a third-party “universal” remote control to work with the Planar UltraRes displays. These third-party products usually come with a computer software application for this purpose. For more information, consult the documentation provided with the remote control.

The IR control codes have the following characteristics:

- Each code consists of the following:
  - A leader pulse (a modulated pulse of 9 ms followed by a non-modulated pulse of 4.5 ms)
  - 16 address bits. The default address is 1785 (0x06F9, binary 00000110 11111001)
  - 16 data bits: eight (8) bits for the command followed by the logical inverse of the command
  - An end pulse (a modulated pulse of 0.56 ms, similar to the modulated pulse in the ‘0’ and ‘1’ bits). The end of the modulated pulse constitutes the end of the data transmission.
- The carrier frequency is 38 kHz, with the modulated pulses having a 33% duty cycle.
- Commands are sent at a maximum rate of 9 Hz.

For example, below is the NEC control code for the ON button of the Planar UltraRes remote control (assuming the default address is used).

<b>Hex</b>	<b>06</b>	<b>F9</b>	<b>01</b>	<b>FE</b>
<b>Binary</b>	00000110	11111001	00000001	11111110
<b>Function</b>	<b>Address Byte 1</b>	<b>Address Byte 2</b>	<b>Command</b>	<b>Command (Logical Inverse)</b>

The following example shows the pulse train for this command.



Remote Control Button Name	Address	Data	NEC Data From Remote (Hex Code)	Description
ON	1785	1	0x06F901FE	Power on
OFF	1785	9	0x06F909F6	Power off
◀	1785	2	0x06F902FD	Not used
▶	1785	3	0x06F903FC	Not used
**	1785	6	0x06F906F9	Not used
PRESETS	1785	4	0x06F904FB	Opens the Presets menu
PRESET 1	1785	5	0x06F905FA	Applies Preset 1
PRESET 2	1785	7	0x06F907F8	Applies Preset 2
PRESET 3	1785	8	0x06F908F7	Applies Preset 3
PRESET 4	1785	10	0x06F90AF5	Applies Preset 4
1	1785	12	0x06F90CF3	Number button 1
2	1785	13	0x06F90DF2	Number button 2
3	1785	14	0x06F90EF1	Number button 3
4	1785	15	0x06F90FF0	Number button 4
5	1785	16	0x06F910EF	Number button 5
6	1785	17	0x06F911EE	Number button 6
7	1785	20	0x06F914EB	Number button 7
8	1785	25	0x06F919E6	Number button 8
9	1785	27	0x06F91BE4	Number button 9
0	1785	18	0x06F912ED	Number button 0
VOL +	1785	28	0x06F91CE3	Volume increase
VOL -	1785	33	0x06F921DE	Volume decrease
MUTE	1785	32	0x06F920DF	Audio mute
COLOR	1785	19	0x06F913EC	Not used
VIDEO WALL	1785	34	0x06F922DD	Opens the Tiling menu
MISC	1785	11	0x06F90BF4	Opens the Image Information menu
MENU	1785	21	0x06F915EA	Opens the menu
PREV	1785	22	0x06F916E9	Returns to the previous menu
ENTER	1785	23	0x06F917E8	Selects the current menu item
UP	1785	26	0x06F91AE5	Navigate up
DOWN	1785	29	0x06F91DE2	Navigate left
LEFT	1785	31	0x06F91FE0	Navigate right
RIGHT	1785	24	0x06F918E7	Navigate down

Remote Control Button Name	Address	Data	NEC Data From Remote (Hex Code)	Description
TOP	1785	30	0x06F91EE1	Selects the top line in the current menu
ZONE 1	1785	35	0x06F923DC	Selects the input for Zone 1
ZONE 2	1785	36	0x06F924DB	Selects the input for Zone 2
ZONE 3	1785	38	0x06F926D9	Selects the input for Zone 3
ZONE 4	1785	39	0x06F927D8	Selects the input for Zone 4
PIP MODE	1785	37	0x06F925DA	Selects the Multi-Source View setting
PIP SWAP	1785	40	0x06F928D7	Swaps the main and PIP windows
HDMI 1	1785	41	0x06F929D6	Selects HDMI 1 for the current zone
HDMI 2	1785	42	0x06F92AD5	Selects HDMI 2 for the current zone
HDMI 3	1785	43	0x06F92BD4	Selects HDMI 3 for the current zone
HDMI 4	1785	44	0x06F92CD3	Selects HDMI 4 for the current zone
DP	1785	45	0x06F92DD2	Selects DP for the current zone
DVI	1785	46	0x06F92ED1	Not used
VGA	1785	47	0x06F92FD0	Not used
OPS	1785	48	0x06F930CF	Selects OPS for the current zone

## Locking the Keypad and IR Remote

You can lock the keypad and IR remote functionality on the display. To lock the keypad, go to Main Menu -> Advanced Settings -> System Settings and select Keypad Lock. To lock the IR remote, go to Main Menu -> Advanced Settings -> System Settings and select IR Remote Lock.

## Unlocking the Keypad and IR Remote

To unlock the keypad, press the following keys on the keypad in the order listed: UP, UP, RIGHT, LEFT, DOWN. If the IR remote is unlocked, you can also unlock the keypad by using the IR remote to go to Main Menu -> Advanced Settings -> System Settings and uncheck Keypad Lock.

To unlock the IR remote, press the following keys on the IR remote in the order listed: UP, UP, RIGHT, LEFT, DOWN. If the keypad is unlocked, you can also unlock the IR remote by using the keypad to go to Main Menu -> Advanced Settings -> System Settings and uncheck IR Remote Lock.

## Changing the IR Remote Code Set

The IR remote code set transmitted by the remote and accepted by the display can be configured. This is useful if there are multiple Planar displays and you would like each remote to work only with one of the displays. It can also be used if IR interference with another device, such as a DVD player, is occurring.

To change the IR code on the remote, use the following procedure:

- 1 Press and hold the CODE button on the remote control until the LED on the remote lights solid red (approximately five seconds).
- 2 Enter a new five-digit code between 00000 and 65535. Include leading zeros for codes with four or fewer digits; for example, enter 255 as 00255.
- 3 The LED turns off to confirm the code change. If you enter an invalid code, the LED flashes for three or four seconds. Try again, entering a valid code.

**Note:** The code must match the IR Remote ID Code setting. See page 64.

## Turning the Display On

- 1 Insert the power cord into the display and into the power outlet.
- 2 Ensure the AC switch is set to “—”.
- 3 Press the ON button on the remote or the power button on the keypad.

## Turning the Display Off

With the power on, press the OFF button on the remote or the power button on the keypad to put the LCD panel in a standby mode. To turn off power completely, turn the AC switch to “O” or disconnect the AC power cord from the power outlet.

**Note:** The display may automatically turn off the backlight or enter standby mode if no signal is present for a certain period of time. See the description of the Power Saving Mode setting on page 46 for more information.

## Adjusting the Volume

- 1 Using the remote, press the VOL + or VOL - to increase or decrease the volume. You can also use the Up and Down keys on the remote and keypad to increase or decrease the volume.
- 2 Press the MUTE button to temporarily turn off all sound. To restore the sound, press the MUTE button again.

**Note:** The analog audio out is variable. S/PDIF is fixed.

## Selecting Layouts and Input Sources

With Planar MediaPlex Plus Processing, you can show one source at a time or multiple sources simultaneously. Multiple layout options are available and can be selected from the Inputs and Views Menu (see page 36). Once a layout has been designated, you can assign sources to each of the zones in the layout. The selection of sources must be made one at a time by assigning a current zone. To select the current zone, you can navigate through the on-screen menu (see page 36). Alternatively, you can use the remote or keypad as described next.

### Remote

Press the Zone 1, Zone 2, Zone 3, or Zone 4 buttons on the remote. After selecting the desired zone, you can press the source button (DP, HDMI 1, HDMI 2, HDMI 3, HDMI 4, or OPS). This action will also select the active audio source.

For example, to change Zone 3 to OPS, press the Zone 3 button and then press the OPS button.

### Keypad

Press the SRC button. The input source will be toggled in the following order: HDMI 1, HDMI 2, HDMI 3, HDMI 4, DP, OPS).

**Note:** Sources will toggle through the current zone, or last zone to be modified. Current zones can only be re-assigned in the on-screen menu.



## Navigating Through the Menu

- 1 With the power on, press MENU. The MAIN menu appears.



- 2 Within the menu, use ▲, ▼, ◀, ▶ and ENTER to navigate through the menus and adjust options.
- 3 Press PREV on the remote control, or MENU on the keypad, to return to the previous menu. To exit the menu system, press MENU on the remote control, or continue to press MENU on the keypad until the main menu is reached.

## Inputs and Views Menu

This menu shows how the sources will be laid out on the screen based on the current Multi-Source View and Advanced Layouts selections.

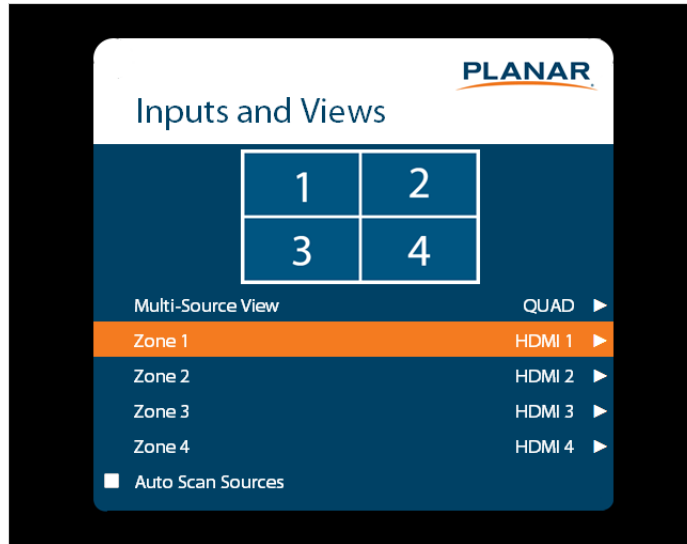

### Multi-Source View

Select the Multi-Source View mode

**Options:** Single, Dual, Triple, Quad, PIP; **Default:** Single

**Note:** For the Advanced Layouts submenu, refer to page 37.

**Note:** You can only use 4K/60Hz in Single mode.

### Zone 1

Select the source displayed in Zone 1

**Options:** HDMI 1, HDMI 2, HDMI 3, HDMI 4, DP, OPS; **Default:** HDMI 1

**Note:** If HDMI1 was selected as another source, OPS cannot be selected. If OPS was selected as another source, HDMI1 cannot be selected.

### Zone 2

Select the source displayed in Zone 2

**Options:** HDMI 1, HDMI 2, HDMI 3, HDMI 4, DP, OPS; **Default:** HDMI 2

**Note:** If HDMI1 was selected as another source, OPS cannot be selected. If OPS was selected as another source, HDMI1 cannot be selected.

### Zone 3

Select the source displayed in Zone 3

**Options:** HDMI 1, HDMI 2, HDMI 3, HDMI 4, DP, OPS; **Default:** HDMI 3

**Note:** If HDMI1 was selected as another source, OPS cannot be selected. If OPS was selected as another source, HDMI1 cannot be selected.

### Zone 4

Select the source displayed in Zone 4

**Options:** HDMI 1, HDMI 2, HDMI 3, HDMI 4, DP, OPS; **Default:** HDMI 4

**Note:** If HDMI1 was selected as another source, OPS cannot be selected. If OPS was selected as another source, HDMI1 cannot be selected.

### Auto Scan Sources

Select whether the display will automatically scan for a valid source on any zone that currently does not have a source

**Options:** On, Off; **Default:** Off

### Advanced Layouts Submenu

This submenu defines the layouts for each multi-source view type.

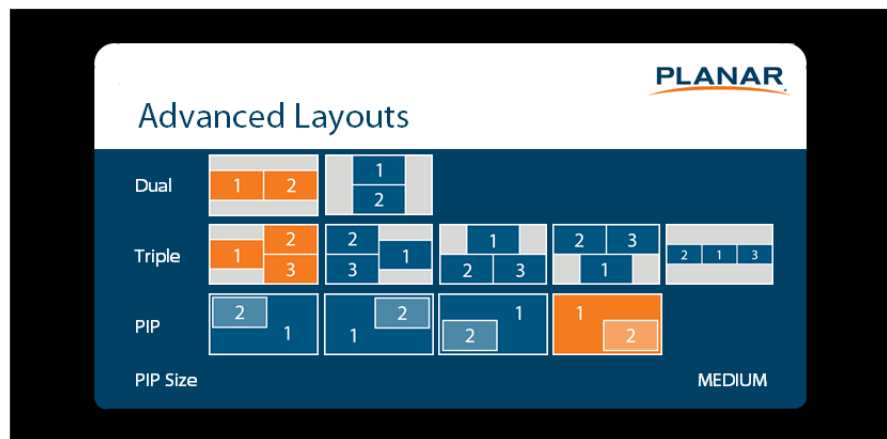

### Dual

Select from two dual source layout options. The layout in orange will be the active layout displayed when the Multi-Source View is set to Dual.

### Triple

Select from five triple source layout options. The layout in orange will be the active layout displayed when the Multi-Source View is set to Triple.

**PIP**

Select from four PiP (Picture-in-Picture) layouts. The layout in orange will be the active layout displayed when the Multi-Source View is set to PiP.

**PIP Size**

Select the size of the PiP (Picture-in-Picture) window.

## Image Adjust Menu

This menu is used for making common image adjustments for the current zone.

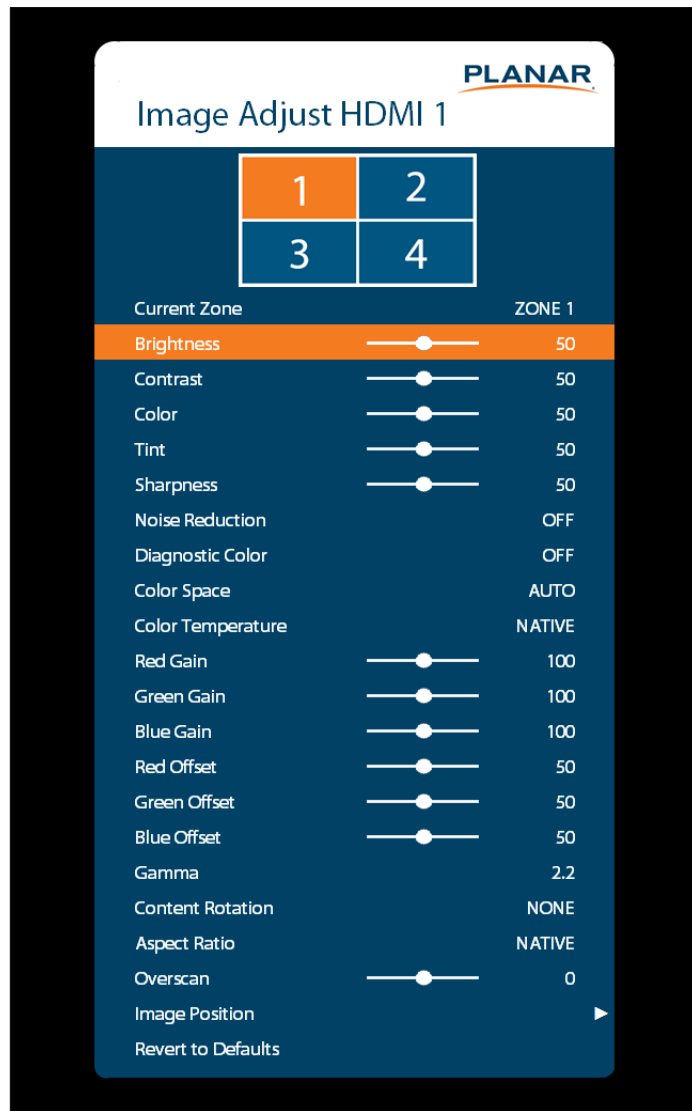

### Current Zone

The zone that is currently being adjusted. All of the settings in this menu are saved per input. The zone's corresponding input source is shown in the title bar, and the graphic beneath that shows which zone is being adjusted in the current Multi-Source View mode and Advanced Layout setting (if applicable).

The current zone can be changed via the menu or by using the ZONE 1-4 keys on the remote control.

**Note:** Changing the Current Zone setting via the ZONE 1-4 keys also changes the Audio Select setting.

### Brightness

Adjust the brightness value of the image  
**Range:** 0~100; **Default:** 50

### Contrast

Adjust the contrast of the image  
**Range:** 0~100; **Default:** 50

### Color

Adjust the saturation of the image  
**Range:** 0~100; **Default:** 50

### Tint

Adjust the hue of the image  
**Range:** 0~100; **Default:** 50

### Sharpness

Adjust the sharpness of the image. Higher numbers are sharper  
**Range:** 0~10; **Default:** 5

### Noise Reduction

Turn on noise reduction processing  
**Options:** Off, Low, Medium, High; **Default:** Off

### Diagnostic Color

Set the image to monochrome. This setting is for use in adjustments to a test pattern and is not stored.  
**Options:** Off, Red, Green, Blue; **Default:** Off

### Color Space

Set the color space of the image  
**Options:** REC601, REC709, RGB, RGB Video, Auto; **Default:** Auto

### Color Temperature

Set the color temperature of the image  
**Options:** 3200K, 5500K, 6500K, 7500K, 9300K, Native; **Default:** Native

### Red Gain

Adjust the red gain of the image  
**Range:** 0~200; **Default:** 100

### Green Gain

Adjust the green gain of the image  
**Range:** 0~200; **Default:** 100

**Blue Gain**

Adjust the blue gain of the image  
**Range:** 0~200; **Default:** 100

**Red Offset**

Adjust the red offset of the image  
**Range:** 0~100; **Default:** 50

**Green Offset**

Adjust the green offset of the image  
**Range:** 0~100; **Default:** 50

**Blue Offset**

Adjust the blue offset of the image  
**Range:** 0~100; **Default:** 50

**Gamma**

Set the gamma of the image  
**Options:** 1.5, 1.55, 1.6, 1.65, 1.7, 1.75, 1.8, 1.85, 1.9, 1.95, 2.0, 2.05, 2.1, 2.15, 2.2, 2.25, 2.3, 2.35, 2.4, 2.45, 2.5, 2.55, 2.6, 2.65, 2.7, 2.75, 2.8  
**Default:** 2.2

**Content Rotation**

Rotate the image on the display  
**Options:** None, 90, 180, 270; **Default:** None

**Aspect Ratio**

Set how the source is treated when the aspect ratio of the input is different than the aspect ratio of the zone it is in. If the image does not fill the zone completely, the extra margins are black.  
**Options:** Auto, 16:9, 4:3, Fill Screen, Native, Letterbox; **Default:** Auto

**Overscan**

Set the percentage of the image to remove from each edge  
**Range:** 0~20; **Default:** 0

**Image Position**

Move the image horizontally or vertically. The amount to move is measured in input pixels.  
**Range:** -1000~1000; **Default:** 0

**Revert to Defaults**

Reset all settings in the Image Adjust menu to their factory defaults for the current zone only

## Audio Menu

This menu enables you to make audio adjustments to the selected zone.

**Note:** Volume, Bass, Treble and Balance do not apply to the S/PDIF output.



### Audio Select

The zone that is currently being adjusted and whose audio is being played. The zone's corresponding input source is shown in the title bar.

**Options:** Zone 1, Zone 2, Zone 3, Zone 4; **Default:** Zone 1

**Note:** Changing the Audio Select setting via the ZONE 1-4 keys also changes the Current Zone setting.

### Volume

Set the volume of the audio

**Range:** 0~100; **Default:** 50

### Bass

Set the bass level

**Range:** 0~100; **Default:** 50

**Note:** This setting applies only to the internal speakers, and cannot be adjusted for the Line Out connector.

### Treble

Set the treble level

**Range:** 0~100; **Default:** 50

**Note:** This setting applies only to the internal speakers, and cannot be adjusted for the Line Out connector.



**Balance**

Set the audio balance

**Range:** 0~100; **Default:** 50

**Enable Internal  
Speakers**

Disable or enable the built-in speakers

**Options:** On, Off; **Default:** On

**Mute**

Mute or unmute the audio

**Options:** On or Off; **Default:** Off

## Presets Menu

This menu enables you to save Inputs and Views settings, Image Adjust settings, Audio settings, the Backlight Intensity setting, the Local Dimming setting, and Tiling settings. You can save up to 10 presets using this menu (more can be saved via the serial command interface). If a preset is saved, it will appear as "Preset 1", "Preset 2", and so on. If it is not saved, it will appear as "<Empty>".

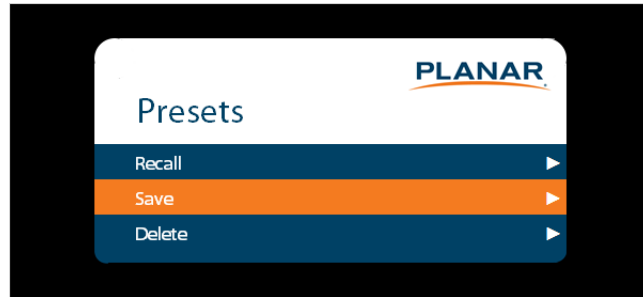

### Recall

Apply the setup from the selected preset  
**Range:** Preset 1~Preset 10

### Save

Save the current setup for later recall  
**Range:** Preset 1~Preset 10

### Delete

Delete the selected preset  
**Range:** Preset 1~Preset 10

## Advanced Settings Menu

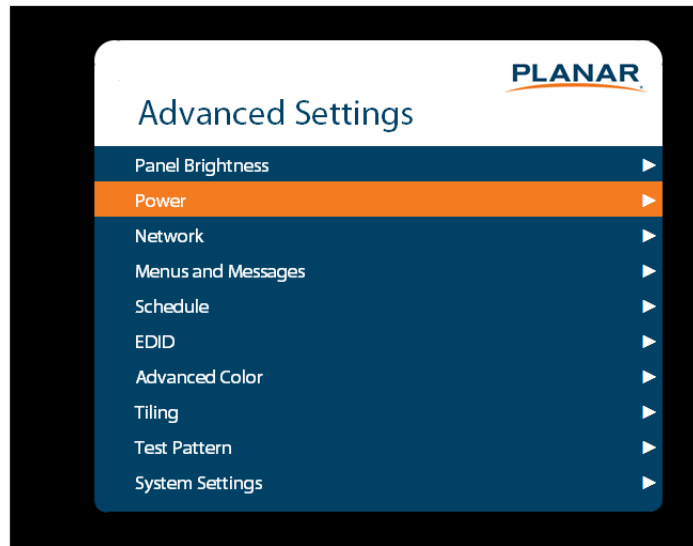

### Panel Brightness Submenu



#### Intensity

Set the intensity of the LCD backlight  
**Range:** 0~100; **Default:** 75

#### Local Dimming

Turn on or off the local dimming function, if supported by the display  
**Options:** On, Off; **Default:** On

## Power Submenu

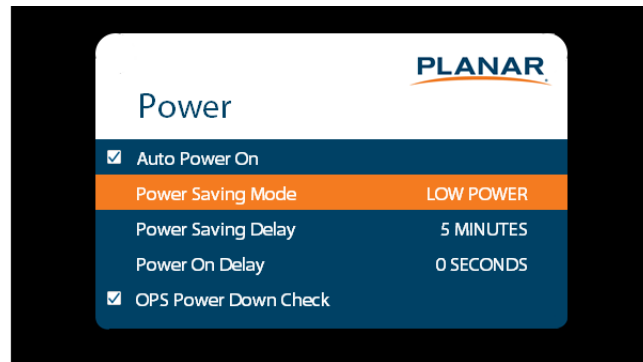
**Auto Power On**

Set whether the system will automatically leave standby mode after AC power is applied  
**Options:** On, Off; **Default:** Off

**Power Saving Mode**

Set the action to take if there is no signal detected after the period of time selected by the Power Saving Delay setting:

- **Disabled:** The display will remain on even if no signal is present.
- **Low Power:** The display will enter standby mode if no signal is detected after the specified period of time.
- **Wake on Signal:** The display will enter a reduced power mode if no signal is detected after the specified period of time. When in this state, the display will turn on when a signal is detected or when any key is pressed on the keypad or IR remote.

**Power Saving Delay**

Set the number of minutes to delay before initiating the power saving mode action (if any)

**Options:** 1 Minute, 5 Minutes, 15 Minutes, 30 Minutes, 60 Minutes; **Default:** 5 minutes

**Power On Delay**

Select the amount of time to delay before turning on the display. Depending on the electrical capabilities at the installation site, it can be necessary to adjust the power on sequence of the displays if there are multiple displays in the installation. Use this control to ensure that each display will power on at a different time, avoiding such problems.

**Options:** 0-10 seconds, in 0.1 second increments; **Default:** 0 seconds

**OPS Power Down Check**

When this is enabled, the system will wait for a signal from the OPS module indicating it has finished its power down sequence before going into standby

**Options:** Disable, Enable; **Default:** Enable

## Network Submenu

The default static IP values are:

- IP Address: 192.168.12.12
- Subnet Mask: 255.255.255.0
- Default Gateway: 192.168.12.1

The static IP settings that you program will be used if a DHCP server cannot be found.

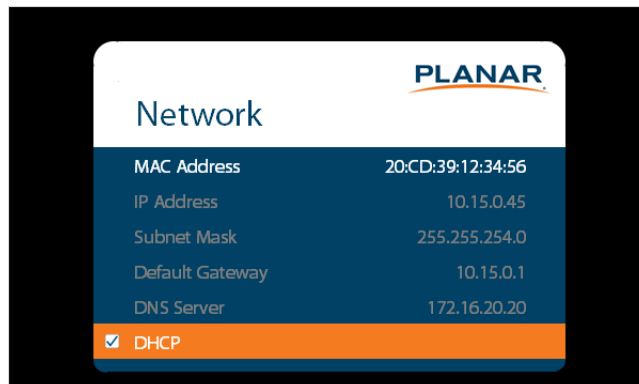

### MAC Address

The MAC address of the system

### IP Address

The current network address. You can use the number keys on the remote to enter this information.

### Subnet Mask

The current subnet mask. You can use the number keys on the remote to enter this information.

### Default Gateway

The current default gateway. You can use the number keys on the remote to enter this information.

### DNS Server

The current DNS server. You can use the number keys on the remote to enter this information.

**Note:** The specified DNS server is used when Use Network Time is checked for the Set Date and Time setting.

### DHCP

Turn DHCP on or off

**Options:** On, Off; **Default:** On

## Menus and Messages Submenu

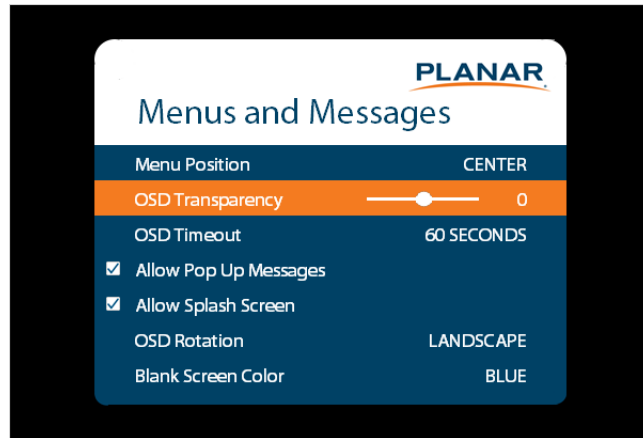
**Menu Position**

Move the OSD menu to a different location on the screen

**Options:** Center, Upper Left, Upper Right, Lower Left, Lower Right; **Default:** Center

**OSD Transparency**

Set the transparency of the OSD so that the image behind it can be seen. Higher values mean greater transparency.

**Range:** 0~5; **Default:** 0

**OSD Timeout**

Set the amount of time in seconds since the last keypress before the OSD menu automatically closes. If set to Off, the menu never automatically closes.

**Options:** Off, 10 Seconds, 30 Seconds, 60 Seconds, 120 Seconds, 240 Seconds; **Default:** 60 Seconds

**Allow Pop Up Messages**

Suppress messages that pop up automatically. When set to No, the source status message and the volume slider bar will not be displayed.

**Options:** Yes or No; **Default:** Yes

**Allow Splash Screen**

Enable or disable the splash screen during startup

**Options:** Enable or Disable; **Default:** Enable

**OSD Rotation**

Rotate the OSD menu so that it is readable if the display is mounted in portrait orientation

**Options:** Landscape or Portrait; **Default:** Landscape

## Blank Screen Color

Select the color to display when there is no signal in a zone

**Options:** Black, White, Gray, Red, Green, Blue, Cyan, Magenta, Yellow

**Default:** Black

## Schedule Submenu

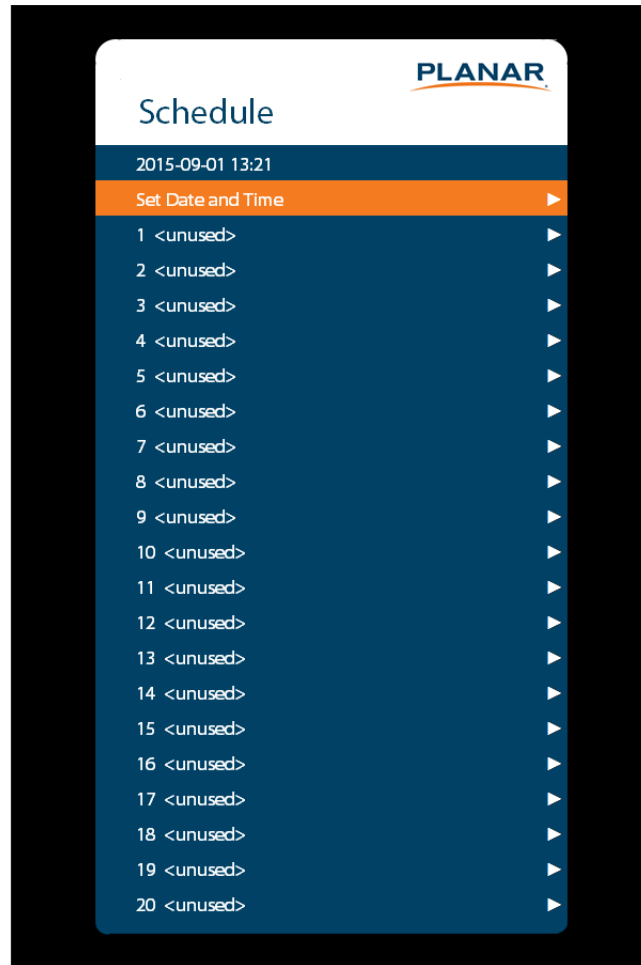

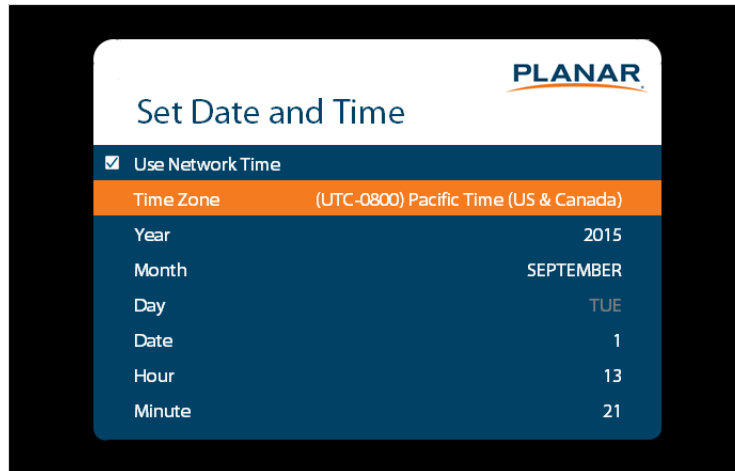

## Set Date and Time

Set the internal system clock. If **Use Network Time** is unchecked, you can set the following settings individually: Time Zone, Year, Month, Day, Date, Hour, and Minute.

**Note:** If Use Network Time is checked and DHCP is unchecked, the display will be unable to obtain the network time unless a DNS server is programmed. This is done via the DNS Server setting in the Network menu or the serial command interface.

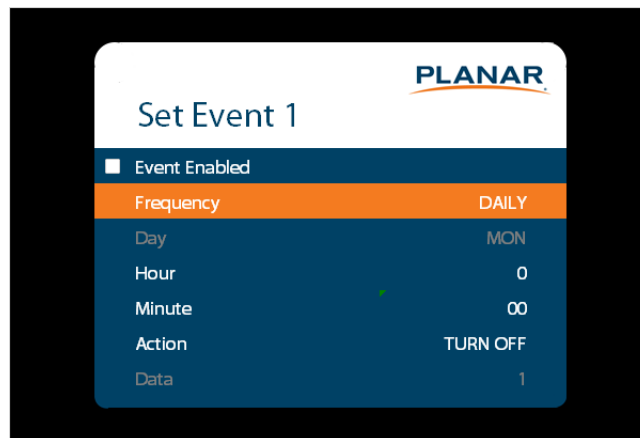

## Set Event 1~Event 20

**Event Enabled:** Turns on the event. If disabled, the settings are saved so that the event can be re-enabled.

**Frequency:** The frequency of the event. Options are Daily, Weekly, Weekdays, Weekends.

**Action:** The action to take for the event. Options are Turn On, Turn Off, Recall, Panel Brightness.

**Data:** The preset to recall when the Action is set to Recall, or the backlight setting when the Action is set to Panel Brightness.



## EDID Submenu

This menu specifies the EDID format and preferred timing for the selected connector.

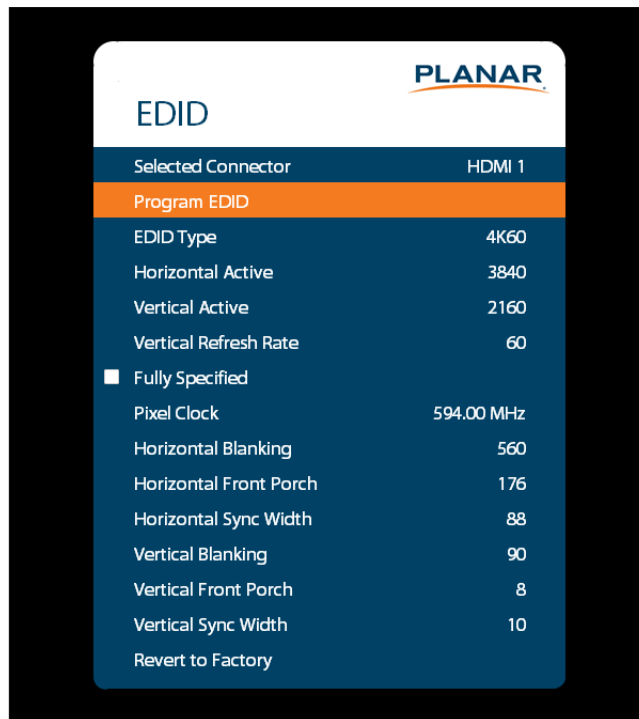

### Selected Connector

Set which connector is used

**Options:** HDMI 1, HDMI 2, HDMI 3, HDMI 4, DP, OPS, All

### Program EDID

Program the EDID information for the selected connector based on the selections in the EDID submenu

### EDID Type

Set the EDID type to determine the base EDID used for the current connector:

- 4K60 selects an EDID format compliant with HDMI 2.0 and DP 1.2
- 4K30 selects an EDID format compliant with HDMI 1.4b and DP 1.1
- 1080P selects an EDID format compliant with HDMI 1.3 and DP 1.1

**Options:** 4K60, 4K30, 1080P

### Horizontal Active

The number of active pixels in a line

**Range:** 0~4095

### Vertical Active

The number of active lines in a field  
**Range:** 0~4095

### Vertical Refresh Rate

The number of fields per second rounded to the nearest Hz  
**Range:** 0~120

### Fully Specified

Determine how the final detailed timing is calculated. If disabled, it is calculated based on Horizontal Active, Vertical Active, and Vertical Refresh Rate values. If enabled, it is calculated based on all of the EDID values except for Vertical Refresh Rate.

**Options:** Disabled, Enabled

**Note:** This setting should only be enabled by advanced users.

### Pixel Clock

The value of the pixel clock, in megahertz  
**Range:** 0~600.00, in 0.01 increments

### Horizontal Blanking

The number of non-active pixel clocks in a line  
**Range:** 0~1023

### Horizontal Front Porch

The number of pixel clocks in the horizontal front porch  
**Range:** 0~1023

### Horizontal Sync Width

The number of pixel clocks in the horizontal sync pulse  
**Range:** 0~255

### Vertical Blanking

The number of non-active lines in a field  
**Range:** 0~255

### Vertical Front Porch

The number of line times in the vertical front porch  
**Range:** 0~255

### Vertical Sync Width

The number of line times in the vertical sync  
**Range:** 0~255

## Revert to Factory

Reset the EDID type and timings to the default values for the selected connector

### Advanced Color Submenu

This menu adjusts the color coordinates of the current zone. These controls are used by advanced installers to achieve exact color point targets on the display. In some cases, the target color coordinates may not be achievable. In this case, an asterisk (\*) will appear next to the color coordinate value.

**Note:** The white color point should be adjusted before adjusting the other color points.

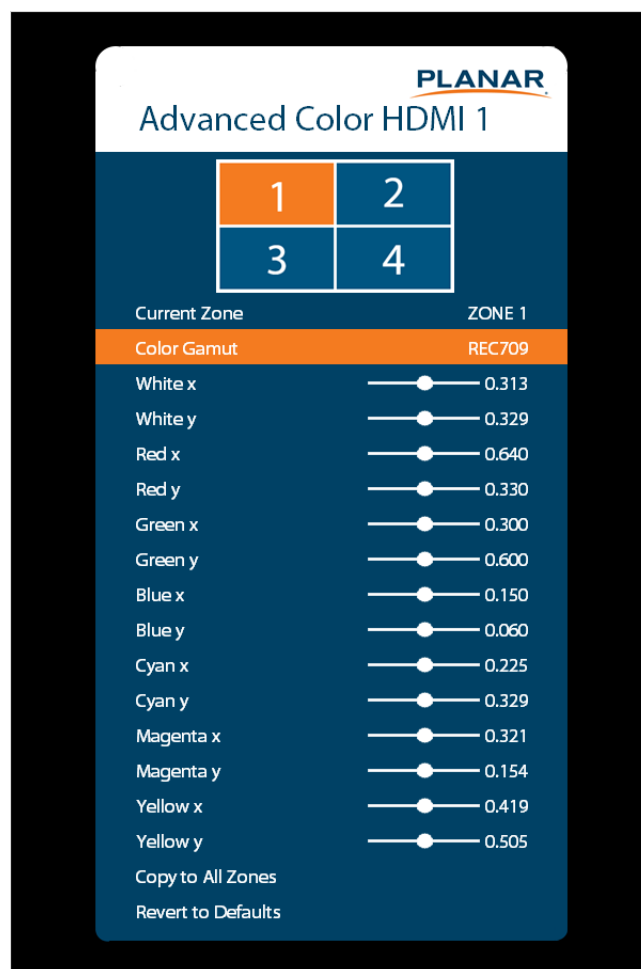

### Current Zone

The zone that is currently being adjusted. All of the settings in this menu are saved per zone, and all color coordinate values are also saved per Color Gamut setting. The zone's corresponding input source is shown in the title bar, and the graphic beneath that shows which zone is being adjusted in the current Multi-Source View mode and Advanced Layout setting (if applicable).

The current zone can be changed via the menu or by using the ZONE 1-4 keys on the remote control.

**Note:** Changing the Current Zone setting via the ZONE 1-4 keys also changes the Audio Select setting.

### White x

Adjust the x coordinate of the white color point  
**Range:** 0.000-0.800

### White y

Adjust the y coordinate of the white color point  
**Range:** 0.000-0.800

### Red x

Adjust the x coordinate of the red color point  
**Range:** 0.000-0.800

### Red y

Adjust the y coordinate of the red color point  
**Range:** 0.000-0.800

### Green x

Adjust the x coordinate of the green color point  
**Range:** 0.000-0.800

### Green y

Adjust the y coordinate of the green color point  
**Range:** 0.000-0.800

### Blue x

Adjust the x coordinate of the blue color point  
**Range:** 0.000-0.800

### Blue y

Adjust the y coordinate of the blue color point  
**Range:** 0.000-0.800

**Cyan x**

Adjust the x coordinate of the cyan color point  
**Range:** 0.000-0.800

**Cyan y**

Adjust the y coordinate of the cyan color point  
**Range:** 0.000-0.800

**Magenta x**

Adjust the x coordinate of the magenta color point  
**Range:** 0.000-0.800

**Magenta y**

Adjust the y coordinate of the magenta color point  
**Range:** 0.000-0.800

**Yellow x**

Adjust the x coordinate of the yellow color point  
**Range:** 0.000-0.800

**Yellow y**

Adjust the y coordinate of the yellow color point  
**Range:** 0.000-0.800

**Copy to All Zones**

Copy the color coordinate settings for the current zone and the current Color Gamut setting to all other zones

**Revert to Defaults**

Reset the color coordinate settings for the current zone and the current Color Gamut setting to their default values

## Tiling Submenu

This menu contains controls for using multiple UltraRes displays in a tiled configuration. This is useful when trying to display one image across multiple displays. In addition to setting up the width and height of the tiled wall, each display must have its position within the tiled wall properly selected. Refer to the diagrams below for example setting values in a 3 x 4 tiled wall.

**Note:** When using the Content Rotation feature, the Tiling settings must be adjusted differently in order to display the image properly. Refer to the examples below.

**Example 1:** 0 Degree Rotation, Wall Width = 3, Wall Height = 4

Unit Row 1 Unit Column 1	Unit Row 1 Unit Column 2	Unit Row 1 Unit Column 3
Unit Row 2 Unit Column 1	Unit Row 2 Unit Column 2	Unit Row 2 Unit Column 3
Unit Row 3 Unit Column 1	Unit Row 3 Unit Column 2	Unit Row 3 Unit Column 3
Unit Row 4 Unit Column 1	Unit Row 4 Unit Column 2	Unit Row 4 Unit Column 3



**Example 2:** 180 Degree Rotation, Wall Width = 3, Wall Height = 4

Unit Row 4 Unit Column 3	Unit Row 4 Unit Column 2	Unit Row 4 Unit Column 1
Unit Row 3 Unit Column 3	Unit Row 3 Unit Column 2	Unit Row 3 Unit Column 1
Unit Row 2 Unit Column 3	Unit Row 2 Unit Column 2	Unit Row 2 Unit Column 1
Unit Row 1 Unit Column 3	Unit Row 1 Unit Column 2	Unit Row 1 Unit Column 1



**Example 3:** 90 Degree Rotation, Wall Width = 4, Wall Height = 3

Unit Row 3 Unit Column 1	Unit Row 2 Unit Column 1	Unit Row 1 Unit Column 1
Unit Row 3 Unit Column 2	Unit Row 2 Unit Column 2	Unit Row 1 Unit Column 2
Unit Row 3 Unit Column 3	Unit Row 2 Unit Column 3	Unit Row 1 Unit Column 3
Unit Row 3 Unit Column 4	Unit Row 2 Unit Column 4	Unit Row 1 Unit Column 4





**Example 4:** 270 Degree Rotation, Wall Width = 4, Wall Height = 3

Unit Row 1 Unit Column 4	Unit Row 2 Unit Column 4	Unit Row 3 Unit Column 4
Unit Row 1 Unit Column 3	Unit Row 2 Unit Column 3	Unit Row 3 Unit Column 3
Unit Row 1 Unit Column 2	Unit Row 2 Unit Column 2	Unit Row 3 Unit Column 2
Unit Row 1 Unit Column 1	Unit Row 2 Unit Column 1	Unit Row 3 Unit Column 1





### Tiling Enabled

When enabled, the tiling parameters in the menu are used  
**Options:** Disable, Enable; **Default:** Disable

### Wall Width, Wall Height

Select the width and height of the tiled wall  
**Default:** Width=1, Height=1

### Unit Column, Unit Row

Selects the location of the current display within the tiled wall  
**Default:** Column=1, Row=1

### Frame Compensation

When enabled, the image is scaled to compensate for the width of the display's bezel, using the Frame Width and Frame Height parameters. See "Frame Compensation Examples" on page 61.  
**Options:** Disable, Enable; **Default:** Disable

### Frame Width, Frame Height

Selects how many lines/pixels are removed from the image to compensate for the display's bezel

### Frame Compensation Examples

Below are examples with the Frame Compensation feature enabled (left) and disabled (right). Note that the eagle's eye is noticeably different when Frame Compensation is disabled.

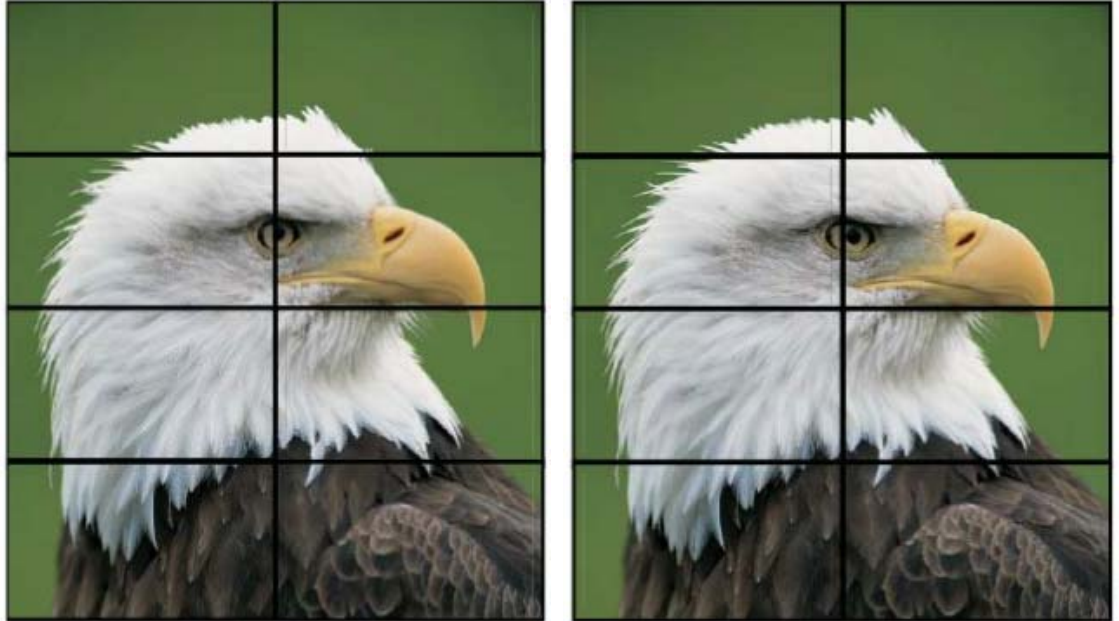

### Test Patterns Submenu

This menu selects a test pattern to show on the display for diagnostic purposes.

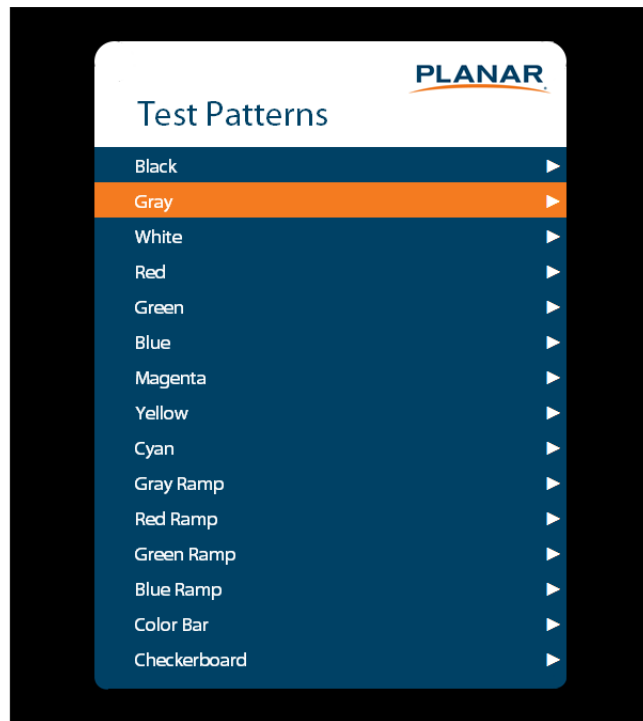

### Test Patterns

**Options:** Black, Gray, White, Red, Green, Blue, Magenta, Yellow, Cyan, Gray Ramp, Red Ramp, Blue Ramp, Color Bar, Checkerboard

## System Settings Submenu

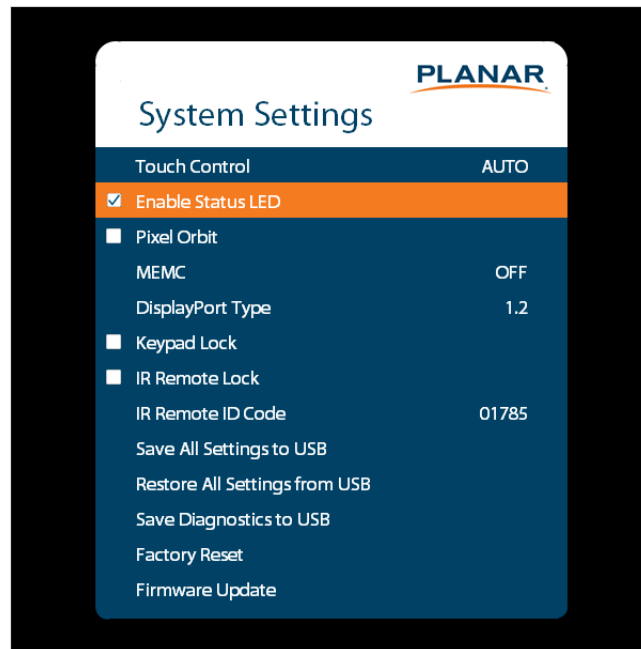

### Touch Control

Set where the USB commands from the touch panel is routed:

- OPS routes the touch USB commands to the OPS module
- External routes the touch USB command to the USB-B connector
- Auto routes the touch USB commands to the OPS module if the OPS source is selected; otherwise, they are connected to the USB-B connector

### Enable Status LED

When enabled, the status LEDs on the back of the display behave as indicated on page 28. When disabled, the status LEDs are always turned off.

**Options:** Disable, Enable; **Default:** Enable

### Pixel Orbit

Create slight frame motion to help avoid image retention

**Options:** Enable, Disable; **Default:** Disable

### MEMC

Enable motion estimation motion compensation (frame interpolation). This improves smoothness for fast motion video content.

**Options:** Off, Low, Medium, High; **Default:** Off

### DisplayPort Type

Set the version of DisplayPort that is used by the system

**Options:** 1.1, 1.2; **Default:** 1.2

### Keypad Lock

Lock or unlock the keypad. When it is enabled, all keypad presses will be ignored.

**Options:** Enable, Disable; **Default:** Disable

### IR Remote Lock

Lock or unlock the remote control. When it is enabled, all remote control presses will be ignored.

**Options:** Enable, Disable; **Default:** Disable

### IR Remote ID Code

Selects the IR remote code set accepted by the display

**Options:** 00000-65535; **Default:** 01785

### Save All Settings to USB

Save all settings in the display to a USB flash drive. The saved file will be named *Planar-settings.bin* and will be saved in the root folder of the USB flash drive.

**Note:** A USB flash drive must be inserted into the USB-A connector prior to using this feature. The USB flash drive must be formatted as FAT32. This feature will not work with the NTFS file system.

### Restore All Settings from USB

Restores all settings in the display from a USB flash drive. The settings file must be named *Planar-settings.bin* and must be located in the root folder of the USB flash drive.

**Note:** A USB flash drive must be inserted into the USB-A connector prior to using this feature. The USB flash drive must be formatted as FAT32. This feature will not work with the NTFS file system.

### Save Diagnostics to USB

Save a diagnostic report to a USB flash drive to help Planar Technical Support troubleshoot any issues. The saved file will be named *Planar-diagnostics.bin* and will be saved in the root folder of the USB flash drive.

**Note:** A USB flash drive must be inserted into the USB-A connector prior to using this feature. The USB flash drive must be formatted as FAT32. This feature will not work with the NTFS file system.

### Factory Reset

Return the saved settings in a system to their factory defaults

### Firmware Update

Update the firmware for the display. Refer to the instructions on the firmware release package for more information.

# Information Menu



## System Information Submenu

This menu displays version information for all programmable parts in the system. It also contains the model and serial number.

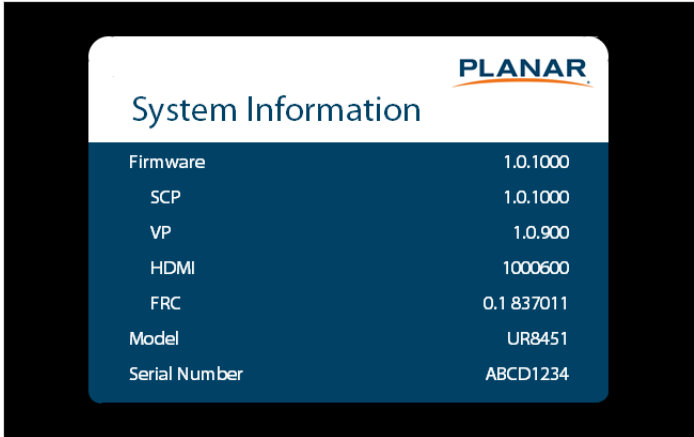

### Image Information Submenu

This menu displays image details for the current zone. If more than one zone is available, you can change zones by setting the **Current Zone** option.

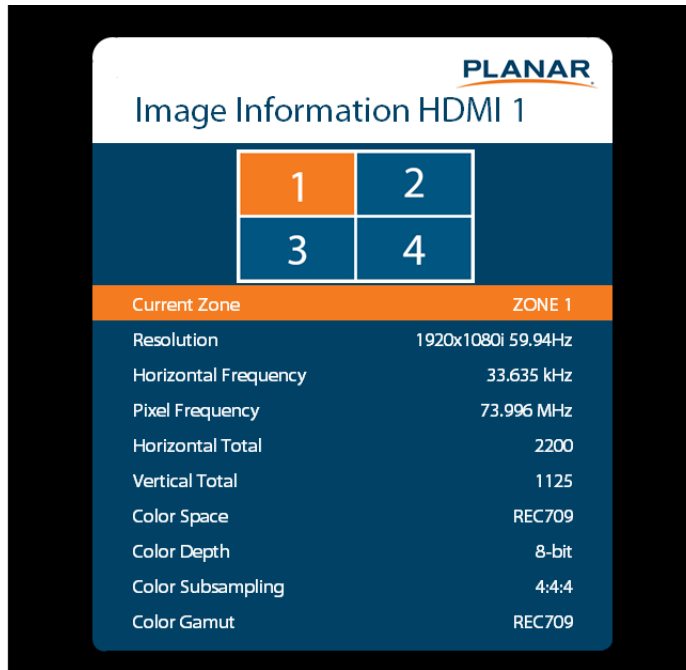



## Error Log Submenu

This menu displays a chronological list of system errors that have occurred. For a list of possible errors, see "Error Codes" on page 92.

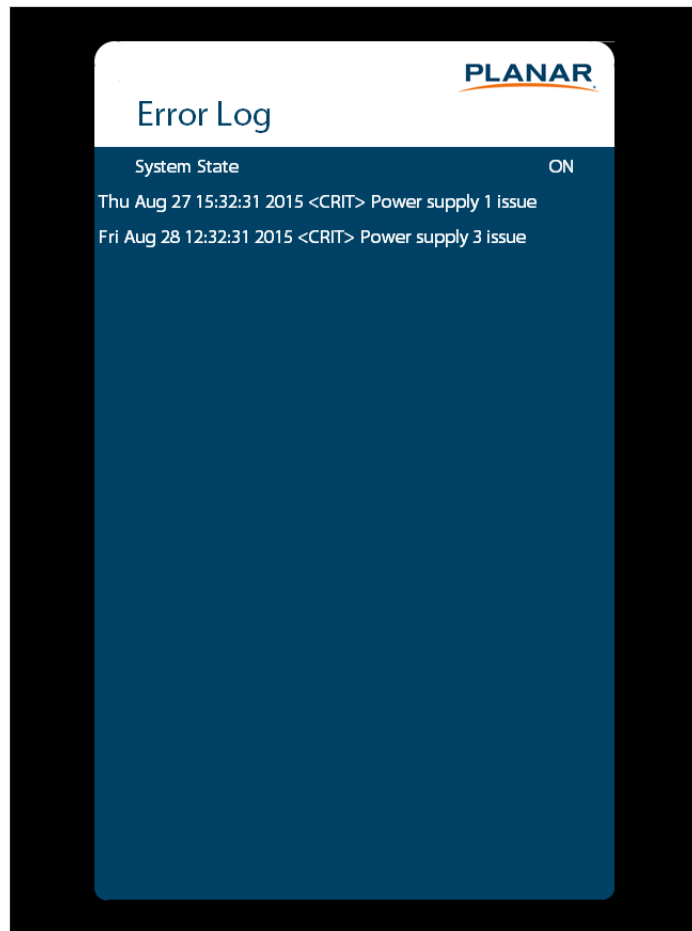

## Using the Touch Screen

You can use the touch screen to control your Windows, Mac, or Linux operating system. The Planar UltraRes Series is HID compliant, delivering up to 12 points of touch on both Windows and Linux without a driver. To achieve greater than 12 points of touch on a Planar UltraRes Touch display, a driver will need to be installed on the operating system. Drivers for Windows and Linux can be found on <http://www.planar.com/support> and on the USB flash drive included with the display. Single touch only is supported for Mac operating systems. There is no driver required to enable Mac support.

**Note:** Ensure that you have installed the USB cable on the display to a computer.

**Note:** If an OPS PC is installed in the OPS slot, the OPS PC will automatically be connected internally to the touch system. The touch functionality is configurable via the Touch Control setting.

## Touchscreen MultiTouch Driver Installation

- 1 With the PC on, plug in the USB memory stick to the USB port on your PC.
- 2 Locate and open the USB drive.
- 3 Double-click on the "mt\_driver\_kit [xxxxxx].exe" to install the driver.
- 4 Follow installation prompts until driver installation is complete.

Once driver installation is complete, the touchscreen is ready for use.

## Touchscreen (PQLabs) MultiTouch Platform Content

The PQLabs Software is used for troubleshooting and calibration. The different menus are described below.

- 1 On the PC, select the **Start** menu, **All Programs** and then **PQLabs Software**.
- 2 Click on "MultiTouch Platform" to open the PQLabs MultiTouch Platform window.

### Touchscreen Information

- **Serial Number:** Displays the serial number of the connected touchscreen.
- **Firmware Version:** Displays the firmware version of the touchscreen selected under the "Serial Number" dropdown menu.
- **Touch Points:** Displays the number of touch points for which the touchscreen is capable.
- **Status:** Displays the current status of the touchscreen.

### Calibration

- **Calibration:** Starts a 4-point calibration of the touchscreen. Perform the programmed touchscreen calibration process. At the conclusion of the calibration routine your touchscreen device is ready to use and will perform with accurately positioned touch points.
- **Reset Calibration:** Resets calibration to factory default settings.

### Utility

- **Diagnose:** Starts the “MultiTouchDoctor” program. This can be used to troubleshoot issues with the touchscreen.

### Options

- Default settings on options have the following programs enabled: Tuio Support, Flash Tuio Support, Handwriting Optimization, Enable Windows Native Touch, Enable Mouse/Keyboard Simulation, and Launch When Windows Starts Up.
- Flexible Scan Rate is at a default setting.

## Uninstalling the MultiTouch Driver

- 1** On the PC, select the **Start** menu, **All Programs** and the **PQLabs Software**.
- 2** Click on the MultiTouch Driver.
- 3** Select the Uninstall option.

# Planar UltraRes Remote Monitoring Software

Planar UltraRes Remote Monitoring is a software tool that displays information about the display via a web browser. It is used primarily to access the settings in the OSD as well as provides some additional features.

## Remote Monitoring Home

Launch a web browser. Enter the IP address shown in the Network menu (see page 47). If successful, you should see the Remote Monitoring System Information page.

## Remote Monitoring System Information

This page displays version information for all programmable parts in the system. It also contains the model and serial number.

For the OSD equivalent, refer to "System Settings Submenu" on page 63.

System Information	
<b>Summary</b>	
System State:	ON
Multi-Source View:	QUAD
Audio Input:	HDMI.1
Volume:	50
Mute:	OFF
Pattern/OSD On Screen:	No
Network IP Address:	10.15.0.96
<b>Product Information</b>	
Model:	UR9851
Serial:	ABCD1234
<b>Version Information</b>	
Firmware:	1.2.987
SCP:	1.2.987
VP:	1.2.992
HDMI:	01000600
FRC:	0.1 837011

## Remote Monitoring Inputs and Views

This page shows how the sources will be laid out on the screen based on the current Multi-Source View and Advanced Layouts selections.

For the OSD equivalent, refer to "Inputs and Views Menu" on page 36.

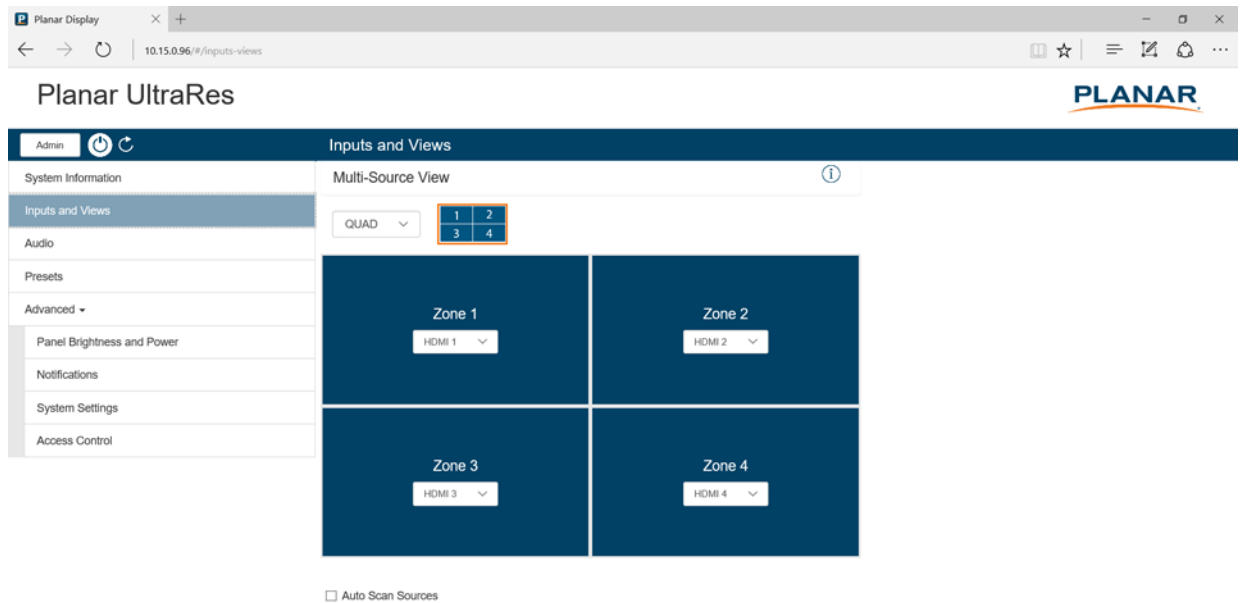

## Remote Monitoring Audio

This page enables you to make audio adjustments to the selected zone.

**Note:** Volume, Bass, Treble and Balance do not apply to the S/PDIF output.

For the OSD equivalent, refer to "Audio Menu" on page 42.

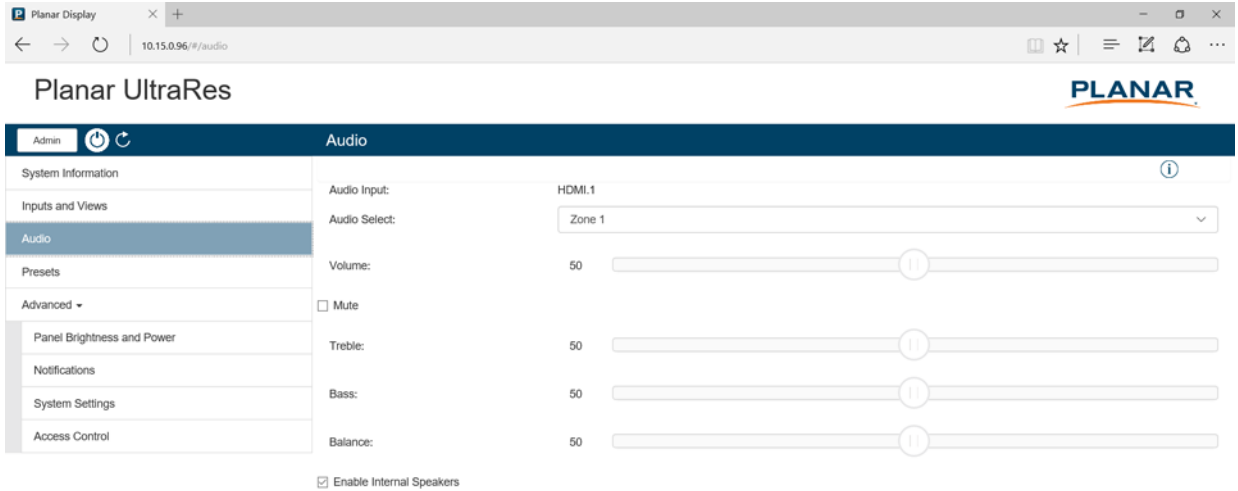

## Remote Monitoring Presets

This page enables you to save Inputs and Views settings, Image Adjust settings, Audio settings, the Backlight Intensity setting, the Local Dimming setting, and Tiling settings. You can save up to 64 presets using this page (more can be saved via the serial command interface). Only presets that contain saved data are shown in the table, with buttons to recall or delete the corresponding preset.

The controls below the table enable you to save a new preset, or overwrite an existing preset with the current display settings. To save or overwrite a preset, enter the preset number to save or overwrite, optionally enter a custom name for the preset, and then click the **Save** button.

For the OSD equivalent, refer to "Presets Menu" on page 44.

#	Name	Action
1	Preset 1	Recall #1 Delete #1
3	Video Conference	Recall #3 Delete #3
4	Guest PC	Recall #4 Delete #4
5	New Preset Name	Save #5

## Remote Monitoring Panel Brightness and Power

This page enables you to make adjustments to the brightness and power settings.

For the OSD equivalents, refer to "Panel Brightness Submenu" on page 45 and "Power Submenu" on page 46.

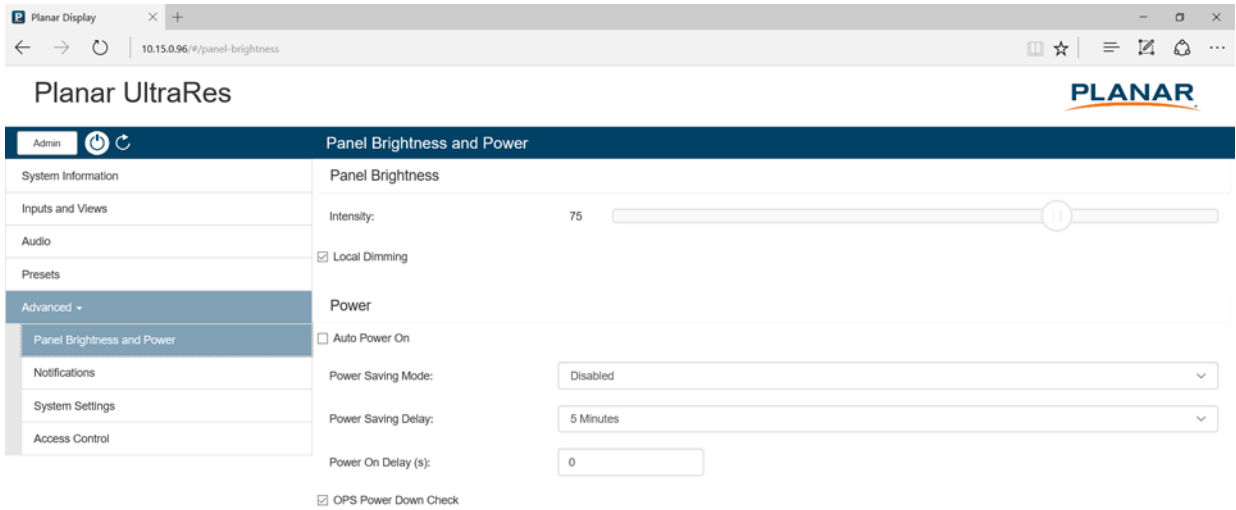



# Remote Monitoring Notifications

This page enables you to send email notifications on certain events.

The screenshot shows the 'Planar UltraRes' web interface. The 'Notifications' page is active, displaying configuration options for email notifications. The 'Email Account Settings' section includes the following fields:

- SMTP Server: smtp.comcast.net
- Connection Encryption: TLS
- Port: 485
- Authentication: Auto
- User Name: mgirardelli
- Password: server login password
- Email From Address: mgirardelli@comcast.net

The 'Notification Events' section is a table with the following data:

Event	Recipient(s)	Additional Note	Enabled
Power On/Off	marques.girardelli@planar.com	Testing 12345678	<input type="checkbox"/>
System Error			<input type="checkbox"/>

**Note:** Obtain this information from your ISP or network administrator.

The options under **Email Account Settings** are:

- **SMTP Server:** The name of the outgoing SMTP server. Obtain this information from your ISP.
- **Connection Encryption:** Selects the appropriate encryption method required by the SMTP server.
- **Port:** Selects the port that the SMTP server uses.
- **Authentication:** Use Auto unless directed by your ISP or network administrator.
- **User Name:** Login username for the SMTP server.
- **Password:** Login password for the SMTP server.
- **Email From Address:** The email address that will be shown in the "From:" field of the notification emails.

The options under **Notification Events** are:

- **Power On/Off:** Occurs when standby mode is entered and when the display is powered on.
- **System Error:** Occurs when the display has detected an error within the system.
- **Source Detect:** Occurs when the display detects and displays a new input signal.
- **Source Lost:** Occurs when the current input signal is no longer detected.
- **Source Selected:** Occurs when a different input source is selected for any of the zones.

**Note:** Each event can be sent to one or more recipients. To add multiple email addresses, separate them by a space.

- **Test Email:** Sends a test of the selected email notification. This is useful for verifying that your email account settings are setup correctly. If the test email fails, you can use the **View Last 10 Log Messages** button to get more detailed information about the failure.

## Remote Monitoring System Settings

This page enables you to make adjustments to a variety of system settings.

For the OSD equivalent, refer to "System Settings Submenu" on page 63.

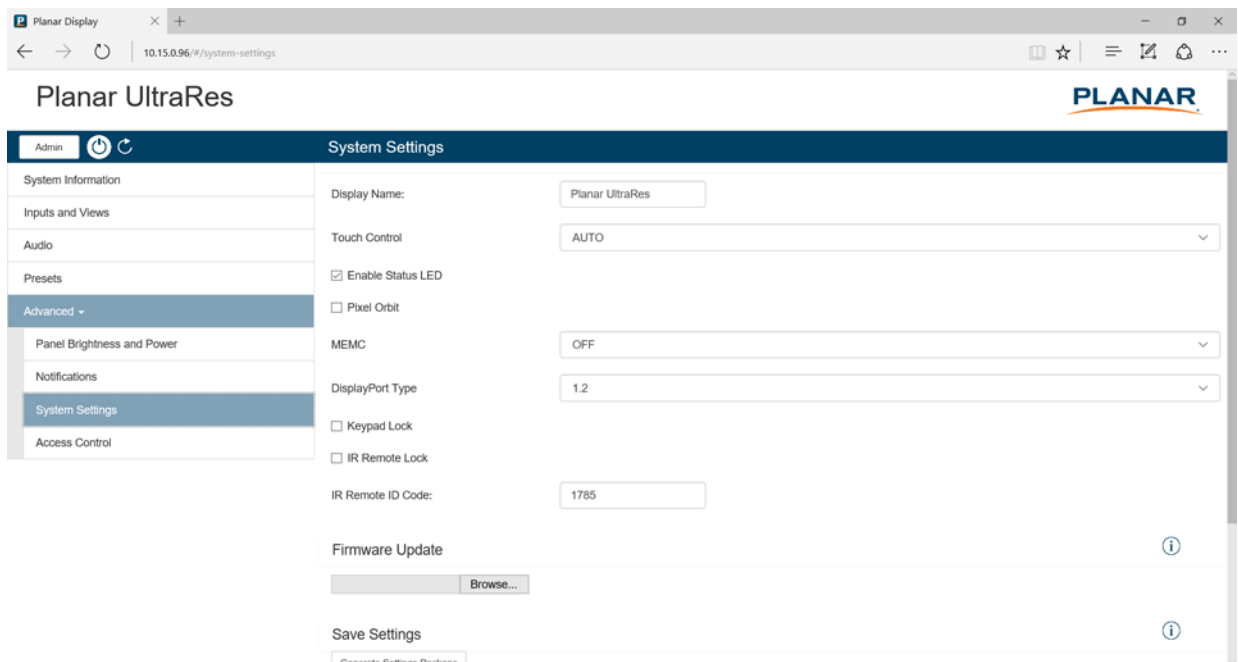

## Remote Monitoring Access Control

This page enables you to limit the ability to access certain features in the web server by password protecting them.

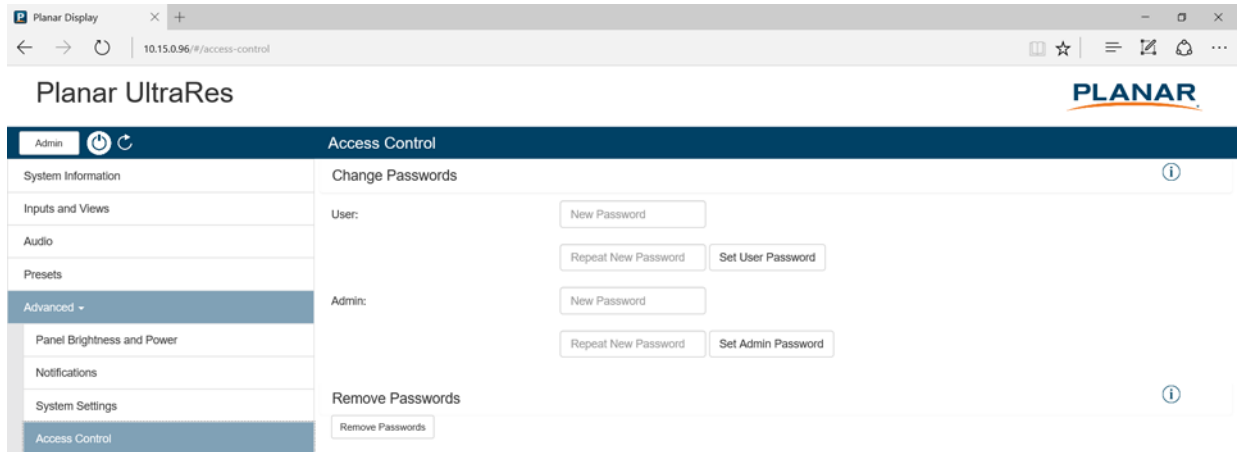

All functions other than the following require Admin level access:

- Power On/Off
- System Information
- Inputs and Views
  - Multi-Source View
  - Zone inputs
- Presets
  - Recall
- Audio
  - Volume
  - Mute
- Panel Brightness and Power
  - Panel Brightness

With the exception of System Information, all functions listed above require User level access.

If no password is set for either access level, all functions can be accessed. By default, there are no passwords for either access level.

# External Control

In addition to using the Planar UltraRes remote control and display, there are other methods of controlling the Planar UltraRes display externally:

- Using a serial link to send ASCII commands and to receive responses to those commands. The same set of commands can be sent over RS-232, USB, TCP or UDP. See the *Planar UltraRes Series RS232 User Manual* for more information.
- Using discrete infrared (IR) codes to program a third-party remote control. See "IR Command Protocol" on page 30.
- Using the Planar UltraRes Remote Monitoring software to access the settings in the OSD as well as some additional features via a web browser. See "Planar UltraRes Remote Monitoring Software" on page 70.

# Signal Compatibility

Signal Type	Resolution	Frame rate (Hz)	Line Rate (kHz)	Pixel Rate (MHz)	HDMI 1-2, OPS	HDMI 3-4	DisplayPort	References
PC	640x480	59.94	31.469	25.175	x	x	x	VESA DMT, CEA-861-F Format 1
	640x480	72	37.861	31.500	x	x	x	VESA DMT
	640x480	74.99	37.500	31.500	x	x	x	VESA DMT
	640x480	85	43.269	36.000	x	x	x	VESA DMT
	800x600	60.32	37.890	40.000	x	x	x	VESA DMT
	800x600	72	48.077	50.000	x	x	x	VESA DMT
	800x600	75	46.875	49.500	x	x	x	VESA DMT
	800x600	85.06	53.674	56.250	x	x	x	VESA DMT
	848x480	59.659	29.830	31.500	x	x	x	VESA CVT
	848x480	74.769	37.684	41.000	x	x	x	VESA CVT
	848x480	84.751	42.969	46.750	x	x	x	VESA CVT
	1024x768	60	48.363	65.000	x	x	x	VESA DMT
	1024x768	70	56.476	75.000	x	x	x	VESA DMT
	1024x768	75.03	60.023	78.750	x	x	x	VESA DMT
	1024x768	85.03	68.677	94.500	x	x	x	VESA DMT
	1152x864	70.012	63.851	94.500	x	x	x	VESA DMT
	1152x864	75	67.500	108.000	x	x	x	VESA DMT
	1152x864	84.999	77.094	121.500	x	x	x	VESA DMT
	1280x768	49.929	39.593	65.250	x	x	x	VESA CVT
	1280x768	59.995	47.396	68.250	x	x	x	VESA CVT-R
	1280x768	60	47.776	79.500	x	x	x	VESA CVT
	1280x768	74.893	60.289	102.250	x	x	x	VESA CVT
	1280x768	84.837	68.633	117.500	x	x	x	VESA CVT
	1280x960	60	60.000	108.000	x	x	x	VESA DMT
	1280x960	75	75.000	126.000	x	x	x	VESA DMT
	1280x960	85.002	85.938	148.500	x	x	x	VESA DMT
	1280x1024	60.02	63.981	108.000	x	x	x	VESA DMT
	1280x1024	75.02	79.976	135.000	x	x	x	VESA DMT
	1280x1024	85.02	91.146	157.500	x	x	x	VESA DMT
	1360x768	60	47.712	85.500	x	x	x	VESA DMT

Signal Type	Resolution	Frame rate (Hz)	Line Rate (kHz)	Pixel Rate (MHz)	HDMI 1-2, OPS	HDMI 3-4	DisplayPort	References
PC	1400x1050	49.965	54.113	100.000	x	x	x	VESA CVT
	1400x1050	60	64.7	101.00	x	x	x	VESA CVT-R
	1400x1050	60	65.317	121.750	x	x	x	VESA CVT
	1400x1050	74.867	82.278	156.000	x	x	x	VESA CVT
	1600x1200	60	75.000	162.000	x	x	x	VESA DMT
	1920x1080	49.929	55.621	141.500	x	x	x	VESA CVT
	1920x1080	59.963	67.158	173.000	x	x	x	VESA CVT
	1920x1080	59.950	66.587	138.500	x	x	x	VESA CVT-R
	1920x1200	49.932	61.816	158.250	x	x	x	VESA CVT
	1920x1200	59.950	74.038	154.000	x	x	x	VESA CVT-R
	1680x1050	49.974	54.121	119.500	x	x	x	VESA CVT
	1680x1050	59.954	65.290	146.250	x	x	x	VESA CVT
	1920x2160	60	135.000	297.000	x	x	x	CEA-861-F, VIC 16, with vertical parameters doubled
	2560x1440	59.951	88.787	241.500	x	x	x	VESA CVT-R
	2560x1600	59.972	98.713	268.500	x	x	x	VESA CVT-R
	3840x2160	24	52.438	209.750	x	x	x	VESA CVT-R
	3840x2160	30	65.688	262.750	x	x	x	VESA CVT-R
	3840x2160	50	110.500	442.000	x		x	VESA CVT-R
3840x2160	60	133.313	533.250	x		x	VESA CVT-R	
Apple Mac	640x480	66.59			x	x	x	
	832x624	75.087	49.107	55.000	x	x	x	
	1024x768	59.278	48.193	64.000	x	x	x	
	1024x768	74.927	60.241	80.000	x	x	x	
	1152x870	75.062	68.681	100.000	x	x	x	
SDTV	480i	60			x	x	x	SMPTE 125M, CEA-861-F Formats 6 & 7
	576i	50			x	x	x	ITU-R BT.601, CEA-861-F Formats 21 & 22
EDTV	480p	60	31.469	27.000	x	x	x	ITU-R BT.1358, CEA-861-F Format 17 & 18
	576p	50	31.250	27.000	x	x	x	SMPTE 125M, CEA-861-F Format 6 & 7

Signal Type	Resolution	Frame rate (Hz)	Line Rate (kHz)	Pixel Rate (MHz)	HDMI 1-2, OPS	HDMI 3-4	DisplayPort	References
HDTV	1080i	50	28.125	74.500	x	x	x	SMPTE 274M, CEA-861-F Format 20
	1080i	60	33.750	74.250	x	x	x	SMPTE 274M, CEA-861-F Format 5
	720p	50	37.500	74.250	x	x	x	SMPTE 296M, CEA-861-F Format 19
	720p	60	45.000	74.250	x	x	x	SMPTE 296M, CEA-861-F Format 4
	1080p	24	27.000	74.250	x	x	x	SMPTE 274M, CEA-861-F Format 32
	1080p	25	28.125	74.250	x	x	x	SMPTE 274M, CEA-861-F Format 33
	1080p	30	33.750	74.250	x	x	x	SMPTE 274M, CEA-861-F Format 34
	1080p	50	56.250	148.500	x	x	x	SMPTE 274M, CEA-861-F Format 31
	1080p	60	67.500	148.500	x	x	x	SMPTE 274M, CEA-861-F Format 16
UHDTV	3840x2160	24	54.000	297.000	x	x	x	CEA-861-F Format 93, HDMI 1.4b VIC 1
	3840x2160	25	56.250	297.000	x	x	x	CEA-861-F Format 94, HDMI 1.4b VIC 2
	3840x2160	30	67.500	297.000	x	x	x	CEA-861-F Format 95, HDMI 1.4b VIC 3
	3840x2160	50	67.500	297.000	x			CEA-861-F Format 96, 4:2:0 sub-sampling
	3840x2160	50	135.000	594.000	x		x	CEA-861-F Format 96
	3840x2160	60	67.500	297.000	x			CEA-861-F Format 97, 4:2:0 sub-sampling
	3840x2160	60	135.000	594.000	x		x	CEA-861-F Format 97

# Color Subsampling Support

Video Timing	Input	RGB 4:4:4 Supported	YUV 4:4:4 Supported	YUV 4:2:2 Supported	YUV 4:2:0 Supported
4K @ 50/60 Hz	DP	x	x	x	
4K @ 50/60 Hz	HDMI 1-2, OPS	x	x	x	x
4K @ 50/60 Hz	HDMI 3-4				
All Other Supported Timings	Any	x	x	x	



# Specifications

Item	UR7551-MX UR7551-MX-ERO UR7551-MX-ERO-T	UR8651-MX UR8651-MX-ERO UR8651-MX-ERO-T	UR9851 UR9851-ERO UR9851-ERO-T
<b>LCD Panel</b>			
Resolution	3840 x 2160		
Aspect Ratio	16:9		
Screen Size	75"	86"	98"
Orientation	Landscape/Portrait		
Brightness (Typ.)	500 cd/m <sup>2</sup>		
Contrast Ratio (local dimming enabled)	20000:1		
Contrast Ratio (local dimming disabled)	1200:1	1200:1	1300:1
Viewing Angle (Typ.)	178°		
Response Time (Typ.)	6ms	8ms	8ms
Color Gamut	72% NTSC		
Display Color	1.07 billion (10 bit depth)		
<b>Connectivity</b>			
Standard Inputs	DisplayPort 1.2, HDMI 2.0 x 2, HDMI 1.4 x 2, OPS		
Audio Output	Line out, S/PDIF		
Control and Monitoring	LAN RJ45, RS232 In, IR, Keypad, Planar® UltraRes™ App		
<b>Mechanical</b>			
Display Dimensions (Unmounted and Mounted)	Standard/ERO™: 66.5" x 38.1" x 3.4" (1690mm x 968mm x 86.6mm)  Touch 67.9" x 39.5" x 3.86" (1724mm x 1003mm x 98.1mm)	Standard/ERO™: 76.3" x 43.6" x 3.41" (1937mm x 1108mm x 86.6mm)  Touch 77.6" x 45.0" x 3.86" (1972mm x 1143mm x 98.1mm)	Standard/ERO™: 86.7" x 49.5" x 3.6" (2203 mm x 1258 mm x 93 mm)  Touch: 87.6" x 50.4" x 4.1" (2225 mm x 1280 mm x 104 mm)
Bezel Width	Standard/ERO: 0.8" (20 mm) Touch: 1.5" (37.7mm)	Standard/ERO: 0.82" (20.9mm) Touch: 1.5" (38.2mm)	Standard/ERO: 0.9" (22 mm) Touch: 1.3" (33 mm)

Item	UR7551-MX UR7551-MX-ERO UR7551-MX-ERO-T	UR8651-MX UR8651-MX-ERO UR8651-MX-ERO-T	UR9851 UR9851-ERO UR9851-ERO-T
Display Weight	Standard: 165 lbs (75 kg) ERO: 186 lbs (84 kg) Touch: 207 lbs (94 kg)	Standard: 184 lbs (84 kg) ERO: 201 lbs (92 kg) Touch: 234 lbs (107 kg)	Standard: 255 lbs (115 kg) ERO: 305 lbs (138 kg) Touch: 330 lbs (150 kg)
Mounting	Planar Profile Mounting System or VESA 400 x 400 mm	Planar Profile Mounting System or VESA 600 x 400 mm	
Wall Mount Weight	Landscape: 21 lbs (9.5 kg) Portrait: 17 lbs (7.7 kg)	Landscape: 23 lbs (10.4 kg) Portrait: 18 lbs (8.2 kg)	Landscape: 24.7 lbs (11.2 kg) Portrait: 19.0 (8.6 kg)
Fanless	Yes		
Speakers	10W x 2 built-in		
<b>Usage</b>			
Recommended Usage	24x7		
Backlight	E-LED	E-LED	D-LED
Backlight Life	30,000 hours min		
<b>Power Source</b>			
Power Consumption (Typ.)	200W	230W	410W
BTUs/hr (Typ.)	200W x 3.42 BTU = 684 BTU/hr	230W x 3.42 BTU = 787 BTU/hr	410W x 3.42 BTU = 1402 BTU/hr
Standby Power Consumption	<1.2W		
Input Voltage/ Frequency	AC 100V~240V; 50-60 Hz		
<b>Environment</b>			
Storage Temperature	Min -4°F ~ Max 140° F (-20°C ~ 60°C)		
Operating Temperature	Min 32°F ~ Max 104°F (0 ~ 40°C) at up to 1500 m; Min 32°F ~ Max 95°F (0 ~ 35°C) at up to 3000 m	Min 32°F ~ Max 95°F (0 ~ 35°C) at up to 1500 m; Min 32°F ~ Max 86°F (0 ~ 30°C) at up to 3000 m	
Humidity	20~85% RH		
Approvals	FCC Class A, cTUVus, CE		

Item	UR7551-MX UR7551-MX-ERO UR7551-MX-ERO-T	UR8651-MX UR8651-MX-ERO UR8651-MX-ERO-T	UR9851 UR9851-ERO UR9851-ERO-T
<b>ERO (ERO and ERO-T models only)</b>			
Surface Treatment	Anti-glare (AG)		Anti-reflective (AR)
Glass Type	2mm Corning® Gorilla® Glass		3mm soda-lime
<b>Touch (ERO-T models only)</b>			
Touch Technology	IR		
Supporting OS	Windows 7, 8, 10, Vista, XP, Mac OSX, and Linux		

# Dimensions

## UR7551-MX

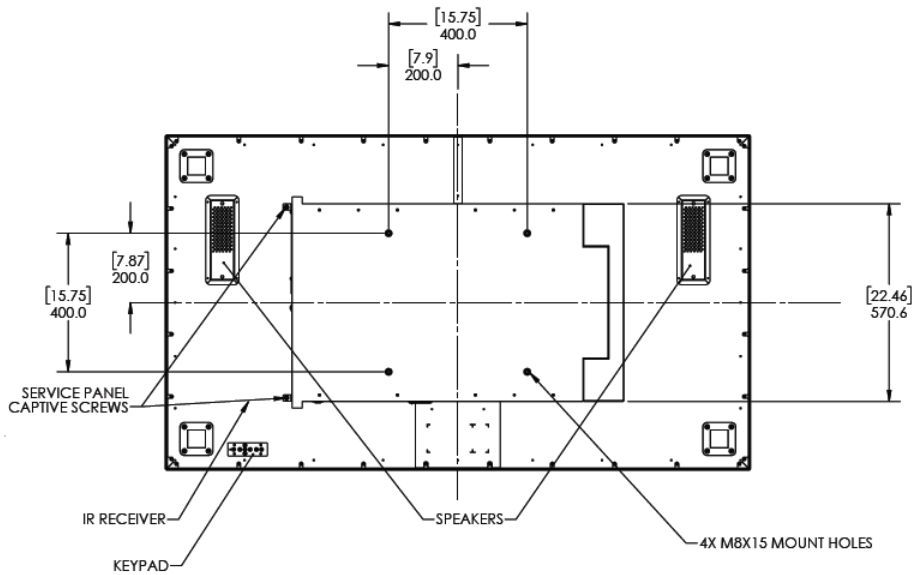
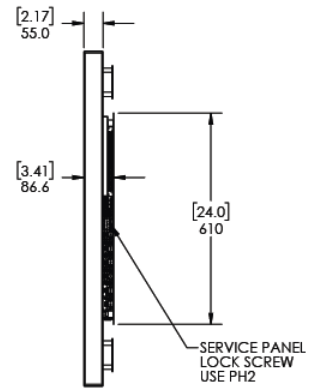
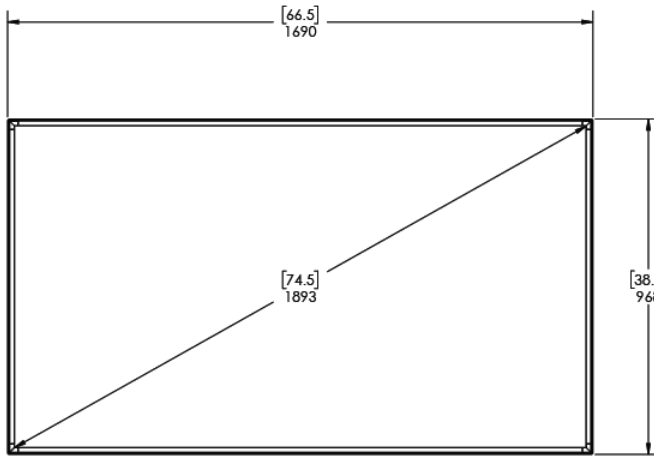
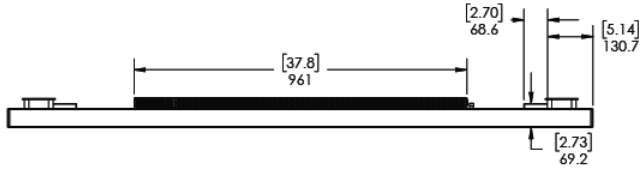

# UR7551-MX Touch

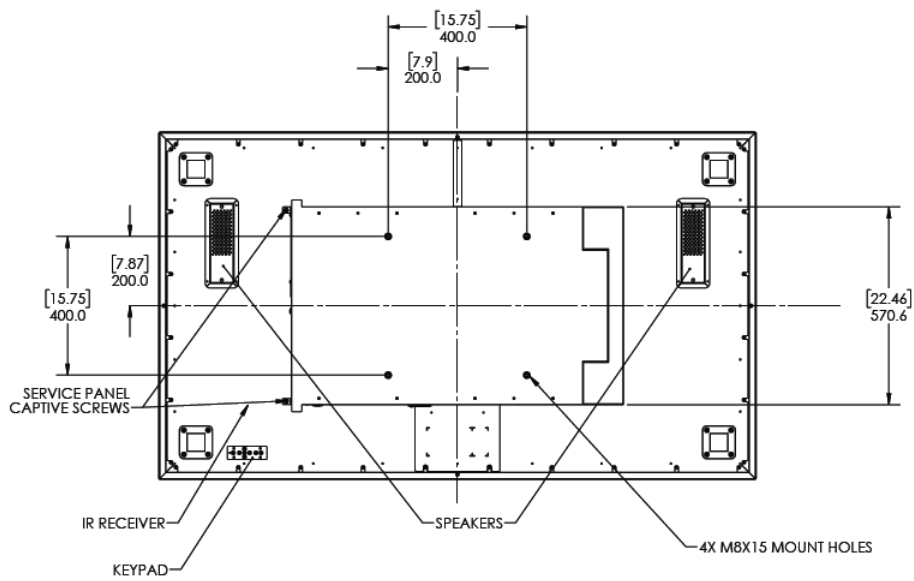
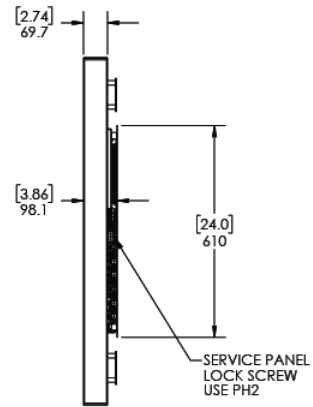
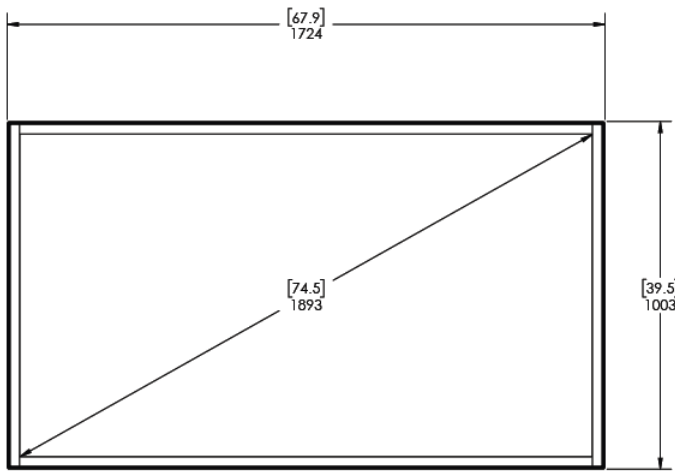
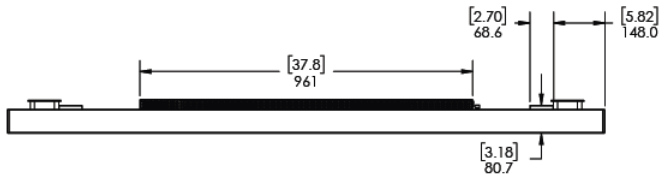

# UR8651-MX

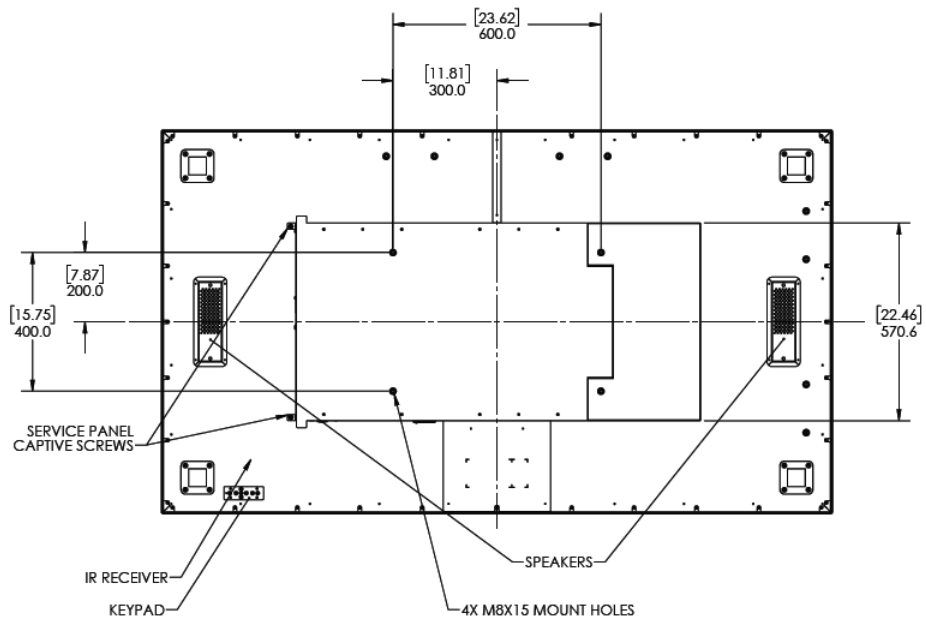
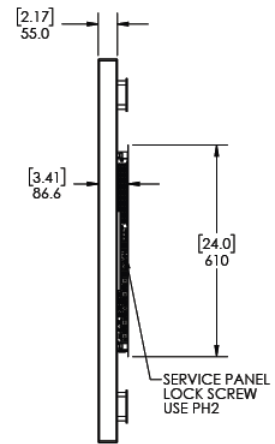
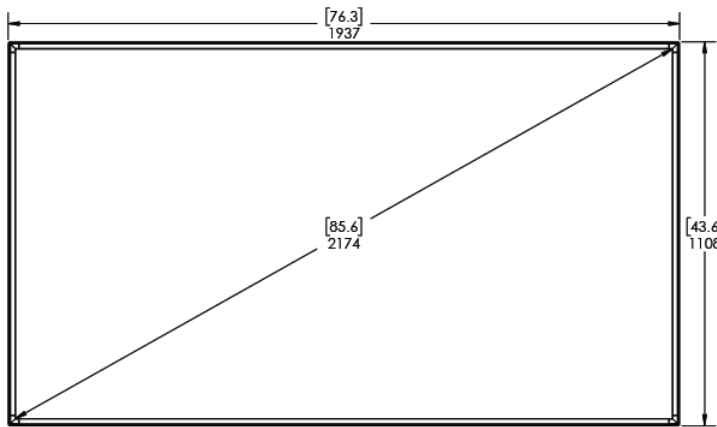
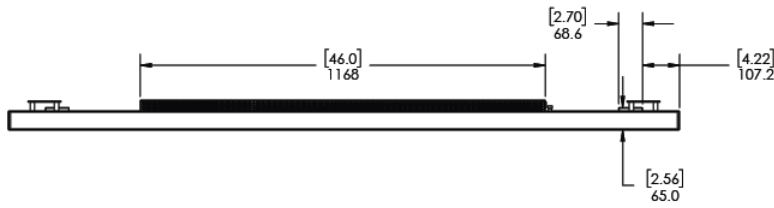

# UR8651-MX Touch

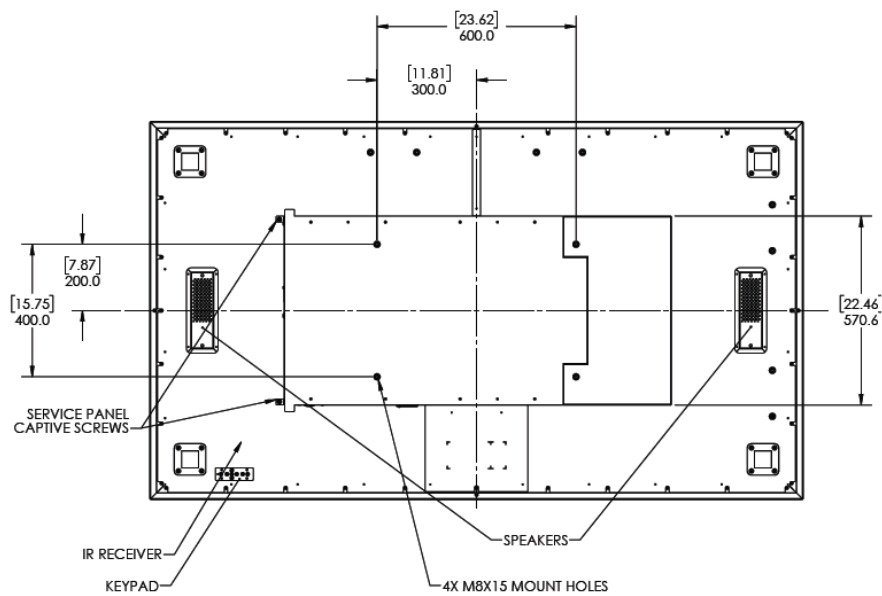
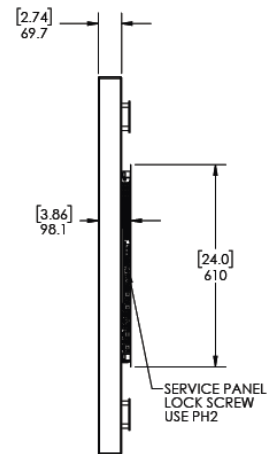
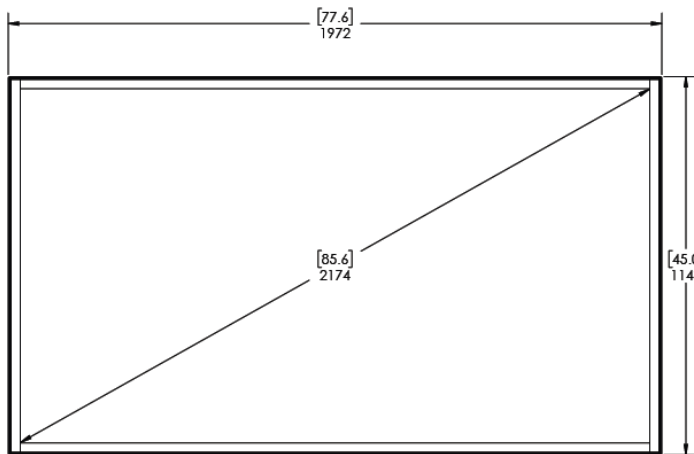
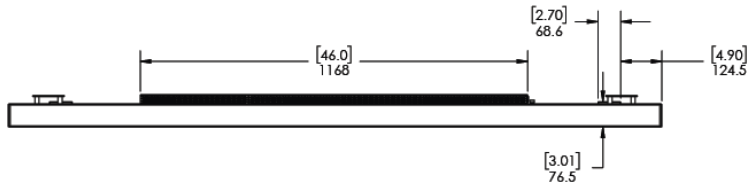

# UR9851

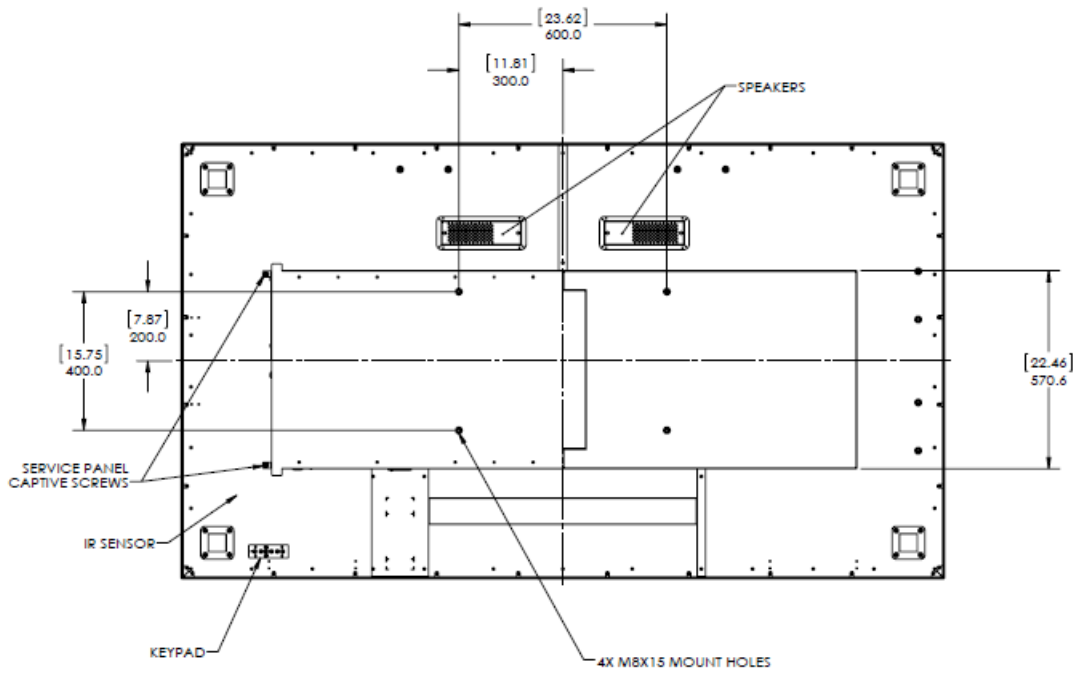
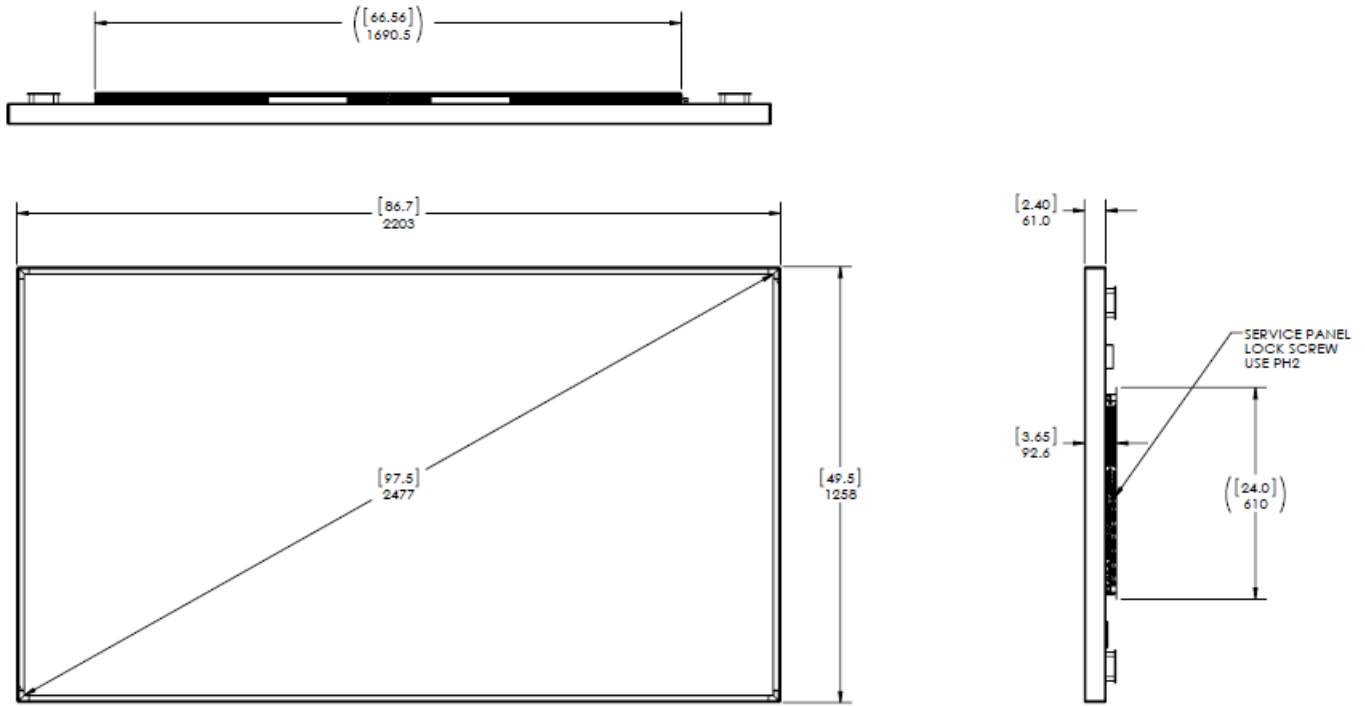



## UR9851 Touch

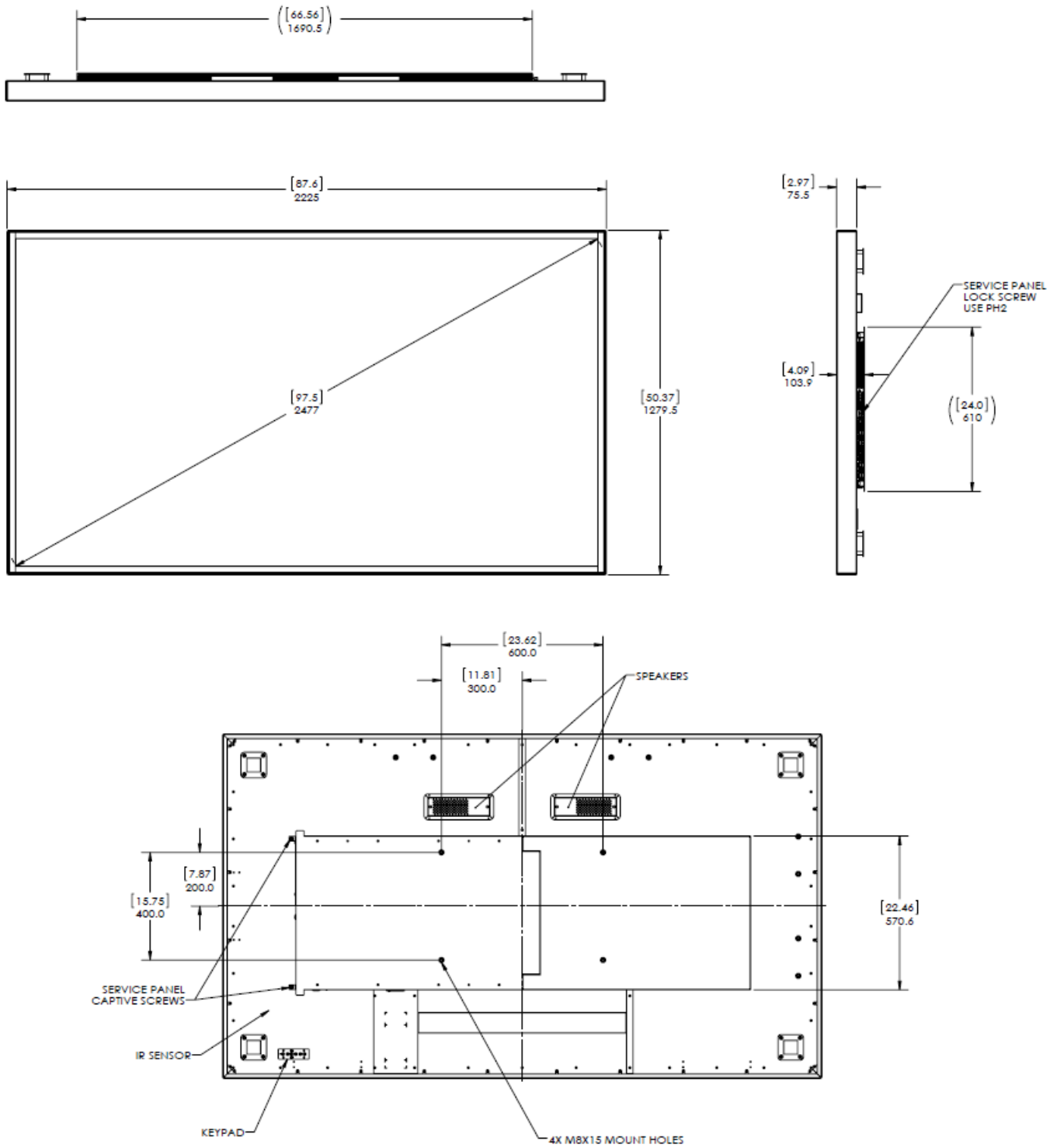

# Troubleshooting During Installation

This section includes troubleshooting information about different issues you may encounter during the installation process or after your display has been running for some time. If you are not able to solve your issue in this section, please contact Planar's Technical Support team for assistance.

## Error Codes

To see the last 50 errors that have occurred, select the Error Log tab in the OSD (MAIN MENU > INFORMATION > ERROR LOG), as shown below.

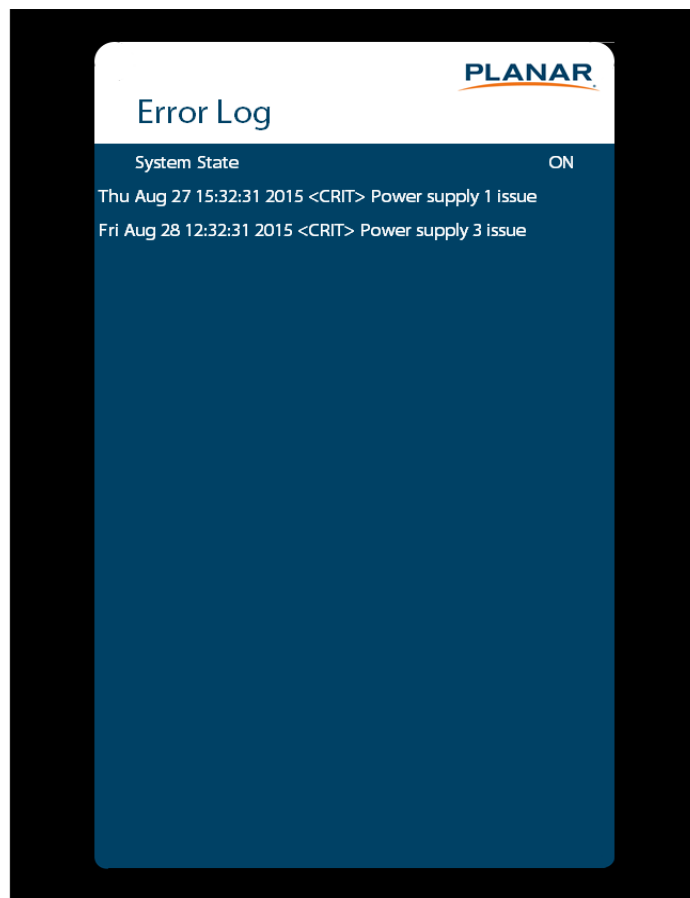

Possible error codes include:

- Power supply 1 issue
- Power supply 2 issue
- Power supply 3 issue
- Calibration EEPROM board disconnected

Note the following:

- One power supply failure will limit the backlight intensity to 50% maximum and two power supply failures will shut off the display.
- Power supply 3 issues do not apply to the 75" and 86" models.

## Symptoms, Possible Causes and Solutions

Below are different symptoms that you might encounter as you install your Planar UltraRes display. First look at the different symptoms to see if you can find your issue. And then look at the possible cause and try the suggested solution(s). If you still are not able to resolve your issue, please contact Planar's Technical Support Department.

### Symptom: Can't Get PC to Output 4K @ 24/30/60 Hz

#### Solution

Make sure that your graphics card can support a 4K output. See "Supported Graphics Cards" on page 25 for a list of the current graphics cards that Planar supports for the Planar UltraRes Series displays.

#### Solution

Confirm that you are using a DisplayPort output. You can't use a DisplayPort-to-HDMI adapter to output 4K content.

#### Solution

Make sure you are using a high-speed HDMI cable. Standard HDMI cables might work but are not guaranteed.

#### Solution

Verify that the selected **EDID Type** setting in the OSD is **4K60** or **4K30**. If you change the EDID setting, you may need to disconnect and reconnect the cable.

#### Solution

If you are trying to use 4K @ 60 Hz on HDMI, the display must be connected to HDMI 1 or HDMI 2.

#### Solution

If you are trying to display 4K @ 60 Hz on HDMI 1 or HDMI 2, the Multi-Source View setting must be Single.

## Symptom: Can't Get PC to Output 4K @ 24/30/60 Hz

### Possible Cause

The connector overmold is too large, which can cause the pins not to contact properly on some cards.

### Solution

If using DisplayPort, make sure the connector overmold isn't too large.



## Symptom: Can't Select OPS or HDMI 1

### Solution

The OPS and HDMI sources cannot be viewed at the same time. If your Multi-Source View setting is not Single, and you select OPS in a zone, any zones that are showing HDMI 1 will automatically change to OPS. Conversely, if you select HDMI 1 in a zone, any zones that are currently showing OPS will automatically change to HDMI 1.

## Symptom: IR Isn't Working Properly

### Possible Cause

The wired IR module may not be fully connected.

### Solution

Make sure the IR is fully connected by pressing hard to ensure it is inserted as far as possible.

### Possible Cause

The wired IR module cable is not being used.

### Solution

Make sure that the wired IR module cable is being used.



# Accessing Planar's Technical Support Website

Visit <http://www.planar.com/support> for the following support documents and resources:

- User Manual
- RS232 User Manual
- Touch screen drivers
- Standard warranties
- Planar support hotline number and email

# Index

---

## A

adjusting volume, 33  
advanced settings menu, 45  
audio menu, 42  
avoiding temporary image retention, 4

---

## C

cleaning the display, 6  
codes, error, 92  
color subsampling, 82  
connecting  
    touch screen, 68  
control, external, 78

---

## D

dimensions, 86  
display  
    installing, 10

---

## E

error codes, 92  
external control, 78

---

## I

image adjust menu, 39  
information menu, 65  
input source  
    selecting, 34  
inputs and view menu, 36  
installation  
    before you build, 10  
    of display on a wall, 11  
    of LCD, 10  
    OPS expansion slot, 24  
    safety precautions, 3  
introduction, 1

IR codes, using, 30  
IR commands  
    for Planar UltraRes, 30  
    protocol, 30  
IR not working, 95

---

## K

kickstand bracket  
    using, 21

---

## L

LCD  
    installation, 10  
    mounts, 7  
LCD display, 7  
locking, 32

---

## M

menus  
    advanced settings, 45  
    audio, 42  
    image adjust, 39  
    information, 65  
    inputs and views, 36  
    presets, 44  
    using, 35  
mounting template for LCD mounts, 7

---

## N

navigating menus, 35  
normal usage guidelines, 5

---

## O

OPS expansion slot  
    installation, 24  
optional

- LCD mounts, 7
- mounting template, 7
- using the kickstand bracket, 21

osd menus, 32, 35

unlocking, 32

---

## P

package contents, 7

Planar UltraRes display

- installing on a wall, 11
- troubleshooting via error codes, 92

presets menu, 44

---

## R

recommended usage, 4

remote control

- using, 29

---

## S

safety

- during installation, 3
- information, 2
- precautions, 2
- precautions during use, 4

selecting input source, 34

service plans, ii

signal compatibility, 79

specifications, 83

subsampling

- color, 82

supported timings, 79

---

## T

temporary image retention

- avoiding, 4
- definition, 4

timings, 79

TIR *see temporary image retention*

touchscreen

- using the touchscreen, 68

troubleshooting, 92

- during installation, 92
- error codes in Planar UltraRes, 92

- symptoms, 93
- turning off the displays, 33
- turning on the displays, 33

---

## U

using the kickstand bracket, 21

using the remote, 29

---

## V

volume, 33

---

## W

warranty

- information, ii