

Maximum Flat Panel Weight:
300 lb. / 136 kg.

LMVLF

INSTALLATION GUIDE

Press and Release Pop Out Mount for
300lbs/136kg Flat Panel Display

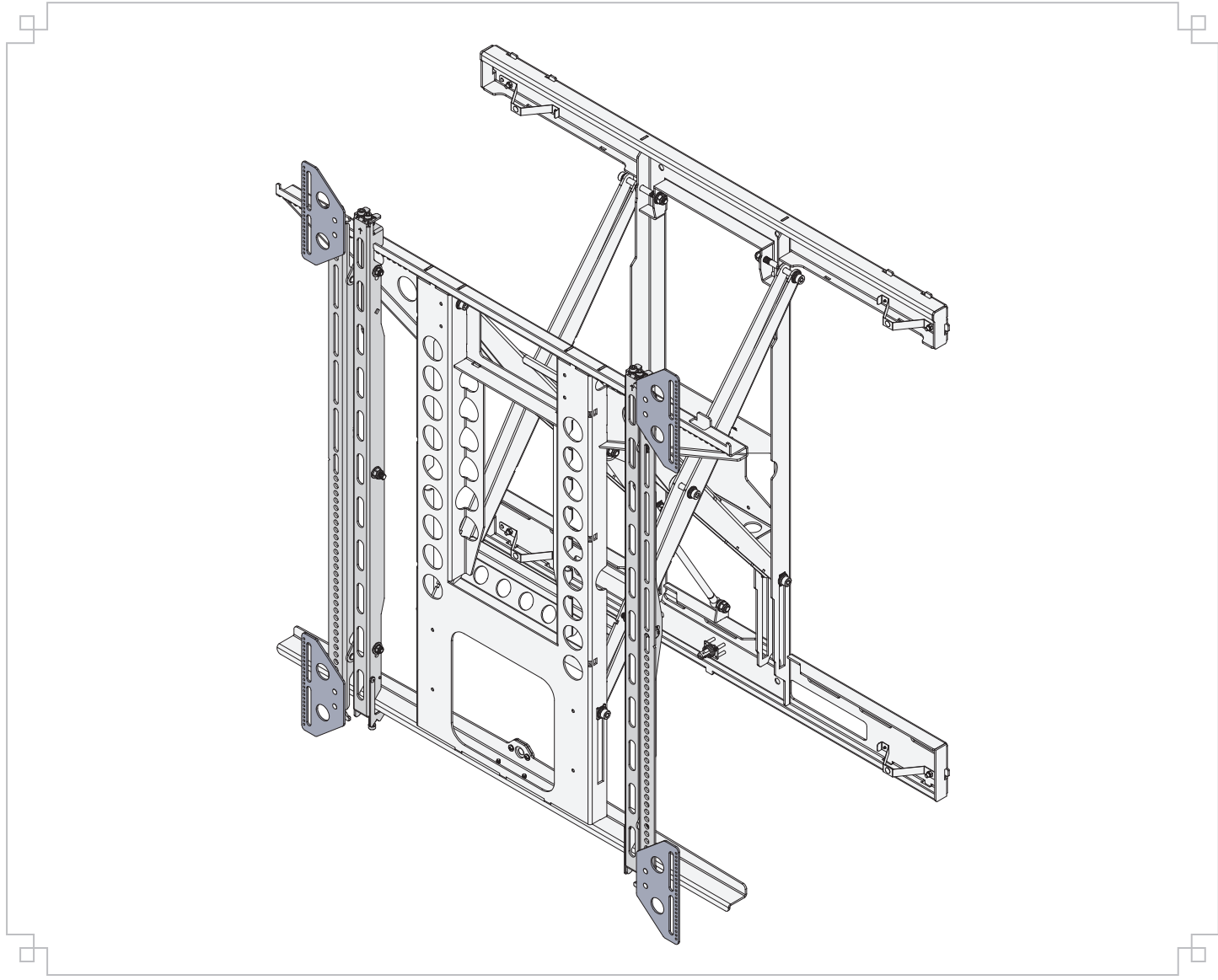

LMVLF

Installation Guide

Maximum Weight Capacity: **300 lbs.**

THE WALL STRUCTURE MUST BE CAPABLE OF SUPPORTING AT LEAST FOUR TIMES THE WEIGHT OF THE FLAT PANEL. IF NOT, THE WALL STRUCTURE MUST BE REINFORCED.

CAUTION STATEMENT



PRIOR TO THE INSTALLATION OF THIS PRODUCT, THE INSTALLATION INSTRUCTIONS MUST BE READ AND COMPLETELY UNDERSTOOD. KEEP THESE INSTALLATION INSTRUCTIONS IN AN EASILY ACCESSIBLE LOCATION FOR FUTURE REFERENCE.



PROPER INSTALLATION PROCEDURE BY A QUALIFIED SERVICE TECHNICIAN MUST BE FOLLOWED, AS OUTLINED IN THESE INSTALLATION INSTRUCTIONS. FAILURE TO DO SO COULD RESULT IN PROPERTY DAMAGE, SERIOUS PERSONAL INJURY, OR EVEN DEATH.



SAFETY MEASURES MUST BE PRACTICED AT ALL TIMES DURING THE ASSEMBLY OF THIS PRODUCT. USE PROPER SAFETY EQUIPMENT AND TOOLS FOR THE ASSEMBLY PROCEDURE TO PREVENT PERSONAL INJURY.



PREMIER MOUNTS DOES NOT WARRANT AGAINST DAMAGE CAUSED BY THE USE OF ANY PREMIER MOUNTS PRODUCT FOR PURPOSES OTHER THAN THOSE FOR WHICH IT WAS DESIGNED OR DAMAGE CAUSED BY UNAUTHORIZED ATTACHMENTS OR MODIFICATIONS, AND IS NOT RESPONSIBLE FOR ANY DAMAGES, CLAIMS, DEMANDS, SUITS, ACTIONS OR CAUSES OF ACTION OF WHATEVER KIND RESULTING FROM, ARISING OUT OF OR IN ANY MANNER RELATING TO ANY SUCH USE, ATTACHMENTS OR MODIFICATIONS.



At least two qualified people should perform the assembly procedure. Personal injury and/or property damage can result from dropping or mishandling the flat panel.



If mounting to wall studs or ceiling studs, make sure that the mounting screws are anchored into the center of the wall studs or ceiling studs. Use of an edge-to-edge stud finder is recommended.



It is recommended that a maximum of 5/8" plaster board be used when mounting to wooden studs.



Be aware of the mounting environment. If drilling and/or cutting into the mounting surface, always make sure that there are no electrical wires in wall. Cutting or drilling into an electrical line may cause serious personal injury.



Make sure there are no water or natural gas lines inside the wall where the mount is to be located. Cutting or drilling into a water or gas line may cause severe property damage or personal injury.



This product is intended for indoor use only. Use of this product outdoors could lead to product failure and/or serious personal injury.



Do not install near sources of high heat. Do not install on a structure that is prone to vibration, movement or chance of impact.

Required for installation

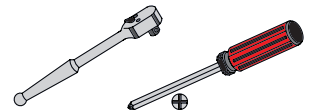
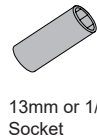
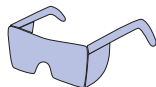
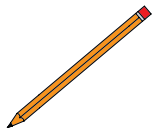

INCLUDES:

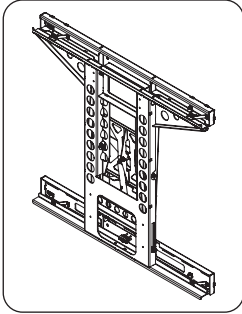

Wall Mount

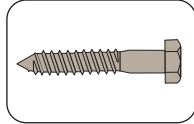

5/16" x 3" Lag Bolts (Qty 7)

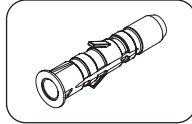

Finned Anchors (Qty 7)

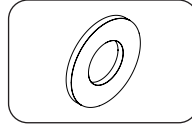

5/16" Flat Washers (Qty 11)

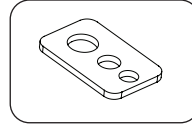

Universal Washers (Qty 4)

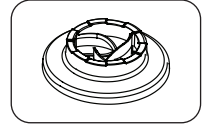

Universal Spacers (Qty 8)

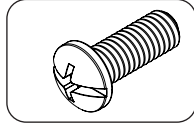

M6 x 16mm (Qty 4)

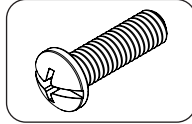

M6 x 20mm (Qty 4)

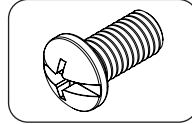

M8 x 16mm (Qty 4)

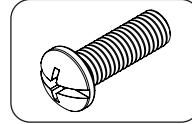

M8 x 25mm (Qty 4)

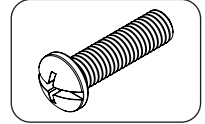

M8 x 30mm (Qty 4)

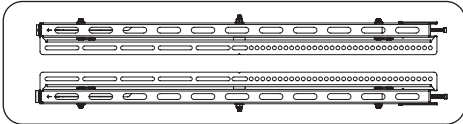

Mounting Brackets

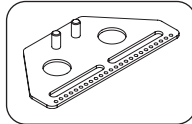

Adapter Wings (Qty 4)

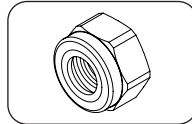

M8 Lock Nut (Qty 4)

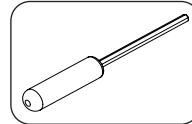

M5 Allen Driver (Qty 1)

1

Wood Application

Use a stud finder to determine the wall studs in the vicinity of the mount and mark the wall.

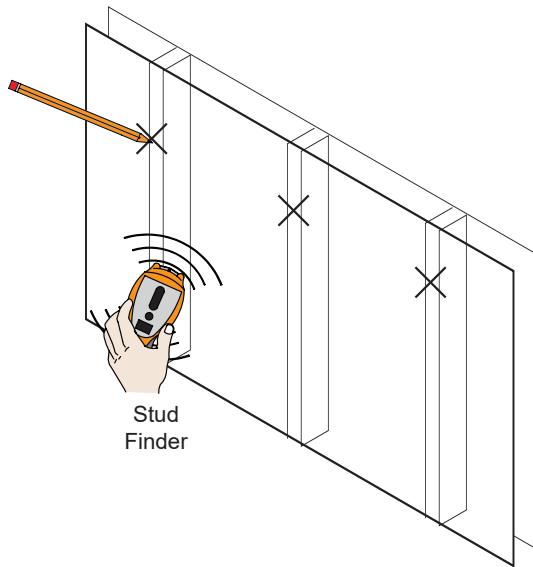

Stud Finder

Concrete Application

Two people recommended for this step; one person to level the mount and another person to mark the mounting locations.

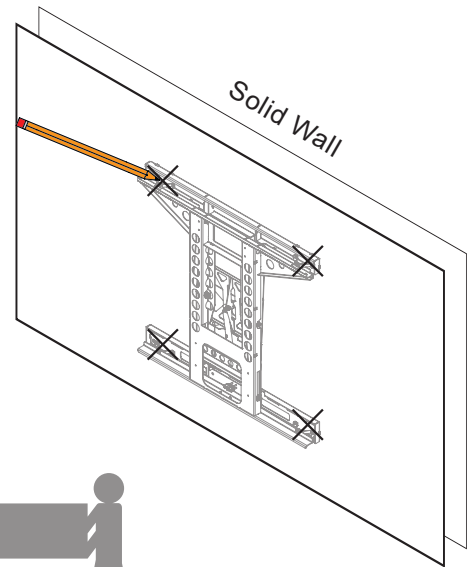

Solid Wall

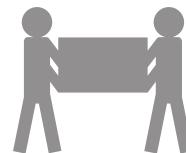

Heavy, May require 2-person.

LMVLF

Installation Guide

2

LEVEL THE MOUNT VERTICALLY AND HORIZONTALLY BEFORE TIGHTENING THE BOLT.

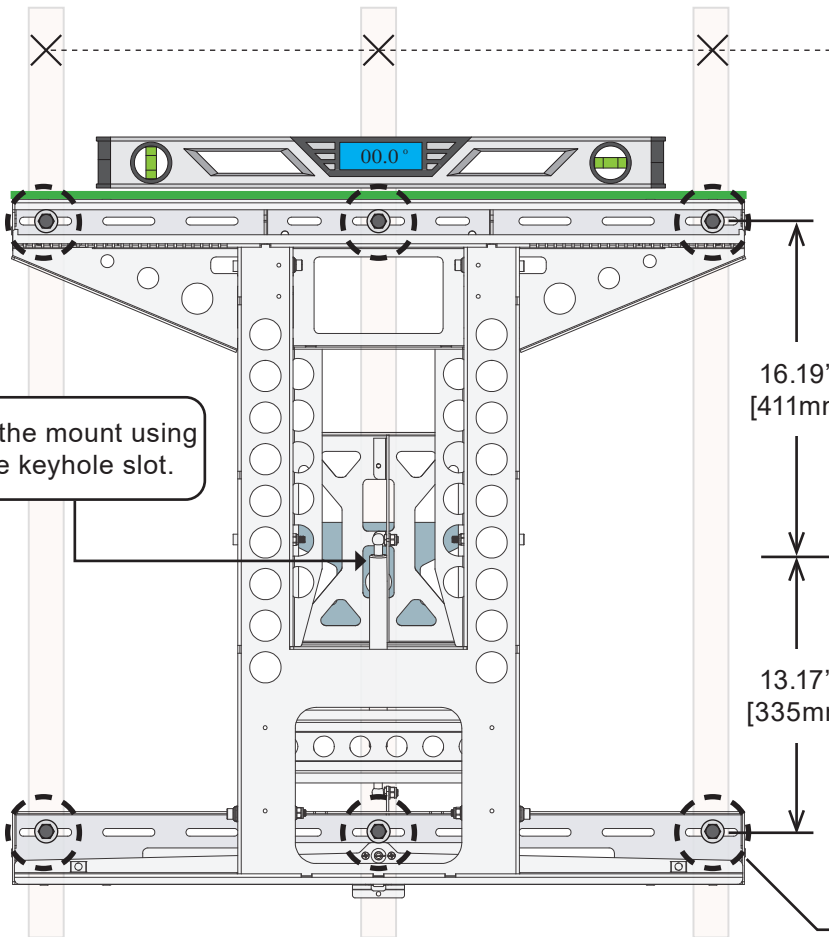

Marked for locating the center of the stud (on wood application).

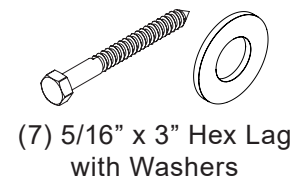
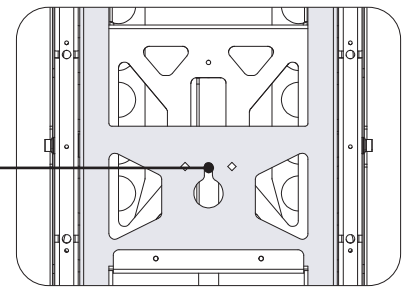

CONCRETE APPLICATION

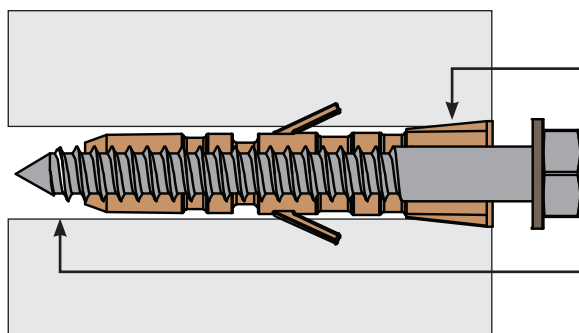

Finned Anchor

Make pilot holes with 1/8" or 7/32" drill bit and finish with 3/8" drill bit.



3

SELECTING THE MOUNTING HARDWARE

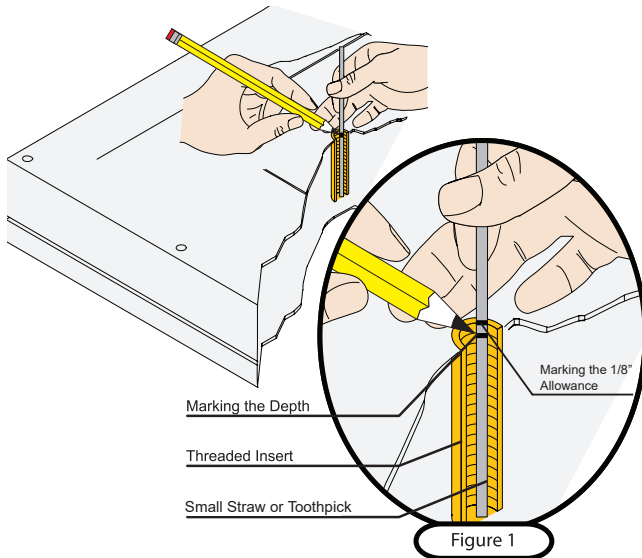

- 1) Insert a small straw or toothpick into the threaded inserts found on the back of the flat-panel.
- 2) Use a pencil to mark the depth of the threaded insert on the small straw or toothpick.
- 3) Mark the straw or toothpick 1/8" above the depth of the threaded insert, as shown in Figure 1.
- 4) Insert the small straw or toothpick into the remaining threaded inserts to compare and verify their depth using the straw or toothpick's 1/8" allowance mark.
- 5) Locate the correct diameter screw for the threaded insert.



If the screw you selected is longer than the 1/8" allowance mark on the small straw or toothpick, as shown in Figure 2 and Figure 3, do not use this screw. The screw length must not bypass the mark.

- 6) Test each size of the screws provided.
The correct screws should thread easily into the mounting point and not pull out when tension is applied.

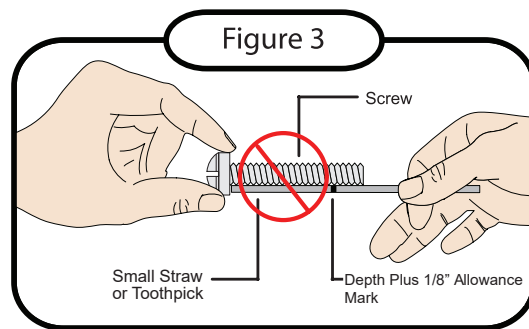
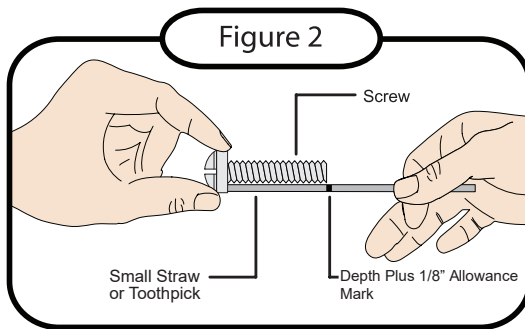

LMVLF

Installation Guide

4

INSTALL THE MOUNTING BRACKETS

UP Arrow

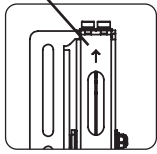

Selected mounting screws
(from previous step) and
universal washers.

Do not overtighten.

Top of flat
panel

LANDSCAPE
OR PORTRAIT

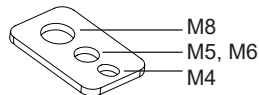

Universal Washers x4

EXTENSION ADAPTER WINGS

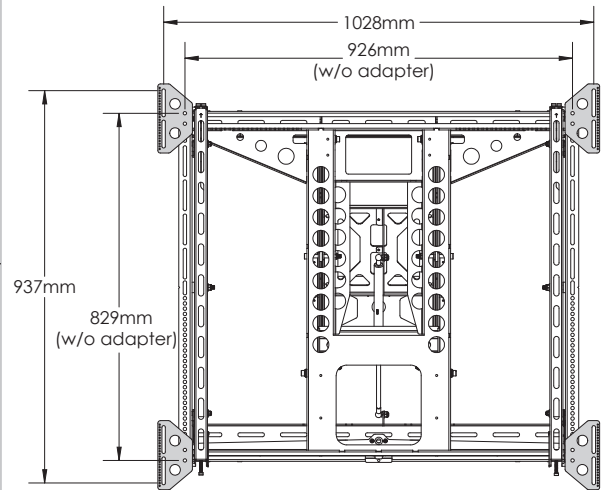

Max Mounting Pattern

Install the **optional** adapter wings
to make accommodations for various
mounting patterns.

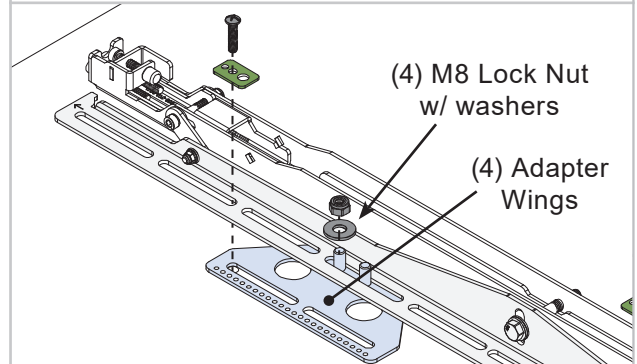

USE ADDITIONAL UNIVERSAL SPACERS TO FILL UNEVEN GAPS

Universal Spacers allow the user to attach the mounting bracket to flat-panels which have recessed or uneven mount points. Each Universal Spacer adds 1/4" to the distance between the mounting bracket and the flat-panel.

Recessed or uneven
mounting points

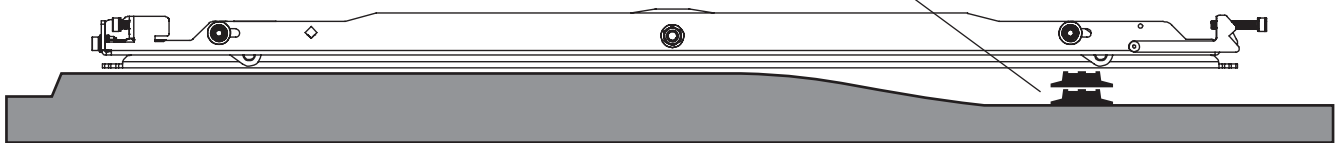
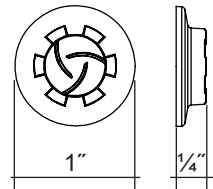

MOVE INWARD

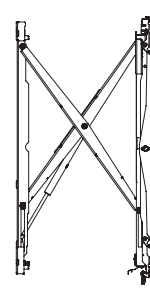
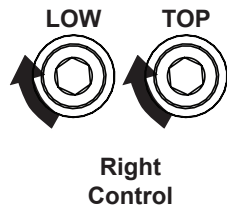
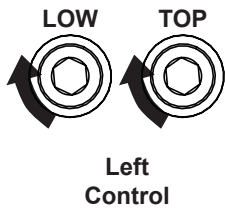

MOVE OUTWARD

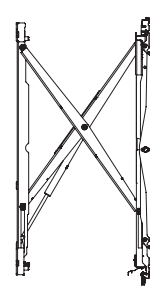
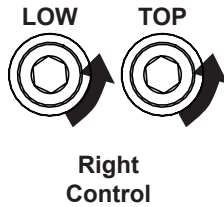
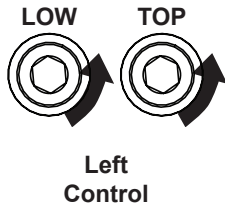

TILT UP

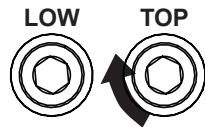
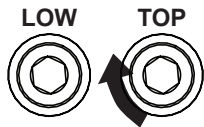

AND/
OR

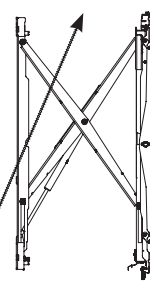
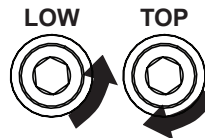
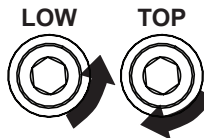

TILT DOWN

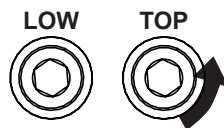
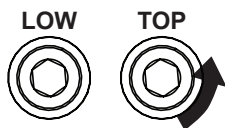

AND/
OR

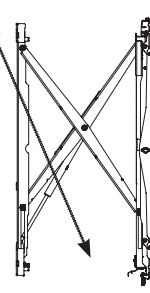
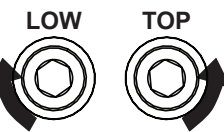
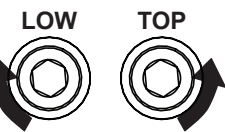

LMVLF

Installation Guide

LEVEL UP

Left Control

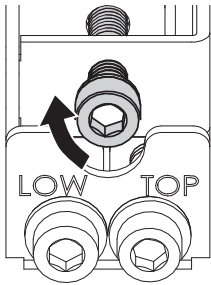

Right Control

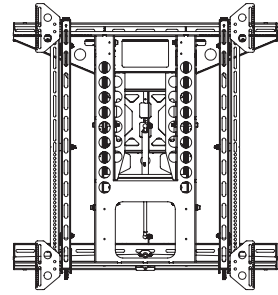
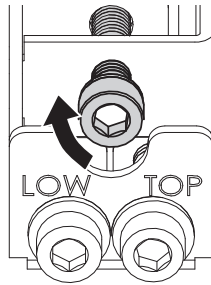

LEVEL DOWN

Left Control

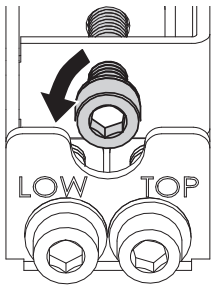

Right Control

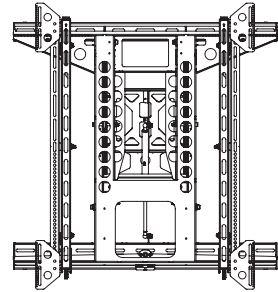
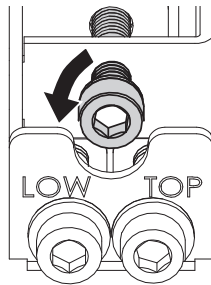

ROTATE LEFT

Left Control

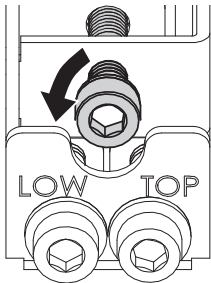

Right Control

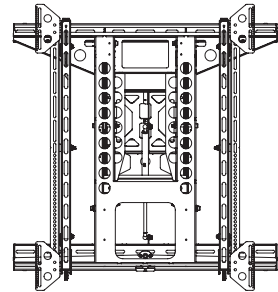
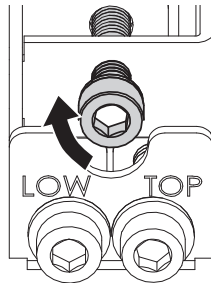

ROTATE RIGHT

Left Control

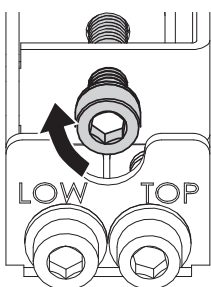

Right Control

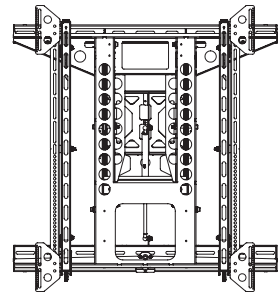
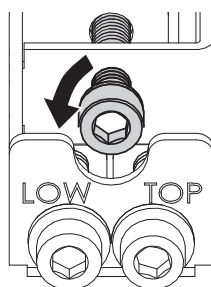

5

Attaching the Flat-Panel to the Mount

Mounting bracket adjustments are factory preset (see note).



This section requires two people.



Do not release the flat-panel prematurely. The top and bottom hooks of both mounting brackets must be securely seated on the upper and lower mounting rails.

- 1) Raise the flat-panel past the top and bottom mounting rails on the wall panel.
- 2) Slide the flat-panel down slowly, keeping it close to the wall.
- 3) Engage the top and bottom mounting brackets to the rails of the mount.

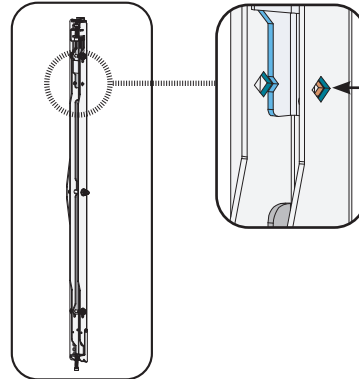
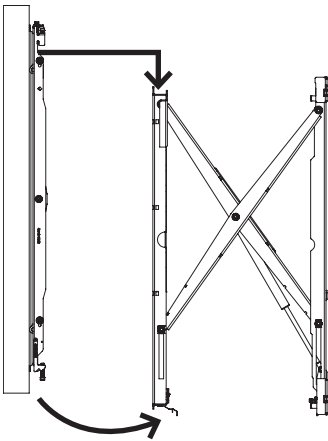

Note: The registers must align prior to installation.

Neutral Position
(factory preset).

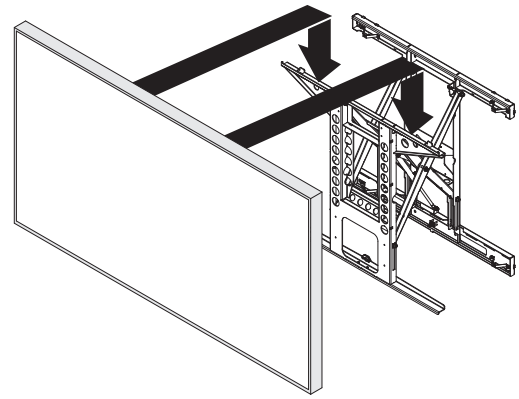

Locking Safety Screw Installation

6

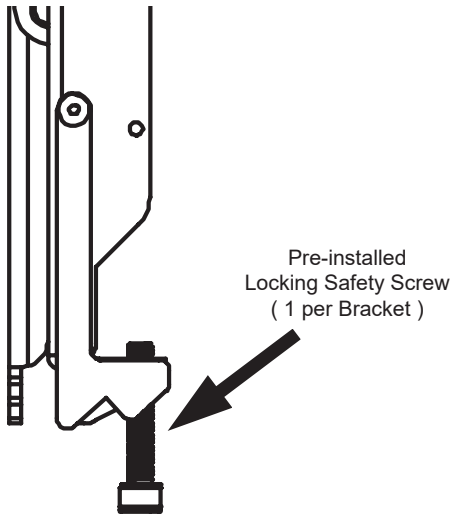

The locking safety screws keep the flat-panel from being accidentally dislodged from the mount.

- 1) Locate the pre-installed security locking safety screw at the bottom of each of the mounting brackets.
- 2) Use the M5 Allen driver (supplied) to tighten the locking safety screw.

Note: Tighten screw to surface, then tighten 1/4" turn



Do not overtighten the locking safety screws.



**ONLY TIGHTEN AFTER
FINAL ADJUSTMENT**

LMVLF

Installation Guide

LMVLF SPACER

OPTIONAL FOR EASE OF INSTALLTION

Model-specific spacers are available for most flat-panel displays. Engineered with the intent of significantly reducing installation time on large video wall array. Contact customer service to inquire about model specific spacers.

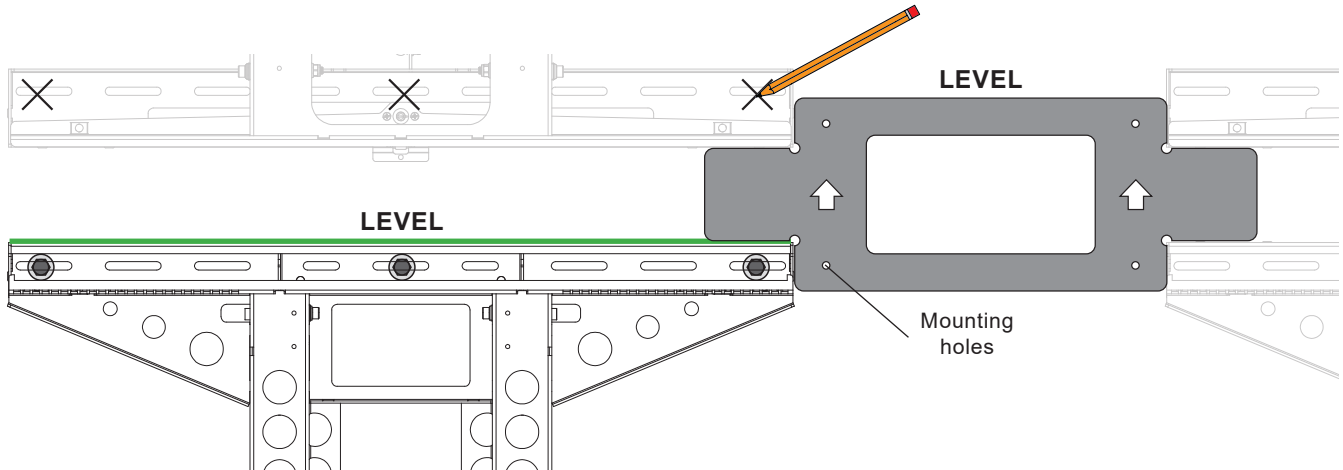

1. Align the corner register tabs of the mount and spacer then temporary secure the spacer in place. Use commercially available hardware.
2. Set the following mount on the next register corner tabs and mark its mounting location.
3. Reutilize the same spacer as many times as needed to complete the video wall matrix.

Use the **GAPit GO/No Go Gauge** as a final step in the process to inspect and adjust the gap to **prevent costly replacement** and **extend the lifespan of the displays**. For more information, please visit: www.mounts.com

1. Swipe GAPit along vertical gap
2. Inspect for .050" gap & adjust if needed
3. Swipe GAPit along horizontal gap
4. Inspect for .050" gap & adjust if needed

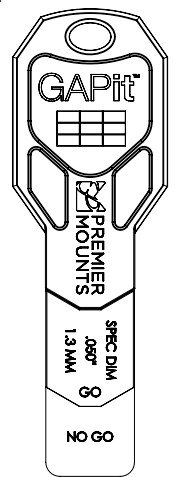
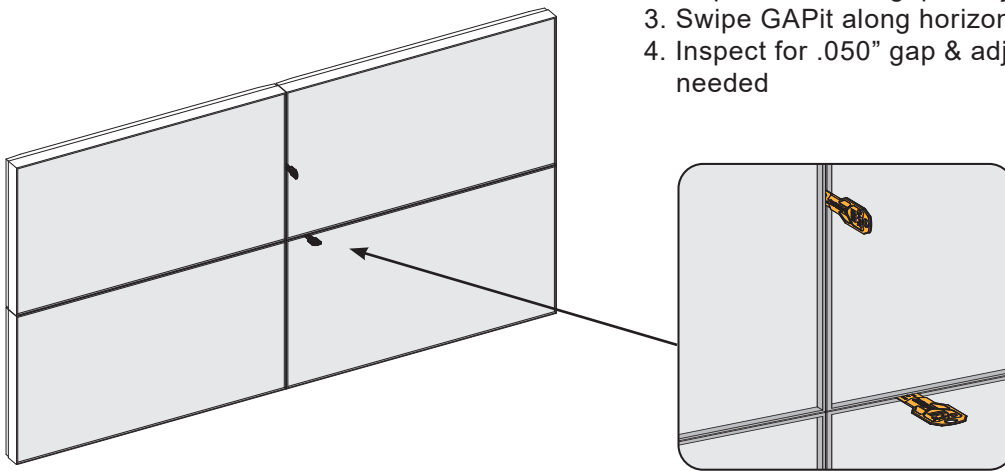

7

Servicing

1. Push evenly in the front to release the single latch spring lock (Figure 1).
2. Slowly pull the front of the mount to extend the scissor arms.
3. Loosen the locking safety screws on both mounting brackets.
4. Tilt up the bottom of the flat-panel, then set the kickstand shown in Figures 2 & 3.
5. Perform any necessary repairs.

*Install the optional locking latch to prevent accidental release of the mount. Pull the string to manually disengage. Latch sold separately, P/N: LMVLF-LTH.

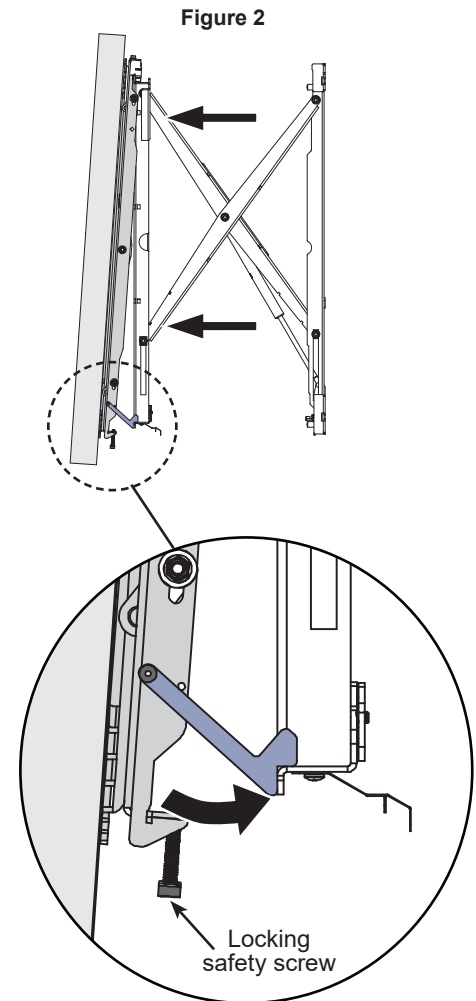
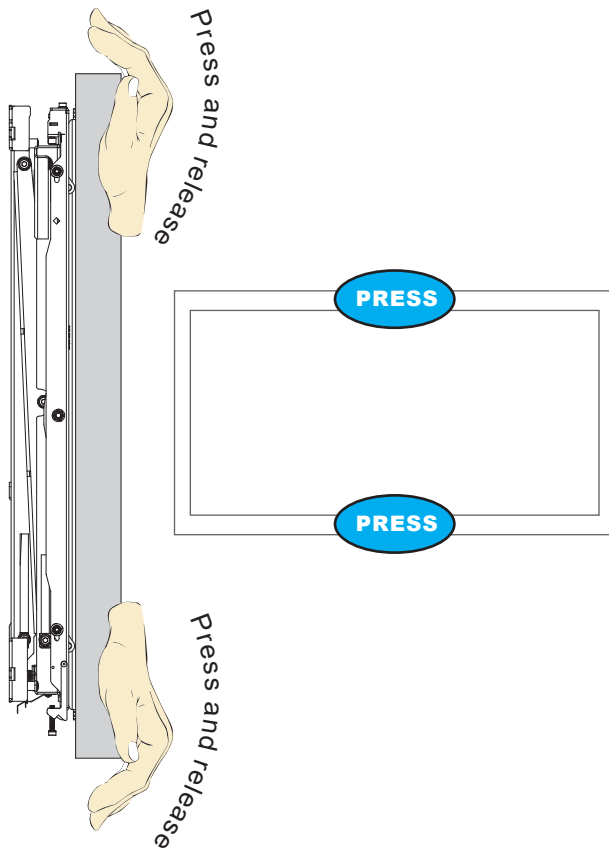
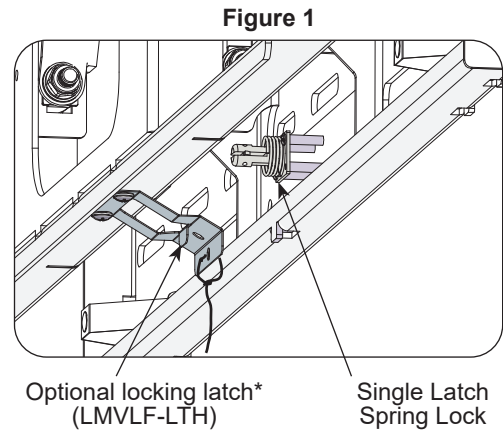

PREMIER MOUNTS LIMITED LIFETIME WARRANTY

What and Who is Covered by this Limited Lifetime Warranty

Premier Mounts warrants all mounting products to be free from defects in material and workmanship for the lifetime of the original installation of the product.

What Premier Mounts Will Do

At the sole option of Premier Mounts, Premier Mounts will repair or replace any product or product part that is defective. If Premier Mounts chooses to replace a defective product or part, a replacement product or part will be shipped to you at no charge, but you must pay any related labor costs.

What is Not Covered: Limitations

Premier Mounts disclaims any liability for damage to mounts, adapters, displays, projectors, other property, or personal injury resulting, in whole or in part, from improper installation, modification, use or misuse of its products.

NOTWITHSTANDING ANYTHING TO THE CONTRARY IN THIS WARRANTY, THIS WARRANTY IS LIMITED TO FIVE YEARS FROM THE DATE OF PURCHASE IN THE EVENT THAT THE WARRANTED PRODUCT IS COMMERCIALY RENTED OUT.

Electrical products and components, such as amplifiers, speakers, motors, switches remote controls and related electrical items, are backed by a 3-year warranty.

Premier Mounts disclaims all other warranties, express or implied, including warranties of merchantability and fitness for a particular purpose. Premier Mounts is not responsible for incidental or consequential damages, including but not limited to, inability to use its products or labor costs for removing and replacing defective products or parts. Some states do not allow the exclusion or limitation of incidental or consequential damages, so the above limitation or exclusion may not apply to you.

What Customers Must Do for Warranty Service

If you discover a problem that you think may be covered by the warranty, you must report it in writing to the address below within thirty (30) days. Proof of purchase (an original sales receipt) from the original consumer purchaser must accompany all warranty claims. Warranty claims must also include a description of the problem, the purchaser's name, address, and telephone number. General inquiries can be addressed to Premier Mounts Customer Service at 1-800-368-9700. Warranty claims will not be accepted over the phone or by fax.

Premier Mounts
Attn: Warranty Claim
2620 Palisades Drive
Corona, CA 92882 USA

How State Law Applies

This warranty gives you specific legal rights, and you may also have other rights which vary from state to state.

Premier Mounts intends to make this manual accurate and complete. However, Premier Mounts makes no claim that the information contained herein covers all details, conditions or variations, nor does it provide for every possible contingency in connection with the installation or use of this product. The information contained in this document is subject to change without notice or obligation of any kind. Premier Mounts makes no representation of warranty, expressed or implied, regarding the information contained herein. Premier Mounts assumes no responsibility for accuracy, completeness or sufficiency of the information contained in this document.

Warranty: <http://www.mounts.com/warranty>

