

Introduction

The MM-EP15 is the 15" single pole for multi-monitor mounts with base for extrusion track installation. The MM-EP28 is the 28" version, and the MM-EP42 is the 42" version. These three different pole sizes provide more mounting options for those installing multi-monitor mounts. The larger the pole, the more displays that can be mounted per single base. This base is designed for extrusion tracks typically used on consoles for central stations and control centers. The extrusion base fits standard tracks and is a great mounting option for upgrading from traditional CRT monitors to HD flat-panel consoles.

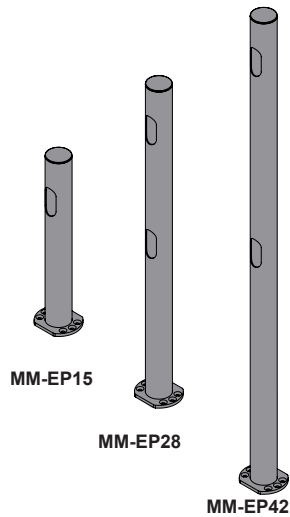

Parts List

<p>MM-EP15/28/42 (Varied sized pole with extrusion base) (Qty 1)</p>	<p>T-Nut (Qty 4)</p>
<p>1/4-20" x 5/8" Flat Hex Screw (Qty 4)</p>	
<p>5/32" Hex Key (Qty 1)</p>	

Step 1

Multi-monitor mounts with extrusion track bases can be installed on 1.5" on center T slot channel or single T slot channel (channel not included).

? First, determine where you would like your multi-monitor mount positioned on your desired surface. The mounting surface should be capable of supporting 5x the weight of the flat-panel and mount. (Mount and flat-panel sold separately)

Are you installing your pole on a 1.5" on center T slott channel?

If no, procede to step 2...

If yes, follow instructions below

- For dual 1.5" on center channel you will need to use the four outer holes on the base of the pole (Figure 1)
- Insert the four (4) 1/4 20" Flat Hex Screws through the top of the four holes on base shown in figure 1.
- Thread the four (4) provided T nuts onto the bottom of each of the now installed screws (Figure 3).
Do not thread all the way to the top. You will need to leave loose for positioning the tube on the extrusion track.

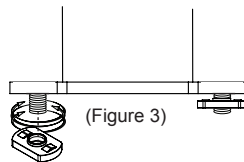
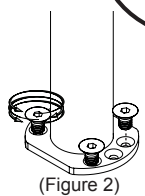
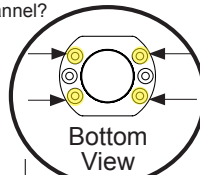

! Proceed to step 3.

Step 2

For single T slot channel you will need to use the two center holes on the base of the pole (Figure 4).

Follow sub-steps 2 and 3 from the above section, but only use two (2) 1/4 20" Flat Hex Screw and two (2) T nuts into the holes noted in figure 4.

Proceed to Step 3.

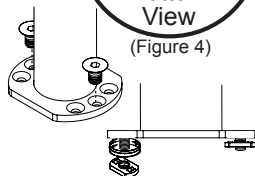
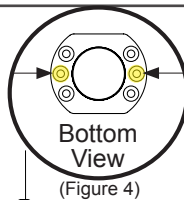

Step 3

- Once you have your Flat Hex Screws installed and T-Nuts threaded in, insert the base into the track.
- The bottom cable routing hole should always be facing to the back.
- Slide pole to the desired position on the track.
- Once in place, tighten the (4 for the dual track and 2 for the single) 1/4 20" Flat Hex Screws with the included hex key so that the pole remains in place and is sturdy (Figure 5).
- If the pole needs to be re-positioned on the track, loosen the the flat hex screws and simply slide to the new position. Repeat sub-step 3 in this section.

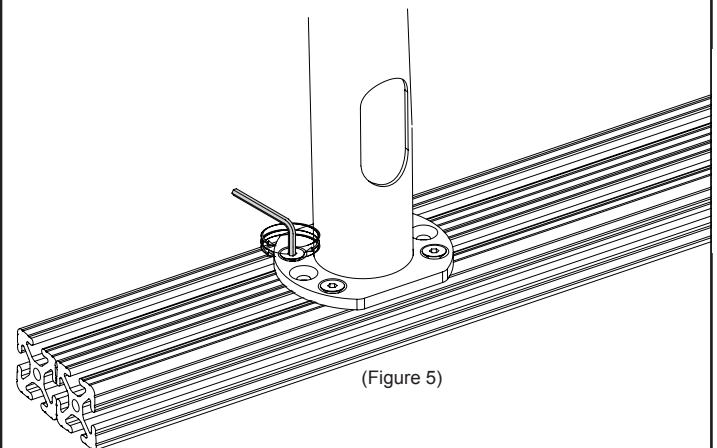
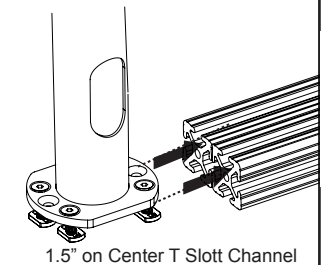
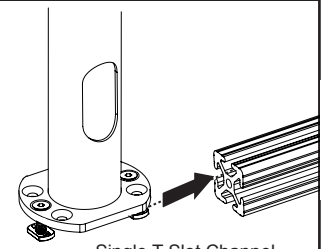

PREMIER MOUNTS

LIMITED LIFETIME WARRANTY

What and Who is Covered by this Limited Warranty and for How Long

Premier Mounts warrants this product to be free from defects in material and workmanship for the lifetime of the original owner of this product. The limited warranty is valid only for the original purchaser of the product.

What Premier Mounts Will Do

At the sole option of Premier Mounts, Premier Mounts will repair or replace any product or product part that is defective. If Premier Mounts chooses to replace a defective product or part, a replacement product or part will be shipped to you at no charge, but you must pay any labor costs.

What is Not Covered; Limitations

PREMIER MOUNTS DISCLAIMS ANY LIABILITY FOR DAMAGE TO MOUNTS, ADAPTERS, DISPLAYS, PROJECTORS, OTHER PROPERTY, OR PERSONAL INJURY RESULTING, IN WHOLE OR IN PART, FROM IMPROPER INSTALLATION, MODIFICATION, USE OR MISUSE OF ITS PRODUCTS. PREMIER MOUNTS DISCLAIMS ALL OTHER WARRANTIES, EXPRESS OR IMPLIED, INCLUDING WARRANTIES OF MERCHANTABILITY AND FITNESS FOR A PARTICULAR PURPOSE. PREMIER MOUNTS IS NOT RESPONSIBLE FOR INCIDENTAL OR CONSEQUENTIAL DAMAGES, INCLUDING BUT NOT LIMITED TO, INABILITY TO USE ITS PRODUCTS OR LABOR COSTS FOR REMOVING AND REPLACING DEFECTIVE PRODUCTS OR PARTS. SOME STATES DO NOT ALLOW THE EXCLUSION OR LIMITATION OF INCIDENTAL OR CONSEQUENTIAL DAMAGES, SO THE ABOVE LIMITATION OR EXCLUSION MAY NOT APPLY TO YOU.

What Customers Must Do for Limited Warranty Service

If you discover a problem that you think may be covered by the warranty you MUST REPORT it in writing to the address below within thirty (30) days. Proof of purchase (an original sales receipt) from the original consumer purchaser must accompany all warranty claims. Warranty claims must also include a description of the problem, the purchaser's name, address, and telephone number. General inquiries can be addressed to Premier Mounts Customer Service at 1-800-368-9700. Warranty claims will not be accepted over the phone or by fax.

Premier Mounts
Attn: Warranty Claim
3130 East Miraloma Ave.
Anaheim, CA 92806

How State Law Applies

THIS WARRANTY GIVES YOU SPECIFIC LEGAL RIGHTS, AND YOU MAY ALSO HAVE OTHER RIGHTS WHICH VARY FROM STATE TO STATE.



205 Westwood Ave, Long Branch, NJ 07740
Phone: 866-94 BOARDS (26273) / (732)-222-1511
Fax: (732)-222-7088 | E-mail: sales@touchboards.com