

## INSTALLATION MANUAL



**UFA**  
**Universal Flat Dual Pole Arms\***

---

### NORTH AMERICA

3130 East Miraloma Avenue  
Anaheim, CA 92806 USA  
USA and Canada –  
Phone: 800-368-9700  
Fax: 800-832-4888

### EUROPE

Swallow House,  
Shilton Industrial Estate,  
Shilton, Coventry, England CV79JY  
Phone: +44 (0) 2476 614700  
Fax: +44 (0) 2476 614710

### AUSTRALIA, NEW ZEALAND, OCEANIA (DISTRIBUTOR)

P.O. Box 295  
Mordialloc Victoria 3195  
Australia  
Phone: 03 9586 6330  
[www.premiermounts.com.au](http://www.premiermounts.com.au)

Other Locations – Phone: 001.714.632.7100; Fax: 001.714.632.1044

©Premier Mounts 2007

9532-006-001-01

\* Base and Poles not included.

**Touchboards**

205 Westwood Ave, Long Branch, NJ 07740  
Phone: 866-94 BOARDS (26273) / (732)-222-1511  
Fax: (732)-222-7088 | E-mail: [sales@touchboards.com](mailto:sales@touchboards.com)



## Table of Contents

WARNING STATEMENTS ..... - 2 -  
 WARRANTY ..... - 3 -  
 PARTS LIST\* ..... - 3 -  
 INSTALLATION TOOLS ..... - 3 -  
 SUPPORT TUBE INSTALLATION ..... - 6 -  
 ATTACHING THE UPPER UFA MOUNTING BRACKET ..... - 6 -  
 INSTALLING THE DISPLAY ON THE SUPPORT TUBES ..... - 7 -  
 TECHNICAL SPECIFICATIONS ..... - 8 -

## Warning Statements

**WARNING:** PREMIER MOUNTS DOES NOT WARRANT AGAINST DAMAGE CAUSED BY THE USE OF ANY PREMIER MOUNTS PRODUCT FOR PURPOSES OTHER THAN THOSE FOR WHICH IT WAS DESIGNED OR DAMAGE CAUSED BY UNAUTHORIZED ATTACHMENTS OR MODIFICATIONS, AND IS NOT RESPONSIBLE FOR ANY DAMAGES, CLAIMS, DEMANDS, SUITS, ACTIONS OR CAUSES OF ACTION OF WHATEVER KIND RESULTING FROM, ARISING OUT OF OR IN ANY MANNER RELATING TO ANY SUCH USE, ATTACHMENTS OR MODIFICATIONS.

**WARNING:** THE FLOOR STRUCTURE MUST BE CAPABLE OF SUPPORTING AT LEAST 320 LBS. IF NOT, THE FLOOR STRUCTURE MUST BE REINFORCED. PROPER INSTALLATION PROCEDURE BY A QUALIFIED SERVICE TECHNICIAN, AS OUTLINED IN THE INSTALLATION INSTRUCTIONS, MUST BE ADHERED TO. FAILURE TO DO SO COULD RESULT IN SERIOUS PERSONAL INJURY, OR EVEN DEATH. THE MAXIMUM WEIGHT THAT CAN BE USED WITH THIS MOUNT IS 160 LBS. IF THIS WEIGHT IS EXCEEDED, DAMAGE TO THE MOUNT AND/OR UNIT MAY OCCUR.

**WARNING:** SAFETY MEASURES MUST BE PRACTICED AT ALL TIMES DURING THE ASSEMBLY OF THIS PRODUCT. USE PROPER SAFETY GEAR AND TOOLS FOR THE ASSEMBLY PROCEDURE TO PREVENT PERSONAL INJURY.

**WARNING:** PRIOR TO THE INSTALLATION OF THIS PRODUCT, THE ASSEMBLY INSTRUCTIONS SHOULD BE READ AND COMPLETELY UNDERSTOOD. THE ASSEMBLY INSTRUCTIONS MUST BE READ TO PREVENT PERSONAL INJURY AND PROPERTY DAMAGE. KEEP THESE ASSEMBLY INSTRUCTIONS IN AN EASILY ACCESSIBLE LOCATION FOR FUTURE REFERENCE.



Indicates that the power plug is to be disconnected from the power outlet.



Contact Premier Mounts with any questions.



Safety precautions must be taken at all times.



Warning and Caution statements.



Do not install on a structure that is prone to vibration, movement or chance of impact. Failure to do so could result in damage to the plasma display and/or damage to the mounting surface.



Do not install near heater, fireplace, direct sunlight, air conditioning or any other source of direct heat energy. Failure to do so may result in damage to the display and could increase the risk of fire.



At least two qualified people should perform the assembly procedure. Injury and/or damage can result from dropping or mishandling the display.



**WARNING** WHEN USING THE PSD-BWL NESTING CART, DO NOT ATTACH EQUIPMENT WEIGHING MORE THAN 75LBS. ABOVE THE 60" MARKED LINE ON THE SUPPORT POLES. DOING SO MAY CAUSE THE NESTING CART TO TIP OVER, RESULTING IN SEVERE PROPERTY DAMAGE AND/OR PERSONAL INJURY.



# Warranty

## Limited Lifetime Warranty

### **What and Who is Covered by this Limited Warranty and for How Long**

Premier Mounts warrants this product to be free from defects in material and workmanship for the lifetime of the original owner of this product. The limited warranty is only valid for the original purchaser of the product.

### **What Premier Mounts Will Do**

At the sole option of Premier Mounts, Premier Mounts will repair or replace any product or product part that is defective. If Premier Mounts chooses to replace a defective product or part, a replacement product or part will be shipped to you at no extra charge, but you must pay any labor cost.

### **What is Not Covered; Limitations**

Premier Mounts disclaims any liability for damage to mounts, adapters, displays, projectors, other property, or personal injury resulting from, in whole or in part, from improper installation, modification, use or misuse of its products. Premier Mounts disclaims all other warranties express or implied, warranties of merchantability and fitness for a particular purpose. Premier Mounts is not responsible for incidental or consequential damages, including but not limited to, inability to use its products or labor costs for removing and replacing defective products or parts. Some states do not allow the exclusion or limitation of incidental or consequential damages, so the above limitation or exclusion may not apply to you.

### **WHAT CUSTOMERS MUST DO FOR LIMITED SERVICE WARRANTY**

If you discover a problem that you think may be covered by the warranty you must report it in writing to the address below within thirty (30) days. Proof of Purchase (an original sales receipt) from the original consumer purchaser must accompany all warranty claims. Warranty claims must also include a description of the problem, the purchasers name, address, and telephone number. General inquiries may be addressed to Premier Mounts Customer Service Department at 1-800-368-9700. Warranty claims will not be accepted over the phone or by fax.

Premier Mounts  
ATTN: Warranty Claim  
3130 E. Miraloma Ave.  
Anaheim, CA 92806

### **How State Law Applies**

This warranty gives you specific legal rights, and you may also have other rights which vary from state to state.

## Parts List\*

**NOTE:** The UFA Universal Flat Dual Pole Arms are shipped with all proper installation hardware and components. Verify parts before beginning installation. If there are parts missing and/or damaged, please stop the installation and contact Premier Mounts (800-368-9700).

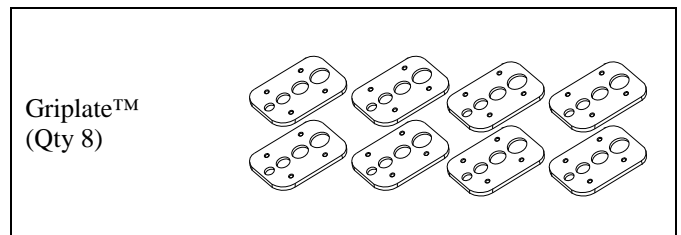

\* Parts List in continued on Page 4.

## Installation Tools

5/32" Allen Wrench (Supplied)  
Level (Supplied)

Thread Depth Indicator (Supplied)



# Mounting Hardware

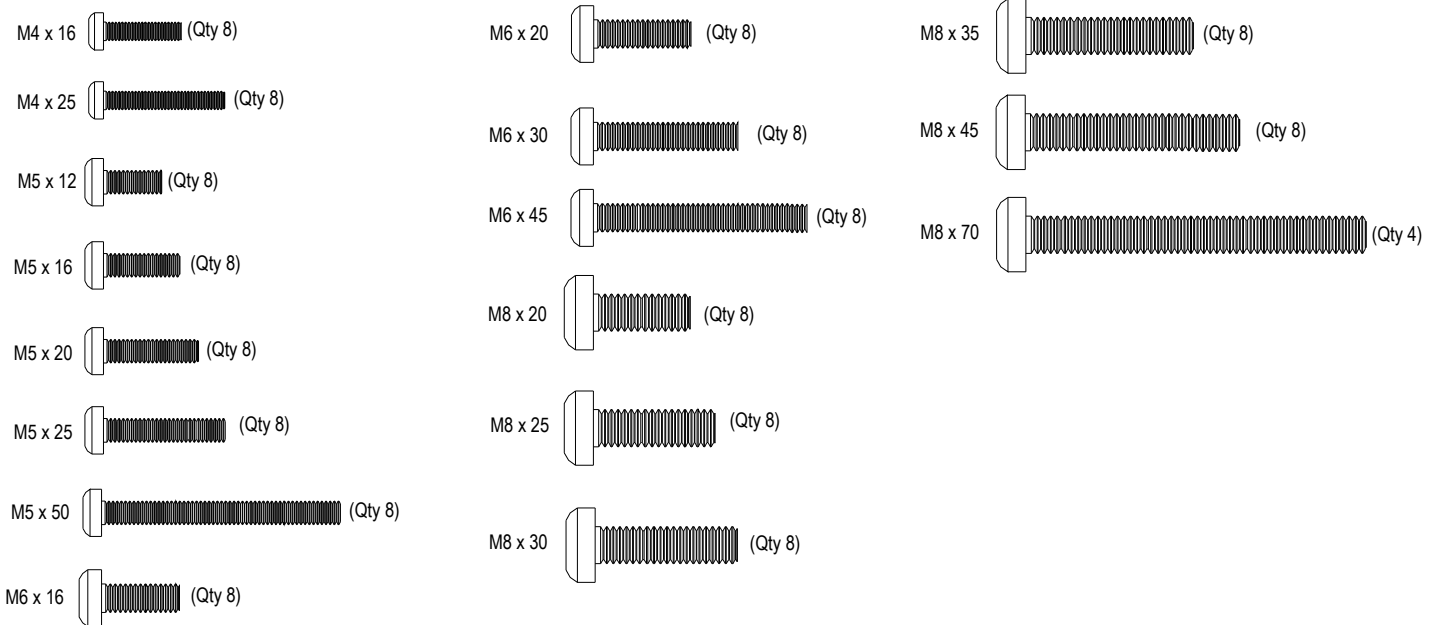

**NOTE:** The nylon spacers may be stacked to achieve proper spacing.

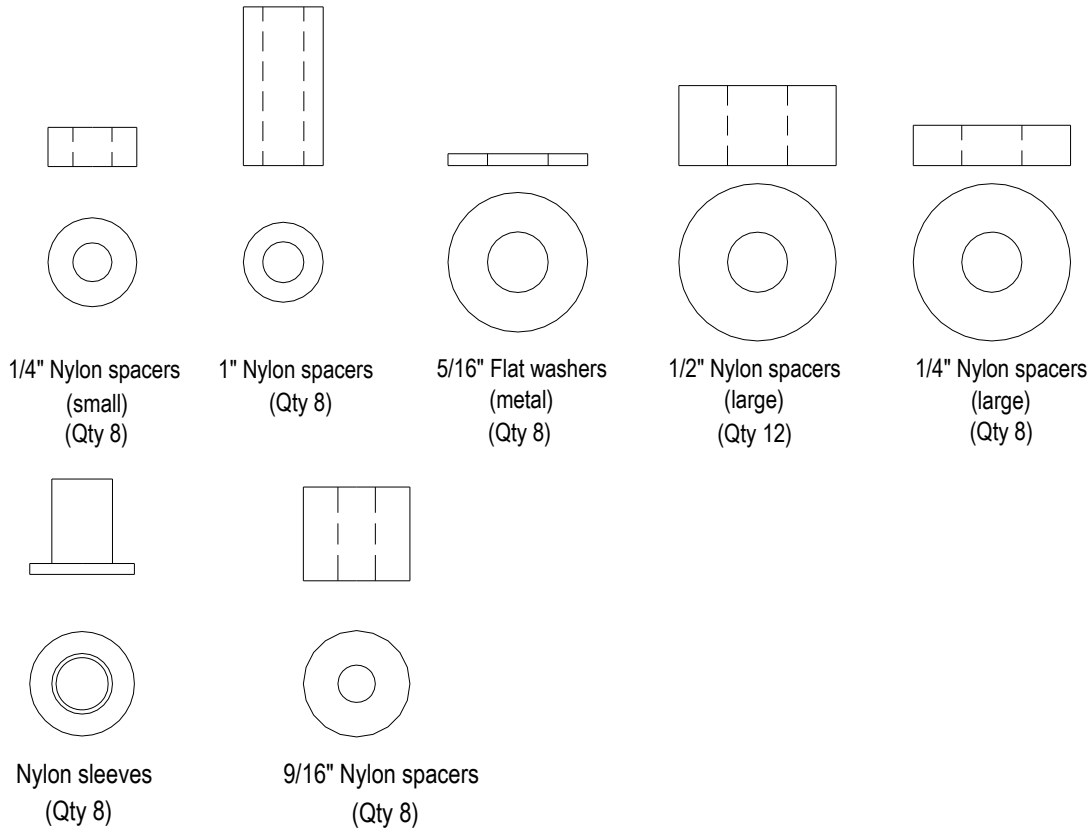



## Thread Depth Indicator

1. Insert the thread depth indicator (supplied) through the thread inserts found on the back of the flat panel to make sure the inserts measure the same full depth and mark it (Figure 1).
2. Locate the correct diameter screw for the thread insert. Compare your marking to the screws (supplied).
3. If your selected screw is longer than the marking on the thread depth indicator, **DO NOT USE** this screw.
4. The screw length must not bypass the marking. Select another screw size (Figure 2 and 3), until you find one that comes closest to your mark without going past.

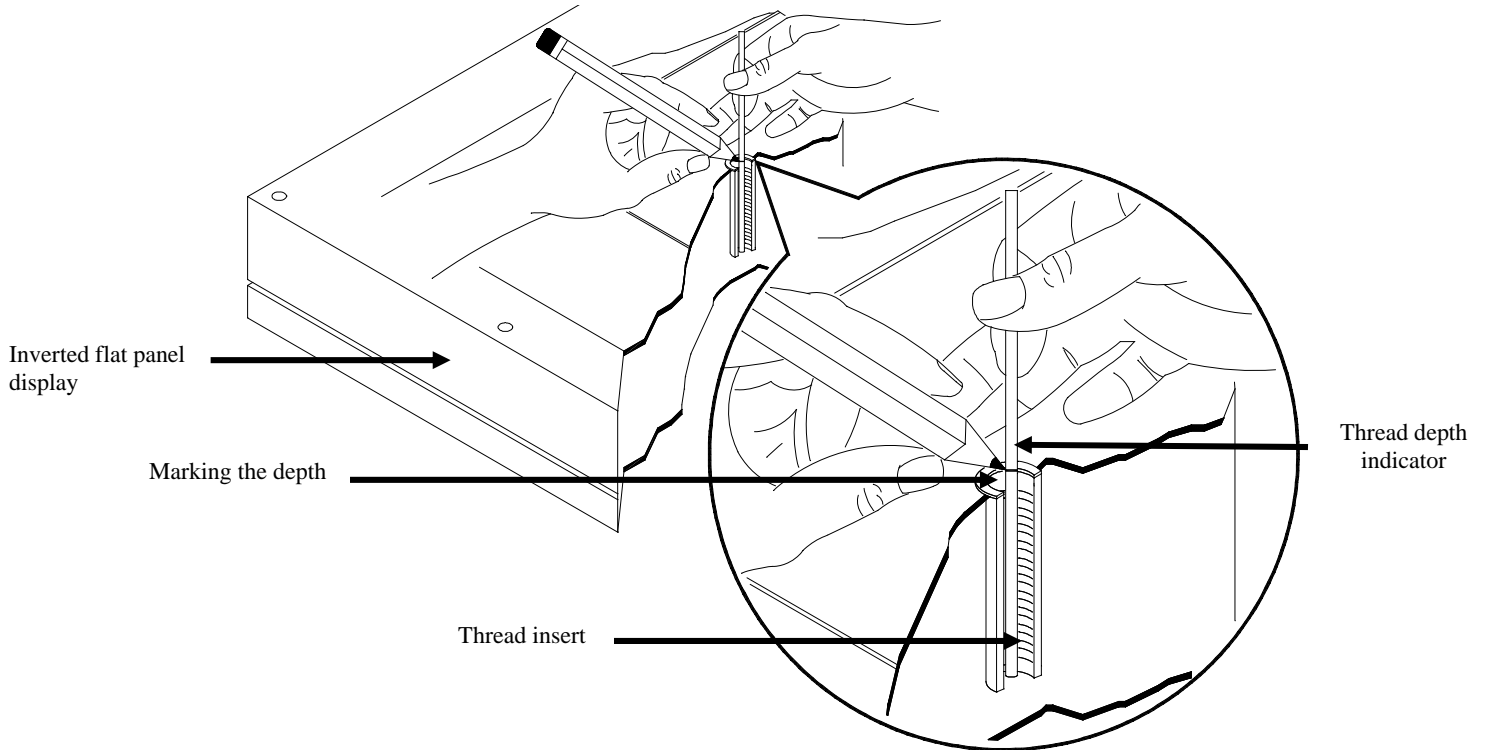

**Figure 1**

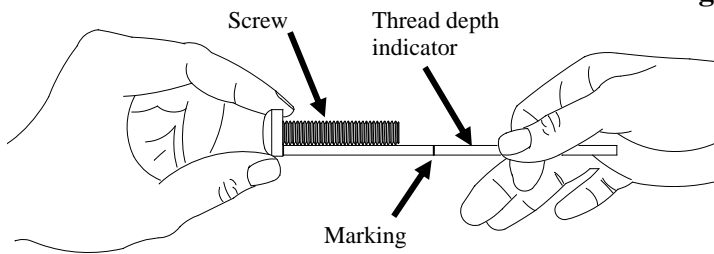

**Figure 2**

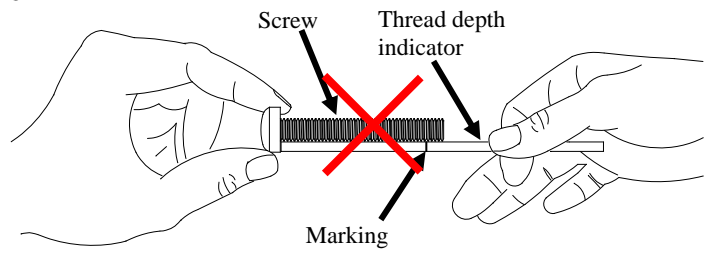

**Figure 3**



## Support Tube Installation

**NOTE:** Please refer to the base installation instructions for the assembly of the base and the support tubes. The support tubes and base must already be assembled.

**NOTE:** If the optional shelf has been purchased, the shelf must be attached prior to attaching the UFA bracket arms. Please refer to the shelf installation instructions. When working with the shelf, take precautions not to scratch it.

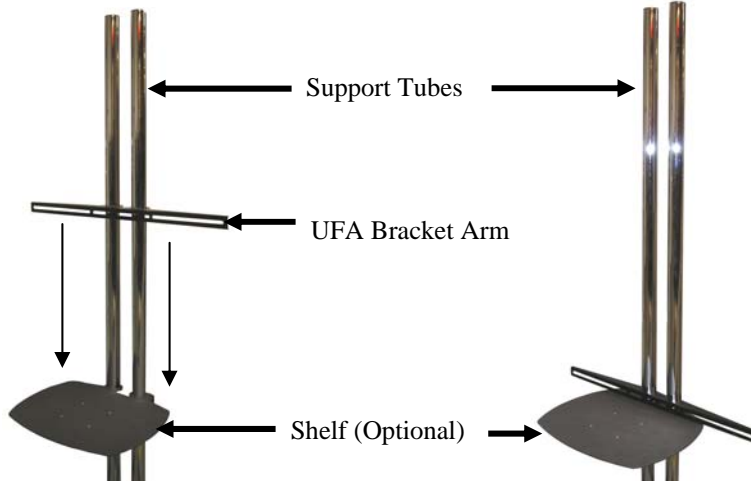

1. Slide the UFA bracket arm over and down the support tubes. This will be the lower bracket arm.

**NOTE:** The UFA lower mounting bracket can rest on the optional shelf, or base, prior to upper bracket installation.

## Attaching the Upper UFA Mounting Bracket

1. Place the display on a soft, flat surface. Locate the mounting points that are located on the back of the display.
2. Once the mounting points are located, place the upper UFA bracket arm over the mounting points.
3. Center the mounting bracket arm on the back of the display.

**NOTE:** Please refer to 'Thread Depth Indicator Use' on Page 5 to determine the correct hardware.

4. Once the desired position has been determined, place the griplates over each mounting point (flat side down) and secure them using the appropriate hardware (see Page 4).
5. At this time, center the UFA mounting bracket on the display and tighten the mounting screws.

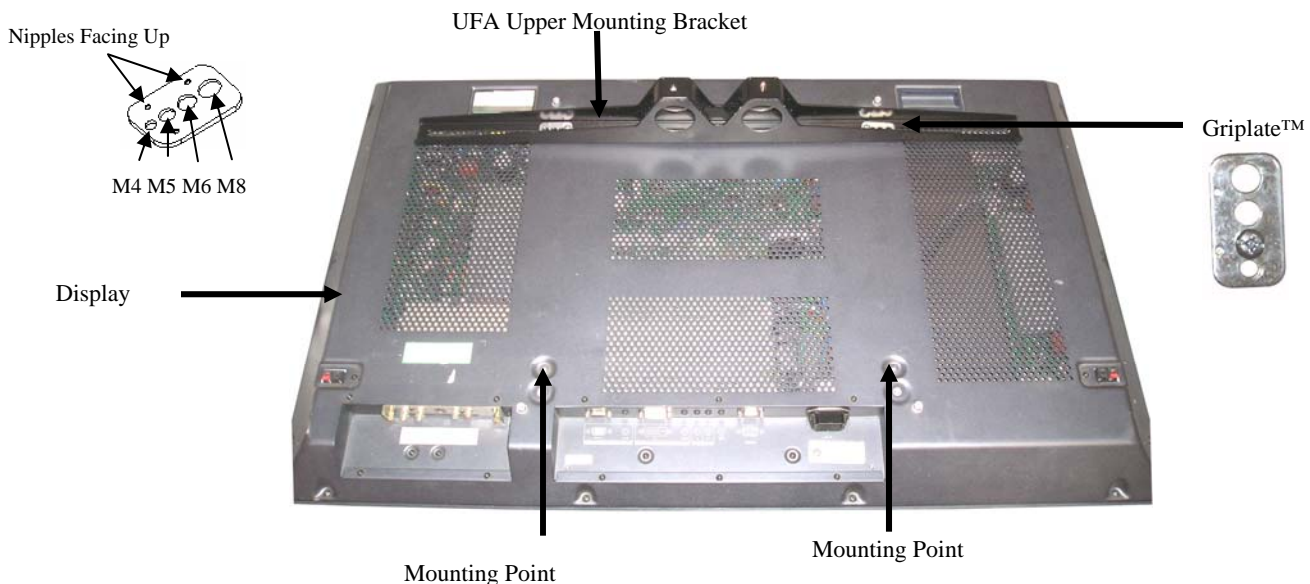



## Installing the Display on the Support Tubes

### Attaching the Upper UFA Mounting Bracket



**WARNING:**

THE FOLLOWING STEPS MUST BE PERFORMED USING THREE PEOPLE. FAILURE TO DO SO WILL RESULT IN PHYSICAL DAMAGE TO THE DISPLAY AND/OR THE PERSONNEL PERFORMING THESE STEPS.

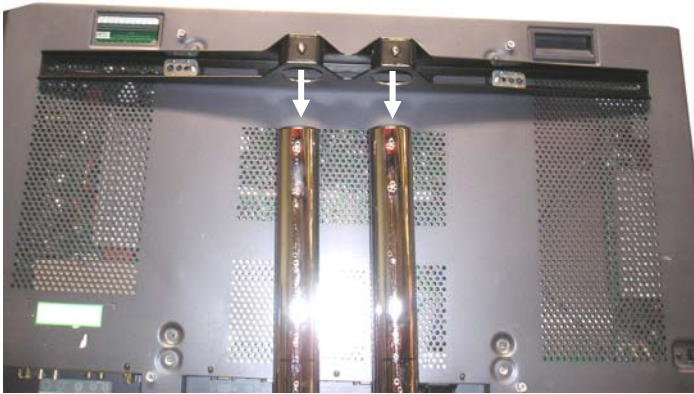

1. Two people, one on each side, must pick up the display.
2. Align the upper UFA mounting bracket above the two support tubes and lower the unit down.

**NOTE:** In some cases, the support tubes will not voluntarily align with the upper UFA mounting bracket. In these cases, the third person must squeeze, or spread, the support tubes together. When the holes and the support tubes are aligned, then lower the unit down onto the support tubes.

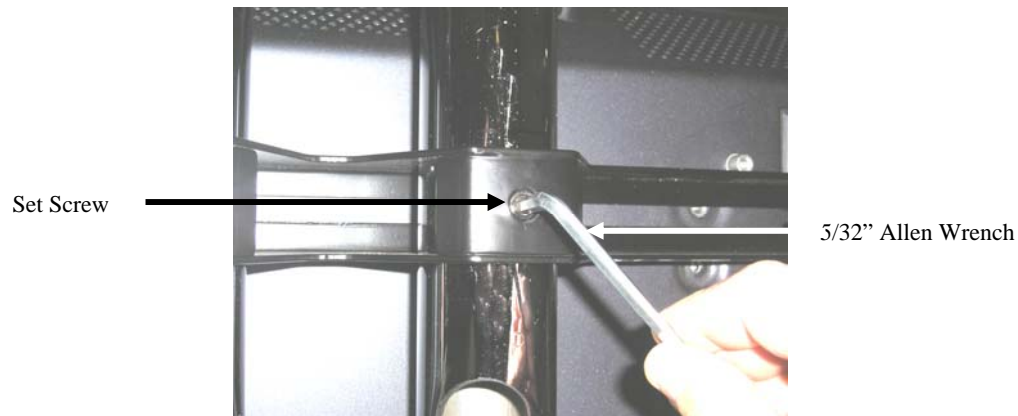

3. After the appropriate height has been determined, use the 5/32" Allen wrench (supplied) to tighten the two set screws, one of each side of the mounting bracket.



## Attaching the Lower UFA Mounting Bracket

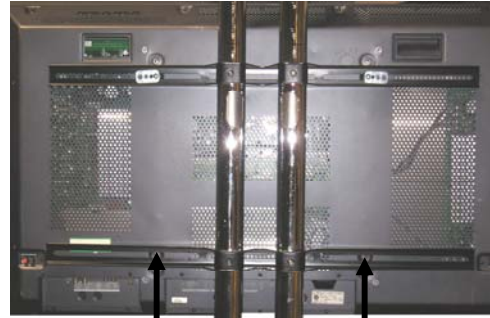

Mounting Point

Mounting Point

1. Lift the lower UFA mounting bracket up until it is even with the display.
2. Line up the lower UFA mounting bracket with the mounting points that are located on the back of the display.



3. Once the mounting points are aligned with the lower UFA mounting bracket, place a Griplate™ over each mounting point (flat side down) and secure them using the appropriate hardware (see Page 6).
4. At this time, tighten all hardware.



**WARNING:** THREE PEOPLE MUST PERFORM THE FOLLOWING STEP; TWO PEOPLE TO HOLD THE DISPLAY, AND ONE TO TIGHTEN/LOOSEN THE SET SCREWS.

5. To adjust the overall height of the unit loosen the set screws that are located on the upper and lower UFA arms. Tighten the set screws down when the adjustment is complete.

## Technical Specifications

All measurements are in inches (mm).

