



ERICSON
SAFETY

1-800-ERICSON • w

PRODUCT GUIDE



ERICSON[®]
SAFETY IS OUR STANDARD



First Logo

The Evolution of Ericson Manufacturing

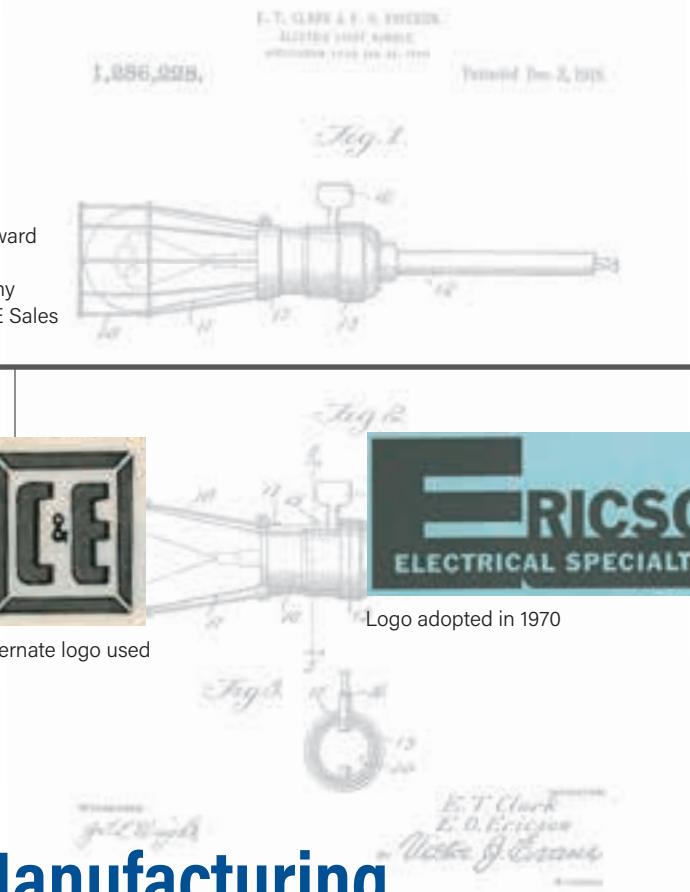

1918

With his first patent in 1918, Edward Oscar Ericson officially begins Ericson Manufacturing Company which also operates under C&E Sales



ERICSON MANUFACTURING CO. is headed by John Ericson, vice president, and his father, E. O. Ericson, president and founder. Both come up the country with portable ideas for electrical safety equipment.



Alternate logo used



Logo adopted in 1970

About Ericson Manufacturing

Celebrating 100 years of innovating electrical safety products

For over 100 years, Ericson has engineered and manufactured the safest portable power distribution and temporary lighting products on the market. Designed for superior durability and convenience, our engineered solutions offer customers the best tailor-made products to fit their specific needs. **No one does it better.**

We pride ourselves on providing distributor partners, industrial end users, and OEM customers all over the world with durable, industrial-grade products that protect the workforce from work site hazards, increase productivity, and have a lower cost of

ownership than other options on the market. Our unique array of products allows Ericson to offer our customers a comprehensive line of portable power and lighting solutions all in one place. Ericson is a customer-driven organization focused on high quality and continual improvement and we strive to meet or exceed our customer's expectations. From initial application consultation, to design and manufacturing, to product performance in the field, we aim to consistently impress.

Thank you for considering Ericson products for your company.

ERICSON™

Logo adopted by 1980

1995

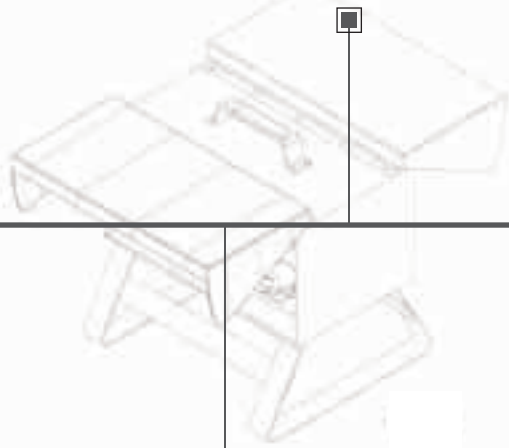

ERICSON®
ERICSON®

Alternate logos used in the 1980s

Since 1918

ERICSON®

Logo adopted in the 1990s

1980

 **ERICSON®**
SAFETY IS OUR STANDARD

Logo adopted in 2018

100
YEARS STRONG
100
ERICSON

Secondary logo adopted in 2018 for centennial anniversary

2018



Ericson Manufacturing is located 20 miles east of Cleveland, Ohio



PORTABLE POWER

Power Transformer Units (PTUs)	6-8
e-Cart™ Jr. 15-30 kVA	6
e-Cart™ 30-300 kVA	7
Auto Transformer Series: 15-300 kVA	8
e-Cart-xp™ 15-75 kVA	8
Power Distribution Units (PDUs)	10-16
Compact Distribution Box: 30-50 Amp	10
Distribution Box: 50 Amp	11
Distribution Cart: 60-200 Amp	12
Distribution Cart: 200-400 Amp	13
Portable Panelboards: 400-2000 Amp	14
Portable Transfer Switch: 400-2000 Amp	15
Portable Disconnect (Fused/Unfused): 200-3000 Amp	15
Portable Splitter: 60-1000 Amp	16
Engineered Solutions and Options	17-18
Temp Power Layout / Takeoff Services	19



e-Cart® Jr. 15-30 kVA

Power Transformer Unit

ericson.com/ecartjr

- 15 kVA models cETLus listed for U.S. and Canada
- 1Ø (15-25 kVA) or 3Ø (30 kVA) options
- Rated NEMA 3R in-use including main disconnect switch
- Combo load center with GFCI circuit protection
- Easy to move, narrow frame fits through a standard 36" doorway
- Optional 50A receptacle for connection to smaller PDUs
- Other NEMA configuration receptacles available
- Product customizations are available upon request

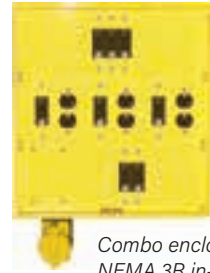

Combo enclosure style
NEMA 3R in-use



15 kVA e-Cart® Jr. frame



30 kVA e-Cart® Jr. frame

Part Number ¹	Input Power				Secondary Info		Output Connections		cETLus Listing
	Volts	Phase	Primary	Transformer Size	Secondary Voltage Out	Secondary Panel MCB ²	Receptacles	Circuit Protection	
EJR4115CL10600-UL	480V	1	6 ft. SOW Blunt	15 kVA	120/240V	N/A	(6) 5-20 T Slot GFCI DPLX	(6) 20A Breakers	Yes
EJR4115CM1061-UL	480V	1	6 ft. SOW Blunt	15 kVA	120/240V	Yes	(6) 5-20 T Slot GFCI DPLX & (1) CS6369 50A	50A 2P C.B. (6) 20A Breakers	Yes
EJR4315CL30600-UL	480V	3	6 ft. SOW Blunt	15 kVA	120Y208V	N/A	(6) 5-20 T Slot GFCI DPLX	(6) 20A Breakers	Yes
EJR4315CM30310-UL	480V	3	6 ft. SOW Blunt	15 kVA	120Y208V	Yes	(3) 5-20 T Slot GFCI DPLX & (1) CS6369 50A ³	(3) 20A Breakers & (1) 50A 2P C.B.	Yes
EJR4315CM3061-UL	480V	3	6 ft. SOW Blunt	15 kVA	120Y208V	Yes	(6) 5-20 T Slot GFCI DPLX & (1) CS6369 50A ³	(6) 20A Breakers & (1) 50A 2P C.B.	Yes
EJR4315CM31200-UL	480V	3	6 ft. SOW Blunt	15 kVA	120Y208V	Yes	(12) 5-20 T Slot GFCI	(12) 20A GFCI C.B.	Yes
EJR24330CL3120	480V	3	6 ft. SOW Blunt	30 kVA	120Y208V	N/A	(12) 5-20 T Slot GFCI DPLX	(12) 20A Breakers	Pending
EJR24330CL3061	480V	3	6 ft. SOW Blunt	30 kVA	120Y208V	N/A	(6) 5-20 T Slot GFCI DPLX & (1) CS6369 50A	(6) 20A Breakers & (1) 50A 2P C.B.	Pending

¹ - Change 4 to 6 for 600V Input ² - Main Circuit Breaker ³ - 30A max available

e-Cart® 30-300 kVA

Power Transformer Unit

ericson.com/ecart

- cETLus listed for U.S. and Canada
- Industrial duty aluminum frame with lifting eyes, wheels or stands
- 1Ø or 3Ø NEMA 3R 480V or 600V 60Hz ventilated transformer
- NEMA 3R load center with GFCI protection installed, sized per transformer
- NEMA 3R fused primary disconnect, sized per transformer
- Easy to move, narrow frame fits through a standard 36" doorway
- Choice of solid 10" rubber tires, (2 steering with brakes, 2 fixed) or stationary legs
- Other NEMA configuration receptacles available, combo enclosure styles are customizable (see examples below)
- Product customizations are available upon request



Standard 45 kVA e-Cart® frame with fork tubes & optional handles



300 kVA e-Cart® frame

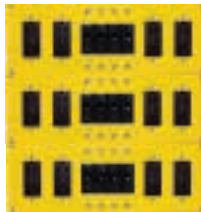

CL3120

Part Number ¹	Input Power			Secondary Info			Output Connections		cETLus Listing
	Volts	Phase	Primary	Transformer Size	Secondary Voltage Out	Secondary Panel MCB ²	Receptacles	Circuit Protection	
EC2SSH41025XXCM1100	480V	1	6 ft. SOOW Blunt	25 kVA	120/240V	Yes	(10) NEMA 5-20 T-Slot Duplexes	(10) 1P 20A GFCI C.B. & 100A MCB	Yes
EC2SSH41037XXCL1101	480V	1	6 ft. Type-W Blunt	37.5 kVA	120/240V	No	(10) 5-20 T Slot Duplexes & (1) CS6369 50A	(10) 1P 20A GFCI C.B. & (1) 2P 50A C.B.	Yes
EC2SSH43030XXCL3120	480V	3	6 ft. SOOW Blunt	30 kVA	120Y208V	No	(12) 5-20 T Slot GFCI DPLX	(12) 20A C.B.	Yes
EC2SSH43045XXCL3121	480V	3	6 ft. Type-W Blunt	45 kVA	120Y208V	No	(12) 5-20 T Slot Duplexes & (1) CS6369 50A	(12) 20A GFCI C.B. & (1) 50A 2P C.B.	Yes
EC2HSX43075XXCL3063	480V	3	6 ft. Type-W Blunt	75 kVA	120Y208V	No	(6) 5-20 T Slot Duplexes & (3) CS6369 50A	(6) 20A GFCI C.B. & (3) 50A 2P C.B.	Yes

1) Change 4 to 6 for 600V Input

2) Main Circuit Breaker



e-Cart® 15-300 kVA

Auto Transformer Unit

ericson.com/ecartauto

- kVA range: 15 kVA to 300 kVA
- Primary voltage: 600V or 480V
- Secondary voltage: 480V or 600V
- Hardwire and/or camlock cable connections
- Protective frames
- Crane, forklift, and/or pallet jack lifting points
- NEMA 3R rated
- Product customizations are available upon request



30 kVA ATU

e-Cart®-XP 15-75 kVA

Explosion Proof Power Transformer Unit

ericson.com/ecartxp

- Class I, Div. 2, Groups C and D certified
- NEMA 3R rated
- Heavy duty, light weight, spark resistant aluminum frame
- NEMA 3R fused primary disconnect, sized per transformer
- Easy to move, narrow frame fits through a standard 36" doorway
- Choice of 4 solid 10" rubber tires, (2 steering with brakes and 2 fixed) or stationary legs
- Other NEMA configuration receptacles available
- cCSAus factory certification available
- Product customizations are available upon request



45 kVA e-Cart®-XP frame

Part Number ¹	Input Power				Secondary Info		Output Connections	
	Volts	Phase	Primary	Transformer Size	Secondary Voltage Out	Secondary Panel MCB ²	Receptacles	Circuit Protection
EC2XPSSX43015XXCL3060	480V	3	6 ft. SOOW Blunt	15 kVA	120Y208V	No	(6) NEMA 5-20 w/ flip covers	(6) 20A GFCI C.B.
EC2XPSSX41025XXCL3100	480V	1	6 ft. SOOW Blunt	25 kVA	120/240V	No	(10) NEMA 5-20 w/ flip covers	(10) 20A GFCI C.B.
EC2XPSSX43030XXCL3120	480V	3	6 ft. SOOW Blunt	30 kVA	120Y208V	No	(12) NEMA 5-20 w/ flip covers	(12) 20A GFCI C.B.
EC2XPSSX43045XXCL3180	480V	3	6 ft. Type-W Blunt	45 kVA	120Y208V	No	(18) NEMA 5-20 w/ flip covers	(18) 20A GFCI C.B.

1) Change 4 to 6 for 600V Input



30-50 Amp

Compact Distribution Box

ericson.com/compact

- cETLus listed for U.S. and Canada
- 50A input power
- NEMA 3R in-use
- Simplified handling, one hand carry
- Reduced operational footprint
- Anti-nuisance tripping design
- Less maintenance vs. traditional 30-50A PDUs
- Multiple panel configurations available
- Multiple units are stackable
- Patented enclosure design
- Patented open neutral protection
- Product customizations are available upon request



GWO

Input panel



Output panel



50 Amp Y adapter
63YSTW



50 Amp cordsets
63DSO (100ft)
63BSO (50ft)

Part Number	Electrical Rating	Input Connector	Breakers / Receptacles	240V Single Receptacle	240V GFCI Protection	240V Overload Protection	Daisy Chain Feed-thru
GWO	50 Amp 125/250 V	CS6375	(6) 20A Circuit Breaker (6) NEMA 5-20 GFCI Duplex	NEMA L6-30	No	30A Circuit Breaker	CS6369
GWO-A	50 Amp 125/250 V	CS6375	(6) 20A GFCI Circuit Breaker (6) NEMA L5-20	NEMA L6-30	No	30A Circuit Breaker	CS6369
GWO-B	50 Amp 125/250 V	CS6375	(6) 20A Circuit Breaker (6) NEMA 5-20 GFCI Duplex	NEMA L6-30	Yes	30A Circuit Breaker	CS6369
GWO-30A	30 Amp 125/250 V	L14-30	(6) 20A Circuit Breaker (6) NEMA 5-20 GFCI Duplex	NEMA L14-30	No	30A Circuit Breaker	see below ¹

¹ - 30A single receptacle is the feed-thru on the 30A GWO-30A unit
All 20A circuits include open-neutral relay protection U.S. Patented (US9,001,477 B2)

50 Amp

Distribution Box

ericson.com/pdu50

- cETLus listed for U.S. and Canada
- CS6375 twistlock 50A, 125/250V power inlet
- Each 20A outlet is individually GFCI protected
- CS6369 50A, 125/250V power outlet - daisy chain 2 boxes together
- Watertight NEMA 3R flip covers included
- Product customizations are available upon request



1067-LC



1066FS

Part Number	Electrical Rating	Input Connector	Breakers / Receptacles	240V Single Receptacle	240V GFCI Protection	240V Overload Protection	Daisy Chain Feed-thru
1066FS	50 Amp 125/250 V	4W CS6375-F	(6) 20A Circuit Breaker (6) NEMA 5-20 Duplex (6) 1075-AR GFCI	NEMA L6-30	No	30A 2P C.B.	CS6369
1066-BFS	50 Amp 125/250 V	4W CS6375-F	(6) 20A Circuit Breaker (6) NEMA 5-20 Duplex (6) 1075-AR GFCI	NEMA L6-30	Yes	30A 2P C.B.	CS6369
1067-LC	50 Amp 125/250 V	4W CS6375-F	(6) 20A Circuit Breaker (6) NEMA L5-20R Single (6) 1075-AR GFCI	NEMA L6-30	No	30A 2P C.B.	CS6369
1067-ALC	50 Amp 125/250 V	4W CS6375-F	(6) 20A Circuit Braker (6) NEMA L5-20R Single (6) 1075-AR GFCI	NEMA L6-30	No	30A 2P C.B.	CS6369



ericson.com
ericson.com/rfq

1.800.ERICSON
1.800.374.2766



Portable Power

11

60-200 Amp

Distribution Cart

ericson.com/pdu60

- Select models cETLus listed for U.S. and Canada
- Up to 200 Amp capacity
 - Feed-thru units (CAM2 Models) are rated 400 Amp w/ CAM set
- 120Y208V, 120/240V, 480V or 600V
- 1Ø and 3Ø options
- NEMA 3R in-use
- Product customizations are available upon request



Camlock input connections on rear panel makes hookup easy and efficient

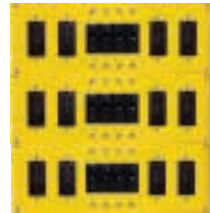

CL3120

Part Number	Input Power				Output Connections
	Male Inlet Type	Phase	Volts	Female Mains Feed-thru	Recptacles and Circuit Protection
BE1-T50CM1080	CS6375 Twist-lock	1	120/240V	CS6369 Twist-lock	(8) NEMA 5-20 T Slot GFCI Duplex, (8) 20A C.B.
BE1-CAMCL1061	CAM Set (4)	1	120/240V	N/A	(6) NEMA 5-20 T Slot Duplex (1) CS6369 - 50A C.B. (6) GFCI C.B.
BE1-CAMCL1120	CAM Set (4)	1	120/240V	N/A	(12) NEMA 5-20 T Slot GFCI Duplex, (12) 20A C.B.
BE1-CAMCL1160	CAM Set (4)	1	120/240V	N/A	(16) NEMA 5-20 T Slot GFCI Duplex, (16) 20A C.B.
BE1-CAMCL3006 ¹	CAM Set (5)	3	120Y208V	N/A	(6) CS6369 - 50A C.B.
BE1-CAMCL3062-1	CAM Set (5)	3	120Y208V	N/A	(6) NEMA 5-20 T Slot Duplex (2) CS6369 - 50A C.B. (6) GFCI C.B.
BE1-CAMCL3120	CAM Set (5)	3	120Y208V	N/A	(12) NEMA 5-20 T Slot GFCI Duplex, (12) 20A C.B.
BE1-CAM2CL3006 ¹	CAM Set (5)	3	120Y208V	CAM Set (5)	(6) CS6369 - 50A C.B.

1) 50 Amp PDU Feeder Design

200-400 Amp

Distribution Cart

ericson.com/pdu200

- cETLus listed for U.S. and Canada
- Optional 200A and 400A (main lug only)
- 120Y208V, 120/240V, 480V or 600V
- 1Ø and 3Ø options
- Combo load center with GFCI circuit protection
- Camlock and terminal lug options
- 24 poles available in breaker panels
- All-weather access clearance
- Main circuit breaker up to 200A
- Product customizations are available upon request



Part Number ¹	Volts	Phase	Amperage	Main Feed-thru	Receptacles
OPC-01-120-200-LBLN-14150250-X	120/240V	1	200 Amps	No	(14) NEMA 5-15 GFCI Duplex (2) CS6369 50A
OPC-03-208-200-LBLN-12150350-X	120Y208V	3	200 Amps	No	(12) NEMA 5-15 GFCI Duplex (3) CS6369 50A
OPC-01-120-200-LBLN-121502300250-X	120/240V	1	200 Amps	No	(12) NEMA 5-15 GFCI Duplex (2) NEMA L6-30 (2) CS6369
OPC-03-208-200-LBLN-101503300350-X	120Y208V	3	200 Amps	No	(10) NEMA 5-15 GFCI Duplex (3) NEMA L6-30 (3) CS6369

¹ - (-X) use C for Canada only models, use U for U.S. models only



400-2000 Amp

Portable Panelboards

ericson.com/panelboard

Equipment specification range may include:

- Various Panelboard options from Schneider (I-Line™), Eaton (Pow-R-Line), Siemens (P Series) or GE (A or Spectra™)¹
- Voltage range: 120V to 600V
- Breaker amperage range: 15A to 2000A (adjustable trip settings)
- Customizable breaker configurations
- Hardwire and/or camlock cable connections
- Protective frames
- Crane, forklift, and/or pallet jack lifting points
- NEMA 3R rated
- Product customizations are available upon request



800 Amp PDU



400 Amp PDU

¹- All trademarks and registered trademarks are the property of their respective owners.

400-2000 Amp

Portable Transfer Switch

ericson.com/switch

Equipment specification range may include:

- 1Ø Voltage: 120/240V
- 3Ø Voltage range: 120Y208V, 277Y480V and 347Y600V
- Ampacity range: 400A to 2000A
- Manual and automatic options
- Hardwire and/or camlock cable connections
- Protective frames
- Crane, forklift and pallet jack lifting points
- NEMA 3R rated
- Product customizations are available upon request



400 Amp PATS

200-3000 Amp

Portable Disconnect (Fused or Unfused)

ericson.com/disconnect

Equipment specification range may include:

- Rated up to 600V
- Ampacity range: 200A to 3000A
- Adjustable trip settings available
- Hardwire and/or camlock cable connections
- Protective frames
- Crane, forklift and/or pallet jack lifting points
- NEMA 3R rated
- Product customizations are available upon request



1200 Amp PDU



ericson.com
ericson.com/rfq

1.800.ERICSON
1.800.374.2766



60-1000 Amp

Portable Splitter

ericson.com/splitter

Equipment specification range may include:

- Rated Up to 600V
- Ampacity range: up to 1000A
- Hardwire and/or camlock cable connections
- Protective frames
- Crane, forklift and pallet jack lifting points
- NEMA 3R rated
- Product customizations are available upon request



*60 Amp PDU
Welding Cart*

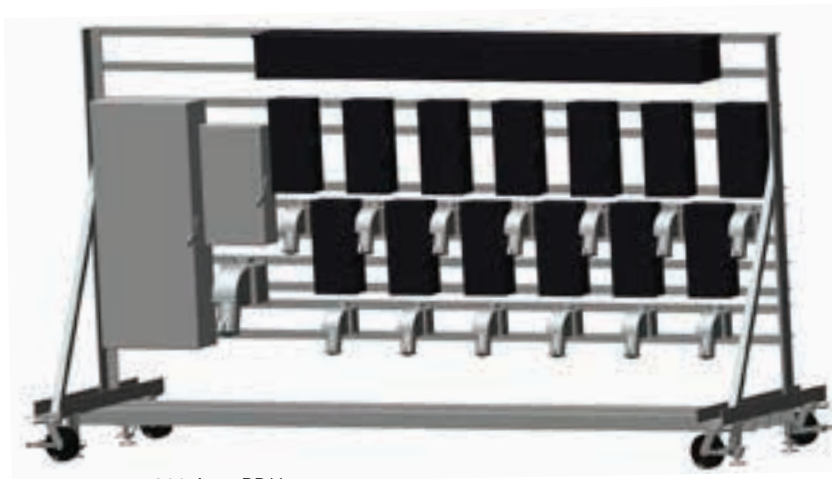

*800 Amp PDU
Mobile Switch Rack*

Engineered Solutions

ericson.com/engineered-solutions



*e-Cart™ "Bus Stop"
Switch Rack*



e-Cart™ Jr. Wall Mount PTU



Stainless Steel Panel PDU



*Custom Distribution Enclosure
for Genset Trailer*



e-Cart-XP™ Custom Trailer PTU



ericson.com
ericson.com/rfq

1.800.ERICSON
1.800.374.2766



Portable Power

17

Portable Power Options

Frame/Cart Options

Material

Aluminum
Steel
Stainless steel equipment

Finish

A Powder coat in any color
Multi or single color Mylar or Vinyl labels

Other Accessories

B Mounting pads and jack stands
C Cable management hooks
Stainless steel outconn enclosure

Power Unit Options

Other Accessories

D Watt meter field kit
Remote circuit switch
E Transformer voltage selector switch

Power Unit Attachment Options

Other Accessories

RFID tagging system
Cables reels
Telescoping or mounted light fixtures
Power supply & interconnecting cables

A



B



C



D



E



Temp Power Layout / Takeoff Services

Contact us for a complementary estimate

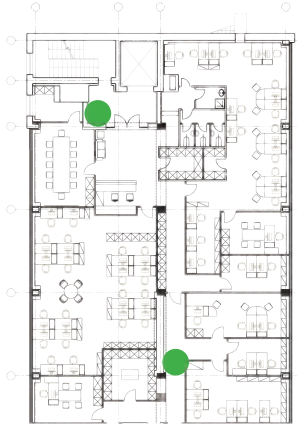
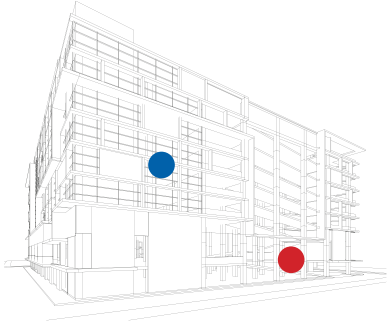

Portable/Temp Power Layout

Project Title

Product A

Product B

Product C

Ericson Manufacturing Portable Power Layout Estimate

Representation only

Upload your project documents
and drawings at ericson.com/layout >>



ericson.com
ericson.com/rfq

1.800.ERICSON
1.800.374.2766



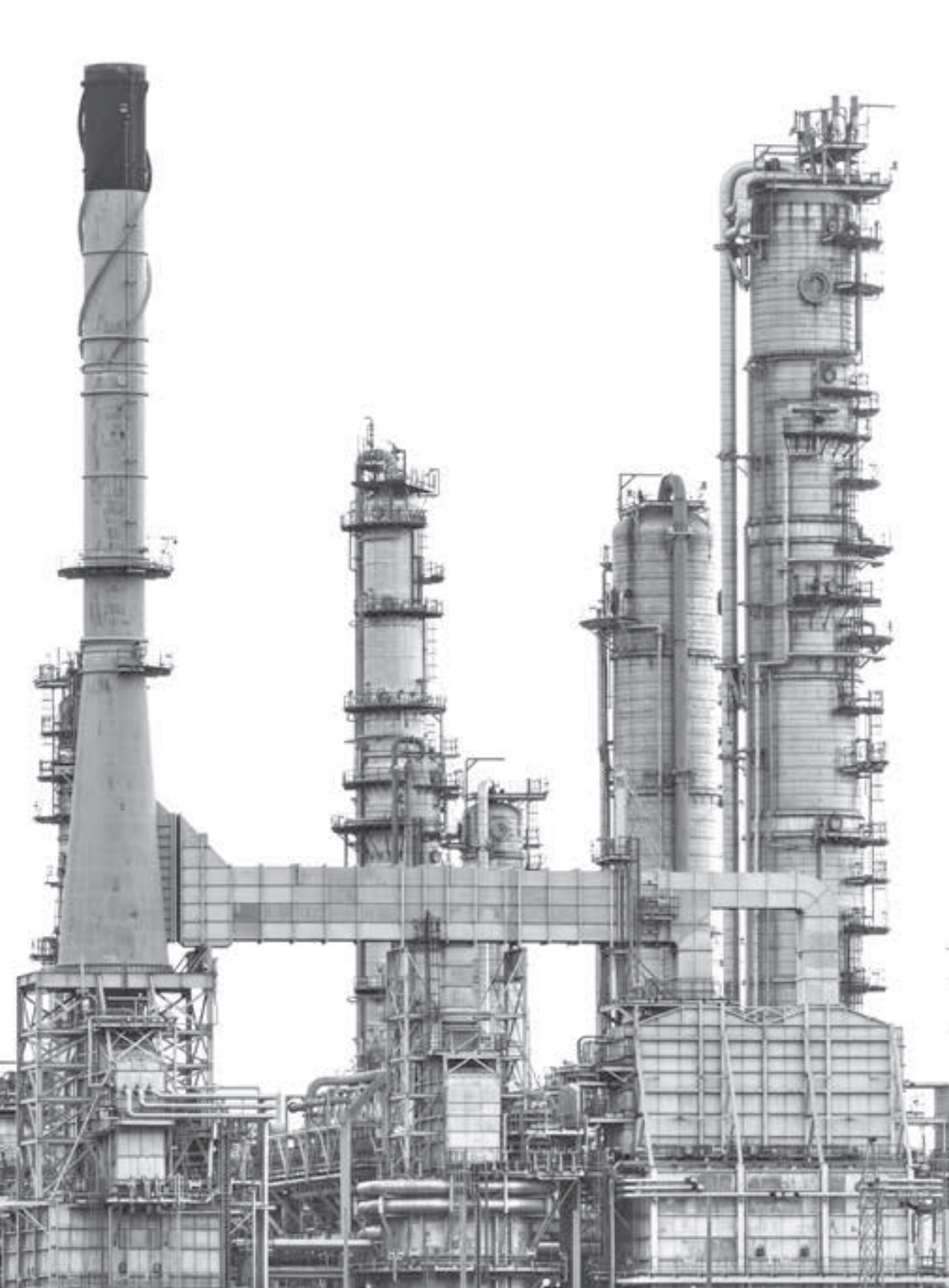

WIRING DEVICES & CORDSETS

Wiring Devices	22-30
Commercial Grade	22
Industrial Grade	22-23
Extreme Duty, Watertight	23
Smart Monitor™	24
Antimicrobial, Watertight	25
NEMA Configuration Selection Guide	26
Wiring Device Selection Guide	27
Competitor Cross Reference	28-29
Receptacles & Flip Covers	30
Outlet Boxes	31-33
6000 Series Outlet Boxes–Single Gang	31
6100 Series Outlet Boxes–Single Gang	32
8000 Series Outlet Boxes–Double Gang	33
Wire Mesh Grips	34
Power Drops & Cordsets	35-39
Power Drops	35
Power Supply Cables	36
Power & Receptacle Stringers	37
Cordsets	38-39
GFCIs	40-41
GFCIs–In-line	40
1075 Series Panel Mount GFCI	41
1060 Series Multiple Outlet GFCI	41



Economy Grade

Commercial Grade Wiring Devices

ericson.com/economywd

E515-PL, E515-CL

- cULus listed for U.S. and Canada
- Body and shell are thermoplastic nylon
- Strain relief clamps furnished with removable inserts to accommodate varying cable diameters
- Designed for indoor use and dry locations
- Operating temperature range -40°C to 70°C
- Select models lighted to provide power-on indication



E515-PL



E515-CL



Power indication light

5266-EL 5269-EL

- cETLus listed for U.S. and Canada
- Commercial grade, indoor rated wiring device with power indication light
- 1-piece, open suitcase design for easy installation
- Fits cord diameters from 10/3 to 18/3
- Clear internal conductor cover allows visual inspection



5266-EL



5269-EL



1-piece "open suitcase" design

ECONOMY GRADE

Perma-Link®

Industrial Grade Wiring Devices

ericson.com/industrialwd

- UL listed and CSA certified
- Industrial grade, indoor rated cord clamp wiring devices
- Withstands high impact, corrosion, oils, greases, solvents and other chemicals across -20° C to 100° C
- Internal cord seal keeps out dust, dirt and mud
- Available individually or on factory assembled cordsets
- Plug and connector covers may be interchanged for a weather resistant connection
- Available in multiple NEMA configurations



Cord clamp style



PERMA-LINK®

Perma-Grip™

Industrial Grade Wiring Devices

ericson.com/industrialwd

- UL listed and CSA certified
- Industrial grade, indoor rated cord grip wiring devices
- Quick field assembly, no cable clamp screws to tighten
- Cord grip won't pinch cable like standard clamps thus providing longer use and less cable replacement
- Compression cord grips and sealing grommets included
- Withstands high impact, corrosion, oils, greases, solvents and other chemicals across -20° C to 100° C
- Available individually or on factory assembled cordsets
- Plug and connector covers may be interchanged for a weather resistant connection
- Available in multiple NEMA configurations



PERMA GRIP™

Small size grommets - 15-20 Amp models*



Large size grommets - 30 Amp models*



Perma-Tite®

Extreme Duty, Watertight Wiring Devices

ericson.com/watertightwd

- UL listed and CSA certified
- Extreme industrial duty, outdoor rated, watertight wiring devices
- Double tongue & groove sealing system provides environmental protection of NEMA Type 4, 4X, 6, 6P & IP67
- Devices resist high-pressure hose down of 1,000 psi
- Plug & connector bodies made with PBT chosen for its high resistance to moisture absorption, high voltage arcing and carbon tracking
- Removable/replaceable self-retained sealing cap provided with connector to keep out contaminants when not in use
- Available in multiple NEMA configurations

*Each device includes a set of grommets to accommodate a range of cable sizes



PERMA TITE®



ericson.com
ericson.com/rfq

1.800.ERICSON
1.800.374.2766



SmartMonitor®

Visual Diagnostic Wiring Devices

ericson.com/monitor

- cETLus listed for U.S. and Canada
- Available in Perma-Link®, Perma-Grip®, and Perma-Tite® models
- 24/7 diagnostic technology with LED indicator
- Makes OSHA Assured Equipment Grounding Conductor Program compliance quick and cost effective
- Monitors 7 conditions including ground continuity, reverse polarity, hot on ground, and open neutral conditions
- Blue LED light indicates a proper wiring connection, a red LED light indicates a faulty wiring connection
- Available in multiple NEMA configurations



*Perma-Link®
Cord clamp style*



*Perma-Tite®
Watertight style*



*Perma-Grip™
Cord grip style*

Perma-Kleen™

Antimicrobial Watertight Wiring Devices

ericson.com/kleen

- UL listed and CSA certified
- Antimicrobial additives embedded in polymer
- Inhibits growth of bacteria, molds, mildews and fungi
- Antimicrobial additive resistant to scuffing and cleaning
- Independently tested and certified
- Double tongue & groove sealing system provides environmental protection of NEMA Type 4, 4X, 6, 6P & IP67
- Devices resist high-pressure hose down of 1,000 psi
- Available in multiple NEMA configurations



Escherichia (E. coli) - Log Reduction > 4.8, reduces surface bacteria by > 99.99%

Staphylococcus (Staph), MRSA - Log Reduction > 3.9, reduces surface bacteria by > 99.98%

Listeria monocytogenes - Log Reduction > 4.3, reduces surface bacteria by > 99.99%

Salmonella - Log Reduction > 3.6, reduces surface bacteria by > 99.97%



Untreated *E. coli* after 24 hours



Treated *E. coli* after 24 hours

PERMAKLEEN®















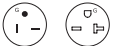









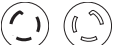

ericson.com
ericson.com/rfq

1.800.ERICSON
1.800.374.2766



Ericson Wiring Device Selection Guide

See page 28-29 for cross reference resources

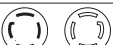
	Face View	NEMA Configuration	Electrical Rating		Base Model	
			Amps	Voltage	Plug	Connector
2-pole, 3-wire		NEMA 5-15	15A	125V	1510-P	1610-C
		NEMA 5-20	20A	125V	1512-P	1612-C
		NEMA 6-15	15A	250V	1514-P	1614-C
		NEMA 6-20	20A	250V	1516-P	1616-C
		NEMA L5-15	15A	125V	1520-P	1620-C
		NEMA L6-15	15A	250V	1522-P	1622-C
		NEMA L7-15	15A	277V	1524-P	1624-C
		NEMA L5-20	20A	125V	2310-P	2410-C
		NEMA L6-20	20A	250V	2312-P	2412-C
		NEMA L7-20	20A	277V	2314-P	2414-C
3-pole, 3-wire		Non-NEMA ¹	20A	125 / 250V	2316-P	2416-C
		Non-NEMA ¹	20 / 10A	250 / 600V	2317-P	2417-C
		Non-NEMA ¹	15 / 10A	125 / 250V	1507-P	1607-C
		Non-NEMA ^{1,2}	30A	125 / 250V	2516-P	2616-C
3-pole, 4-wire ²		NEMA L14-20	20A	125 / 250V	2320-P	2420-C
		NEMA L15-20	20A	250V / 3Ø	2322-P	2422-C
		NEMA L16-20	20A	480V / 3Ø	2324-P	2424-C
2-pole, 3-wire		NEMA L5-30	30A	125V	2510-P	2610-C
		NEMA L6-30	30A	250V	2512-P	2612-C
		NEMA L7-30	30A	277V	2514-P	2614-C
3-pole, 4-wire ²		NEMA L14-30	30A	125 / 250V 3Ø	2520-P	2620-C
		NEMA L15-30	30A	250V / 3Ø	2522-P	2622-C
		NEMA L16-30	30A	480V / 3Ø	2524-P	2624-C
		NEMA L17-30	30A	600V / 3Ø	2526-P	2626-C
4-pole 4-wire		NEMA L18-30	30A	120/208V 3Ø wye	2530-P	2630-C
		Non-NEMA ^{1,2}	30A	120/208V 3Ø wye	2528-P	2628-C

¹ - All non-NEMA configurations are non-grounding

² - Not available in Perma-Grip style



Perma-Link®

1510-P

1610-C

Base Model



Perma-Grip™

1510-PG

1610-CG



Perma-Tite®

1510-PW6P

1610-CW6P



Perma-Kleen™

Perma-Tite®

1510-PW6P-AM

1610-CW6P-AM

SmartMonitor®



Perma-Link®

1510-PML

1610-CML



Perma-Grip™

1510-PMGL

1610-CMGL





































Perma-Tite®

1510-PW6PL









1610-CW6PL



Perma-Link® Cross Reference

Competitor Part Number	Molex New Part Number	Ericson Part Number	Ericson Part Description
1447	130141-0015	1510-P	 Plug, NEMA 5-15P, 15A-125V
1547	130141-0031	1610-C	 Connector, NEMA 5-15R, 15A-125V
1433	130141-0010	1512-P	 Plug, NEMA 5-20P, 20A-125V
1533	130141-0025	1612-C	 Connector, NEMA 5-20R, 20A-125V
1449	130141-0022	1514-P	 Plug, NEMA 6-15P, 15A-250V
1549	130141-0038	1614-C	 Connector, NEMA 6-15R, 15A-250V
1448	130141-0020	1516-P	 Plug, NEMA 6-20P, 20A-250V
1548	130141-0036	1616-C	 Connector, NEMA 6-20R, 20A-250V
2447	130141-0047	1520-P	 Plug, NEMA L5-15P, 15A-125V
2547	130141-0056	1620-C	 Connector, NEMA L5-15R, 15A-125V
2449	130141-0051	1522-P	 Plug, NEMA L6-15P, 15A-250V
2549	130141-0060	1622-C	 Connector, NEMA L6-15R, 15A-250V
2434	130141-0045	1524-P	 Plug, NEMA L7-15P, 15A-277V
2534	130141-0054	1624-C	 Connector, NEMA L7-15R, 15A-277V
2647	130141-0062	2310-P	 Plug, NEMA L5-20P, 20A-125V
2747	130142-0021	2410-C	 Connector, NEMA L5-20R, 20A-125V
2648	130141-0063	2312-P	 Plug, NEMA L6-20P, 20A-250V
2748	130141-0066	2412-C	 Connector, NEMA L6-20R, 20A-250V
2649	130141-0064	2314-P	 Plug, NEMA L7-20P, 20A-277V
2749	130142-0023	2414-C	 Connector, NEMA L7-20R, 20A-277V
2847	130142-0033	2510-P	 Plug, NEMA L5-30P, 30A-125V
2947	130141-0067	2610-C	 Connector NEMA L5-30R, 30A-125V
2848	130142-0034	2512-P	 Plug, NEMA L6-30P, 30A-250V
2948	130141-0068	2612-C	 Connector NEMA L6-30R, 30A-250V
2849	130142-0035	2514-P	 Plug, NEMA L7-30P, 30A-277V
2949	130141-0069	2614-C	 Connector, NEMA L7-30R, 30A-277V
2874	130142-0036	2520-P	 Plug, NEMA L14-30P, 30A-125/250V
2974	130142-0043	2620-C	 Connector, NEMA L14-30R, 30A-125/250V
2875	130142-0037	2522-P	 Plug, NEMA L15-30P, 30A-250V, 3 Phase
2975	130142-0044	2622-C	 Connector, NEMA L15-30R, 30A-250V, 3 Phase
2876	130142-0038	2524-P	 Plug, NEMA L16-30P, 30A-480V, 3 Phase
2976	130142-0045	2624-C	 Connector, NEMA L16-30R, 30A-480V, 3 Phase
2877	130142-0039	2526-P	 Plug, NEMA L17-30P, 30A-600V, 3 Phase
2977	130142-0046	2626-C	 Connector, NEMA L17-30R, 30A-600V, 3 Phase

Perma-Tite® 2 Cross Reference

Competitor Part Number	Molex New Part Number	Ericson Part Number	Ericson Part Description
14W47	130146-0031	1510-PW6P	 Plug, NEMA 5-15P, 15A-125V
15W47	130146-0060	1610-CW6P	 Connector, NEMA 5-15R, 15A-125V
14W33	130146-0022	1512-PW6P	 Plug, NEMA 5-20P, 20A-125V
15W33	130146-0052	1612-CW6P	 Connector, NEMA 5-20R, 20A-125V
14W49	130146-0044	1514-PW6P	 Plug, NEMA 6-15P, 15A-250V
15W49	130146-0074	1614-CW6P	 Connector, NEMA 6-15R, 15A-250V
14W48	130146-0040	1516-PW6P	 Plug, NEMA 6-20P, 20A-250V
15W48	130146-0068	1616-CW6P	 Connector, NEMA 6-20R, 20A-250V
24W47	130146-0082	1520-PW6P	 Plug, NEMA L5-15P, 15A-125V
25W47	130146-0099	1620-CW6P	 Connector, NEMA L5-15R, 15A-125V
24W49	130146-0088	1522-PW6P	 Plug, NEMA L6-15P, 15A-250V
25W49	130146-0106	1622-CW6P	 Connector, NEMA L6-15R, 15A-250V
24W34	130146-0079	1524-PW6P	 Plug, NEMA L7-15P, 15A-277V
25W34	130146-0095	1624-CW6P	 Connector, NEMA L7-15R, 15A-277V
26W47	130147-0018	2310-PW6P	 Plug, NEMA L5-20P, 20A-125V
27W47	130147-0044	2410-CW6P	 Connector, NEMA L5-20R, 20A-125V
26W48	130147-0021	2312-PW6P	 Plug, NEMA L6-20P, 20A-250V
27W48	130147-0048	2412-CW6P	 Connector, NEMA L6-20R, 20A-250V
26W49	130147-0023	2314-PW6P	 Plug, NEMA L7-20P, 20A-277V
27W49	130147-0051	2414-CW6P	 Connector, NEMA L7-20R, 20A-277V
26W08	130147-0012	2316-PW6P	 Plug, Non-NEMA, 20A-125/250V
27W08	130147-0035	2416-CW6P	 Connector, Non-NEMA, 20A-125/250V
26W74	130147-0025	2320-PW6P	 Plug, NEMA L14-20P, 20A-125/250V
27W74	130147-0053	2420-CW6P	 Connector, NEMA L14-20R, 20A-125/250V
26W75	130147-0027	2322-PW6P	 Plug, NEMA L15-20P, 20A-250V, 3 Phase
27W75	130147-0056	2422-CW6P	 Connector, NEMA L15-20R, 20A-250V, 3 Phase
26W76	130147-0029	2324-PW6P	 Plug, NEMA L16-20P, 20A-480V, 3 Phase
27W76	130147-0059	2424-CW6P	 Connector, NEMA L16-20R, 20A-480V, 3 Phase
28W47	130147-0072	2510-PW6P	 Plug, NEMA L5-30P, 30A-125V
29W47	130147-0093	2610-CW6P	 Connector, NEMA L5-30R, 30A-125V
28W74	130147-0077	2520-PW6P	 Plug, NEMA L14-30P, 30A-125/250V
29W74	130147-0102	2620-CW6P	 Connector, NEMA L14-30R, 30A-125/250V
28W75	130147-0079	2522-PW6P	 Plug, NEMA L15-30P, 30A-250V, 3 Phase
29W75	130147-0105	2622-CW6P	 Connector, NEMA L15-30R, 30A-250V, 3 Phase
28W76	130147-0081	2524-PW6P	 Plug, NEMA L16-30P, 30A-480V, 3 Phase
29W76	130147-0108	2624-CW6P	 Connector, NEMA L16-30R, 30A-480V, 3 Phase
28W77	130147-0083	2526-PW6P	 Plug, NEMA L17-30P, 30A-600V, 3 Phase
29W77	130147-0111	2626-CW6P	 Connector, NEMA L17-30R, 30A-600V, 3 Phase

Receptacles & Flip Covers

Commercial & Industrial Grade

ericson.com/flipcovers

Blue LC Series

Commercial Grade

- Single flip cover – no receptacle
- Universal foam gasket to accommodate 15, 20, and 30A receptacles
- Designed to be mounted to a flat surface
- Accommodates Lockout/Tagout (LOTO)

LOTO feature

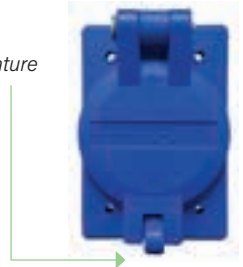

FS Series

Industrial Grade

- Single flip cover – with or without receptacle
- Weather resistant boot seals around an Ericson Perma-Tite®2 plug
- Mounts easily to any FS/FD box or any flat surface
- See page 26 for all 15, 20, and 30A NEMA configuration options



PWDX Series

Industrial Grade

- Duplex flip covers – with receptacles
- Weather resistant boot seals around an Ericson Perma-Tite®2 plug
- Mounts easily to any FS/FD box or any flat surface
- See page 26 for all 15 and 20 Amp NEMA configuration options
- Accommodates Lockout/Tagout (LOTO)

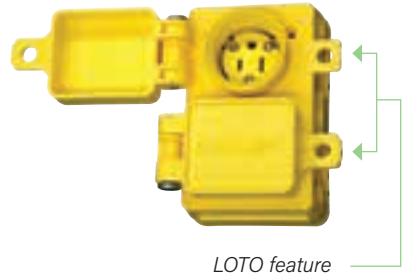

LOTO feature

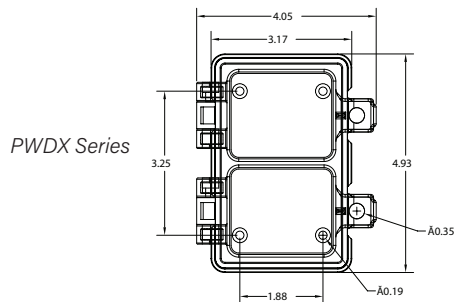
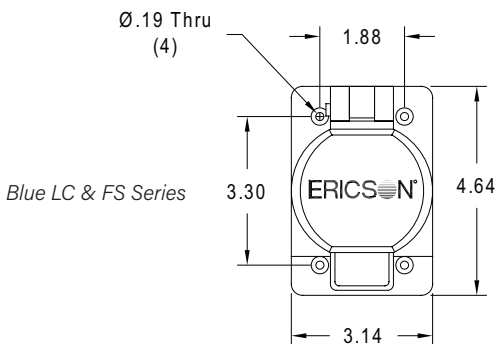

Outlet Boxes-Single Gang

Industrial Grade, Rubber TPV Boxes

ericson.com/boxes

6000 Series

Pendant Style



6000

Standard Box



6002

Extra Deep Box

Feed-thru not available with cord clamp style



Strain relief bushing available on select models

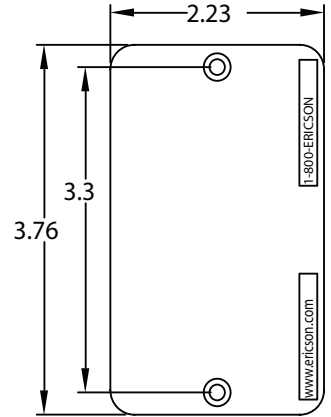

6000 Series

Feed-thru Style



6000-F

Standard Box



6002-F

Extra Deep Box



Duplex

6031



1.39" diameter

6032



1.57" diameter

6033



Blank Cover

6034



GFCI Duplex

6035

Also available in all black

	6031 Duplex Plate		6032 1.39" Diameter Plate		6033 1.57" Diameter Plate	
	Standard Box	Extra Deep Box	Standard Box	Extra Deep Box	Standard Box	Extra Deep Box
Pendant Style	6000	6002	6005	6006	6010	6011
Feed-thru Style	6000-F	6002-F	6005-F	6006-F	6010-F	6011-F



ericson.com
ericson.com/rfq

1.800.ERICSON
1.800.374.2766



Outlet Boxes—Single Gang

Industrial Grade, Rubber TPV Boxes

ericson.com/boxes

6100 Series

Pendant Style with Flip Covers

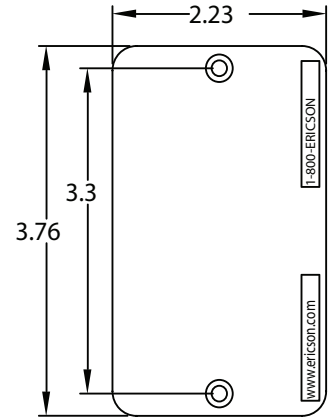

6100

Standard Box



6102

Extra Deep Box

Duplex

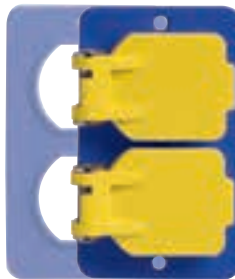

6131

GFCI Duplex

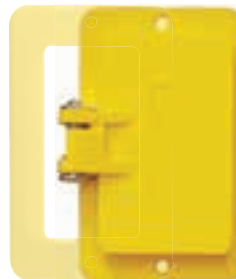

6135Y

1.39" diameter



6132

1.57" diameter

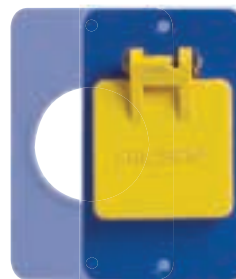

6133

Blank Cover



6034

Also available in all black

	6131 Duplex Plate with Flips		6132 1.39" Diameter Plate with Flip		6133 1.57" Diameter Plate with Flip	
	Standard Box	Extra Deep Box	Standard Box	Extra Deep Box	Standard Box	Extra Deep Box
Pendant Style	6100	6102	6105	6106	6110	6111
Feed-thru Style	6100-F	6102-F	6105-F	6106-F	6110-F	6111-F

Outlet Boxes—Double Gang

Industrial Grade, Rubber TPV Boxes

ericson.com/boxes

8000 Series



8201FS



8208FS

Box Selection Guide

Part Number	Description
8005	(1) 1/2" npt hole
8005F	(2) 1/2" npt holes, one on each end
8034	(1) 3/4" npt hole
8034F	(2) 3/4" npt holes, one on each end
8010	(1) 1" npt hole
8010F	(2) 1" npt holes, one on each end

Strain Relief Selection Guide

Part Number	Description
82005	Strain relief, cord 1/2" npt with grommets
82034	Strain relief, cord 3/4" npt
82010	Strain relief, cord 1" npt
82005W	Strain relief, wire, cord 1/2" (1/2 npt)
82034W	Strain relief, wire, cord 3/4" npt
82010W	Strain relief, wire, cord 1" npt

Cover Plate Selection Guide

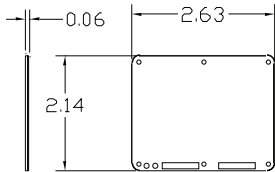

8200

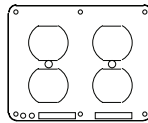

8201

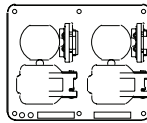

8201FS

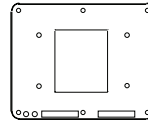

8202

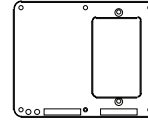

8203

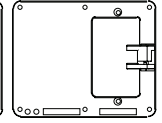

8203FS

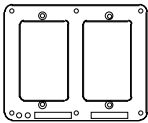

8204

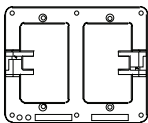

8204FS

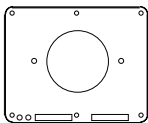

8205

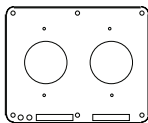

8206

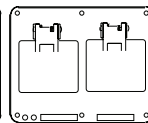

8206FS

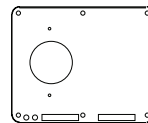

8207

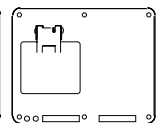

8207FS

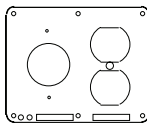

8208

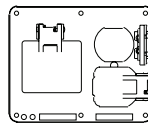

8208FS

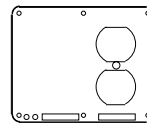

8209
8209-OR

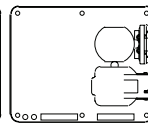

8209FS
8209FS-OR

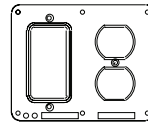

8210

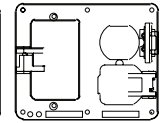

8210FS

Hole Ø Inches

8205 = 2.40"

8206 = 1.57"

8207 = 1.57"

8208 = 1.57"



ericson.com
ericson.com/rfq

1.800.ERICSON
1.800.374.2766



Wire Mesh Grips

Industrial Grade

ericson.com/grips

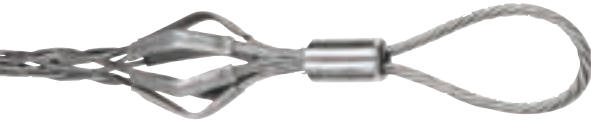

Pulling Grips

- Reusable pulling tool for light to heavy cables

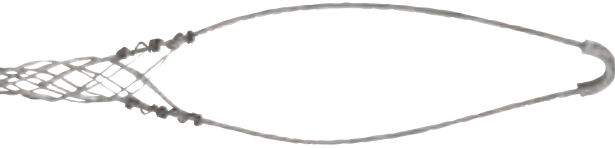

Support Grips

- Hold and support vertical or horizontal cables, metal rods and tubing
- Prevents cable pull-out by supporting the weight



Cord Grips

- Protects cable when exposed to moisture or submersion
- Eliminates fatigue points and prevents cable pull-out
- Indoor and outdoor use

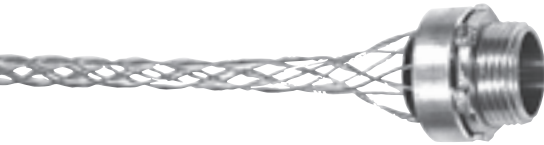

Strain Relief Grips

- Prevents damage caused by cable pull-out
- Reduces tension from being transmitted to joints
- Minimizes stress and strain on conductors at the point of wire termination



Deluxe Support Grips

- Prevents damage caused by cable pull-out
- Reduces tension from being transmitted to joints
- Minimizes stress and strain on conductors at the point of wire termination

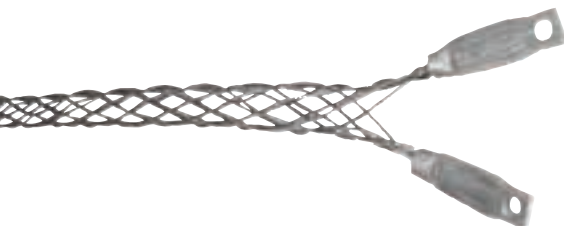

I-Grips

- Easy to attach
- Controls cable arc-of-bend
- Provides heavy duty strain relief for plugs and connectors

Power Drops

Industrial Grade

ericson.com/drops

- Provides convenient access to power at each work station
- Reduces trip hazards
- Watertight solutions for wash down and wet environments
- Antimicrobial PermaKleen™ solutions for food & beverage processing plants
- Single power drop and multi-drop festoon systems available
- Both single- and multi-receptacle options
- Add cable strain reliefs for demanding applications
- Blunt primary end for hard-wire into junction box or factory configured for easy plug 'n play installation
- Smart Monitor™ connector options provide additional safety by continuously checking for ground path integrity



*Perma-Tite® 2
Watertight Connector*

*Perma-Kleen™
Antimicrobial & Watertight
Connector*

*6000 Series Non-metallic
Outlet Boxes*



Light Duty Molded Power Drop



Heavy Duty Molded Power Drop



*Also available with Smart
Monitor™ wiring devices*



Power Supply Cables

Commercial & Industrial Grade

ericson.com/supply

- Power supply cables and interconnecting cables for various OEM applications
- Antimicrobial Perma-Kleen™ solutions for food-processing equipment
- Solutions for all common plug and receptacle types and configurations
- Watertight plug options for equipment used in marine and outdoor/wet environments
- GFCI options for worker safety
- Smart Monitor™ plug options help ensure equipment is connected to proper ground path



Mini/Micro connections



NEMA Commercial Plugs



GFCI with NEMA Commercial Plugs



IEC60309 Plug Style Options



Molded Watertight Plug
Perma-Kleen™ overmold solutions also available

- See page 26 for all NEMA configuration options
- Available in multiple lengths



Perma-Grip™



Perma-Tite® 2



Perma-Kleen™

Smart Monitor™



Perma-Link®



Perma-Grip™



Perma-Tite® 2

Power & Receptacle Stringers

Commercial & Industrial Grade

ericson.com/stringers

- Various configurations and receptacle spacings available
- Great for tent and portable shelter applications
- 3Ø options for convention centers & trade shows
- Provides for work site lighting during early stages of construction projects
- Indoor and outdoor rated solutions available



Light Duty Molded Receptacle Power Stringer



Molded Receptacle Power Stringer with Watertight Cap



Heavy Duty Molded Receptacle Power Stringer

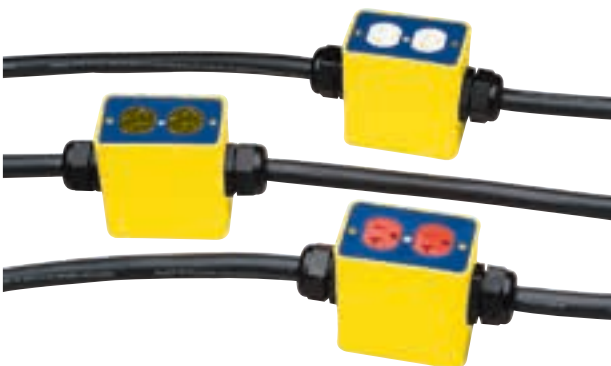

3-Phase Power Stringer



Cordsets

Commercial Grade

ericson.com/commercial-cordset

15 Amp Molded Cordsets



123B - 50 ft.



123B-TT - 50 ft.



123D - 100 ft.



123D-TT - 100 ft.

50 Amp Cordsets



63BSO - 50 ft.



63DSO - 100 ft.



63YSTW



SR50 Receptacle

- See page 26 for all NEMA configuration options
- Available in multiple lengths

Cordsets

Industrial Grade

15-30 Amp Cordsets



Perma-Link®



Perma-Grip™



Perma-Tite® 2



Perma-Kleen™

Smart Monitor™



Perma-Link®



Perma-Grip™



Perma-Tite® 2



Cordsets

Industrial Grade

ericson.com/cordsets

15-20 Amp Multi-Outlet Cordsets

- See page 26 for all NEMA configuration options
- Available in multiple lengths



7000-25-2

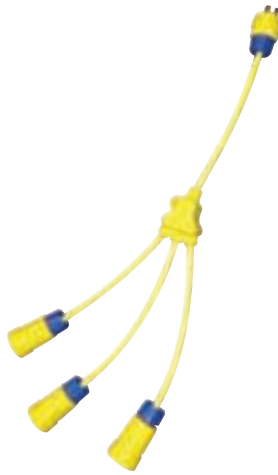

W Adapter



Y Adapter



61025



6000 Box



6002 Box



6100 Box



6102 Box

Up to 400 Amp Cordsets



Camlock Devices
 F – Female end with blunt male end
 MF – Female and male ends installed

Camlocks
 BK – Black
 R – Red
 BL – Blue
 W – White
 G – Green

SC Size Devices Length Color

2 – 2 AWG SC (140 Amps max)
 20 – 2/0 AWG SC (225 Amps max)
 40 – 4/0 AWG SC (400 Amps max)

3 – 3 ft. Overall length
 10 – 10 ft. Overall length
 25 – 25 ft. Overall length
 50 – 50 ft. Overall length
 100 – 100 ft. Overall length



ericson.com
ericson.com/rfq

1.800.ERICSON
 1.800.374.2766



GFCIs-In-line

Commercial & Industrial Grade

ericson.com/gfci

Protector Series – Commercial Grade

- cULus listed for U.S. and Canada
- Meets NEC & OSHA construction site requirements
- Automatic power-up
- Open neutral and grounded neutral protection
- Factory wired line & load side using 12/3 SJTW cable
- User can re-wire load side cord
- Works on 2-wire or 3-wire circuits
- Class A with open neutral protection



XG2 Series – Industrial Grade

- cULus listed for U.S. and Canada
- Meets NEC & OSHA construction site requirements
- Automatic & manual power-up models are available
- Works on 2-wire or 3-wire circuits
- Available in 15A and 20A models
- Up to 1.5 horsepower switch rating
- NEMA type 6P polycarbonate enclosure is watertight and corrosion, impact, and UV light resistant
- Available with factory-wired and molded-on device
- Class A with open neutral protection



Part Number	Power Up Type	Length (ft.)	Plug	Connector	Amps	Watts
XG2-14-2S	Auto	2 ft.	Molded NEMA 5-15	Molded NEMA 5-15	15	1875
XG2-12-2TT	Auto	2 ft.	Molded NEMA 5-15	Molded NEMA 5-15 Tri-tap	15	1875
XG2-12-2W	Auto	2 ft.	NEMA 5-20 1512-PG	NEMA 5-20 1612-CG	20	2500
XG2-12-2B ¹	Auto	2 ft.	NEMA 5-20 1512-PG	(2) 5-20 Duplex receptacals	20	2500
XG2-12-2BW ²	Auto	2 ft.	NEMA 5-20 1512-PG	(2) 5-20 Duplex receptacles	20	2500

¹ - Factory wired 6000 box connector with two duplex receptacles

² - Factory wired 6100 box connector with two duplex receptacles

1075 Series Panel Mount GFCI

ericson.com/panelmount-gfci

- cULus listed for U.S. and Canada
- Quick and easy field installation into temporary panels and work boxes
- Compact & portable, this unit is easy to use, store and transport
- Unique vibration resistant design
- Works on 2-wire or 3-wire circuits
- Meets OSHA construction site requirements
- Fast response trip time; less than .025 seconds
- Molded polycarbonate enclosure is corrosion and impact resistant and stands up to the toughest work site conditions
- Manual and automatic power-up models available
- Class A with open neutral protection

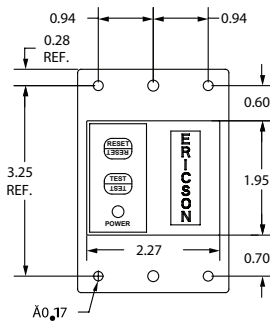

1075 hole configuration



1075-AR or 1075-MR

1060 Series Multiple Outlet GFCI

ericson.com/multi-gfci

- Polycarbonate, impact resistant enclosure retains its properties under the most extreme environmental conditions
- Spring-loaded flip lids protect outlets from work site contaminants when not in use
- Unit comes standard with extra hard usage #12/3 SOOW cable
- Meets OSHA construction site requirements
- Fast response trip time; less than .025 seconds
- Class A with open neutral protection
- Tamper proof enclosure
- Unmatched vibration resistance ideal for OEM applications
- Multiple NEMA configurations available



1060



ericson.com
ericson.com/rfq

1.800.ERICSON
1.800.374.2766



TUFFTRAXX™ & CABLE REELS

TuffTraxx™ Cable & Hose Protectors	43-44
Retractable Cable Reels	45-50
Commercial Grade	45
Industrial Grade	46-47
Industrial Grade, High Capacity	48
Industrial, Hazardous Location	49
Static Discharge Grounding Reels (SDR)	50
Pushbutton Pendant Stations	51



TuffTraxx™

Cable & Hose Protection

ericson.com/tuff

- NEC / OSHA compliance
- Lifetime warranty
- Industry-leading load ratings up to 50,000 lbs. per axle
- Industrial and extreme duty styles
- Constructed from lightweight polyurethane
- Flexible design for easy setup and transportation
- Operating temperature range is -40° F to 120° F / -40° C to 49° C
- Customize with your company logo and color scheme

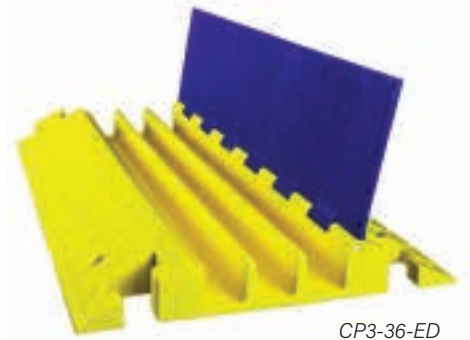
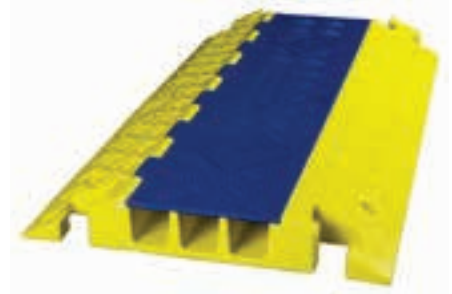

CP3-36-ED
3-channel

Material	Straight Section Body	UV resistant, stabilized polyurethane
	Hinges	Reinforced fiberglass
Max load per tire	CP5-36-ID	13,500 lbs. @ 70° F (6,123 kg. @ 21° C)
	CP3-36-ED	25,000 lbs. @ 70° F (11,340 kg. @ 21° C)
	CP4-36-ED	25,000 lbs. @ 70° F (11,340 kg. @ 21° C)
	CP5-36-ED	25,000 lbs. @ 70° F (11,340 kg. @ 21° C)
Max load per axle	CP5-36-ID	27,000 lbs. @ 70° F (12,247 kg. @ 21° C)
	CP3-36-ED	50,000 lbs. @ 70° F (22,680 kg. @ 21° C)
	CP4-36-ED	50,000 lbs. @ 70° F (22,680 kg. @ 21° C)
	CP5-36-ED	50,000 lbs. @ 70° F (22,680 kg. @ 21° C)
	CP5-36-ED	50,000 lbs. @ 70° F (22,680 kg. @ 21° C)

Cord Type	Voltage	CP5-36-ID (1.25" Max Diameter)	CP4-36-ED CP5-36-ED (1.33" Max Diameter)	CP3-36-ED (2" Max Diameter)
SOOW Portable Cord	600V	2/4	2/4	2/5
SOOW Control Cord	600V	12/20, 14/24, 16/44	12/24, 14/24, 16/60	ALL
Type W Single Conductor	2000V	350 MCM	500 MCM	>500 MCM
Type W Multi-Conductor Power	2000V	2/2, 4/4, 6/5	2/3, 4/4	3/0-4C, 4/0-3C
Type SC Single Conductor	600V	>4/0	>4/0	>4/0
Welding Single Conductor	600V	500 MCM	>500 MCM	>500 MCM
Type G Multi-Conductor	2000V	G-4/4	G-4/4	G-3/0-4C



ericson.com
ericson.com/rfq

1.800.ERICSON
1.800.374.2766



TuffTrax™ Options & Specs



TT-Cart

Industrial Duty

CP5-36-ID



Extreme Duty

CP5-36-ED



CP4-36-ED



CP3-36-ED

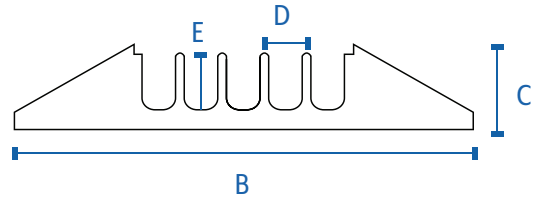
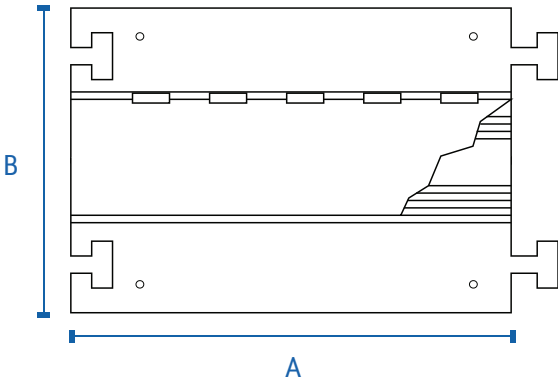

Part Number	Description	A-Length	B-Width	C-Height	D-Channel Width	E-Channel Height	Weight
CP3-36-ED	Extreme duty 3-slot, 36" straight section	36" 91 cm.	20" 51 cm.	3.08" 7.8 cm.	2.22" 5.6 cm.	2.25" 6 cm.	28 lbs. 12.7 kg.
CP4-36-ED	Extreme duty 4-slot, 36" straight section	36" 91 cm.	19.5" 50 cm.	2.25" 6 cm.	1.78" 4.5 cm.	1.33" 3.4 cm.	23.5 lbs. 10.7 kg.
CP5-36-ID	Industrial duty 5-slot, 36" straight section	36" 91 cm.	17.25" 44 cm.	2.00" 5.1 cm.	1.36" 3.5 cm.	1.27" 3.2 cm.	20.6 lbs. 9.3 kg.
CP5-36-ED	Extreme duty 5-slot, 36" straight section	36" 91 cm.	19.5" 50 cm.	2.25" 6 cm.	1.40" 3.5 cm.	1.33" 3.4 cm.	23.5 lbs. 10.7 kg.

F3100 Flex Rig

Commercial, Retractable Cable Reel

ericson.com/flexrig

Listing: cULus listed for U.S. and Canada

Flange Size: 12" diameter

Construction: Reinforced steel construction, durable white powder coated finish, and black nylon hubs

- Separate mounting base plate for easiest installation on the market
- 4-roller cable guide designed for a quick positional change
- Grounded slip ring assembly for safety
- Adjustable ball stop included

Termination: 6 ft. feeder cord with molded plug

Cable Type: Installed with 12 or 16 gauge type SJOW 300V cable

Environmental: Rated NEMA 2 for indoor use

Electrical Ratings: Max rating of slip ring is 20A, 125V

Options: Secondary attachment options: blunt, a quad rubber box, molded tri-tap or single connector

Range 35 & 50 ft. **Applications** Lift or drag



Separate mounting base for quick & easy install

Cord Length & Type	Part Number	Primary End	Secondary Attachment
50 ft. 16/3 AWG	F3163-50-TT10	NEMA 5-15 molded plug	NEMA 5-15 molded tri-tap
50 ft. 12/3 AWG	F3123-50-TT15G	NEMA 5-15 molded plug	NEMA 5-15 molded tri-tap
50 ft. 12/3 AWG	F3123-50-F15	NEMA 5-15 molded plug	Blunt
50 ft. 12/3 AWG	F3123-50-F20	NEMA 5-20 molded plug	Blunt
50 ft. 12/3 AWG	F3123-50-520	NEMA 5-20 molded plug	NEMA 5-20 connector
50 ft. 12/3 AWG	F3123-50-L520	NEMA 5-20 molded plug	NEMA L5-20 connector
50 ft. 12/3 AWG	F3123-50-B20	NEMA 5-20 molded plug	NEMA 5-20 quad receptacle box
50 ft. 12/3 AWG	F3123-50-B20G	NEMA 5-20 molded plug	NEMA 5-20 quad receptacle box with GFCI



ericson.com
ericson.com/rfq

1.800.ERICSON
1.800.374.2766



TuffTraxx™ & Cable Reels

4000 Series

Industrial, Retractable Cable Reel

ericson.com/industrial-reels

Listing: UL listed and CSA certified

Flange Size: 12" diameter

Construction: Heavy all-steel with durable yellow powder coated finish

- Formed steel stand with multiple mounting holes
- 4-roller cable guide - adjustable to one of 12 positions
- Ratchet can be engaged for positive lock or disengaged for constant tension
- Safety chain hole provided for overhead mounting
- Adjustable ball stop included
- Grounded slip ring assembly for safety

Termination: 6 ft. feeder cord (3 conductor - molded plug, all others - blunt cable)

Cable Type: Installed with type SJOW/SJEOW 300V or SOOW 600V cable

Environmental: Reel housing is rated NEMA 4 for Indoor & Outdoor. Reel is derated to NEMA 2 with any reel attachment or with a molded plug on primary w/ SJ 3 conductor cable.

Electrical Ratings: Max rating of slip Ring = 30A, 600V

Options: Stretch or retrieve application, black or white powder coat finish, secondary attachments, pivot base, or Perma-Kleen™ antimicrobial cable



Range 20–50 ft. **Applications** Lift or drag

Cord Length & Type	Reel with cable only		944-RS Hand Lamp	910 LED Hand Lamp	6000 Box NEMA 5-15 Duplex (2) Non-GFCI	NEMA 5-20 Perma-Grip Connector
	300V Cable	600V Cable				
25 ft. 16/3 AWG		4163-25SO	4163-25-HSS			
35 ft. 16/3 AWG		4163-35SO	4163-35-HSS			
50 ft. 16/3 AWG		4163-50SO	4163-50-HSS			
30 ft. 14/3 AWG	4143-30	4143-30SO	4143-30-HSS		4143-30-B	4143-30-1612CG
40 ft. 14/3 AWG	4143-40	4143-40SO	4143-40-HSS		4143-40-B	4143-40-1612CG
50 ft. 14/3 AWG	4143-50	See 5000 Series	4143-50-HSS		4143-50-B	4143-50-1612CG
25 ft. 12/3 AWG	4123-25	4123-30SO (30')	4123-25-HSS	4123-25-910-S-360	4123-25-B	4123-25-1612CG
50 ft. 12/3 AWG	4123-50	See 5000 Series	4123-50-HSS	4123-50-910-S-360	4123-50-B	4123-50-1612CG
35 ft. 16/4 AWG	4164-35	4164-35SO				
50 ft. 16/4 AWG	4164-50	4164-50SO				
35 ft. 14/4 AWG	4144-35					
25 ft. 12/4 AWG	4124-25	4124-25SO				
35 ft. 12/4 AWG	4124-35					

NEMA 2 Rated **NEMA 4 Rated**

-1917-12S



1917-12S
12V Spotlight with Switch

-HSS



944-RS

-910-S-360



910

-B



6000 Box NEMA 5-15
duplex (2) non-GFCI

-1612CG



NEMA 5-20
Perma-link™ Connector

5000 Series

Industrial, Retractable Cable Reel

ericson.com/industrial-reels

Listing: UL listed and CSA certified

Flange Size: 14" diameter

Construction: Heavy all-steel with durable yellow powder coated finish with nylon drum

- Formed steel stand with multiple mounting holes
- 4-roller cable guide—adjustable to one of 12 positions
- Ratchet can be engaged for positive lock or disengaged for constant tension
- Safety chain hole provided for overhead mounting
- Adjustable ball stop included
- Grounded slip ring assembly for safety

Termination: 6 ft. feeder cord

Cable Type: Installed with type black SOOW 600V cable

Available in 16/6, 16/8, 16/10, 16/12, 14/6, 14/8, 14/10, 12/3, 12/4, 12/6, 12/8, 10/3, 10/4, 10/6

Environmental: Rated NEMA 4 for indoor and outdoor

Electrical Ratings: Max rating of Slip Ring = 35A, 600V

Options: Stretch or retrieve application, black or white powder coat finish, secondary attachments, pivot base, or Perma-Kleen™ antimicrobial cable



Range 20–80 ft. **Applications** Lift or drag

Cord Length & Type	Reel with cable only	NEMA 5-20 Perma-Grip Connector	6000 Box NEMA 5-20 Duplex (2) GFCI	PWDX Box NEMA 5-20 Water Tight	Pushbutton Pendant Stations
	Standard with SOOW cable				
40 ft. 16/12 AWG	51612-40				Contact Us
40 ft. 14/8 AWG	5148-40				Contact Us
40 ft. 12/3 AWG	5123-40	5123-40-1612CG	5123-40-BG-20	5123-40-1612-PWDX	Contact Us
30 ft. 12/3 AWG	5123-30	5123-30-1612CG	5123-30-BG-20	5123-30-1612-PWDX	Contact Us
50 ft. 12/3 AWG	5123-50	5123-50-1612CG	5123-50-BG-20	5123-50-1612-PWDX	Contact Us
50 ft. 12/4 AWG	5124-50				Contact Us
30 ft. 12/6 AWG	5126-30				Contact Us
20 ft. 10/3 AWG	5103-20				Contact Us
50 ft. 10/4 AWG	5104-50				Contact Us

Many configurations available, please contact us for assistance

–1612CG



NEMA 5-20 Perma-Grip Connector

–BG-20



6000 Box NEMA 5-20 duplex (2) GFCI

–1612-PWDX



PWDX Box NEMA 5-20 Watertight



Pushbutton Pendant Stations

–5506
–5508



ericson.com
ericson.com/rfq

1.800.ERICSON
1.800.374.2766



TuffTraxx™ & Cable Reels

6000 & 7000 Series

Industrial, High Capacity Retractable Cable Reels

ericson.com/industrial-reels

Flange Size: 6000–19" diameter, 7000–24" diameter, other diameters up to 36"

Construction: Heavy all-steel with durable yellow powder coated finish

- Ratchet can be engaged for positive lock or disengaged for constant tension
- Formed steel stand with multiple mounting holes
- 4-roller cable guide—adjustable to one of 12 positions
- Safety chain hole provided for overhead mounting
- Adjustable ball stop included
- Grounded slip ring assembly for safety

Termination: approximately 2 ft. of primary flying lead conductors

Cable Type: Installed with type SOOW 600V cable

Environmental: Rated NEMA 4 for indoor and outdoor

Electrical Ratings: Call for details

Options: Stretch or retrieve application, black or white powder coat finish, secondary attachments spool guard rail, spool lock, marine duty

Range 20–200 ft. **Applications** Lift or drag



Additional Cable Reel Options

Ball Stop & Swivel Base



345° Swivel Base
 PB-FLEX – Flex Rig Series
 PB-45 – 4000 & 5000 Series
 PB-67 – 6000 & 7000 Series

Part Number	Description
SC-1	Cable O.D. ranges 0.188" to 0.438"
SC-2	Cable O.D. ranges 0.188" to 0.438" with shock absorbing bumper
SC-3	Cable O.D. ranges 0.438" to 0.624"
SC-4	Cable O.D. ranges 0.625" to 0.749"
SC-5	Cable O.D. ranges 0.75" to 1.05"
SC-6	Cable O.D. ranges 1.06" to 1.38"
SC-7	Cable O.D. ranges 1.39" to 1.55"

8000 Series

Industrial, Hazardous Location Retractable Cable Reel

ericson.com/haz-reels

Flange Size: 14" diameter

Construction: Rugged fabricated steel with gray epoxy finish and cast aluminum construction

- Formed steel stand with multiple mounting holes
- 4-roller cable guide—adjustable to one of 12 positions
- Ratchet can be engaged for positive lock or disengaged for constant tension
- Safety chain hole provided for overhead mounting
- Adjustable ball stop included
- Grounded slip ring assembly for safety
- Threaded junction box and slip ring enclosure

Termination: 6 ft. feeder cord

Cable Type: Installed with type SOOW 600V cable

Environmental: Class I Division 1, Groups C & D (flammable gases or vapors)

Class II Division 1, Groups E, F, & G (combustible dusts)

Class III Division 1 (easily-ignitable fibers or flyings)

Class I Zone 1: AEx d IIB, EX d IIB

Conforms to NEMA 9 and NEMA 4 (IP56) standards

Select models UL listed

Electrical Ratings: Max rating of Slip Ring = 35A, 600V

Options: Stretch or retrieve application, LED XP hand lamp attachment
flop-over guide kit, or pivot base



Optional XP LED hand lamp

Range 20–80 ft. **Applications** Lift or drag

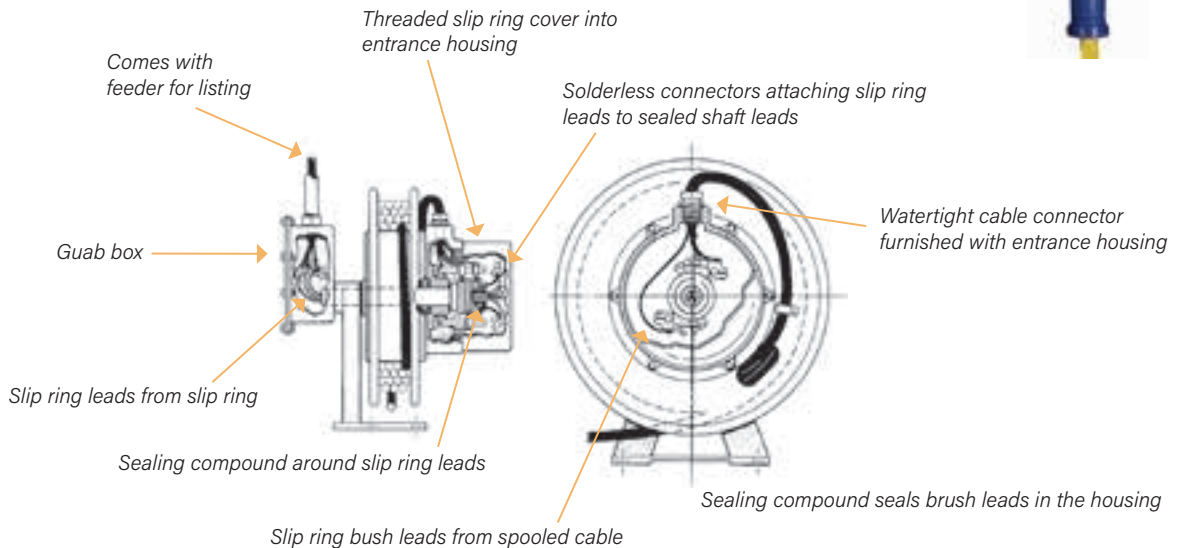

ericson.com
ericson.com/rfq

1.800.ERICSON
1.800.374.2766



SDR Series–Static Discharge Grounding Reel

Industrial, Hazardous Location Retractable Cable Reel

ericson.com/sdr

Flange Size: 6.25" diameter

- Built to NEC standards

Construction: Compact, all steel unit with 100 Amp grounding clamp

- Red epoxy finish
- Floor and ceiling mount
- 1/8" diameter steel aircraft cable
- Resistance not exceeding 0.3 Ohms

Options: Automatic locking ratchet with lockout feature for constant tension

- Available in double cable "Y" design to ground 2 places at once



Range 25 & 50 ft.

Applications Ericson's SDR reels ground potentially dangerous static electricity in hazardous areas, such as refueling stations, fuel trucks, fuel tanks, aircraft, and similar applications

Flange Size: 14" diameter

Construction: Heavy all-steel construction with durable yellow powder coated finish with black nylon drum

- Formed steel stand with multiple mounting holes
- 4-roller cable guide–adjustable to one of 12 positions
- Adjustable ball stop included
- 100A grounding clamp
- 3/32" diameter orange nylon steel aircraft cable
- Automatic locking ratchet with lockout feature for constant tension
- Resistance not exceeding 2 Ohms

Environmental: Rated NEMA 4



Range 75 & 100 ft.

Applications Ericson's SDR reels ground potentially dangerous static electricity in hazardous areas, such as refueling stations, fuel trucks, fuel tanks, aircraft, and similar applications

Pushbutton Pendant Stations

5500 Series Industrial Grade

ericson.com/pendants

- NEMA rated 1, 3, 4, 4X and 12 (depending on model)
- IP65 suitability enclosure ratings
- Available in 2 to 12 button configurations
- Single, 2-speed, and 3-speed models available
- Neoprene boots surround buttons to seals out dirt and moisture
- 2-piece enclosure simplifies field wiring
- Soft pressure and positive indent switches provide optimum tactile feedback so you can feel when switch has been engaged
- Contacts rated at 5A/120VAC and 5A/240VAC
- 2 Amps at 12V/24DC
- Up to 100 g shock resistance
- Ambient temperature rated 5°F to 160° F (-15° to 70°C) operation (model 5503 rated to 50°C/122°F)



Multiple button configurations



*Pistol Grip Styles with E-Stop
5503-pg*



*Compact Pistol Grip
5502-pg*



TEMPORARY LIGHTING

String Lights (LED, Incandescent, CFL)	53-58
Commercial Grade	53
Industrial Grade	54-55
Hazardous Location	56
Hazardous Location Low Voltage	57
Engineered Solutions: String Lights	58
Hand Lamps (LED, Incandescent, CFL)	59-67
Industrial Grade	59-61
Industrial Grade Low Voltage	62-65
Hazardous Location Low Voltage	66-67
Wide Area Work/Task Lighting	68-71
1000 LED Series	68
800 LED Series	69
1140 LED Series	70
1009 LED Series	71
Bay Lighting (Hi/Lo)	72-74
1004 LED Baylite	72
1007 LED Series	73
1005 LED Hi/Lo Baylite	74
Specialty Lighting	75-77
Boiler Lights	75
1239 LED Battery Back-up Lighting	76
1000F-EMBT Battery Back-up Lighting	77
Temporary Lighting Options & Customs	78
Temp Lighting Layout / Calculation Services	79



Construct-O-Lite® & E-Lite

2- and 3-Wire Commercial String Lights

ericson.com/commercial-sl

- UL or cULus listed for U.S. and Canada
- Meets OSHA construction site requirements
- Meets NEC/CEC requirements for temporary lighting
- Designed for applications that require rapid set-up and tear down
- Full threaded screwshell to ensure proper contact*
- Easy relamping with non-conductive, snap-open cage guard
- Built-in hanger for easy installation with messenger cable or hooks
- Part numbers 142100 and 14250 are packaged "ready to lamp" with guards attached
- Product customizations are available upon request



142100



212 rain guard



211 wire guard

	Part Number ¹	Listing	Length	Cable Type/Voltage	Guard Number	# of Sockets	Socket Spacing	Max Watts Per Socket	Primary Plug	Secondary Connector
2-wire	142100	UL	100 ft.	14/2 SJTW 300 V	04202	10	10 ft. centers	150 watts	NEMA 1-15	Blunt
	122100	cULus	100 ft.	12/2 SJTW 300 V	04202	10	10 ft. centers	150 watts	NEMA 1-15	Blunt
3-wire	143100	UL	100 ft.	14/3 SJTW 300 V	04202	10	10 ft. centers	150 watts	NEMA 5-15	NEMA 5-15
	143100-W	UL	100 ft.	14/3 SJTW 300 V	04202 + 211	10	10 ft. centers	150 watts	NEMA 5-15	NEMA 5-15
	143100-C	UL	100 ft.	14/3 SJTW 300 V	04202 + 212	10	10 ft. centers	150 watts	NEMA 5-15	NEMA 5-15
	14350	None	50 ft.	14/3 SJTW 300 V	04202	5	10 ft. centers	150 watts	NEMA 5-15	NEMA 5-15
	14350-W	None	50 ft.	14/3 SJTW 300 V	04202 + 211	5	10 ft. centers	150 watts	NEMA 5-15	NEMA 5-15
	14350-C	None	50 ft.	14/3 SJTW 300 V	04202 + 212	5	10 ft. centers	150 watts	NEMA 5-15	NEMA 5-15
	123100STWY-1L	cULus	100 ft.	12/3 STW 600 V	04202	10	10 ft. centers	150 watts	NEMA 5-15	NEMA 5-15
	123100STWY-1W	cULus	100 ft.	12/3 STW 600 V	04202 + 211	10	10 ft. centers	150 watts	NEMA 5-15	NEMA 5-15
	123100STWY-1C	cULus	100 ft.	12/3 STW 600 V	04202 + 212	10	10 ft. centers	150 watts	NEMA 5-15	NEMA 5-15
	12350STWY-1L	cULus	50 ft.	12/3 STW 600 V	04202	5	10 ft. centers	150 watts	NEMA 5-15	NEMA 5-15
	12350STWY-1W	cULus	50 ft.	12/3 STW 600 V	04202 + 211	5	10 ft. centers	150 watts	NEMA 5-15	NEMA 5-15
	12350STWY-1C	cULus	50 ft.	12/3 STW 600 V	04202 + 212	5	10 ft. centers	150 watts	NEMA 5-15	NEMA 5-15

¹ - Add -LED as suffix to any part number for 10W LED bulbs to be kitted with product



ericson.com
ericson.com/rfq

1.800.ERICSON
1.800.374.2766



Temporary Lighting

53

Industrial Grade

3-, 4- and 5-Wire Heavy Duty String Lights

ericson.com/industrial-sl

- UL listed and CSA certified
- Meets OSHA, NEC/CEC compliance
- Full threaded screwshell to ensure proper contact
- Designed for applications that require rapid set-up and tear down
- String lights available in 50ft. and 100ft.
- String lights come standard with watertight NEMA plug and connector
- Power drops between lamps available
- Guards sold separately
- Product customizations are available upon request



211 wire guard



211-P vinyl guard



215 rain guard



Perma-Tite® 2 watertight plug and connector

Part Number	Listing	Length	Cable Type / Voltage	# of Sockets	Socket Spacing	Max Watts per Socket ¹	Primary ²	Secondary
12350Y-1	UL / CSA	50 ft.	12/3 SEOW or SOW 600V	5	10 ft. centers	150 watts	NEMA 5-15	NEMA 5-15
12350Y-2	UL / CSA	50 ft.	12/3 SEOW 600 V	5	10 ft. centers	150 watts	NEMA L5-15	NEMA L5-15
12350Y-3	UL / CSA	50 ft.	12/3 SEOW 600 V	5	10 ft. centers	150 watts	NEMA L5-20	NEMA L5-20
123100Y-1	UL / CSA	100 ft.	12/3 SEOW 600 V	10	10 ft. centers	150 watts	NEMA 5-15	NEMA 5-15
123100Y-2	UL / CSA	100 ft.	12/3 SEOW 600 V	10	10 ft. centers	150 watts	NEMA L5-15	NEMA L5-15
123100Y-3	UL / CUL	100 ft.	12/3 SEOW 600 V	10	10 ft. centers	150 watts	NEMA L5-20	NEMA L5-20

1) 10 sockets: 150 watts max, 5 sockets: up to 200 watts although marked for 150 watts

2) Change Y to B in part number for all black string light configuration

Linear LED Tube String Light

ericson.com/linear-sl

- 817- P/N: cULus listed, 813- P/N: cULus listing pending
- 817- P/N: 2 ft. bulb length, 813- P/N: 1 ft. bulb length
- Low profile, streamlined design for easy insertion/extraction
- Industrial grade, LED string light designed for rugged environments
- NEMA 3R, 4X, and 6P rated
- Feed-thru connectivity
- Available in 200 and 360 degree beam angles
- Color temperature = 5700K, color rendition > 80
- Unique LED bulb provides theft deterrence
- Patent D786493, D836238, and other patents pending
- Product customizations are available upon request



Beveled ends reduce pinch points



Part Number ⁴	14/3 SEOW Overall Length	Cord Length		Lamp Spacing	LED Type		Lamp Quantity	Total Lumens	Electrical Rating ¹		Max Units Connected ²
		Primary Cord Length	Secondary Cord Length		Beam Angle °	Amperage Draw (A)					
813-6-LEDSL-14350-D	50 ft. 15.24m	6 ft. / 1.82m	6 ft. / 1.82m	12.5 ft. 3.81m	Directional	200°	4	5760	120V 60Hz	0.24	50
		6 ft. / 1.82m			200°						
813-6-LEDSL-14350-360	50 ft. 15.24m	6 ft. / 1.82m	6 ft. / 1.82m	12.5 ft. 3.81m	Omni-directional	360°	4	5760	120V 60Hz	0.24	50
		6 ft. / 1.82m			360°						
813-6-LEDSL-143100-D	100 ft. 30.48m	6 ft. / 1.82m	6 ft. / 1.82m	12.5 ft. 3.81m	Directional	200°	8	11,520	120V 60Hz	0.48	25
		6 ft. / 1.82m			200°						
813-6-LEDSL-143100-360	100 ft. 30.48m	6 ft. / 1.82m	6 ft. / 1.82m	12.5 ft. 3.81m	Omni-directional	360°	8	11,520	120V 60Hz	0.48	25
		6 ft. / 1.82m			360°						
813-5-LEDSL-143100-D	100 ft. 30.48m	5 ft. / 1.52m	4 ft. / 1.21m	10 ft. 3.04m	Directional	200°	10	14,400	120V 60Hz	0.6	20
		4 ft. / 1.21m			200°						
813-5-LEDSL-143100-360	100 ft. 30.48m	5 ft. / 1.52m	4 ft. / 1.21m	10 ft. 3.04m	Omni-directional	360°	10	14,400	120V 60Hz	0.6	20
		4 ft. / 1.21m			360°						
813-5-LEDSL-12350-DLV-CF	50 ft. ³ 15.24m	10 ft. / 3.04m	None	10 ft. 3.04m	Directional	200°	5	7,200	12V 60Hz	7.1	1
		None			200°						
817-6-LEDSL-14350-1	50 ft. 15.24m	6 ft. / 1.82m	6 ft. / 1.82m	12.5 ft. 3.81m	Directional	200°	4	3,600	120V 60Hz	0.31	25
		6 ft. / 1.82m			200°						
817-6-LEDSL-143100-1	100 ft. 30.48m	6 ft. / 1.82m	6 ft. / 1.82m	12.5 ft. 3.81m	Directional	200°	8	7,200	120V 60Hz	0.62	12
		6 ft. / 1.82m			200°						

Notes: 1) 100-277V 50/60Hz rated. Low-voltage models available on directional models only.

2) Based on a single 15A supply receptacle.

3) 12/3 SEOW yellow cable

4) Consult Ericson for custom assemblies.



ericson.com
ericson.com/rfq

1.800.ERICSON
1.800.374.2766



2600 Series

LED Explosion Proof String Lights

ericson.com/haz-sl

- cETLus listed for U.S. and Canada
- Class I & II, Div 1 & 2, groups C & D and F & G, explosion proof
- LED and incandescent bulb options
- Explosion proof plug option available
- Aluminum anti-spark guard
- Tempered glass globe provides 360° illumination
- Rubber bumper protects lamps during use
- Multiple string light configurations available
- Product customizations are available upon request



Part Number ¹	Total Length	# of Lamps	Bulb Type	Socket Spacing	Lead Cord Length	Plug
123100LEDXPI-BL	100 ft.	10	10W LED	8.33 ft.	25 ft.	Blunt
123100LEDXPI-1	100 ft.	10	10W LED	8.33 ft.	25 ft.	1510-PW6PL
12365LEDXPI-BL	65 ft.	5	10W LED	10 ft.	25 ft.	Blunt
12365LEDXPI-1	65 ft.	5	10W LED	10 ft.	25 ft.	1510-PW6PL

Notes: 1) Add "XP" suffix to any item (except blunt) to furnish explosionproof UGP-15231 NEMA5-15 plug

LED Explosion Proof

Low Voltage String Lights

ericson.com/haz-sl

- cETLus listed for U.S. and Canada
- Class I & II, Div 1 & 2, groups C & D and F & G, explosion proof
- 12VAC string light with Class I, Div 1 Killark style plug
- 8 W, 12 V LED bulbs deliver 500 lumens
- Aluminum anti-spark guard
- Tempered glass globe provides 360° Illumination
- Rubber bumper protects lamps during use
- Multiple string light drop configurations available
- Combine with portable transformer for a complete low voltage solution



Part Number ¹	Lead Cord Length	# of Lamps	Socket Spacing	Bulb Type	Supply Voltage	Plug
123100LEDXPI-5L-16	25 ft.	5	18.75 ft. centers	8 watt LED 12V AC	12V AC, 35 watt	UGP-15232 NEMA 6-15
123100LEDXPI-6L-16	25 ft.	6	15 ft. centers		12V AC, 42 watt	

¹ - Contact Ericson for 14 gauge configurations

Portable Transformer

ericson.com/lv-transformer

- cETLus listed for U.S. and Canada
- Class I, Div 2, non-incendive
- NEMA 3R polycarbonate enclosure with convenient carry handle
- 120VAC 60Hz to 12VAC step down, rated at 400VA
- Quad secondaries provide 12VAC power to 4 receptacles
- Each receptacle can supply power to 10-drop LED string light
- Class I, Div 1 rated decontactor-style receptacle
- Product customizations are available upon request



Part Number ¹	Input Power	Input Cable	Input Plug	Output	Number of Receptacles	Type of Receptacles	Enclosure Rating
1941-12-C1D2-16	120VAC / 60Hz	14/3 SEOW 6 ft. Pigtail	ENP5151	12 AC	4	UGRP-20232F NEMA 6-20	NEMA 4



ericson.com
ericson.com/rfq

1.800.ERICSON
1.800.374.2766



Temporary Lighting

57

Engineered Solutions: String Lights

String Light Customization Options

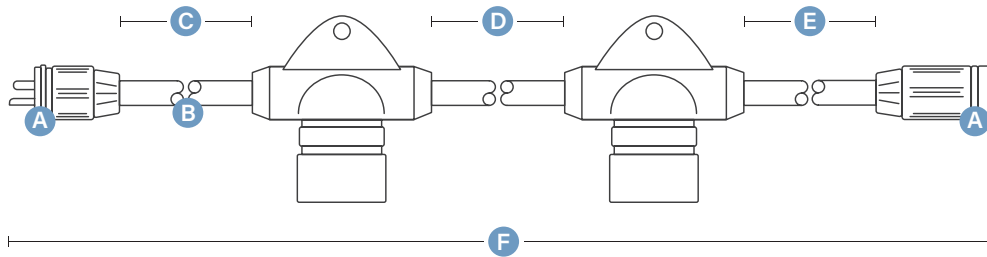

- A** Plug / connector NEMA configurations
- B** Cable length and cable type
- C** Primary cord length
- D** Socket spacing
- E** Secondary cord length
- F** Overall length

See all available string light customizations at ericson.com/rfq

Custom: String Lights



Ericson string lights in outdoor application

7 and 9 Series

Industrial Grade Hand Lamps

ericson.com/industrial-hl

- cETLus listed for U.S. and Canada
- Use with LED, incandescent, or CFL bulbs
- Molded flexible rubber handle impervious to impact and resistant to work site chemicals
- Standard NEMA 5-15 side outlet (9-series)
- Optional switch is available
- Low temperature performance
- Wide selection of pre-wired hand lamps and replacement parts
- 120V and 12V options
- Accommodates cord sizes up to 14/3 SOW
- Product customizations are available upon request



Replacement Parts



104-R

710

44-W

79

	Part Number ¹	Cord Length	Cord Type	Primary Plug	Bulb Type ¹	Guard Type	Handle Receptacle	On/off Switch
7-Series	7425-R	25 ft.	16/3 SOOW	NEMA 5-15	None	104-R	No	No
	7450-R	50 ft.	16/3 SOOW	NEMA 5-15	None	104-R	No	No
	7425-RS	25 ft.	16/3 SOOW	NEMA 5-15	None	104-R	No	Yes
	7450-RS	50 ft.	16/3 SOOW	NEMA 5-15	None	104-R	No	Yes
9-Series	9425-R	25 ft.	16/3 SOOW	NEMA 5-15	None	104-R	Yes	No
	9450-R	50 ft.	16/3 SOOW	NEMA 5-15	None	104-R	Yes	No
	9425-RS	25 ft.	16/3 SOOW	NEMA 5-15	None	104-R	Yes	Yes
	9450-RS	50 ft.	16/3 SOOW	NEMA 5-15	None	104-R	Yes	Yes

¹ - Bulbs are not included with hand lamps



ericson.com
ericson.com/rfq

1.800.ERICSON
1.800.374.2766



70-N Vapor-Gard®

Industrial Grade Hand Lamps

ericson.com/industrial-hl

- cETLus listed for U.S. and Canada
- Molded handle impervious to impact and resistant to jobsite chemicals
- Glass globe is heat and impact resistant and threads into handle sealing bulb and socket
- Guard is constructed out of heavy-gauge steel wire and finished with a Zinc-Chromate plating to resist corrosion
- Quick latch wire guard for easy bulb changes
- Nut and grommet system provides both cord strain relief and protection from moisture/dirt
- Pre-wired models come with 16/3 SOW cord and a watertight molded plug
- Bulb included with hand lamp
- Product customizations are available upon request



Part Number	Cord Length	Cord Type	Plug	Bulb Type	Lumens	Guard Type
70-NGQL	N/A	N/A	N/A	16W LED	1600	703
70-NGQL25	25 ft.	16/3 SOW	NEMA 5-15	16W LED	1600	703
70-NGQL50	50 ft.	16/3 SOW	NEMA 5-15	16W LED	1600	703
70-NGQL100	100 ft.	16/3 SOW	NEMA 5-15	16W LED	1600	703

910 Series

LED Hand Lamp

ericson.com/910-hl

- cULus listing pending
- Industrial grade, LED hand lamp designed for rugged environments
- Environmental ratings: NEMA 3R (IP24), 4X (IP56), & 6P (IP67)
- High output LED light engine providing 1440 lumens at 10 watts for a luminous efficacy of 144 lumens/watt
- Available in 200 and 360 degree beam angles
- Unique LED bulb provides theft deterrence
- 50,000-hour lamp life
- Patent D836238
- Hot stamping and custom cable printing available
- Product customizations are available upon request

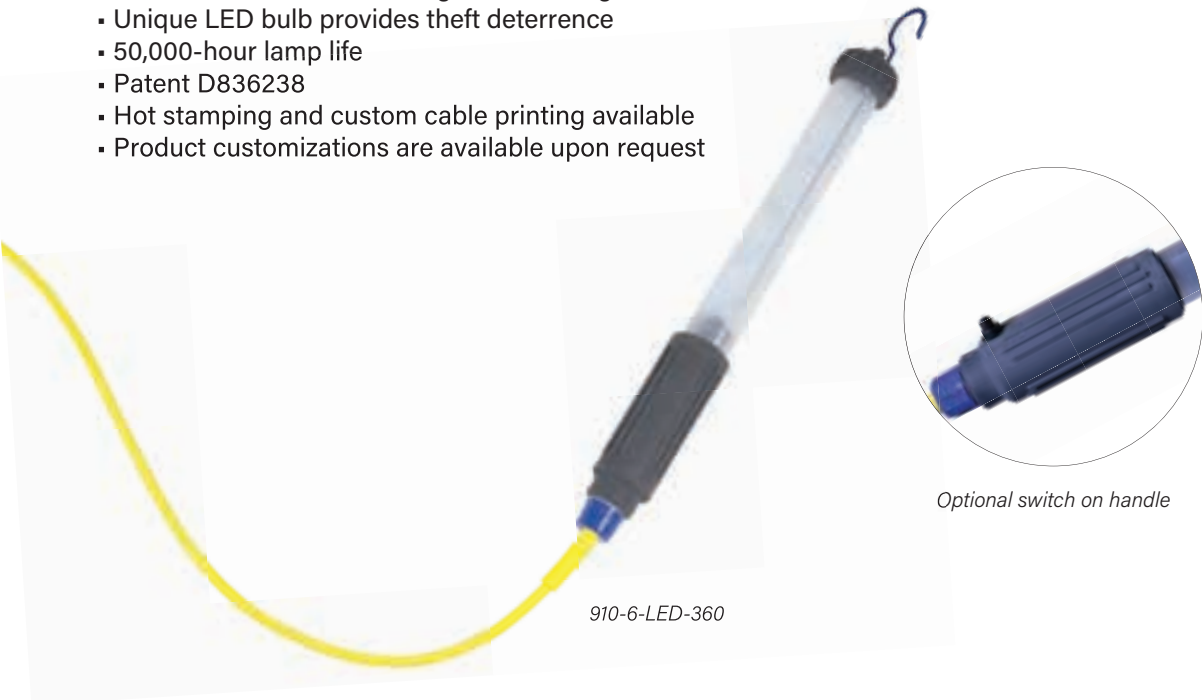

Optional switch on handle

910-6-LED-360

Part Number	Electrical Rating	Cord Length ¹	Cord Type	Plug	Lumens	Beam Angle	Color Temperature	On / Off Switch	NEMA / IP Ratings ²
910-25-LED-D	100-277VAC 50/60Hz	25 ft.	16/3 SOW	NEMA 5-15	1440	200°	5700K	No	NEMA 3R, 4X, 6P IP 24, 56, 67
910-25S-LED-D	100-277VAC 50/60Hz	25 ft.	16/3 SOW	NEMA 5-15	1440	200°	5700K	Yes	NEMA 3R, 4X IP 24, 56
910-25-LED-360	100-277VAC 50/60Hz	25 ft.	16/3 SOW	NEMA 5-15	1440	360°	5700K	No	NEMA 3R, 4X, 6P IP 24, 56, 67
910-25S-LED-360	100-277VAC 50/60Hz	25 ft.	16/3 SOW	NEMA 5-15	1440	360°	5700K	Yes	NEMA 3R, 4X IP 24, 56

¹ - All 910 models available in 6, 25 and 50 ft. cord lengths

² - NEMA 6P environmental rating is achieved in models without a switch. Models with a switch are rated NEMA 4X



ericson.com
ericson.com/rfq

1.800.ERICSON
1.800.374.2766



Temporary Lighting

61

1917, 1918, & 1950 Series

Low Voltage Spot & Flood Lighting

ericson.com/low-voltage-hl

- Impact resistant, non-glass lens for food & beverage processing environments
- Large rubberized cushion will not mar or scratch surfaces
- Optional weather-proof switch
- Spot light or flood light models available
- Optional 120V to 12V rubberized in-line transformer
- Nylon, non-metallic body
- Can be mounted to a cable reel as an accessory



1917 Spot Light



1950-12 Spot Light



GNC-B
Gooseneck Clamp

	Part Number	Electrical Rating	Primary Cord Length	Secondary Cord Length	Cable Type	Plug	Bulb Type	Beam Angle	Color Rendition ¹	Color Temperature	On/Off Switch
Spotlight	1917-12	120 V 60 Hz	4 ft.	50 ft.	16/3 SOOW	NEMA 5-15	#4405 / 30W	9°	95	2700 K	No
	1917-12S	120 V 60 Hz	4 ft.	50 ft.	16/3 SOOW	NEMA 5-15	#4405 / 30W	9°	95	2700 K	Yes
	1917LED-12	120 V 60 Hz	4 ft.	50 ft.	16/3 SOOW	NEMA 5-15	LED / 9W	15°	90	5500 K	No
	1917LED-12S	120 V 60 Hz	4 ft.	50 ft.	16/3 SOOW	NEMA 5-15	LED / 9W	15°	90	5500 K	Yes
	1950-12	12 VAC	50 ft.	None	16/3 SOOW	NEMA 5-15	#4405 / 30W	15°	95	2700 K	No
	1950-12 CF ²	12 VAC	50 ft.	None	16/3 SOOW	Crowsfoot	#4405 / 30W	15°	95	2700 K	No
Flood Light	1918-12	120 V 60 Hz	4 ft.	50 ft.	16/3 SOOW	NEMA 5-15	#4406 / 30W	80°	95	2700 K	No
	1918-12S	120 V 60 Hz	4 ft.	50 ft.	16/3 SOOW	NEMA 5-15	#4406 / 30W	80°	95	2700 K	Yes
	1918LED-12	120 V 60 Hz	4 ft.	50 ft.	16/3 SOOW	NEMA 5-15	LED / 9W	60°	90	5500 K	No
	1918LED-12S	120 V 60 Hz	4 ft.	50 ft.	16/3 SOOW	NEMA 5-15	LED / 9W	60°	90	5500 K	Yes

¹ - Based on a scale from 1-100. 100 equals to sunlight ² - Comes with watertight crowsfoot plug for CF series transformers

1948 Vapor-Gard®

Industrial Duty, Low Voltage Hand Lamps

ericson.com/low-voltage-hl

- Molded handle impervious to impact and resistant to work site chemicals
- Glass globe is heat and impact resistant and threads into handle sealing bulb and socket
- Guard is constructed out of heavy-gauge steel wire and finished with a Zinc-Chromate plating to resist corrosion
- Quick latch 703 guard makes bulb changes easy
- Nut and grommet system provides both cord strain relief and protection from moisture/dirt
- Pre-wired models come with 14/3 SOW cord and a watertight plug
- Combine with portable transformer for a complete low voltage solution
- Product customizations are available upon request



1948-12

Part Number	Voltage ¹	Cord Length	Cord Type	Plug	Bulb Type ¹	Guard Type
1948-12	12V	50 ft.	14/3 SOW	NEMA 5-15	12V Incandescent	703
1948-12CF	12V	50 ft.	14/3 SOW	Non-NEMA ²	12V Incandescent	703
1948-12LED-L	12V	50 ft.	14/3 SOW	Non-NEMA ²	12V LED	703

¹ - Voltage is determined by the bulb used

² - Non-NEMA crowsfoot configuration, 15/10 Amps, 125-250 Volts, 1Ø

Portable Transformer

ericson.com/low-voltage-hl

- Transformers convert 120 VAC/60Hz line voltage to 12 VAC
- Corrosion resistant enclosures are made from non-conductive resin that is resistant to impact and jobsite chemicals
- Outlets operate independently of each other—4 x 100VA outputs
- Circuit breakers wired individually to each receptacle and operate independently of each other – if one circuit opens the others continue to operate



1941-12

Part Number ¹	Input Power	Output Power	Cord Length	Cord Type	Plug Type	Number of Receptacles	Type of Receptacles	Enclosure Rating
1941-12	120VAC / 60Hz	12V, 400VA	6 ft.	14/3 SOW	NEMA 5-15	4	NEMA 5-15	NEMA 4
1941-12CF	120VAC / 60Hz	12V, 400VA	6 ft.	14/3 SOW	NEMA 5-15	4	Non-NEMA Crowsfoot	NEMA 4



1924 Series

Low Voltage Hand Lamp with In-Line Transformer

ericson.com/low-voltage-hl

- Step-down transformers reduce 120 VAC line voltage to 12 VAC
- Extra-thick walled rubber housing with non-corrosive stainless steel hardware protects transformer from jobsite contaminants
- Transformers incorporate a grounded metal shield between primary and secondary windings to ensure the two voltages are isolated providing an added degree of protection
- Each transformer is subjected to a factory dielectric test of 1600 volts between primary and secondary windings and between each winding and ground to ensure safety

1924-12A



Part Number	Input Power	Output Power	Max Wattage	Primary Cord Length	Primary Cord Type	Secondary Cord Length	Secondary Cord Type	Plug Type
1924-12A	120VAC / 60Hz	12V	100 watts	6 ft.	16/3 SOW	25 ft.	14/3 SOW	NEMA 5-15
1924-12B	120VAC / 60Hz	12V	100 watts	6 ft.	16/3 SOW	50 ft.	14/3 SOW	NEMA 5-15

910 Series

LED Low Voltage Hand Lamp

ericson.com/910-lv

- cULus listing pending for U.S. and Canada
- Industrial grade, LED hand lamp designed for rugged environments
- Environmental ratings: NEMA 3R (IP24), 4X (IP56), & 6P (IP67)
- High output LED light engine providing 1440 lumens at 10 watts for a luminous efficacy of 144 lumens/watt
- 200 degree beam angle
- Unique LED bulb provides theft deterrence
- 50,000-hour lamp life
- Field serviceable
- Patent pending
- Product customizations are available upon request



910-50S-LED-DLV

Part Number	Electrical Rating	Lumens	Beam Angle	Color Temperature	On / Off Switch	Low Voltage (12V) Transformer	NEMA / IP Ratings ¹	Plug Type
910-6S-LED-DLV	120VAC 60Hz only	1440	200°	5700K	Yes	Yes	NEMA 3R, 4X IP 24, 56	NEMA 5-15
910-25S-LED-DLV	120VAC 60Hz only	1440	200°	5700K	Yes	Yes	NEMA 3R, 4X IP 24, 56	NEMA 5-15
910-50S-LED-DLV	120VAC 60Hz only	1440	200°	5700K	Yes	Yes	NEMA 3R, 4X IP 24, 56	NEMA 5-15
910-6S-LED-DLV-CF	12V / 24V	1440	200°	5700K	Yes	No	NEMA 3R, 4X IP 24, 56	Crowsfoot
910-25S-LED-DLV-CF	12V / 24V	1440	200°	5700K	Yes	No	NEMA 3R, 4X IP 24, 56	Crowsfoot
910-50S-LED-DLV-CF	12V / 24V	1440	200°	5700K	Yes	No	NEMA 3R, 4X IP 24, 56	Crowsfoot

¹ - NEMA 6P environmental rating is achieved in models without a switch. Models with a switch are rated NEMA 4X



ericson.com
ericson.com/rfq

1.800.ERICSON
1.800.374.2766



2600 Series

LED Explosion Proof Hand Lamp

ericson.com/xp-hl

- cETLus listed for U.S. and Canada
- Class I & II, Div 1 & 2, Groups C, D, F & G
- 120VAC or 12VAC lamp with NEMA plug or XP plug
- Lightweight construction
- Aluminum anti-spark guard
- Non-conductive, high-impact glass reinforced handle
- Accommodates 16/3 to 14/3 types SOOW, STW, STOW cable
- High-impact tempered glass globe threads directly into specially designed guard assembly
- Handle construction provides superior strength and high insulation properties
- Heavy duty aluminum guard features swivel hook



Part Number ¹	Electrical Rating	Wattage	Cord Length / Cord Type	Bulb Type ²	Plug ³	Low Voltage
2600-LED	120VAC	11 watts	None Hand Lamp Only	LED	None	No
2600-LED-L	12VAC	8 watts	None Hand Lamp Only	LED	None	Yes
2625-LED	120VAC	11 watts	25 ft. / #14/3 SOOW	LED	NEMA Style	No
2625-LED-L	12VAC	8 watts	25 ft. / #14/3 SOOW	LED	NEMA Style	Yes

¹ - 2600 Series handlamps are available in 25, 50 and 100 ft. cord lengths

² - All bulbs included with handlamps

³ - Add (-XP) for explosion proof plug (N/A on -L)

1926 Series

LED Low Voltage Explosion Proof Hand Lamp with In-Line Transformer

ericson.com/low-voltage-hl

- Class I & II, Div 1 & 2 (hand lamp only)
- Step-down transformers reduce 120 VAC line voltage to 12 VAC
- Extra-thick walled rubber housing with non-corrosive stainless steel hardware protects transformer from work site contaminants
- Transformers incorporate a grounded metal shield between primary and secondary windings to ensure the two voltages are isolated providing an added degree of protection
- Each transformer is subjected to a factory dielectric test of 1600 volts between primary and secondary windings and between each winding and ground to ensure safety
- Explosion proof and shock resistant (transformer not hazardous location rated)
- Product customizations are available upon request



1926-12A-LED-L

Part Number	Input Power	Output Power	Max Wattage	Primary Cord Length	Primary Cord Type	Secondary Cord Length	Secondary Cord Type	Plug Type
1926-12A	120VAC / 60Hz	12V	75 watts	10 ft.	16/3 SOW	25 ft.	14/3 SOW	NEMA 5-15
1926-12B	120VAC / 60Hz	12V	75 watts	10 ft.	16/3 SOW	50 ft.	14/3 SOW	NEMA 5-15
1926-12A-LED-L	120VAC / 60Hz	12V	75 watts	10 ft.	16/3 SOW	25 ft.	14/3 SOW	NEMA 5-15
1926-12B-LED-L	120VAC / 60Hz	12V	75 watts	10 ft.	16/3 SOW	50 ft.	14/3 SOW	NEMA 5-15



1000 Series

LED Wide Area Work Lighting

ericson.com/wide-area

- cULus listed for U.S. and Canada
- Outdoor and wet location rated
- Strong integral mounting magnet
- LED efficient lighting technology
- 50,000-hour lamp life expectancy
- Standard models come wired with NEMA 5-15 plugs
- Optional feed-thru connectivity via secondary cable or receptacle with flip cover
- Driver located in main body
- Low temperature start at -30°C
- Color temperature 5000 Kelvin
- Product customizations are available upon request



1000LED-6



1001LED-6



Part Number	Electrical Rating	Watts	Primary Cord Length / Plug	Secondary Cord Length / Connector	Switch	Color Rendition	Lumens	Listing
1000LED-25	100-240 VAC	50 watts	25 ft. / NEMA 5-15	None	No	70	6450	cULus
1000LED-25S	100-240 VAC	50 watts	25 ft. / NEMA 5-15	None	Yes	70	6450	cULus
1000LED-25F	100-240 VAC	50 watts	25 ft. / NEMA 5-15	1 ft. / NEMA 5-15	No	70	6450	cULus
1000LED-25FS	100-240 VAC	50 watts	25 ft. / NEMA 5-15	1 ft. / NEMA 5-15	Yes	70	6450	cULus
1001LED-25 ¹	100-277 VAC	25 watts	25 ft. / NEMA 5-15	None	No	80	3400	Pending
1001LED-25S	100-277 VAC	25 watts	25 ft. / NEMA 5-15	None	Yes	80	3400	Pending
1001LED-25R	100-277 VAC	25 watts	25 ft. / NEMA 5-15	Built in receptacle	No	80	3400	Pending
1001LED-25RS	100-277 VAC	25 watts	25 ft. / NEMA 5-15	Built in receptacle	Yes	80	3400	Pending

1) 1000 & 1001 Series are available in primary cord lengths of 6, 25, and 50 ft.

800 Series

LED Heavy Duty Work Lighting

ericson.com/wide-area

- cULus listed for U.S. and Canada
- Outdoor and wet location rated
- Lightweight, heavy duty and impact resistant material
- Feed-thru connectivity
- Low power utilization and consumption
- 50,000-hour lamp life
- Flex strain relief at critical bending points
- Sealed switch option available
- Low voltage options available



Part Number	Electrical Rating	Amperage	Primary Cord Length / Type ¹	Secondary Cord Length / Type	Primary & Secondary Plug Type	Bulb Type	Lumens
825-25-LED	120V 60Hz	150mA	25 ft. / 16/3 SOOW	Blunt	NEMA 5-15	LED T8	1358
825-25S-LED	120V 60Hz	150mA	25 ft. / 16/3 SOOW	Blunt	NEMA 5-15	LED T8	1358
825-4F-LED	120V 60Hz	150mA	4 ft. / 14/3 SJOW	10 in. / 14/3 SJOW	NEMA 5-15	LED T8	1358
825-25F-LED	120V 60Hz	150mA	25 ft. / 14/3 SJOW	10 in. / 14/3 SJOW	NEMA 5-15	LED T8	1358
825-25FS-LED	120V 60Hz	150mA	25 ft. / 14/3 SJOW	10 in. / 14/3 SJOW	NEMA 5-15	LED T8	1358
832-25-LED	120V 60Hz	190mA	25 ft. / 16/3 SOOW	Blunt	NEMA 5-15	LED T8	1735
832-25S-LED	120V 60Hz	190mA	25 ft. / 16/3 SOOW	Blunt	NEMA 5-15	LED T8	1735
832-4F-LED	120V 60Hz	190mA	4 ft. / 14/3 SJOW	10 in. / 14/3 SJOW	NEMA 5-15	LED T8	1735
832-25F-LED	120V 60Hz	190mA	25 ft. / 14/3 SJOW	10 in. / 14/3 SJOW	NEMA 5-15	LED T8	1735
832-25FS-LED	120V 60Hz	190mA	25 ft. / 14/3 SJOW	10 in. / 14/3 SJOW	NEMA 5-15	LED T8	1735
840-25-LED	120V 60Hz	220mA	25 ft. / 16/3 SOOW	Blunt	NEMA 5-15	LED T8	2160
840-25S-LED	120V 60Hz	220mA	25 ft. / 16/3 SOOW	Blunt	NEMA 5-15	LED T8	2160
840-25F-LED	120V 60Hz	220mA	25 ft. / 14/3 SJOW	10 in. / 14/3 SJOW	NEMA 5-15	LED T8	2160
840-25FS-LED	120V 60Hz	220mA	25 ft. / 14/3 SJOW	10 in. / 14/3 SJOW	NEMA 5-15	LED T8	2160

¹ - Primary cord length available in 4, 25 and 50 ft.



1140 Series

LED Heavy Duty Work Lighting

ericson.com/1140

- Outdoor and wet location rated
- Feed-thru connectivity option
- Low power utilization and consumption
- Lightweight, heavy duty and impact resistant material
- Fixture can be mounted horizontally overhead or vertically on the ground
- 50,000-hour lamp life
- Battery backup available with -EL part numbers



1140-25-LED



Vertical Light Stand



1140-25F-LED

	Part No.	Electrical Rating	Primary Cord Length (feet)	Secondary Cord Length (feet)	Primary Plug (NEMA)	Secondary Connector (NEMA)	Lumens	Color	Weight
Standard LED Lighting	1140-4-LED	120VAC 1.67A	5 ft.	None	5-15	None	24,000	5000K	20.7 lbs.
	1140-4F-LED	120VAC 12A	5 ft.	1 ft.	5-15	5-15	24,000	5000K	21.5 lbs.
	1140-25-LED	120VAC 1.67A	25 ft.	None	5-15	None	24,000	5000K	22.3 lbs.
	1140-25F-LED	120VAC 12A	25 ft.	1 ft.	5-15	5-15	24,000	5000K	24.1 lbs.
	1140-50-LED	120VAC 1.67A	50 ft.	None	5-15	None	24,000	5000K	24.4 lbs.
	1140-50F-LED	120VAC 12A	49.5 ft.	.5 ft.	5-15	5-15	24,000	5000K	27.4 lbs.
Emergency Egress Lighting	1140-4-LED-EL	120VAC 1.67A	5 ft.	None	5-15	None	24,000	5000K	24.4 lbs.
	1140-4F-LED-EL	120VAC 12A	5 ft.	.5 ft.	5-15	5-15	24,000	5000K	25.3 lbs.
	1140-25-LED-EL	120VAC 1.67A	25 ft.	None	5-15	None	24,000	5000K	26.1 lbs.
	1140-25F-LED-EL	120VAC 12A	25 ft.	.5 ft.	5-15	5-15	24,000	5000K	27.9 lbs.
	1140-50-LED-EL	120VAC 1.67A	50 ft.	None	5-15	None	24,000	5000K	28.1 lbs.
	1140-50F-LED-EL	120VAC 12A	49.5 ft.	.5 ft.	5-15	5-15	24,000	5000K	31.1 lbs.

NEW AND IMPROVED!
NOW WITH 24,000 LUMENS

1009 Task Light

LED Hazardous Location Lighting

ericson.com/1009

- cETLus listed for U.S. and Canada
- Class I, Division 2, Groups A,B,C,D
- Class II, Division 1, Groups E,F,G
- Class II, Division 2, Groups E,F,G
- Class III
- NEMA 4X, IP66
- T3 temperature rating
- Marine and wet location rated
- High efficacy: up to 140lm/W
- CRI>70
- Surface mounting and pendant installation
- Copper free aluminum
- High vibration resistance
- 5 year warranty
- Ambient temperature range: -40°C to 60°C



Product Number	Wattage	CCT	Voltage	Lumens	Working Hours	CRI
1009-HAZ-60	60	4000K-5700K	AC100-277V	8400	5 years	70
1009-HAZ-80	80	4000K-5700K	AC100-277V	11200	5 years	70



ericson.com
ericson.com/rfq

1.800.ERICSON
1.800.374.2766



1004 LED Baylite

High Bay Lighting

ericson.com/1004

- cETLus listed for U.S. and Canada
- DLC rating
- 150 watt LED baylite
- Wet location rated, IP65
- Use as temporary light or permanent fixture
- Dimmer capability
- Immediate full intensity output
- Simple mounting
- 50,000-hour lamp life



Part Number	Input Voltage	Input Wattage	Power Factor	Lumens	Efficiency	CRI	Color Temperature	Beam Angle	Input Power Cord
1004-LED-120	100-277 VAC 50/60 Hz	150 Watts	>0.9	19,000	127 lumens/ watt	>80	5000K	120°	3 ft. Blunt 18/3SJTW

Optional Accessories



1004-LED-Hook

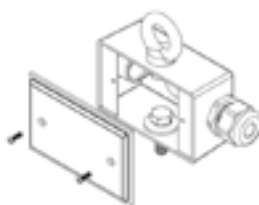

1004-LED-Box



1510-P



1510-PW6P

Part Number	Part Description
1004-LED-Hook	3/8 in. Stainless Steel Hook
1004-LED-Box	Conduit Termination Box Kit
1510-PW6P / 1510-P	Watertight industrial plug or commercial grade plug options, other NEMA configurations available
PS14390-3	90 ft. power stringer, indoor rated, 3 NEMA 5-15 receptacles every 30 ft.
PS3R14390-3	90 ft. power stringer, outdoor rated, 3 NEMA 5-15 receptacles every 30 ft.

1007 LED Baylite

Explosion Proof High Bay Lighting

ericson.com/1007

- cETLus listed for U.S. and Canada
- Class I, Division 1, Groups C, D
- Class I, Division 2, Groups A,B,C,D
- Class II, Division 1, Groups E,F,G
- Class II, Division 2, Groups E,F,G
- Class III
- NEMA 4X, IP66
- T4 temperature rating
- Marine and wet location rated
- High efficacy: up to 140lm/W
- CRI>70
- Surface mounting and pendant installation
- Copper free aluminum
- High vibration resistance
- 5 year warranty
- Ambient temperature range: -40°C to 60°C



Product Number	Wattage	CCT	Voltage	Lumens	Working Hours	CRI
1007-XP-100	100	5000K	AC100-277V	14000	5 years	70
1007-XP-150	150	5000K	AC100-277V	21000	5 years	70



ericson.com
ericson.com/rfq

1.800.ERICSON
 1.800.374.2766



1005 LED Hi/Lo Baylite

Hi/Lo Bay Lighting

ericson.com/1005

- Available as a single socket light fixture or multiple socket string light
- Overmolded lamp fixture with tough wire guard
- Easily convert from a high to low bay lighting fixture
- Indoor and outdoor use - wet location rated when proper bulb and/or guard is used
- Customizable to fit your work site needs
- Select models UL listed



Single Socket Style



LED100WDL Bulb



LED120W Bulb



CFL100W Bulb



LED10W Bulb



String Light Style

*Bulb is not included

Single Socket Style

Part Number	Product Description
1005-P-250-0	Single socket, 250 wire guard, 3 ft. 14/3 SJTOW blunt primary cord
1005-P-250-1	Single socket, 250 wire guard, 3 ft. 14/3 SJTOW molded NEMA 5-15 plug
1005-P-250-1-LP	Single socket, 250 wire guard, 3 ft. 14/3 SJTOW molded NEMA 5-15 plug, 25 ft. long primary.
1005-PS-250-0	Single socket, 250 wire guard, 3 ft. 14/3 SJTOW blunt primary cord & 3 ft. blunt feed-thru cord
1005-PS-250-1	Single socket, 250 wire guard, 3 ft. 14/3 SJTOW primary cord & 3 ft. feed-thru cord with molded NEMA 5-15 plug and connector
1005-P-215-0	Single socket, 215 lexan guard, 3 ft. 14/3 SJTOW blunt primary cord
1005-P-215-1	Single socket, 215 lexan guard, 3 ft. 14/3 SJTOW molded NEMA 5-15 plug
1005-PS-215-0	Single socket, 215 lexan guard, 3 ft. 14/3 SJTOW blunt primary cord & 3 ft. blunt feed-thru cord
1005-PS-215-1	Single socket, 215 lexan guard, 3 ft. 14/3 SJTOW primary cord & 3 ft. feed-thru cord with molded NEMA 5-15 plug and connector

String Light Style

Part Number	Product Description
1005-14340-250-1	2 sockets, 40' OAL, 20' socket spacing, 250 wire guard, mogul base socket adapters included
1005-14380-250-1	4 sockets, 80' OAL, 20' socket spacing, 250 wire guard, mogul base socket adapters included
1005-14375-250-1	3 sockets, 75' OAL, 25' socket spacing, 250 wire guard, mogul base socket adapters included

*String light orders also include 215 rain guards for application versatility.

Boiler Lighting

Specialty Lighting

ericson.com/boiler

- Boiler lights can fit through a sight hole of 1.8" in diameter and larger
- 500 watt tungsten light at 8800 lumens
- Curved handle is optional for greater mobility
- 120 volt operation
- Welded steel cage protects bulb
- Grounded metal tube handle
- Not recommended for hazardous locations
- Couple with in-line GFCI for confined space use
- LED options are available upon request



Part Number	Electrical Rating	Cord Length	Cord Type	Primary Plug	Bulb Type / Wattage	Handle Type	Total Fixture Length
BL500S	120V	5 ft.	SOW	NEMA 5-15	Tungsten / 500W	Straight	32 in.
BL500	120V	5 ft.	SOW	NEMA 5-15	Tungsten / 500W	Curved	25 in. (straight) 9 in. (curve)
BL500M	120V	5 ft.	SOW	NEMA 5-15	Tungsten / 500W	Straight	32 in.



1239 Series

LED Emergency Egress Lighting

ericson.com/1239

- 90 Minute battery backup maintains lighting during loss of power
- Indoor and outdoor wet location rated
- Lightweight, heavy duty and impact resistant materials reduce maintenance and replacement costs
- Feed-thru capability available on all models
- 25,000-hour lamp life
- Low power utilization and consumption
- Non-conductive base with cord egress
- Optional magnetic mount



	Part No.	Electrical Rating	Primary Cord Length (feet)	Secondary Cord Length (feet)	Primary Plug (NEMA)	Secondary Connector (NEMA)	Lumens	Color	Weight
Standard LED Lighting	1239-6-LED	120VAC .73A 88W	5 ft	None	5-15	None	13400	5000K	11.8 lbs.
	1239-6F-LED	120VAC 12A 1500W	5 ft	.5 ft	5-15	5-15	13400	5000K	12.6 lbs.
	1239-25-LED	120VAC .73A 88W	25 ft	None	5-15	None	13400	5000K	13.4 lbs.
	1239-25F-LED	120VAC 12A 1500W	25 ft	.5 ft	5-15	5-15	13400	5000K	15.2 lbs.
	1239-50-LED	120VAC .73A 88W	50 ft	None	5-15	None	13400	5000K	15.5 lbs.
	1239-50F-LED	120VAC 12A 1500W	49.5 ft	.5 ft	5-15	5-15	13400	5000K	18.5 lbs.
Emergency Egress Lighting	1239-6-LED-EL	120VAC .76A 92W	5 ft	None	5-15	None	13400	5000K	15.5 lbs.
	1239-6F-LED-EL	120VAC 12A 1500W	5 ft	.5 ft	5-15	5-15	13400	5000K	16.4 lbs.
	1239-25-LED-EL	120VAC .76A 92W	25 ft	None	5-15	None	13400	5000K	17.2 lbs.
	1239-25F-LED-EL	120VAC 12A 1500W	25 ft	.5 ft	5-15	5-15	13400	5000K	19 lbs.
	1239-50-LED-EL	120VAC .76A 92W	50 ft	None	5-15	None	13400	5000K	19.2 lbs.
	1239-50F-LED-EL	120VAC 12A 1500W	49.5 ft	.5 ft	5-15	5-15	13400	5000K	22 lbs.

1000F-EMBT Series

Emergency Egress Lighting

ericson.com/1000f

- Battery backup provides 90 minutes of illumination upon power failure
- Battery automatically charges when fixture is connected to power
- 3600 lumens on AC power, 1800 lumens on battery backup
- Dual 26W fluorescent bulbs
- Switch operates for testing and main on/off
- Internal battery/ballast combo
- Impact resistant, high-temperature lens with inner surface prisms for optimal light diffusion
- 4000K color temperature, 82 CRI
- Mounts with magnet base
- Includes safety hook for tethering



Part Number	Electrical Rating	Cord Length	Cord Type	Primary Plug	Bulb Type	Environmental Rating	Lumens
1000F-EMBT	120VAC / 60Hz / 52W	6 ft.	16/3 SOOW	NEMA 5-15	26W (2)	Outdoor / wet location	3600 - AC Power 1800 - Battery Backup
1000F-EMBT-25	120VAC / 60Hz / 52W	25 ft.	16/3 SOOW	NEMA 5-15	26W (2)	Outdoor / wet location	3600 - AC Power 1800 - Battery Backup
1000F-EMBT-50	120VAC / 60Hz / 52W	50 ft.	16/3 SOOW	NEMA 5-15	26W (2)	Outdoor / wet location	3600 - AC Power 1800 - Battery Backup



ericson.com
ericson.com/rfq

1.800.ERICSON
1.800.374.2766



Temporary Lighting Options & Customs

String Light & Hand Lamp Options

Cable Finish

- A** Custom color
- B** Cable personalization / stamping

Environmental Accommodations

- Indoor, outdoor or hazardous
- C** Plug type
- Socket / lamp style

Mounting

- H** Magnet base mounting
- Alternate hook options
- Adjustable clamp mounting base¹

Handle Finish¹

- D** Custom color

¹ - Hand lamp only options

Other Lighting Options

Mounting

- E** Custom brackets
- F** Mounting stands

Theft Deterrence

- G** RFID tagging and/or main gate theft alert system



Temp Lighting Layout / Calculation Services

Contact us for a complementary estimate



Temporary Lighting Layout Calculation

Room Estimator — Layout 1 — "Project Title" — 0000sqf

Luminaire Details

Luminaire image

Room Dimensions

Room Reflectance

Results

Layout

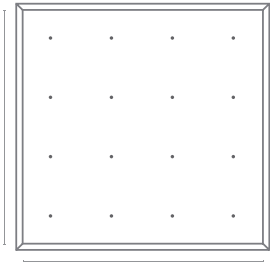
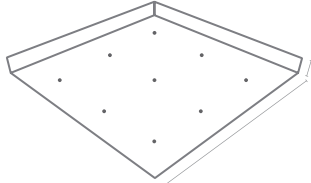

Representation only

Upload your project documents
and drawings at ericson.com/layout >> 



4323 Hamann Parkway Willoughby, OH 44094



100
YEARS STRONG
ERICSON



SAFETY IS OUR STANDARD.