

Promethean

Multimedia Projector

MODEL: UST-P2, UST-P1V1
UST-P2C, UST-P1CV1

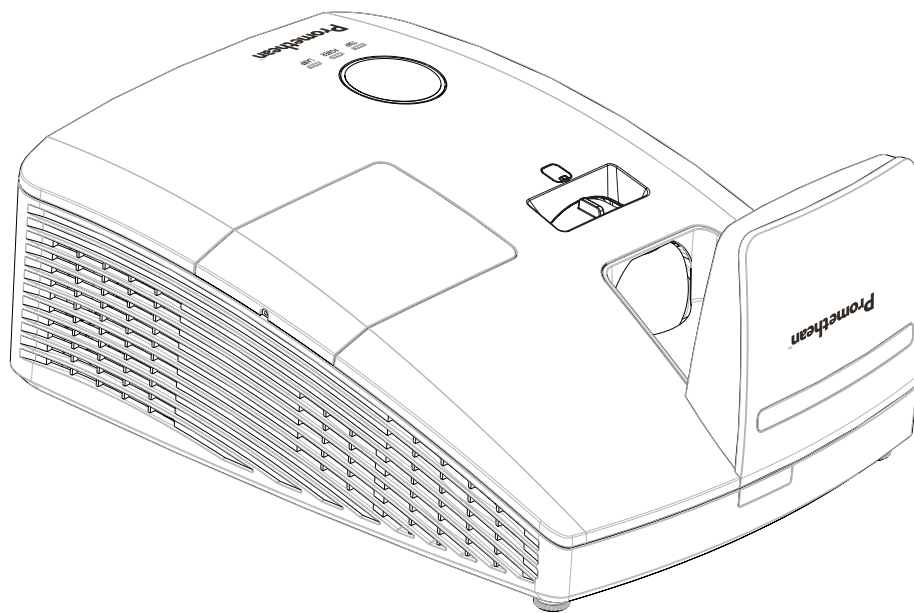

PROJECTOR

Owner's Manual

TP-2056-V01

PROMETHEAN LTD
PROMETHEAN HOUSE
LOWER PHILIPS ROAD
BLACKBURN
BB1 5TH
UNITED KINGDOM
(44) 1254 298 598

Copyright

This publication, including all photographs, illustrations and software, is protected under international copyright laws, with all rights reserved. Neither this manual, nor any of the material contained herein, may be reproduced without written consent of the author.

© Copyright 2012

Disclaimer

The information in this document is subject to change without notice. The manufacturer makes no representations or warranties with respect to the contents hereof and specifically disclaims any implied warranties of merchantability or fitness for any particular purpose. The manufacturer reserves the right to revise this publication and to make changes from time to time in the content hereof without obligation of the manufacturer to notify any person of such revision or changes.

Trademark Recognition

Kensington is a U.S. registered trademark of ACCO Brand Corporation with issued registrations and pending applications in other countries throughout the world.



HDMI, the HDMI Logo, and High-Definition Multimedia Interface are trademarks or registered trademarks of HDMI Licensing LLC in the United States and other countries.

All other product names used in this manual are the properties of their respective owners and are acknowledged.

Important Safety Information



Important:

It is strongly recommended that you read this section carefully before using the projector. These safety and usage instructions will ensure that you enjoy many years of safe use of the projector. Keep this manual for future reference.

Symbols Used

Warning symbols are used on the unit and in this manual to alert you of hazardous situations. The following styles are used in this manual to alert you to important information.

Note:

Provides additional information on the topic at hand.



Important:

Provides additional information that should not be overlooked.



Caution:

Alerts you to situations that may damage the unit.



Warning:

Alerts you to situations that may damage the unit, create a hazardous environment, or cause personal injury.

Throughout this manual, component parts and items in the OSD menus are denoted in bold font as in this example:

“Push the **Menu** button on the remote control to open the **Main** menu.”

General Safety Information

- Do not open the unit case. Aside from the projection lamp, there are no user-serviceable parts in the unit. For servicing, contact qualified service personnel.
- Follow all warnings and cautions in this manual and on the unit case.
- The projection lamp is extremely bright by design. To avoid damage to eyes, do not look into the lens when the lamp is on.
- Do not place the unit on an unstable surface, cart, or stand.
- Avoid using the system near water, in direct sunlight, or near a heating device.
- Do not place heavy objects such as books or bags on the unit.

Projector Installation Notice

- Place the projector in a horizontal position
The tilt angle of the projector should not exceed 15 degrees, nor should the projector be installed in any way other than the desktop and ceiling mount, otherwise lamp life could decrease dramatically.
- Allow at least 50 cm clearance around the exhaust vent.
- Ensure that the intake vents do not recycle hot air from the exhaust vent.
- When operating the projector in an enclosed space, ensure that the surrounding air temperature within the enclosure does not exceed operation temperature while the projector is running, and the air intake and exhaust vents are unobstructed.
- All enclosures should pass a certified thermal evaluation to ensure that the projector does not recycle exhaust air, as this may cause the device to shutdown even if the enclosure temperature is within the acceptable operation temperature range.

Power Safety

- Only use the supplied power cord.
- Do not place anything on the power cord. Place the power cord where it will not be in the way of foot traffic.
- Remove the batteries from the remote control when storing or not in use for a prolonged period.

<p>Note: RG1 IEC 62471-5:2015</p>
--

Replacing the Lamp

Replacing the lamp can be hazardous if done incorrectly. See [Replacing the Projection Lamp](#) on page 41 for clear and safe instructions for this procedure. Before replacing the lamp:

- Unplug the power cord.
- Allow the lamp to cool for about one hour.

Cleaning the Projector

- Unplug the power cord before cleaning. See [Cleaning the Projector](#) on page 44.
- Allow the lamp to cool for about one hour.

Regulatory Warnings

Before installing and using the projector, read the regulatory notices in the [Regulatory Compliance](#) section on page 56.

Important Recycle Instructions:



Lamp(s) inside this product contain mercury. This product may contain other electronic waste that can be hazardous if not disposed of properly. Recycle or dispose in accordance with local, state, or federal Laws. For more information, contact the Electronic Industries Alliance at WWW.EIAE.ORG. For lamp specific disposal information check WWW.LAMPRECYCLE.ORG.

Symbol Explanations



DISPOSAL: Do not use household or municipal waste collection services for disposal of electrical and electronic equipment. EU countries require the use of separate recycling collection services.

About this manual

This manual is intended for end users and describes how to install and operate the DLP projector. Wherever possible, relevant information—such as an illustration and its description—has been kept on one page. This printer-friendly format is both for your convenience and to help save paper, thereby protecting the environment. It is suggested that you only print sections that are relevant to your needs.

Table of Contents

GETTING STARTED.....	1
PACKING CHECKLIST.....	1
VIEWS OF PROJECTOR PARTS.....	2
<i>Front-right View</i>	2
<i>Rear view</i>	3
<i>Bottom view</i>	4
REMOTE CONTROL PARTS.....	5
REMOTE CONTROL OPERATING RANGE.....	7
PROJECTOR AND REMOTE CONTROL BUTTONS.....	7
SETUP AND OPERATION.....	8
INSERTING THE REMOTE CONTROL BATTERIES.....	8
STARTING AND SHUTTING DOWN THE PROJECTOR.....	9
SETTING AN ACCESS PASSWORD (SECURITY LOCK).....	10
ADJUSTING THE PROJECTOR LEVEL.....	12
ADJUSTING THE FOCUS AND KEYSTONE.....	13
ON-SCREEN DISPLAY (OSD) MENU SETTINGS.....	14
OSD MENU CONTROLS.....	14
<i>Navigating the OSD</i>	14
SETTING THE OSD LANGUAGE.....	15
OSD MENU OVERVIEW.....	16
IMAGE MENU.....	19
<i>Advanced Feature</i>	20
<i>Color Manager</i>	21
COMPUTER MENU.....	22
VIDEO MENU.....	23
INSTALLATION I MENU.....	24
<i>ActivBoard Installation</i>	25
<i>Advanced Feature</i>	26
INSTALLATION II MENU.....	27
<i>Advanced Feature</i>	28
<i>OSD Menu Setting</i>	29
<i>Peripheral Test</i>	29
<i>Lamp Hour Reset</i>	30
<i>3D</i>	30
<i>Network</i>	31
<i>Factory Reset</i>	40
<i>Status</i>	40
MAINTENANCE AND SECURITY.....	41
REPLACING THE PROJECTION LAMP.....	41
<i>Resetting the Lamp</i>	43
CLEANING THE PROJECTOR.....	44
<i>Cleaning the Projector Mirror</i>	44
<i>Cleaning the Case</i>	45
USING THE PHYSICAL LOCK.....	46
<i>Using the Kensington® Lock</i>	46
<i>Using the Security Bar</i>	46
TROUBLESHOOTING.....	47
COMMON PROBLEMS AND SOLUTIONS.....	47
TIPS FOR TROUBLESHOOTING.....	47
LED ERROR MESSAGES.....	48
IMAGE PROBLEMS.....	48
LAMP PROBLEMS.....	49
REMOTE CONTROL PROBLEMS.....	49
HAVING THE PROJECTOR SERVICED.....	49
SPECIFICATIONS.....	50

SPECIFICATIONS.....	50
PROJECTION DISTANCE VS. PROJECTION SIZE.....	51
<i>Projection Distance and Size Table</i>	51
TIMING MODE TABLE.....	52
PROJECTOR DIMENSIONS.....	55
REGULATORY COMPLIANCE.....	56
FCC WARNING.....	56
CANADA.....	56
SAFETY CERTIFICATIONS.....	56

Packing Checklist

Carefully unpack the projector and check that the following items are included:

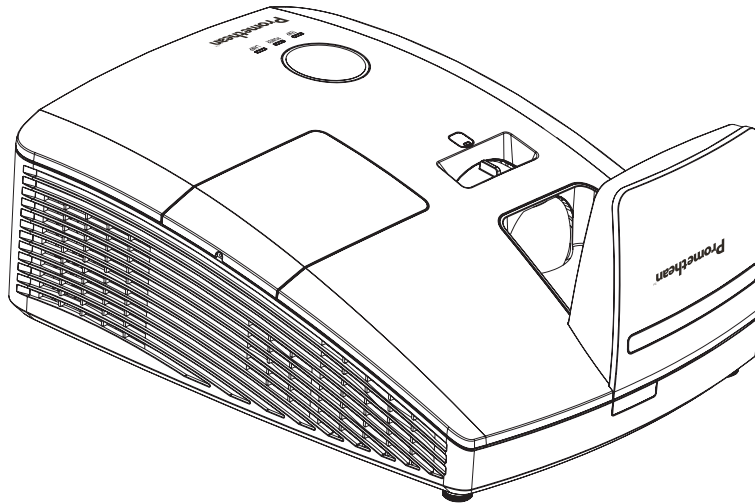

DLP PROJECTOR



*REMOTE CONTROL
(WITH TWO AAA BATTERIES)*



*CD-ROM
(THIS USER'S MANUAL)*

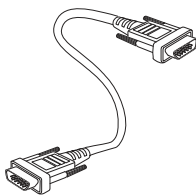

RGB CABLE

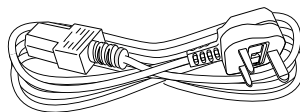

REGIONAL POWER CORD

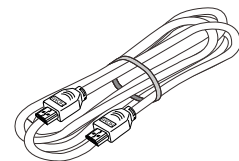

HDMI CABLE

Contact your dealer immediately if any items are missing, appear damaged, or if the unit does not work. It is recommended that you keep the original packing material should you ever need to return the equipment for warranty service.



Caution:
Avoid using the projector in dusty environments.

Views of Projector Parts

Front-right View

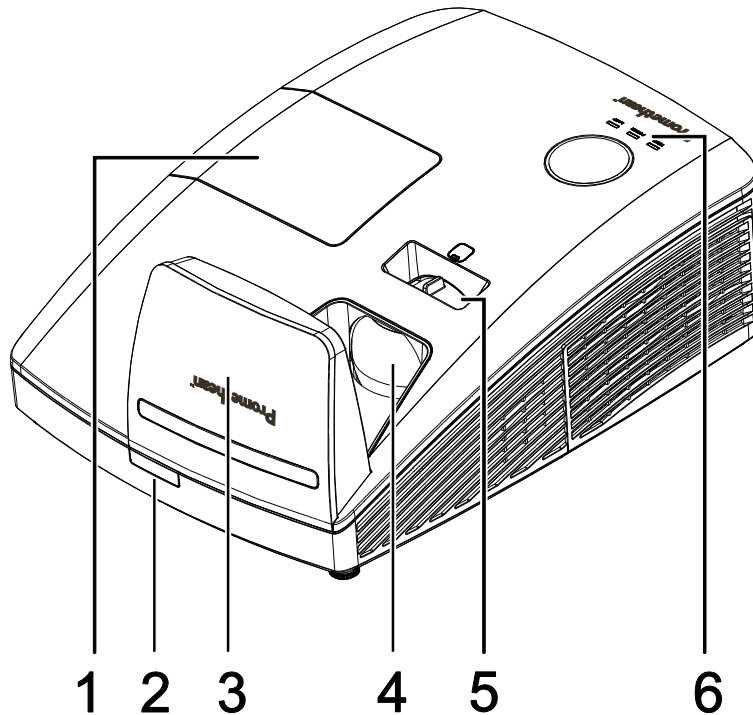

ITEM	LABEL	DESCRIPTION		SEE PAGE:
1.	Lamp cover	Removes cover to replace lamp or color wheel		
2.	IR receiver	Receives IR signal from remote control		
3.	Aspheric mirror	Reflects images		
4.	Lens	Projection Lens		
5.	Focus ring	Focuses the projected image		
6.	TEMP LED	Red	Error code	48
	LAMP LED	Amber	Lamp Error	
		Flashing	Error code	
	POWER LED	Flashing	Error code , System warm up, Cooling	
Green		Power On, Ready to power on (Standby)		



Important:

Ventilation openings on the projector allow for good air circulation, which keeps the projector lamp cool. Do not obstruct any of the ventilation openings.

Rear view

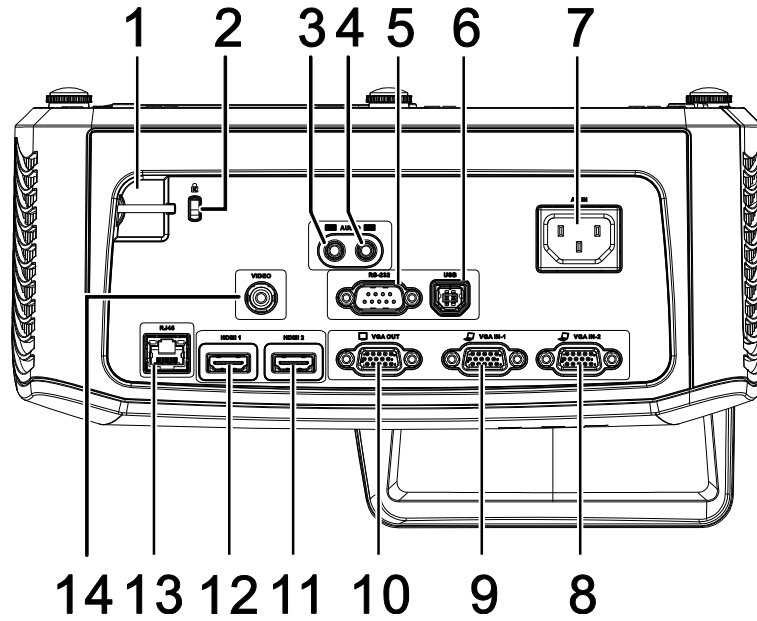

ITEM	LABEL	DESCRIPTION	SEE PAGE:
1.	Security bar	For security and authorized usage	46
2.	Kensington lock	Secure to permanent object with a Kensington® Lock system	
3.	AUDIO IN	Connect an AUDIO cable from the audio device	
4.	AUDIO OUT	Connect an AUDIO cable to an audio amplifier	
5.	RS-232	Connect RS-232 serial port cable for remote control	
6.	USB	Connect the USB cable from a computer	
7.	AC IN	Connect the POWER cable	9
8.	VGA – 2	Connect the RGB cable from a computer and components	
9.	VGA – 1	Connect the RGB cable from a computer and components	
10.	VGA OUT	Connect the RGB cable to a display (Loop Thru only for VGA IN-1)	
11.	HDMI 2	Connect the HDMI cable from a HDMI device	
12.	HDMI 1	Connect the HDMI cable from a HDMI device	
13.	RJ – 45	Connect a LAN cable from Ethernet	
14.	VIDEO	Connect the composite cable from a video device	

Note:

If your video equipment has various input sources, it is recommended to connect in priority of HDMI/DVI, component (thru VGA), Composite for better picture quality.



Warning:

As a safety precaution, disconnect all power to the projector and connecting devices before making connections.

Bottom view

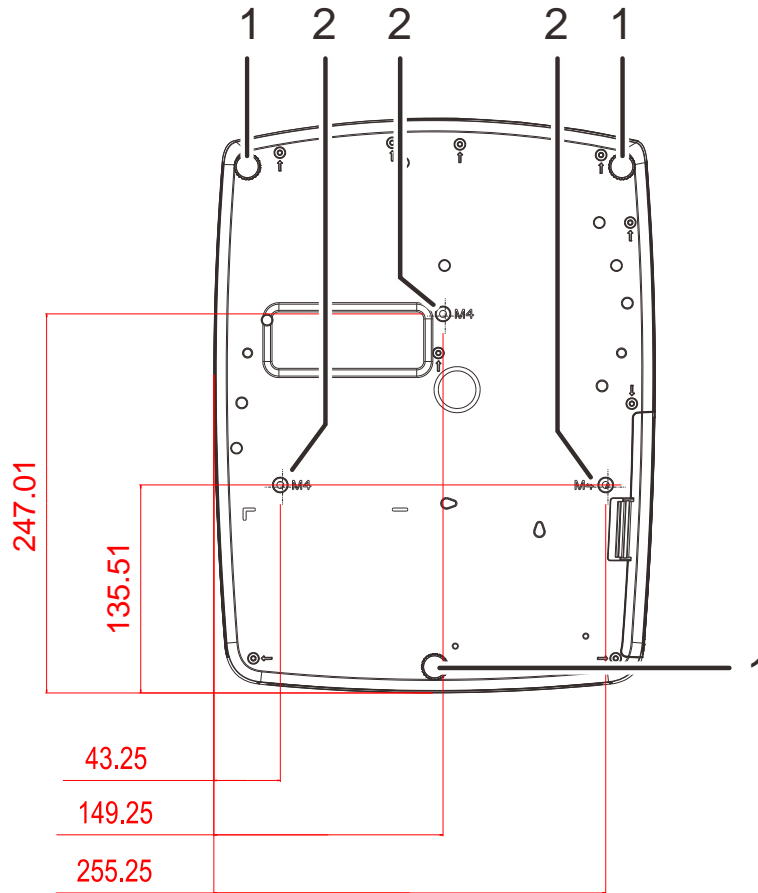

ITEM	LABEL	DESCRIPTION	SEE PAGE:
1.	Tilt adjustor	Rotate adjuster lever to adjust angle position	12
2.	Ceiling support holes	Contact your dealer for information on mounting the projector on a ceiling	

Note:

When installing, ensure that you use only UL Listed ceiling mounts.

For ceiling installations, use approved mounting hardware and M4 screws with a maximum screw depth of 12 mm (0.47 inch).

The construction of the ceiling mount must be of a suitable shape and strength. The ceiling mount load capacity must exceed the weight of the installed equipment, and as an additional precaution be capable of withstanding three times the weight of the equipment (not less than 5.15 kg) over a period of 60 seconds.

Remote Control Parts

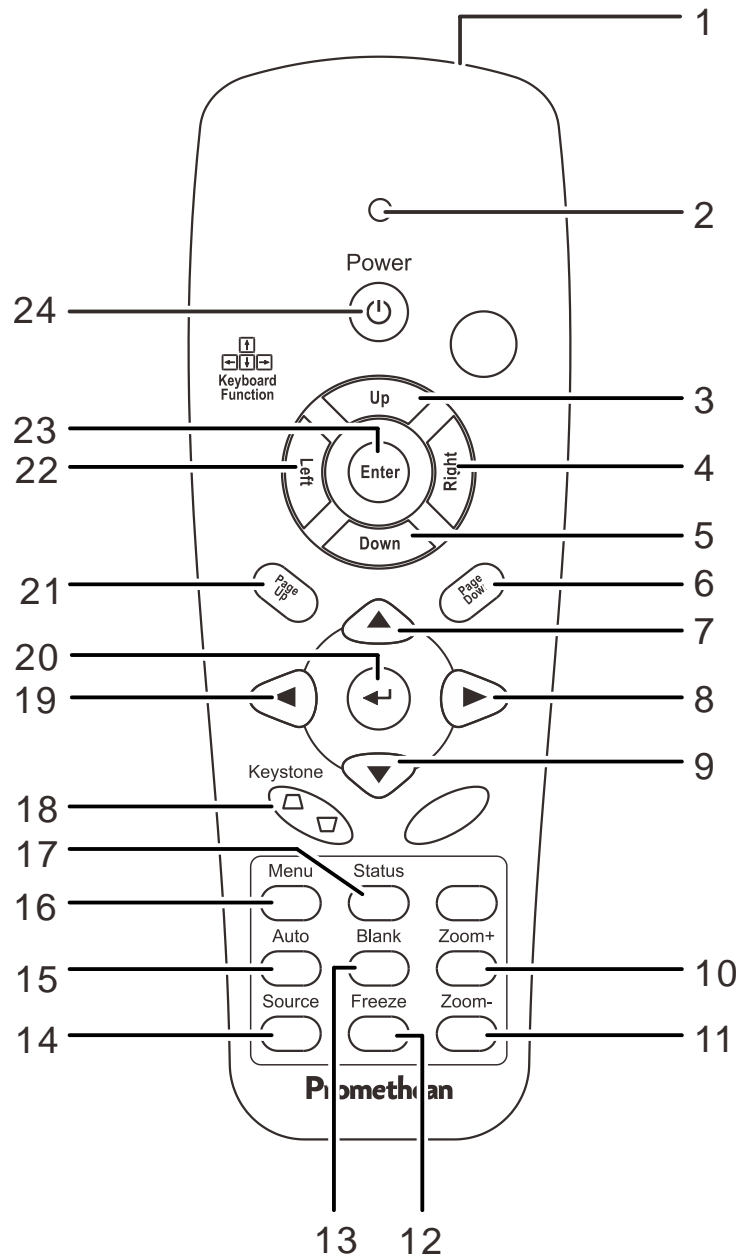

Important:

1. Avoid using the projector with bright fluorescent lighting turned on. Certain high-frequency fluorescent lights can disrupt remote control operation.
2. Be sure nothing obstructs the path between the remote control and the projector. If the path between the remote control and the projector is obstructed, you can bounce the signal off certain reflective surfaces such as projector screens.

ITEM	LABEL	DESCRIPTION	SEE PAGE:
1.	IR transmitter	Transmits signals to projector	
2.	Status LED	Lights when the remote control is used	
3.	Up	Up arrow when connected through USB to a PC	
4.	Right	Right arrow when connected through USB to a PC	
5.	Down	Down arrow when connected through USB to a PC	
6.	Page Down	Page down when connected through USB to a PC	
7.	Up cursor	Navigates and changes settings in the OSD	
8.	Right cursor		
9.	Down cursor		
10.	Zoom+	Zoom in	
11.	Zoom-	Zoom out	
12.	Freeze	Freeze/unfreezes the on-screen picture	
13.	Blank	Makes the screen blank	
14.	Source	Detects the input device	
15.	Auto	Auto adjustment for phase, tracking, size, position	
16.	Menu	Opens the OSD	
17.	Status	Opens the OSD Status menu (the menu only opens when an input device is detected)	40
18.	Keystone top/bottom	Corrects image-trapezoid (wider top/bottom) effect	12
19.	Left cursor	Navigates and changes settings in the OSD	
20.	Enter	Changes settings in the OSD	
21.	Page Up	Page up when connected through USB to a PC	
22.	Left	Left arrow when connected through USB to a PC	
23.	Enter	Enter key when connected through USB to a PC	
24.	Power	Turns the projector on or off	9

Remote Control Operating Range

The remote control uses infrared transmission to control the projector. It is not necessary to point the remote directly at the projector. Provided you are not holding the remote perpendicular to the sides or the rear of the projector, the remote will function well within a radius of about 7 meters (23 feet) and 15 degrees above or below the projector level. If the projector does not respond to the remote control, move a little closer.

Projector and Remote Control Buttons

The projector can only be operated using the remote control. All operations can be carried out with the remote control.

Inserting the Remote Control Batteries

1. Remove the battery compartment cover by sliding the cover in the direction of the arrow.

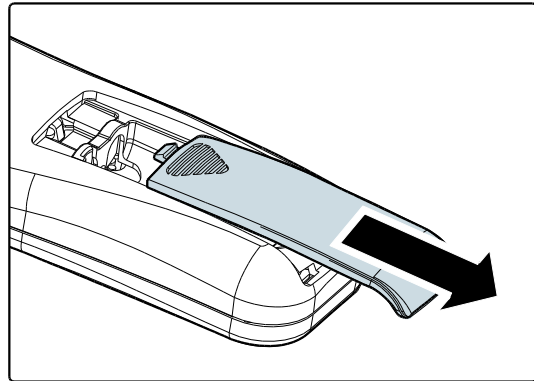

2. Insert the battery with the positive side facing up.

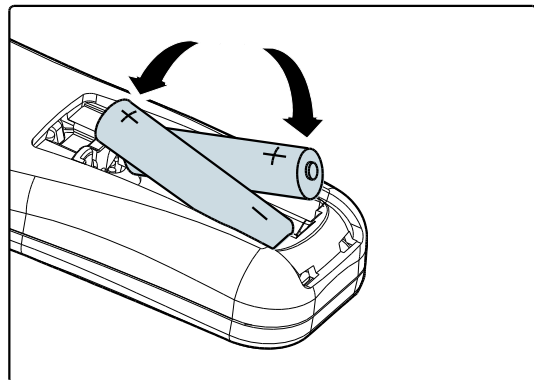

3. Replace the cover.

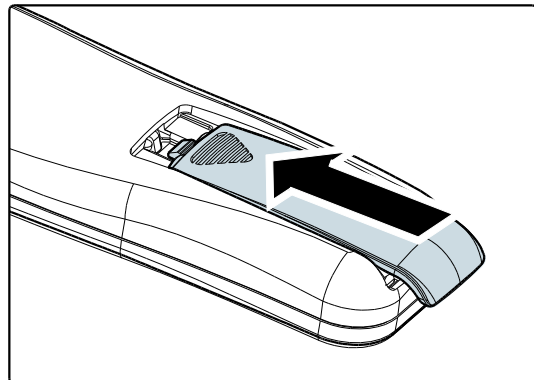

Caution:

1. Only use AAA batteries (Alkaline batteries are recommended).
2. Dispose of used batteries according to local ordinance regulations.
3. Remove the batteries when not using the projector for prolonged periods.

Starting and Shutting down the Projector

1. Connect the power cord to the projector. Connect the other end to a wall outlet.
2. Turn on the connected devices.
3. Ensure the **POWER** LED displays a solid green. Then press the **POWER** button of the remote to turn on the projector.

The projector splash screen displays and connected devices are detected.

See [Setting an Access Password \(Security Lock\)](#) on page 10 if security lock is enabled.

4. If more than one input device is connected, press the **SOURCE** button of the remote and use ▲▼ to scroll among devices. (Component is supported through the RGB to COMPONENT ADAPTER.)

5. When the “Power Off? /Press Power again” message appears, press the **POWER** button. The projector turns off.

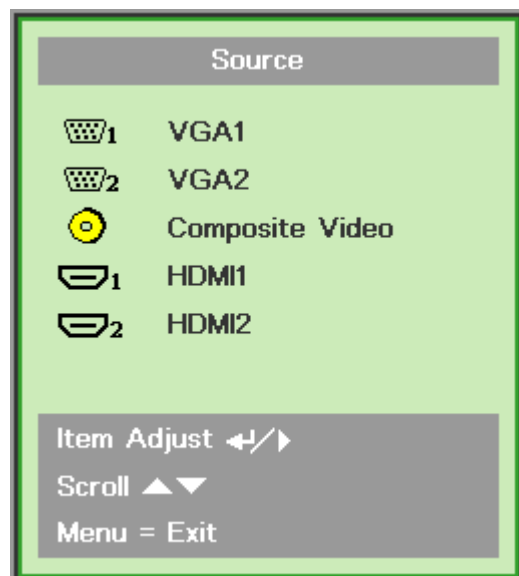
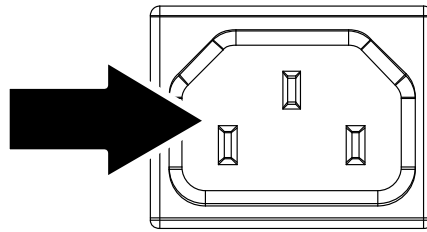

- VGA 1/VGA 2: Analog RGB
Component: DVD input YCbCr / YPbPr, or HDTV input YPbPr via HD15 connector
- Composite Video: Traditional composite video
- HDMI1/HDMI2: HDMI, DVI

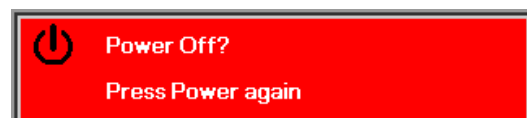

Caution:

Do not unplug the power cord until the POWER LED change to green—indicating the projector has cooled down.

Setting an Access Password (Security Lock)

You can use the four (arrow) buttons to set a password and prevent unauthorized use of the projector. When enabled, the password must be entered after you power on the projector. (See [Navigating the OSD](#) on page 14 and [Setting the OSD Language](#) on page 15 for help on using OSD menus.)



Important:

Keep the password in a safe place. Without the password, you will not be able to use the projector. If you lose the password, contact your reseller for information on clearing the password.

1. Press the **MENU** button to open the OSD menu.

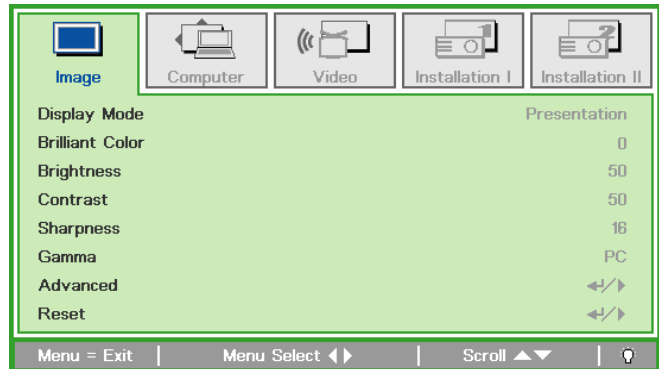

2. Press the cursor **◀▶** button to move to the **Installation I** menu.

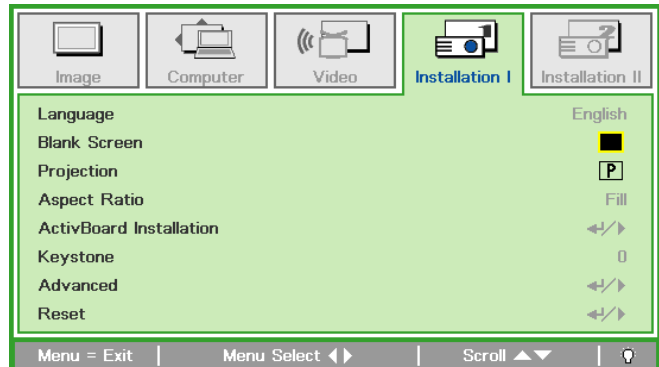

3. Press the cursor **▲▼** button to select **Advanced**.

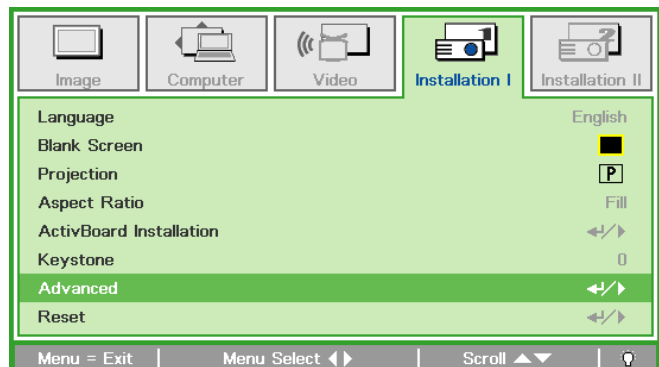

4. Press the cursor ▲▼ button to select **Security Lock**.

5. Press the cursor ◀▶ button to enable or disable security lock function.

A password dialog box automatically appears.

6. You can use the cursor buttons ▲▼◀▶ on IR remote control for password entry. You can use any combination including the same arrow five times, but not less than five.

Press the cursor buttons in any order to set the password. Push the **MENU** button to exit the dialog box.

7. The password confirm menu appears when user presses the power-on key in case the **Security Lock** is enabled. Enter the password in the order you set it at step 5. In case you forget the password, please contact the service center. Service center will validate the owner and help reset the password.

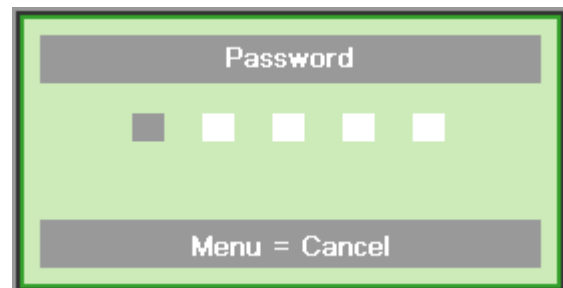
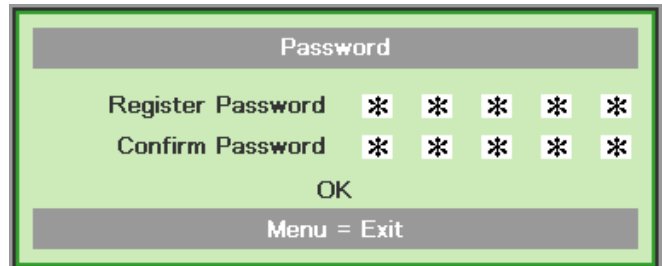
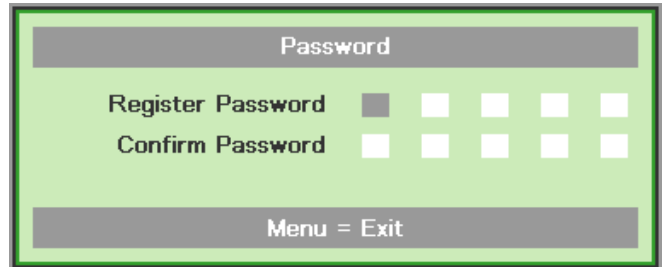
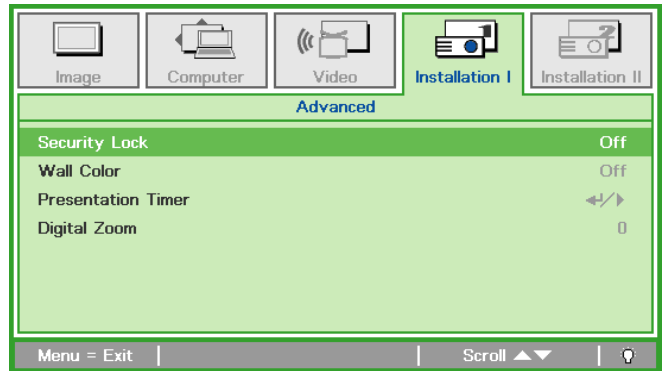

Adjusting the Projector Level

Take note of the following when setting up the projector:

- *The projector table or stand should be level and sturdy.*
- *Position the projector so that it is perpendicular to the screen.*
- *Ensure the cables are in a safe location. You could trip over them.*

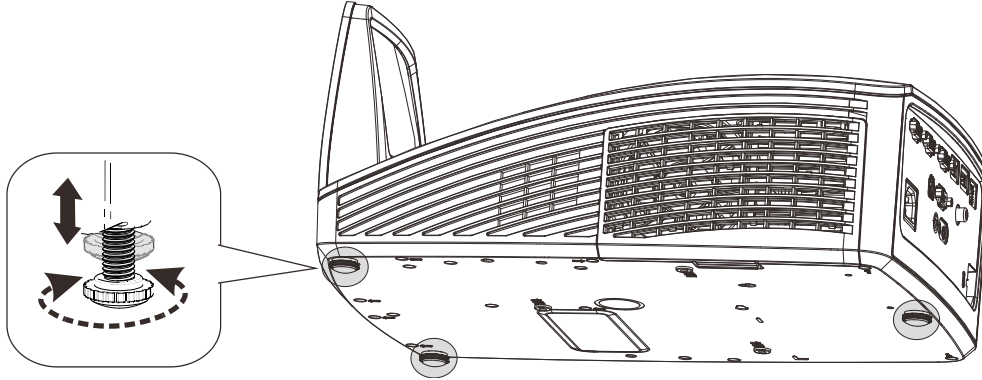

To adjust the angle of the picture, turn the tilt-adjuster right or left until the desired angle has been achieved.

Adjusting the Focus and Keystone

1. Use the **Image-focus** control (on the projector only) to sharpen the projected image

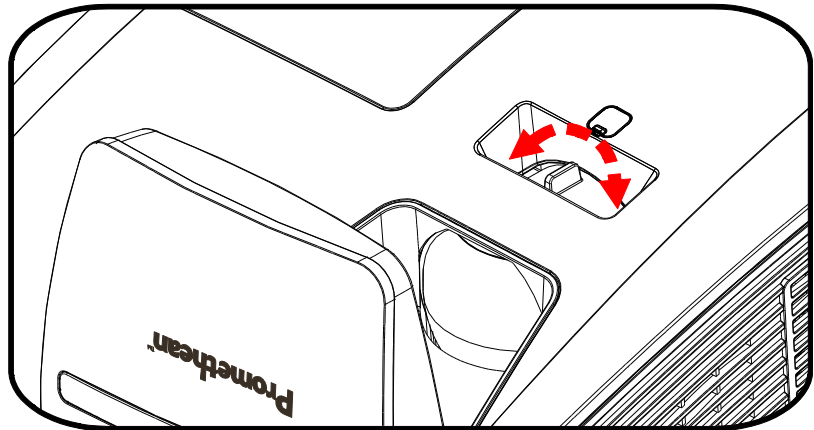

2. Use the **KEYSTONE** buttons the remote control to correct image-trapezoid (wider top or bottom) effect.

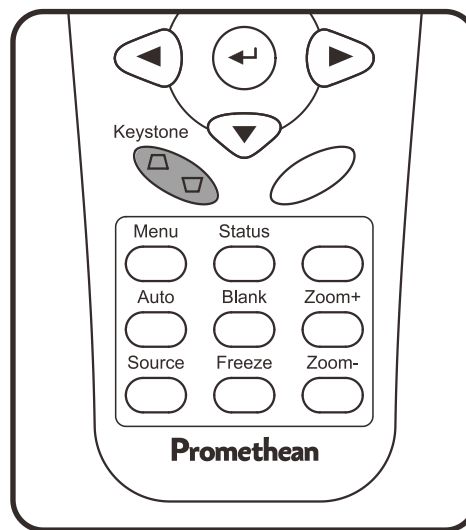

3. The keystone control appears on the display.



ON-SCREEN DISPLAY (OSD) MENU SETTINGS

OSD Menu Controls

The projector has an OSD that lets you make image adjustments and change various settings.

Navigating the OSD

You can use the remote control cursor buttons to navigate and make changes to the OSD.

1. To enter the OSD, press the **MENU** button.
2. There are five menus. Press the cursor ◀▶ button to move through the menus.
3. Press the cursor ▲▼ button to move up and down in a menu.
4. Press ◀▶ to change values for settings.
5. Press **MENU** to close the OSD or leave a submenu.

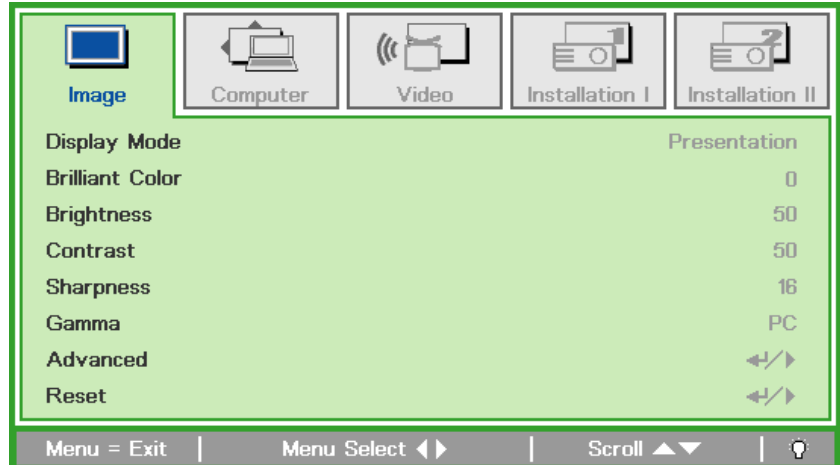

Note:

Depending on the video source, not all items in the OSD are available. For example, the **Horizontal/Vertical Position** items in the **Computer** menu can only be modified when connected to a PC. Items that are not available cannot be accessed and are grayed out.

Setting the OSD Language

Set the OSD language to your preference before continuing.

1. Press the **MENU** button. Press the cursor ◀▶ button to navigate to Installation I.

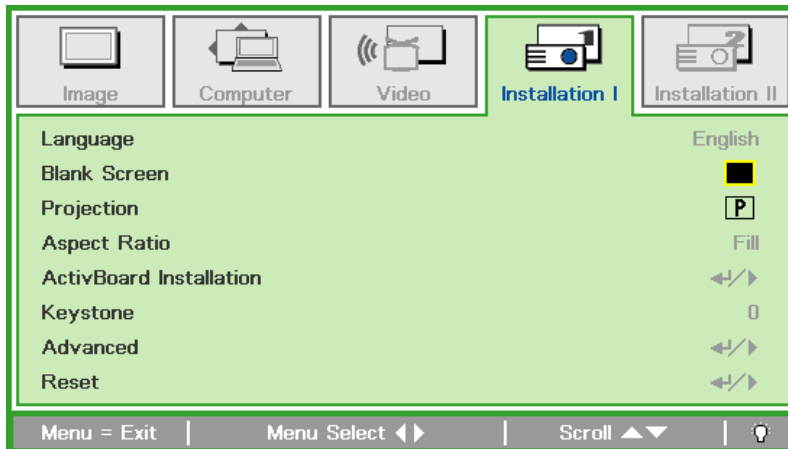

2. Press the cursor ▲▼ button until **Language** is highlighted.

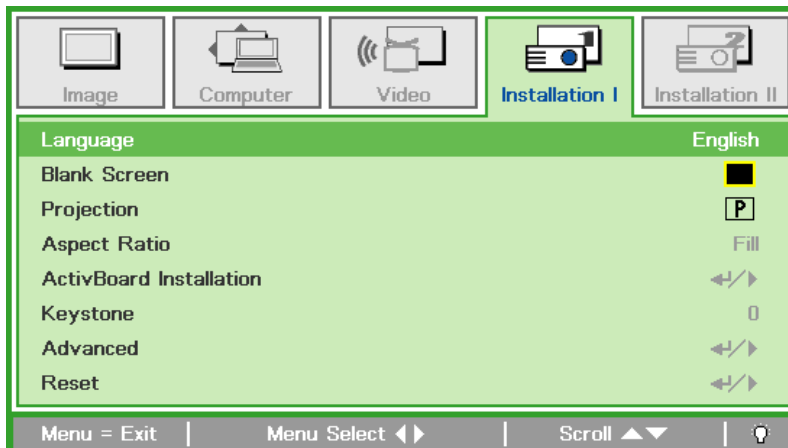

3. Press the cursor ◀▶ button until the language you want is highlighted.
4. Press the **MENU** button twice to close the OSD.

OSD Menu Overview

Use the following illustration to quickly find a setting or determine the range for a setting.

MAIN MENU	SUB MENU	SETTINGS		
Image	Display Mode	Presentation, Bright, Game, Movie, TV, sRGB, User		
	Brilliant Color	0~10		
	Brightness	0~100		
	Contrast	0~100		
	Sharpness	0~31		
	Gamma	PC, MAC, Video, Chart, B&W		
	Advanced	Color Space	Auto, RGB, YUV	
		Color Temperature	Native, Warm, Normal, Cold	
		Color Manager	Red	Hue, Saturation, Gain
			Green	Hue, Saturation, Gain
			Blue	Hue, Saturation, Gain
			Cyan	Hue, Saturation, Gain
			Magenta	Hue, Saturation, Gain
	Yellow		Hue, Saturation, Gain	
White	Red, Green, Blue			
Reset				
Computer	Horizontal Position	-5~5		
	Vertical Position	-5~5		
	Frequency	0~31		
	Tracking	-5~5		
	Auto Image			
Video	Video AGC	Off, On		
	Video Saturation	0~100		
	Video Tint	0~100		
	Film Mode	Auto, Off		
	Video Overscan	Off, On		
	Closed Captioning	Off, On		
	Reset			

MAIN MENU	SUB MENU	SETTINGS		
Installation I	Language	English, Français, Deutsch, Español, Português, 簡體中文, 繁體中文, Italiano, Norsk, Svenska, Nederlands, Русский, Suomi, العربية, Türkçe, 日本語, Ағылшын, Việt, Dansk, Polski, Ελληνικά, Magyar, Čeština, ไทย, Indonesian, Latviski, Lietuvių, Bahasa Malaysia		
	Blank Screen	Black, Red, Green, Blue, White		
	Projection	Front, Rear, Ceiling, Rear+Ceiling		
	Aspect Ratio	Fill, 4:3, 16:9, Letter Box, Native		
	ActiveBoard Installation	White Board	16:10, 4:3, 16:9, None	
		Test Pattern	None, Grid, RGB Ramps, Color Bars, Step Bars, Checkboard, Horizontal Lines, Vertical Lines, Diagonal Lines, Horizontal Ramp, Vertical Ramp, White, Black	
		Vertical Image Adjustment	-40~40	
		Horizontal Image Adjustment	-128~128	
	Keystone	-40~40		
	Advanced	Security Lock	Off ,On	
		Wall Color	Off, Light Yellow, Pink, Light Green, Blue, Blackboard	
		Presentation Timer	Timer	Off ,On
			Timer Period	1-60
			Timer Reset	
	Digital Zoom	-10~10		
Reset				

MAIN MENU	SUB MENU	SETTINGS		
Installation II	Auto Source	Off, On		
	Auto Power Off (min.)	0~180		
	Auto Power On	Off, On		
	Fan Speed	Normal, High		
	Lamp Mode	Normal, Bright		
	Advanced	OSD Menu Setting	Menu Position	Center, Down, Up, Left, Right
			Translucent Menu	0%, 25%, 50%, 75%, 100%
			Menu Display	10~20
		Peripheral Test	Remote Control Test	
			Color Test	
			USB Test	
		Lamp Hour Reset		
		Low Power Mode	On, Off	
		3D	3D	Off, DLP-Link, IR
			3D Sync Invert	On, Off
			3D Format	Frame Sequential, Top/Bottom, Side-By-Side, Frame Packing (3D Frame Packing HDMI source only)
		RS232	RS232, Network	
		Network	Network State	Disconnect, Connect
			DHCP	Off, On
			IP Address	0~255, 0~255, 0~255, 0~255
	Subnet Mask		0~255, 0~255, 0~255, 0~255	
	Gateway		0~255, 0~255, 0~255, 0~255	
	DNS		0~255, 0~255, 0~255, 0~255	
	Apply			
	Factory Reset			
	Status	Active Source		
		Video Information		
Lamp Hours (Normal, Bright)				

Image Menu

Press the **MENU** button to open the **OSD** menu. Press the cursor ◀▶ button to move to the **Image Menu**. Press the cursor ▲▼ button to move up and down in the **Image** menu. Press ◀▶ to change values for settings.

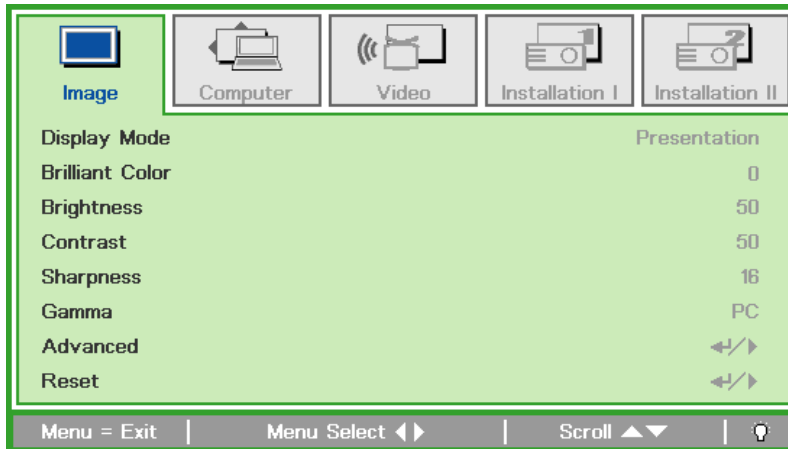

ITEM	DESCRIPTION
Display Mode	Press the cursor ◀▶ button to set the Display Mode.
Brilliant Color	Press the cursor ◀▶ button to adjust the Brilliant Color value.
Brightness	Press the cursor ◀▶ button to adjust the display brightness.
Contrast	Press the cursor ◀▶ button to adjust the display contrast.
Sharpness	Press the cursor ◀▶ button to adjust the display sharpness level.
Gamma	Press the cursor ◀▶ button to adjust the gamma correction of the display.
Advanced	Press ◀ (Enter) / ▶ to enter the Advanced menu. See Advanced Feature on page 20.
Reset	Press ◀ (Enter) / ▶ to reset all settings to default values.

Advanced Feature

Press the **Menu** button to open the **OSD** menu. Press **◀▶** to move to the **Image** menu. Press **▼▲** to move to the **Advanced** menu and then press **Enter** or **▶**. Press **▼▲** to move up and down in the **Advanced** menu.

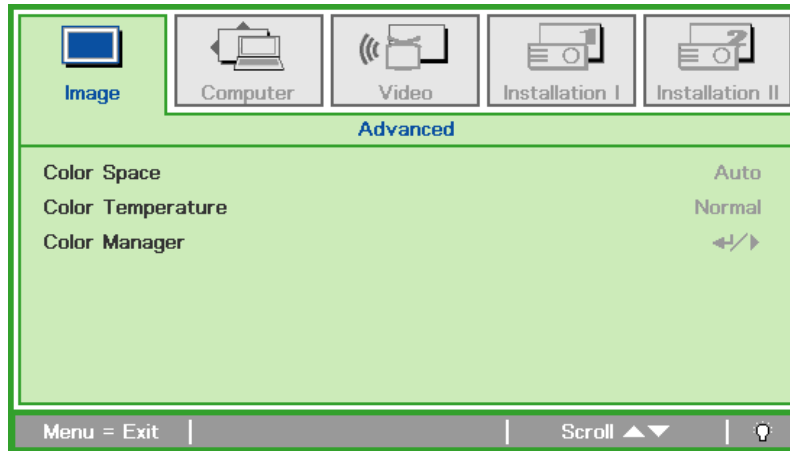

ITEM	DESCRIPTION
Color Space	Press the cursor ◀▶ button to adjust the color space. (Range: Auto – RGB – YUV)
Color Temperature	Press the cursor ◀▶ button to adjust the color temperature. (Range: Native – Warm – Normal – Cold)
Color Manager	Press ◀ (Enter) / ▶ to enter the color manager menu. (Range: Red – Green – Blue – Cyan-Magenta – Yellow – White). See page 21 for more information on Color Manager .

Color Manager

Press **←** (Enter) / **▶** to enter the **Color Manager** sub menu.

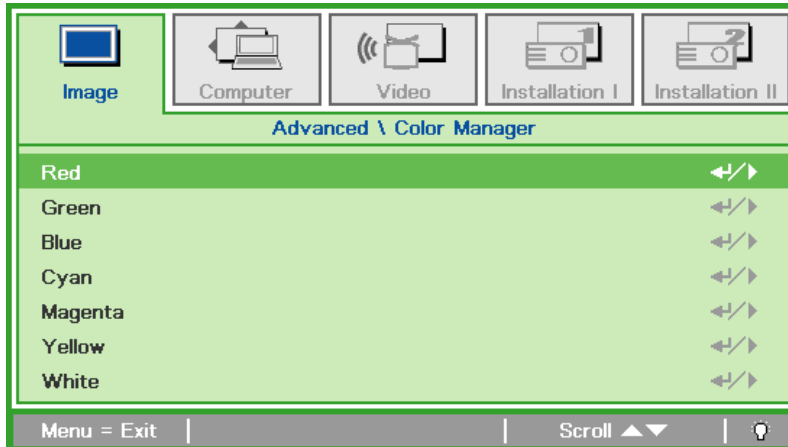

ITEM	DESCRIPTION
Red	Select to enter the Red Color Manager. Press the ◀▶ buttons to adjust the Hue, Saturation, and Gain.
Green	Select to enter the Green Color Manager. Press the ◀▶ buttons to adjust the Hue, Saturation, and Gain.
Blue	Select to enter the Blue Color Manager. Press the ◀▶ buttons to adjust the Hue, Saturation, and Gain.
Cyan	Select to enter the Cyan Color Manager. Press the ◀▶ buttons to adjust the Hue, Saturation, and Gain.
Magenta	Select to enter the Magenta Color Manager. Press the ◀▶ buttons to adjust the Hue, Saturation, and Gain.
Yellow	Select to enter the Yellow Color Manager. Press the ◀▶ buttons to adjust the Hue, Saturation, and Gain.
White	Select to enter the White Color Manager. Press the ◀▶ buttons to adjust the Red, Green, and Blue.

Computer Menu

Press the **MENU** button to open the **OSD** menu. Press the cursor ◀▶ button to move to the **Computer** menu. Press the cursor ▲▼ button to move up and down in the computer menu. Press ◀▶ to change values for settings.

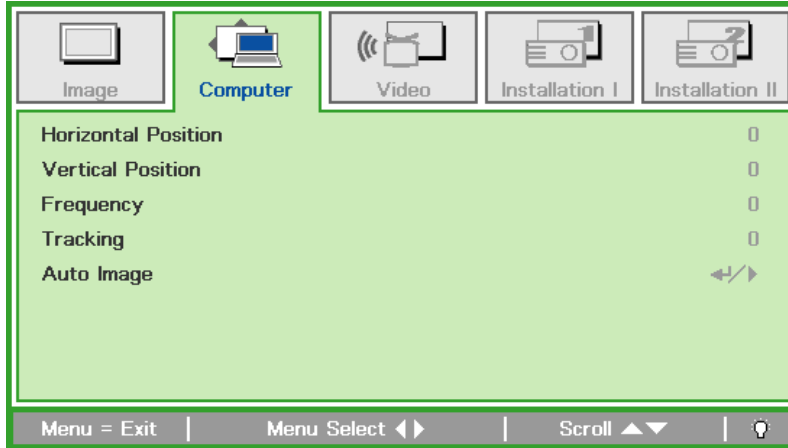

ITEM	DESCRIPTION
Horizontal Position	Press the cursor ◀▶ button to adjust the display position to left or right.
Vertical Position	Press the cursor ◀▶ button to adjust the display position to up or down.
Frequency	Press the cursor ◀▶ button to adjust the A/D sampling clock.
Tracking	Press the cursor ◀▶ button to adjust the A/D sampling dot.
Auto Image	Press ◀(Enter) / ▶ to automatically adjust for phase, tracking, size and position.

Video Menu

Press the **MENU** button to open the **OSD** menu. Press the cursor ◀▶ button to move to the **Video** menu. Press the cursor ▲▼ button to move up and down in the **Video** menu. Press ◀▶ to change values for settings.

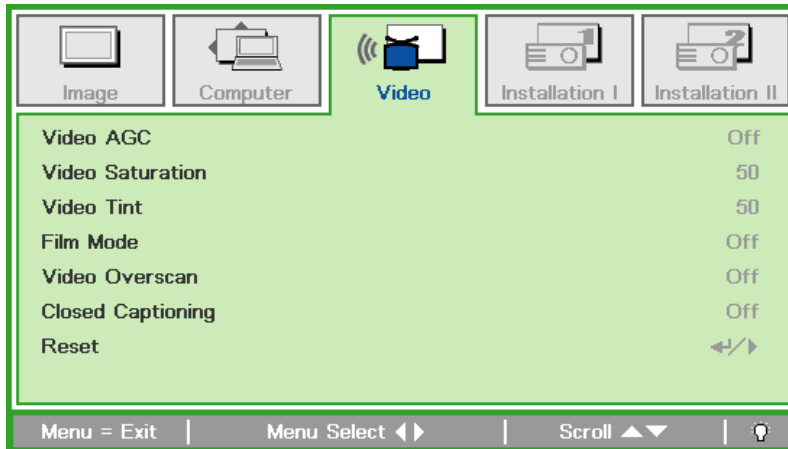

ITEM	DESCRIPTION
Video AGC	Press the ◀▶ buttons to enable or disable the Automatic Gain Control for video source.
Video Saturation	Press the ◀▶ buttons to adjust the video saturation.
Video Tint	Press the ◀▶ buttons to adjust the video tint/hue.
Film Mode	Press the ◀▶ buttons to select a different film mode.
Video Overscan	Press the ◀▶ buttons to enable or disable video over scan.
Closed Captioning	Press the ◀▶ buttons to enable or disable closed captioning.
Reset	Press ⏏ (Enter) / ▶ to reset all settings to default values.

Note:

Video jaggging may occur when playing interlace video. To overcome this issue, open the Video menu and adjust the Film Mode feature.

Installation I Menu

Press the **MENU** button to open the **OSD** menu. Press the cursor ◀▶ button to move to the **Installation I** menu. Press the cursor ▲▼ button to move up and down in the **Installation I** menu. Press ◀▶ to change values for settings.

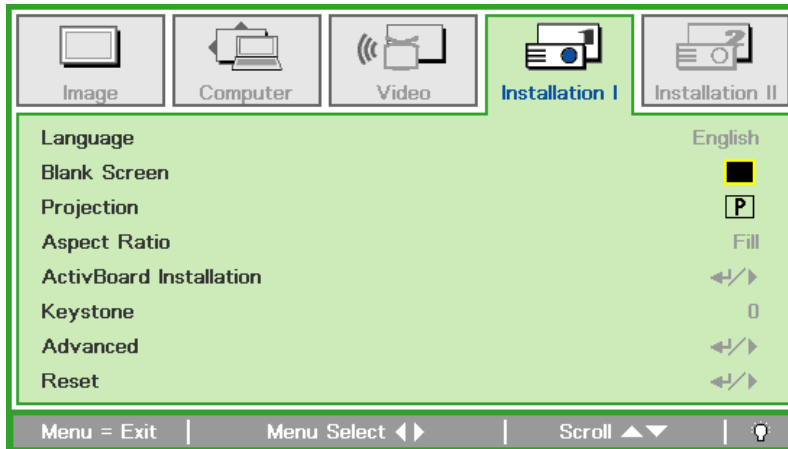

ITEM	DESCRIPTION
Language	Press the cursor ◀▶ button to select a different localization Menu.
Blank Screen	Press the cursor ◀▶ button to select different color to blank the screen.
Projection	Press the cursor ◀▶ button to choose from four projection methods:
Aspect Ratio	Press the cursor ◀▶ button to adjust the video aspect ratio. Noted: Aspect Ratio will be grayout when White Board in used.
ActivBoard Installation	Press ↵ (Enter) / ▶ to the ActivBoard Installation menu. See ActivBoard Installation on page 25.
Keystone	Press the cursor ◀▶ button to adjust the display keystone.
Advanced	Press ↵ (Enter) / ▶ to the Advanced menu. See Advanced Feature on page 26.
Reset	Press ↵ (Enter) / ▶ to reset all settings to default values (except Language).

ActivBoard Installation

Press the **Menu** button to open the **OSD** menu. Press **◀▶** to move to the **Installation I** menu. Press **▲▼** to move to the **ActivBoard Installation** menu and then press **Enter** or **▶**. Press **▲▼** to move up and down in the **ActivBoard Installation** menu. Press **◀▶** to change values for setting.

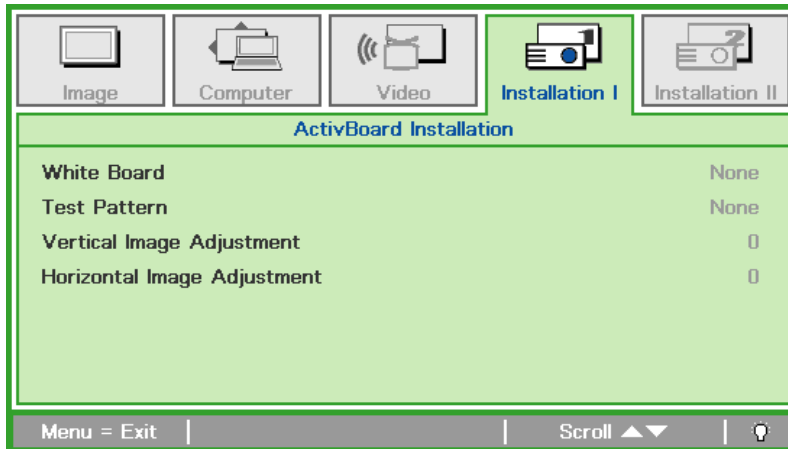

ITEM	DESCRIPTION
White Board	Press ◀▶ button to select different White Board aspect ratios for the projected image Note : Aspect Ratio will be grayed out when White Board settings are in use.
Test Pattern	Press ◀▶ button to select different test pattern for projector installation check.
Vertical Image Adjustment	Press ◀▶ button to adjust vertical image position. Note: Only available when White Board 4:3/16:9 is selected
Horizontal Image Adjustment	Press ◀▶ button to adjust horizontal image position. Note : Only available when White Board 4:3 is selected

Advanced Feature

Press the **Menu** button to open the **OSD** menu. Press **◀▶** to move to the **Installation I** menu. Press **▲▼** to move to the **Advanced** menu and then press **Enter** or **▶**. Press **▲▼** to move up and down in the **Advanced** menu. Press **◀▶** to change values for setting.

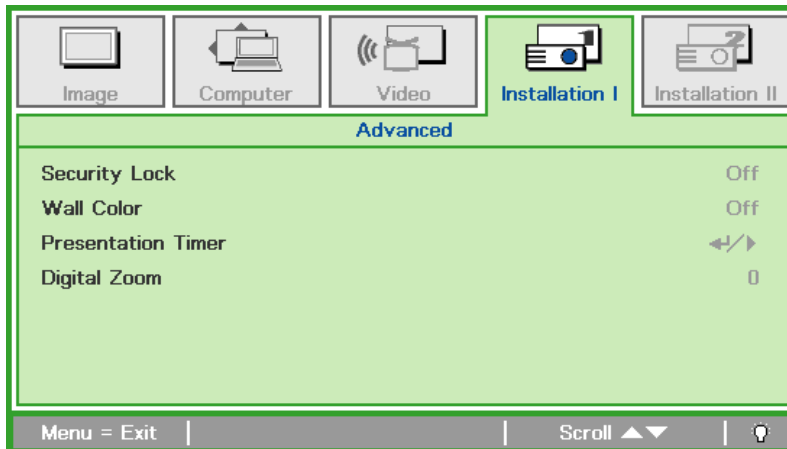

ITEM	DESCRIPTION
Security Lock	Press the cursor ◀▶ button to enable or disable security lock function.
Wall Color	Press the cursor ◀▶ button to enable or disable wall color function (Off/ Light Yellow/ Pink/ Light Green/ Blue/ Blackboard).
Presentation Timer	Press ◀ (Enter) / ▶ to go to the Presentation Timer Menu. See Presentation Timer below.
Digital Zoom	Press the cursor ◀▶ button to adjust the Digital Zoom menu.

Presentation Timer

The Presentation Timer function can indicate the presentation time on the screen to help you achieve better time management when giving presentations.

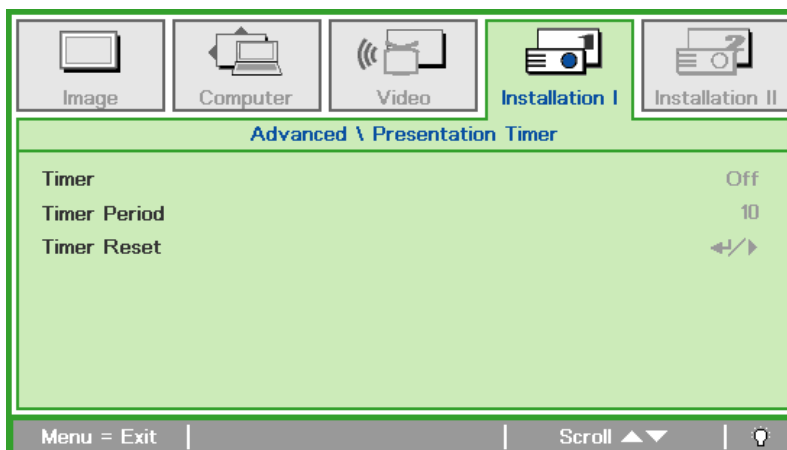

ITEM	DESCRIPTION
Timer	Press the cursor ◀▶ button to enable or disable presentation timer.
Timer Period	Press the cursor ◀▶ button to select timer period (1 ~ 60 minutes)
Timer Reset	Press ◀ (Enter) / ▶ to reset the timer settings.

Installation II Menu

Press the **MENU** button to open the **OSD** menu. Press the cursor ◀▶ button to move to the **Installation II** menu. Press the cursor ▲▼ button to move up and down in the Installation II menu.

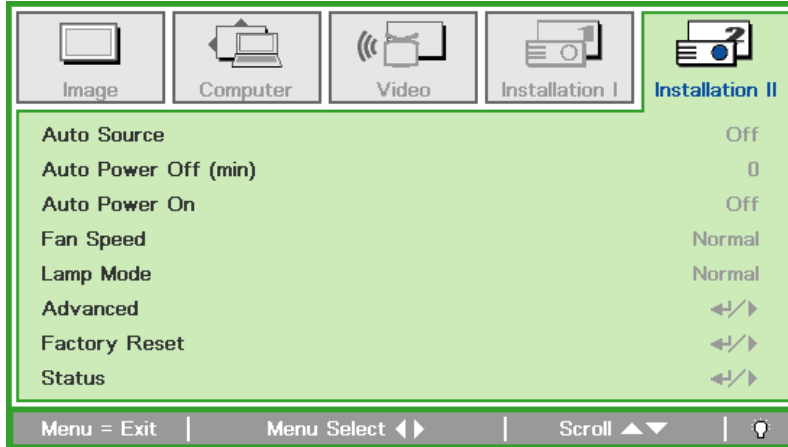

ITEM	DESCRIPTION
Auto Source	Press the cursor ◀▶ button to enable or disable automatic source detection.
Auto Power Off (min.)	Press the cursor ◀▶ button to enable or disable automatic shutdown of lamp when no signal.
Auto Power On	Press the cursor ◀▶ button to enable or disable automatic power On when AC power is supplied.
Fan Speed	Press the cursor ◀▶ button to toggle between Normal and High fan speeds. Note: Recommend selecting high speed when the altitude of the environment is higher than 1500m (4921ft)
Lamp Mode	Press the cursor ◀▶ button to select the lamp mode for higher brightness or lower brightness to save lamp life.
Advanced	Press ↵ (Enter) / ▶ to enter the Advanced menu. See Advanced Feature on page 28.
Factory Reset	Press ↵ (Enter) / ▶ to reset all items to factory preset values.
Status	Press ↵ (Enter) / ▶ to enter the Status menu. See page 40 for more information on Status .

Advanced Feature

Press the **Menu** button to open the **OSD** menu. Press ◀▶ to move to the **Installation II** menu. Press ▲▼ to move to the **Advanced** menu and then press **Enter** or ▶. Press ▲▼ to move up and down in the **Advanced** menu. Press ◀▶ to change values for setting.

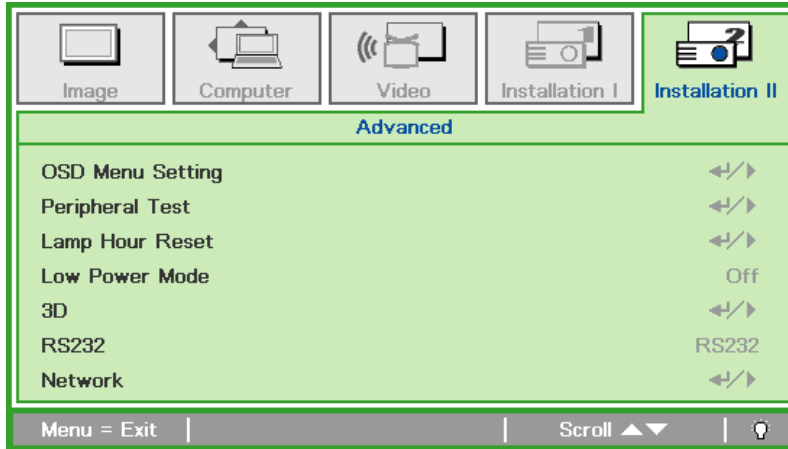

ITEM	DESCRIPTION
OSD Menu Setting	Press ◀ (Enter) / ▶ to enter the OSD setting menu. See page 29 for more information on OSD Menu Setting .
Peripheral Test	Press ◀ (Enter) / ▶ to enter the Peripheral Test menu. See page 29 for more information on Peripheral Test .
Lamp Hour Reset	After replacing the lamp, this item should be reset. See page 30 for more information on Lamp Hour Reset .
Low Power Mode	Press ◀▶ to turn Low Power Mode on or off.
3D	Press ◀ (Enter) / ▶ to enter the 3D menu. See page 30 for more information on 3D settings.
RS232	Press ◀▶ to select RS232 (remote) or Network (LAN) mode depending on projector connection method.
Network	Press ◀ (Enter) / ▶ to enter the Network menu. See page 31 for more information on Network settings.

Note:

To enjoy the 3D function, first enable the Play Movie in 3D setting found in your DVD device under the 3D Disc Menu.

To enjoy Network function on Low Power Stand-By, Please let Low Power Mode set On, and RS232 set Network.

OSD Menu Setting

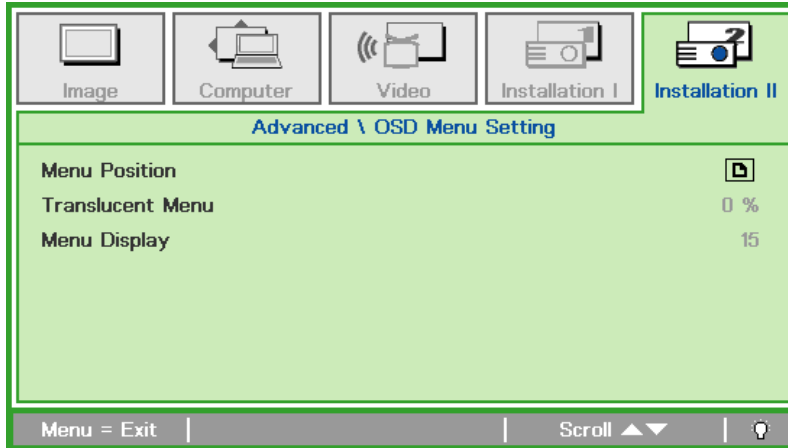

ITEM	DESCRIPTION
Menu Position	Press ◀▶ button to select different OSD location.
Translucent Menu	Press ◀▶ button to select OSD background translucent level.
Menu Display	Press ◀▶ button to select OSD timeout delay.

Peripheral Test

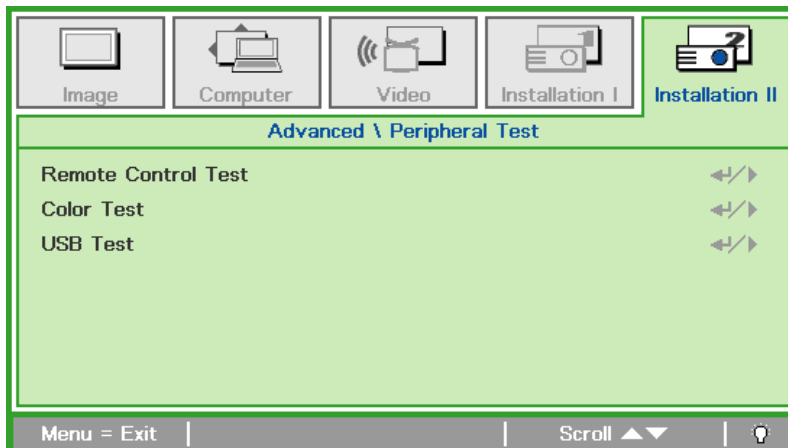

ITEM	DESCRIPTION
Remote Control Test	Press ◀ (Enter) / ▶ to test the IR remote controller for diagnostic.
Color Test	Press ◀ (Enter) / ▶ to select different colors on screen.
USB Test	Press ◀ (Enter) / ▶ to test the USB connection with connected PC.

Lamp Hour Reset

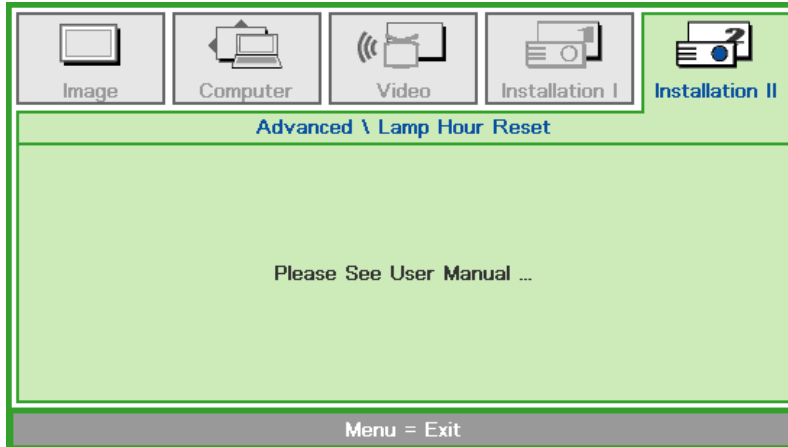

Please refer to [Resetting the Lamp](#) on page 43 to reset the lamp hour counter.

3D

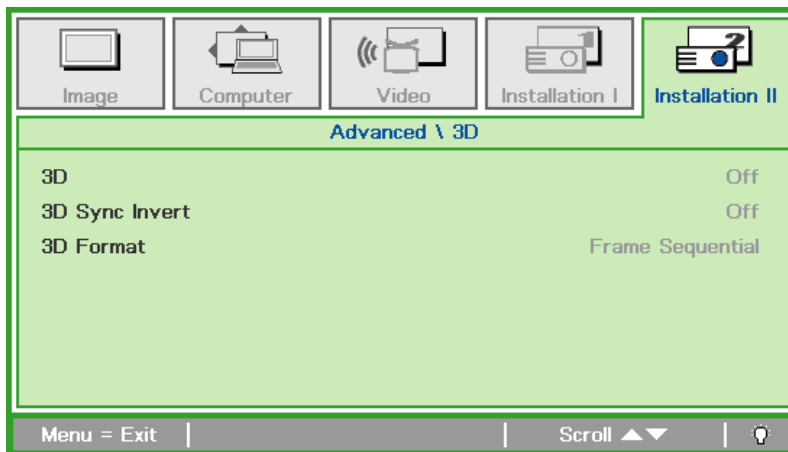

ITEM	DESCRIPTION
3D	Press ◀▶ to select Off, DLP-Link or IR.
3D Sync Invert	Press ◀▶ to turn 3D Sync Invert On or Off.
3D Format	Press ◀▶ to enable or disable 3D Format.

Note:

The model is 3D ready, please contact Promethean for more details.

Network

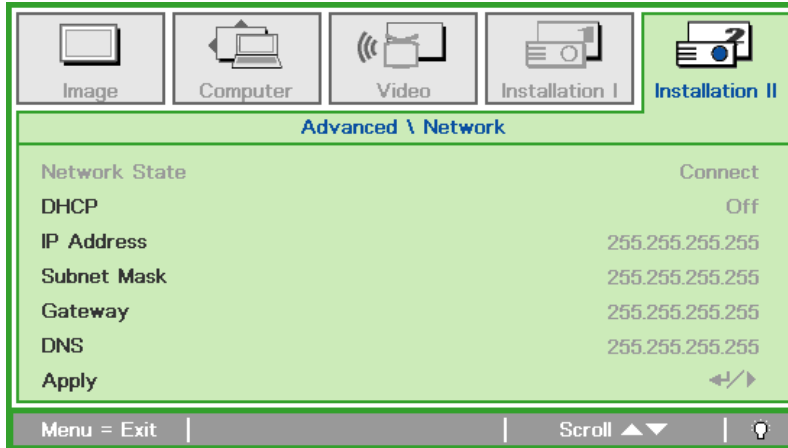

ITEM	DESCRIPTION
Network State	Displays the network connection status.
DHCP	Press ◀▶ to turn DHCP On or Off. Note: If you select DHCP Off, complete the IP Address, Subnet Mask, Gateway, and DNS fields.
IP Address	Enter a valid IP address if DHCP is turned off.
Subnet Mask	Enter a valid Subnet Mask if DHCP is turned off.
Gateway	Enter a valid Gateway address if DHCP is turned off.
DNS	Enter a valid DNS name if DHCP is turned off.
Apply	Press ↵ (Enter) / ▶ to confirm settings.

For simplicity and ease of operation, the projector provides diverse networking and remote management features.

The LAN/RJ45 function of the projector through a network, such as remotely manage: Power On/Off, Brightness and Contrast settings. Also, projector status information, such as: Video-Source, Sound-Mute, etc.

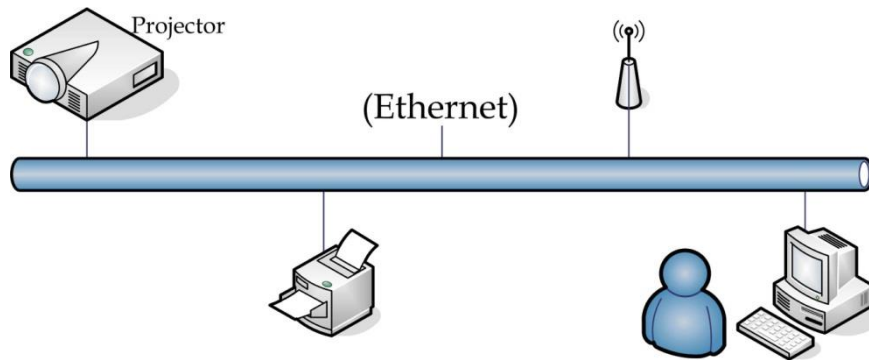

The projector can be controlled by a PC (Laptop) or other external device with connecting to the projector's LAN/RJ45 port.

Wired LAN Terminal functionalities

Remote control and monitoring of a projector from a PC (or Laptop) via wired LAN is also possible. Compatibility with Crestron / AMX (Device Discovery) / Extron control boxes enables not only collective projector management on a network but also management from a control panel on a PC (or Laptop) browser screen.

* Crestron is a registered trademark of Crestron Electronics, Inc. of the United States.

* Extron is a registered trademark of Extron Electronics, Inc. of the United States.

* AMX is a registered trademark of AMX LLC of the United States.

Supported External Devices

This projector is supported by the specified commands of the Crestron Electronics controller and related software (ex, RoomView ®).

<http://www.crestron.com/>

This projector is supported by AMX (Device Discovery).

<http://www.amx.com/>

This projector is compliant to support Extron device(s) for reference.

<http://www.extron.com/>

For more information about the range of external devices which can be connected to the LAN/RJ45 port, as well as the related control commands for each external device, please contact the Service team directly.

LAN RJ45

1. Connect an RJ45 cable to RJ45 ports on the projector and the PC (Laptop).

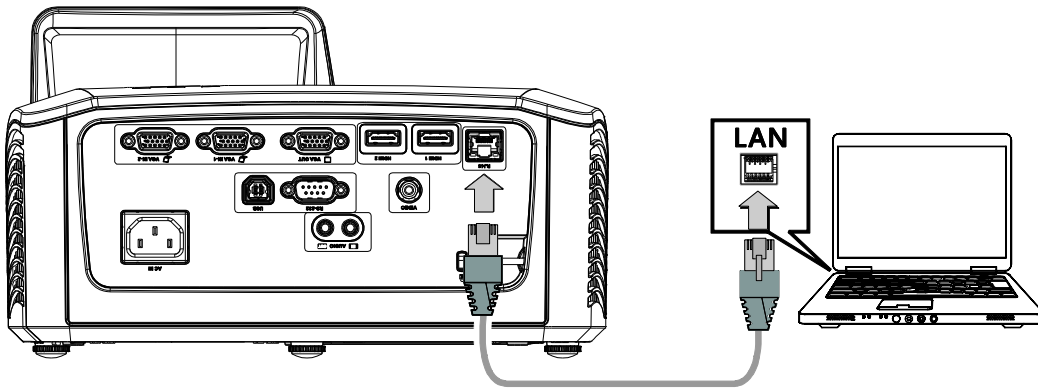

2. On the PC (Laptop), select **Start** → **Control Panel** → **Network and Internet**.

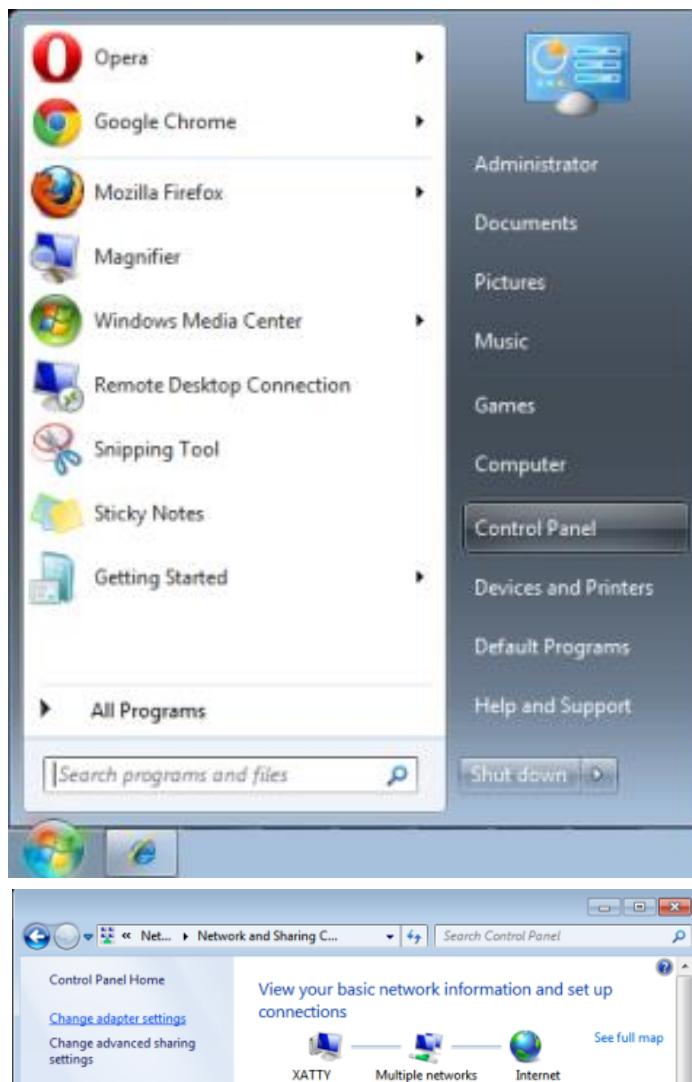

3. Right-click on **Local Area Connection**, and select **Properties**.

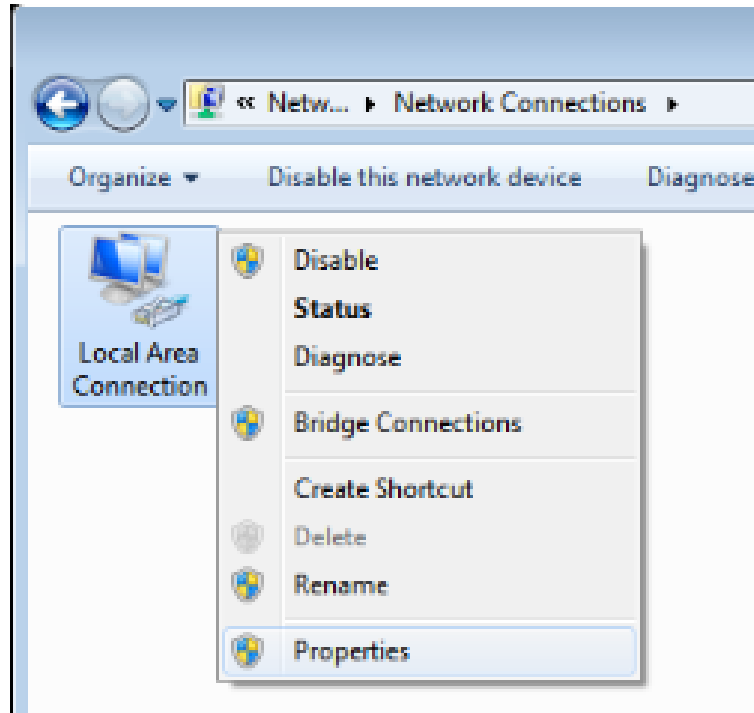

4. In the **Properties** window, select the **Networking** tab, and select **Internet Protocol (TCP/IP)**.
5. Click **Properties**.

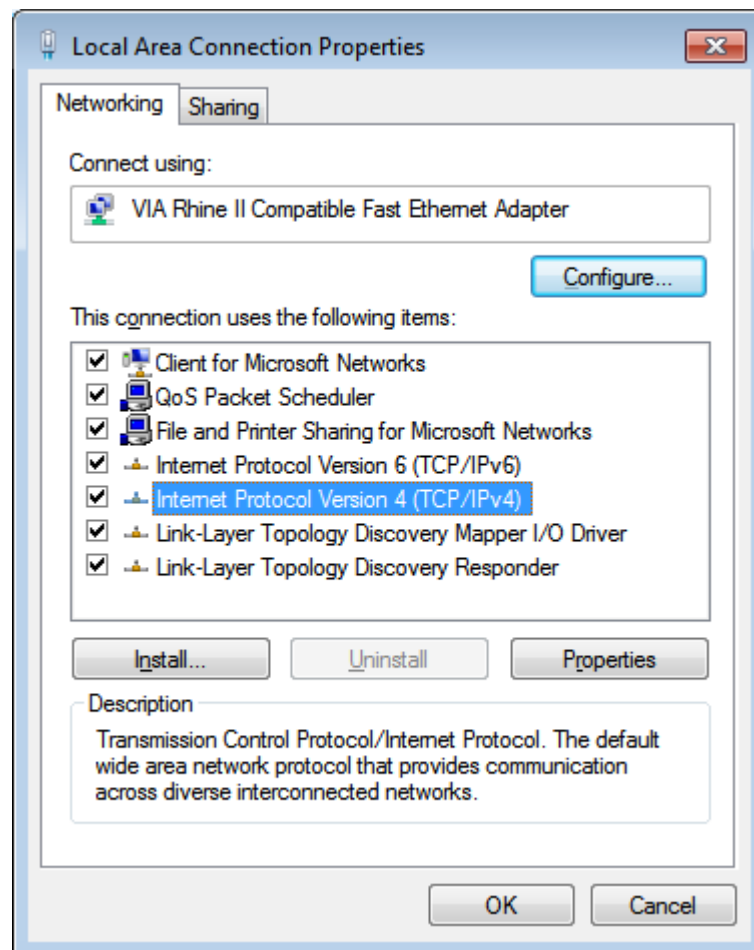

6. Click **Use the following IP address** and fill in the IP address and Subnet mask, then click **OK**.

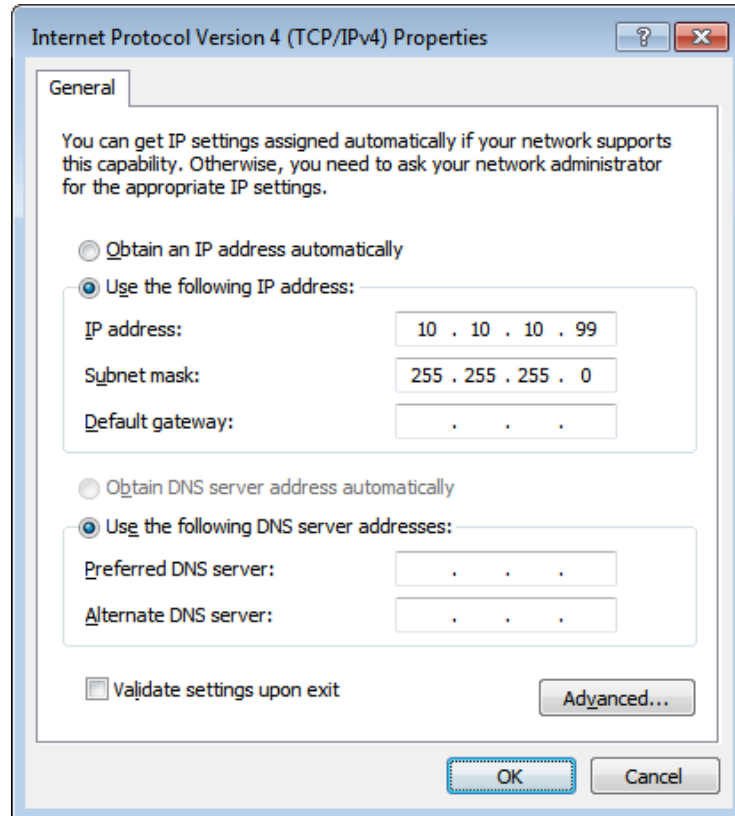

7. Press the **Menu** button on the projector.
8. Select **Installation II** → **Advanced** → **Network** → **Network State** → **Connect**
9. After getting into **Network**, input the following:
- ▶ DHCP: Off
 - ▶ IP Address: 10.10.10.10
 - ▶ Subnet Mask: 255.255.255.0
 - ▶ Gateway: 0.0.0.0
 - ▶ DNS Server: 0.0.0.0
10. Press **↵** (Enter) / **▶** to confirm settings.
11. Open a web browser (for example, Microsoft Internet Explorer with Adobe Flash Player 9.0 or higher).

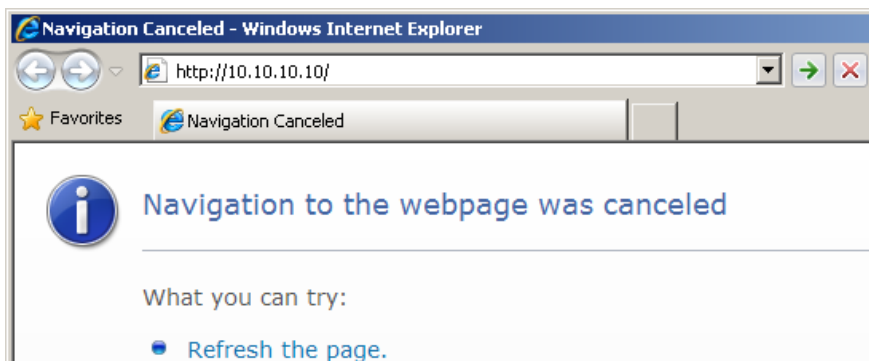

12. In the Address bar, input the IP address: 10.10.10.10.
13. Press **↵** (Enter) / **▶**.

The projector is setup for remote management. The LAN/RJ45 function displays as follows. Based on network web-page for the input-string in **tools** tab, the limitation for Input-Length is in the below list ("space" and the other punctuation key included):



Expansion Options

Crestron Control	Projector	User Password
IP Address: 192.168.0.20	Projector Name: A01	<input type="checkbox"/> Enabled
IP ID: 03	Location: Room	New Password: _____
Port: 41794	Assigned To: Sir.	Confirm: _____
<input type="button" value="Send"/>	<input type="button" value="Send"/>	<input type="button" value="Send"/>
	DHCP <input type="checkbox"/> Enabled	Admin Password
	IP Address: 10.10.10.10	<input type="checkbox"/> Enabled
	Subnet Mask: 255.255.255.0	New Password: _____
	Default Gateway: 0.0.0.0	Confirm: _____
	DNS Server: 0.0.0.0	<input type="button" value="Send"/>
	<input type="button" value="Send"/>	<input type="button" value="Send"/>
<input type="button" value="Exit"/>		

CATEGORY	ITEM	INPUT-LENGTH
Crestron Control	IP Address	14
	IP ID	3
	Port	5
Projector	Projector Name	10
	Location	10
	Assigned To	10
Network Configuration	DHCP (Enabled)	(N/A)
	IP Address	15
	Subnet Mask	15
	Default Gateway	15
	DNS Server	15
User Password	Enabled	(N/A)
	New Password	10
	Confirm	10
Admin Password	Enabled	(N/A)
	New Password	10
	Confirm	10

For more information, please visit <http://www.crestron.com/>.

RS232 by Telnet Function

Besides projector connected to RS232 interface with “Hyper-Terminal” communication by dedicated RS232 command control, there is alternative RS232 command control way, so called “RS232 by TELNET” for LAN/RJ45 interface.

Quick Start-Guide for “RS232 by TELNET”

Check and get the IP-Address on OSD of the projector.

Make sure that laptop/PC can access the web-page of the projector.

Make sure that “Windows Firewall” setting to be disabled in case of “TELNET” function filtering out by laptop/PC.

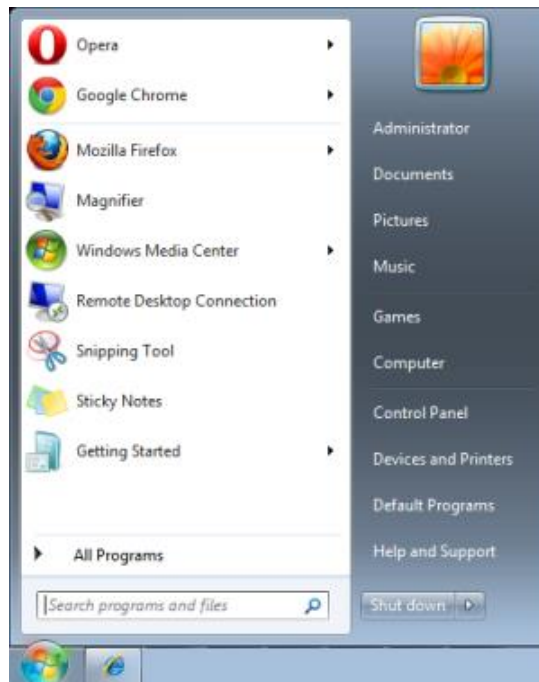

Start => All Programs => Accessories => Command Prompt

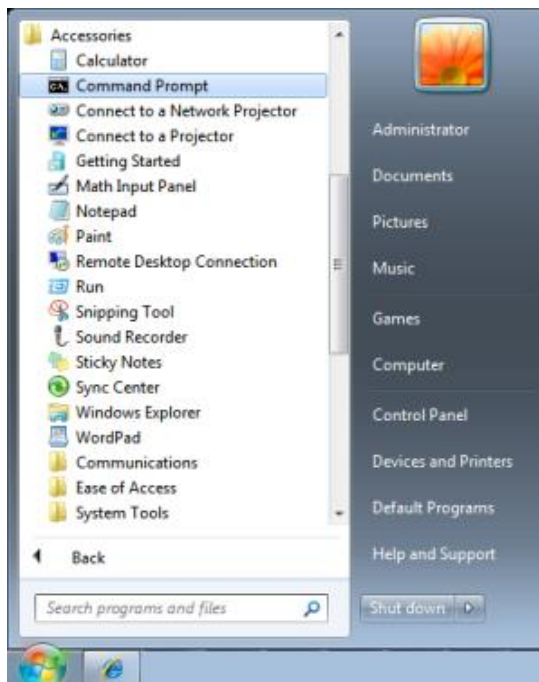

Input the command format like the below:

telnet ttt.xxx.yyy.zzz 23 (“Enter” key pressed)

(**ttt.xxx.yyy.zzz**: IP-Address of the projector)

If Telnet-Connection ready, and user can have RS232 command input, then “Enter” key pressed, the RS232 command will be workable.

How to have TELNET enabled in Windows VISTA / 7

By default installation for Windows VISTA, “TELNET” function is not included. But end-user can have it by way of “Turn Windows features On or Off” to be enabled.

Open “Control Panel” in Windows VISTA

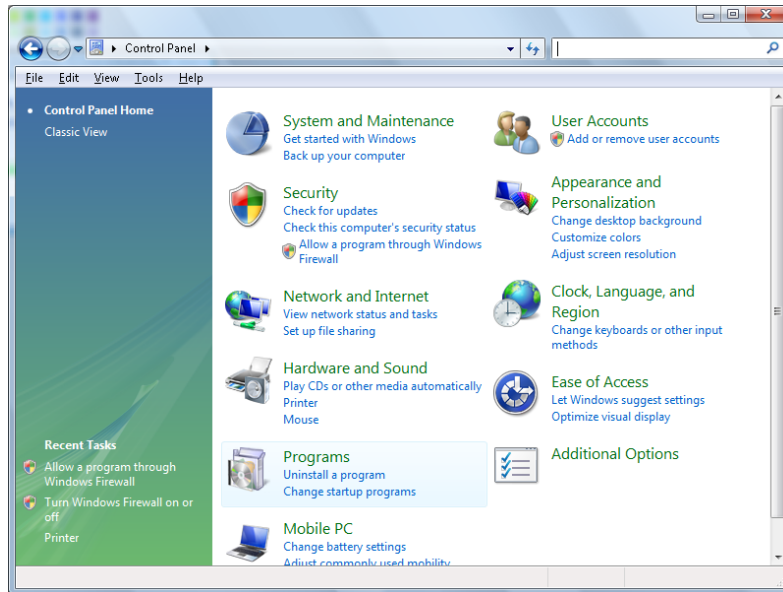

Open “Programs”

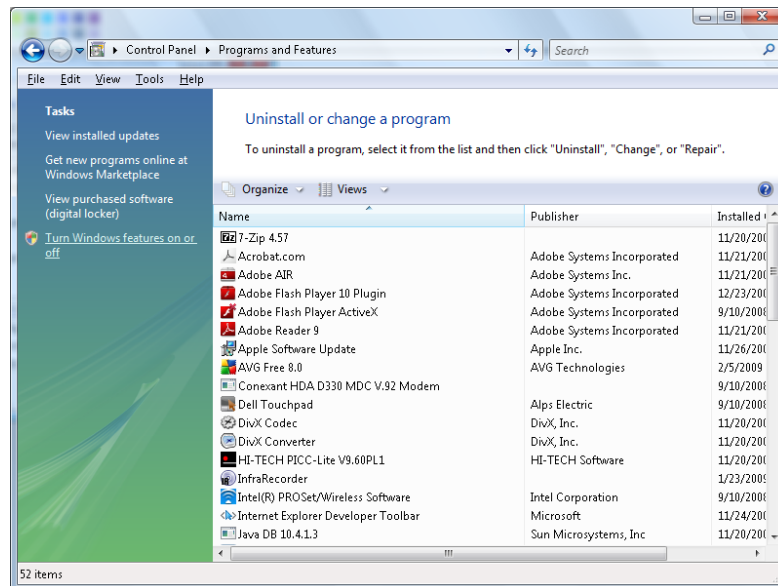

Select “Turn Windows features on or off” to open

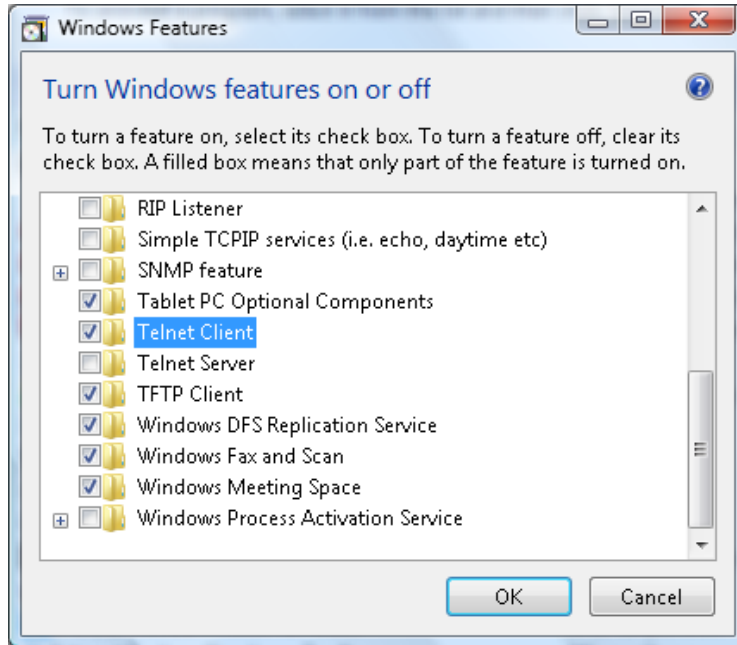

Have “Telnet Client” option checked, then press “OK” button.

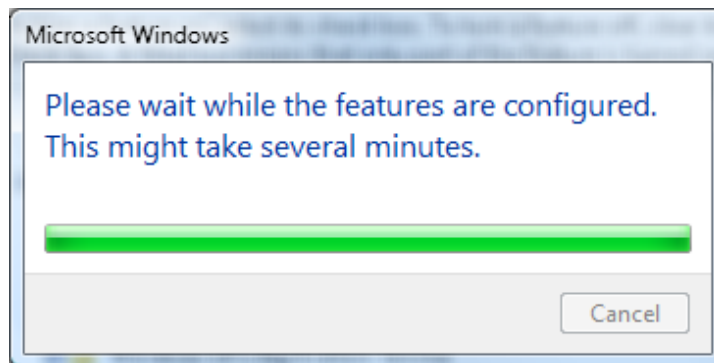

Specsheet for “RS232 by TELNET” :

1. Telnet: TCP
 2. Telnet port: 23 or 8000 (for more detail, please contact the service team)
 3. Telnet utility: Windows “TELNET.exe” (console mode)
 4. Disconnection for RS232-by-Telnet control normally: Close Windows Telnet utility directly after TELNET connection ready
 5. Limitation 1 for Telnet-Control: there is only one connection for Telnet-Control in one projector
Limitation 2 for Telnet-Control: there is less than 50 bytes for successive network payload for Telnet-Control application.
Limitation 3 for Telnet-Control: there is less than 26 bytes for one complete RS232 command for Telnet-Control.
Limitation 4 for Telnet-Control: Minimum delay for next RS232 command must be more than 200 (ms).
- (*, In Windows built-in “TELNET.exe” utility, “Enter” key pressed will have “Carriage-Return” and “New-Line” code.)

Factory Reset

Press the cursor ▲▼ button to move up and down in the **Installation II** menu. Select the **Factory Reset** sub menu and press ⏏ (Enter) / ▶ to reset all the menu items to the factory default values (except Language and Security Lock).

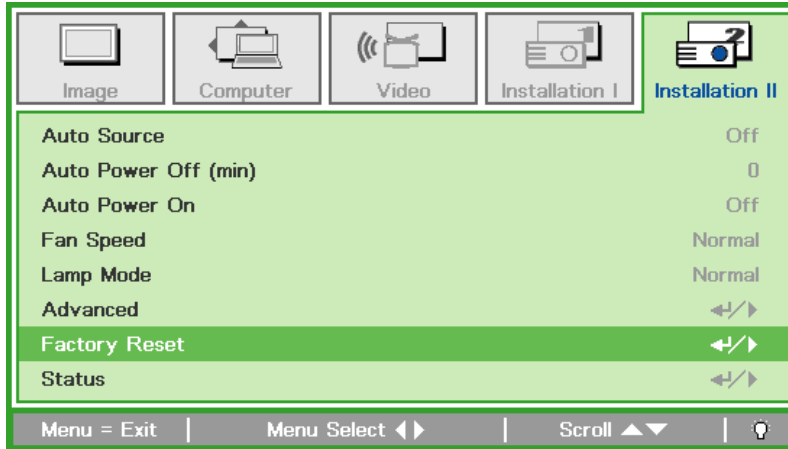

Status

Press the cursor ▲▼ button to move up and down in the **Installation II** menu. Select the **Installation II** sub menu and press ⏏ (Enter) / ▶ to enter the **Status** sub menu.

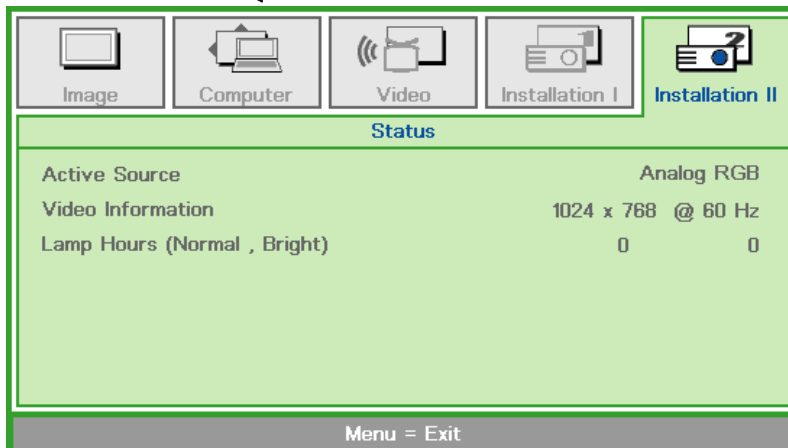

ITEM	DESCRIPTION
Active Source	Display the activated source.
Video Information	Displays resolution/video information for RGB source and color standard for Video source.
Lamp Hours (Normal, Bright)	Lamp hour used information is displayed. Normal and Bright counters are separated.

Replacing the Projection Lamp

The projection lamp should be replaced when it burns out. It should only be replaced with a certified replacement part, which you can order from your local dealer.



Important:

- a. The projection lamp used in this product contains a small amount of mercury.
- b. Do not dispose this product with general household waste.
- c. Disposal of this product must be carried out in accordance with the regulations of your local authority.



Warning:

Be sure to turn off and unplug the projector at least 30 minutes before replacing the lamp. Failure to do so could result in a severe burn.

1. Remove the single screw on the lamp compartment cover.

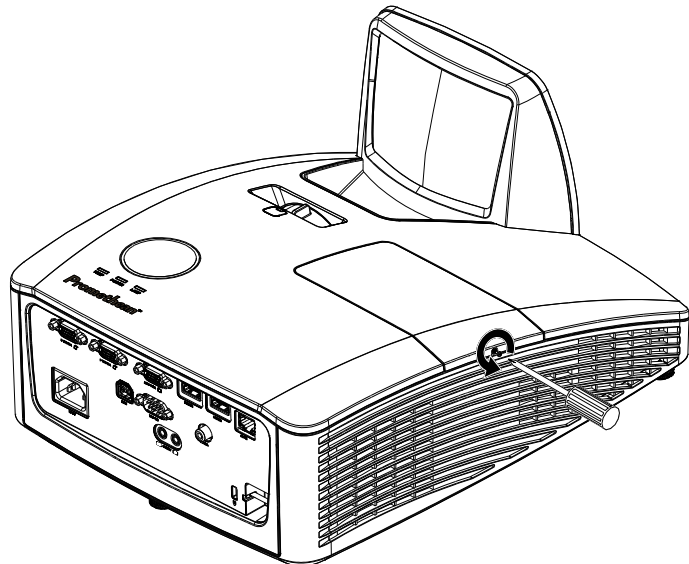

2. Remove the lamp compartment cover.

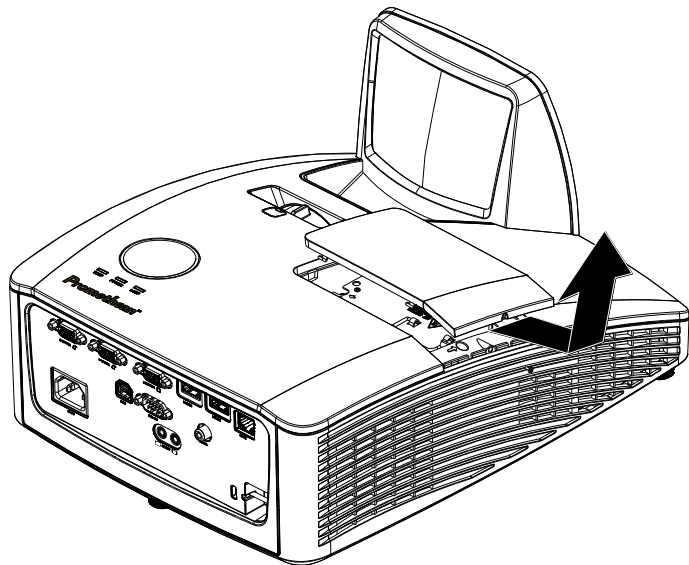

3. Remove the two screws from the lamp module.

4. Lift the module handle up.

5. Pull firmly on the module handle to remove the lamp module.

6. Reverse steps 1 to 5 to install the new lamp module.
While installing, align the lamp module with the connector and ensure it is level to avoid damage.

Note: The lamp module must sit securely in place and the lamp connector must be connected properly before tightening the screws.

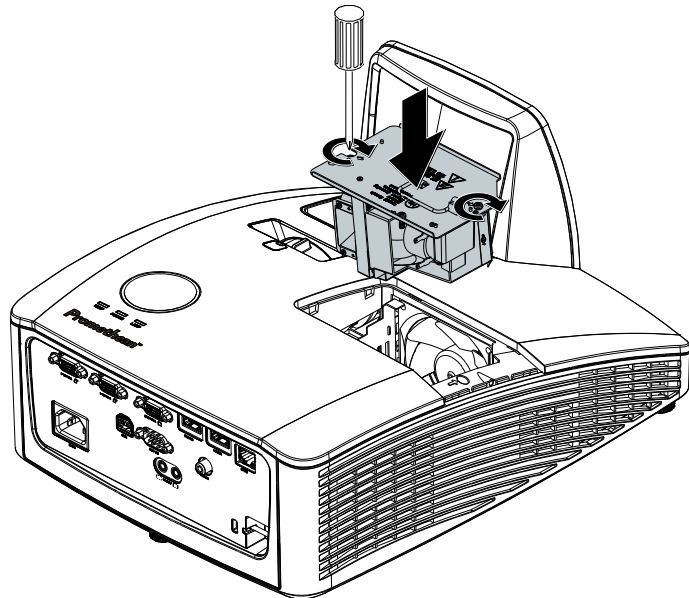
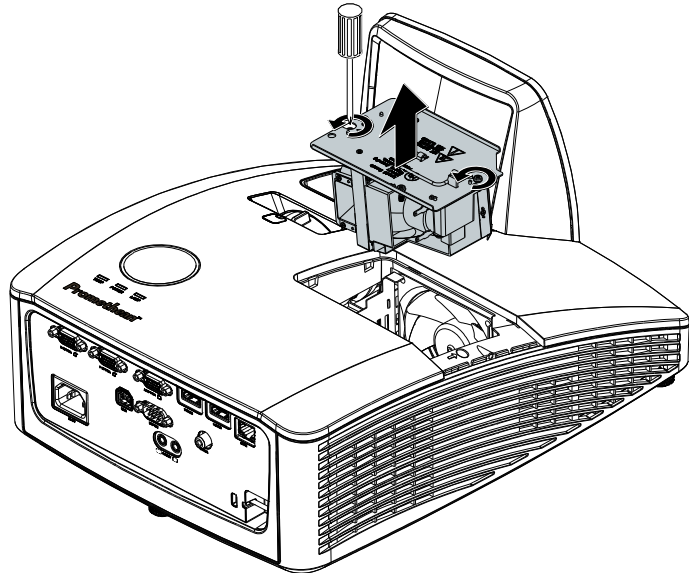

Resetting the Lamp

After replacing the lamp, you should reset the lamp hour counter to zero. Refer to the following:

1. Press the **MENU** button to open the OSD menu.

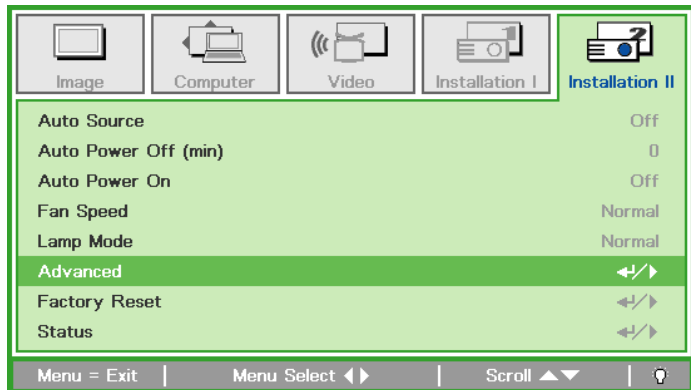

2. Press the cursor ◀▶ button to move to the **Installation II** menu. Press the cursor button to move down to **Advanced**.

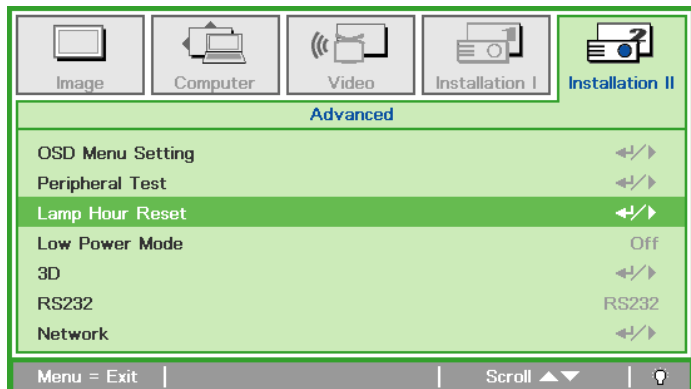

3. Press the cursor ▼▲ button to move down to **Lamp Hour Reset**.

4. Press the cursor ▶ or Enter button.

A message screen appears.

5. Press ▼▲◀▶ buttons to reset the lamp hour.

6. Press the **MENU** button to get back to Installation II.

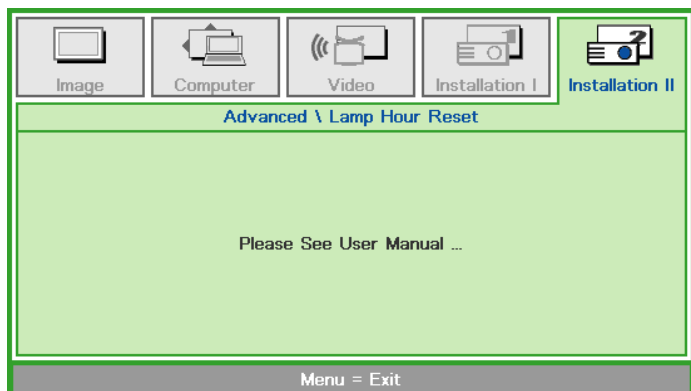

Cleaning the Projector

Cleaning the projector to remove dust and grime will help ensure trouble-free operation.

Cleaning the Projector Mirror:

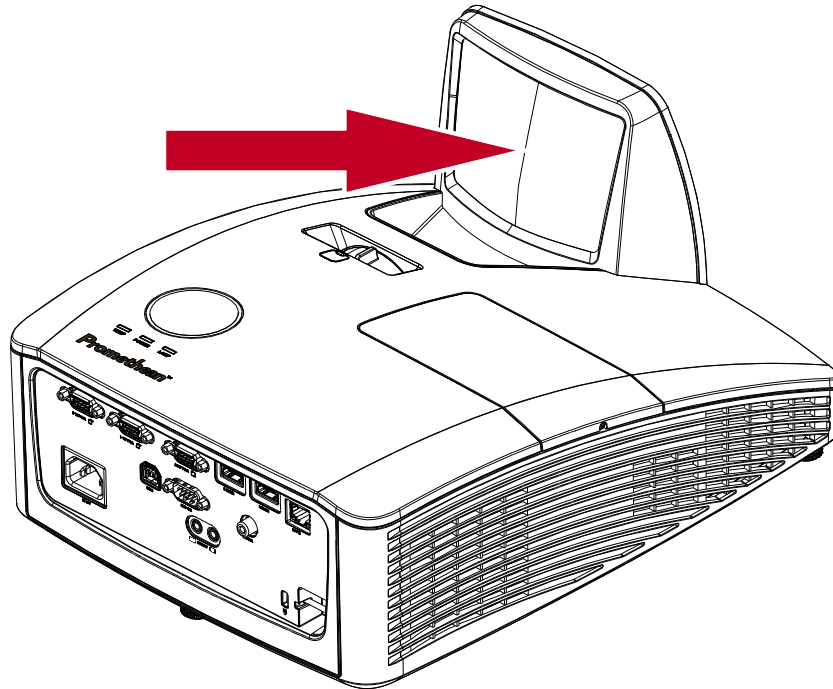

1. Remove dust with a "Bellows/Lens Blower" readily available from Camera shops to prevent scratching the mirror when subsequently wiped.
2. Gently wipe with a lens cleaning cloth or alternatively, use a lens cleaning tissue in conjunction with a small amount of lens cleaning fluid.



Cautions:

1. Always turn the projector off and allow to cool for at least 30 minutes prior to cleaning.
2. Never touch the projector mirror or Lens directly by hand.
3. Do not use hard fibre cloths.
4. Do not use abrasive cleaners, solvents or other harsh chemical cleaners.

Cleaning the Case

Refer to the following to clean the projector case.

1. Wipe off dust with a clean dampened cloth.
2. Moisten the cloth with warm water and mild detergent (such as used to wash dishes), and then wipe the case.
3. Rinse all detergent from the cloth and wipe the projector again.
4. It is important to clean the case regularly to prevent dust from entering the projector interior.



Caution:

To prevent discoloration or fading of the case, do not use abrasive alcohol-based cleaners.



Warning:

1. *Be sure to turn off and unplug the projector at least 30 minutes before cleaning. Failure to do so could result in a severe burn.*
2. *Use only a dampened cloth when cleaning. Do not allow water to enter the ventilation openings on the projector.*
3. *If a little water gets into the projector interior while cleaning, leave unplugged in a well-ventilated room for several hours before using.*
4. *If a lot of water gets into the projector interior when cleaning, have the projector serviced.*

Using the Physical Lock

Using the Kensington® Lock

If you are concerned about security, attach the projector to a permanent object with the Kensington slot and a security cable.

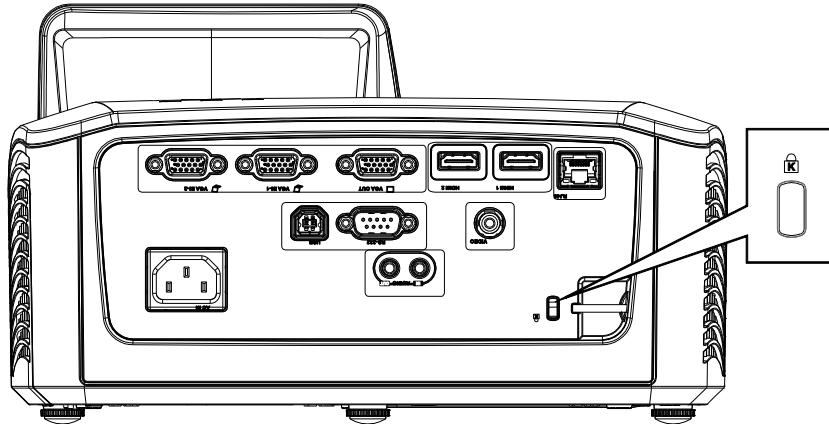

Note:

Contact your vendor for details on purchasing a suitable Kensington security cable.

The security lock corresponds to Kensington's MicroSaver Security System. If you have any comment, contact: Kensington, 2853 Campus Drive, San Mateo, CA 94403, U.S.A. Tel: 800-535-4242, <http://www.Kensington.com>.

Using the Security Bar

In addition to the password protection function and the Kensington lock, the Security Bar helps protect the projector from unauthorized removal.

See the following picture.

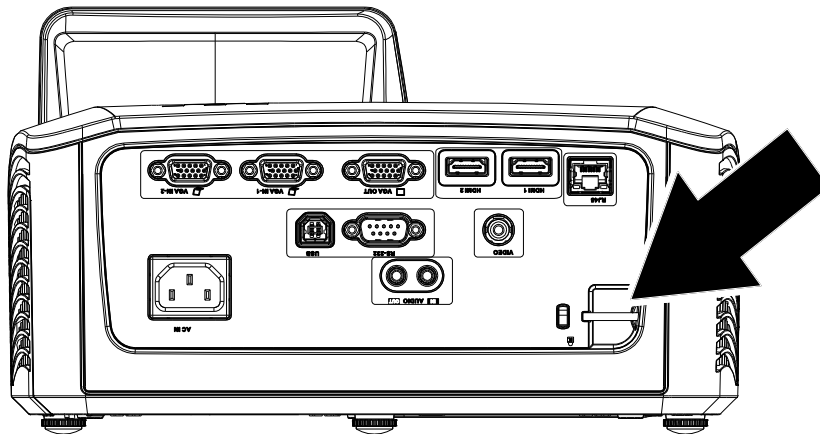

Common problems and solutions

These guidelines provide tips to deal with problems you may encounter while using the projector. If the problem remains unsolved, contact your dealer for assistance.

Often after time spent troubleshooting, the problem is traced to something as simple as a loose connection. Check the following before proceeding to the problem-specific solutions.

- *Use some other electrical device to confirm that the electrical outlet is working.*
- *Ensure the projector is turned on.*
- *Ensure all connections are securely attached.*
- *Ensure the attached device is turned on.*
- *Ensure a connected PC is not in suspending mode.*
- *Ensure a connected notebook computer is configured for an external display. (This is usually done by pressing a Fn-key combination on the notebook).*

Tips for Troubleshooting

In each problem-specific section, try the steps in the order suggested. This may help you to solve the problem more quickly.

Try to pin point the problem and thus avoid replacing non-defective parts.

For example, if you replace batteries and the problem remains, put the original batteries back and go to the next step.

Keep a record of the steps you take when troubleshooting: The information may be useful when calling for technical support or for passing on to service personnel.

LED Error Messages

ERROR CODE MESSAGES	TEMP LED	LAMP LED BLINK	POWER LED BLINK
Power On	0	0	Green
Power Off	0	0	Green
Cooling	0	0	Flashing
Over Temperature	ON	0	0
Thermal Break Sensor error	0	0	4
Lamp error	0	ON	0
Fan 1	0	1	6
Fan 2	0	2	6
Fan 3	0	3	6
Fan 4	0	4	6
Lamp Door Open	0	0	7
DMD error	0	0	8
Color wheel error	0	0	9

In the event of an error, please disconnect the AC power cord and wait for one (1) minute before restarting the projector. If the POWER or LAMP LEDs are still blinking or the TEMP LED is lit, contact your service center.

Image Problems

Problem: No image appears on the screen

1. Verify the settings on your notebook or desktop PC.
2. Turn off all equipment and power up again in the correct order.

Problem: The image is blurred

1. Press the **Auto** button on the remote control or projector.
2. Ensure the projector-to-screen distance is within the 340.3mm+/-10mm (for 16:10 87") or 421.9mm+/-10mm (for 16:9 95") specified range.
3. Check that the projector lens is clean.

Problem: The image is wider at the top or bottom (trapezoid effect)

1. Position the projector so it is as perpendicular to the screen as possible.
2. Use the **Keystone** button on the remote control or projector to correct the problem.

Problem: The image is reversed

Check the **Projection** setting on the **Installation I** menu of the OSD.

Problem: The image is streaked

1. Set the **Frequency** and **Tracking** settings on the **Computer** menu of the OSD to the default settings.
2. To ensure the problem is not caused by a connected PC's video card, connect to another computer.

Problem: The image is flat with no contrast

Adjust the **Contrast** setting on the **Image** menu of the OSD.

Problem: The color of the projected image does not match the source image.

Adjust the **Color Temperature** and **Gamma** settings on the **Image** menu of the OSD.

Lamp Problems

Problem: There is no light from the projector

1. Check that the power cable is securely connected.
2. Ensure the power source is good by testing with another electrical device.
3. Restart the projector in the correct order and check that the Power LED is on.
4. If you have replaced the lamp recently, try resetting the lamp connections.
5. Replace the lamp module.
6. Put the old lamp back in the projector and have the projector serviced.

Problem: The lamp goes off

1. Power surges can cause the lamp to turn off. Re-plug power cord. When the POWER LED is on, press the power button.
2. Replace the lamp module.
3. Put the old lamp back in the projector and have the projector serviced.

Remote Control Problems

Problem: The projector does not respond to the remote control

1. Direct the remote control towards remote sensor on the projector.
2. Ensure the path between remote and sensor is not obstructed.
3. Turn off any fluorescent lights in the room.
4. Check the battery polarity.
5. Replace the batteries.
6. Turn off other Infrared-enabled devices in the vicinity.
7. Have the remote control serviced.

Having the Projector Serviced

If you are unable to solve the problem, you should have the projector serviced. Pack the projector in the original carton. Include a description of the problem and a checklist of the steps you took when trying to fix the problem: The information may be useful to service personnel. For servicing, return the projector to the place you purchased it.

Specifications

Model	UST-P2 / UST-P1V1 UST-P2C / UST-P1CV1	
Display type	DMD 0.65" WXGA	
Resolution	WXGA 1280 x 800 Native	
Projection distance	340.3+/-10mm	421.9+/-10mm
Projection screen size (diagonal)	16:10 (87")	16:9 (95")
Vertical keystone correction	+/- 40 degrees	
Projection methods	Front, Rear, Desktop/Ceiling (Rear, Front)	
Data compatibility	VGA, SVGA, XGA, SXGA, UXGA, Mac	
SDTV/EDTV/ HDTV	480i, 576i, 480p, 576p, 720p, 1080i, 1080p	
Video compatibility	NTSC/NTSC 4.43, PAL (B/G/H/I/M/N/60), SECAM	
H-Sync	15, 30 – 91.4 kHz	
V-Sync	24-30, 47-120 Hz	
Safety certification	FCC-B, UL, CB, CE, CCC, GOST, SASO, KUCAS, TUV-Safety	
Operation temperature	5° ~ 40°C	
Net weight	4.75 kg	
Gross weight	9.0 kg	
Projector Dimensions	287.7 mm (W) x 122.6 mm (H) x 374.5 mm (D)	
Box dimensions	440 mm (W) x 291 mm (H) x 591 mm (D)	
AC Input	AC Universal 100 ~ 240, Typical @ 110VAC (100~240)/+/-10%	
Power consumption	300W	
Stand By	<0.5 watt	
Lamp	230W	
Input Terminals	VGA x 2	
	Mini jack x 1 (Audio In)	
	Composite Video x 1	
	HDMI x 2	
Output Terminals	VGA x 1 (Loop Thru only for VGA IN-1)	
	Mini jack x 1 (Audio out)	
Control Terminals	RS-232C	
	RJ45 (10/100 Mbps)	
	USB (type B)	
Security	Kensington lock	

Projection Distance vs. Projection Size

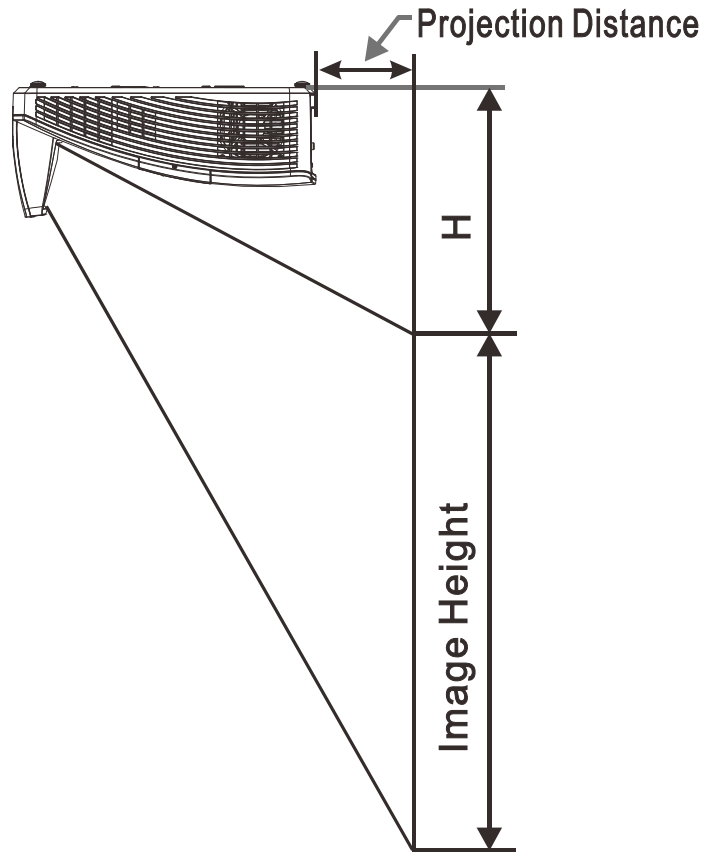

Projection Distance and Size Table

	WXGA		XGA
	16:9	16:10	4:3
Distance	421.9+/-20mm	340.3+/-20mm	372.1+/-20mm
Diagonal	95"	87"	78"
Image Width	2089mm	1880mm	1566mm
Image height	1175mm	1175mm	1175mm
H	327.6+/-50mm	300.2+/-50mm	310.7+/-50mm

Timing Mode Table

The projector can display several resolutions. The following table outlines the resolutions that can be displayed by the projector.

SIGNAL	RESOLUTION	H-SYNC (KHz)	V-SYNC (Hz)	COMPOSITE	COMPONENT	RGB (ANALOG)	DVI/ HDMI (DIGITAL)
NTSC	—	15.734	60.0	O	—	—	—
PAL/SECAM	—	15.625	50.0	O	—	—	—
VESA	720 x 400	37.9	85.04	—	—	o	o
	640 x 480	31.5	60.0	—	—	o	o
	640 x 480	37.9	72.8	—	—	o	o
	640 x 480	37.5	75.0	—	—	o	o
	640 x 480	43.3	85.0	—	—	o	o
	800 x 600	35.2	56.3	—	—	o	o
	* 800 x 600	37.9	60.3	—	—	o	o
	800 x 600	46.9	75.0	—	—	o	o
	800 x 600	48.1	72.2	—	—	o	o
	800 x 600	53.7	85.1	—	—	o	o
	** 800 x 600	76.3	120.0	—	—	o	o
	1024 x 576	35.8	60.0	—	—	o	o
	1024 x 600	37.3	60.0	—	—	o	o
	1024 x 600	41.5	65.0	—	—	o	o
	* 1024 x 768	48.4	60.0	—	—	o	o
	1024 x 768	56.5	70.1	—	—	o	o
	1024 x 768	60.0	75.0	—	—	o	o
	1024 x 768	68.7	85.0	—	—	o	o
	** 1024 x 768	97.6	120.0	—	—	o	o
	1024 x 768	99.0	120.0	—	—	o	o
1152 x 864	67.5	75.0	—	—	o	o	
* 1280 x 720	45.0	60.0	—	—	o	o	

SIGNAL	RESOLUTION	H-SYNC (KHz)	V-SYNC (Hz)	COMPOSITE	COMPONENT	RGB (ANALOG)	DVI/ HDMI (DIGITAL)
	* 1280 x 720	90.0	120.0	—	—	○	○
	1280 x 768	47.4	60.0	—	—	○	○
	* 1280 x 768	47.8	59.9	—	—	○	○
	* 1280 x 800	49.7	59.8	—	—	○	○
	1280 x 800	62.8	74.9	—	—	○	○
	1280 x 800	71.6	84.9	—	—	○	○
	** 1280 x 800	101.6	119.9	—	—	○	○
	*** 1280 x 1024	64.0	60.0	—	—	○	○
	1280 x 1024	80.0	75.0	—	—	○	○
	1280 x 1024	91.1	85.0	—	—	○	○
	*** 1280 x 960	60.0	60.0	—	—	○	○
	1280 x 960	85.9	85.0	—	—	○	○
	*** 1360 x 768	47.7	60.0	—	—	○	○
	*** 1400 x 1050	65.3	60.0	—	—	○	○
	1440 x 900	55.5	59.9	—	—	○	○
	*** 1440 x 900	55.9	59.9	—	—	○	○
	1440 x 900	70.6	75.0	—	—	○	○
	1600 x 1200	75.0	60	—	—	○	○
	1680 x 1050	64.7	59.9	—	—	○	○
	1680 x 1050	65.3	60.0	—	—	○	○
	1920 x 1200	74.0	60.0	—	—	○	○
	1920 x 1080	67.5	60.0	—	—	○	○
Apple Macintosh	640 x 480	35.0	66.7	—	—	○	○
	832 x 624	49.7	74.5	—	—	○	○
	1024 x 768	60.2	74.9	—	—	○	○
	1152 x 870	68.7	75.1	—	—	○	○

SIGNAL	RESOLUTION	H-SYNC (KHz)	V-SYNC (Hz)	COMPOSITE	COMPONENT	RGB (ANALOG)	DVI/ HDMI (DIGITAL)
SDTV	480i	15.734	60.0	—	O	—	O
	576i	15.625	50.0	—	O	—	O
EDTV	576p	31.3	50.0	—	O	—	O
	480p	31.5	60.0	—	O	—	O
HDTV	720p	37.5	50.0	—	O	—	O
	720p	45.0	60.0	—	O	—	O
	1080i	33.8	60.0	—	O	—	O
	1080i	28.1	50.0	—	O	—	O
	1080p	27	24	—	O	—	O
	1080p	28	25	—	O	—	O
	1080p	33.7	30	—	O	—	O
	1080p	67.5	60.0	—	O	—	O
	1080p	56.3	50.0	—	O	—	O

O: Frequency supported

—: Frequency not supported

★3D note :

“★” It means the timing can support non-3D and 3D signal with Frame Sequential and Top-Bottom format.

“★★”It means the timing can support non-3D and 3D signal with Frame Sequential format.

“★★★”It means the timing can support non-3D and 3D signal with Top-Bottom format.

There 3D timing showing depend the EDID file and display card. It is possible that user cannot choose the above 3D timings on display card.

The resolution of the panel is 1280 x 800. Resolution other than native resolution may display with uneven size of text or lines.

Projector Dimensions

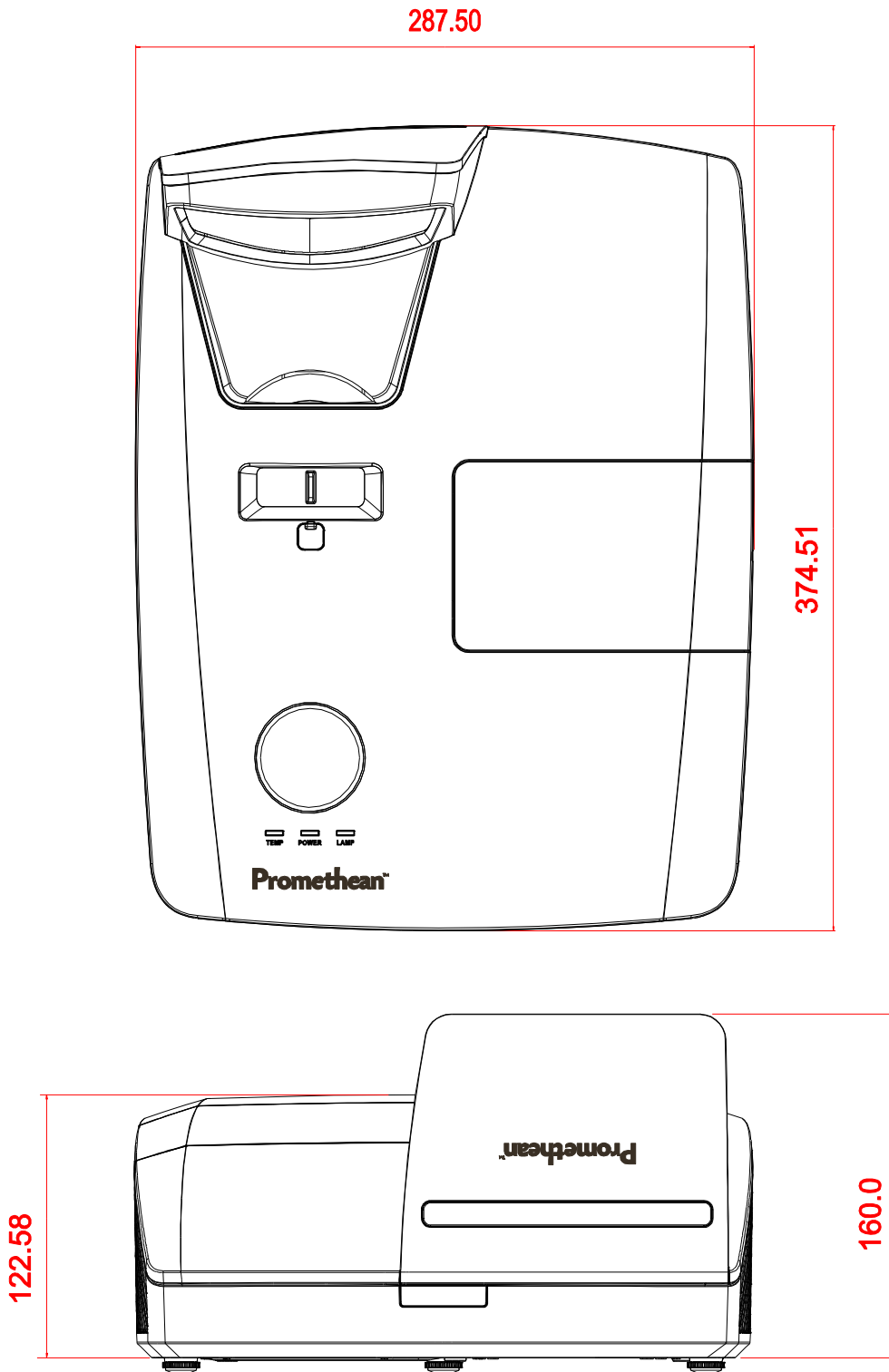

FCC Warning

This equipment has been tested and found to comply with the limits for a Class B digital device pursuant to Part 15 of the FCC Rules. These limits are designed to provide reasonable protection against harmful interference when the equipment is operated in a commercial environment.

This equipment generates, uses, and can radiate radio frequency energy and, if not installed and used in accordance with the instruction manual, may cause harmful interference to radio communications. Operation of this equipment in a residential area is likely to cause harmful interference in which case the user will be required to correct the interference at his/her own expense.

Changes or modifications not expressly approved by the parties responsible for compliance could void the user's authority to operate the equipment.

Canada

This class B digital apparatus complies with Canadian ICES-003.

Safety Certifications

FCC-B, UL, CB, CE, CCC, GOST, SASO, KUCAS and TUV-Safety