

Digital Series Operators Manual

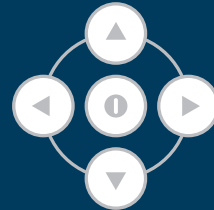

PUREX
FUME EXTRACTION SYSTEMS

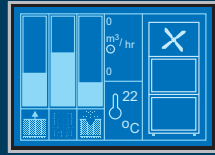

PUREX
FUME EXTRACTION SYSTEMS

Visit www.purex.co.uk for more information.

“Protecting People and the Environment with Innovative Technology”

822005-rev7

ATTENTION!

LEV REGISTRATION

ATTENTION!

LEV (Local Exhaust Ventilation) equipment must be tested annually by law, according to the COSHH regulations in the UK. Please register your Purex unit using the form below to ensure a test is arranged. Customers in other countries should register with their local supplier.

Machine details

Model/Serial Number

Purchased from

Date of purchase

Process

Your details

Title

First name

Surname

Position

Company

Address 1

Address 2

Town/City

Zip/Post code

Telephone

Fax

Email

Send to Purex, or your local supplier:

Purex International Ltd. QWP House, Capitol Park, Thorne, Doncaster, DN8 5TX, UK

T +44 (0)1405 746 030 F +44 (0)1405 746 047 W www.purex.co.uk E purex@purex.co.uk

Registered Office: Purex International Ltd. QWP House, Capitol Park, Thorne, Doncaster, DN8 5TX. Registered No. 5136616 England. VAT No. GB842 5025 49

Purex Inc, 2246 Palmer Drive, Unit 108, Schaumburg IL 60173, United States. W www.purexinc.com T +1847 348 5203

CONTENTS

	Page
LEV registration	2
Consumables & spares	3
EC declaration of conformity	4
Warnings	5
Routine maintenance	5
Installing the machine	6-9
Control system	9-10
Filtration & changing filters	11-13
Changing a fuse	14
Trouble shooting	15-16
Terms & conditions	17
LEV logbook	18

ATTENTION!

CONSUMABLES & SPARES

ATTENTION!

Filters

Should always be ordered in advance of requirement from Purex or your authorised local agent.

Replacement filter part numbers are shown on the original packaging, please ensure you make a note here for future reference:

Prefilter Part Numbers	
Main Filter Part Numbers	

Spare parts

When requesting spares please quote the model and serial number of your system. These details can be found on the specification label at the rear of the machine.

EC DECLARATION OF CONFORMITY

EC Directive	2014/30/EU, 2014/35/EU, 2006/42/EC
Responsible Person	Mr Andrew Easey Purex International Limited QWP House Capitol Park Thorne Doncaster DN8 5TX United Kingdom
Apparatus	200, 200i, 200i-HP, 300i, 400, 400i, 400i PVC, 800, 800i, 800i PVC
Technical Construction File	Purex Engineering File - Issue 3
Date	4th November 2016
Standards Applied	IEC 60950-1:2005/A2:2013 EN 60950-1: 2006/A2:2013 UL 60950-1:2007/R:2014-10 CAN/CSA C22.2 No.60950-1:2007/A2:2014-10 FCC CFR 47: PART 15: B: 2015 ICES-003: 2012 EN 61000-6-1:2007 EN 61000-6-3:2007+A1:2011
Meeting the Requirements of	2014/30/EU EMC Directive 2006/42/EC Machinery Directive 2011/65/EU RoHS Directive

We certify that the Purex equipment stated above conforms with the protection requirements of the Council Directives indicated above on the approximation of the laws of the Member States relating to electromagnetic compatibility, low voltage and machinery safety.

Signed: Andrew Easey
Position: Operations Director
Date: 7th July 2017



WARNINGS

**The use of filters other than those supplied by Purex
will invalidate any warranty, service contract and any LEV certification !**

- Always isolate the system from the mains power supply before removing the machine cover.
- Disposable gloves and a dust mask are supplied with replacement filters/prefilters. They should be worn when removing filters and disposed of with the used filter in the bag which is also provided.
- Filters are manufactured from non-toxic materials.
- Filters and prefilters are not re-usable and no attempt should be made to clean them.
- Used filters and prefilters should be disposed of in accordance with local laws and regulations. The company and its agents disclaim all liability and responsibility for any harm, damage, contamination or injury caused by inappropriate or unlawful disposal.
- Purex systems use high pressure pumps, which may cause inferior filters to burst, allowing hazardous fumes into the workplace. Do not use filters that have only been tested to BS3928, BS5295 or AS208C as these standards are flow checks only and are designed to test filters used in general dust extraction and air conditioning.
- Consult the local regulations concerning fume extraction systems, as these may be subject to requirements including; periodic checks by authorised agencies, re-issue of certificates of compliance or equivalents etc. Consult your supplier if in doubt.
- Consult your supplier for information on maintenance agreements that will ensure conformance to local regulations.

ROUTINE MAINTENANCE

Schedule

Primary maintenance is filter replacement, the machine control system will indicate when this is required. Filters should be replaced annually as a matter of course.

To ensure the smooth running of the extraction machine and associated equipment, please follow the LEV logbook on page 18.

Circuit breaker tripped or fuse blown

May indicate a serious fault. Consult your supplier.

LEV (Local Exhaust Ventilation) equipment must be tested annually by law, according to the COSHH regulations in the UK. Please register your Purex unit using the form on page 2. to ensure a test is arranged. Customers in other countries should register with their local supplier.

INSTALLING THE MACHINE

200
400

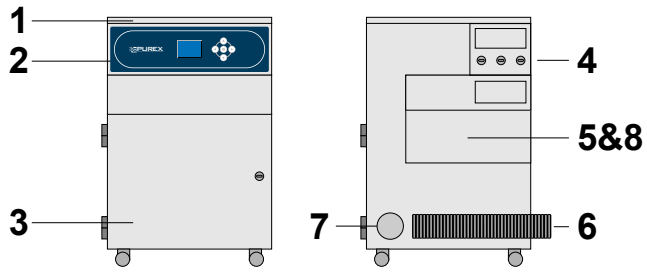

300i

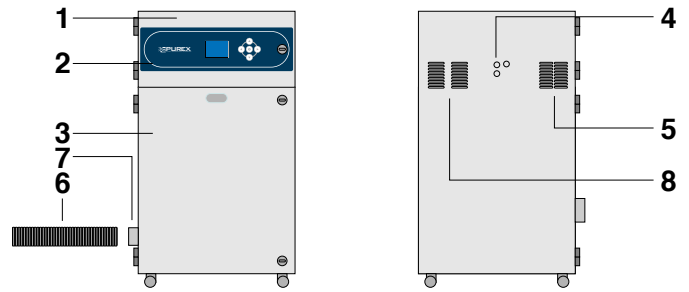

200i
400i

PVC

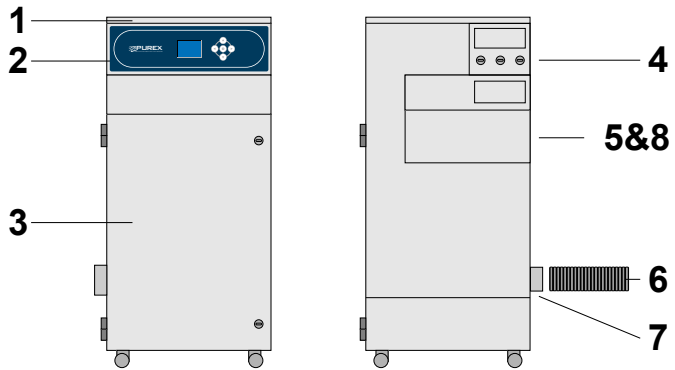

650

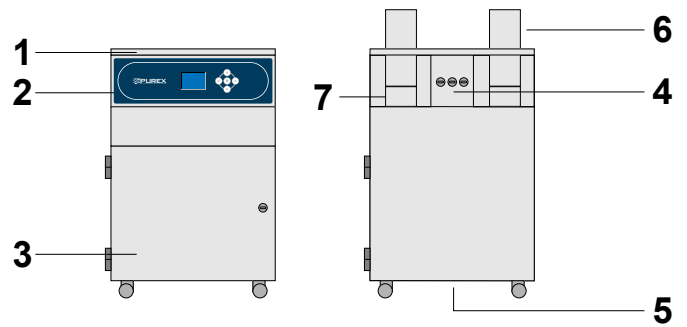

INSTALLING THE MACHINE

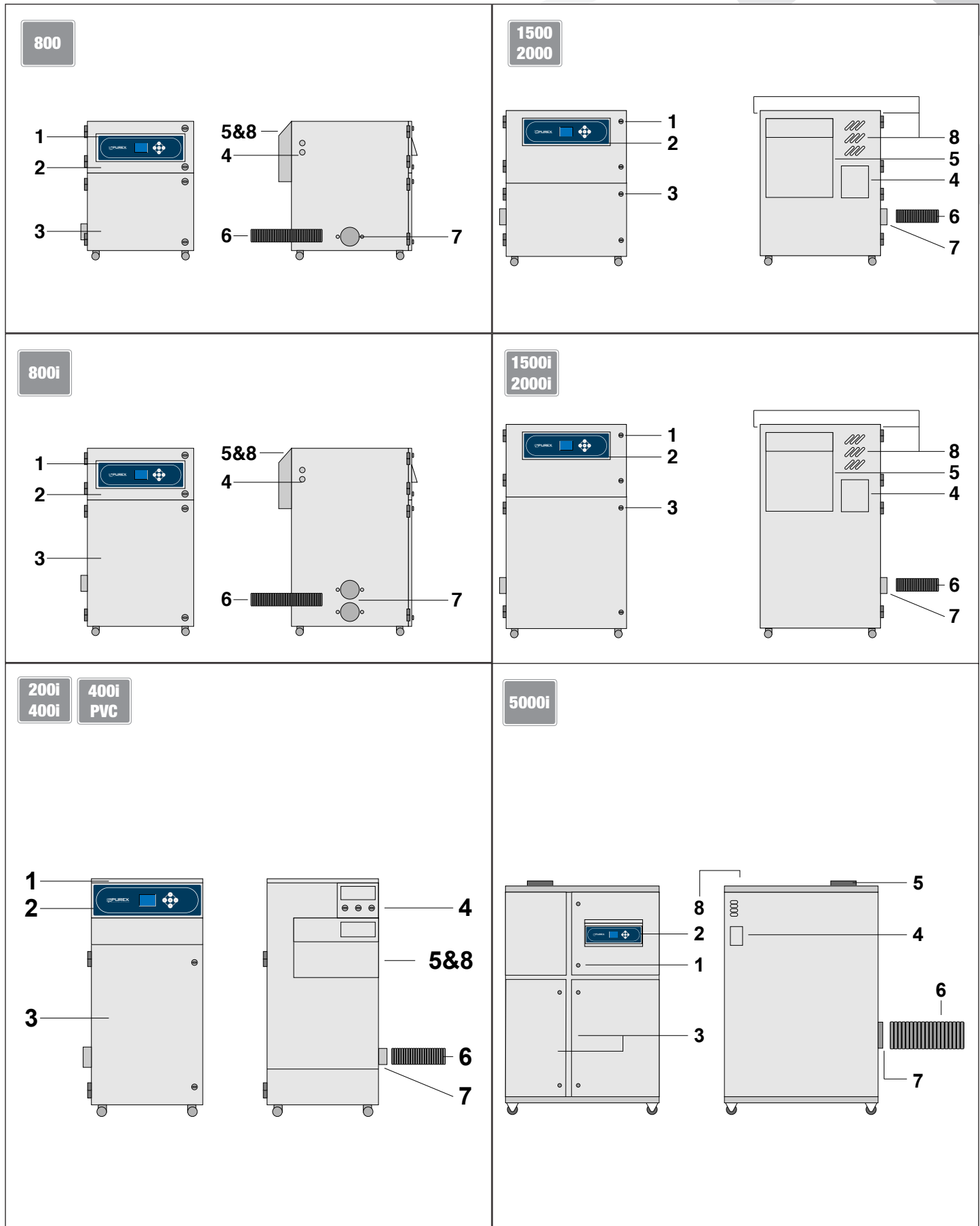

LEGEND:

- 1. Access to internal components
- 2. Control panel

- 3. Access to replace filters
- 4. Electrical connections
- 5. Exhaust air

- 6. Hose or duct
- 7. Inlet
- 8. Cooling air

INSTALLING THE MACHINE

Positioning the machine

The machine should be as near to the process as possible with space allowed for the following access:

- Internal maintenance
- Control panel, replacing filters
- Exhaust air + cooling air, electrical connections, hose connection

Once in position, lock the two front castors by depressing the foot levers (if present).

Hose connection

Incorrect connection or layout of hose can cause poor airflow, blockages and potentially dangerous build up of fume. Use the shortest length of hose possible and keep bends to a minimum. Your supplier can advise you of appropriate diameters and layouts of hose for your particular application.

- It is best practice to use the connection kit supplied.
- Do not reduce the diameter of the pipe / hose too much. The use of small diameter pipe / hose or nozzles can reduce the performance of fume extraction systems and so should be avoided
- If a special connection kit or attachment is required please contact Purex or your local agent.

Ensure all connections are properly sealed and that there are no kinks in the hose. Once secured in position, connect the hose/s to the inlet/s on the machine either by pushing the hose onto the inlet or by using the connections supplied.

Electrical connection

Various connection methods are available to order. Prior to connecting the power supply, ensure that the voltage, frequency and power requirements are correct as shown on the label attached to the cabinet rear (Note - These are MAX values). It is important that the local supply is protected by a circuit breaker of the correct rating, and the cabling and plug type used are similarly rated. Ensure plug is accessible as a disconnect device or use a similar method of isolation.

Purex recommend the use of a dedicated supply to their single phase units.

- In the case of single phase equipment a 13A fused spur is recommended.
- All units should be protected by a 16A Type C circuit breaker in the customer's circuit.
- Purex International do not recommend the use of RCDs but where their use is mandatory, single phase units (up to and inc 1500i) require a 300mA RCD type A and 3 phase units (2000i & 5000i) require a 300mA RCD Type B.
- Machines up to and including the 600 model are supplied with a power cable and plug attached according to your order.
- Machines from 800 model upwards are supplied with a fixed power cable without a plug. These machines should be hard wired into the electrical supply by a qualified electrician following local regulations and practices.

INSTALLING THE MACHINE

Interfacing (Where fitted)

When not in use this socket is protected by a screw-on cap. To enable interfacing unscrew the interface socket cap and plug in the interface cable or remote ON/OFF switch (optional). Then connect the other end of the interface cable to your related machine or use the remote ON/OFF switch depending on which you have purchased. Please note there is only one interface socket so an interface cable and the remote ON/OFF switch cannot be used together.



The interfacing socket.

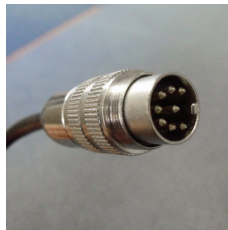

An interfacing cable



Remote ON/OFF switch (5m)

CONTROL SYSTEM

Switching the machine ON/OFF

To switch the machine **ON** press the central button on the keypad. The central button will illuminate (green) and the motor run indicator on the graphic display will rotate.

Pressing the central button again will switch the machine **OFF**, extinguish the green light and the motor run indicator on the graphic display will stop rotating.

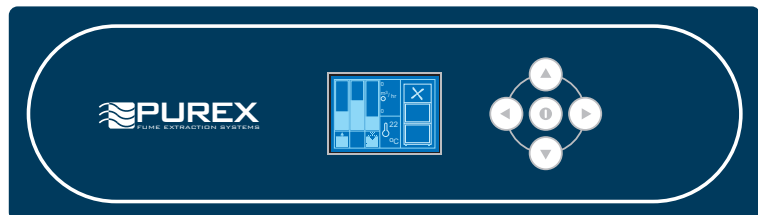

Adjusting the airflow rate

To adjust the airflow rate press the **UP** and **DOWN** buttons together. Both buttons will then begin to flash (red). To increase the airflow rate press the **UP** button, to decrease the airflow rate press the **DOWN** button.

The target airflow measurement is shown on the graphic display together with the actual airflow being achieved by the fume extractor. Once the target value has been set, do not touch any other buttons. After a few seconds the buttons will cease to flash and the set value will be stored.

What airflow rate to set?

For most applications a good starting point is a flow rate of 50% of the machines maximum capability. Check the fumes are being removed by site observation and appropriate measurement. Then increase or decrease the flow rate as appropriate. Please note that setting the flow level unnecessarily high may reduce filter life.

Fully automatic operation

The airflow rate is the only parameter that needs to be set by the operator. The Purex machine will automatically maintain the airflow level you have set without any further intervention required.

CONTROL SYSTEM

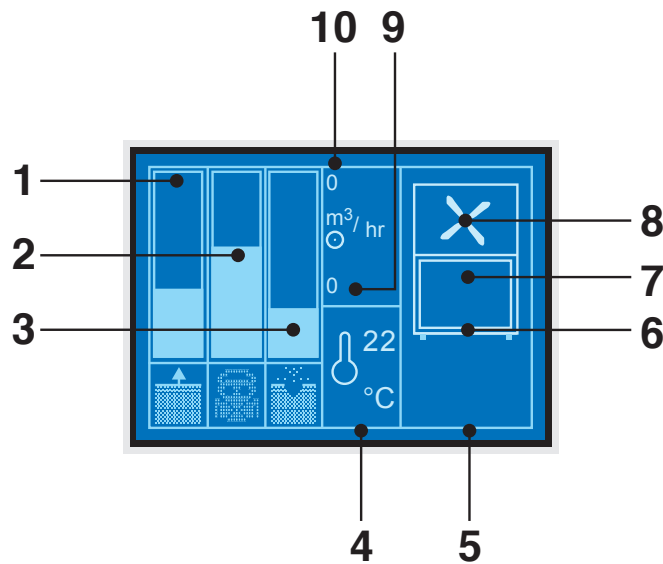

Graphic Display:

- 1: Column 1 - Filter blocked warning
- 2: Column 2 - Gas sensor
- 3: Column 3 - Particulate sensor
- 4: Exhaust temperature
- 5: Machine icon (varies)
- 6+7: Filter fault indicators (varies)
- 8: Motor run indicator
- 9: Target airflow
- 10: Actual airflow being achieved

Graphic Display

The graphic display shows the operating status of the machine in one easy glance.

Filter Fault Indicators Note

Some machines use a single combined particle / chemical filter while others employ separate chemical and particle filters. Therefore the machine icons and filter positions (see 5,6,7) may vary depending on the type of machine you have.

Filter Status (1,2,3)

Purex Digital machines warn the operator if the chemical filter is saturated or the particle filter is blocked. Sensors are also used to warn the operator if particles or gas are passing through the machine into the workplace due to a missing, damaged or incorrectly fitted filter.

When gas or particles are sensed or the filter is nearly saturated/blocked, the machine will warn the operator with an audible chime and the keypad will flash (red).

At this point the appropriate filter icon (see 5,6,7) will flash to show which filters may need attention. See Changing Filters Section.

Exhaust Temperature (4)

When the machine temperature rises above a preset limit the machine will warn the operator with an audible chime every 20 seconds and the keypad will flash (red) every 10 seconds. This feature allows the operator time to identify the problem. If the problem continues then the machine will chime and the keypad will flash (red) every 1 second. See problem solving section.

Motor Run Indicator (8)

This icon will rotate when the motor is running.

Target Airflow / Actual Airflow (9,10)

The operator can set the target airflow to the level they require, although in most cases this will be factory preset at the correct level. The Purex machine will automatically raise or lower the motor speed as required until the actual airflow rate equals the target airflow rate.

FILTRATION & CHANGING FILTERS

ENSURE ALL FILTERS ARE FITTED CORRECTLY PRIOR TO USING THE MACHINE.

DO NOT LIFT THE FILTERS USING THE HANDLES, THESE ARE ONLY TO BE USED FOR SLIDING THE FILTERS OUT OF THE MACHINE.

Important note:

Always check the extraction nozzle, flexible hose, any pipework and the air inlet for debris build up before changing any filter. This avoids false alerts related to airflow. Also, always change the pre-filter first (unless recently changed) and restart the machine. If the alert continues, change the main filter.

Changing filters

The machine will warn you with audible and visible alerts if a filter is exhausted (see control system). The graphic display will flash the icons of the filters which may need attention. Take care when removing main filters as they are heavy. Always wear the protective gloves and mask provided and dispose of with the used filters in the bag provided. Protective eyewear should also be worn when changing filters.

Opening the cabinet door

- Ensure your process is stopped
- Switch off your Purex machine at the control panel (see control system)
- Turn the door lock/s on the front of the machine
- Open the door



Changing the pre-filter

200/400/650/800/1500/2000 - Have a pad situated in a recess underneath the main filter. To remove the pad, first remove the main filter and turn it over (See *Changing the main filter*). Remove the pad and replace it with a new one. Make sure the harder, smoother side of the pad is facing the main filter.

200i/400i/300i/800i/1500i/2000i - All have Labyrinth pre-filters which can be removed by pulling the filter off the air inlet inside the machine before replacing with a new one. PVC machines also have an adsorbent pad in the base of the machine underneath the Labyrinth filter. This should be replaced at the same time as the Labyrinth filter. It is also good practice to wipe the inside of the machine periodically with a cloth to avoid build up of liquid. Suitable protective clothing should always be worn.

5000i - Can be fitted with a (Labyrinth filter) or (a pre-filter pad plus a pleated bag). The Labyrinth bag is removed by pulling the filter off the air inlet inside the machine. Where fitted, the pre-filter pad is removed by sliding the filter frame (2a overleaf) out of the machine then lifting the pad out and replacing it with a new one. Make sure the harder, smoother side of the pad is facing the bottom of the tray. The bag filter can also be removed and replaced at this point if required.

Changing the main filter

- Open the door
- Turn the filter locking handle (4) 180° anti-clockwise so that it is horizontal and in the filter unlocked position
- The filter (2) should drop slightly to allow release
- Remove the filter by sliding it towards you and remove it completely from the machine (Use correct manual lifting techniques - filters can be heavy!)
- Insert the new filter (completely) into the machine ensuring that the airflow arrow on the label (7. overleaf) is pointing up.
- Turn the filter locking handle 180° clockwise so that it is horizontal and in the filter locked position
- Close and lock the door and restart the machine

Notes: The 800i/1500i/2000i 3-tier and 5000i machines have two main filters, always ensure you are replacing the correct one.

FILTRATION & CHANGING FILTERS

200
400

650

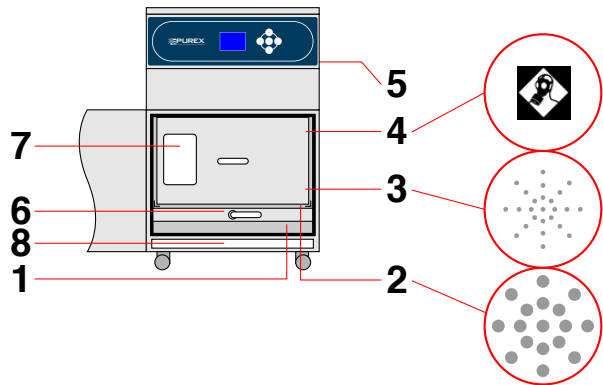

200i
400i

400i
PVC

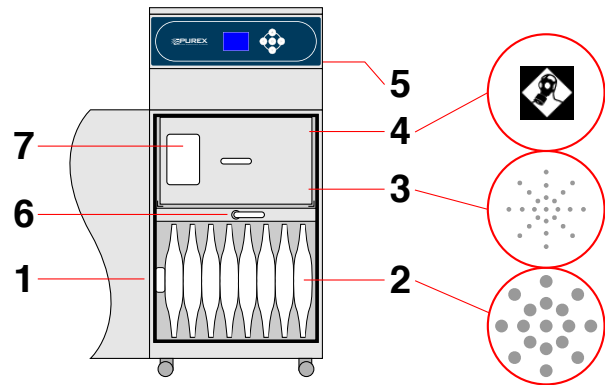

PVC versions include an adsorbent pad under the prefilter.

300i

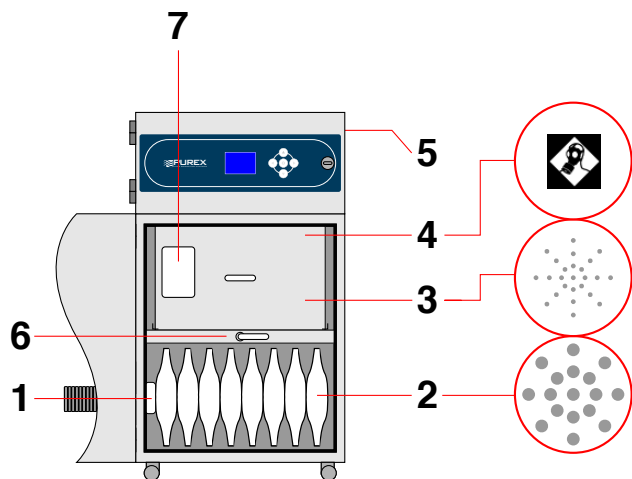

800

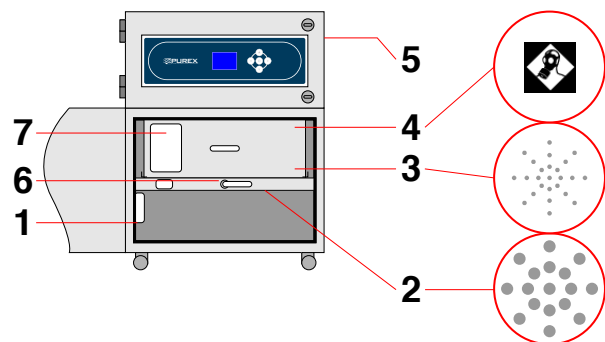

FILTRATION & CHANGING FILTERS

<p>800i</p>	<p>1500 2000</p>
<p>NOTE 800i/1500i/2000i 3-Tier Versions Have 2 x Main Filters as Below</p> <p>A) HEPA filter B) Carbon filter</p>	<p>1500i 2000i</p>
<p>5000i</p> <p>Option 1. Pleated prefilter bag and tray</p> <p>Option 2. Labyrinth prefilter</p>	<p>LEGEND:</p> <ol style="list-style-type: none"> 1) Air inlet. 2) Pre-filter. 3) Main Filter (HEPA location). † 4) Main Filter (Carbon location). † 5) Clean air returned to workplace. 6) Filter locking handle. 7) Filter identification label. 8) Debris tray. (If fitted) <p>All machines are mounted on four castors for increased mobility.</p> <p>† Standard Filters Only, Filter Contents and Positions Can Vary.</p>

CHANGING THE FUSE

If a fuse has to be replaced it is important that this procedure is followed to ensure safe and efficient operation of the Purex unit.

Round Cap

- Ensure the machine is isolated from the mains power supply.
- Remove the blown fuse by unscrewing the fuse holder cap (using a suitable screwdriver) in an anti-clockwise direction and withdraw the spent fuse.
- Check the fuse holder, if there are any signs of damage contact Purex Technical support, if there is no obvious damage continue as follows.
- Fit a replacement fuse, ensuring the type and fuse rating is correct, if in any doubt contact Purex technical support.
- Re-fit the cap to the machine by applying gentle pressure and rotating it in an anti-clockwise direction until the cap is felt to click.
- Using a correctly sized screwdriver, turn the fuse holder cap $1\frac{1}{4}$ full turns (450 degrees) in a clockwise direction.
- If the above procedure is not effective, contact Purex Technical support.

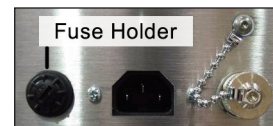

Rectangular Cap

- Ensure the machine is isolated from the mains power supply.
- Remove the blown fuse by prising open the fuse cover which is part of the power socket.
- Check the fuse holder, if there are any signs of damage contact Purex Technical support, if there is no obvious damage continue as follows.
- Fit a replacement fuse, ensuring the type and fuse rating is correct, if in any doubt contact Purex Technical support.
- Close the fuse cover.
- If the fuse holder shows any physical damage or the above procedure is not effective, contact Purex Technical support.

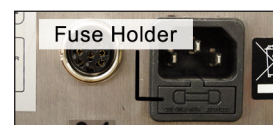

TROUBLESHOOTING

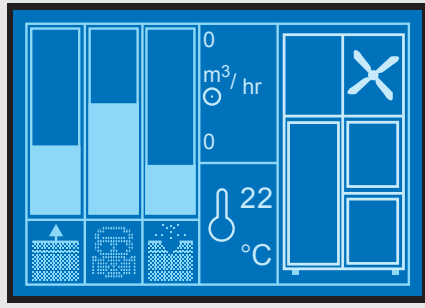





Notes:

Warning status - is an audible chime every 20 seconds and the keypad flashing (red) every 10 seconds. This stage allows the operator time to identify the problem and take appropriate action e.g. acquire a replacement filter.

Alarm status - is an audible chime and the keypad flashing (red) every 1 second. At this point the problem should be identified and remedial action taken immediately.

Filters - Some machines use a single combined HEPA / Chemical filter while others employ separate HEPA and chemical filters. Therefore the machine icons may vary depending on the type of machine you have.

	A nozzle or connecting hose/pipe may have a leak / blockage or the vacuum sensor tubes (if fitted) in the air inlet may be blocked.	Check all nozzles, hose/pipe connections and the vacuum sensor tube (if fitted) for leaks / blockages.
	The pre-filter may be blocked. or... The HEPA/Chemical filter (or separate HEPA filter if appropriate) may be blocked.	Change the pre-filter. or... If the pre-filter has been changed quite recently then change the main HEPA/Chemical filter (or separate HEPA filter if appropriate).
	The HEPA/Chemical filter (or separate chemical filter if appropriate) is missing, not fitted correctly or is damaged.	Check the HEPA/Chemical filter (or separate chemical filter if appropriate) is fitted correctly in the machine, is locked into position correctly and is undamaged.
	The HEPA/Chemical filter (or separate chemical filter if appropriate) may be exhausted.	Replace the HEPA/Chemical filter (or separate chemical filter if appropriate)
	The exhaust monitor unit inside the machine may have developed a fault.	This is a sealed unit. Contact your supplier for a replacement exhaust monitor unit.
	The HEPA/Chemical filter (or separate HEPA filter if appropriate) is missing, not fitted correctly or is damaged.	Check the HEPA/Chemical filter (or separate HEPA filter if appropriate) is fitted correctly in the machine, is locked into position correctly and is undamaged.
	The combined HEPA/Chemical filter (or separate HEPA filter if appropriate) may be exhausted.	Replace the HEPA/Chemical filter (or separate HEPA filter if appropriate)
	The exhaust monitor unit inside the machine may have developed a fault.	This is a sealed unit. Contact your supplier for a replacement exhaust monitor unit.
	The alarm has triggered and the blower stops.	The thermal cutout on the blower may have engaged. Check the cooling vents both inside and out. Switch off mains power and allow the blower to cool. If this does not remedy the fault please contact your supplier.
	Blower does not function	Power supply to blower absent or incorrect. Check all cables and connections and ensure the power supply matches the requirements of the machine. Check all fuses and circuit breakers.
	Control signal to/from interfaced equipment is incorrect or absent.	Check all cables and connections are correct.
	The control PCB inside the machine may have developed a fault.	Check all cables and connections first. Then contact your supplier.

TROUBLESHOOTING

Odour or particles in exhaust air but there is no alert from the machine.	The exhaust monitor unit inside the machine may have developed a fault.	Check all cables and connections first. Then contact your supplier.
Airflow insufficient to remove fume when the filter is not blocked.	Airflow set to low or possible airflow leak or a blockage.	Increase airflow. If problem persists then check all nozzles, hose/pipe connections and the vacuum sensor tube (if fitted) for leaks / blockages.
Control signal to/from interfaced equipment is incorrect. Equipment is not switched on alarm condition.	Electrical problem.	Check all cables and connections and interfaced equipment.
	The exhaust monitor unit inside the machine may have developed a fault.	Check all cables and connections first. Then contact your supplier.
	The control PCB inside the machine may have developed a fault.	Check all cables and connections first. Then contact your supplier.
Buttons and/or graphic display is not illuminated.	Power supply absent or incorrect.	Check all cables and connections and ensure the power supply matches the requirements of the machine.
	Control signal to/from interfaced equipment is incorrect or absent.	Check all cables and connections are correct.
	The control PCB inside the machine may have developed a fault.	Check all cables and connections first. Then contact your supplier.
A filter has a shorter than expected life.	A problem with the pre-filter can cause main filter life to be reduced.	Check the pre-filter which may be damaged or missing.
	The process may have changed or increased in duration. Are different materials being used?	Check if any factors have changed. If the problem persists then contact your supplier.

Note:

Some of these machines incorporate an inverter which connects the control PCB and the power supply to the blower. This inverter and its connections should also be inspected if electrical faults occur.

TERMS & CONDITIONS

1. Contract

1.1 All quotations given, orders accepted and contracts entered into by Purex International Limited ("Purex") with any person ("Purchaser") for supply of goods ("Goods"), or for services ("Services") are subject to these conditions of sale ("Conditions"). All other terms and conditions, whether expressly stipulated by the Purchaser or implied by trade custom, course of dealing or otherwise are excluded. No variation to these Conditions will be effective unless agreed in writing by an authorised representative of Purex.

1.2 No quotation, estimate or proposal issued by Purex is an offer that is capable of acceptance by the Purchaser. Any order issued by the Purchaser shall be deemed placed subject to these Conditions and shall constitute an offer that Purex may accept or reject. The contract between Purex and the Purchaser ("Contract") shall be formed at the time Purex accepts the Purchaser's order. Purex may accept the Purchaser's order by issuing an order acknowledgement or by other means, including commencing the supply of Goods or the performance of Services. No amendments to the Purchaser's order shall be valid unless agreed in writing by an authorised representative of Purex.

2. Order and Specifications

The Purchaser shall be responsible to Purex for ensuring the accuracy of the terms of any order, including any applicable specification, submitted by the Purchaser, and for giving to Purex any necessary information relating to the Goods or Services within a sufficient time to enable Purex to perform the Contract in accordance with its terms. The specification for the Goods or Services shall be that set out in the Purchaser's order or as otherwise agreed in writing by Purex. Should an order be cancelled by the Purchaser within 2 months of the relevant delivery date Purex reserves the right to impose a reasonable cancellation charge.

3. Price and Payment

3.1 The price of Goods and Services shall be the price quoted by Purex. Quoted prices shall remain valid for 30 days. Prices do not include carriage and packing which will be charged at cost plus a handling fee unless otherwise specified in writing. Express or Special Delivery at the Purchaser's request will always be at the Purchaser's expense. Prices do not include VAT.

3.2 Unless otherwise agreed in writing payment of invoices shall be made in full without any deduction or set-off within 30 days of the invoice date. Payment shall be due whether or not property in the Goods has passed. Time for payment shall be of the essence. If the Purchaser fails to pay Purex any sum due pursuant to the Contract, the Purchaser shall be liable to pay interest to Purex on such sum from the due date for payment at the annual rate of 4% above the base lending rate from time to time of The Bank of England, accruing on a daily basis until payment is made, whether before or after any judgement. Purex reserves the right to claim interest under the Late Payment of Commercial Debts (Interest) Act 1998. Purex may also, without prejudice to any other remedy suspend or cancel further supply of Goods or performance of Services whether under this or any other Contract until the Purchaser makes payment in full together with any applicable interest.

4. Delivery

4.1 Delivery of the Goods shall unless otherwise agreed be made by Purex delivering the Goods to the location specified in the Purchaser's order or by the Purchaser collecting the Goods at Purex's premises.

4.2 Any dates or times for delivery of Goods and performance of the Services are approximate only. Purex shall use reasonable endeavours to meet such dates or times but so long as it uses such reasonable endeavours Purex shall not be liable to the Purchaser, in contract, tort, negligence or otherwise for any loss or damage whatsoever resulting from any late delivery or performance.

4.3 Where the Goods are delivered by instalments, any breach by Purex in respect of any one or more instalments shall not entitle the Purchaser to terminate the Contract in whole or in part.

4.4 Upon receipt of the Goods the Purchaser shall examine them and shall within 48 hours of such receipt give notice in writing to Purex of any apparent defects and/or shortages. The parties will agree between themselves such further action as may be necessary to remedy the defect and/or shortage. Purex shall not be liable for any such defects and/or shortages notified to it after the period of 48 hours after receipt.

5. Risk and Title

5.1 Risk of damage to or loss of the Goods shall pass to the Purchaser when Purex delivers the Goods to the Purchaser or, if the Purchaser collects the Goods from Purex, when the Goods are loaded onto transport at Purex's premises.

5.2 Notwithstanding the passing of the risk, Purex shall retain title to and ownership of the Goods until it has received payment in full of all sums due for the Goods.

5.3 Until title in the Goods has passed to the Purchaser, the Purchaser shall be in possession of them as a bailee of the Goods for Purex and shall store the Goods, properly insured and protected, separately from any Goods belonging to the Purchaser or any third party and shall be clearly marked and identifiable as being Purex's property. Purex shall be entitled to enter the Purchaser's premises upon reasonable notice to verify the Purchaser's compliance with this clause. If the Purchaser fails to make any payments to Purex when due, or any of the circumstances set out in Clause 8.2 arise, then Purex will have the right, without prejudice to any other remedies:

5.3.1 to enter, without prior notice, any premises where Goods owned by Purex may be, and to repossess and dispose of any such Goods; and/or

5.3.2 to require the Purchaser not to resell or part with possession of any Goods owned by Purex until the Purchaser has paid in full all sums due to Purex under this or any other Contract.

5.4 The Purchaser shall not be entitled to pledge or in any way charge by way of security for any indebtedness any of the Goods which remain the property of Purex and if the Purchaser does so all monies owing by the Purchaser to Purex shall (without prejudice to any other right or remedy of Purex) forthwith become due and payable.

6. Warranty & Liability

6.1 Goods manufactured by Purex : Purex warrants that the Goods manufactured by it will be free from defects in materials and workmanship for a period of 12 months from the date of installation or 15 months from the date of despatch from Purex's premises, whichever period expires earlier. Exceptions :

Spare parts including replacement filters : 3 months from installation or 4 months from despatch

Used and ex-demonstration equipment: 3 months from installation or 4 months from despatch

In the case of any breach of warranty then Purex shall at its option remedy such defects or refund such sums as the Purchaser has paid to Purex in respect of such Goods. Purex shall be under no liability under the above warranties:

6.1.1 arising from any drawing, design or specification supplied by the Purchaser;

6.1.2 arising from improper installation, storage, use, modification or operation including but not limited to the use of consumable items not approved by Purex;

6.2 Goods manufactured by third parties : Purex will use its best endeavours to obtain for the purchaser the benefit of any warranty provided by the original manufacturer of the Goods. Repair or replacement, in whole or in part, of Goods which fail due to faulty manufacture is available from the original manufacturer under its warranty. Purex must be consulted to approve the return of Goods for replacement or repair under the original manufacturer's warranty.

6.3 All replacement items will be charged at the point of despatch. Provided the original items are received back at Purex within 28 days from the date upon which the Returns Authorisation Number is issued and Purex agree following testing / inspection that these are defective, a credit note will be issued.

6.4 Services : Purex warrants that it will carry out the Services with reasonable care and skill. If Purex is shown to be in breach of this warranty in respect of particular Services it shall at its option and cost either re-provide those Services or refund any sums already paid in respect of those Services.

6.5 Purex does not exclude or limit its liability in negligence for death or personal injury, or for fraud or wilful default, or otherwise to the extent that any exclusion or limitation of its liability is void, prohibited or unenforceable by law.

6.6 Subject to Clauses 6.1 - 6.5, all representations, warranties and conditions implied by trade custom, course of dealing, statute, common law or otherwise are excluded to the fullest extent permitted by law.

6.7 Subject to Clause 6.5, in no circumstances shall Purex be liable to the Purchaser, in contract, tort, negligence or otherwise, for any incidental or consequential loss including, without limitation, any loss of profit, business, revenue, goodwill or anticipated savings or for any special, exemplary or consequential damages or other financial loss whatsoever arising out of or in connection with the Contract or the supply of the Goods or Services or their use or resale (if applicable) by the Purchaser.

6.8 If notwithstanding the provisions of these Conditions Purex is found liable for any loss suffered by the Purchaser arising in any way out of or in connection with the Contract or the supply of any Goods or Services, that liability shall in no event exceed the price paid for such Goods or Services.

6.9 The parties hereby confirm that notwithstanding any other provision of the Contract or these Conditions, the Contract shall not and shall not purport to confer on any third party the right to enforce any term of the Contract for the purposes of the Contracts (Rights of Third Parties) Act 1999.

6.10 Purex and third party Software

6.10.1 Software is licensed (or sublicensed, in case of third party Software) by Purex to the Purchaser.

6.10.2 Purex warrants that the media on which the Software is recorded is free from defects in material and workmanship under normal use for a period of thirty days from the date of despatch.

6.10.3 Purex warrants that any Purex Software will perform in substantial compliance with the specification for a period of 90 days from installation.

6.10.4 Purex warrants that any third party Software will perform in substantial compliance with the Software documentation issued by the original manufacturer of the Software and for the period specified therein.

6.10.5 Purex (and, where applicable, the original manufacturer of the Software) do not warrant that the functions contained in the Software will meet Purchaser's requirements or operate in the combination that may be selected for use by Purchaser, that the operation of the Software will be uninterrupted or error-free or that all defects in the Software will be corrected.

6.10.6 The entire liability of Purex (and, where applicable, of the original manufacturer of the Software) shall be, at Purex's option, either :

(a) Return of all sums paid by the Purchaser for the Software, or

(b) Replacement of the Software or media that does not meet Purex or the original manufacturer limited warranty and which is returned to Purex under its return policy.

6.10.7 Any replacement Software or media will be warranted for the remainder of the original warranty period or 30 days, whichever is longer.

7. Force Majeure

Purex shall not be deemed in breach of the Contract or otherwise liable to the Purchaser, by reason of any delay in performance, or non-performance of its obligations under the Contract to the extent that such delay or non-performance is caused by an event or circumstance beyond Purex's reasonable control. In such events Purex, without liability to the Customer, reasonably vary the terms of the Contract including but not limited to extending the time for performing the contract by a period of at least equal to the time lost due to such an event.

8. Termination

8.1 Purex may at any time by notice in writing to the Purchaser terminate the Contract with effect from the date of service of such notice if:

8.1.1 The Purchaser commits a material breach of the Contract and fails to remedy such breach within 14 days after Purex has given written notice to the Purchaser identifying the breach and requiring it to be remedied; or

8.1.2 The Purchaser is unable to pay its debts as they fall due within the meaning of Section 123 of the Insolvency Act 1986 or if any petition is presented for the appointment of an administrator or receiver or trustee in bankruptcy in respect of the Purchaser or any part of its undertaking or assets or an administrative receiver is appointed in respect of any of the Purchaser's undertaking or assets or if the Purchaser makes or attempts to make any arrangement with or for the benefit of its creditors or if the Purchaser ceases or threatens to cease to carry on business.

9. Miscellaneous

9.1 The expressions "in writing" and "written" include fax transmission. Purex shall be entitled to sub-contract any or all of its obligations under the Contract and to assign the Contract and the Customer shall at Purex's cost do all such things as may be necessary to enable Purex to so assign the Contract. Any failure or neglect by Purex to enforce at any time any provision of the Contract shall not be construed nor deemed to be a waiver of any of Purex's rights under the Contract. The Contract shall be governed by and construed in accordance with English law and the parties hereby submit to the exclusive jurisdiction of the English courts in relation to any claim or controversy arising out of or connected with the Contract.

9.2 New Accounts : Credit accounts cannot be opened under the minimum amount in operation at the time of placing the order. Customer's wishing to open a credit account must furnish two trade references and a Bank reference.

9.3 Specification Alterations : Purex reserves the right to alter the specification of any goods without prior reference to the Purchaser provided that the goods comply in all other known respects with the Purchaser's requirements.

9.4 Trade-Marks / Patents : The supply of goods by Purex shall not confer any right upon the Purchaser to use any Purex trade-mark without prior written consent of Purex and at all times such trade-mark shall remain the property of Purex. Neither does it imply any right to use any Purex patent or any indemnity against infringement of third party patents.

9.5 Catalogues : Catalogues and other advertising matter are issued to indicate the type and range of goods we offer and no particulars therein are binding to Purex.

LEV LOGBOOK

TO ENSURE THE CONTINUED PERFORMANCE OF YOUR PUREX LEV EQUIPMENT, THE FOLLOWING DAILY, WEEKLY AND MONTHLY CHECKS SHOULD BE CARRIED OUT. THE FORM BELOW CAN BE PHOTOCOPIED FOR YOUR RECORDS. CONTACT PUREX OR YOUR LOCAL SUPPLIER FOR ANNUAL MAINTENANCE.

LEV Serial Number: _____ Model Number: _____
 Location: _____ Week Number: _____
 Year: _____

Instructions: The operator should check the LEV systems at the suggested frequency, put a tick in the relevant box if OK or put an "X" in the box if not OK. Then initial the column. Write details of problems and how they have been resolved in the boxes at the bottom of the sheet.

	S	M	T	W	T	F	S	S	M	T	W	T	F	S	S	M	T	W	T	F	S	S	M	T	W	T	F	S	
Daily check list where applicable																													
Airflow indicator effective if fitted																													
LEV on when process is in use																													
Extraction capturing all dust/fume																													
No unusual noise/vibration/odour																													
No draughts affecting airflow																													
Waste collection not overfull																													
Area clean and tidy																													
Checked by initials																													
Weekly check list where applicable																													
Filters in good condition																													
Access not obstructed																													
Flexible hose condition																													
Ducting & hood condition																													
Dampers operate freely																													
Visible electrical cable check OK																													
Monthly check list where applicable																													
LEV inspection label within date																													
Date filter changed																													

General housekeeping:- All spillages must be immediately removed by a suitable vacuum, not by sweeping, dusting or using an airline. A regular cleaning regime should be employed.

Record details of any problem reported to management for action/advice. Enter date, problem details, name of reporting person, name of person reported to:

Date	Details	Reported to:





Purex International Ltd.

QWP House
Capitol Park, Thorne
Doncaster
South Yorkshire
DN8 5TX
UK

T: +44 (0)1405 746 030

F: +44 (0)1405 746 047

E: purex@purex.co.uk

W: www.purex.co.uk

Purex Incorporated

2246 Palmer Drive
Unit 108, Schaumburg
Illinois 60173
United States

T: +1847 348 5203

W: www.purexinc.com



Registered Office. Purex International Ltd. QWP House, Capitol Park, Thorne, Doncaster, DN8 5TX. Registered No. 5136616 England.
VAT No. GB842 5025 49 | WEEE Producer Registration Number: WEE/CE0067TX