



PUREX

FUME EXTRACTION SYSTEMS

Brochure 01/13



*“Protecting People
and the Environment
with Innovative Technology”*

Introduction

Purex offers an extensive range of fume extraction solutions. These range from machines to protect a single person to powerful centralised systems to cater for multiple users or high volume continuous automated processes (e.g. a PCB production line).

Purex has the experience, products and support infrastructure to help ensure that:

- The correct machine is specified first time.
- The process performs at the optimum level.
- Employees are protected from hazardous fumes.
- The company complies with health & safety legislation
- Product quality is maintained
- Process machinery is protected from dust and fumes.
- Contaminated air is filtered, not pumped into the environment.

APPLICATIONS

- Laser Coding and Marking
- Continuous Ink Jet Coding and Marking
- Laser Engraving
- Wide Format Printing
- Dye Sublimation
- Reflow & Wave Soldering
- Manual Soldering
- Laser & Robotic Soldering
- Underfill & Conformal Coating
- Cleanrooms & Laboratories
- Education & Engineering

Protecting

NEW....

FumeCube Max

- Ideal for dusty applications & lead free solder.
- Can be used with small lasers, in dentistry, in jewellery making and many other applications.
- Uses patented filter technology.



NEW....

Tip Extraction Kits

- Individual kits to fit tip extraction onto popular models of soldering iron.
- Prevents tip cooling.
- Simple to install and comfortable to use.

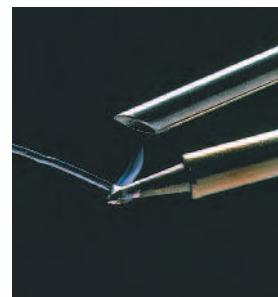

NEW....

Large Diameter Arms

- Ideal for applications requiring high airflow.
- Can be attached to a Purex extractor to give mobility.
- Fully adjustable.



NEW....

- 113669 filter for Acidic Vapours such as HCN or for engraving ABF plastic.
- 200316 high performance F8/F9 pre-filter pad for FumeCubes.
- 125mm connection kits for conformal coating and other systems.
- Parts and Spares information for easy reference.

People and the Environment with Innovative Technology

Health & Safety Legislation

Local and international health and safety legislation (such as COSHH, NIOSHH, OSHA etc) states that it is the employers responsibility to protect the health, welfare and safety of their employees. Failure to do so can result in expensive legal action, potential fines and poor employee relations.

The Need for Fume Extraction

Many types of dust and fume are hazardous to health if inhaled. People can become permanently sensitised to fumes which means that continued exposure, even to very small amounts of fume, may cause asthma attacks or other respiratory diseases. A high performance fume extraction system will help to:-

- Protect employee health.
- Ensure compliance with Health & Safety regulations such as **OSHA, NIOSH C.O.S.H.H, MAK, AFNOR and HSG258** or equivalent.
- Increase production speeds.
- Reduce complaints by operators due to odours, dust and vapours.

- Avoid the possible cost of health compensation claims.
- Reduce the cost & time to clean laser lenses, conveyors, guarding, soldering machines and other equipment.
- Reduce product contamination.
- Provide a better working environment.
- Reduce downtime.

Which Extraction System?

There are usually two types of extraction system available:-

- External - pump contaminated air outside
- Internal - at source capture and filtration or LEV (local exhaust ventilation) system

In our opinion the best system to use is an LEV system such as a Purex. These capture fumes at the source thereby preventing fumes escaping into the workplace. They also filter hazardous particles and gasses which would otherwise be pumped into the outside environment causing pollution.

Using an internal filter system also avoids issues with environmental regulations and potential complaints from neighbouring businesses about fumes and odours.

Purex LEV systems sit next to the process and the extraction rate can be altered precisely to suit the application. Purex machines are also easy to move if the process moves.

LEV systems have additional benefits over external exhaust systems.

See comparison table below...

“Purex LEV engineers are qualified to BOHS P601 or P602”



COMPARISON: Exhaust into the Environment System “vs” Purex LEV System...

Comparison Question	Exhausting into the Environment	Purex LEV System
How long will it take to install the system?	Several days on average.	In many cases just minutes.
Will there be any disruption in the workplace?	Scaffold, ladders etc. may be required in several places, disrupting work for lengthy periods.	Minor, if any.
Can the system be moved?	Only with scaffold etc. and disruption to work.	Yes. Simply disconnect and push to new location.
Are holes in the building required?	Yes. They need to be specially cut and sealed.	No.
Are external emissions regulations a problem?	Company must investigate and obey local laws.	Not applicable.
Is there any energy lost e.g. heating costs?	Energy (and therefore money) is wasted when heated or conditioned air is pumped outside.	No energy or heat is lost as the air is recycled. So costs are lowered.
Are there any ducting / installation costs?	Potentially expensive - as ducting needs to be purchased and specialist installation is required.	Minimal if any, depending on process.
Are there any cleaning costs?	Specialist cleaning required to prevent risk of fire or contamination. Again, scaffold, disruption & cost.	One annual service is recommended to comply with regulations such as COSHH.
Are there any decontamination costs?	Specialist decontamination may be required.	None.
Can fumes be drawn back into the workplace?	Yes. Through windows or vents.	Fumes are captured by highly efficient filters
Could there be disputes with my neighbours?	Yes. Over hazardous fumes and odours.	Not applicable.



Fume Extractor Selector Guide

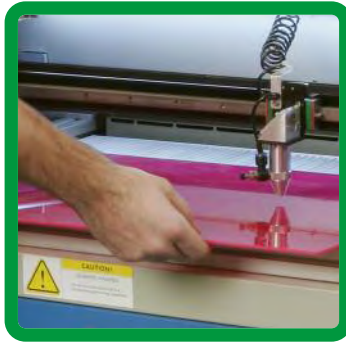
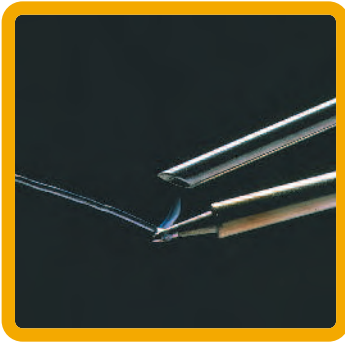

SOLDERING & ELECTRONICS MANUFACTURING

Machine	Arm Extraction, Cabinets & Cows				Tip Extraction	Reflow	Wave
	Max No. Arms 38mm	Max No. Arms 100mm	Max No. Cleancabs	Max No. Cows	Max No. Soldering Iron Tips	Oven Extract Volume Required m³/hr	Oven Extract Volume Required m³/hr
FumeCube (inc MAX)	1 or 2	-	-	1 or 2	1*	-	-
FumeBuster	-	-	1 or 2	1 or 2	-	-	-
FumeSafe	-	-	-	-	3 up to 15	-	-
2tiP	-	-	-	-	1 or 2	-	-
200	3	1	1	2	up to 30	-	-
400	6	1	1-2	4	-	-	-
200i	3	1	1	2	up to 30	-	-
200i-HP	-	-	-	-	up to 50	-	-
400i	6	1	1-2	4	-	-	-
800i	9	2	2-4	6	-	-	-
1500i	12	5	4-8	8	-	Below 900	-
2000i	15	5	6-12	10	-	Below 1500	Below 1500
5000i	36	10	12-24	20	-	Over 1500	Over 1500

Notes:

- The selection is based on the use of a standard connection kit.
- A larger extraction machine may be required depending on the layout and the type of fume or dust.
- * Selective soldering machines only, not suitable for handheld tip extraction.
- Continuous use may require a machine with larger filtration capacity.
- In some cases more arms/cows can be used e.g. for non coalescing vapours such as solvents or where airflow valves can be opened and closed.

IMPORTANT: Choose a vacuum control machine for Arm and Tip extraction and a volume control machine for other applications. We also have solutions for conformal coating, selective soldering, vapour phase and more, please contact us for more information.

LASER ENGRAVING

Size of Laser Engraving Machine		Alpha 200	Alpha 400	Xbase 200	Xbase 400	400i	800i	800i 2-Tier (High Dust)	1500i 3-Tier (Acrylic)	2000i	5000i
Light Use	Heavy Use*										
Small		●	■	●	■	-	-	▲	-	-	-
	Small	x	●	x	●	-	-	▲	-	-	-
Medium		x	x	x	x	●	■	▲	-	-	-
	Medium	x	x	x	x	x	●	▲	■	-	-
Large		x	x	x	x	x	x	▲	●	■	-
	Large	x	x	x	x	x	x	▲	-	●	■
Extra large open bed lasers		x	x	x	x	x	x	x	x	●	■

Approximate laser bed sizes:

Small - 16"x12", Medium - 24"x12", Large - Anything over this.

- Normal selection.
- Select if extra filter capacity is required and/or additional airflow is required to extract from multiple lasers or heavy duty applications.
- (-) May also be considered.
- x Unit not usually specified for application.
- ▲ Consider if continually lasing acrylic.

Notes: Always select a volume control machine.

- The selection is based on the use of standard connection kit.
- * Heavy use includes high proportion of cutting, lasers with a deep bed and constant use. Contact Purex for further advice.
- The 800i 3 tier unit is designed for use where the application has low dust, but high gas emissions. The 2 tier is designed for applications producing high dust emissions.
- In applications with extremely high dust emissions, a Cascade inline filter can be considered.



Fume Extractor Selector Guide

CODING & MARKING

Laser Coding & Marking

CPM (Codes per Minute)		FumeCube MAX*	200i	400i	800i 2-Tier (High Dust)	800i 3-Tier (High Gas)	1500i	2000i	5000i
Good Enclosure	Poor Enclosure								
<200		●	●	■	-	-	-	-	-
	<200	x	x	●	■	-	-	-	-
200-500		x	x	●	■	-	-	-	-
	200-500	x	x	x	●	■	-	-	-
>500		x	x	x	●	■	-	-	-
	>500	x	x	x	x	x	●	■	-
Machines for Lasing PVC		x	x	▲	▲	▲	▲	▲	▲

● Normal selection.

■ Select if extra filter capacity is required and/or additional airflow is required to extract from multiple lasers or heavy duty applications.

(-) May also be considered.

x Unit not usually specified for application.

▲ Optional "PVC" machines should be used when lasing onto PVC.

* For low wattage lasers or occasional use.

Notes: Always select a volume control machine.

1. The selection is based on the use of a standard connection kit.
2. The 800i 3 tier unit is designed for use where the application has low dust, but high gas emissions. The 2 tier is designed for applications producing high dust emissions.
3. A poor enclosure is where less than 4 sides of the process are enclosed.

Continuous Inkjet Coding & Marking

Small Character Inkjet Printers	200	400	800i
See Notes	●	■	■

● Normal selection.

■ Select if additional airflow is required to extract from multiple inkjet heads or if the controller unit has cooling fans installed.

Notes: Always select a volume control machine.

There are many different makes and models of inkjet printers available. Please contact Purex or your local representative for advice on which model is correct for particular applications.

IMPORTANT:

- This is a guide only, many factors influence the choice of fume extraction system. For more help and information please contact Purex or your local representative
- Purex recommends the use of anti static hose with continuous inkjet printers.

WIDE FORMAT PRINTING

Printer Model	Machine Part No.		Machine Type	Connection Kit	Fittings	Manifold	Main Filter	Pre-Filter	
	230V	120V							
Mimaki	JV33-130SP	080703	080702	CaptivairMAX	120309	120311	120313	113800 x 2	-
	JV33-160SP	080703	080702	CaptivairMAX	120309	120312	120313	113800 x 2	-
Roland	AdvancedJet AJ-740	0LX4000D	0LX4001D	400	120188	120299	-	113508	202260
	VersaUV LEC-300	0AL4102	0AL4103	Alpha 400	100019	120090	-	113508	202269
	VersaUV LEC-330	0AL4102	0AL4103	Alpha 400	100019	120089	-	113508	202269
Seiko	ColorPainter H-74s	080703	080702	CaptivairMAX	120303	120314	120322	113800 x 2	-
	ColorPainter H-104s	080703	080702	CaptivairMAX	120303	120314	120322	113800 x 2	-
	ColorPainter V-64s	0LX4000D	0LX4001D	400	120297	120323 x 2	-	113508	202260

Contact Purex or your local distributor for more information.

OTHER APPLICATIONS

Dye Sublimation • Laser & Robotic Soldering • Underfill & Conformal Coating • Cleanrooms & Laboratories • Education & Engineering
Dentistry • Medical • Welding • Adhesives • Solvents • and more... contact us for more information.



Index

Information		Accessories	
Introduction	2-3	Connection Kits	26-28
Fume Extraction Selector	4-5	Pipe & Duct	29
Solder Fume	4	Arms & Accessories	30-31
Laser Engraving	4	CleanCabs	31
Coding & Marking	5	Tip Extraction Kits	32-33
Printing	5	Interfacing Cables	34
Index	6	Plug Leads	35
		Replacement Parts	36
Digital Machines		Appendix	
200 & 400	8	Options	37
200i & 400i	9	Pre Filters	38
400i PVC	10	Main Filters	39
800i	11	Digital Control System	40-41
1500i & 2000i	12	Terms & Conditions	42
5000i	13	Filter Matrix	43
Analogue Machines			
Alpha & Alpha Dust	16		
Xbase	17		
FumeCube - Std & Max	18-19		
FumeSafe	20		
2tiP	21		
FumeBuster	22		
Captivair	23		
Cascade Inline Filters	24		



Digital Systems



200 & 400

What to specify...

1. Model

2. Voltage

3. Volume or Vacuum

4. Pre-filter

5. Main filter

6. Connection Kit

7. Interfacing Kit

	200		400	
1				
2				
3				
Voltage	230V ±10%	120V ±10%	230V ±10%	120V ±10%
Volume Control	0LX2100D	0LX2101D	0LX4000D	0LX4001D
Vacuum Control	080026D	081026D	080410D	080411D
Wattage	0.46 kW	0.47 kW	1.30 kW	1.37 kW
Frequency	50Hz / 60 Hz	50Hz / 60 Hz	50Hz / 60 Hz	50Hz / 60 Hz
Cabinet height (inc castors)	710 mm	710 mm	710 mm	710 mm
Cabinet width (not inc hose)	445 mm	445 mm	445 mm	445 mm
Cabinet depth (not inc hose)	528 mm	528 mm	528 mm	528 mm
Cabinet weight	50 Kg	50 Kg	50 Kg	50 Kg
Construction	Precision engineered brushed stainless steel units. High performance continuous run brushless motors. Mounted on castors for mobility.			

4

Pre-filter Pad

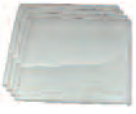

Options: F5 Pack of 4 Code: 202260

5

Main filter



Options:	Code:	Options:	Code:
HEPA/Chemical (std)	113505	Chemical	113508
HEPA/Twin Chemical	113579	Chemical Special	113662
HEPA/Chemical Cleanroom	113512	Chemical (Acidic Fumes)	113505P
HEPA/Chemical (Hydrophobic)	113505H	Pleated Bag	113531
HEPA	113809	Solvent Lock*	113513

* IMPORTANT!
Must be specified for CIJ printing applications.



Air Compressor Available For This Model

Optional Clean Air Cowl - 190040

6

Connection Hose Kit

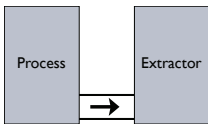

PAGE 26-28

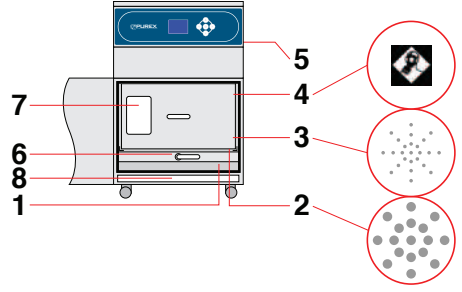

Legend:

- 1) Air inlet - 80mm safe seal.
- 2) Pre-filter.
- 3) Main Filter (HEPA location). †
- 4) Main Filter (Carbon location). †
- 5) Clean air returned to workplace.
- 6) Filter locking handle.
- 7) Filter identification label.
- 8) Debris tray.

All machines are mounted on four castors for increased mobility.

† Standard Filter Only

7

Machine Interfacing (Optional)

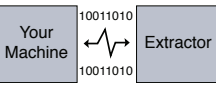

Allows the Purex system to interface with a piece of equipment connected to it.

- **Start/Stop Control:** Extraction unit starts/stops when a connected piece of equipment is switched ON/OFF.
- **Filter Blocked Warning:** A signal is sent to a connected piece of equipment to trigger an alert or to shut it down.
- **Remote ON/OFF Switch:** 5M cable & switch

See PAGE 34

Digital Control System

A dedicated control, monitoring and display system unique to Purex fume extractors. All functions are fully automatic, all the user has to do is set the appropriate airflow on installation. The features of this system are designed to:

- Lower energy consumption by using variable speed motors and automatic flow control.
- Increase filter life by using the optimal extraction rate.
- Further protect people by constantly monitoring exhaust emissions.
- Interface with other equipment e.g. a laser.
- Maintain a constant extraction rate to prevent fume escape or damage to equipment.

System Features...

- Automatic electronic flow control - maintains a constant extraction rate even as the filter blocks
- Adjustable airflow
- Clear and informative graphic display
- Gas and Particle Sensors on the exhaust
- Low capital and running costs
- Quick change pre-filters deliver longer filter life
- Submicronic (HEPA) filtration removes 99.997% of particles down to 0.3 microns
- Activated carbon filtration removes harmful gas
- Simple to install and quiet in operation
- Easy to relocate
- Precision made from stainless steel

Includes:

- 1 x Main filter
- 4 x Pre-filter pads
- 1 x Connection Kit
- 1 x Power cable

Accessories

Please see the accessories section at the back of this brochure.



200i & 400i

What to specify... 1. Model 2. Voltage 3. Volume or Vacuum 4. Pre-filter 5. Main filter 6. Connection Kit 7. Interfacing Kit

1	2	3	200i	200i-HP	400i
Voltage	230V ±10%	120V ±10%	230V ±10%	230V ±10%	120V ±10%
Volume Control	0LX2110D	0LX2121D	-	0LX4010D	0LX4013D
Vacuum Control	080026iD	081026iD	080050iD	080410iD	080411iD
Wattage	0.46 kW	0.47 kW	1.30 kW	1.30 kW	1.37 kW
Frequency	50Hz / 60 Hz	50Hz / 60 Hz	50Hz / 60 Hz	50Hz / 60 Hz	50Hz / 60 Hz
Cabinet height (inc castors)	1070 mm	1070 mm	1070 mm	1070 mm	1070 mm
Cabinet width (not inc hose)	465 mm	465 mm	465 mm	465 mm	465 mm
Cabinet depth (not inc hose)	528 mm	528 mm	528 mm	528 mm	528 mm
Cabinet weight	60 Kg	60 Kg	60 Kg	60 Kg	60 Kg
Construction	Precision engineered brushed stainless steel units. High performance continuous run brushless motors. Mounted on castors for mobility.				

4 Labyrinth Pre-filter



Options: (Pack of 2): Code:
 F6 (std) 202268
 F8/F9 Composite 202271

5 Main filter



Options:	Code:	Options:	Code:
HEPA/Chemical (std)	113505	HEPA/Chemical (Hydrophobic)	113505H
HEPA+/Chemical (200i-HP)*	113811	Chemical Special	113662
HEPA/Twin Chemical	113579	Chemical (Acidic Fumes)	113505P
or HEPA/Twin Chemical	113669	Pleated Bag	113531
HEPA/Chemical Cleanroom*	113512	HEPA	113809
Chemical	113508	* Use in combination with 202271	



Optional Clean Air Cowl - 190040

Air Compressor Available For This Model

6 Connection Hose Kit

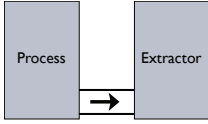

PAGE 26-28

7 Machine Interfacing (Optional)

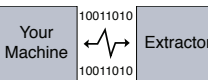

Allows the Purex system to interface with a piece of equipment connected to it.

- Start/Stop Control:** Extraction unit starts/stops when a connected piece of equipment is switched ON/OFF.
- Filter Blocked Warning:** A signal is sent to a connected piece of equipment to trigger an alert or to shut it down.
- Remote ON/OFF Switch:** 5M cable & switch

See PAGE 34

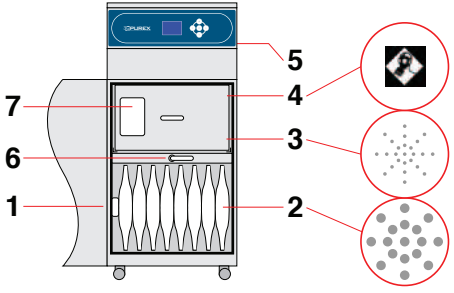

Legend:

- 1) Air inlet - 80mm safe seal.
- 2) Pre-filter.
- 3) Main Filter (HEPA location). †
- 4) Main Filter (Carbon location). †
- 5) Clean air returned to workplace.
- 6) Filter locking handle.
- 7) Filter identification label.

All machines are mounted on four castors for increased mobility.

† Standard Filter Only

Digital Control System

A dedicated control, monitoring and display system unique to Purex fume extractors. All functions are fully automatic, all the user has to do is set the appropriate airflow on installation. The features of this system are designed to:

- Lower energy consumption by using variable speed motors and automatic flow control.
- Increase filter life by using the optimal extraction rate.
- Further protect people by constantly monitoring exhaust emissions.
- Interface with other equipment e.g. a laser.
- Maintain a constant extraction rate to prevent fume escape or damage to equipment.

System Features...

- Automatic electronic flow control - maintains a constant extraction rate even as the filter blocks
- Adjustable airflow
- Clear and informative graphic display
- Gas and Particle Sensors on the exhaust
- Low capital and running costs
- Quick change patented Labyrinth pre-filters deliver longer filter life
- Submicronic (HEPA) filtration removes 99.997% of particles down to 0.3 microns
- Activated carbon filtration removes harmful gas
- Simple to install and quiet in operation
- Easy to relocate and precision made from stainless steel

Includes:

- 1 x Main filter
- 2 x Labyrinth Pre-filters
- 1 x Connection Kit
- 1 x Power cable

Accessories

Please see the accessories section at the back of this brochure.



400i PVC

What to specify...

1. Model

2. Voltage

3. Pre-filter

4. Main filter

5. Connection Kit

6. Interfacing Kit

400i PVC		
1	2	
Voltage	230V ±10%	120V ±10%
Volume Control	0PV4010D	0PV4013D
Wattage	1.30 kW	1.37 kW
Frequency	50Hz / 60 Hz	50Hz / 60 Hz
Cabinet height (inc castors)	1181 mm	1181 mm
Cabinet width (not inc hose)	465 mm	465 mm
Cabinet depth (not inc hose)	528 mm	528 mm
Cabinet weight	70 Kg	70 Kg
Special Construction	<ul style="list-style-type: none"> • High chemical resistance epoxy coating on all inner surfaces, painted onto SSPC-SP6 prepared stainless steel for maximum adhesion of coating. • Polypropylene protective pads and bushings protect the filter mechanisms and epoxy coating from wear. • Corrosion resistant polymer fasteners and caps protect the door hinges and casters. Door catches and grounding wire mounted externally to avoid corrosion. 	

3

Labyrinth Pre-filter



Options:
F8/F9 Composite (Pack of 2)
Chemical Absorbant Pad (Pack of 4)

Code:
202271
200261

Note:
Both Pre-filter and pads are required. The absorbant pad should be replaced when the Labyrinth filter is replaced or sooner if required.

4

Main filter



Options:
HEPA/PVC Chemical (std)

Code:
113498



5

Connection Hose Kit

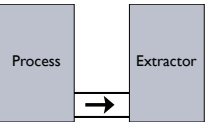

Please choose 100043C connection kit from **PAGE26**

6

Machine Interfacing (Optional)



Allows the Purex system to interface with a piece of equipment connected to it.

- **Start/Stop Control:** Extraction unit starts/stops when a connected piece of equipment is switched ON/OFF.
- **Filter Blocked Warning:** A signal is sent to a connected piece of equipment to trigger an alert or to shut it down.
- **Remote ON/OFF Switch:** 5M cable & switch

See **PAGE 34**

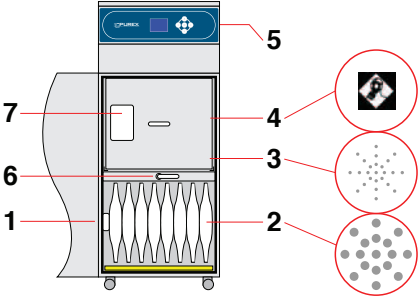

Legend:

- 1) Air inlet - 80mm safe seal.
- 2) Pre-filter.
- 3) Main Filter (HEPA location).
- 4) Main Filter (Carbon location).
- 5) Clean air returned to workplace.
- 6) Filter locking handle.
- 7) Filter identification label.

- All machines are mounted on four castors for increased mobility.
- An absorbant pad is also supplied to fit under the Labyrinth filter

Digital Control System

A dedicated control, monitoring and display system unique to Purex fume extractors. All functions are fully automatic, all the user has to do is set the appropriate airflow on installation. The features of this system are designed to:

- Lower energy consumption by using variable speed motors and automatic flow control.
- Increase filter life by using the optimal extraction rate.
- Further protect people by constantly monitoring exhaust emissions.
- Interface with other equipment e.g. a laser.
- Maintain a constant extraction rate to prevent fume escape or damage to equipment.

System Features...

- Automatic electronic flow control - maintains a constant extraction rate even as the filter blocks
- Adjustable airflow
- Clear and informative graphic display
- Gas and Particle Sensors on the exhaust
- Low capital and running costs
- Quick change patented Labyrinth pre-filters deliver longer filter life
- Submicronic (HEPA) filtration removes 99.997% of particles down to 0.3 microns
- Activated carbon filtration removes harmful gas
- Simple to install and quiet in operation
- Easy to relocate and precision made from stainless steel

Includes:

- 1 x Main filter
- 2 x Labyrinth Pre-filters
- 4 x Absorbant Pads
- 1 x Connection Kit
- 1 x Power cable

Accessories

Please see the accessories section at the back of this brochure.



800i

What to specify...

1. Model

2. Voltage

3. Volume or Vacuum

4. Pre-filter

5. Main filter

6. Connection Kit

7. Interfacing Kit

	800i - 2 Tier		800i - 3 Tier	
1				
2				
3				
Voltage	230V ±10%	120V ±10%	230V ±10%	120V ±10%
Volume Control	080502D	080503D	080501D	080500D
Vacuum Control	080505D	080507D	080504D	080506D
Wattage	2.60 kW	2.74 kW	2.60 kW	2.74 kW
Frequency	50Hz / 60 Hz	50Hz / 60 Hz	50Hz / 60 Hz	50Hz / 60 Hz
Cabinet height (inc castors)	1143 mm	1143 mm	1143 mm	1143 mm
Cabinet width (not inc hose)	571 mm	571 mm	571 mm	571 mm
Cabinet depth (not inc hose)	670 mm	670 mm	670 mm	670 mm
Cabinet weight	80 Kg	80 Kg	90 Kg	90 Kg
Construction	Precision engineered brushed stainless steel units. High performance continuous run brushless motors. Mounted on castors for mobility.			

4 Labyrinth Pre-filter

Options: (Pack of 2) Code: PVC Options: Code:
(2-Tier) F6 (std) 202280 Chemical Absorbant 200262
 F8/9 Composite* 202272 *Use F8/F9 Labyrinth bags for PVC
(3-Tier) F8/9 Composite (std)* 202273





Optional Clean Air Cowl - 190039

PVC Version Available
Air Compressor Available For This Model

5 Main filter

Options: Code: † Use in combination with 202272
(2-Tier) HEPA/Chemical (std) or.. 113652
 HEPA/Twin Chemical or.. 113660
 HEPA/Chemical Cleanroom† 113658
(3-Tier) HEPA (std) and.. 113650 * Must be specified for CIJ printing applications.
 Chemical (std) or.. 113651
 Solvent Lock* 113667



6 Connection Hose Kit (Optional)

PAGE 26-28
For PVC applications please contact us.

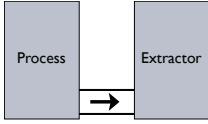
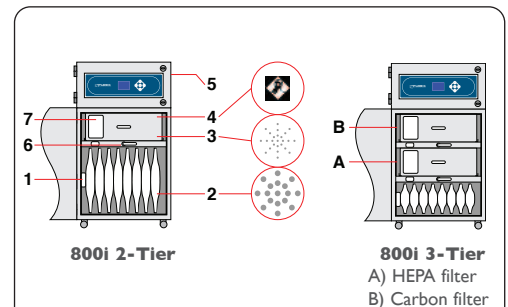



7 Machine Interfacing (Optional)

Allows the Purex system to interface with a piece of equipment connected to it.

- Start/Stop Control:** Extraction unit starts/stops when a connected piece of equipment is switched ON/OFF.
- Filter Blocked Warning:** A signal is sent to a connected piece of equipment to trigger an alert or to shut it down.
- Remote ON/OFF Switch:** 5M cable & switch

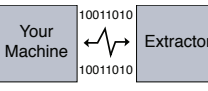
See PAGE 34



Legend:

- 1) Air inlet - 100mm safe seal.
- 2) Pre-filter.
- 3) Main Filter (HEPA location). †
- 4) Main Filter (Carbon location). †
- 5) Clean air returned to workplace.
- 6) Filter locking handle.
- 7) Filter identification label.

All machines are mounted on four castors for increased mobility.
† Standard Filter Only

Digital Control System

A dedicated control, monitoring and display system unique to Purex fume extractors. All functions are fully automatic, all the user has to do is set the appropriate airflow on installation. The features of this system are designed to:

- Lower energy consumption by using variable speed motors and automatic flow control.
- Increase filter life by using the optimal extraction rate.
- Further protect people by constantly monitoring exhaust emissions.
- Interface with other equipment e.g. a laser.
- Maintain a constant extraction rate to prevent fume escape or damage to equipment.

System Features...

- Automatic electronic flow control - maintains a constant extraction rate even as the filter blocks
- Adjustable airflow
- Clear and informative graphic display
- Gas and Particle Sensors on the exhaust
- Low capital and running costs
- Quick change patented Labyrinth pre-filters deliver longer filter life
- Submicronic (HEPA) filtration removes 99.997% of particles down to 0.3 microns
- Activated carbon filtration removes harmful gas
- Simple to install and quiet in operation
- Easy to relocate and precision made from stainless steel

Includes:

- 1 x Main filter (2-tier)
- 2 x Main filters (3-tier)
- 2 x Labyrinth Pre-filters
- 1 x Power cable (no plug)

Accessories

Please see the accessories section at the back of this brochure.



1500i & 2000i

What to specify...

1. Model

2. Voltage

3. Volume or Vacuum

4. Pre-filter

5. Main filter

6. Connection Kit

7. Interfacing Kit

	1500i		2000i	
1				
2				
3				
Voltage	230V ±10%	120V ±10%	400V 3ph + N	220V 3ph
Volume Control	0LX1510D	0LX1511D	0LX2010D	0LX2011D
Vacuum Control	021820iD	021821iD	022120iD	022121iD
Wattage	1.5 kW	1.5 kW	3.0 kW	3.0 kW
Frequency	50Hz / 60 Hz	50Hz / 60 Hz	50Hz / 60 Hz	50Hz / 60 Hz
Cabinet height (inc castors)	1400 mm	1400 mm	1400 mm	1400 mm
Cabinet width (not inc hose)	725 mm	725 mm	725 mm	725 mm
Cabinet depth (not inc hose)	726 mm	726 mm	726 mm	726 mm
Cabinet weight (inc filters)	150 Kg	150 Kg	150 Kg	150 Kg
Construction	Precision engineered brushed stainless steel units. High performance continuous run brushless motors. Mounted on castors for mobility.			

4

Labyrinth Pre-filter

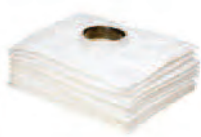

Options:	Code:	PVC Options:	Code:
F6 (std)	111037	Chemical Absorbant Pad (Pack of 4)	200281
F8/F9 Composite*	111099	*Use F8/F9 Labyrinth bags for PVC	



PVC Version Available

Air Compressor Available For This Model

Optional Clean Air Cowl - 640002

5

Main filter



Options:	Code:
HEPA/Chemical (std)	110615
HEPA/Twin Chemical	110614
HEPA/Chemical Cleanroom*	110632
Chemical	110610

* Use in combination with 111099

6

Connection Hose Kit (Optional)

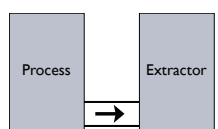

PAGE 26-28
For PVC applications please contact us.

7

Machine Interfacing (Optional)



Allows the Purex system to interface with a piece of equipment connected to it.

- **Start/Stop Control:** Extraction unit starts/stops when a connected piece of equipment is switched ON/OFF.
- **Filter Blocked Warning:** A signal is sent to a connected piece of equipment to trigger an alert or to shut it down.
- **Remote ON/OFF Switch:** 5M cable & switch

See PAGE 34

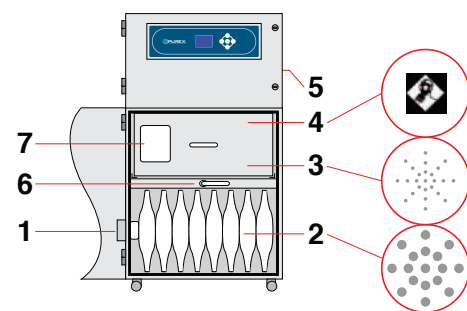

Legend:

- 1) Air inlet - 150mm safe seal.
- 2) Pre-filter.
- 3) Main Filter (HEPA location). †
- 4) Main Filter (Carbon location). †
- 5) Clean air returned to workplace.
- 6) Filter locking handle.
- 7) Filter identification label.

All machines are mounted on four castors for increased mobility.

† Standard Filter Only

Digital Control System

A dedicated control, monitoring and display system unique to Purex fume extractors. All functions are fully automatic, all the user has to do is set the appropriate airflow on installation. The features of this system are designed to:

- Lower energy consumption by using variable speed motors and automatic flow control.
- Increase filter life by using the optimal extraction rate.
- Further protect people by constantly monitoring exhaust emissions.
- Interface with other equipment e.g. a laser.
- Maintain a constant extraction rate to prevent fume escape or damage to equipment.

System Features...

- Automatic electronic flow control - maintains a constant extraction rate even as the filter blocks
- Adjustable airflow
- Clear and informative graphic display
- Gas and Particle Sensors on the exhaust
- Low capital and running costs
- Quick change patented Labyrinth pre-filters deliver longer filter life
- Submicronic (HEPA) filtration removes 99.997% of particles down to 0.3 microns
- Activated carbon filtration removes harmful gas
- Simple to install and quiet in operation
- Easy to relocate and precision made from stainless steel

Includes:

- 1 x Main filter
- 1 x Labyrinth Pre-filter
- 1 x Power cable (no plug)

Accessories

Please see the accessories section at the back of this brochure.



5000i

What to specify...

1. Model

2. Voltage

3. Volume or Vacuum

4. Pre-filter

5. Main filter

6. Connection Kit

7. Interfacing Kit

1	2	3	5000i	
Voltage	400V 3ph + N		220V 3ph	
Volume Control	0LX5550D		0LX5551D	
Vacuum Control	044250D		044251D	
Wattage	7.5 kW		7.5 kW	
Frequency	50Hz / 60 Hz		50Hz / 60 Hz	
Cabinet height (inc castors)	1804 mm		1804 mm	
Cabinet width (not inc hose)	1250 mm		1250mm	
Cabinet depth (not inc hose)	892 mm		892 mm	
Cabinet weight (inc filters)	400 Kg		400 Kg	
Construction	Precision engineered brushed stainless steel units. High performance continuous run brushless motors. Mounted on castors for mobility.			

4	Pre-filter			
	1 - Labyrinth (Side Inlet)			
	Options:	Code:	PVC Options:	Code:
	F8/F9 Composite* Tagged (std) F8	111006 111072	Chemical Absorbant Pad (Pack of 4) *Use F8/F9 Labyrinth bags for PVC	200312
	2 - Pleated Bag (Rear Inlet)			
	Options:	Code:		
	Pre-filter Pad (Pack of 4) and... Pleated Bag Filter	200310 111144		



5	Main filter			
	Options:	Code:	Options:	Code:
	HEPA (std) and... Chemical (std) or... Pleated Bag	110633 110627 110645	Heavy Duty Chemical For applications where high levels of solvent are used or when lasing acrylic.	110624

(!) Please note the 5000i requires 2 main filters. Use 111006 in cleanroom applications.

6	Connection Hose Kit (Optional)	
	Call Purex or your local distributor for more information.	

7	Machine Interfacing (Optional)	
	<ul style="list-style-type: none"> Start/Stop Control: Extraction unit starts/stops when a connected piece of equipment is switched ON/OFF. Filter Blocked Warning: A signal is sent to a connected piece of equipment to trigger an alert or to shut it down. Remote ON/OFF Switch: 5M cable & switch 	
Allows the Purex system to interface with a piece of equipment connected to it.	See PAGE 34	

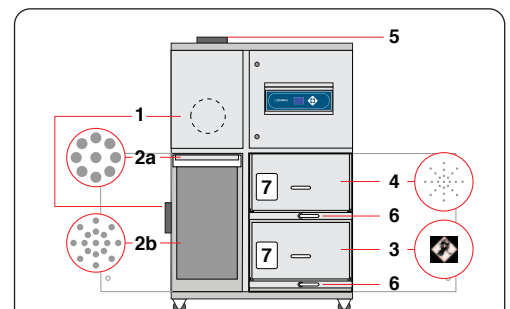

- Legend:**
- 1) Air inlet (Left or Rear) - 200mm safe seal.
 - 2) Pre-filter.
 - 3) Main Filter (HEPA location). †
 - 4) Main Filter (Carbon location). †
 - 5) Clean air returned to workplace.
 - 6) Filter locking handle.
 - 7) Filter identification label.
- Note:**
- 2a) Prefilter pad
 - 2b) Pleated Bag Filter
 - Alternatively a Labyrinth filter can be supplied.

All machines are mounted on four castors for increased mobility.

† Standard Filter Only

Digital Control System

A dedicated control, monitoring and display system unique to Purex fume extractors. All functions are fully automatic, all the user has to do is set the appropriate airflow on installation. The features of this system are designed to:

- Lower energy consumption by using variable speed motors and automatic flow control.
- Increase filter life by using the optimal extraction rate.
- Further protect people by constantly monitoring exhaust emissions.
- Interface with other equipment e.g. a laser.
- Maintain a constant extraction rate to prevent fume escape or damage to equipment.

System Features...

- Automatic electronic flow control - maintains a constant extraction rate even as the filter blocks
- Adjustable airflow
- Clear and informative graphic display
- Gas and Particle Sensors on the exhaust
- Low capital and running costs
- Quick change patented Labyrinth or standard pre-filters deliver longer filter life
- Submicronic (HEPA) filtration removes 99.997% of particles down to 0.3 microns
- Activated carbon filtration removes harmful gas
- Simple to install and quiet in operation
- Easy to relocate and precision made from stainless steel

Includes:

2 x Main filters and

1 x Labyrinth Pre-filter
or 4 x Pre-filter pads with
1 x Pleated Bag Filter

1 x Power cable (no plug)

Accessories

Please see the accessories section at the back of this brochure.



Analogue Systems



Alpha & Alpha Dust

What to specify...

1. Model

2. Voltage

3. Pre-filter

4. Main filter

5. Connection Kit

6. Interfacing Kit

	200		400	
1				
2				
Voltage	230V ±10%	120V ±10%	230V ±10%	120V ±10%
Alpha-Vacuum Control	0AL2102	0AL2103	0AL4102	0AL4103
Alpha Dust-Vacuum Control	-	-	0AL4136	0AL4137
Wattage	0.14 kW	0.107 kW	0.24 kW	0.255 kW
Frequency	50Hz / 60 Hz	50Hz / 60 Hz	50Hz / 60 Hz	50Hz / 60 Hz
Cabinet height (inc castors)	885 mm	885 mm	885 mm	885 mm
Cabinet width (not inc hose)	465 mm	465 mm	465 mm	465 mm
Cabinet depth (not inc hose)	430 mm	430 mm	430 mm	430 mm
Cabinet weight	55 Kg	55 Kg	55 Kg	55 Kg
Construction	Precision engineered brushed stainless steel units. High performance continuous run brushless motors. Mounted on castors for mobility.			

3

Labyrinth Pre-filter



Standard Alpha

Options: (Pack of 2)
F6 (std)
F8/F9 Composite

Code:
202269
202274

Dust Version

Options: (Pack of 2)
F6 (std)
F8/F9 Composite

Code:
202268
202271

4

Main filter



Options:

HEPA/Chemical (std)
HEPA/Twin Chemical
or HEPA/Twin Chemical
HEPA/Chemical Cleanroom*
HEPA
HEPA/Chemical
(Hydrophobic)

Code:

113505
113579
113669
113512
113809
113505H

Options:

Chemical
Chemical Special
Chemical (Acidic Fumes)
Pleated Bag

Code:

113508
113662
113505P
113531

* Use in combination with 202274

NOTE: No main filters are required for the dust version.

5

Connection Hose Kit

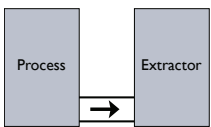

PAGE 26-28

6

Machine Interfacing (Optional)



Allows the Purex system to interface with a piece of equipment connected to it.

- **Start/Stop Control:** Extraction unit starts/stops when a connected piece of equipment is switched ON/OFF.
- **Filter Blocked Warning:** A signal is sent to a connected piece of equipment to trigger an alert or to shut it down.
- **Remote ON/OFF Switch:** 5M cable & switch

See PAGE 34

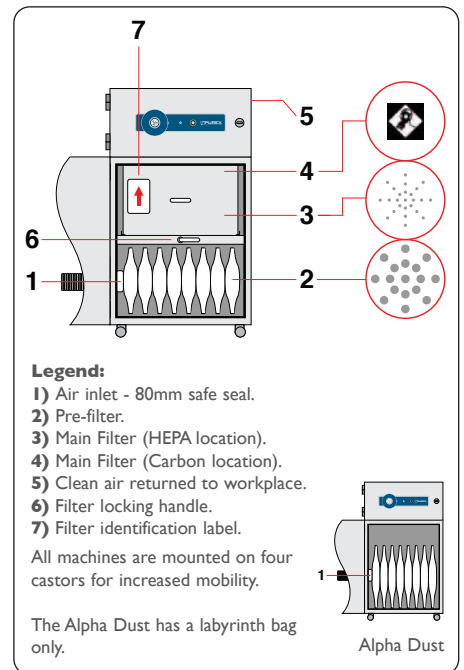

Controls

Visual and Audible Filter Blocked Warning

Alerts the operator when a filter starts to block so that a replacement filter can be acquired and downtime can be avoided.

LED Filter Status

Green = Filter OK

Yellow = Filter nearly full

Red = Filter full, replacement required

Interface with other equipment e.g. a laser optional.

System Features...

- Automatic electronic flow control - maintains a constant extraction rate even as the filter blocks
- Adjustable airflow
- VariColour filter blocked warning system
- Low capital and running costs
- Quick change, patented Labyrinth pre-filters deliver longer filter life
- Submicronic (HEPA) filtration removes 99.997% of particles down to 0.3 microns
- Activated carbon filtration removes harmful gas
- Simple to install and quiet in operation
- Easy to relocate
- Precision made from stainless steel

Includes:

- 1 x Main filter
- 2 x Labyrinth pre-filters
- 1 x Connection Kit
- 1 x Power cable

Note: Alpha Dust does not contain a main filter.

Accessories

Please see the accessories section at the back of this brochure.



Xbase

What to specify...

1. Model

2. Voltage

3. Pre-filter

4. Main filter

5. Connection Kit

6. Interfacing Kit

	200		400	
1				
2				
Voltage	230V ±10%	120V ±10%	230V ±10%	120V ±10%
Vacuum Control	0AL2106	0AL2107	0AL4104	0AL4107
Wattage	0.14 kW	0.107 kW	0.24 kW	0.255 kW
Frequency	50Hz / 60 Hz	50Hz / 60 Hz	50Hz / 60 Hz	50Hz / 60 Hz
Cabinet height (inc castors)	705 mm	705 mm	705 mm	705 mm
Cabinet width (not inc hose)	707 mm	707 mm	707 mm	707 mm
Cabinet depth (not inc hose)	691 mm	691 mm	691 mm	691 mm
Cabinet weight	80 Kg	80 Kg	80 Kg	80 Kg
Construction	Precision engineered brushed stainless steel units. High performance continuous run brushless motors. Mounted on castors for mobility.			

3

Labyrinth Pre-filter



Options: (Pack of 2)
F8/F9 Composite

Code:
202275

4

Main filter



Options:
HEPA/Chemical (std)
HEPA CSA

Code:
110545
113585



5

Connection Hose Kit

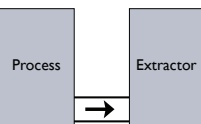

PAGE 26-28

6

Machine Interfacing (Optional)



Allows the Purex system to interface with a piece of equipment connected to it.

- **Start/Stop Control:** Extraction unit starts/stops when a connected piece of equipment is switched ON/OFF.
- **Filter Blocked Warning:** A signal is sent to a connected piece of equipment to trigger an alert or to shut it down.
- **Remote ON/OFF Switch:** 5M cable & switch

See PAGE 34

Storage Area

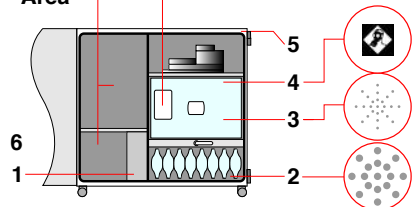

Legend:

- 1) Air inlet. - 80mm safe seal.
- 2) Pre-filter.
- 3) Main Filter (HEPA location).
- 4) Main Filter (Carbon location).
- 5) Clean air returned to workplace.
- 6) Filter locking handle.
- 7) Filter identification label.

All machines are mounted on four castors for increased mobility.

Controls

Visual and Audible Filter Blocked Warning

Alerts the operator when a filter starts to block so that a replacement filter can be acquired and downtime can be avoided.

LED Filter Status

Green = Filter OK
Yellow = Filter nearly full
Red = Filter full, replacement required

Interface with other equipment e.g. a laser optional.

System Features...

- Automatic electronic flow control - maintains a constant extraction rate even as the filter blocks
- Adjustable airflow
- VariColour filter blocked warning system
- Low capital and running costs
- Quick change, patented Labyrinth pre-filters deliver longer filter life
- Submicronic (HEPA) filtration removes 99.997% of particles down to 0.3 microns
- Activated carbon filtration removes harmful gas
- Simple to install and quiet in operation
- Easy to relocate
- Precision made from stainless steel

Includes:

- 1 x Main filter
- 2 x Labyrinth pre-filters
- 1 x Connection Kit
- 1 x Power cable

Accessories

Please see the accessories section at the back of this brochure.



FumeCube

What to specify...

1. Single or Dual Arm System

2. Voltage

3. Pre-filter

4. Main filter

6. Interfacing Kit

1		2		Single Arm System		Dual Arm System	
Voltage		230V ±10%		120V ±10%		230V ±10%	
Vacuum Control		072066		072067		072065	
Wattage		0.14 kW		0.107 kW		0.14 kW	
Frequency		50Hz / 60 Hz		50Hz / 60 Hz		50Hz / 60 Hz	
Cabinet height		366 mm		366 mm		366 mm	
Cabinet width (not inc hose)		308 mm		308 mm		308 mm	
Cabinet depth (not inc hose)		294 mm		294 mm		294 mm	
Cabinet weight (inc filters)		17 Kg		17 Kg		17 Kg	
Construction		Precision engineered brushed stainless steel units. High performance continuous run brushless motors. Quick and simple to relocate.					

3 Pre-filter Pad



<i>Options:</i>	<i>Code:</i>
F5 Pack of 4 (std)	200225
F6 Pack of 4	200226
F8/F9 Pack of 4	200316

4 Main filter



<i>Options:</i>	<i>Code:</i>	<i>Options:</i>	<i>Code:</i>
HEPA/Chemical (std)	110536	Solvent Lock	110543
Chemical	110537	<i>* Use in combination with 200316</i>	
Chemical Special	110544	Note: FumeCubes sold prior to December 2008 may require different filters. Please contact your local distributor for advice.	
HEPA/Chemical Cleanroom*	110538		



6 Machine Interfacing (Optional)

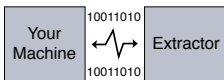

Allows the Purex system to interface with a piece of equipment connected to it.

- Start/Stop Control:** Extraction unit starts/stops when a connected piece of equipment is switched ON/OFF.
- Filter Blocked Warning:** A signal is sent to a connected piece of equipment to trigger an alert or to shut it down.
- Remote ON/OFF Switch:** 5M cable & switch

See PAGE 34

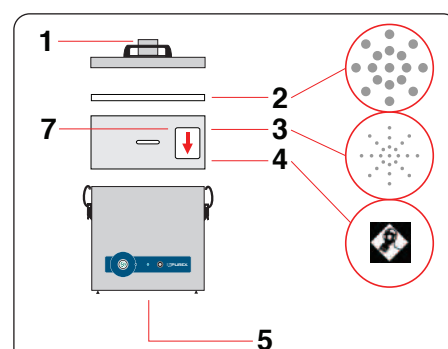

Single arm system supplied with:

- 1 x Filter + pre-filter pad
- 1 x 51mm x 2m flexible hose [black]
- 2 x Connecting cuffs [black]
- 1 x Clamped bracket
- 1 x 38mm stainless steel flexible arm and valve
- 1 x 38mm pen nib nozzle & 1 x conical cowl.



Dual arm system supplied with:

- 1 x Filter + pre-filter pad
- 2 x 51mm x 2m flexible hose [black]
- 4 x Connecting cuffs [black]
- 2 x Clamped bracket
- 2 x 38mm stainless steel flexible arm and valve
- 2 x 38mm pen nib nozzle and 2 x conical cowl.

- Legend:**
- 1) Air inlet - 57mm ID - 62mm OD
 - 2) Pre-filter.
 - 3) Main Filter (HEPA location).
 - 4) Main Filter (Carbon location).
 - 5) Clean air returned to workplace.
 - 7) Filter identification label.

In cleanroom filters, positions 3&4 are reversed.

Controls

Visual and Audible Filter Blocked Warning

Alerts the operator when a filter starts to block so that a replacement filter can be acquired and downtime can be avoided.

LED Filter Status

Green = Filter OK
 Yellow = Filter nearly full
 Red = Filter full, replacement required

Interface with other equipment e.g. a laser optional.

System Features...

- Automatic electronic flow control - maintains a constant extraction rate even as the filter blocks
- Adjustable airflow
- VariColour filter blocked warning system
- Low capital and running costs
- Quick change pre-filters deliver longer filter life
- Submicronic (HEPA) filtration removes 99.997% of particles down to 0.3 microns
- Activated carbon filtration removes harmful gas
- Simple to install and quiet in operation
- Easy to relocate
- Precision made from stainless steel

Includes:

- 1 x Main filter
- 4 x Pre-filter pad
- 1 or 2 Arm Kit
- 1 x Power cable

Accessories

Please see the accessories section at the back of this brochure.



FumeCube MAX

What to specify...

1. Voltage

2. Pre-filter

3. Main filter

4. Kits

5. Interfacing Kit

Machine Only		
Voltage	230V ±10%	120V ±10%
Vacuum Control	072115	072116
Wattage	0.14 kW	0.107 kW
Frequency	50Hz / 60 Hz	50Hz / 60 Hz
Cabinet height	493 mm	493 mm
Cabinet width (not inc hose)	314 mm	314 mm
Cabinet depth (not inc hose)	330 mm	330 mm
Cabinet weight (inc filters)	14 Kg	14 Kg



Pre-filter	
	Labyrinth Pre-Filter (All models) Description: F8/F9 Composite Code: 111124

Main filter	
	Main Filters Description: HEPA/Chemical (std) Chemical Code: 110507 110504

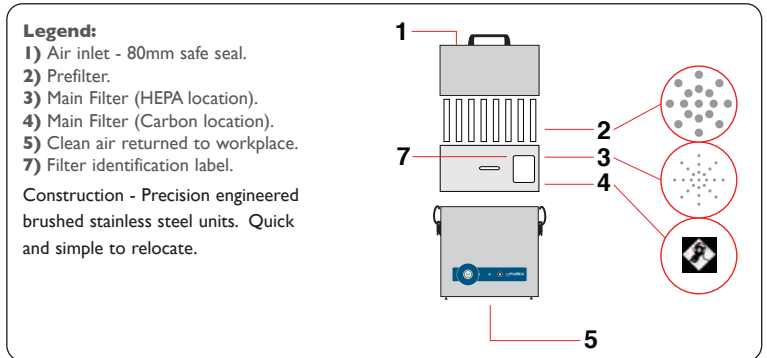

4	
Option 1	
Description: 51mm hose kit (3m)	Code: 100032
Option 2	
Single 38mm arm kit (Screw Fixing)	
1 x Arm Kit (Screw Fix)	100294
or 1 x Arm Kit (Clamp Fix)	100295
1 x 80mm to 51mm reducer	550287
Option 3	
Dual 38mm arm kit	
2 x Arm Kit (Screw Fix)	100294
or 2 x Arm Kit (Clamp Fix)	100295
1 x Dual Manifold Assembly	120093C

Hose and Arm Kits

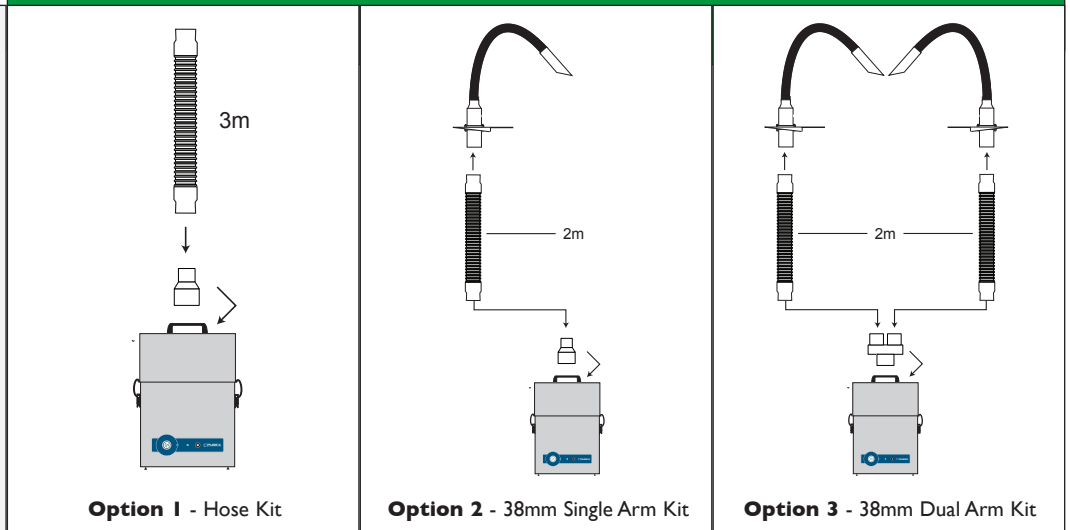

5 Machine Interfacing (Optional)	
Allows the Purex system to interface with a piece of equipment connected to it.	<ul style="list-style-type: none"> • Start/Stop Control: Extraction unit starts/stops when a connected piece of equipment is switched ON/OFF. • Filter Blocked Warning: A signal is sent to a connected piece of equipment to trigger an alert or to shut it down. • Remote ON/OFF Switch: 5M cable & switch - See PAGE 34

Controls

Visual and Audible Filter Blocked Warning

Alerts the operator when a filter starts to block so that a replacement filter can be acquired and downtime can be avoided.

LED Filter Status

Green = Filter OK

Yellow = Filter nearly full

Red = Filter full, replacement required

Interface with other equipment e.g. a laser optional.

System Features...

- Automatic electronic flow control - maintains a constant extraction rate even as the filter blocks
- Adjustable airflow
- VariColour filter blocked warning system
- Low capital and running costs
- Quick change, patented Labyrinth pre-filters deliver longer filter life
- Submicronic (HEPA) filtration removes 99.997% of particles down to 0.3 microns
- Activated carbon filtration removes harmful gas
- Simple to install and quiet in operation
- Easy to relocate
- Precision made from stainless steel

Includes:

- 1 x Main filter
- 1 x Labyrinth Pre-Filter
- 1 x Power cable



FumeSafe™

What to specify...

1. Model

3. Pre-filter

4. Main filter

1		3-15 Tip Fume Extraction Unit	
Voltage	230V ±10% or 120V ±10%		
Vacuum Control	072200		
Wattage	0.45 kW		
Frequency	50Hz / 60 Hz		
Cabinet height	493 mm		
Cabinet width (not inc hose)	471 mm		
Cabinet depth (not inc hose)	430 mm		
Cabinet weight (inc filters)	26 Kg		
Construction	Stainless Steel		
Construction	Precision engineered brushed stainless steel units. High performance continuous run brushless motors. Quick and simple to relocate.		

**Auto Sensing
Dual Voltage
Blower Works
Anywhere in
the World!**

3		Replacement Pads	
		Pre Filter Options: F8/F9 Pack of 4	Code: 200098
Pre Filter	Exhaust Filter	Exhaust Filter Options: Single	Code: 200053



4		Replacement Main filter	
	Options: HEPA/Chemical (std) Chemical or Chemical Special HEPA/Chemical Cleanroom Solvent Lock	Code: 110531 110532 110542 110533 110541	

Pipe kit (100165) includes 32mm Ø:	Code:
6 x 1.5M x 32mm pipe (3 pre drilled)	500050
4 x 90° bends	500080
2 x Swept T's	500100
4 x Straight connectors	500060
2 x End caps	500120

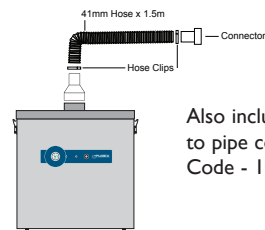
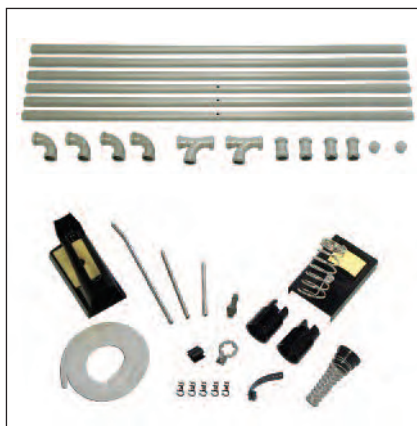

Also includes machine to pipe connector hose
Code - 100170

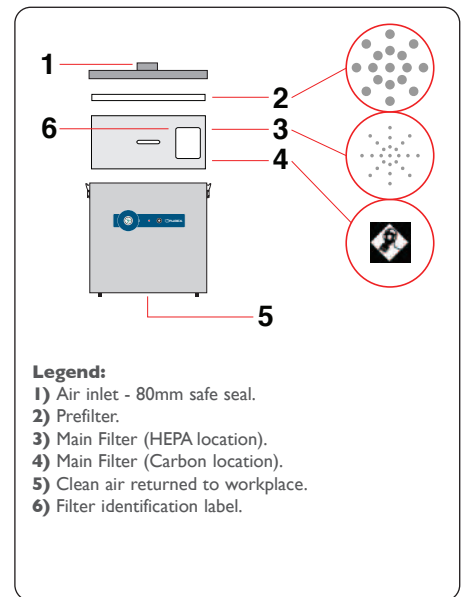

Supplied with 3 universal iron kits - 300001

Controls

Visual and Audible Filter Blocked Warning

Alerts the operator when a filter starts to block so that a replacement filter can be acquired and downtime can be avoided.

Controls & System Features...

- Speed Control
- Dual voltage brushless blower
- Low capital and running costs
- Quick change pre-filters deliver longer filter life
- Submicronic (HEPA) filtration removes 99.997% of particles down to 0.3 microns
- Activated carbon filtration removes harmful gas
- Simple to install and quiet in operation
- Easy to relocate
- Precision made from stainless steel
- Filter blocked alarm and LED

Includes:

- 1 x Main filter
- 1 x Pre-filter pad
- 1 x Exhaust filter
- 1 x Power cable
- 1 x Connection kit
- 1 x Pipework kit
- 3 x Universal iron kits

Accessories

Please see the accessories section at the back of this brochure.



What to specify...

1. Model

3. Pre-filter

4. Main filter

2 Tip Fume Extraction Unit	
Voltage	230V ±10%
Vacuum Control	072120
Wattage	0.135 kW
Frequency	50Hz / 60 Hz
Cabinet height	275 mm
Cabinet width (not inc hose)	286 mm
Cabinet depth (not inc hose)	291 mm
Cabinet weight (inc filters)	9.8 Kg
Construction	Stainless Steel
Construction	Precision engineered brushed stainless steel units. High performance continuous run brushless motors. Quick and simple to relocate.

3
Replacement Pre-filter Pad

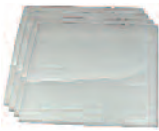

Options:
F5 Pack of 4 (std)
F6 Pack of 4

Code:
200225
200226

4
Replacement Main filter



Options:
HEPA/Chemical (std)

Code:
110507



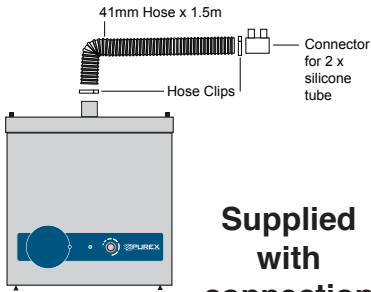

41mm Hose x 1.5m

Hose Clips

Connector for 2 x silicone tube

Supplied with connection kit



Options: Iron kits (Pg 32-33)

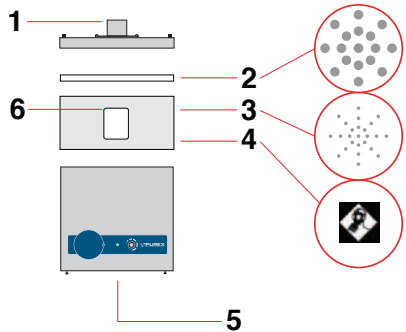

Legend:

- 1) Air inlet - 38mm ID - 40mm OD
- 2) Prefilter.
- 3) Main Filter (HEPA location).
- 4) Main Filter (Carbon location).
- 5) Clean air returned to workplace.
- 6) Filter identification label.

Controls & System Features...

- Run LED
- Speed Control
- Low capital and running costs
- Quick change pre-filters deliver longer filter life
- Submicronic (HEPA) filtration removes 99.997% of particles down to 0.3 microns
- Activated carbon filtration removes harmful gas
- Simple to install and quiet in operation
- Easy to relocate
- Precision made from stainless steel

Includes:

- 1 x Main filter
- 1 x Pre-filter pad
- 1 x Power cable
- 1 x Connection kit
- 1 x End cap

Accessories

Please see the accessories section at the back of this brochure.



FumeBuster

What to specify...

1. Voltage

2. Pre-filter

3. Main filter





4. Capture Kit (For one or two stations)

Machine Only		
Voltage	230V ±10%	115V ±10%
Vacuum Control	070362	070363
Wattage	0.3 kW	0.3 kW
Frequency	50Hz	60 Hz
Cabinet height (inc castors)	350 mm	350 mm
Cabinet width (not inc hose)	425 mm	425 mm
Cabinet depth (not inc hose)	415 mm	415 mm
Cabinet weight (inc filters)	25 Kg	25 Kg
Construction	Precision engineered brushed stainless steel units. High performance continuous run brushless motors. Quick and simple to relocate.	

2 Pre-filter Pad	
	<p>Options: Code:</p> <p>F5 Pack of 4 (std) 200314</p> <p>F8/F9 Pack of 4 200098</p>

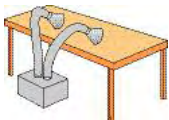
3 Main filter	
	<p>Options: Code: Solvent Lock 110541</p> <p>HEPA/Chemical (std) 110531 * Use in combination with 200098</p> <p>Chemical 110532</p> <p>or Chemical Special 110542</p> <p>HEPA/Chemical Cleanroom* 110533</p>

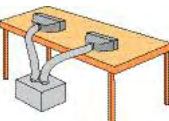

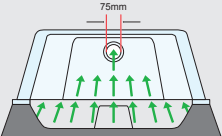
4 Capture Kit (Optional)	
	<p>1 x 1.2m x 75mm Ø flexible arm with 2 x 75mm couplings (120707) + 1 x Conical cowl (840114)</p> <p>Code: 100181</p> 
	<p>1 x 1.5m x 75mm Ø flexible hose with 2 x 75mm couplings (100185) + 1 x Anti-static plenum cowl (black) (120702)</p> <p>Code: 100182</p> 
	<p>1 x 1.5m x 75mm Ø flexible hose with 2 x 75mm couplings (100185) + 1 x Cleancab extraction cabinet (840155)</p> <p>Code: 100183</p> 

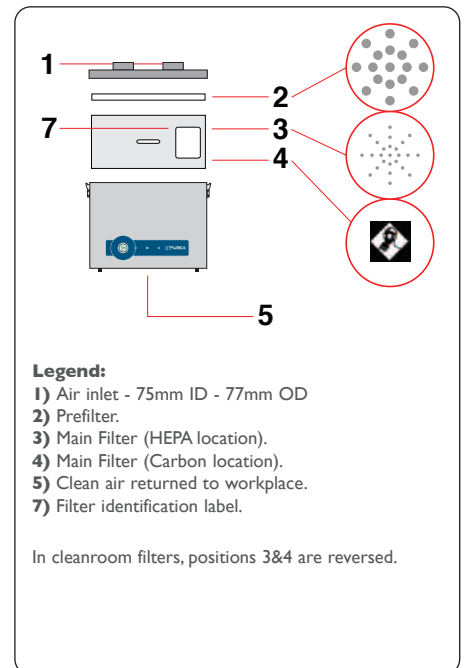

Controls

Visual and Audible Filter Blocked Warning

Alerts the operator when a filter is blocked so that a replacement filter can be acquired.

LED Filter Status

Green = Filter OK

Red = Filter full, replacement required

System Features...

- Audible and visual filter blocked alert
- Low capital and running costs
- Quick change pre-filters deliver longer filter life
- Submicronic (HEPA) filtration removes 99.997% of particles down to 0.3 microns
- Activated carbon filtration removes harmful gas
- Simple to install and quiet in operation
- Easy to relocate
- Precision made from stainless steel

Includes:

- 1 x Main filter
- 4 x Pre-filter pad
- 1 x Port blank (530430)
- 1 x Power cable

Accessories

Please see the accessories section at the back of this brochure.



What to specify...

Model

Voltage

2

Captivair Max

	230V ±10%	120V ±10%		
Voltage	230V ±10%	120V ±10%		
Vacuum Control	080703	080702		
Wattage	0.155 kW	0.280 kW		
Frequency	50 Hz	60 Hz		
Cabinet height (inc castors)	691 mm	691 mm		
Cabinet width (not inc hose)	851 mm	851 mm		
Cabinet depth (not inc hose)	591 mm	591 mm		
Cabinet weight (inc filters)	100 Kg	100 Kg		



CAPTIVAIR
MAX

Legend:

- 1) Air inlet
4 x 48mm ID - 51mm OD
4 x 98mm ID - 102mm OD
- 4) Main Filter (Carbon location).
- 5) Clean air returned to workplace.

All machines are constructed of coated steel.

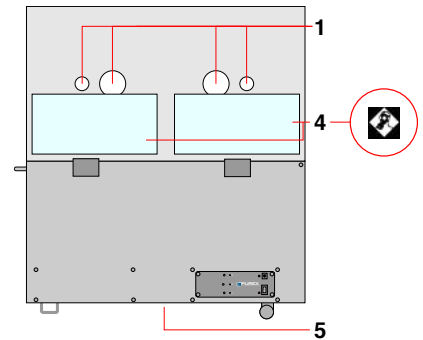

Main filter (Included)



Description: Chemical (refillable)
Refill for 113800

Code: 113800
113805

(!) Please note the Captivair^{MAX} requires 2 main filters.

Printer Model	Machine Part No.		Machine Type	Connection Kit	Fittings	Manifold	Main Filter	Pre-Filter	
	230V	120V							
Mimaki	JV33-130SP	080703	080702	CaptivairMAX	120309	120311	120313	113800 x 2	-
	JV33-160SP	080703	080702	CaptivairMAX	120309	120312	120313	113800 x 2	-
Roland	AdvancedJet AJ-740	0LX4000D	0LX4001D	400	120188	120299	-	113508	202260
	VersaUV LEC-300	0AL4102	0AL4103	Alpha 400	100019	120090	-	113508	202269
	VersaUV LEC-330	0AL4102	0AL4103	Alpha 400	100019	120089	-	113508	202269
Seiko	ColorPainter H-74s	080703	080702	CaptivairMAX	120303	120314	120322	113800 x 2	-
	ColorPainter H-104s	080703	080702	CaptivairMAX	120303	120314	120322	113800 x 2	-
	ColorPainter V-64s	0LX4000D	0LX4001D	400	120297	120323 x 2	-	113508	202260

Contact Purex or your local distributor for more information.

Captivair units are available for other printer models, please contact Purex or your local distributor for further information.

Features...

- Captures fumes at source
- Reduces fumes escaping into the workplace
- Promotes a more pleasant working environment
- Can help reduce headaches and nausea caused by fumes
- Helps prevent fumes escaping into neighbouring buildings and rooms
- Bespoke kits for each printer model
- Can aid compliance with health and safety regulations

System Features...

- Visual filter blocked alert
- Low capital and running costs
- Activated carbon filtration of ink vapour
- Simple to install and quiet in operation
- Easy to relocate

Includes:

- 2 x Main filters
- 1 x Power cable





Inline Filter Units

What to specify...

Pre-filter

Connection Kit

1	Cascade	Spark Arrestor
Part number	890180	890241
Cabinet height (inc castors)	1063 mm	1063 mm
Cabinet width (not inc hose)	430 mm	430 mm
Cabinet depth (not inc hose)	430 mm	430 mm
Cabinet weight (inc filters)	30 Kg	30 Kg
Note: Vacuum or Volume	The Cascade Box is fitted with a silicone vacuum sensing tube. The tube should be connected to the inlet on all vacuum machines e.g. Xbase, Alpha and Digital Tip and Arm Applications. It should not be connected on volume machines.	Not Applicable.

2	Cascade Pre-filter	Spark Arrestor
	<p>Description: Needlefelt Cascade Code: 111107 or</p> <p>Description: Labyrinth F8/F9 Composite Code: 111117</p>  <p>Cascade Version Shown</p>	<p>Description: Supplied with a collection tray</p> 

3	Connection Hose Kit
	<p>1 x 1M of 80mm hose 1 x 100-80mm reducer 1 x 80mm coupling 1 x 100mm coupling 2 x 70-90mm hose clips</p> <p>Code: 100184</p>

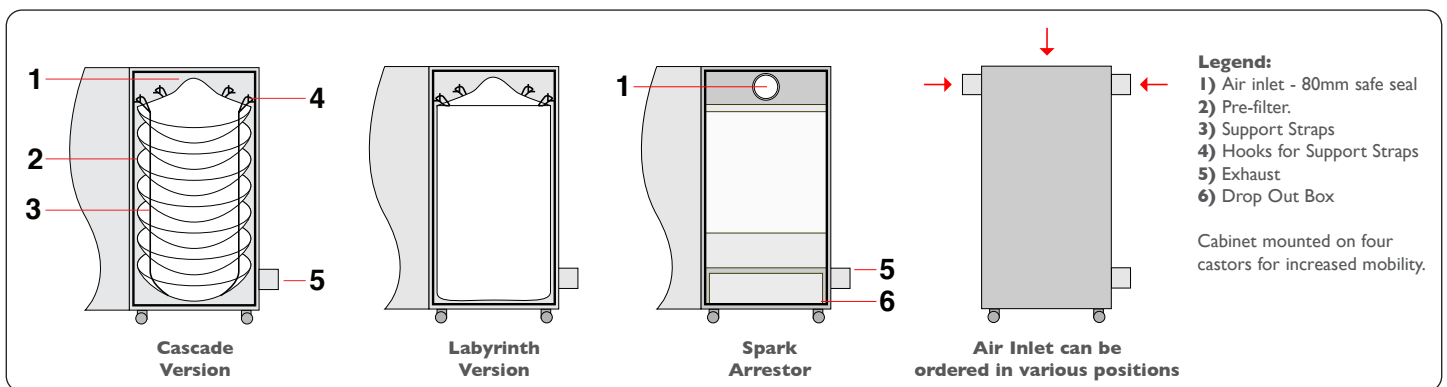

Inline Filter

The Cascade Box acts as an additional prefilter to capture particles in applications where large amounts are produced. The filter can be emptied when full and the operator can periodically shake the filter to increase filter life.

- Removes large particles from the process air
- Extends the life of the filters in the fume extractor
- Can be used on problematic applications where large quantities of dust are produced
- Filter can be seeded to help deal with sticky particles
- Filter can be emptied and shaken to prolong life*

- The use of this unit means the operator does not have to buy a new, larger fume extraction machine
- Low capital and running costs
- Simple to install and easy to relocate
- Precision made from stainless steel
- * cascade filter only

Spark Arrestor

This inline unit is used to prevent sparks entering the extraction machine. It works by extinguishing sparks against metal surfaces and collecting hot materials in a drop out box.

Includes:

- 1 x Cascade filter
- or 1 x Labyrinth filter
- or 1 x Drop out box
- 1 x Connection kit

Accessories

Please see the accessories section at the back of this brochure.



Accessories



Connection Kits

PUREX MACHINE INLET DIAMETERS

- 40mm - 2tiP
- 57mm - FumeCube
- 75mm - FumeBuster
- 80mm - 200, 400, 200i, 400i, 200i-HP, 400iPVC Alpha, Alpha Dust, Xbase, FumeCube Max, FumeSafe
- 100mm - 800i
- 150mm - 1500i, 2000i
- 200mm - 5000i

??mm	?.?m	??mm
Diameter of pipe/port	Length of hose	Purex machine inlet diameter

32mm	1.5m	80mm
-------------	-------------	-------------

Connect to 32mm diameter pipe/port

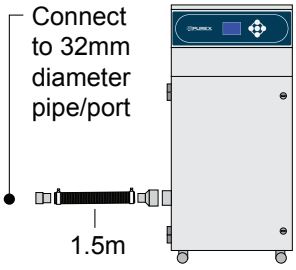

Code: 100170
 1 x 80-34mm reducer
 1 x 1.5m x 41mm flexible hose
 2 x Half straight connector
 2 x 35-50mm hose clips

50mm	2.0m	80mm
-------------	-------------	-------------

Connect to 50mm diameter pipe/port

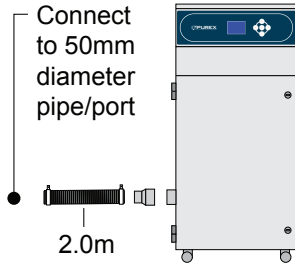

Code: 100180
 1 x 80-53.5mm reducer
 1 x 2m x 57mm flexible hose
 2 x 45-60mm hose clips

50mm	3.0m (Anti Static)	80mm
-------------	---------------------------	-------------

Connect to 50mm diameter pipe/port or Purex valve

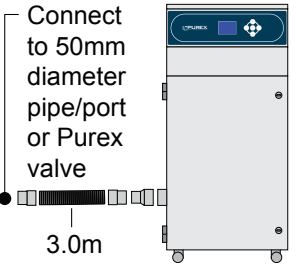

Code: 100026
 1 x earth strap 6mm
 1 x 80mm to 51mm reducer
 1 x 3m x 50mm antistatic hose
 2 x 51mm antistatic cuffs

50mm	Twin Head AntiStatic	80mm
-------------	-----------------------------	-------------

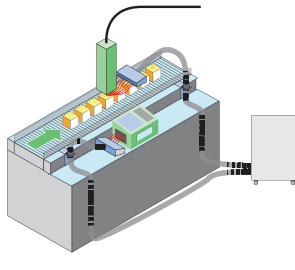

These are bespoke kits. An example is shown on the left. Contact us for more information.

50mm	2.0m	57mm
-------------	-------------	-------------

Connect to 50mm diameter pipe/port or Purex valve

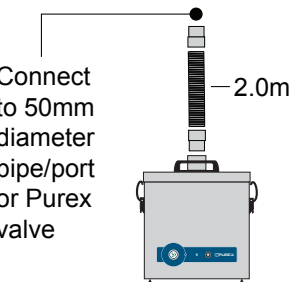

Code: 120117
 1 x 2m x 51mm flexible hose
 2 x 51mm cuffs

50mm	3.0m	80mm
-------------	-------------	-------------

Connect to 50mm diameter pipe/port or Purex valve

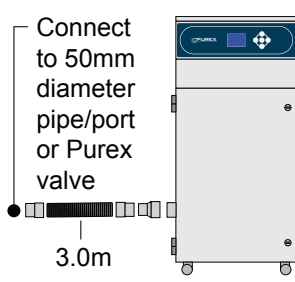

Code: 100032
 1 x 80-51mm reducer
 1 x 3m x 51mm flexible hose
 2 x 51mm cuffs

50mm	6.0m	80mm
-------------	-------------	-------------

Connect to 50mm diameter pipe/port or Purex valve

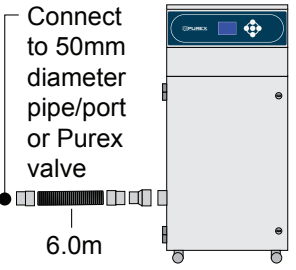

Type Std Code:
PVC* 100043C
 1 x 80-51mm reducer
 1 x 6m x 51mm flexible hose
 2 x 51mm cuffs

* coated reducer suitable for PVC applications

50mm	6.0m (Dual Manifold)	80mm
-------------	-----------------------------	-------------

Connect to 50mm diameter pipe/port or Purex valve

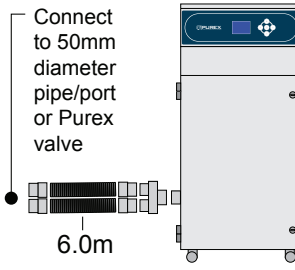

Code: 100039*
 (Use with 100043 or 100043C)
 1 x dual manifold assembly(120093C)
 1 x 6m x 51mm flexible hose
 2 x 51mm cuffs

* also suitable for PVC applications.



Connection Kits

50mm	6.0m (Extension)	50mm
		
<p>Code: 100037* 1 x 50mm coupling 1 x 6m x 51mm flexible hose 2 x 51mm cuffs</p> <p>* also suitable for PVC applications.</p>		

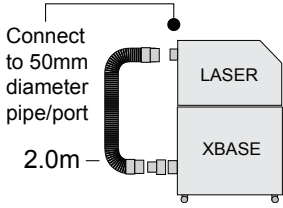
50mm	2.0m	80mm
		
<p>Code: 100019 1 x 80-51mm reducer 1 x 2m x 51mm flexible hose 2 x 51mm cuffs</p>		

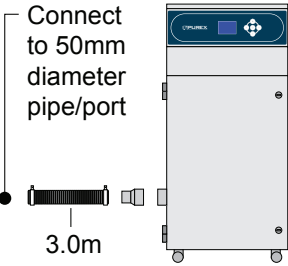
50mm	3.0m	80mm
		
<p>Code: 120285 1 x 80-53 mm reducer 1 x 3m x 57mm flexible hose 2 x 45-60mm hose clips</p>		

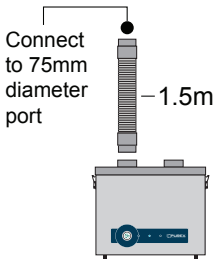
75mm	1.5m	75mm
		
<p>Code: 100185 2 x 85-75mm reducer 1 x 1.5m x 75mm flexible hose</p>		

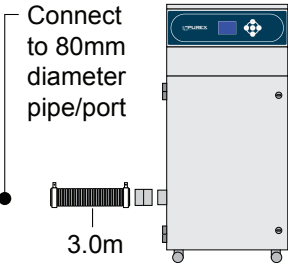
80mm	3.0m	80mm
		
<p>Code: 120299 1 x 80mm female coupling 1 x 3m x 82mm flexible hose 2 x 70-90mm hose clips</p>		

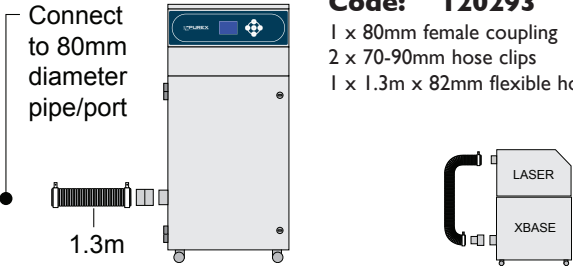
80mm	1.3m	80mm
		
<p>Code: 120293 1 x 80mm female coupling 2 x 70-90mm hose clips 1 x 1.3m x 82mm flexible hose</p>		

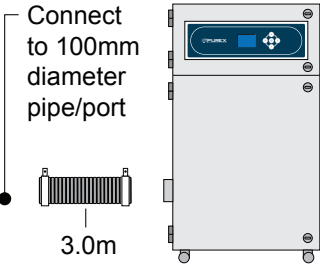
100mm	3.0m	100mm
		
<p>Code: 100107* 1 x 3m x 100mm flexible hose 2 x 90-120mm hose clips</p> <p>* suitable for PVC</p>		

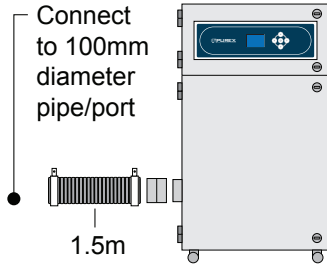
100mm	1.5m	100mm
		
<p>Code: 120270 1 x 100mm female coupling 1 x 1.5m x 100mm flexible hose 2 x 90-120mm hose clips</p>		

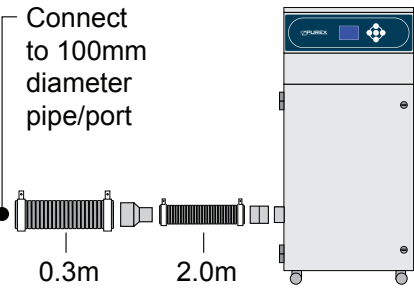
100mm	2.3m	80mm
		
<p>Code: 120288 1 x 80mm female coupling 2 x 70-90mm hose clips 1 x 2m x 82mm flexible hose 1 x 100-80mm reducer 1 x 0.3m x 100mm flexible hose 2 x 90-120mm hose clips</p>		

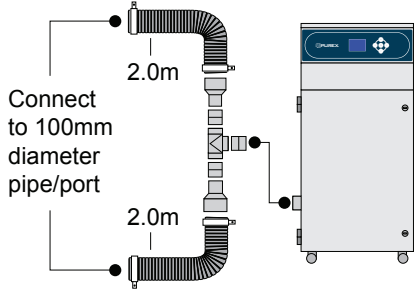
100mm	2.0m (Dual)	80mm
		
<p>Code: 120297 3 x 80mm female coupling 1 x 80mm equal tee 2 x 100-80mm reducer 2 x 2m x 100mm flexible hose 4 x 90-120mm hose clips</p>		



Connection Kits

??mm	?.?m	??mm
Diameter of pipe/port	Length of hose	Purex machine inlet diameter

100mm	1.3m	80mm
<p>Code: 120292</p> <ul style="list-style-type: none"> 1 x 80mm female coupling 2 x 70-90mm hose clips 1 x 1m x 82mm flexible hose 1 x 100-80mm reducer 1 x 0.3m x 100mm flexible hose 2 x 90-120mm hose clips 		

100mm	3.0m (Dual)	100mm
<p>Code: 120291</p> <ul style="list-style-type: none"> 1 x 100mm female coupling 1 x 100mm equal tee 2 x 3m x 102mm flexible hose 4 x 90-120mm hose clips 		

100mm	3.0m (Dual)	150mm
<p>Code: 120287</p> <ul style="list-style-type: none"> 1 x 150mm female coupling 1 x 150mm equal tee 2 x 150 female couplings 2 x 150-100mm reducers 2 x 90-120mm hose clips 2 x 3m x 102mm flexible hose 2 x 90-120mm hose clips 2 x 100mm female couplings 		

125mm	3.0m	80mm
<p>Code: 100171</p> <ul style="list-style-type: none"> 1 x 80mm female coupling 1 x 100-80mm reducer 1 x 3m x 100mm flexible hose 1 x 125-100mm reducer 1 x 125mm female coupling 2 x 90-120mm hose clips 		

125mm	3.0m	100mm
<p>Code: 100172</p> <ul style="list-style-type: none"> 1 x 100mm female coupling 1 x 125-100mm reducers 1 x 3m x 125mm flexible hose 2 x 135-160mm hose clips 		

150mm	1.5m	150mm
<p>Code: 120280</p> <ul style="list-style-type: none"> 1 x 150mm female coupling 1 x 150mm male coupling 1 x 1.5m x 150mm flexible hose 2 x 135-160mm hose clips 		

150mm	3.3m	80mm
<p>Code: 120289</p> <ul style="list-style-type: none"> 1 x 80mm female coupling 2 x 70-90mm hose clips 1 x 3m x 82mm flexible hose 1 x 100-80mm reducer 1 x 0.3m x 100mm flexible hose 2 x 90-120mm hose clips 1 x 150-100mm reducer 1 x 0.3m x 150mm flexible hose 2 x 135-160mm hose clips 		

150mm	3.25m	100mm
<p>Code: 120294</p> <ul style="list-style-type: none"> 1 x 100mm female coupling 1 x 100mm equal tee 4 x 90-120mm hose clips 2 x 3m x 100mm flexible hose 2 x 150-100mm reducers 2 x 0.25m x 150mm flexible hose 4 x 135-165mm hose clips 		

200mm	1.0m	200mm
<p>Code: SPECIAL</p> <ul style="list-style-type: none"> 1 x 200mm female coupling 1 x 200mm male coupling 1 x 1m x 200mm flexible hose 2 x 200mm hose clips 		



Pipe & Duct

Plastic Pipe Ø 32mm		Plastic Pipe Ø 50mm		Plastic Pipe Ø 82mm	
3.0m straight pipe 500050 - Grey 500055 - Black ABS		3.0m straight pipe 520000 - Grey 520300 - Black ABS		3.0m straight pipe 530110 - Grey	
Straight connector 500060 - Grey 500065 - Black ABS		Straight connector 520020 - Grey 520330 - Black ABS		Straight connector 530170	
45° bend 500070 - Grey		45° bend 520070 - Grey		45° bend single socket 530180	
90° bend 500080 - Grey 500090 - Black ABS		90° bend 520080 - Grey 520130 - Black ABS		90° bend single socket 530190	
Swept 'T' 500100 - Grey 500110 - Black ABS		Swept 'T' 520120 - Grey 520320 - Black ABS		Swept 'T' 530210	
End blank 500120 - Grey 500130 - Black ABS		End blank 520170		Socket plug 530220	
Pipe clip 500180		Pipe clip 520180		Pipe clip 530120	
		Pipe reducer (50-32mm) 520150		Pipe reducer (82-50mm) 530200	
				82mm Strap boss 530160	
				50mm Boss adaptor 530150	

	Steel Duct Ø 100mm	Steel Duct Ø 150mm	Steel Duct Ø 200mm
	3.0m spiral pipe 540100	3.0m spiral pipe 540300	3.0m spiral pipe 540600
	90° bend 540133	90° bend 540345	90° bend 540620
	45° bend 540130	45° bend 540333	45° bend 540622
	30° bend 540129	30° bend 540328	
	Equal 'T' 540145	Equal 'T' 540337	Equal 'T' 540630
	End cap 540161	End cap 540400	End cap 540402
	'U' bracket saddle 540190	'U' bracket saddle 540450	'U' bracket saddle 540891
	Butterfly valve 540185	Butterfly valve 540440	Butterfly valve 540439
	Pipe reducer (100mm-80mm) 540150	Pipe reducer (150mm-100mm) 540382	Pipe reducer (200mm-150mm) 540640
	ENERGY Valve - Alternating Shut Off (100mm) 540686		ENERGY Valve - Alternating Shut Off (200mm) 540684



Arms & Accessories

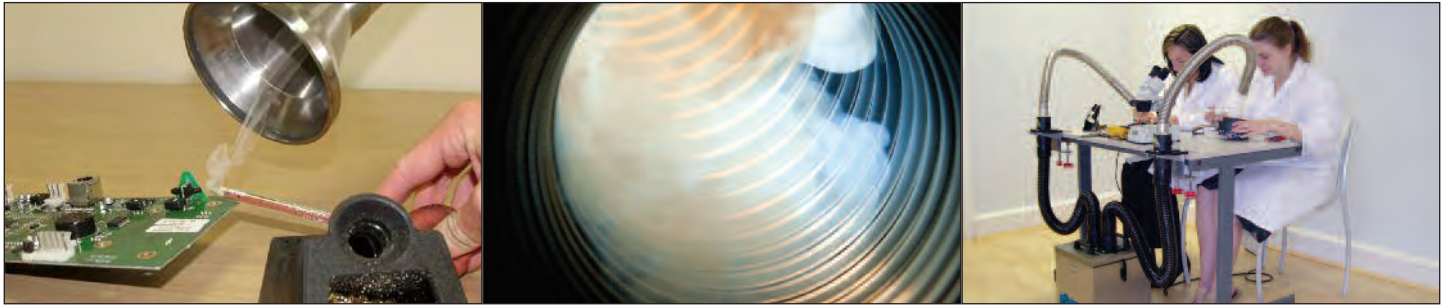

38mm Stainless Steel Flexible Arm Kit For Purex Airflow Valves

	<p>Includes:</p> <ul style="list-style-type: none"> 1 x 38mm x 1m stainless steel flexible arm with fixed pen nib nozzle 1 x Support collar and valve 1 x Screwed bench bracket 1 x 51mm x 2m flexible hose with 2 connecting cuffs <p>Code: 100294</p> <p>Replacement parts available if required.</p>		<p>Includes:</p> <ul style="list-style-type: none"> 1 x 38mm x 1m stainless steel flexible arm (includes 1 x Support collar and valve) 1 x Clamped bench bracket 1 x Pen-nib nozzle (38mm ID) 1 x Conical cowl (95mm ID) 1 x 51mm x 2m flexible hose with 2 connecting cuffs <p>Code: 100295</p> <p>Replacement parts available if required.</p>
--	--	--	--

(Additional Fittings)

<p>Clear hood cowl (265 x 310mm) Code: 840160</p>	<p>Pen Nib Nozzle (38mm ID) Code: 840170</p>	<p>Delta cowl (192 x 5mm inlet) Code: 840182</p>	<p>Conical Cowl (95mm ID) Code: 840190</p>
<p>Screwed bench bracket Code: 840200</p>	<p>Clamped bench bracket Code: 120180</p>	<p>Wall bracket Code: 840210</p>	<p>Bench support collar and valve Code: 840048</p>
<p>Plenum cowl Anti static polycarbonate (black) Includes 57mm airflow valve Code: 120703</p>	<p>Plenum cowl Anti static polycarbonate (clear) Includes 57mm airflow valve Code: 120704</p>	<p>Max W x L 300 x 400mm</p>	

38mm Stainless Steel Flexible Arm For Push Fit Valves

	<p>Build</p> <p>This is a high quality stainless steel replacement arm to fit plastic push fit valves.</p> <ul style="list-style-type: none"> 1 x 38mm x 1m stainless steel flexible arm 1 x Pen-nib nozzle (38mm ID) or 1 x Conical cowl (38mm ID) 1 x Tapered fitting <div style="text-align: right;"> </div>
--	---

Pen Nib Type Code: 120143

Conical Cowl Type Code: 120144

50mm Stainless Steel Flexible Arm Kit For Purex Airflow Valves

	<p>Includes:</p> <ul style="list-style-type: none"> 1 x 50mm x 1m stainless steel flexible arm with fixed conical cowl 1 x Support collar and valve 1 x Clamped bench bracket 1 x 51mm x 2m flexible hose with 2 connecting cuffs <p>Code: 100297</p>		<p>Includes:</p> <ul style="list-style-type: none"> 1 x 50mm x 1m stainless steel flexible arm with square end 1 x Support collar and valve 1 x Clamped bench bracket 1 x 51mm x 2m flexible hose with 2 connecting cuffs <p>Code: 100298</p>		<p>Includes:</p> <ul style="list-style-type: none"> 1 x 50mm x 1m stainless steel flexible arm with clear hood cowl & cuff 1 x Support collar and valve 1 x Clamped bench bracket 1 x 51mm x 2m flexible hose with 2 connecting cuffs <p>Code: 100299</p>
--	--	--	--	--	--

Replacement parts available if required.



Arms & Accessories

CleanCab Enclosed Extraction Unit

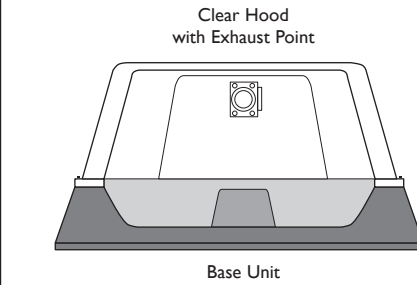
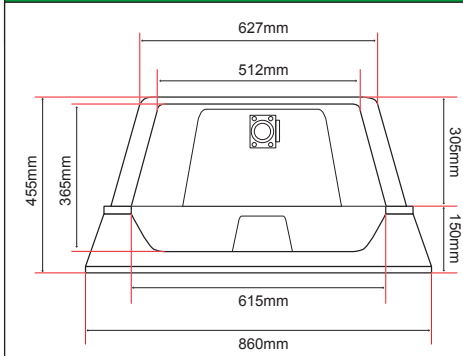

Depth = 510mm

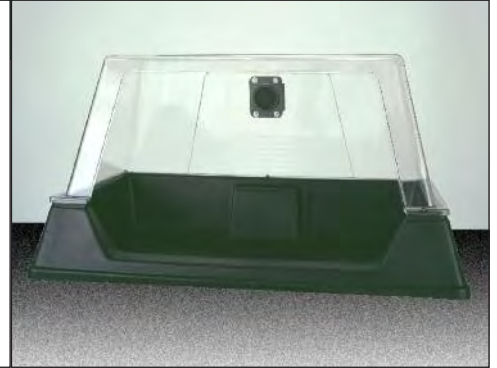

Complete Kit		Hood Only		Base Only	
	Includes: Base Open hood 57mm Airflow valve Code: 840150		Includes: Open hood 57mm Airflow valve Code: 840159		Includes: Base Code: 840152
	Includes: Base Open hood 75mm Exhaust port Code: 840155		Includes: Open hood 75mm Exhaust port Code: 840171		Includes: Downdraught base + insert Perforated steel plate 75mm Exhaust port Code: 840161
	Includes: Downdraught base + Insert Perforated steel plate Open hood 75mm Exhaust port Code: 840164		Includes: Open hood Code: 840151		

Connection kits with 51mm cuffs are suitable for 57mm valves - for 75mm exhaust port use kit 100185

Clean Air Feed

Free Clean Air!

- Purex machines produce very clean air from the exhaust so why not use it?
- This replacement exhaust cowl can be used to supply clean air to equipment such as lasers, ovens and more...

Machine Range:	Code:
200/400, 200i/400i	190040
800i	190039
1500i/2000i	640002



Dual Inlet Manifold

Connect two hose to one machine.

Manifold:	Code:
Aluminium Manifold	120093
Coated Aluminium Manifold for corrosive fumes.	120093C



(1 x 80mm to 2 x 50mm inlets)

Large Flexible Arms - Call

Digital 400 machines and above only.

100mm = Code: 120172

Other diameters please call.



Compressors

30 PSI / 2.1 bar

Compressor:	Code:
Free standing	100284
Integrated*	100283

* 200i/400i/Alpha/Xbase





Tip Kits & Accessories

Universal - Soldering Iron Kit

Allows an extraction tube to be fitted to most common soldering irons.

- 1) 1 x 1.5m x 6mm ID x 1.5mm wall clear silicone hose (560030)
- 2) 1 x screw in adaptor (8mm hose, M10) (580010)
- 3) 5 x 8mm Ø hose clips (580525)
- 4) 1 x universal iron stand (830007)
- 5) 1 x soldering iron stand (830008)
- 6) 1 x cup standard iron (830000)
- 7) 1 x cup metcal iron (830005)
- 8) 1 x extraction tube clip weller (830040)
- 9) 1 x extraction tube clip metcal/mini weller (830050)
- 10) 1 x extraction tube strap universal (830051)
- 11) 1 x 6mm Ø x 100mm extraction tube weller (830110)
- 12) 1 x 6mm Ø x 135mm extraction tube metcal (830112)
- 13) 1 x 6mm Ø x 225mm extraction tube universal (830135)

Code: **300001**

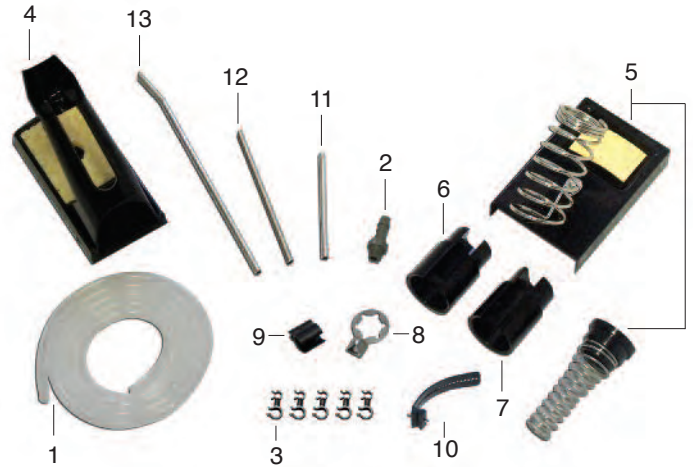

Specific - Soldering Iron Kits

Allows an extraction tube to be fitted to specific soldering irons.

<p>Metcal iron kit 100075</p> <p>1 x extraction tube clip 830050 1 x 6mm Ø x 135mm extraction tube 830112 1 x 1.5m x 6mm ID x 1.5mm wall clear silicone hose 560030 5 x hose clips 580525 Universal iron stand 830007 1 x screw in adaptor (M10) 580010</p>		<p>Large Weller iron adaptor kit 100070</p> <p>1 x extraction tube clip 830041 1 x 7mm Ø x 150mm extraction tube 830115 1 x 1.5m x 6mm ID x 1.5mm wall clear silicone hose 560030 5 x hose clips 580525 1 x soldering iron stand 830008 1 x cup 830002 1 x screw in adaptor (M10) 580010</p>	
<p>Antex/Ersa iron kit 100085</p> <p>1 x extraction tube clip 830050 1 x extraction tube strap 830051 1 x 6mm Ø x 225mm extraction tube 830135 1 x 1.5m x 6mm ID x 1.5mm wall clear silicone hose 560030 5 x hose clips 580525 Universal iron stand 830007 1 x screw in adaptor (M10) 580010</p>		<p>Pace iron adaptor kit 100072</p> <p>1 x extraction tube strap 830051 1 x 6mm Ø x 100mm extraction tube 830110 1 x 1.5m x 6mm ID x 1.5mm wall clear silicone hose 560030 5 x hose clips 580525 1 x soldering iron stand 830008 1 x cup 830002 1 x screw in adaptor (M10) 580010</p>	
<p>Mini Weller iron kit 100065</p> <p>1 x extraction tube clip 830050 1 x 6mm Ø x 135mm extraction tube 830112 1 x 1.5m x 6mm ID x 1.5mm wall clear silicone hose 560030 5 x hose clips 580525 1 x soldering iron stand 830008 1 x cup 830005 1 x screw in adaptor (M10) 580010</p>		<p>Hakko iron adaptor kit 100030</p> <p>1 x 6mm Ø x 225mm extraction tube 830136 1 x 1.5m x 6mm ID x 1.5mm wall clear silicone hose 560030 5 x hose clips 580525 1 x screw in adaptor (M10) 580010 1 x extraction tube strap 830051</p>	
<p>Standard Weller/RS/Adcola iron kit 100060</p> <p>1 x extraction tube clip 830040 1 x 6mm Ø x 100mm extraction tube 830110 1 x 1.5m x 6mm ID x 1.5mm wall clear silicone hose 560030 5 x hose clips 580525 1 x soldering iron stand 830008 1 x cup 830000 1 x screw in adaptor (M10) 580010</p>			



Tip Kits & Accessories

These optional kits allow the user to quickly and simply detach the soldering iron from the extraction system. The options are:

- To detach the iron from the main pipework.
- To detach the iron from trunking on the bench.
- To detach the iron from an ON/OFF tap.

Use with Soldering Iron Kits shown on previous page.

Optional - Quick Release Kit

1 x Adaptor 8mm hose 1/4BSP	(580070)
1 x 8mm red blank	(580130)
1 x Adaptor tube 8mm x 65mm	(580300)
Code: 100100	

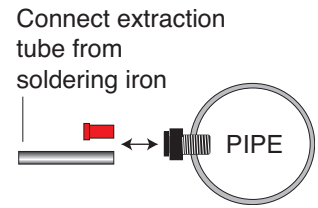

Optional - Trunking Connector Kit (Quick Release)

1 x Adaptor tube 8mm x 65mm	(580300)
1 x 8mm red blank	(580130)
1 x Trunking connector (8mm)	(580190)
1 x 8mm Connector hose stem	(580210)
1 x 1.5m x 6mm ID x 1.5mm wall clear silicone hose	(560030)
1 x screw in adaptor (8mm hose, M10)	(580010)
Code: 100090	

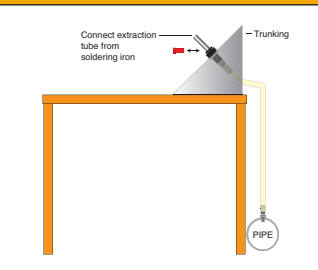

Optional - ON/OFF Tap Kit (Quick Release)

1 x 8mm Connector hose stem	(580210)
1 x 0.04m x 8mm ID x 2mm wall clear silicone hose	(560060)
1 x ON/OFF tap bracket	(580090)
1 x ON/OFF tap	(590078)
1 x 1m x 13mm flexihose	(570000)
2 x Hose clip 15mm	(580500)
1 x Adaptor 12mm hose 3/8BSP	(580035)
4 x Screws	
Code: 300002	

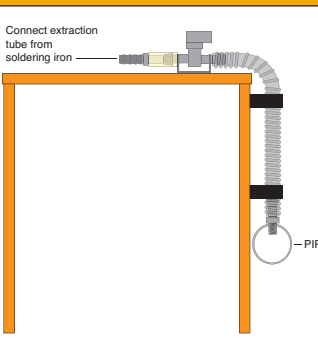

Optional - Tube Cleaning Brushes

Tube cleaning brushes	
5mm bronze	830200
Airflow meter	
5-50 l/min	330200
10-100 l/min	330201





Machine Interfacing

4 way Mini Bulgin



Code: 105097 (5M cable)

ALARM
PINS 1 + 2 = VOLT FREE ALARM OUTPUT CONTACTS

REMOTE START
VOLT FREE CONTACTS REQUIRED TO OPERATE
PIN 3 = REMOTE START INPUT SIGNAL
PIN 4 = +12V DC

5 way XLR Neutric

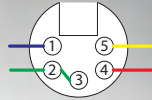

Code: 105105 (5M cable)

ALARM
PINS 1 + 4 = VOLT FREE ALARM OUTPUT CONTACTS

REMOTE START
VOLTAGE SIGNAL REQUIRED TO OPERATE
PIN 2+3 (LINKED) = REMOTE START INPUT SIGNAL
PIN 5 = 0V DC

6 way Bulgin

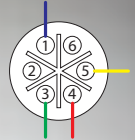

Code: 105103 (5M cable)

ALARM
PINS 1 + 4 = VOLT FREE ALARM OUTPUT CONTACTS

REMOTE START
VOLT FREE CONTACTS REQUIRED TO OPERATE
PIN 3 = REMOTE START INPUT SIGNAL
PIN 5 = +12V DC
PIN 2 + 6 = NOT USED

9 way D-type

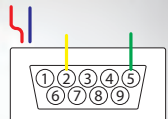

Code: 105106 (5M cable)

ALARM
NO ALARM OUTPUT

REMOTE START
VOLTAGE SIGNAL REQUIRED TO OPERATE
PIN 2 = 0V DC
PIN 3 = +12VDC / +24VDC REMOTE START INPUT SIGNAL

9 way D-type

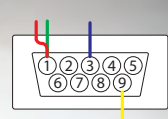

Code: 105107 (5M cable)

ALARM
PIN 3 = +12VDC / +24VDC ALARM OUTPUT

REMOTE START
VOLTAGE SIGNAL REQUIRED TO OPERATE
PIN 1 = REMOTE START INPUT SIGNAL
PIN 9 = 0V DC

9 way D-type



Code: 105104 (5M cable)

ALARM
PINS 1 + 2 = VOLT FREE ALARM OUTPUT CONTACTS

REMOTE START
VOLT FREE CONTACTS REQUIRED TO OPERATE
PIN 3 = REMOTE START INPUT SIGNAL
PIN 4 = +12V DC

6 way Lumberg

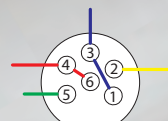

Code: 105096 (5M cable)

ALARM
PINS 1 + 6 = VOLT FREE ALARM OUTPUT CONTACTS
PINS 3 + 4 = VOLT FREE ALARM OUTPUT CONTACTS

REMOTE START
VOLTAGE SIGNAL REQUIRED TO OPERATE
PIN 5 = +12VDC / +24VDC REMOTE START INPUT SIGNAL
PIN 2 = 0V DC INPUT

7 way Lumberg

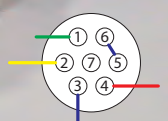

Code: 105098 (5M cable)

ALARM
PINS 3 + 4 = VOLT FREE ALARM OUTPUT CONTACTS

REMOTE START
VOLTAGE SIGNAL REQUIRED TO OPERATE
PIN 1 = +12VDC / +24VDC REMOTE START INPUT SIGNAL
PIN 2 = 0V DC INPUT
PIN 5 + 6 = LINKED
PIN 7 = NOT USED

No Connector



Code: 105108 (5M cable)

Yellow and green wires = remote start stop
Volt free contacts required to close these wires to start (+12VDC signal)

Red and blue wires = alarm signal
Output via a set of volt free contacts inside Purex extractor

Remote ON/OFF Switch

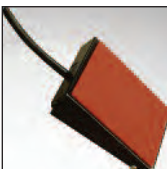

Code: 105114 (5M cable)

Now you can easily switch your Purex fume extractor on or off from up to 5m away. This is particularly useful if your fume extractor is tucked away under a bench or in a cupboard where it cannot easily be accessed. This feature is also useful if the work you do is not continuous e.g. intermittent hand soldering as you will be saving energy by turning the extractor off.

IMPORTANT: Failure to follow the wiring instructions above or hard wiring other cables to your Purex machine will invalidate any warranty and may damage your machine.





Power Plug Options

Note: A plug will be supplied to match the destination region on the order. E.g. an order to go to the UK will be supplied with a UK plug unless you request otherwise.

FumeCube (inc MAX), FumeBuster, FumeSafe, 2tiP and Captivair

Are supplied with a 2m long detachable cable with a choice of plug.

USA/ASIA 120V	UK	Europe	No Plug
			Bare wire only.
Code: 410125	Code: 410100	Code: 410127	Code: 410120

200/400, 200i/400i, 400iPVC, Alpha, Xbase

Are supplied with a 5m long detachable cable with a choice of plug.

USA/ASIA 120V	USA/ASIA 230V	UK	Europe
			
Code: 410160	Code: 410161	Code: 410162	Code: 410163
Australia	No Plug		
	Bare wire only.		
Code: 410164	Code: 410165		

800i, 1500i, 2000i, 5000i

Are factory fitted with a 5m long cable without a plug.

Electrical installations should only be carried out by a qualified person.



Replacement Parts

PART	Blower 230V	Blower 120V	Blower 230V/120V	Blower 220V/400V	PCB Digital Volume	PCB Digital Vacuum	PCB Analogue	FMU Filter Monitor Unit	Inverter 230V/120V	Inverter 220V	Inverter 400V
200	300593	300592			400001	400000		400440			
400	300595	300594			400001	400000		400440			
200i	300593	300592			400001	400000		400440			
200i-HP	300596					400000		400440			
400i	300595	300594			400001	400000		400440			
400i PVC	300595	300594			400001			400440			
800i - 2 Tier	300595 x 2	300594 x 2			400001	400000		400440			
800i - 3 Tier	300595 x 2	300594 x 2			400001	400000		400440			
1500i			300603		400001	400000		400440	400406		
2000i				300612	400001	400000		400440		400394	400396
5000i				300615	400001	400000		400440		400393	400439
Alpha 200	300170	300174					400048				
Alpha 400	300172	300173					400048				
Xbase 200	300170	300174					400048				
Xbase 400	300172	300173					400048				
FumeCube (inc Max)	300170	300174					400048				
FumeBuster	300161	300162					400049				
FumeSafe			300618								
2tiP	300575						400005				
Captivair Max	300588	300589					400007				

When ordering PCBs please supply the machine serial number and connection kit used.



Replacement Fuses

Code: 410246 (For 200, 200i - 120V) & (400, 400i & 400iPVC - 230V)
 Code: 410276 (For 200, 200i - 230V) & (Alpha, Xbase - 230V & 120V)
 Code: 410271 (For 400, 400i & 400iPVC - 120V)



Replacement Manuals

Code: 822005 Digital Manual
 Code: 822006 Analogue Manual
 Code: 822001 Captivair Manual

Download from www.purex.co.uk



Options

Supplied as Standard

1 Machine Selection

Specifying the correct model is vitally important to ensure the extraction rate is sufficient and filtration is optimal.



2 Volume or Vacuum

Digital machines come with the choice of vacuum or volume sensing. Vacuum sensing is for tip and arm applications. Volume sensing is for laser and machine processing.[†]



3 Voltage

All machines are available in a variety of voltages to cater for different regions of the world.



4 Pre-filter

The pre-filter protects the main filter from premature blockage. A wide choice of pre-filter combinations are available from Purex depending on your application.



5 Main Filter

A wide choice of main filter combinations are available from Purex depending on your application.



6 Connection Kit

Connect the extractor to pipe work or to another machine such as a laser or reflow oven.*

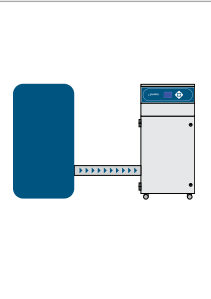

Optional

7 Additional Filtration

Some applications may require additional filter capacity, for example the Cascade filter can extend the life of other filters in problematic applications.



8 Accessories

Accessories include arm, tip and pipework kits.



9 Remote ON/OFF

Switch your Purex fume extractor on/off from up to 5m away. This is particularly useful if your fume extractor is tucked away under a bench where it cannot easily be accessed.



10 Interface Kit

The Purex machine can control or be controlled by another machine such as a laser or reflow oven. Options include: ON/OFF control and filter blocked warnings.

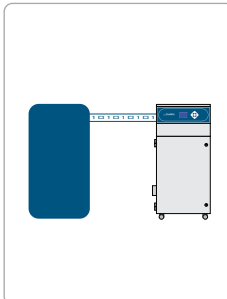

11 Installation

Correct installation is essential to aid compliance with health and safety regulations and to protect your people and process.

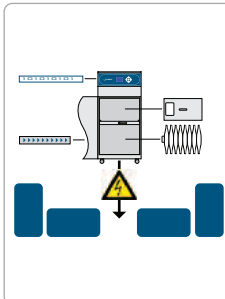

12 LEV Testing

LEV testing is also essential to aid compliance with health and safety regulations and to protect your people and process.



[†] Digital machines offer volume or vacuum sensing, all other machines are vacuum sensing only. *Not all machines are supplied with a connection kit as standard, please check the individual product page for details. For more help and information please contact Purex or your local representative



Pre-Filters

Pre-filters are designed to capture larger particles before they can enter the main HEPA filter.

Without pre-filters, the life of the main filter would be much shorter.

A variety of media and designs are available to allow Purex extractors to be used in a wide range of processes.

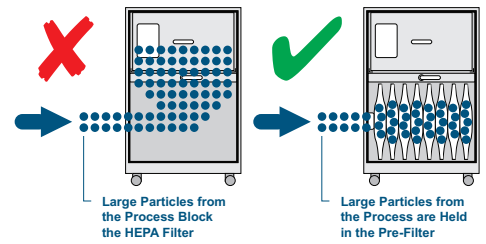

Pads

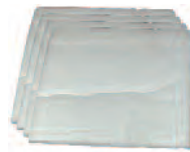
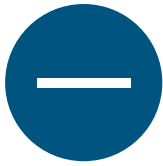

Pad pre-filter

- Extends the life of the main filter by capturing larger particles before they reach the HEPA filter
- Fits neatly under the main filter
- Graduated fibre matrix delivers excellent particle capture capacity
- Ideal for low volume applications or where small amounts of particles are produced

Labyrinth



Patented Labyrinth pre-filters

- Extends the life of the main filter by capturing larger particles before they reach the HEPA filter
- Fits neatly under the main filter in integral Purex extractors
- Graduated fibre matrix delivers excellent particle capture capacity - up to 20 times more than a standard filter
- Ideal for medium-high volume applications
- Can deal with sticky or moisture laden particles
- Composite material available for extra filter life and filtration down to 0.5 micron
- Contains the particles inside for clean and simple disposal

Pleated Bag



Pleated bag pre-filter

- Extends the life of the main filters by capturing larger particles
- Used in Purex 5000i machines
- Provides additional particle capturing capacity
- Ideal for processes where large amounts of particles are produced
- Contains the particles inside for clean and simple disposal

Cascade

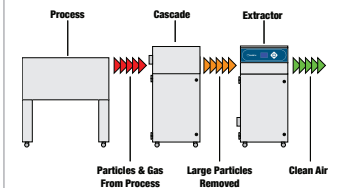

Cascade heavy duty inline filter

- Extends the life of the pre-filter by capturing larger particles
- Fits between the process and the Purex machine
- Provides additional particle capturing capacity
- Ideal for processes where large amounts of particles are produced
- Can be emptied and reused
- Can be powder seeded for extra life in difficult applications
- Contains the particles inside for clean and simple disposal





Main Filters

Purex use specialised combinations of filter media to capture particles, gases and vapours generated by industrial processes such as laser engraving, laser marking, hand and machine soldering, ink jet printing and many others. Each filter has a unique serial number and is individually tested and certified to ensure performance and safety.

Purex HEPA (High Efficiency Particulate Air) filter elements are precision manufactured from a pleated material that incorporates reinforcing strips which separate the pleats and help prevent airflow vibration or collapse.

Additionally, air equalisation plates are used between the layers of media to further reinforce the filter housing and to distribute the airflow across the filter to ensure all of the filter media is used.

Typical Filter

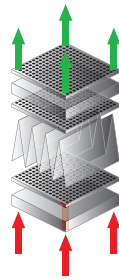

Chemical

Adsorbs a wide variety of gases and vapours.

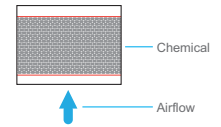

HEPA/Chemical

Filters small particles @ 99.997% down to 0.3 microns in size and adsorbs a wide variety of gases and vapours

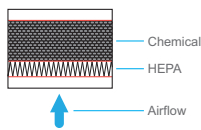

HEPA/Twin Chemical

Filters small particles @ 99.997% down to 0.3 microns in size and adsorbs a wide variety of gases and vapours particularly from rubber engraving or acidic gas applications.

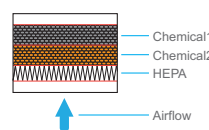

HEPA/PVC Chemical

Filters small particles @ 99.997% down to 0.3 microns in size and adsorbs gases and corrosive vapours generated when PVC is laser processed.

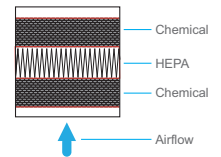

HEPA/CSA

Heavy duty filter for laser engraving rubber.

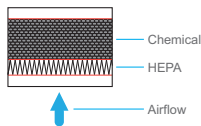

CSA

Adsorbs a wide variety of gases and vapours.

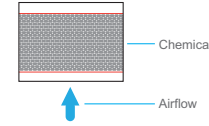

HEPA

Filters small particles @ 99.997% down to 0.3 microns in size.

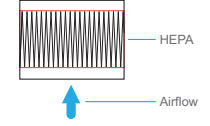

HEPA/Chemical Cleanroom

Adsorbs a wide variety of gases and vapours and filters small particles @ 99.997% down to 0.3 microns in size. Specially designed for use in cleanrooms. (Use F8/F9 pre-filters.)

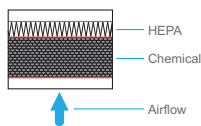

Solvent Lock

Adsorbs gases and vapours generated by ink jet printing and certain solvent applications.

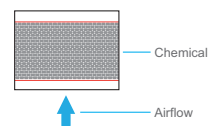

Pleated Bag

Filters small particles from the airstream. Replaces the HEPA filter in certain machines and applications.

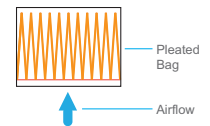



Digital Control System

*“The Ultimate in Advanced Control,
Monitoring, Performance and Safety Features”*

WATER PROOF FASCIA

GRAPHIC DISPLAY

MENU BUTTONS

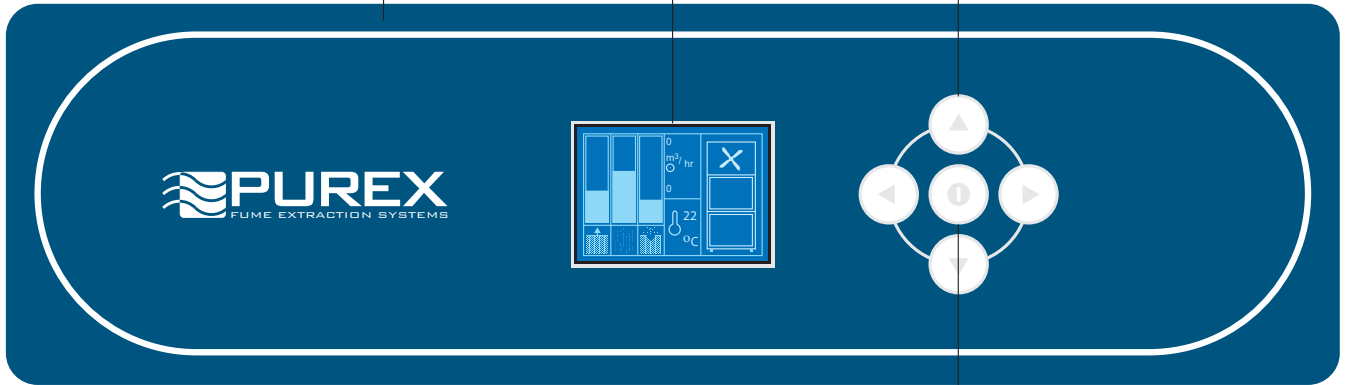

ON/OFF SWITCH

A dedicated control, monitoring and display system unique to Purex fume extractors. All functions are fully automatic, all the user has to do is set the appropriate airflow on installation.





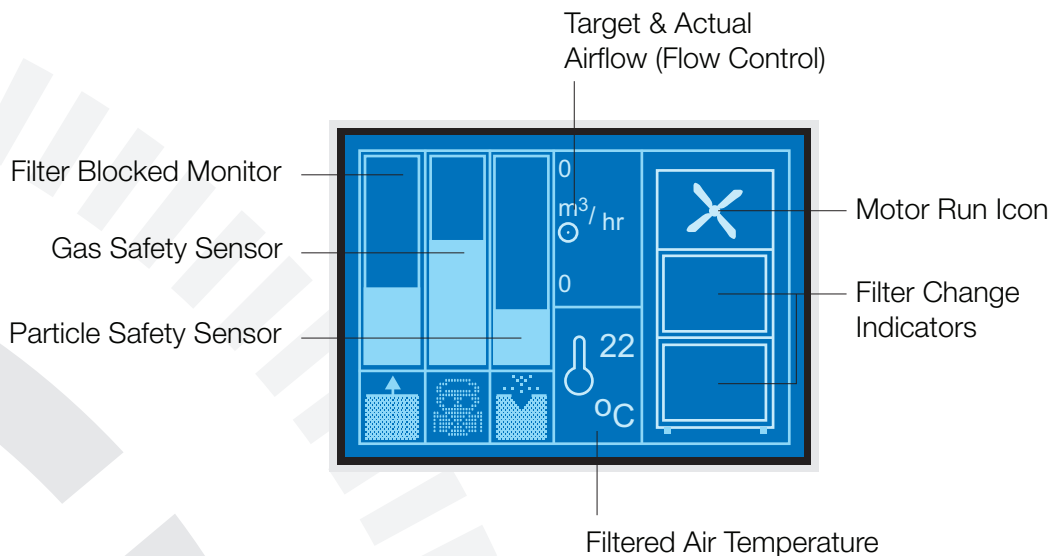



The many features of this system are designed to:

- Protect people by constantly monitoring exhaust emissions.
- Maintain a constant airflow and lower energy consumption by using variable speed motors which also allow the use of a fully automatic flow control system.
- Show the operator at a glance the status of the machine via an advanced graphic display.





Digital Control System

Gas Sensors	Particle Sensors	Speed Control	Flow Control
<p>Constantly monitors the chemical filters to warn the user when they are nearly saturated. This helps reduce downtime by allowing the user time to make replacement filters ready. Gas sensors also warn the user if hazardous gas is passing through the system, e.g. due to a missing, damaged or incorrectly fitted filter.</p> 	<p>Constantly monitors the particle filters to warn the user if hazardous particles are passing through the system, e.g. due to a missing, damaged or incorrectly fitted filter.</p> 	<p>The user can set the required airflow for the process. The motor will automatically speed up or slow down until the “actual” airflow equals the “required” airflow.</p> <p>This system is energy efficient as the motor does not have to constantly run at 100%. It also means the machine is quieter and the filters last longer.</p> 	<p>Purex “Flow Control” automatically increases the speed of the motor as the filter blocks to keep extraction constant and ensure fumes are captured effectively throughout the life of the filter.</p> 
Filter Status	Filter Indicator	Temperature	Interfacing
<p>Constantly monitors the particle filters to warn the user when they are nearly full. This helps reduce downtime by allowing the user time to make replacement filters ready.</p> 	<p>If a filter is nearly blocked or if the gas or particle alarms are triggered, this icon will show which filters may need attention.</p> <p>This makes it easier and quicker for the user to identify where the problem may be. This icon also indicates to the user when the motor is running.</p> 	<p>An adjustable alarm to warn if the filtered air temperature goes above a certain level.</p> 	<p>Allows the Purex unit to communicate with associated equipment such as lasers or reflow ovens etc. Options:</p> <ul style="list-style-type: none"> • Synchronised STOP/START • Automatic run on (extraction continues for a set period after associated equipment is stopped.) • Filter Alarm Signals • Several connection types • Remote ON/OFF switch 

FEATURE LIST	Graphic Display	Gas Sensor	Particle Sensor	Filter Indicator	Temp Warning	Machine Interfacing	Speed Control	Flow Control	Filter Life Warning	Coated for PVC use	Air Compressor
200/400	●	●	●	●	●	■	●	●	●	■	■
200i/400i (inc HP)	●	●	●	●	●	■	●	●	●	■	■
400i PVC	●	●	●	●	●	■	●	●	●	●	■
800i 2-Tier	●	●	●	●	●	■	●	●	●	■	■
800i 3-Tier	●	●	●	●	●	■	●	●	●	■	■
1500i/2000i	●	●	●	●	●	■	●	●	●	■	■
5000i	●	●	●	●	●	■	●	●	●	■	■
Alphas (inc Dust)*	-	-	-	-	-	■	●	●	●	-	■
Xbase*	-	-	-	-	-	■	●	●	●	-	■
FumeCube (inc MAX)*	-	-	-	-	-	■	●	●	●	-	-
FumeSafe*	-	-	-	-	-	-	●	●	●	-	-
2tiP*	-	-	-	-	-	-	●	-	●	-	-
FumeBuster*	-	-	-	-	-	-	-	-	●	-	-
Captivair*	-	-	-	-	-	-	-	-	●	-	-

- Supplied as standard.
- Optional.
- Not applicable
- * Analogue control system only



Terms & Conditions

1. Contract

1.1 All quotations given, orders accepted and contracts entered into by Porex International Limited ("Porex") with any person ("Purchaser") for supply of goods ("Goods"), or for services ("Services") are subject to these conditions of sale ("Conditions"). All other terms and conditions, whether expressly stipulated by the Purchaser or implied by trade custom, course of dealing or otherwise are excluded. No variation to these Conditions will be effective unless agreed in writing by an authorised representative of Porex.

1.2 No quotation, estimate or proposal issued by Porex is an offer that is capable of acceptance by the Purchaser. Any order issued by the Purchaser shall be deemed placed subject to these Conditions and shall constitute an offer that Porex may accept or reject. The contract between Porex and the Purchaser ("Contract") shall be formed at the time Porex accepts the Purchaser's order. Porex may accept the Purchaser's order by issuing an order acknowledgement or by other means, including commencing the supply of Goods or the performance of Services. No amendments to the Purchaser's order shall be valid unless agreed in writing by an authorised representative of Porex.

2. Order and Specifications

The Purchaser shall be responsible to Porex for ensuring the accuracy of the terms of any order, including any applicable specification, submitted by the Purchaser, and for giving to Porex any necessary information relating to the Goods or Services within a sufficient time to enable Porex to perform the Contract in accordance with its terms. The specification for the Goods or Services shall be that set out in the Purchaser's order or as otherwise agreed in writing by Porex. Should an order be cancelled by the Purchaser within 2 months of the relevant delivery date Porex reserves the right to impose a reasonable cancellation charge.

3. Price and Payment

3.1 The price of Goods and Services shall be the price quoted by Porex. Quoted prices shall remain valid for 30 days. Prices do not include carriage and packing which will be charged at cost plus a handling fee unless otherwise specified in writing. Express or Special Delivery at the Purchaser's request will always be at the Purchaser's expense. Prices do not include VAT.

3.2 Unless otherwise agreed in writing payment of invoices shall be made in full without any deduction or set-off within 30 days of the invoice date. Payment shall be due whether or not property in the Goods has passed. Time for payment shall be of the essence. If the Purchaser fails to pay Porex any sum due pursuant to the Contract, the Purchaser shall be liable to pay interest to Porex on such sum from the due date for payment at the annual rate of 4% above the base lending rate from time to time of The Bank of England, accruing on a daily basis until payment is made, whether before or after any judgement. Porex reserves the right to claim interest under the Late Payment of Commercial Debts (Interest) Act 1998. Porex may also, without prejudice to any other remedy suspend or cancel further supply of Goods or performance of Services whether under this or any other Contract until the Purchaser makes payment in full together with any applicable interest.

4. Delivery

4.1 Delivery of the Goods shall unless otherwise agreed be made by Porex delivering the Goods to the location specified in the Purchaser's order or by the Purchaser collecting the Goods at Porex's premises.

4.2 Any dates or times for delivery of Goods and performance of the Services are approximate only. Porex shall use reasonable endeavours to meet such dates or times but so long as it uses such reasonable endeavours Porex shall not be liable to the Purchaser, in contract, tort, negligence or otherwise for any loss or damage whatsoever resulting from any late delivery or performance.

4.3 Where the Goods are delivered by instalments, any breach by Porex in respect of any one or more instalments shall not entitle the Purchaser to terminate the Contract in whole or in part.

4.4 Upon receipt of the Goods the Purchaser shall examine them and shall within 48 hours of such receipt give notice in writing to Porex of any apparent defects and/or shortages. The parties will agree between themselves such further action as may be necessary to remedy the defect and/or shortage. Porex shall not be liable for any such defects and/or shortages notified to it after the period of 48 hours after receipt.

5. Risk and Title

5.1 Risk of damage to or loss of the Goods shall pass to the Purchaser when Porex delivers the Goods to the Purchaser or, if the Purchaser collects the Goods from Porex, when the Goods are loaded onto transport at Porex's premises.

5.2 Notwithstanding the passing of the risk, Porex shall retain title to and ownership of the Goods until it has received payment in full of all sums due for the Goods.

5.3 Until title in the Goods has passed to the Purchaser, the Purchaser shall be in possession of them as a bailee of the Goods for Porex and shall store the Goods, properly insured and protected, separately from any Goods belonging to the Purchaser or any third party and shall be clearly marked and identifiable as being Porex's property. Porex shall be entitled to enter the Purchaser's premises upon reasonable notice to verify the Purchaser's compliance with this clause. If the Purchaser fails to make any payments to Porex when due, or any of the circumstances set out in Clause 8.2 arise, then Porex will have the right, without prejudice to any other remedies: 5.3.1 to enter, without prior notice, any premises where Goods owned by Porex may be, and to repossess and dispose of any such Goods; and/or 5.3.2 to require the Purchaser not to resell or part with possession of any Goods owned by Porex until the Purchaser has paid in full all sums due to Porex under this or any other Contract.

5.4 The Purchaser shall not be entitled to pledge or in any way charge by way of security for any indebtedness any of the Goods which remain the property of Porex and if the Purchaser does so all monies owing by the Purchaser to Porex shall (without prejudice to any other right or remedy of Porex) forthwith become due and payable.

6. Warranty & Liability

6.1 Goods manufactured by Porex: Porex warrants that the Goods manufactured by it will be free from defects in materials and workmanship for a period of 12 months from the date of installation or 15 months from the date of despatch from Porex's premises, whichever period expires earlier. Exceptions: Spare parts including replacement filters: 3 months from installation or 4 months from despatch Used and ex-demonstration equipment: 3 months from installation or 4 months from despatch In the case of any breach of warranty then Porex shall at its option remedy such defects or refund such sums as the Purchaser has paid to Porex in respect of such Goods. Porex shall be under no liability under the above warranties:

6.1.1 arising from any drawing, design or specification supplied by the Purchaser; 6.1.2 arising from improper installation, storage, use, modification or operation including but not limited to the use of consumable items not approved by Porex;

6.2 Goods manufactured by third parties: Porex will use its best endeavours to obtain for the purchaser the benefit of any warranty provided by the original manufacturer of the Goods. Repair or replacement, in whole or in part, of Goods which fail due to faulty manufacture is available from the original manufacturer under its warranty. Porex must be consulted to approve the return of Goods for replacement or repair under the original manufacturer's warranty.

6.3 All replacement items will be charged at the point of despatch. Provided the original items are received back at Porex within 28 days from the date upon which the Returns Authorisation Number is issued and Porex agree following testing / inspection that these are defective, a credit note will be issued.

6.4 Services: Porex warrants that it will carry out the Services with reasonable care and skill. If Porex is shown to be in breach of this warranty in respect of particular Services it shall at its option and cost either re-provide those Services or refund any sums already paid in respect of those Services.

6.5 Porex does not exclude or limit its liability in negligence for death or personal injury, or for fraud or wilful default, or otherwise to the extent that any exclusion or limitation of its liability is void, prohibited or unenforceable by law.

6.6 Subject to Clauses 6.1 - 6.5, all representations, warranties and conditions implied by trade custom, course of dealing, statute, common law or otherwise are excluded to the fullest extent permitted by law.

6.7 Subject to Clause 6.5, in no circumstances shall Porex be liable to the Purchaser, in contract, tort, negligence or otherwise, for any incidental or consequential loss including, without limitation, any loss of profit, business, revenue, goodwill or anticipated savings or for any special, exemplary or consequential damages or other financial loss whatsoever arising out of or in connection with the Contract or the supply of the Goods or Services or their use or resale (if applicable) by the Purchaser.

6.8 If notwithstanding the provisions of these Conditions Porex is found liable for any loss suffered by the Purchaser arising in any way out of or in connection with the Contract or the supply of any Goods or Services, that liability shall in no event exceed the price paid for such Goods or Services.

6.9 The parties hereby confirm that notwithstanding any other provision of the Contract or these Conditions, the Contract shall not and shall not purport to confer on any third party the right to enforce any term of the Contract for the purposes of the Contracts (Rights of Third Parties) Act 1999.

6.10 Porex and third party Software

6.10.1 Software is licensed (or sublicensed, in case of third party Software) by Porex to the Purchaser.

6.10.2 Porex warrants that the media on which the Software is recorded is free from defects in material and workmanship under normal use for a period of thirty days from the date of despatch.

6.10.3 Porex warrants that any Porex Software will perform in substantial compliance with the specification for a period of 90 days from installation.

6.10.4 Porex warrants that any third party Software will perform in substantial compliance with the Software documentation issued by the original manufacturer of the Software and for the period specified therein.

6.10.5 Porex (and, where applicable, the original manufacturer of the Software) do not warrant that the functions contained in the Software will meet Purchaser's requirements or operate in the combination that may be selected for use by Purchaser, that the operation of the Software will be uninterrupted or error-free or that all defects in the Software will be corrected.

6.10.6 The entire liability of Porex (and, where applicable, of the original manufacturer of the Software) shall be, at Porex's option, either:

(a) Return of all sums paid by the Purchaser for the Software, or (b) Replacement of the Software or media that does not meet Porex or the original manufacturer limited warranty and which is returned to Porex under its return policy.

6.10.7 Any replacement Software or media will be warranted for the remainder of the original warranty period or 30 days, whichever is longer.

7. Force Majeure

Porex shall not be deemed in breach of the Contract or otherwise liable to the Purchaser, by reason of any delay in performance, or non-performance of its obligations under the Contract to the extent that such delay or non-performance is caused by an event or circumstance beyond Porex's reasonable control. In such events Porex may, without liability to the Customer, reasonably vary the terms of the Contract including but not limited to extending the time for performing the contract by a period of at least equal to the time lost due to such an event.

8. Termination

8.1 Porex may at any time by notice in writing to the Purchaser terminate the Contract with effect from the date of service of such notice if:

8.1.1 The Purchaser commits a material breach of the Contract and fails to remedy such breach within 14 days after Porex has given written notice to the Purchaser identifying the breach and requiring it to be remedied; or 8.1.2 The Purchaser is unable to pay its debts as they fall due within the meaning of Section 123 of the Insolvency Act 1986 or if any petition is presented for the appointment of an administrator or receiver or trustee in bankruptcy in respect of the Purchaser or any part of its undertaking or assets or an administrative receiver is appointed in respect of any of the Purchaser's undertaking or assets or if the Purchaser makes or attempts to make any arrangement with or for the benefit of its creditors or if the Purchaser ceases or threatens to cease to carry on business.

9. Miscellaneous

9.1 The expressions "in writing" and "written" include fax transmission. Porex shall be entitled to sub-contract any or all of its obligations under the Contract and to assign the Contract and the Customer shall at Porex's cost do all such things as may be necessary to enable Porex to so assign the Contract. Any failure or neglect by Porex to enforce at any time any provision of the Contract shall not be construed nor deemed to be a waiver of any of Porex's rights under the Contract. The Contract shall be governed by and construed in accordance with English law and the parties hereby submit to the exclusive jurisdiction of the English courts in relation to any claim or controversy arising out of or connected with the Contract.

9.2 New Accounts: Credit accounts cannot be opened under the minimum amount in operation at the time of placing the order. Customer's wishing to open a credit account must furnish two trade references and a Bank reference.

9.3 Specification Alterations: Porex reserves the right to alter the specification of any goods without prior reference to the Purchaser provided that the goods comply in all other known respects with the Purchaser's requirements.

9.4 Trade-Marks / Patents: The supply of goods by Porex shall not confer any right upon the Purchaser to use any Porex trade-mark without prior written consent of Porex and at all times such trade-mark shall remain the property of Porex. Neither does it imply any right to use any Porex patent or any indemnity against infringement of third party patents.

9.5 Catalogues: Catalogues and other advertising matter are issued to indicate the type and range of goods we offer and no particulars therein are binding to Porex.



Filter Matrix

MACHINE	PRE-FILTERS								MAIN FILTERS									
	Pad F5	Pad F6	Pad F8/F9	Pad Adsorbent PVC	Pleated Bag	Labyrinth F6	Labyrinth F8	Labyrinth F8/F9	Cascade	HEPA Chemical	HEPA Twin Chemical	HEPA Chemical Cleanroom	Chemical Std	HEPA	Chemical Special	Pleated Bag	HEPA CSA	Solvent Lock
200/400	202260#									113505 113505H	113579Δ	113512	113508	113809	113662 113505P≈	113531		113513
200i/400i					202268*			202271*		113505 113505H	113579Δ	113512	113508	113809	113662	113531		
200i-HP								202271*		113811†								
400i PVC				200261#				202271*		113498								
800i 2-Tier				200262#		202280*		202272*		113652	113660Δ	113658						
800i 3-Tier				200262#				202273*										113667
1500i/2000i				200281#		111037		111099		110615	110614Δ	110632	110610	113650				
5000i	200310#			200312#		111072	111144	111006					110627 110624†	110633	110645			
FumeCube	200225#	200226#	200316#							110536		110538	110537		≈110544			110543
FumeCube Max								111124		110507			110504					
FumeBuster	200314#		200098#							110531		110533	110532		110542			110541
FumeSafe	See note.		200098#							110531		110533	110532		110542			110541
2 Tip	200225#	200226#								110507								
Alpha					202269*			202274*		113505 113505H	113579Δ	113512	113508	113809	113662	113531		
Alpha Dust					202268*			202271*										
Xbase								202276*		110545							113585	
Capitvair (Refill)													113800 113805					
Cascade Box								111117	111107									

* Pack of 2 • # Pack of 4 • All other filters sold in singles • † Heavy Duty • Δ Rubber Engraving • ≈ Acidic Fumes • Note: The FumeSafe has an exhaust filter 200093

"Protecting People and the Environment with Innovative Technology"

www.purex.co.uk

 **PUREX**
FUME EXTRACTION SYSTEMS

T: +44 (0)1709 763000

F: +44 (0)1709 763001

E: purex@purex.co.uk

W: www.purex.co.uk

Registered Office. Purex International Ltd. Purex House, Farfield Park,
Manvers, Rotherham, S63 5DB. Registered No. 5136616 England.
VAT No. GB842 5025 49 • WEEE Producer Registration Number: WEE/CE0067TX

