

BUNDLEBOARD G PANEL QUICK START GUIDE

1



Turn on System

Power Indicator: At the bottom right hand side of your panel frame there is a series of buttons. The first button on the left is the power button. When powered on, the indicator light will turn green.

2

Overview

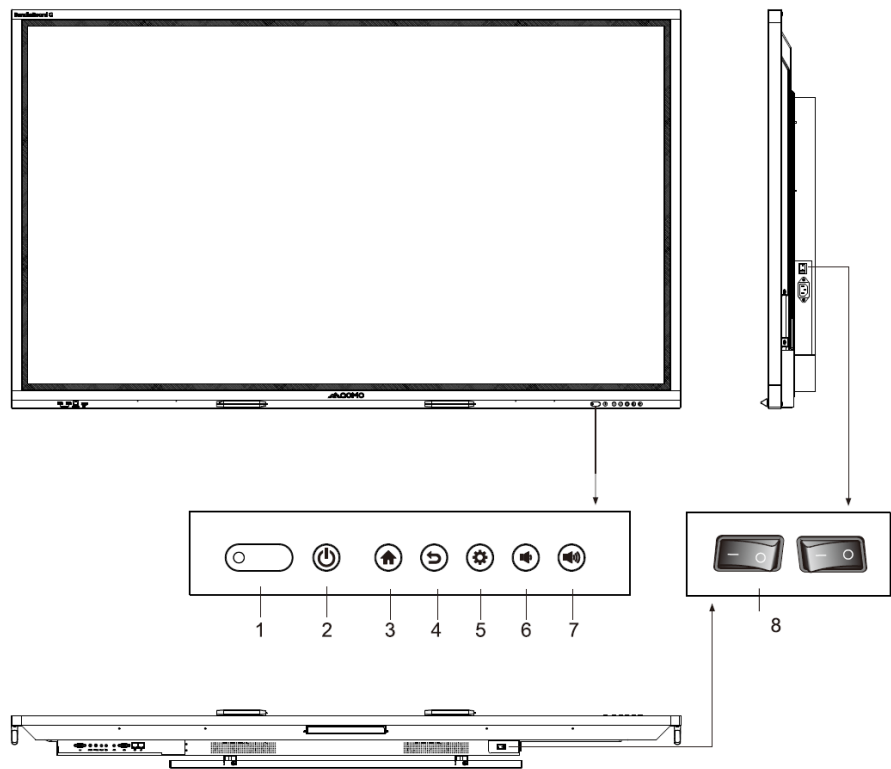

1. Indicator light, remote control receiver and light sensing receiver;
2. :Power;
3. : Homepage
4. : Return and touch unlock;
5. : Setting;
6. :Vol-;
7. : Vol+;
8. Switch.

3

Accessories

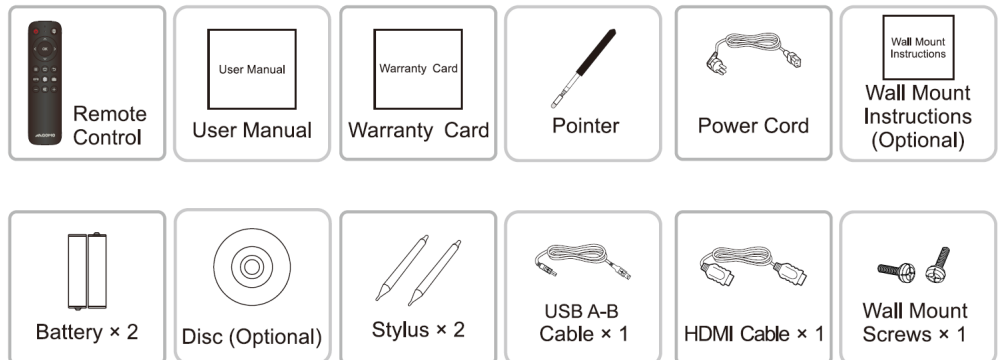

4

Remote Control

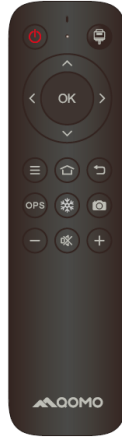

KEY	Function
POWER (⏻)	Switch between power-on and standby states
SOURCE (📡)	Open / close the signal source list
NAVIGATION KEYS (<> ^ v)	Select or adjust menu options
OK (OK)	Confirm the operation
MEUN (☰)	Show/hide the main menu
HOME (🏠)	Display the Android home page
BACK (⏪)	Return to the previous interface
OPS	Switch to OPS source
FREEZE (❄️)	Enable or disable freeze function in the system
SNAPSHOT (📷)	Take a screenshot
VOL- (⏮)	Decrease the volume
MUTE (🔇)	Enable/disable sound
VOL+ (⏭)	Increase the volume

1.The picture is for reference only, subject to the actual remote control.
2.Functions of keys on the remote control may vary, subject to actual functions.

5

Android Home Page

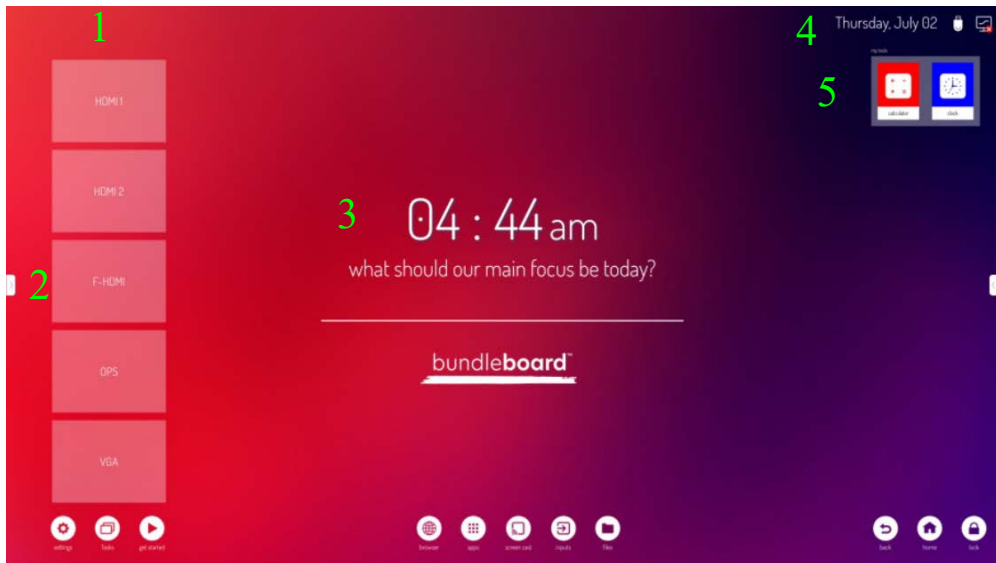

1. Inputs
2. Annotation
3. Time & Subject
4. Date & Wifi
5. Calculator & Timer
6. Settings
7. Show Running Apps
8. Get Started
9. Internet Browser
10. Additional Apps
11. Wireless Screen Cast
12. Inputs
13. File Manager
14. Back
15. Home
16. Lock

6 7 8

9 10 11 12 13

14 15 16

6

Renaming Inputs of Home Screen



Tap and hold front page side input button to rename

7

Set Start Up Channel

Setting up default input to power on to

1. Use remote control to select source (top right button), or click on "input" on swipe up menu
2. Click on "Source Settings" and select "Boot Source"
3. Change to the desired and most frequently used input source

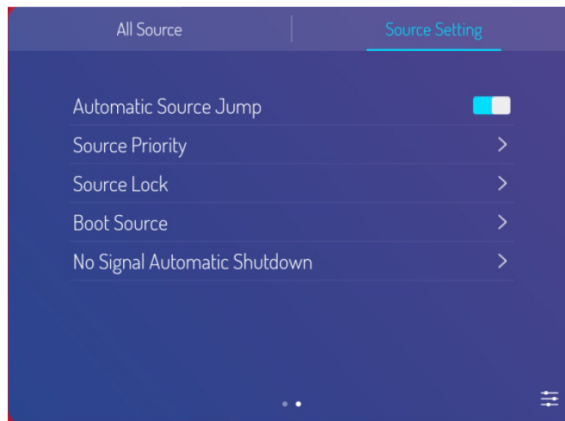

Settings

7



- | | |
|-----------------------------|----------------------------------|
| 1. Wifi Settings | 8. Set Wallpaper |
| 2. Time & Language Settings | 9. Set Screensaver |
| 3. General System Settings | 10. Set Background for No Signal |
| 4. Touch Settings | 11. Count Down |
| 5. Power Settings | 12. Set/Change Password |
| 6. Device Information | 13. Lock Screen Upon Boot Up |
| 7. App Management | 14. Factory reset |
| | 15. Auto Check for Updates |
| | 16. Manually Check for Updates |

7

Program Shut-Down Time

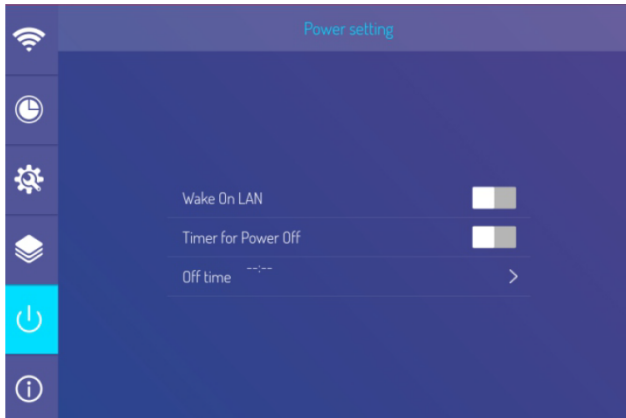

Schedule an automatic shut down time to save energy by clicking on "Off time" under Power settings.

8

File Explorer

Access and save files (image, videos, pdf, etc) onto the screen by clicking on the file icon on the bottom swipe up menu.

Hold and press the icon inside the file explorer to move, copy, or delete.

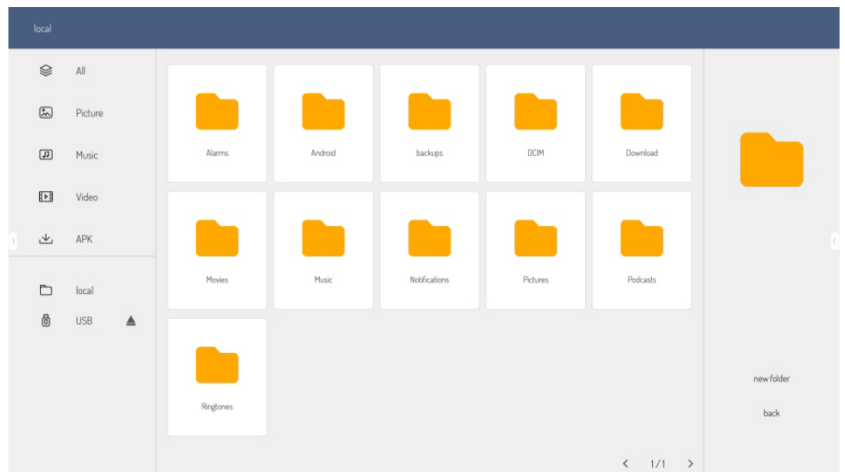

9

Whiteboard Annotation

Access pre-installed whiteboard app in side bar menu, or from apps page.

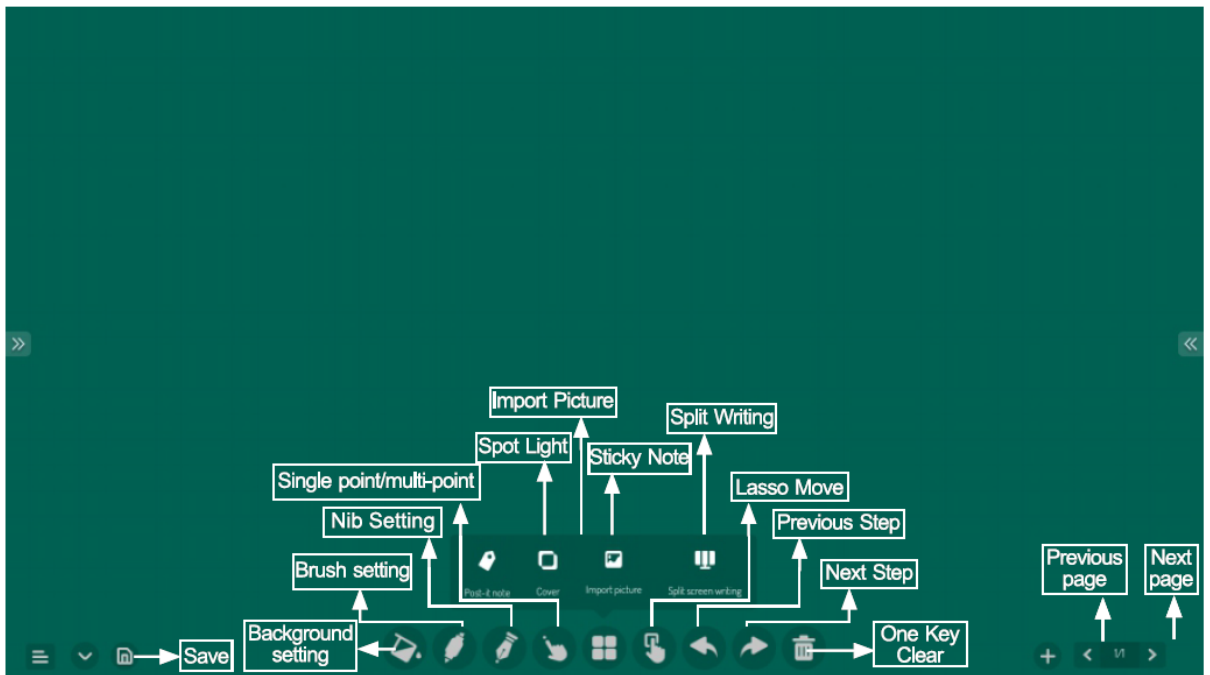

10

Overlay Annotation

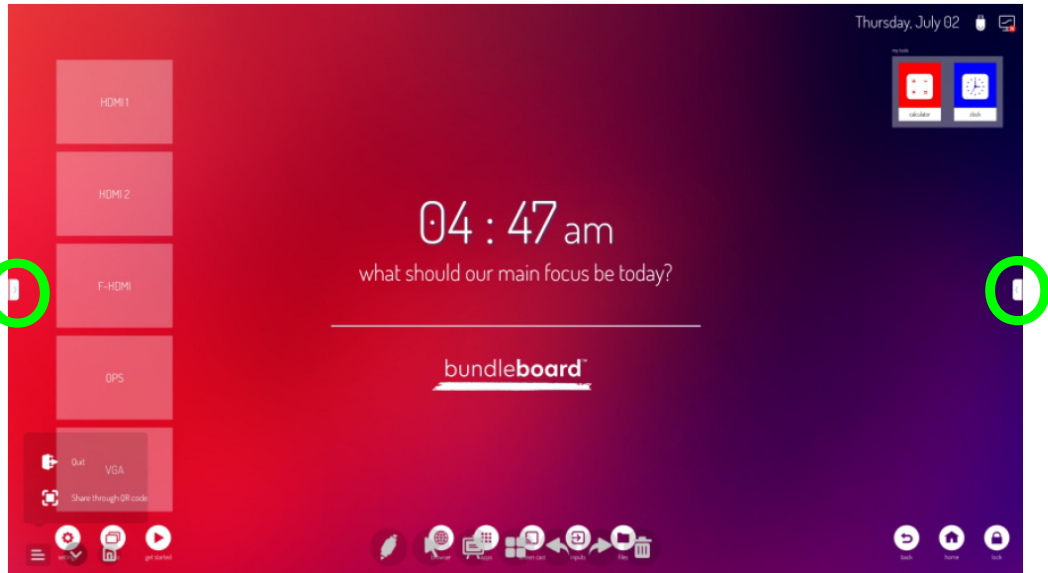

Annotate on top of any screen by clicking side arrow
 Save content through the annotation app

Note: The overlay annotation feature screen shots the document, it does not actually write inside the document

11

EShare App

EShare is a screen casting tool for smart phones, computers and tablets. Cast up to 4 different devices to screen. Windows and Mac devices enables touch control on the interactive screen.

1. Click on casting icon shown below

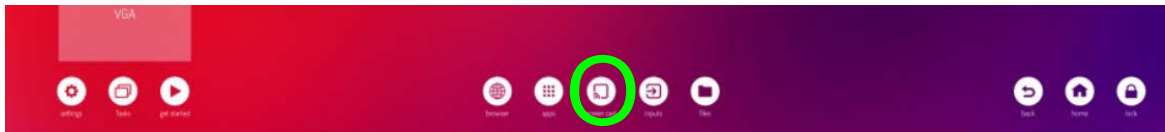

2. Also available by clicking apps, then the following icon



3. Install EShare on device such as computer or tablet by visiting eshare.app
4. Ensure all devices are connected to the same WIFI network.
5. Launch EShare on device and select EShare name shown on the panel.

12

Connecting Devices

1. Connecting Your External Computer

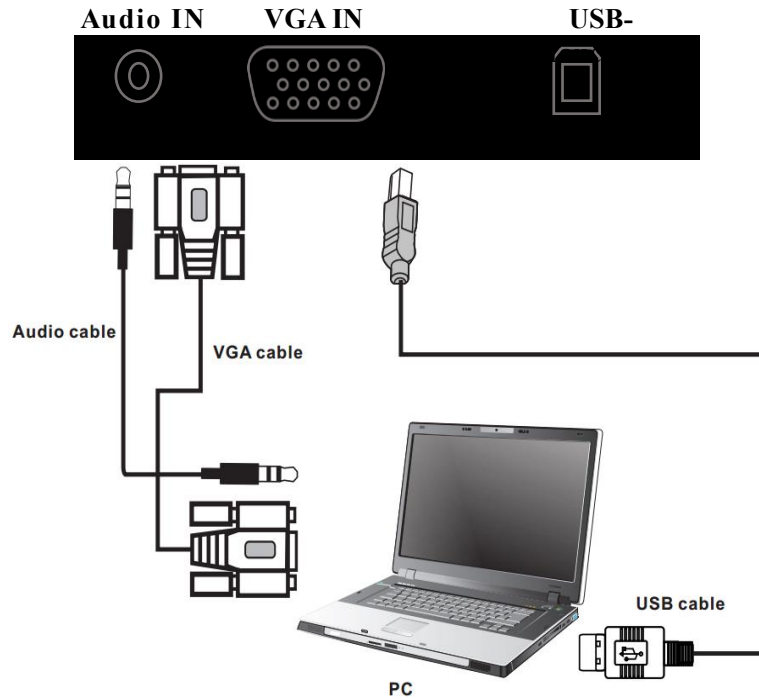

Connect your computer using a USB touch cable, VGA Cable and Audio Cable, HDMI Cable or DP Cable.

2. Outputting Display

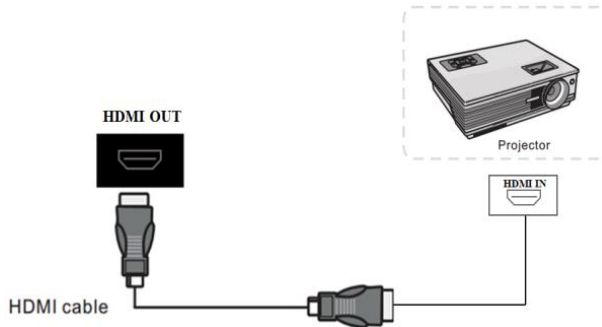

You can output your BundleBoard G panel to other displays through the HDMI port.

3. AV Connecting(HDMI IN)

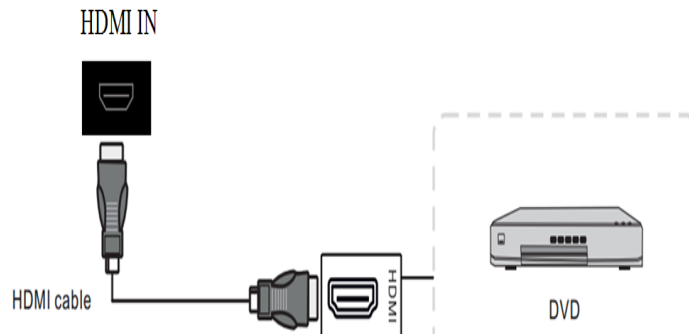

Connect other external devices to the panel such as a DVD player or Camera using the HDMI port.

ENJOY YOUR BUNDLEBOARD G

For Additional Help

Contact us at support@qomo.com

or 248-960-0985

Visit us at www.qomo.com for training videos and more!