

QUICK TRAINING GUIDE: MO-1

1 Configure your classroom

Basic Configuration

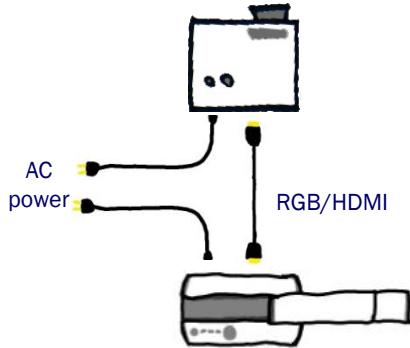

With Computer

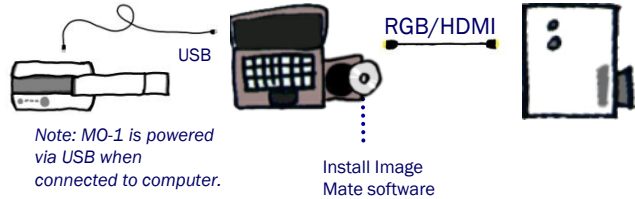

Rear panel

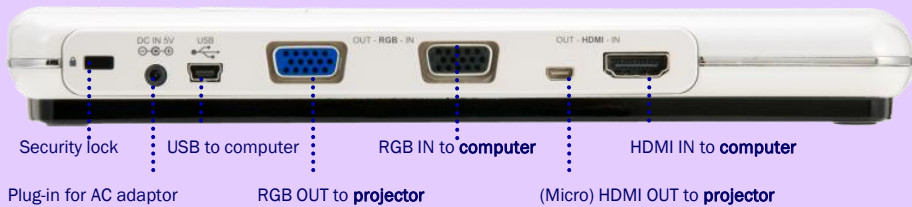

2 Power on the MO-1, Zoom and Focus

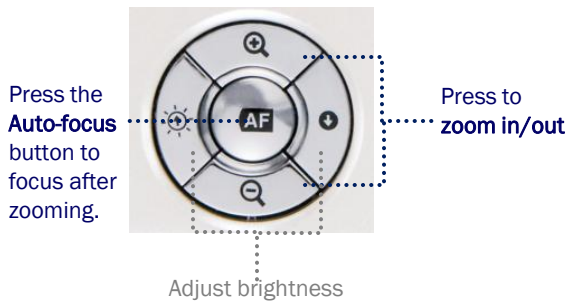

3 Rotate

Rotate the camera arm close to a small object, turn the camera head horizontally to view students giving a presentation, speech, etc.

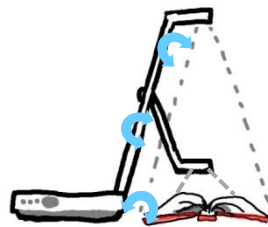

Rotate the camera head to when using MO-1 as web cam.

4 Capture and Review

Press to view image from HDMI/RGB/USB or view computer desktop

A. Insert SD card

Capture the image of worksheets, student work, etc. and save them on the SD card. Quickly and easily review later during class by pressing the SD button.

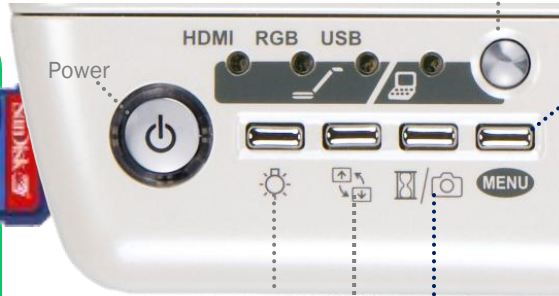

C. Review saved images

Press Menu then use the []·[]·[]·[] and AF buttons to highlight and select the SD card icon. You can now view and select any saved image.

B. Capture image

Hold down for longer than 1 second to capture image. To pause the image, hold down for less than 1 second. Push again to unfreeze the image.

5 Install Image Mate software

Install Image Mate software (ensure MO-1 is disconnected during installation). Connect the MO-1 to the computer and open Image Mate. You will now be able to **annotate on the live image, save images and videos to the computer, record time-lapse photography** (set interval time in Settings before beginning time-lapse).

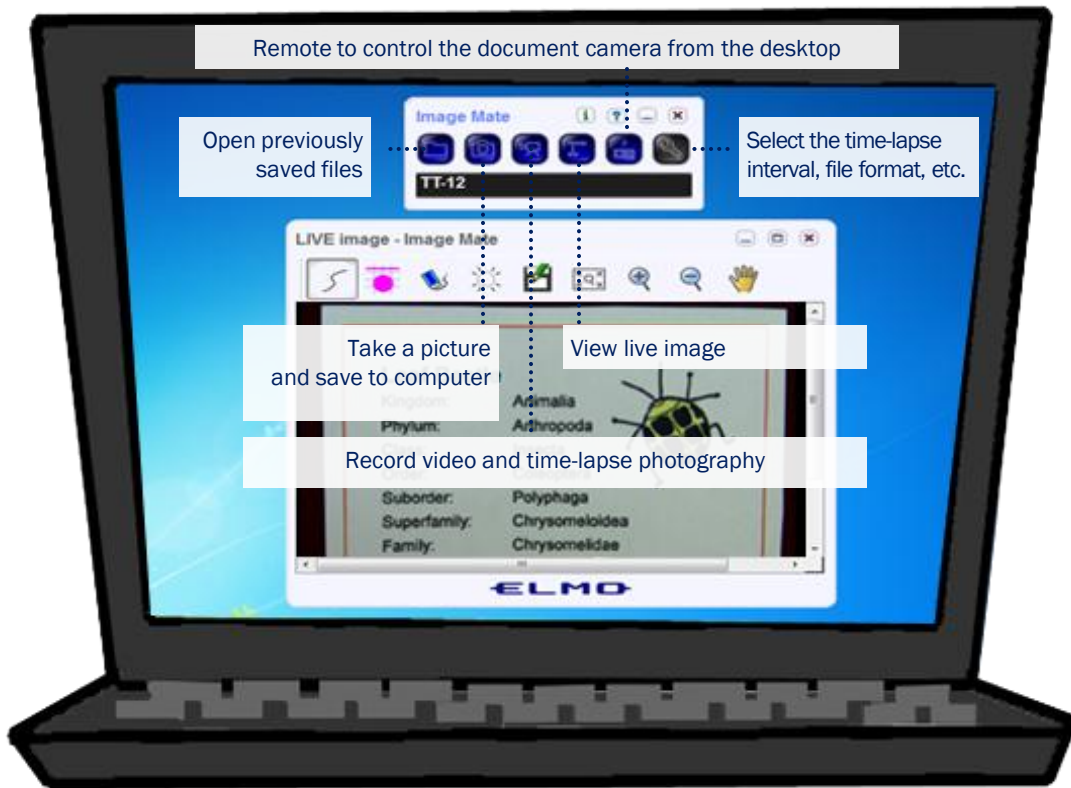

Download Image Mate at <http://www.elmoua.com/support/101>