

**HIGH-  
TONNAGE  
CYLINDERS**

RLL, RCX, RCG,  
RCL, RCR-SERIES

# HYDRAULIC CYLINDERS

For Your Heavy Lifting Applications



**SIMPLEX®**

# HIGH-TONNAGE CYLINDERS

RLL, RCX, RCG, RCL, RCR-Series Cylinders



Simplex High-Tonnage Cylinders are the go-to cylinder series for multipoint heavy lifting applications. With unique features differentiating each series within the range, there is an ideal solution for all types of applications.

## RCX, RCG, RCL, RCR-Series Cylinders

- Replaceable wear bands improve seal life and side load capacity.
- Custom strokes and capacities up to 1000 ton.

## RLL-Series – Low-Profile Pancake Lock Nut

- Load-return – for weighing, lifting and positioning applications.
- Red band warns operator to end of stroke, over-flow port prevents over-stroke without stop ring.
- Body, lock nut and saddle feature black nitride coating to improve corrosion and wear resistance.

## RCX-Series – Low-Profile Load-Return

- Body features black nitride coating up to 250 ton to improve corrosion and wear resistance.
- Load-return – for weighing, lifting and positioning applications.
- Red band warns operator to end of stroke, over-flow port prevents over-stroke without stop ring.

## RCG-Series – Single-Acting Load-Return

- Load-Return.
- Mechanical end of stroke avoids over-travel at full pressure.

## RCL-Series – Lock Nut Load-Return

- Load-Return.
- Lock nut provides safe mechanical load holding for an extended period of time.
- Red band warns operator to end of stroke, over-flow port prevents over-stroke without stop ring.

## RCR-Series – Double-Acting Hydraulic Return

- Hydraulic Return for controlled retraction.
- Safety valve on the retract side prevents accidental over-pressurization.

Cylinder Series	Description / Applications	Cylinder Type	Capacity (tons)	Strokes (in)
RLL	Single-Acting Low-Profile Pancake Lock Nut	Single-Acting	55-575	1.77-1.97
RCX	Single-Acting Low-Profile Load-Return		150-575	1.97-11.81
RCL	Single-Acting Mechanical Load Holding / Lock Nut Load-Return		30-250	1.97-11.81
RCG	Single-Acting Load-Return		50-250	1.97-11.81
RCR	Double-Acting Controlled Retraction / Fast Cycling	Double-Acting	50-250	1.97-11.81

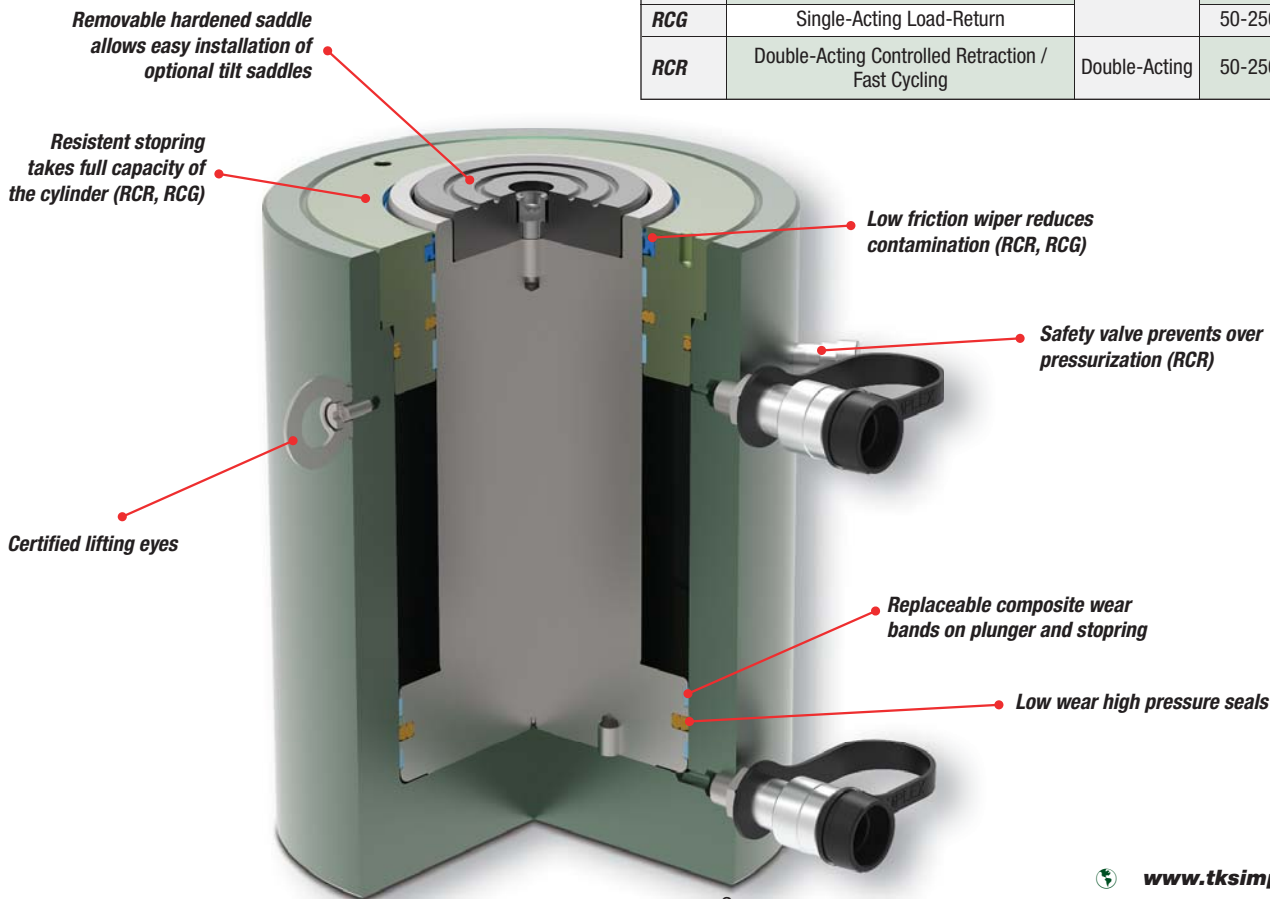



RLL-2502, RLL-1502, RLL502 Shown

Capacity Range .....▶ 55 - 575 tons

Stroke Range .....▶ 1.77 - 1.97 in.

Maximum Pressure .....▶ 10,150 psi

- ▶ Lock nut tested to 150% of rated load.
- ▶ Lock nut provides safe mechanical load holding for an extended period of time.
- ▶ Red band warns operator to end of stroke, over-flow port prevents over-stroke.
- ▶ Built-in tilt saddle to improve side-load resistance.
- ▶ Body, lock nut and saddle feature black nitride coating to improve corrosion and wear resistance.
- ▶ Low-Profile for use in confined areas.



**POWER PUMPS**

Simplex offers a wide variety of lightweight power pumps to fit any application.



**TILT SADDLES**

All RLL-Series cylinders include a built-in Tilt Saddle.



**HOSES**

Heavy-duty and thermo-plastic hydraulic hoses to meet your requirements and safety factor.

Simplex RLL-Series cylinders are designed for where space is at a minimum. ▼

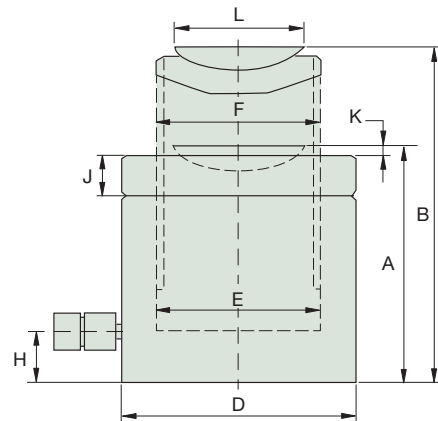

Model	Capacity (ton)	Stroke (in)	Oil Capacity Required (cu.in.)	A	B	D Outside Diameter (in)	E Cylinder Bore Diameter (in)	F Plunger Diameter (Threaded) (mm)	H Base to Adv. Port (in)	J Lock Nut Height (in)	K Saddle Pro- trusion from Plunger (in)	L Saddle Diameter (in)	Effective Area (sq.in.)	Wt. (lbs)
				Collapsed Height (in)	Extended Height (in)									
<b>RLL502</b>	55	1.97	21.66	4.92	6.89	4.92	3.74	Tr 95x4	0.79	0.83	0.24	3.62	10.97	24
<b>RLL1002</b>	104	1.77	36.43	5.39	7.17	6.50	5.12	Tr 130x6	0.91	1.22	0.31	4.96	20.57	49
<b>RLL1502</b>	158	1.77	55.23	5.83	7.60	8.07	6.30	Tr 160x6	1.10	1.50	0.35	5.83	31.17	86
<b>RLL2502</b>	247	1.77	86.23	6.10	7.87	10.04	7.87	Tr 200x6	1.26	1.57	0.39	6.18	48.70	137
<b>RLL3002</b>	341	1.77	119.11	6.81	8.58	12.20	9.25	Tr 235x6	1.50	1.77	0.43	8.46	67.22	214
<b>RLL4002</b>	450	1.77	157.23	7.09	8.86	13.78	10.63	Tr 270x6	1.73	1.97	0.39	10.24	88.75	287
<b>RLL5002</b>	575	1.77	206.74	7.68	9.45	15.75	12.01	Tr 305x6	1.97	2.36	0.39	11.61	113.24	406

# HIGH-TONNAGE CYLINDERS

RCX-Series - Low-Profile Load-Return



Capacity Range .....▶ 158 - 575 tons  
 Stroke Range .....▶ 1.97 - 11.81 in.  
 Maximum Pressure .....▶ 10,150 psi

- ▶ Load-return. For weighing, lifting and positioning applications in Civil Engineering.
- ▶ Red band warns operator to end of stroke, over-flow port prevents over-stroke, without stop-ring.
- ▶ Black nitrided body, up to 250 ton.
- ▶ Replaceable wear bands improve seal life and side load capacity.
- ▶ Custom strokes and capacities up to 1000 ton.
- ▶ Optional tilt saddles.



## POWER PUMPS

Simplex offers a wide variety of lightweight power pumps to fit any application.



## OPTIONAL TILT SADDLES

Highly recommended for side load applications.



## HOSES

Heavy-duty and thermo plastic hydraulic hoses to meet your requirements and safety factor.



## LIFTING EYES

Certified lifting eyes.



<i>Model</i>	Capacity (tons)	Stroke (in)	Oil Capacity Required (cu.in.)	Effective Area (sq.in.)	Wt. (lbs)
<i>RCX1502</i>	158	1.97	61.35	31.16	95
<i>RCX1506</i>		5.91	184.04	31.16	164
<i>RCX15012</i>		11.81	368.09	31.16	256
<i>RCX2502</i>	247	1.97	95.86	48.69	165
<i>RCX2506</i>		5.91	287.57	48.69	266
<i>RCX25012</i>		11.81	575.14	48.69	412
<i>RCX3002</i>	341	1.97	132.34	67.23	243
<i>RCX3006</i>		5.91	397.02	67.23	388
<i>RCX30012</i>		11.81	794.05	67.23	589
<i>RCX4002</i>	450	1.97	174.70	88.75	356
<i>RCX4006</i>		5.91	524.09	88.75	538
<i>RCX40012</i>		11.81	1,048.18	88.75	803
<i>RCX5002</i>	575	1.97	222.92	113.25	498
<i>RCX5006</i>		5.91	668.77	113.25	736
<i>RCX50012</i>		11.81	1,337.55	113.25	1082



**RCG-SERIES**  
For mechanical stop ring, see RCG-Series.



**THINK SAFETY**  
Manufacturer's rating of load and stroke are maximum safe limits.  
Good practice encourages using only 80% of these ratings!



**RLS & RFS-SERIES**  
For confined areas and loads up to 150 ton, see RLS and RFS-Series.

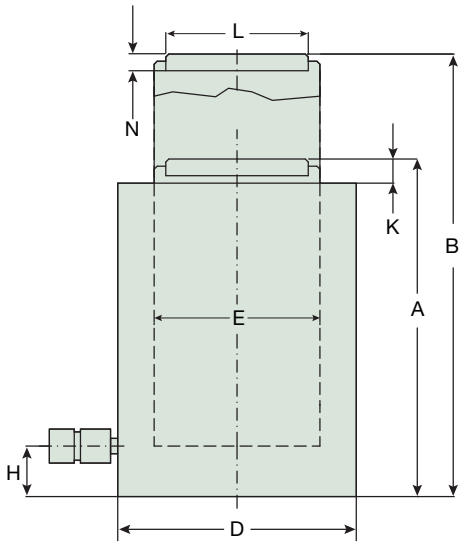

Optional tilt saddle.

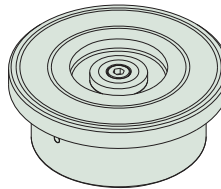

TILTING ±5°

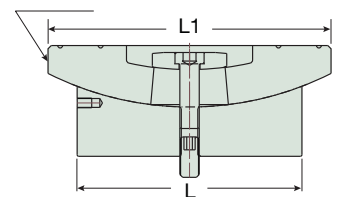

A	B	D	E	H	K	L	N	Cylinder Model
Collapsed Height	Extended Height	Outside Diameter	Cylinder Bore Diameter	Base to Adv. Port	Saddle Protrusion from Plunger	Saddle Diameter	Saddle Height	
(in)	(in)	(in)	(in)	(in)	(in)	(in)	(in)	
6.30	8.27	8.27	6.30	1.57	0.24	3.70	0.79	<b>RCX1502</b>
10.79	16.69	8.27	6.30	1.57	0.24	3.70	0.79	<b>RCX1506</b>
16.93	28.72	8.27	6.30	1.57	0.24	3.70	0.79	<b>RCX15012</b>
7.09	9.06	10.24	7.87	1.97	0.24	4.45	0.79	<b>RCX2502</b>
11.46	17.36	10.24	7.87	1.97	0.24	4.45	0.79	<b>RCX2506</b>
17.76	29.57	10.24	7.87	1.97	0.24	4.45	0.79	<b>RCX25012</b>
7.60	9.57	12.01	9.25	2.17	0.31	5.51	1.18	<b>RCX3002</b>
12.17	18.07	12.01	9.25	2.17	0.31	5.51	1.18	<b>RCX3006</b>
18.46	30.28	12.01	9.25	2.17	0.31	5.51	1.18	<b>RCX30012</b>
8.46	10.43	13.78	10.63	2.56	0.39	6.26	1.18	<b>RCX4002</b>
12.80	18.70	13.78	10.63	2.56	0.39	6.26	1.18	<b>RCX4006</b>
19.09	30.91	13.78	10.63	2.56	0.39	6.26	1.18	<b>RCX40012</b>
9.06	11.03	15.75	12.01	2.95	0.39	7.05	1.18	<b>RCX5002</b>
13.39	19.29	15.75	12.01	2.95	0.39	7.05	1.18	<b>RCX5006</b>
19.69	31.50	15.75	12.01	2.95	0.39	7.05	1.18	<b>RCX50012</b>

With Tilt Saddle		
A (in)	L1 (in)	Tilt Saddle Model
7.05	3.82	CATS150
11.54	3.82	CATS150
17.68	3.82	CATS150
7.99	4.96	CATS200
12.36	4.96	CATS200
18.66	4.96	CATS200
9.13	6.89	CATS300
13.70	6.89	CATS300
20.00	6.89	CATS300
10.35	8.27	CATS400
14.69	8.27	CATS400
20.98	8.27	CATS400
10.91	9.06	CATS500
15.24	9.06	CATS500
21.54	9.06	CATS500

# HIGH-TONNAGE CYLINDERS

RCG-Series - Single-Acting, Load-Return



Capacity Range .....▶ 55 - 247 tons  
 Stroke Range .....▶ 5.91 - 11.81 in.  
 Maximum Pressure .....▶ 10,150 psi

- ▶ Load-return.
- ▶ Mechanical end of stroke avoids over travel at full pressure.
- ▶ Replaceable wear bands improve seal life and side load capacity.
- ▶ Custom strokes and capacities up to 1000 ton.
- ▶ Optional tilt saddles.



## POWER PUMPS

Simplex offers a wide variety of lightweight power pumps to fit any application.



## OPTIONAL TILT SADDLES

Highly recommended for side load applications.



## HOSES

Heavy-duty and thermo plastic hydraulic hoses to meet your requirements and safety factor.



## LIFTING EYES

Certified lifting eyes.



Model	Capacity (tons)	Stroke (in)	Oil Capacity Required (cu.in.)	Effective Area (sq.in.)	Wt. (lbs)
<b>RCG506</b>	55	5.91	64.88	10.99	58
<b>RCG5012</b>		11.81	129.76	10.99	84
<b>RCG1006</b>	104	5.91	121.50	20.57	102
<b>RCG10012</b>		11.81	242.99	20.57	149
<b>RCG1502</b>	158	1.97	61.35	31.16	118
<b>RCG1506</b>		5.91	184.04	31.16	162
<b>RCG15012</b>		11.81	368.09	31.16	230
<b>RCG2502</b>	247	1.97	95.86	48.69	198
<b>RCG2506</b>		5.91	287.57	48.69	265
<b>RCG25012</b>		11.81	575.14	48.69	372



**RCR-SERIES DOUBLE-ACTING CYLINDERS**  
For hydraulic and controlled return, use RCR-Series.



**THINK SAFETY**  
Manufacturer's rating of load and stroke are maximum safe limits.  
Good practice encourages using only 80% of these ratings!



**RLS-SERIES**  
For confined areas and loads up to 100 ton, see RLS-Series.

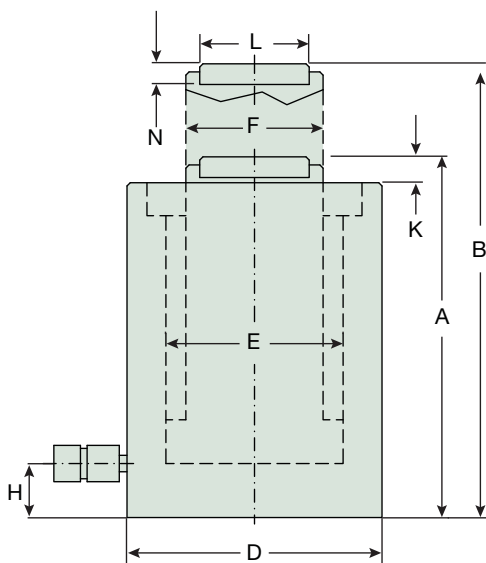

Optional tilt saddle.

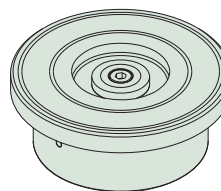

TILTING  $\pm 5^\circ$

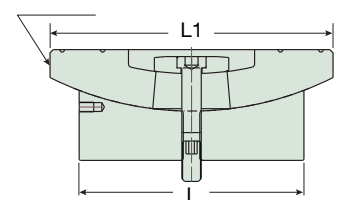

A	B	D	E	F	H	K	L	N	Cylinder Model
Collapsed Height (in)	Extended Height (in)	Outside Diameter (in)	Cylinder Bore Diameter (in)	Plunger Diameter (in)	Base to Adv. Port (in)	Saddle Protrusion from Plunger (in)	Saddle Diameter (in)	Saddle Height (in)	
12.05	17.95	4.92	3.74	2.95	0.98	0.24	1.97	0.79	<b>RCG506</b>
18.16	29.96	4.92	3.74	2.95	0.98	0.24	1.97	0.79	<b>RCG5012</b>
11.65	17.56	6.69	5.12	3.94	1.18	0.24	2.80	0.79	<b>RCG1006</b>
17.77	29.58	6.69	5.12	3.94	1.18	0.24	2.80	0.79	<b>RCG10012</b>
8.39	10.35	8.27	6.30	4.33	1.57	0.24	3.70	0.79	<b>RCG1502</b>
12.53	18.44	8.27	6.30	4.33	1.57	0.24	3.70	0.79	<b>RCG1506</b>
18.83	30.64	8.27	6.30	4.33	1.57	0.24	3.70	0.79	<b>RCG15012</b>
9.17	11.14	10.24	7.87	5.51	1.97	0.24	4.45	0.98	<b>RCG2502</b>
13.11	19.02	10.24	7.87	5.51	1.97	0.24	4.45	0.98	<b>RCG2506</b>
19.62	31.43	10.24	7.87	5.51	1.97	0.24	4.45	0.98	<b>RCG25012</b>

With Tilt Saddle		
A (in)	L1 (in)	Tilt Saddle Model
12.60	2.80	CATS50
18.71	2.80	CATS50
12.05	2.80	CATS100
18.16	2.80	CATS100
9.13	3.82	CATS150
13.28	3.82	CATS150
19.58	3.82	CATS150
9.88	4.96	CATS200
13.82	4.96	CATS200
20.33	4.96	CATS200

# HIGH-TONNAGE CYLINDERS

RCL-Series - Lock Nut Load-Return



Capacity Range .....▶ 34 - 247 tons  
 Stroke Range .....▶ 1.97 - 11.81 in.  
 Maximum Pressure .....▶ 10,150 psi

- ▶ Lock nut tested to 150% of rated load.
- ▶ Lock nut provides safe mechanical load holding for an extended period of time.
- ▶ Red band warns operator to end of stroke, over-flow port prevents over-stroke, without stop ring.
- ▶ As custom, possibility to include stop ring for mechanical end of stroke.
- ▶ Body, lock nut and saddle feature black nitride coating to improve corrosion and wear resistance.
- ▶ Load-return.
- ▶ Replaceable wear bands improve seal life and side load capacity.
- ▶ Custom strokes and capacities up to 1000 ton.
- ▶ Optional tilt saddles.



### POWER PUMPS

Simplex offers a wide variety of lightweight power pumps to fit any application.



### OPTIONAL TILT SADDLES

Highly recommended for side load applications.



### HOSES

Heavy-duty and thermo plastic hydraulic hoses to meet your requirements and safety factor.



### LIFTING EYES

Certified lifting eyes.

### TYPICAL APPLICATIONS

Used for foundation supporting, bridge construction and ship building.



Model	Capacity (tons)	Stroke (in)	Oil Capacity Required (cu.in.)	Effective Area (sq.in.)	Wt. (lbs)
RCL302	34	1.97	13.48	6.85	19
RCL304		3.94	26.96	6.85	26
RCL306		5.91	40.44	6.85	34
RCL308		7.87	53.92	6.85	40
RCL3012		11.81	80.88	6.85	55
RCL502	55	1.97	21.63	10.99	32
RCL506		5.91	64.88	10.99	55
RCL5010		9.84	108.14	10.99	77
RCL1002	104	1.97	40.50	20.57	70
RCL1006		5.91	121.50	20.57	111
RCL10010		9.84	202.49	20.57	152
RCL1502	158	1.97	61.35	31.16	115
RCL1506		5.91	184.04	31.16	183
RCL15012		11.81	368.08	31.16	276
RCL2506	247	5.91	287.56	48.69	298
RCL25012		11.81	575.13	48.69	444





**RLL LOW-HEIGHT CYLINDERS**

For confined areas use RLL-Series, pancake cylinders.



**THINK SAFETY**

Manufacturer's rating of load and stroke are maximum safe limits. Good practice encourages using only 80% of these ratings!

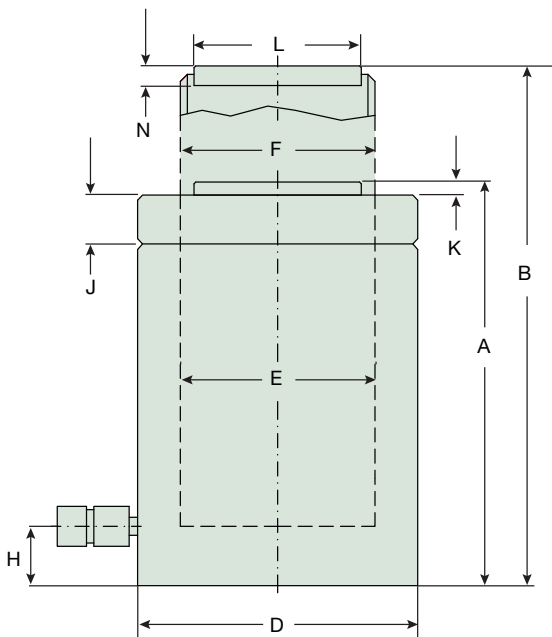

Optional tilt saddle.

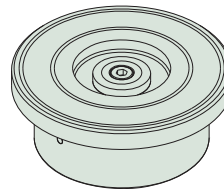

TILTING ±5°

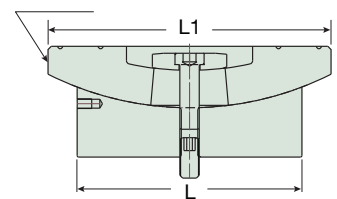

A	B	D	E	F	H	J	K	L	N	Cylinder Model
Collapsed Height	Extended Height	Outside Diameter	Cylinder Bore Diameter	Plunger Diameter (Threaded)	Base to Adv. Port	Lock Nut Height	Saddle Protrusion from Plunger	Saddle Diameter	Saddle Height	
(in)	(in)	(in)	(in)	(mm)	(in)	(in)	(in)	(in)	(in)	
5.55	7.52	3.94	2.95	Tr 75x4	0.79	0.79	0.12	1.97	0.79	<b>RCL302</b>
7.52	11.46	3.94	2.95	Tr 75x4	0.79	0.79	0.12	1.97	0.79	<b>RCL304</b>
9.69	15.59	3.94	2.95	Tr 75x4	0.79	0.79	0.12	1.97	0.79	<b>RCL306</b>
11.65	19.53	3.94	2.95	Tr 75x4	0.79	0.79	0.12	1.97	0.79	<b>RCL308</b>
15.94	27.76	3.94	2.95	Tr 75x4	0.79	0.79	0.12	1.97	0.79	<b>RCL3012</b>
6.02	7.99	4.92	3.74	Tr 95x4	0.98	0.83	0.12	1.97	0.79	<b>RCL502</b>
10.28	16.18	4.92	3.74	Tr 95x4	0.98	0.83	0.12	1.97	0.79	<b>RCL506</b>
14.41	24.25	4.92	3.74	Tr 95x4	0.98	0.83	0.12	1.97	0.79	<b>RCL5010</b>
7.09	9.06	6.69	5.12	Tr 130x6	1.18	1.22	0.12	2.80	0.79	<b>RCL1002</b>
11.22	17.13	6.69	5.12	Tr 130x6	1.18	1.22	0.12	2.80	0.79	<b>RCL1006</b>
15.39	25.24	6.69	5.12	Tr 130x6	1.18	1.22	0.12	2.80	0.79	<b>RCL10010</b>
7.68	9.65	8.27	6.30	Tr 160x6	1.57	1.50	0.12	3.70	0.79	<b>RCL1502</b>
12.17	18.07	8.27	6.30	Tr 160x6	1.57	1.50	0.12	3.70	0.79	<b>RCL1506</b>
18.31	30.12	8.27	6.30	Tr 160x6	1.57	1.50	0.12	3.70	0.79	<b>RCL15012</b>
12.91	18.82	10.24	7.87	Tr 200x6	1.97	1.57	0.12	4.45	0.98	<b>RCL2506</b>
19.21	31.02	10.24	7.87	Tr 200x6	1.97	1.57	0.12	4.45	0.98	<b>RCL25012</b>

With Tilt Saddle		
A (in)	L1 (in)	Tilt Saddle Model
6.10	2.80	CATS50
8.07	2.80	CATS50
10.24	2.80	CATS50
12.20	2.80	CATS50
16.50	2.80	CATS50
6.57	2.80	CATS50
10.83	2.80	CATS50
14.96	2.80	CATS50
7.48	2.80	CATS100
11.61	2.80	CATS100
15.79	2.80	CATS100
8.43	3.82	CATS150
12.91	3.82	CATS150
19.06	3.82	CATS150
13.62	4.96	CATS200
19.92	4.96	CATS200

# HIGH-TONNAGE CYLINDERS

RCR-Series, Double-Acting, Hydraulic Return



Capacity Range .....▶ 55 - 247 tons  
 Stroke Range .....▶ 1.97 - 11.81 in.  
 Maximum Pressure .....▶ 10,150 psi

- ▶ Double-Acting, hydraulic return.
- ▶ Safety valve on the retract side to prevent accidental over-pressure.
- ▶ Replaceable wear bands improve seal life and side load capacity.
- ▶ Custom strokes and capacities up to 1000 ton.
- ▶ Optional tilt saddles.



### POWER PUMPS

Simplex offers a wide variety of lightweight power pumps to fit any application.



### OPTIONAL TILT SADDLES

Highly recommended for side load applications.



### HOSES

Heavy-duty and thermo plastic hydraulic hoses to meet your requirements and safety factor.



### LIFTING EYES

Certified lifting eyes.



Model	Capacity (tons)	Stroke (in)	Oil Capacity Required (cu.in.)	Effective Area (sq.in.)	Wt. (lbs)
<i>RCR502</i>	55	1.97	21.63	10.99	42
<i>RCR506</i>		5.91	64.88	10.99	58
<i>RCR5012</i>		11.81	129.76	10.99	84
<i>RCR1002</i>	104	1.97	40.50	20.57	72
<i>RCR1006</i>		5.91	121.50	20.57	102
<i>RCR10012</i>		11.81	242.99	20.57	149
<i>RCR1502</i>	158	1.97	61.35	31.16	118
<i>RCR1506</i>		5.91	184.04	31.16	162
<i>RCR15012</i>		11.81	368.09	31.16	230
<i>RCR2502</i>	247	1.97	95.86	48.69	198
<i>RCR2506</i>		5.91	287.57	48.69	265
<i>RCR25012</i>		11.81	575.14	48.69	372



**THINK SAFETY**

Manufacturer's rating of load and stroke are maximum safe limits. Good practice encourages using only 80% of these ratings!

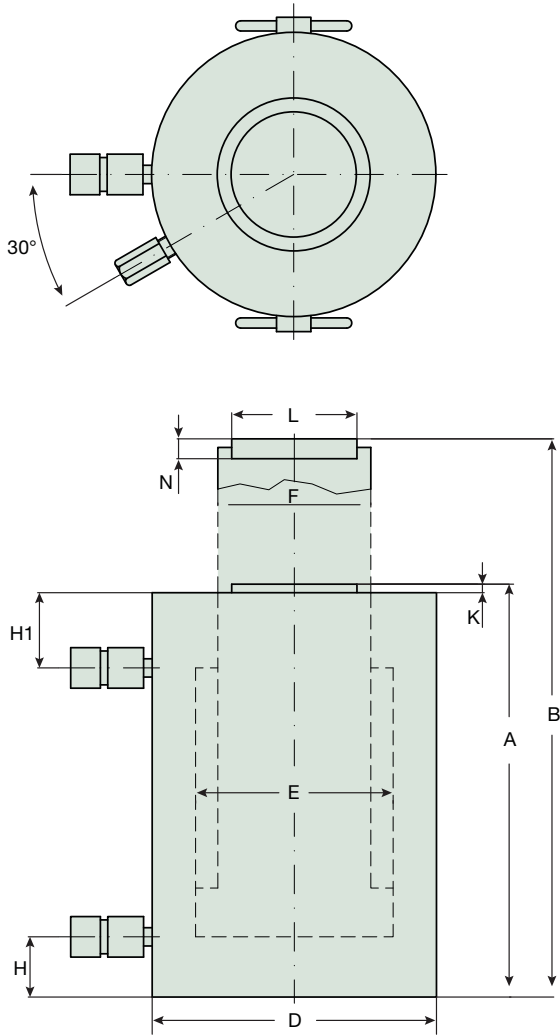

Optional tilt saddle.

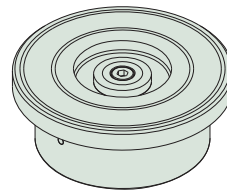

TILTING ±5°

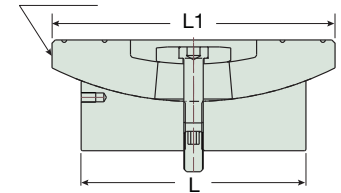

A	B	D	E	F	H	H1	K	L	N	Cylinder Model
Collapsed Height (in)	Extended Height (in)	Outside Diameter (in)	Cylinder Bore Diameter (in)	Plunger Diameter (in)	Base to Adv. Port (in)	Top to Retract Port (in)	Saddle Protrusion From Plunger (in)	Saddle Diameter (in)	Saddle Height (in)	
8.11	10.08	4.92	3.74	2.95	0.98	2.95	0.24	1.97	0.79	<b>RCR502</b>
12.05	17.95	4.92	3.74	2.95	0.98	2.95	0.24	1.97	0.79	<b>RCR506</b>
18.15	29.96	4.92	3.74	2.95	0.98	3.15	0.24	1.97	0.79	<b>RCR5012</b>
7.72	9.69	6.69	5.12	3.94	1.18	2.36	0.24	2.80	0.79	<b>RCR1002</b>
11.65	17.56	6.69	5.12	3.94	1.18	2.36	0.24	2.80	0.79	<b>RCR1006</b>
17.77	29.58	6.69	5.12	3.94	1.18	2.56	0.24	2.80	0.79	<b>RCR10012</b>
8.39	10.35	8.27	6.30	4.33	1.57	2.56	0.24	3.70	0.79	<b>RCR1502</b>
12.53	18.44	8.27	6.30	4.33	1.57	2.76	0.24	3.70	0.79	<b>RCR1506</b>
18.83	30.64	8.27	6.30	4.33	1.57	3.15	0.24	3.70	0.79	<b>RCR15012</b>
9.17	11.14	10.24	7.87	5.51	1.97	2.95	0.24	4.45	0.98	<b>RCR2502</b>
13.11	19.02	10.24	7.87	5.51	1.97	2.95	0.24	4.45	0.98	<b>RCR2506</b>
19.62	31.43	10.24	7.87	5.51	1.97	3.35	0.24	4.45	0.98	<b>RCR25012</b>

With Tilt Saddle		
A (in)	L1 (in)	Tilt Saddle Model
10.63	2.80	CATS50
18.50	2.80	CATS50
30.51	2.80	CATS50
10.08	2.80	CATS100
17.95	2.80	CATS100
29.97	2.80	CATS100
11.10	3.82	CATS150
19.19	3.82	CATS150
31.39	3.82	CATS150
9.88	4.96	CATS200
13.82	4.96	CATS200
20.33	4.96	CATS200

## SIMPLEX Product Lines

cylinders



hand pumps



power pumps



accessories



bolting



lifting jacks



hydraulic tools



presses



mechanical jacks



Visit us on the web.  
[www.tksimplex.com](http://www.tksimplex.com)

Your Simplex Distributor:

N86 W12500 Westbrook Crossing  
Menomonee Falls, WI 53051  
Phone (USA): 1.800.323.9114  
Phone (INSIDE / OUTSIDE USA): 1.262.293.1575  
Fax: 1.262.597.1127