

REFMATE

4688001

4688129

Instruction manual
Digital manifold

Bedienungsanleitung
Digitale Monteurhilfe

Manuel d'utilisation
By-pass digital

Istruzione d'uso
gruppo manometrico digitale

Manual de instrucciones
Analizador digital

1	INTRODUCTION	3
2	GENERAL INFORMATION	3
3	SPECIFICATIONS	6
4	PRODUCT AND PART DESCRIPTION.....	7
4.1	PART DESCRIPTION	7
4.2	BUTTONS AND NAVIGATION	9
5	TRANSPORT, PACKAGING AND STORAGE	10
5.1	TRANSPORT	10
5.2	PACKAGING	10
5.3	STORAGE	10
6	COMMISSIONING AND FUNCTIONS.....	11
6.1	COMMISSIONING.....	11
6.1.1	<i>Analogue display.....</i>	<i>13</i>
6.1.2	<i>Logging data</i>	<i>14</i>
6.1.3	<i>Menu</i>	<i>16</i>
7	MAINTENANCE	20
7.1	REFRIGERANT UPDATE	20
7.2	FIRMWARE UPDATE	21
8	TROUBLESHOOTING	22
9	GUARANTEE.....	24
10	RETURN AND DISPOSAL.....	24
11	SPARE PARTS AND ACCESSORIES	25

1 Introduction



Congratulations on your purchase of this device.

Latest manual is available on www.refco.ch

2 General information

Before you start working with the manifold, please read the operating instructions carefully. They contain important information for the successful operation, maintenance and disposal of the manifold.

Conformity

	<p>This device complies with the relevant European directives. The Declaration of Conformity is available from the specified contact details or on the REFCO website.</p>
	<p>This device complies with Part 15 of the FCC Rules. It should be operated under the following conditions:</p> <ol style="list-style-type: none"> (1) This device may not cause harmful interference, and (2) This device must be able to withstand interference, including interference that may result in errors during operation. <p>FCC ID: XPYNINAB1</p>
	<p>This device complies with Industry Canada's licence-exempt RSS standards.</p> <p>It should be operated under the following conditions:</p> <ol style="list-style-type: none"> (1) This device may not cause harmful interference, and (2) This device must be able to withstand interference, including interference that may result in errors during operation. <p>IC ID: 8595A-NINAB1</p>

	<p>RCM: Regulatory Compliance Mark</p> <p>This device complies with the requirements of the RCM regulations.</p>
<p>RoHS</p>	<p>RoHS: Restriction of Hazardous Substances</p> <p>This device meets the requirements of the RoHS EU directive.</p> <p>RoHS 2011/65/EU including 2015/863/EU</p> <p>The device does not contain any prohibited substances above the maximum permissible values.</p>
<p>REACH</p>	<p>In accordance with article 33 of REACH Regulation 1907/2006, we confirm that this device and its packaging complies with article 57 of REACH Regulation 1907/2006.</p> <p>This device and its packaging do not contain any of the SVHC specified in the current candidate list (Article 59) at concentrations above 0.1%.</p>

Important safety instructions

Please read and follow all safety instructions carefully.

Explanation of symbols:

Warning!



... indicates a potentially hazardous situation which, if not avoided, may result in serious injury.

Danger!



... indicates an electrical hazard. Failure to observe the safety instructions may result in serious or fatal injury.

Safety instructions:



The manifold may not be used for other purposes outside the air-conditioning and refrigeration sector.



The manifold must not be used for pressures higher than 60 bar / 870 psi / 6000 kPa / 6 MPa.



Under no circumstances should the manifold be used as a pressure reducing valve, especially when nitrogen N₂ is used.



The manifold must not be used with the refrigerant ammonia (NH₃ / R717) and not in EX zones.



The manifold must not be exposed to rain or used in damp or wet environments.



Always wear protective goggles and gloves when working with the manifold.



REFCO products have been specially designed and manufactured for use by trained refrigeration technicians. Due to the high pressures and chemical and physical gases used in refrigeration systems, REFCO disclaims all responsibility and liability for accidents, injuries and death.



REFCO expressly points out that the products should only be used by professionally trained specialists.

Intended use

The manifold has been developed for measuring and regulating the pressure and temperature conditions in mobile and stationary refrigeration systems and heat pumps as well. Only trained refrigeration technicians are permitted to use this REFCO product.

3 Specifications

Property	Value	
Pressure range	-0.95 to 60 bar	
Max. overpressure	80 bar	
Pressure accuracy	±0.5 (class 0.5)	
Pressure units	bar / psi / kPa / MPa / kg/cm ²	
Pressure resolution	0.01 bar / 0.5 psi / 1 kPa / 0.001 MPa / 0.01 kg/cm ²	
External temperature sensor	Temperature range	-40°C to +125°C / -40°F to +257°F
	Connector	K-type
	Temperature accuracy	+/- 1 K
	Resolution	0.1°C / 0.1°F
Temperature clamp	Temperature range	-40°C to +125°C / -40°F to +257°F
	Connector	K-type
	Temperature accuracy	+/- 1 K
	Resolution	0.1°C / 0.1°F
	Tube diameters temperature clamp	6 mm to 38 mm ¼" to 1 ½"
	Tube diameters wireless temp. clamp	6 mm to 42 mm ¼" to 1 ⅝"
Ambient temperature	-20°C to +50°C / -4°F to +122°F	
Power supply	4 x 1.5 V AA/Mignon/LR6 or USB	
Storage temperature	- 20°C to + 60°C / -4°F to +140°F	

4 Product and part description

The following parts are included in the delivery:

Included in standard version	Other accessories
Digital manifold 2 K-type temperature sensors with 1.5 m-long cable 5 filling hoses 4 x AA batteries Micro SD card 8 GB (inserted in device) Plastic case Operating instructions Calibration record USB-Cable 1.8 m	2 K-type temperature clamps with 1.5 m-long cable 2 K-type wireless temperature clamps

4.1 Part description

2-way

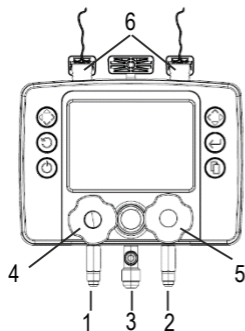

4-way

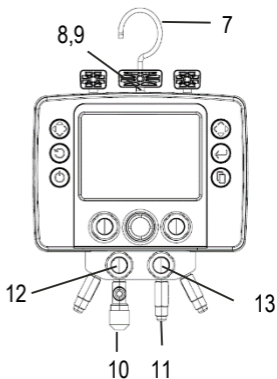

1.	Low pressure connector 1/4" SAE	To connect a hose
2.	High pressure connector 1/4" SAE	To connect a hose
3.	Refrigerant / vacuum connector 1/4" SAE	To connect a hose
4.	Low pressure valve (blue)	Turn to the left to open or turn clockwise to close
5.	High pressure valve (red)	Turn to the left to open or turn clockwise to close
6.	K-type socket	Socket for temperature sensor or temperature clamp
7.	Hook	To hang the device
8.	Micro USB connector	Slot for micro USB cable to connect to a computer
9.	SD card connector	SD card slot
10.	Vacuum connector 3/8" SAE	To connect a hose
11.	Refrigerant connector 1/4" SAE	To connect a hose
12.	Vacuum valve (yellow)	Turn to the left to open or turn clockwise to close
13.	Refrigerant valve (black)	Turn to the left to open or turn clockwise to close

4.2 Buttons and navigation



To the LEFT
or UP



To the RIGHT or
DOWN



BACK button



INPUT /
SELECTION





Power
ON/OFF



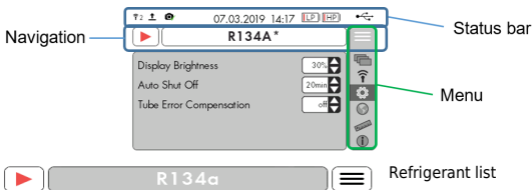

SWITCH button

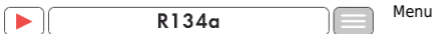

Press  to access the refrigerant library.

Press  to get to the right



Press  to access the menu.

Press  to get to the right



Press  to access the logging menu.

Important notice	
Guarantee date is set within 5 minutes	A one-off extension of the guarantee from the date of initial operation is granted. This date is set the first time the unit is used for more than 5 minutes. This can also be done for presentation purposes at the point of sale and cannot be corrected afterwards!
Remove AA batteries from REFMATE after use	The leakage of chemicals from batteries will destroy the REFMATE. If the device is not going to be used for a longer period of time, the AA batteries must be removed from the REFMATE. The leakage of chemicals is not covered by the guarantee. 
Leave SD card in the REFMATE	We recommend leaving the SD card in the REFMATE to prevent the loss of the card!

5 Transport, packaging and storage

5.1 Transport

The digital manifold comes with a plastic case to protect the parts. The plastic case protects against vibrations during transport and handling. Always use the plastic case to protect the manifold and accessories and secure it to the cargo area during transport. The storage conditions must also be maintained during transport.

5.2 Packaging

The plastic case is made of polyethylene and protects the digital manifold from drop damage. It also has room for accessories, which comprise the temperature sensors included in the delivery as well as the temperature clamps, wireless temperature clamps and a vacuum sensor.

5.3 Storage

The storage temperatures must be maintained and the packaging must be closed.

6 Commissioning and functions

6.1 Commissioning

Preparation for commissioning

Insert 4 batteries into the battery compartment on the back. Observe the correct polarity of the batteries. If you will not be using the REFMATE for a longer period of time, remove the batteries from the battery compartment.

Remove the protective film from the display



Start device

Press 

After a few seconds, the device will be ready.

- Check the battery status

Note: The date and time cannot be changed during the very first 5 minutes.



Zeroing the pressure sensors

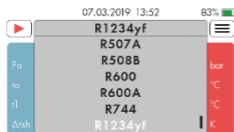

Press and hold 

- The pressure display shows zero



Select refrigerant

Press  to access the refrigerant library.

Select the desired refrigerant by pressing  or . To confirm the selection, press .

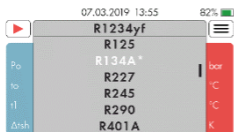

Refrigerant favourites

By pressing and holding  for at least 3 seconds, you can select favourites.

*Favourites are marked with * and appear at the top of the list.*

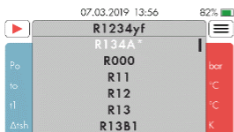

Remove favorite by pressing and holding  for at least 3 seconds.

6.1.1 Analogue display

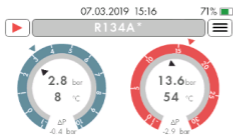
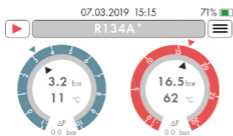
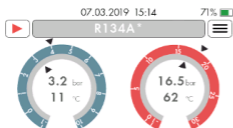
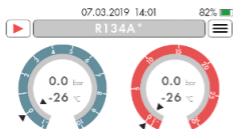

Superheat and Subcool

By pressing

you can switch between the digital and analogue displays.

Slave pointer

The pointer remains in the outer ring of the analogue display at the highest pressure reached.

--.	No reading/value
OOR	Out of range
OCP	Over critical point
no cal.	Device not calibrated

Set reference pressure

To set a reference pressure, press

and hold for 3 seconds.

The pressure difference is also displayed.

To delete the reference pressure,

press and hold for 3 seconds.



The two above-mentioned functions are only available in the analogue display.

6.1.2 Logging data 

07.03.2019 14:02 81% 

R134A* 



Set	Sample Rate	Duration
	1 Sample/min	4 h
	6 Sample/min	8 h
	30 Sample/min	12 h
	60 Sample/min	24 h
	120 Sample/min	48 h

 

07.03.2019 14:03 81% 

R134A* 



Set	Sample Rate	Duration
	1 Sample/min	8 h
	6 Sample/min	12 h
	30 Sample/min	24 h
	60 Sample/min	48 h
	120 Sample/min	168 h

 

07.03.2019 14:03 81% 

R134A* 

Set	Sample Rate	Duration
	1 Sample/min	8 h
	6 Sample/min	12 h
	30 Sample/min	24 h
	60 Sample/min	48 h
	120 Sample/min	168 h

 

07.03.2019 14:04 81% 



R134A* 

LP		HP	
Po	0.00 bar	Pc	0.00 bar
to	-26.2 °C	tc	-26.2 °C
tl	--.- °C	td	--.- °C
Atsh	--.- K	Atsc	--.- K

07.03.2019 14:04 81% 

R134A* 

Set	Sample Rate	Duration
	1 Sample/min	8 h
	6 Sample/min	12 h
	30 Sample/min	24 h
	60 Sample/min	48 h
	120 Sample/min	168 h

 REF_M_20190307_140344.csv 

Logging data

Make sure that there is an SD card in the designated slot.

In the navigation, go with  to

 and press . Select the

sampling rate by pressing :



Values between 1-120 sample/min

(Sample/min = measuring points / minute)

Select the measurement duration

with , , :

Values between 15 min-168 h

Start recording with , ,



The file name is automatically created and displayed.

During recording, refrigerant selection and settings are locked.

To stop the recording prematurely, go to 

and press .

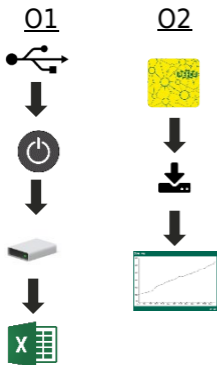

Evaluating data

Option 1

Connect the device to a computer using a USB cable.

Switch on your REFMATE.

The device is displayed as a USB drive.

The data is available as Excel files in csv format.

Option 2



Data transfer to the app:

Open the app and select Transfer

logged data . Select the desired file.

View the time elapsed.

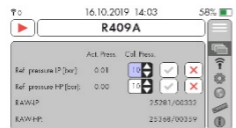
6.1.3

Menu 

Field calibration with reference pressure

In the navigation, go with  to  and press .

Use the  tab to carry out the field calibration of the pressure sensors.

To start the calibration, enter the PIN.

The PIN is 0-0-0-9

The device must not be pressurised at this time!

Press 

Connect the device to a system with a defined pressure.

Pressure range: 10–60 bar, 150–850 psi

The higher the calibration pressure, the more accurate the calibration!

Wait until the calibration pressure corresponds to the reference pressure. By clicking  the respective pressure sensor is calibrated.

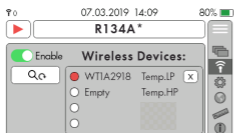
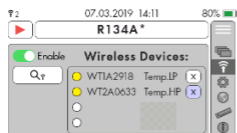
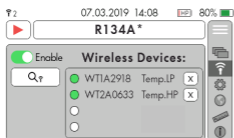
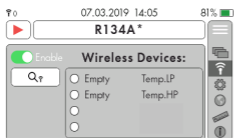

Connections

See the  tab for the available wireless connections.

Under “Enable” you can activate the connection.

Use  to search for connections and connect automatically.

To connect to Wireless Temperature Clamps, choose in the Clamps the Clamp names T1 for LP and T2 for HP.

Once connected, devices are stored and automatically connected when the wireless function is switched on.

The number of connected devices is shown at the top left of the display. An additional battery indicator will appear if the wireless temperature clamp requires a battery change.

Meaning of the colour display:

Green: Device connected

Yellow: Wireless clamp connected and temperature sensor plugged in.

The plugged-in sensor has priority and is displayed.

Red: Stored device not connected.



General settings

Use the  tab for various setting options.



The display brightness can be adjusted as required.

Quick function:

Press and hold  while tapping  or . The brightness is adjusted in increments of 5%.



The time to auto power off is set under Auto Shut Off. This function can be deactivated.

Setting options: 1-60 min and off

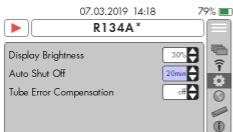

Tube Error Compensation is a temperature correction function that offsets the measurement error from the tube to the refrigerator.

This function can be switched "On" or "Off".



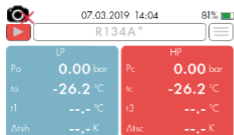
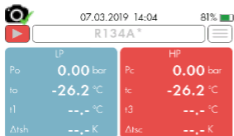
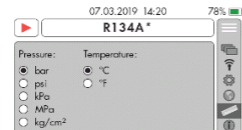

Time and language settings

The  tab offers various country-specific settings.

You can select time, date and language.

The default language is English.

Unit settings

See the  tab for the pressure and temperature units.

Print screen quick function

By pressing and holding  for 5 seconds, a screenshot of any screen can be created.

The file is stored on the SD card as a bitmap.



Screenshot successful



Screenshot not successful



The files can be used as described in the Evaluating data section.



7 Maintenance

The digital manifold requires maintenance work when used regularly:



- Clean the screen and the housing surface with a cloth and cleaning agent.
- Do not use corrosive cleaning agents or solvents to clean the unit. Weak household cleaners and soap suds may be used.
- The connectors and filling hoses must be visually inspected for mechanical damage before each use and replaced if damaged.
- The seals of a manifold are naturally subject to mechanical and ageing-related wear and tear. The manifold must therefore be checked regularly by the user for leaks.
- If any valves are leaking, the piston must be replaced (M4-6-04-R/10).
- The REFCO special tool M4-6-11-T must be used to change the sight glass on the manifold.



7.1 Refrigerant update

1	Log in to the App  and go to the device update section.
2	Under refrigerants you will find the latest refrigerant versions.
3	Select the latest refrigerants and email them to yourself.
4	Connect the REFMATE to your PC via USB cable. 
5	When the REFMATE is turned on, a new drive appears in the explorer. 

6	Copy the received file from your email to the new drive.
7	Switch off the REFMATE  and restart it  .
8	The refrigerant list has now been updated.

7.2 Firmware update

1	Log in to the App  and go to the device update section.
2	See firmware for the latest version.
3	Select the latest firmware and email it to yourself.
4	Connect the REFMATE to your PC via USB cable. 
5	When the REFMATE is turned on, a new drive appears in the explorer. 
6	Copy the received file from your email to the new drive.

7	<p>Switch off the REFMATE .</p> <p>Start the REFMATE by pressing and holding the following key combination:</p> <p>First  and then  simultaneously for one second until the display switches on.</p>
8	<p>The current firmware is deleted from memory and the new firmware is installed. Duration: approx. 1.5 min</p>

8 Troubleshooting

	Problem	Action
Measuring	No temperature is displayed	Measuring range exceeded Change area of application or replace the temperature sensors
	Pressure is displayed incorrectly and can no longer be set to 0 in atmosphere	Calibrate the pressure sensors
	Battery life is not sufficient for testing	Power the device via USB with a power bank or power supply unit with USB connection
Logging	No recording is displayed	No memory inserted Micro SD card must be inserted before switching on Micro SD card memory is full
	SD card is not being read	Use a high-quality industrial SD card. Support will be given to: <ul style="list-style-type: none"> • SDSC bis 2GB • SDHC 2GB-32GB • SDXC 32GB-2TB

	Logging-file is not opened correctly in Excel	Set the settings for the list separator to semicolon ';'. You find it in the system control in the settings for the number format.
Print	Screenshot could not be created	No memory inserted Micro SD card must be inserted before switching on Micro SD card memory is full
Connect	Bluetooth connections to wireless temperature clamp not possible	Enable Bluetooth on the temperature clamp, enable Bluetooth on the REFMATE Test in free field conditions without interference from radio obstructions Set the temperature clamp to T1 and T2
Mechanics	Hook falls out	Push hook back in again
	Knobs are not fix anymore	Replace the knobs, see spare parts
	Flexible hoses cannot be attached anymore	Is the thread broken at the flange, replace the flange, see spare parts
Other	Program freezes	Remove the battery, put it back and restart the REFMATE
	It takes a long time to start the device	Delete the firmware and new refrigerant from SD card

9 Guarantee

Your new, state-of-the-art REFMATE has been developed in accordance with the latest findings in occupational physiology and ergonomics. REFCO Manufacturing Ltd has been certified according to DIN EN ISO 9001:2008. Regular quality control checks as well as an accurate manufacturing process guarantee reliable functionality and are the basis for the REFCO guarantee, in accordance with the General Terms and Conditions of Sale and Delivery applicable on the day of delivery. Excluded from the guarantee are damages caused by obvious maltreatment and wear and tear.

10 Return and disposal

The REFMATE manifold has been developed for long-term use. Attention was paid to energy saving and environmental compatibility at the material procurement and production stages. REFCO Manufacturing Ltd feels responsible for its products throughout their entire lifespan and has therefore been certified in accordance with DIN EN ISO 14001:2004. When decommissioning the device, the user should observe their country's applicable disposal regulations. The housing is made of ABS and TPE, the pressure-bearing metals are aluminium and brass. The plastic case is made of PE.



11 Spare parts and accessories

Spare parts	Designation	Part no.
Replacement knobs (4-Way)	M4-7-SET-B+N+R+Y	4687094
Replacement knobs (2-way)	M2-7-SET-B+R	4687079
Complete valve set	M2-10-95-R/2	4687104
Piston	M4-6-04-R/10	4662624
Sight glass assembly with 2 gaskets	M4-6-11	4491018
Key for Manifold sight glasses	M4-6-11-T	4493169
Threaded Y-Style	A-31452-Y/3	4687951
Complete valve set, 4 pieces	M2-10-95-R/4	4687105
Valve set assemblies, 4 pieces	M4-6-04-R/4	4687093
Accessories		
Temperature sensor	TEMP SENSOR	4681394
Temperature clamp	TEMP-CLAMP	4681466
Wireless temperature clamp	WIRELESS-TEMP-CLAMP	4687785
Plastic case	REFMATE CASE	4688082

1	EINLEITUNG	27
2	ALLGEMEINES	27
3	TECHNISCHE DATEN	30
4	PRODUKT- UND TEILEBESCHREIBUNG	31
4.1	TEILEBESCHREIBUNG.....	31
4.2	KNÖPFE UND NAVIGATION.....	33
5	TRANSPORT, VERPACKUNG UND LAGERUNG	34
5.1	TRANSPORT	34
5.2	VERPACKUNG	34
5.3	LAGERUNG	34
6	INBETRIEBNAHME UND FUNKTIONEN.....	35
6.1	INBETRIEBNAHME	35
6.1.1	<i>Analog Display</i>	37
6.1.2	<i>Datenlogger</i>	38
6.1.3	<i>Menu</i>	40
7	WARTUNG	44
7.1	AKTUALISIERUNG DER KÄLTEMITTEL	44
7.2	AKTUALISIERUNG DER FIRMWARE.....	45
8	PROBLEMBEHANDLUNG.....	46
9	GARANTIE.....	48
10	RÜCKSENDUNG UND ENTSORGUNG	48
11	ERSATZTEILE UND ZUBEHÖR.....	49

1 Einleitung



Wir gratulieren Ihnen recht herzlich zum Kauf dieses Geräts.

Die aktuelle Bedienungsanleitung ist auf www.refco.ch downloadbar.

2 Allgemeines

Bevor Sie die Arbeit mit der Monteurhilfe aufnehmen, lesen Sie aufmerksam die Bedienungsanleitung. Sie gibt Ihnen wichtige Hinweise für den reibungslosen Betrieb, den Unterhalt und die Entsorgung der Monteurhilfe.

Konformität

	<p>Dieses Gerät erfüllt die Konformität zu den relevanten europäischen Richtlinien. Die Konformitätserklärung ist im genannten Kontakt oder der REFICO - Website abrufbar.</p>
	<p>Dieses Gerät erfüllt die Anforderungen gemäss Teil 15 der FCC-Bestimmungen. Der Betrieb erfolgt unter den nachstehenden Bedingungen:</p> <ol style="list-style-type: none"> (1) Dieses Gerät darf keine Interferenzen erzeugen, und (2) Dieses Gerät muss Interferenzen verkraften können einschliesslich Interferenzen, die zu Fehlern im Betrieb führen können. <p>FCC ID: XPYNINAB1</p>
	<p>Dieses Gerät entspricht den lizenzfreien RSS-Standards gemäss Industry Canada.</p> <p>Der Betrieb erfolgt unter nachfolgenden Bedingungen:</p> <ol style="list-style-type: none"> (1) Dieses Gerät darf keine Interferenzen erzeugen, und (2) Dieses Gerät muss Interferenzen verkraften können einschliesslich Interferenzen, die zu Fehlern im Betrieb führen können. <p>IC ID: 8595A-NINAB1</p>

	<p>RCM: Regulatory Compliance Mark</p> <p>Dieses Gerät entspricht den Anforderungen der RCM-Bestimmungen.</p>
<p>RoHS</p>	<p>RoHS: Restriction of Hazardous Substances</p> <p>Dieses Gerät erfüllt die Bestimmungen der EU-Richtlinie RoHS.</p> <p>RoHS 2011/65/EU beinhaltet 2015/863/EU</p> <p>Das Gerät enthält keine verbotenen Substanzen oberhalb der Grenzwerte.</p>
<p>REACH</p>	<p>Gemäss Artikel 33 der REACH-Verordnung 1907/2006 bestätigen wir, dass dieses Gerät und die Verpackung, in Übereinstimmung mit Artikel 57 der REACH-Verordnung 1907/2006 ist.</p> <p>Dieses Gerät und die Verpackung enthalten keinerlei SVHC, spezifiziert in der aktuellen Kandidatenliste (Artikel 59), mit einer Konzentration von über 0,1%.</p>

Wichtige Sicherheitshinweise

Lesen Sie alle Sicherheitshinweise gründlich durch und halten Sie sie ein:
Symbolerklärung:

Warnung!



... weist auf eine möglicherweise gefährliche Situation hin, die zu schweren Verletzungen führen kann, wenn sie nicht gemieden wird.

Gefahr!



... kennzeichnet Gefährdung durch elektrischen Strom. Bei Nichtbeachtung der Sicherheitshinweise besteht die Gefahr schwerer oder tödlicher Verletzungen.

Sicherheitshinweise:



Die Monteurhilfe darf nicht für andere Zwecke ausserhalb des Klima-Kältebereichs eingesetzt werden.



Die Monteurhilfe darf nicht für Drücke, welche höher sind als 60bar / 870psi / 6000kPa / 6MPa eingesetzt werden.



Die Monteurhilfe darf unter keinen Umständen als Druckreduzierventil eingesetzt werden, insbesondere nicht beim Einsatz von Stickstoff N₂



Die Monteurhilfe darf nicht mit dem Kältemittel Ammoniak (NH₃ / R717) und nicht in EX Zonen eingesetzt werden.



Die Monteurhilfe darf nicht dem Regen ausgesetzt, sowie nicht in feuchter oder nasser Umgebung benutzt werden.



Beim Arbeiten mit der Monteurhilfe sind immer eine Schutzbrille und Handschuhe zu tragen.



REFCO- Produkte wurden speziell entwickelt und hergestellt für die Handhabung durch ausgebildete Kälte-Techniker. Aufgrund der hohen Drücke sowie der chemischen und physikalischen Gase, die in Kältesystemen verwendet werden, lehnt REFCO jede Verantwortung und Haftung bei Unfällen, Verletzungen und Tod ab.



REFCO weist ausdrücklich darauf hin, die Produkte ausschliesslich durch professionell ausgebildete Fachleute einzusetzen ist. Kein Gebrauch für Kinder und nicht befähigte Personen.

Bestimmungsgemässer Gebrauch

Die Monteurhilfe ist zum Messen und Einstellen der Druck- und Temperaturverhältnisse in mobilen und stationären Kälte-Erzeugnis Anlagen sowie Wärmepumpen entwickelt. Der Einsatz dieses REFCO Produktes ist einzig durch ausgebildete Kältetechniker zugelassen.

3 Technische Daten

Eigenschaft	Wert	
Druckbereich	-0.95 bis 60bar	
Max. Überdruck	80 bar	
Druckgenauigkeit	±0.5% (Klasse 0.5)	
Druckeinheiten	bar / psi / kPa / MPa / kg/cm ²	
Druckauflösung	0.01 bar / 0.5psi / 1kPa / 0.001MPa / 0.01 kg /cm ²	
Externe Temperaturfühler	Temperaturbereich	-40°C bis +125°C / -40°F bis +257°F
	Anschluss	K-type
	Temperaturgenauigkeit	+/- 1 K
	Auflösung	0.1°C / 0.1°F
Temperaturzange	Temperaturbereich	-40°C bis +125°C / -40°F bis +257°F
	Anschluss	K-type
	Temperaturgenauigkeit	+/- 1 K
	Auflösung	0.1°C / 0.1°F
	Rohrdurchmesser Temperaturzange	6 mm bis 38 mm ¼" bis 1 ½"
	Rohrdurchmesser Wireless Temp.zange	6 mm bis 42 mm ¼" bis 1 ⅝"
Umgebungstemperatur	-20°C bis +50°C / -4°F bis +122°	
Stromversorgung	4 x 1.5 V AA/Mignon/LR6 oder USB Powerbank	
Lagertemperatur	- 20°C bis + 60°C / -4°F bis 140°F	

4 Produkt- und Teilebeschreibung

Folgende Teile werden mitgeliefert:

In Standardausführung inbegriffen	Weiteres Zubehör
Digitale Monteurliste 2 Stück Temperaturfühler des Typs K mit 1.5m Kabellänge 5 Stück Füllschläuche 4 x AA Batterien Micro SD Karte 8GB (in Gerät eingesetzt) Kunststoffkoffer Bedienungsanleitung Kalibrierprotokoll USB-Kabel 1.8 m	2 Stück Temperaturzangen des Typs K mit 1.5m Kabellänge 2 Stück Wireless Temperaturzangen des Typs K

4.1 Teilebeschreibung

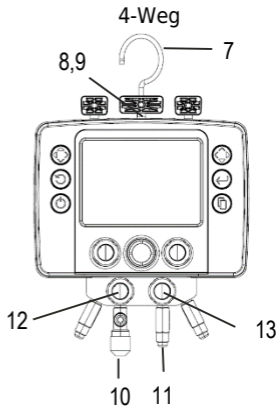
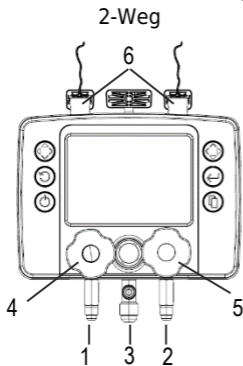

1.	Niederdruck-Anschluss 1/4" SAE	Um ein Schlauch anzuschliessen
2.	Hochdruck-Anschluss 1/4" SAE	Um ein Schlauch anzuschliessen
3.	Kältemittel / Vakuum Anschluss 1/4" SAE	Um ein Schlauch anzuschliessen
4.	Niederdruck-Ventil (Blau)	Nach links drehen zum Öffnen oder im Uhrzeiger drehen zum Schliessen
5.	Hochdruck-Ventil (Rot)	Nach links drehen zum Öffnen oder im Uhrzeiger drehen zum Schliessen
6.	K-Type Buchse	Steckplatz für Temperaturfühler oder Temperaturzange
7.	Haken	Um das Gerät aufzuhängen
8.	Micro-USB Buchse	Steckplatz für Micro-USB Kabel um mit einem Computer zu verbinden
9.	SD-Karte Buchse	Steckplatz für die SD-Karte
10.	Vakuum Anschluss 3/8" SAE	Um ein Schlauch anzuschliessen
11.	Kältemittel Anschluss 1/4" SAE	Um ein Schlauch anzuschliessen
12.	Vakuumventil (Gelb)	Nach links drehen zum Öffnen oder im Uhrzeiger drehen zum schliessen
13.	Kältemittelventil (Schwarz)	Nach links drehen zum Öffnen oder im Uhrzeiger drehen zum Schliessen

4.2 Knöpfe und Navigation



Nach LINKS
oder nach
OBEN



Nach
RECHTS
oder nach
UNTEN



ZURÜCK
Taste



EINGABE /
AUSWAHL



Power
ON/OFF



WECHSEL
Taste

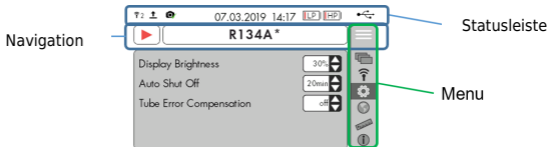

Drücken Sie  um die Kältemittelliste zu öffnen.

Drücken Sie  um nach rechts zu gelangen



Drücken Sie  um das Menu zu öffnen.

Drücken Sie  um nach rechts zu gelangen



Drücken Sie  um das Aufzeichnungsmenu zu öffnen.

Wichtige Hinweise	
Garantiedatum wird innert 5 Minuten festgelegt!	Eine einmalige Garantieverlängerung ab Datum der Inbetriebnahme wird gewährt. Dieses Datum wird festgesetzt, wenn das Gerät das erste Mal mehr als 5 Minuten in Betrieb gesetzt wird. Dies kann auch bei Präsentationszwecken an der Verkaufsstelle erfolgen und kann im Anschluss nicht mehr korrigiert werden!
AA Batterien nach Benutzung aus REFMATE entfernen	Auslaufende Chemikalien aus Batterien zerstören das REFMATE. Wird das Gerät länger nicht benutzt, müssen die AA Batterien aus dem REFMATE entfernt werden. Auf auslaufende Chemikalien besteht keine Garantie. 
SD Karte bei REFMATE belassen	Es wird empfohlen, die SD Karte im REFMATE zu belassen, um ein Verlust der Karte zu verhindern!

5 Transport, Verpackung und Lagerung

5.1 Transport

Die digitale Monteurhilfe wird mit Kunststoffkoffer zum Schutz der Teile geliefert. Der Kunststoffkoffer schützt vor Vibrationen beim Transport und bei der Handhabung. Nutzen Sie immer den Kunststoffkoffer als Schutz der Monteurhilfe und Zubehör und sichern Sie diesen beim Transport auf der Ladefläche. Die Lagerungsbedingungen müssen auch im Transport eingehalten werden.

5.2 Verpackung

Der Kunststoffkoffer besteht aus Polyethylen und schützt die digitale Monteurhilfe vor Sturzschäden. Ebenso können Zubehör mitgetragen werden. Dies beinhaltet die inbegriffenen Temperaturfühler wie auch die Zubehörteile Temperaturzange, Wireless Temperaturzange und einen Vakuumsensor.

5.3 Lagerung

Die Lagerungstemperaturen müssen eingehalten werden und die Verpackung muss geschlossen sein.

6 Inbetriebnahme und Funktionen

6.1 Inbetriebnahme

Vorbereitung zur Inbetriebnahme

4 Batterien in das Batteriefach auf der Rückseite einlegen. Beachten Sie die richtige Polarität der Batterien. Falls Sie das REFMATE über längere Zeit nicht gebrauchen, entfernen Sie die Batterien aus dem Batteriefach.

Entfernen Sie die Display-Schutzfolie



Gerät starten

Drücken Sie 

Nach ein paar Sekunden ist das Gerät bereit.

- Kontrollieren Sie den Batterie Status

Bemerkung: In den ersten 5 Minuten beim erstmaligen Einschalten kann das Datum und die Uhrzeit nicht verändert werden.



Nullen der Drucksensoren

Drücken und halten Sie 

- Die Druckanzeige zeigt Null an

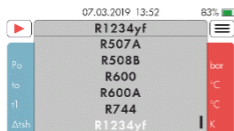
Kältemittel Auswahl

Durch Drücken von  gelangen Sie in die Kältemittelbibliothek.

Wählen Sie das gewünschte

Kältemittel indem Sie  oder

 drücken. Um die Auswahl zu

treffen drücken Sie .

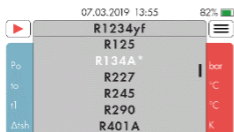
**Kältemittel Favoriten**

Durch Drücken und halten von  für min. 3 Sekunden können Sie Favoriten auswählen.

*Favoriten werden mit einem * gekennzeichnet und erscheinen in der Liste ganz oben.*

Erneutes Drücken und Halten von

 entfernt den Favoriten aus der Favoritenliste.

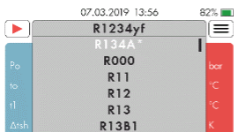

6.1.1 Analog Display

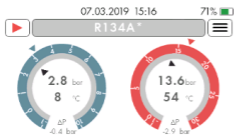
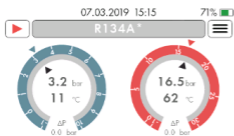
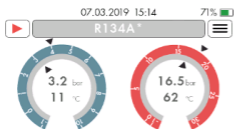
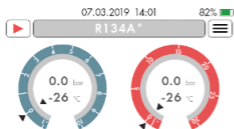

Überhitzung und Unterkühlung

Durch Drücken von  können Sie zwischen der digitalen und analogen Anzeige wechseln.

Schleppzeiger

Der höchste erreichte Druck wird im äusseren Ring der Analoganzeige angezeigt.

--	Keine Messung/Wert
OOR	Out Of Range
OCF	Over Critical Point
no cal.	Gerät nicht kalibriert

Referenzdruck setzen

Um ein Referenzdruck zu setzen, drücken und halten Sie  für 3 Sekunden.



Der Druckunterschied wird Ihnen nun zusätzlich angezeigt.

Um den Referenzdruck zu entfernen, drücken und halten Sie  für 3 Sekunden.



Die zwei obengenannten Funktionen stehen nur in der Analoganzeige zur Verfügung.

6.1.2 Datenlogger 



07.03.2019 14:02 81% 

 R134A* 



Set	Sample Rate	Duration
	1 Sample/min	4 h
	6 Sample/min	8 h
	30 Sample/min	12 h
	60 Sample/min	24 h
	120 Sample/min	48 h

 



07.03.2019 14:03 81% 

 R134A* 



Set	Sample Rate	Duration
	1 Sample/min	8 h
	6 Sample/min	12 h
	30 Sample/min	24 h
	60 Sample/min	48 h
	120 Sample/min	168 h

 



07.03.2019 14:03 81% 

 R134A* 

Set	Sample Rate	Duration
	1 Sample/min	8 h
	6 Sample/min	12 h
	30 Sample/min	24 h
	60 Sample/min	48 h
	120 Sample/min	168 h



 

07.03.2019 14:04 81% 



 R134A* 

LP		HP	
Po	0,00 bar	Pc	0,00 bar
to	-26,2 °C	tc	-26,2 °C
tl	--,-- °C	tl	--,-- °C
Atsh	--,-- K	Atsc	--,-- K

07.03.2019 14:04 81% 

 R134A* 

Set	Sample Rate	Duration
	1 Sample/min	8 h
	6 Sample/min	12 h
	30 Sample/min	24 h
	60 Sample/min	48 h
	120 Sample/min	168 h

 REF_M_20190307_140344.csv 

Daten aufzeichnen

Stellen Sie sicher, dass sich eine SD-Karte im dafür vorgesehenen Slot befindet.

Gehen Sie in der Navigation mit



zu  und drücken Sie

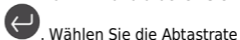

. Wählen Sie die Abtastrate

durch drücken von :

Werte zwischen 1-120 S/min

(S/min = Messpunkte / Minute)

Wählen Sie die Messdauer mit



Werte zwischen 15min -168h

Starten Sie die Aufnahme mit



Der Dateiname wird automatisch erstellt und angezeigt.

Während der Aufnahme sind Kältemittelauswahl und die Einstellungen gesperrt.

Um die Aufnahme vorzeitig zu beenden gehen Sie zu 

und drücken Sie 

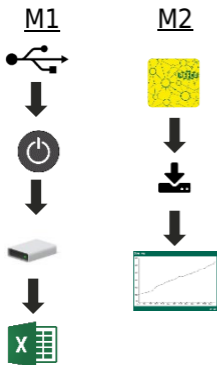

Daten Auswerten

Möglichkeit 1

Verbinden Sie das Gerät mit Hilfe eines USB-Kabels mit einem Computer.

Schalten Sie Ihr REFMATE ein.

Das Gerät wird Ihnen als USB Laufwerk angezeigt.

Die Daten sind als Excel Dateien im csv-Format verfügbar.

Möglichkeit 2

Datentransfer zum APP:

Öffnen Sie die App und wählen

Sie 'Transfer logged data'  .
Wählen sie das gewünschte File.

Lassen Sie sich den Zeitverlauf darstellen.

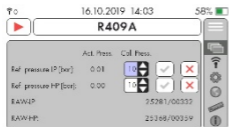

Feld Kalibrierung mit Referenzdruck

Gehen Sie in der Navigation mit

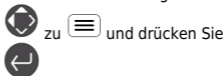

Unter dem Register  können Sie die Feldkalibrierung der Drucksensoren vornehmen.

Um die Kalibrierung zu starten geben Sie den PIN ein.

Der PIN lautet 0-0-0-9

Das Gerät darf zu diesem Zeitpunkt nicht unter Druck stehen!

Drücken Sie

Schliessen Sie das Gerät an ein System mit definiertem Druck.

*Druckbereich: 10-60Bar,
150-850 psi*

Je höher der Kalibrierdruck, desto genauer die Kalibrierung!

Warten Sie, bis der Kalibrierdruck dem Referenzdruck entspricht. Durch drücken von wird dann der jeweilige Drucksensor kalibriert.

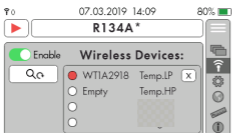
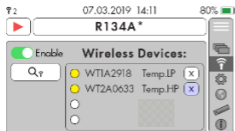
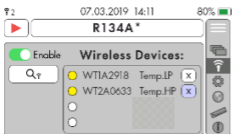
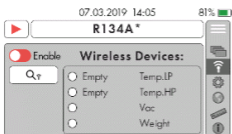

Verbindungen

Unter dem Register  finden Sie die möglichen Drahtlosverbindungen.

Unter "EIN" können Sie die Verbindung einschalten.

Verbindungen werden mit



gesucht und automatisch erstellt. Beachte: die Wireless Temperaturzangen müssen intern die Bezeichnungen T1 für LP und T2 für HP haben.

Bereits einmal verbundene Geräte werden gespeichert und nach Einschalten der Drahtlosfunktion automatisch verbunden.

Die Anzahl verbundener Geräte wird oben links auf dem Display angezeigt. Es erscheint eine zusätzliche Batterieanzeige falls die Wireless Temperaturzange einen Batteriewechsel benötigt.

Bedeutung der Farbanzeige:

Grün: Gerät verbunden

Gelb: Wireless Zange verbunden und Temperaturfühler eingesteckt.

Der eingesteckte Sensor hat Priorität und wird angezeigt.



Rot: Gespeichertes Gerät nicht verbunden.

Allgemeine Einstellungen

Unter dem Register  finden Sie diverse Einstellungsmöglichkeiten.

Die Display Helligkeit kann individuell eingestellt werden.

Schnellfunktion:

Drücken und Halten Sie  während Sie  oder  antippen. Die Helligkeit ändert sich in 5% Schritten.

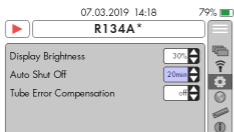

Unter der automatischen Abschaltung wird die Zeit bis zur automatischen Ausschaltung eingestellt. Diese Funktion kann deaktiviert werden.

Einstellmöglichkeiten: 1-60min und off

Die Rohrfehlerkorrektur ist eine Temperatur-Korrektur-Funktion welche den Messfehler vom Rohr zum Kältemittel kompensiert.

Diese Funktion kann "Ein" und "Aus" geschaltet werden.

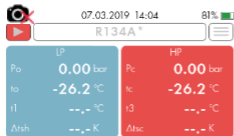
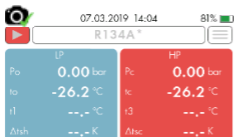
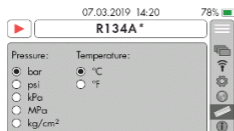

Zeit und Sprach Einstellungen

Unter dem Register  finden Sie diverse länderspezifische Einstellungen.

Zeit, Datum und Sprache können gewählt werden.

Standardmässig ist Englisch als Sprache eingestellt.

Einheiten Einstellungen

Unter dem Register  finden Sie die Einheiten für den Druck und die Temperatur.

Schnellfunktion Printscreen

Durch drücken und Halten von



für 5 Sekunden, kann von beliebigem Bildschirm ein Printscreen erstellt werden.

Die Datei wird auf der SD-Karte als BMP gespeichert.



Printscreen erfolgreich



Printscreen nicht erfolgreich



Die Dateien können wie unter dem Punkt Daten auswerten verwendet werden.



7 Wartung

Die digitale Monteurhilfe erfordert im regen Einsatz Unterhaltsarbeiten. Diese sind:

- Reinigen Sie den Bildschirm und die Gehäuseoberfläche mit einem Putzlappen und Reinigungsmittel.
- Für die Reinigung des Gerätes dürfen keine aggressiven Reinigungs- oder Lösungsmittel verwendet werden. Schwache Haushaltsreiniger und Seifenlaugen dürfen verwendet werden.
- Die Anschlüsse und Füllschläuche sind vor jedem Einsatz einer Sichtprüfung auf mechanische Beschädigungen zu unterziehen und bei Beschädigung auszutauschen.
- Die Dichtungen einer Monteurhilfe unterliegen naturgemäss einem mechanischen und alterungsbedingten Verschleiss. Daher ist die Monteurhilfe regelmässig vom Anwender auf Dichtheit zu prüfen.
- Bei undichten Ventilen ist der Kolben zu ersetzen (M4-6-04-R/10).
- Zum Wechseln des Schauglases an der Monteurhilfe ist das REFCO Spezialwerkzeug M4-6-11-T zu verwenden.



7.1 Aktualisierung der Kältemittel



1	Melden Sie sich im App  an und gehen Sie zum Abschnitt Geräte-Aktualisierung
2	Unter Kältemittel finden Sie die neusten Kältemittel
3	Wählen Sie die aktuellsten Kältemittel aus der Liste aus und senden Sie sie per E-Mail
4	Verbinden Sie das REFMATE mit deinem PC via USB-Kabel 

5	Wenn das REFIMATE eingeschaltet wird, erscheint ein neues Laufwerk. 
6	Kopieren Sie die erhaltene Datei von Ihrem E-Mail auf das erschienene Laufwerk.
7	Schalten Sie das REFIMATE aus  und starten Sie es neu  .
8	Die Kältemittelliste wurde aktualisiert.

Der Hersteller übernimmt keine Verantwortung bei Einsatz von falschen, respektive durch Fremde modifizierte Kältemittel.

7.2 Aktualisierung der Firmware

1	Melden Sie sich im APP  an und gehen Sie zum Abschnitt Geräte-Aktualisierung
2	Unter Firmware finden Sie die neuste Firmware-Version.
3	Wählen Sie die aktuelle Firmware aus und versenden Sie sie per E-Mail an sich
4	Verbinden Sie das REFIMATE mit Ihrem PC via USB-Kabel 
5	Wenn das REFIMATE eingeschaltet wird, erscheint ein neues Laufwerk. 

6	Kopieren Sie die erhaltene Datei von Ihrem E-Mail auf das erschienene Laufwerk.
7	<p>Schalten Sie das REFIMATE aus. </p> <p>Starten Sie das REFIMATE durch Drücken und halten der folgenden Tastenkombination:</p> <p>Zuerst  dann zusätzlich  für eine Sekunde bis der Display sich einschaltet.</p>
8	Die aktuelle Firmware wird vom Speicher gelöscht und die neue installiert. Dauer: ca. 1.5min

8 Problembehandlung

	Problem	Massnahme
Messen	Es wird keine Temperatur angezeigt	Messbereich ist überschritten Einsatzbereich ändern oder ersetzen Sie die Temperaturfühler
	Druck wird falsch angezeigt und kann nicht mehr bei Atmosphäre auf 0 gestellt werden	Führen Sie eine Kalibrierung der Drucksensoren durch.
	Batterielaufzeit reicht nicht für Test aus	Speisen Sie das Gerät über USB mit Power Bank oder mit Netzteil mit USB Anschluss
Loggen	No recording wird angezeigt	Kein Datenspeicher ist eingesetzt Micro SD-Karte muss vor dem Einschalten eingesetzt sein. Datenspeicher Micro-SD Karte ist voll.

	SD Karte wird nicht gelesen	Setzen Sie eine industrielle SD Karte hoher Qualität ein. Unterstützt werden : <ul style="list-style-type: none"> • SDSC bis 2 GB • SDHC 2GB-32GB • SDXC 32GB-2TB
	Logging-file wird nicht richtig geöffnet in Excel	Setzen Sie in der Systemsteuerung des PCs bei den Einstellungen für das Zahlenformat das Listentrennzeichen auf ‘;’
Printscreen	Icon Printscreen wird nicht erfolgreich angezeigt	Kein Datenspeicher ist eingesetzt Micro SD-Karte muss vor dem Einschalten eingesetzt sein. Datenspeicher Micro-SD Karte ist voll.
Verbinden	Keine Bluetooth-Verbindungen zu Wireless Temperaturzange möglich	Schalten Sie Bluetooth der Temperaturzange ein, Schalten Sie Bluetooth des REFMATE ein. Prüfen Sie in Freifeldbedingungen ohne störende Funkhindernisse. Stellen Sie die Temperaturzange auf T1 und T2 ein
Mechanik	Haken fällt raus	Haken wieder reindrücken
	Drehknöpfe halten nicht	Ersetzen Sie die Drehknöpfe, siehe Ersatzteile
	Schläuche können nicht mehr aufgebracht werden	Sind die Gewinde am Bördel defekt, ersetzen Sie die Bördel, siehe Ersatzteile
Other	Programm blockiert	Nehmen Sie die Batterie heraus, setzen Sie sie wieder ein und starten Sie den REFMATE neu.
	Aufschalten dauert lange	Entfernen Sie alle unnötigen Dateien von der SD Karte (Firmware und Kältemittel)

9 Garantie

Ihre neues REFMATE ist nach den neuesten arbeitsphysiologischen und ergonomischen Gesichtspunkten entwickelt worden und entspricht dem aktuellen Stand der Technik. Das Unternehmen REFCO Manufacturing Ltd wurde nach DIN EN ISO 9001:2008 zertifiziert. Regelmässige Qualitätskontrollen sowie eine sorgfältige Verarbeitung gewährleisten eine solide Funktionsfähigkeit und ermöglichen die REFCO-Garantie entsprechend den am Tage der Auslieferung geltenden allgemeinen Verkaufs- und Lieferbedingungen. Ausgenommen davon sind durch offensichtlich unsorgfältige Behandlung sowie durch Verschleiss entstehende Schäden.

10 Rücksendung und Entsorgung

Die REFMATE-Monteurhilfe ist für den Langzeitgebrauch entwickelt worden. Bei der Materialbeschaffung und der Produktion wurde auf Energieersparnis und Umweltverträglichkeit geachtet. REFCO Manufacturing Ltd sieht sich „zeitlebens“ verantwortlich für seine Produkte. Aus diesem Grund hat sich REFCO Manufacturing nach der DIN EN ISO 14001:2004 zertifizieren lassen. Bei Ausserbetriebsetzung des Gerätes sollte der Anwender die geltenden Entsorgungsvorschriften seines Landes beachten. Das Gehäuse ist ABS und TPE, die drucktragenden Metalle sind Aluminium und Messing. Der Kunststoffkoffer ist aus PE.



11 Ersatzteile und Zubehör

Ersatzteile	Bezeichnung	Best-Nr.
Ersatz-Drehknöpfe (4-Weg)	M4-7-SET-B+N+R+Y	4687094
Ersatz-Drehknöpfe (2-Weg)	M2-7-SET-B+R	4687079
Ventileinsatz-Set	M2-10-95-R/2	4687104
Ventil-Kolben	M4-6-04-R/10	4662624
Schauglas mit 2 Dichtungen	M4-6-11	4491018
Schlüssel für Monteurhilfe-Schauglas	M4-6-11-T	4493169
Bördel Y-Stück	A-31452-Y/3	4687951
Ventileinsatz komplett, 4 Stück	M2-10-95-R/4	4687105
Kolben komplett zu Ventileinsatz, 4 Stück	M4-6-04-R/4	4687093
Zubehör		
Temperaturfühler	TEMP-SENSOR	4681394
Temperaturzange	TEMP-CLAMP	4681466
Wireless Temperaturzange	WIRELESS-TEMP-CLAMP	4687785
Kunststoffkoffer	REFIMATE-CASE	4688082

Dies ist die Deutsche Originalfassung der Bedienungsanleitung

1	INTRODUCTION	51
2	GÉNÉRALITÉS	51
3	CARACTÉRISTIQUES TECHNIQUES.....	54
4	DESCRIPTION DU PRODUIT ET DES PIÈCES ..	55
4.1	DESCRIPTION DES PIÈCES.....	55
4.2	BOUTONS ET NAVIGATION	57
5	TRANSPORT, EMBALLAGE ET STOCKAGE	58
5.1	TRANSPORT	58
5.2	EMBALLAGE	58
5.3	STOCKAGE.....	58
6	MISE EN SERVICE ET FONCTIONS.....	59
6.1	MISE EN SERVICE	59
6.1.1	<i>Écran analogique</i>	<i>61</i>
6.1.2	<i>Enregistrement de données</i>	<i>62</i>
6.1.3	<i>Menu</i>	<i>64</i>
7	MAINTENANCE	68
7.1	MISE À JOUR DES RÉFRIGÉRANTS	68
7.2	MISE À JOUR DU LOGICIEL	69
8	RÉSOLUTION DES PROBLÈMES	70
9	GARANTIE.....	72
10	RETOUR ET MISE AU REBUT	72
11	PIÈCES DE RECHANGE ET ACCESSOIRES	73



1 Introduction

Vous avez fait l'acquisition d'un by-pass digital REFMATE et nous vous félicitons de ce choix. Le manuel actuel est disponible sur www.refco.ch.

2 Généralités

Avant de commencer tout travail avec le by-pass digital, veuillez lire attentivement le manuel d'utilisation. Celui-ci vous fournit des consignes importantes pour le fonctionnement parfait, l'entretien et la mise au rebut du by-pass digital.

Conformité

	<p>Cet appareil est conforme aux directives européennes applicables. La déclaration de conformité est disponible auprès du contact mentionné ou sur le site web de REFCO.</p>
	<p>Cet appareil satisfait aux exigences indiquées dans la Partie 15 des prescriptions de la FCC. Son fonctionnement s'effectue dans les conditions mentionnées ci-dessous :</p> <ol style="list-style-type: none"> (1) Cet appareil ne doit produire aucune interférence nuisible, et (2) Cet appareil doit accepter toute interférence reçue, y compris celles pouvant entraîner un fonctionnement indésirable. <p>ID FCC: XYPNINAB1</p>
	<p>Cet appareil correspond aux standards RSS sans licence conformément à Industry Canada. Son fonctionnement s'effectue dans les conditions mentionnées ci-dessous :</p> <ol style="list-style-type: none"> (1) Cet appareil ne doit produire aucune interférence nuisible, et (2) Cet appareil doit accepter toute interférence reçue, y compris celles pouvant entraîner un fonctionnement indésirable. <p>ID IC: 8595A-NINAB1</p>

	<p>RCM: Regulatory Compliance Mark</p> <p>Cet appareil satisfait aux exigences des prescriptions RCM.</p>
<p>RoHS</p>	<p>RoHS: Restriction of Hazardous Substances</p> <p>Cet appareil est conforme aux prescriptions de la directive UE RoHS.</p> <p>RoHS 2011/65/EU contient 2015/863/EU</p> <p>L'appareil ne contient aucune substance interdite au-dessus des valeurs limites.</p>
<p>REACH</p>	<p>Conformément à l'article 33 du règlement REACH 1907/2006, nous confirmons que cet appareil et son emballage sont en accord avec l'article 57 du règlement REACH 1907/2006.</p> <p>Cet appareil et son emballage ne contiennent aucune substance préoccupante (SVHC), spécifiée dans la liste actuelle de candidats (article 59), dans une concentration de plus de 0,1 %.</p>

Consignes de sécurité importantes

Veillez lire attentivement toutes les consignes de sécurité et les respecter:

Explication des symboles

Attention!



... renvoie à une situation potentiellement dangereuse pouvant entraîner des blessures graves lorsqu'elle n'est pas évitée.

Danger!



... renvoie à un risque de choc électrique. Le non-respect des consignes de sécurité entraîne un risque de blessures graves voire mortelles.

Consignes de sécurité



Le by-pass digital ne doit pas être utilisé à des fins autres que celles du domaine de la climatisation-réfrigération.



Le by-pass digital ne doit pas être utilisé pour des pressions supérieures à 60 bars / 870 psi / 6000 kPa / 6 MPa.



Le by-pass digital ne doit en aucun cas être utilisé comme vanne réductrice de pression, et surtout pas avec de l'azote N₂.



Le by-pass digital ne doit pas être utilisé avec du produit réfrigérant à base d'ammoniaque (NH₃ / R717) et pas en EX-zones.



Le by-pass digital ne doit pas être exposé aux précipitations, et ne doit pas être utilisé dans un environnement humide ou mouillé.



Porter toujours des lunettes de protection et des gants lorsque vous travaillez avec le by-pass digital.



Les produits REFCO ont été spécialement développés et fabriqués pour être manipulés par des techniciens en réfrigération qualifiés. En raison des pressions élevées ainsi que des gaz chimiques et physiques utilisés dans les systèmes de réfrigération, REFCO décline toute responsabilité en cas d'accidents, de blessures ou de décès.



REFCO attire expressément l'attention sur le fait que ses produits doivent être utilisés exclusivement par des professionnels qualifiés.

Utilisation conforme

Le by-pass digital est conçu pour mesurer et régler des rapports de pression et de température dans des installations mobiles et stationnaires de production de froid telles que les pompes à chaleur. L'utilisation de ce produit REFCO est autorisée uniquement pour les techniciens en réfrigération qualifiés.

3 Caractéristiques techniques

Propriété	Valeur	
Plage de pressions	-0.95 à 60 bar	
Surpression max.	80 bars	
Précision pneumatique	± 0,5 % (classe 0,5)	
Unités de pression	bar / psi / kPa / MPa / kg/cm ²	
Résolution de la pression	0,01 bar / 0,5 psi / 1 kPa / 0,001 MPa / 0,01 kg /cm ²	
Capteur de température externes	Plage de températures	-40 °C à +125 °C / -40 °F à +257 °F
	Raccordement	type K
	Précision thermique	+/- 1 K
	Résolution	0,1 °C / 0,1 °F
Pince de température	Plage de températures	-40 °C à +125 °C / -40 °F à +257 °F
	Raccordement	type K
	Précision thermique	+/- 1 K
	Résolution	0,1 °C / 0,1 °F
	Diamètre de tube pice de température	6 mm à 38 mm ¼" à 1 ½"
	Diamètre de tube pice de température sans fil	6 mm à 42 mm ¼" à 1 ⅝"
Température ambiante	-20 °C à +50 °C / -4 °F à +122 °F	
Alimentation électrique	4 piles 1,5 V AA/mignon/LR6 ou Power Bank USB	
Température de stockage	- 20 °C à + 60 °C / -4 °F à 140 °F	

4 Description du produit et des pièces

Les pièces suivantes sont fournies à la livraison:

Inclus dans le modèle standard	Autres accessoires
1 By-pass digital 2 Capteur de température externes de type K avec un câble de 1,5 m de long 5 Flexibles pour le remplissage 4 Piles AA 1 Micro carte SD 8 GB (insérée dans l'appareil) 1 Mallette en plastique 1 Manuel d'utilisation 1 Protocole de calibrage 1 Câble USB 1,8 m	2 capteur de température externes de type K avec un câble de 1,5 m de long 2 pinces de température sans fil de type K

4.1 Description des pièces

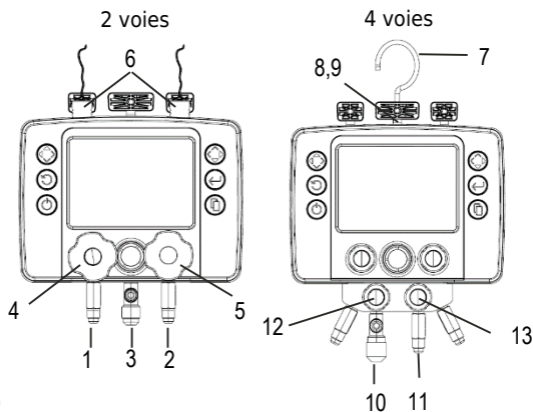

1.	Raccord basse pression 1/4" SAE	Pour le raccordement d'un flexible
2.	Raccord haute pression 1/4" SAE	Pour le raccordement d'un flexible
3.	Raccord réfrigérant / vide 1/4" SAE	Pour le raccordement d'un flexible
4.	Vanne basse pression (bleue)	Tourner vers la gauche pour ouvrir ou dans le sens horaire pour fermer
5.	Vanne haute pression (rouge)	Tourner vers la gauche pour ouvrir ou dans le sens horaire pour fermer
6.	Prise femelle type K	Prise pour sonde de température ou pince de température
7.	Crochet	Pour suspendre l'appareil
8.	Prise femelle micro USB	Prise de câble micro USB pour le branchement d'un ordinateur
9.	Prise carte SD	Prise pour la carte SD
10.	Raccord de vide 3/8" SAE	Pour le raccordement d'un flexible
11.	Raccord réfrigérant 1/4" SAE	Pour le raccordement d'un flexible
12.	Vanne de vide (jaune)	Tourner vers la gauche pour ouvrir ou dans le sens horaire pour fermer
13.	Vanne de réfrigérant (noire)	Tourner vers la gauche pour ouvrir ou dans le sens horaire pour fermer

4.2 Boutons et navigation



Vers la
GAUCHE ou le
HAUT



Vers la DROITE
ou le BAS



Touche
RETOUR



ENTRÉE /
SÉLECTION



Power ON/OFF



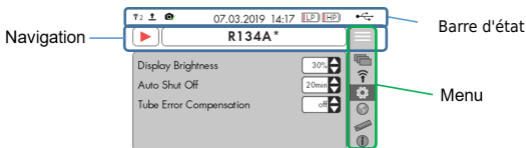

Touche
COMMUTER

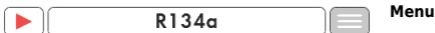

Appuyer  pour ouvrir la list.

Appuyer  pour aller à droit



Appuyer  pour ouvrir le menu.

Appuyer  pour aller à droit



Appuyer  pour ouvrir le menu d'enregistrement.

Remarques importantes	
La date de garantie est déterminée dans un délai de 5 minutes!	Une seule extension de garantie à partir de la date de la mise en service est accordée. Cette date est définie lorsque l'appareil est mis pour la première fois en service pendant plus de 5 minutes. Cette opération peut aussi s'effectuer à des fins de présentation de l'appareil à son point de vente et ne peut plus être corrigée par la suite!
Retirer les piles AA du REFMATE après utilisation	Les fuites de substances chimiques contenues dans les piles détruisent le REFMATE. En cas d'inutilisation prolongée de l'appareil, retirer les piles AA du REFMATE. Aucune garantie sur les fuites de substances chimiques. 
Laisser la carte SD dans le REFMATE	Il est recommandé de laisser la carte SD dans le REFMATE pour éviter de la perdre!

5 Transport, emballage et stockage

5.1 Transport

Le by-pass digital est livré avec une mallette en plastique pour protéger ses pièces. La mallette en plastique protège des vibrations pendant le transport et la manipulation. Utilisez toujours la mallette en plastique pour protéger le by-pass digital et ses accessoires et placez-le en sécurité sur la surface de chargement pendant le transport. Les conditions de stockage doivent également être respectées pendant le transport.

5.2 Emballage

La mallette en plastique est en polyéthylène et protège le by-pass digital des dommages dus aux chutes. Elle permet également de transporter des accessoires. Elle contient les capteur de température fournies de même que les accessoires comme la pince de température, la pince de température sans fil et un capteur de vide.

5.3 Stockage

Les températures de stockage doivent être respectées et la mallette doit être fermé.

6 Mise en service et fonctions

6.1 Mise en service

Préparation à la mise en service

Insérez les 4 piles dans le compartiment situé au dos de l'appareil. Veillez à la polarité correcte des piles. Si vous n'utilisez pas le REFMATE pendant une longue période, retirez les piles du compartiment.

Retirez le film de protection sur l'écran.



Démarrage de l'appareil

Appuyez sur 

L'appareil est prêt après quelques secondes.

- Contrôlez l'état de charge.

Remarque: pendant les cinq premières minutes, la date et l'heure ne peuvent pas être modifiées.



Mise à zéro des capteurs de pression

Appuyez sur  et maintenez la touche enfoncée

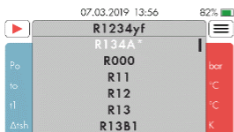
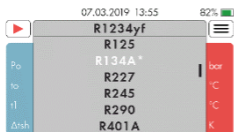
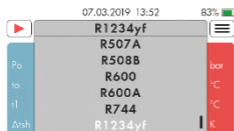

- L'indicateur de pression indique zéro.



Sélection du réfrigérant

Appuyez sur  pour parvenir dans la bibliothèque des réfrigérants.

Sélectionnez le réfrigérant souhaité

en appuyant sur  ou .

Pour valider la sélection, appuyez

sur .

Réfrigérants favoris

Appuyez sur  et maintenez la touche enfoncée pendant au moins 3 secondes pour sélectionner vos favoris.

*Les favoris sont identifiés par * et apparaissent tout en haut dans la liste.*

6.1.1 Écran analogique

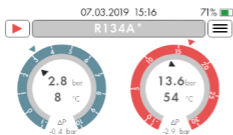
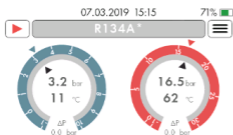
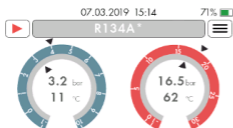
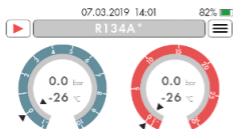
**Surchauffe et sous-refroidissement**

Appuyez sur 

pour passer du mode analogique au mode numérique et vice versa.

Aiguille d'accompagnement

La plus haute pression atteinte reste indiquée dans l'anneau extérieure de l'affichage analogique.

--.-	Aucune mesure
OOR	Out of range
OCP	Over critical point
no cal.	Calibrage manque

Définition d'une pression de référence

Pour définir une pression de référence, appuyez sur  et maintenez la touche enfoncée pendant 3 secondes.

La différence de pression vous est également indiquée.

Pour supprimer la pression de référence, appuyez sur  et maintenez la touche enfoncée pendant 3 secondes.

Les deux fonctions mentionnées ci-dessus s'appliquent uniquement à l'affichage analogique.

6.1.2 Enregistrement de données

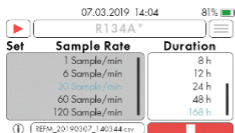
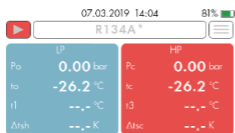
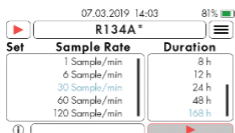
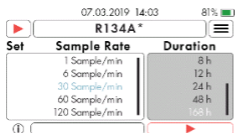
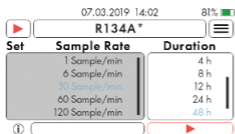

Enregistrement de données

Assurez-vous qu'une carte SD est insérée dans la fente prévue.

Dans la navigation allez avec



Sélectionnez le taux de balayage

avec  :

valeurs entre 1 et 120 S/min
 (S/min = points de mesure / minute)

Sélectionnez la durée de mesure

avec , ,  :

valeurs entre 15 min et 168 h

Lancez l'enregistrement avec



Le nom de fichier est créé automatiquement et s'affiche.

Pendant l'enregistrement, la sélection du réfrigérant et les réglages sont bloqués.

Pour terminer l'enregistrement avant la fin, allez sur 

et appuyez sur 

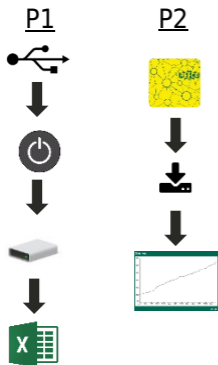

Évaluation des données

Possibilité 1

Connectez l'appareil à un ordinateur à l'aide du câble USB.

Allumez votre REFMATE.

L'appareil s'affiche alors comme un lecteur USB.

Les données sont disponibles au format CSV sous forme de fichiers Excel.

Possibilité 2



Transfert de données vers APP

Ouvrez l'application et sélectionnez Transfer Logged

Data . Sélectionnez le fichier souhaité.

Affichez la durée du transfert.

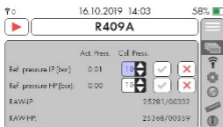
6.1.3

Menu 

Calibrage sur site avec pression de référence

Dans la navigation, allez avec



Vous pouvez entreprendre le calibrage sur site des capteurs de pression dans l'onglet .

Pour lancer le calibrage, entrez le code PIN.

Le code PIN est 0-0-0-9

À ce moment précis, l'appareil ne doit pas être sous pression!

Appuyez 

Raccordez l'appareil à un système présentant une pression définie.

Plage de pressions: 10-60 bars, 150-850 psi

Plus la pression de calibrage est élevée, plus le calibrage est précis!

Attendez jusque la pression de calibrage correspond au pression référence. Appuyez sur  pour calibrer chaque capteur de pression.

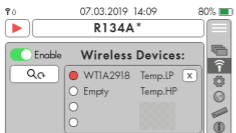
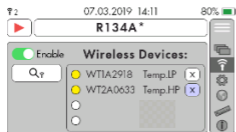
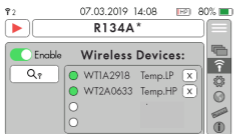

Connexions

Les connexions sans fil possibles se trouvent dans l'onglet .

Appuyez sur «ON» (Enable) pour activer la connexion.

 permet de chercher des connexions et de les activer automatiquement. Faisez attention: Le nom de pince de temperature sans file doit être: T1 pour LP et T2 pour HP.

Des appareils déjà connectés une fois sont enregistrés et connectés automatiquement après activation de la fonction sans fil.

Le nombre d'appareils connectés est indiqué en haut à gauche sur l'écran. Un indicateur supplémentaire sur la charge des piles apparaît dans le cas où la pince de température sans fil nécessite un changement des piles.

Signification de l'affichage en couleur:

Vert: appareil connecté

Jaune: pince sans fil connectée et capteur de température branchées.

Le capteur branché est prioritaire et s'affiche.

Rouge: appareil enregistré non connecté.

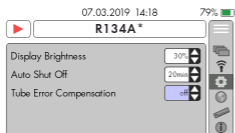
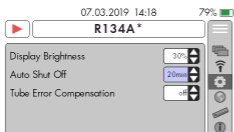
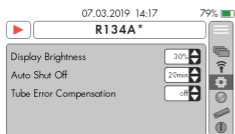



Réglages généraux

Diverses possibilités de réglages se trouvent dans l'onglet .

La luminosité de l'écran peut être réglée individuellement.

Fonction rapide:

Appuyez sur la touche  et maintenez-la enfoncée pendant que vous appuyez sur  ou . La luminosité change par pas de 5 %.

Arrêt automatique permet de régler le délai jusqu'à l'arrêt automatique. Cette fonction peut être désactivée.

Possibilités de réglage: 1 à 60 min et off.

La Compensation d'erreur de la température du tube est une fonction de correction de la température qui compense l'erreur de mesure entre le tube et le réfrigérant.

Cette fonction peut être activée ou désactivée.



Réglages de la date, de l'heure et de la langue

Diverses possibilités de réglages spécifiques au pays se trouvent

dans l'onglet .

L'heure, la date et la langue peuvent être sélectionnées.

L'anglais est la langue réglée par défaut.

Réglage des unités

Les unités pour la pression et la température se trouvent dans

l'onglet .

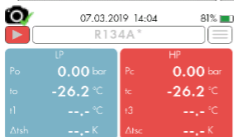
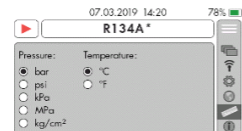

Fonction rapide de capture d'écran

Appuyez sur la touche  et maintenez-la enfoncée pendant 5 secondes pour créer une capture d'écran de n'importe quelle fenêtre.

Le fichier est enregistré sous forme de fichier BMP sur la carte SD.



Capture d'écran réussie



Échec de la capture d'écran



Les fichiers peuvent être utilisés comme indiqué au point Évaluation des données.



7 Maintenance

En cas d'utilisation intense, le by-pass digital requiert des opérations de maintenance. Celles-ci sont:



- Nettoyez l'écran et la surface du boîtier avec un chiffon et un produit de nettoyage.
- N'utilisez pas de nettoyeur ou de solvant agressif pour nettoyer l'appareil. Utilisez des nettoyeurs doux et des solutions au savon.
- Les raccords et flexibles de remplissage doivent être soumis à une inspection visuelle avant chaque utilisation pour détecter la présence de dommages mécaniques et remplacés s'ils sont endommagés.
- Les joints du by-pass digital sont soumis naturellement à l'usure mécanique et au vieillissement. L'étanchéité du by-pass digital doit par conséquent être vérifiée régulièrement par l'utilisateur.
- En cas de vannes non étanches, le piston doit être remplacé (M4-6-04-R/10).
- Pour remplacer le verre-regard sur le by-pass digital, utilisez l'outil spécial REFCO M4-6-11-T.



7.1 Mise à jour des réfrigérants

1	Connectez-vous à l'application  et rendez-vous dans la rubrique Mise à jour.
2	Les versions les plus récentes de réfrigérants se trouvent dans la rubrique Réfrigérants.
3	Sélectionnez les réfrigérants actuelles et envoyez-les à votre adresse mail.
4	Connectez le REFMATE à votre PC à l'aide du câble USB 

5	Une fois le REFMATE allumé, un nouveau lecteur s'affiche. 
6	Copiez ensuite le fichier reçu à votre adresse mail sur le lecteur qui s'affiche.
7	Éteignez le REFMATE  puis redémarrez-le  .
8	La liste des réfrigérants a été mise à jour.

7.2 Mise à jour du logiciel

1	Connectez-vous à l'application  et rendez-vous dans la rubrique Mise à jour.
2	La version la plus récente du logiciel se trouve dans la rubrique Firmware.
3	Sélectionnez le logiciel actuel et envoyez-le à votre adresse mail.
4	Connectez le REFMATE à votre PC à l'aide du câble USB 
5	Une fois le REFMATE allumé, un nouveau lecteur s'affiche. 
6	Copiez ensuite le fichier reçu à votre adresse mail sur le lecteur qui s'affiche.

7	<p>Éteignez le REFMATE  .</p> <p>Démarrez le REFMATE en appuyant sur la combinaison de touches suivante et en la maintenant enfoncée:</p> <p>Premier  et puis  pour une seconde simultanément jusqu'à ce que l'écran s'allume.</p>
8	<p>Le logiciel actuel est supprimé de la mémoire et le nouveau logiciel est installé. Durée: env. 1,5 min</p>

8 Résolution des problèmes

	Problème	Mesure
Mesurer	Aucune température ne s'affiche	La plage de mesure est dépassée. Modifiez la plage d'utilisation ou remplacez les capteur de température
	La pression ne s'affiche pas correctement et ne peut plus être mise à 0 à l'atmosphère	Exécutez un calibrage des capteurs de pression.
	La durée de vie des piles ne suffit pas pour le test	Alimentez l'appareil via USB au Power Bank ou à un bloc d'alimentation doté d'une prise USB.
Enregistrement de données	échec de l'enregistrement s'affiche	Aucune mémoire de données n'est insérée. La micro carte SD doit être insérée avant la mise en marche. La mémoire de données sur la micro carte SD est pleine.
	Les données ne s'ouvrent pas correctement en Excel	Changez en paramètres système de l'ordinateur le séparateur des listes au symbole point-virgule ';':

	La carte SD n'est pas lue	<p>Insérez une carte SD industrielle de meilleure qualité. Le soutien sera donné aux:</p> <ul style="list-style-type: none"> • SDSC bis 2GB • SDHC 2GB-32GB • SDXC 32GB-2TB
Capture d'écran	Le symbole d'échec de la capture d'écran s'affiche	<p>Aucune mémoire de données n'est insérée</p> <p>La micro carte SD doit être insérée avant la mise en marche.</p> <p>La mémoire de données sur la micro carte SD est pleine.</p>
Connexion	Aucune connexion bluetooth possible à la pince de température sans fil	<p>Activez le bluetooth de la pince de température, activez le bluetooth du REFIMATE.</p> <p>Testez les conditions de champ libre sans la présence d'obstacles radio, sources de perturbations</p> <p>Réglez la pince de température sur T1 et T2</p>
Mécanique	Le crochet se détache	Refixer le crochet
	Les boutons se détache	Remplacez les boutons, regardez les pièces de rechange
	Les tuyeaux flexible ne peuvent plus fixes	Si les filets sont cassés, remplacez les bordure pièces, regardez les pièces de rechange
Autre	Programme bloqué	Sortez les piles, remettez-les en place et redémarrez le REFIMATE.
	La mise en marche dure longtemps	Supprimez le firmware et les nouveaux réfrigérants sur la carte SD

9 Garantie

Votre nouveau REFMATE a été développé dans le respect des dernières avancées ergonomiques et techniques en matière de physiologie du travail. Il est conforme à l'état actuel de la technique. L'entreprise REFCO Manufacturing Ltd est certifiée selon DIN EN ISO 9001:2008. Des contrôles de qualité réguliers et un traitement minutieux garantissent de solides capacités de fonctionnement et rendent possible la garantie REFCO suivant les conditions de vente et de livraison applicables au jour de la livraison. Sont cependant exclus les dommages dus à l'usure ou à une négligence manifeste.

10 Retour et mise au rebut

Le by-pass digital REFMATE a été développé pour une utilisation à long terme. Lors de l'approvisionnement en matériaux et de la production, des économies d'énergie et le respect de l'environnement ont été pris en compte. REFCO Manufacturing Ltd se considère «à vie» responsable de ses produits. C'est pourquoi, REFCO Manufacturing s'est fait certifiée suivant la norme DIN EN ISO 14001:2004. À la mise hors service de l'appareil, l'utilisateur doit respecter les consignes d'élimination en vigueur dans son pays. Le boîtier est en ABS et TPE, les métaux sous pression sont l'aluminium et le laiton. La mallette en plastique est en PE.



11 Pièces de rechange et accessoires

Pièces de rechange	Désignation	Réf.
Boutons de remplacements (4 voies)	M4-7-SET- B+N+R+Y	4687094
Boutons de remplacements (2 voies)	M2-7-SET-B+R	4687079
Vanne complète	M2-10-95-R/2	4687104
Piston de vanne	M4-6-04-R/10	4662624
Voyant avec 2 joints	M4-6-11	4491018
Outil de montage du voyant	M4-6-11-T	4493169
Bordure pièce en Y	A-31452-Y/3	4687951
Vanne complète, 4 pièces	M2-10-95-R/4	4687105
Piston complet, 4 pièces	M4-6-04-R/4	4687093

Accessoires		
Sonde de température	TEMP-SENSOR	4681394
Pince de température	TEMP-CLAMP	4681466
Pince de température sans fil	WIRELESS-TEMP- CLAMP	4687785
Mallette en plastique	REFMATE-CASE	4688082

1	INTRODUZIONE	75
2	INFORMAZIONI GENERALI	75
3	SPECIFICHE TECNICHE	78
4	DESCRIZIONE DEL PRODOTTO E DEI COMPONENTI.....	79
4.1	DESCRIZIONE DEI COMPONENTI.....	79
4.2	TASTI E NAVIGAZIONE	81
5	TRASPORTO, CONFEZIONE E STOCCAGGIO ..	82
5.1	TRASPORTO.....	82
5.2	CONFEZIONE.....	82
5.3	STOCCAGGIO	82
6	MESSA IN SERVIZIO E FUNZIONALITÀ	83
6.1	MESSA IN SERVIZIO	83
6.1.1	<i>Display analogico</i>	<i>85</i>
6.1.2	<i>Registrazione di dati</i>	<i>86</i>
6.1.3	<i>Menu</i>	<i>88</i>
7	MANUTENZIONE.....	92
7.1	AGGIORNAMENTO DEI REFRIGERANTI.....	92
7.2	AGGIORNAMENTO DELLA FIRMWARE	93
8	RISOLUZIONE DEI PROBLEMI.....	94
9	GARANZIA	96
10	RESO E SMALTIMENTO	96
11	PARTI DI RICAMBIO E ACCESSORI	97

1 Introduzione



Congratulazioni per aver acquistato questo dispositivo.

Il manuale attuale è disponibile su www.refco.ch

2 Informazioni generali

Prima di iniziare il lavoro con il gruppo manometrico, leggere attentamente le istruzioni per l'uso. Dà indicazioni importanti per il funzionamento, la manutenzione e lo smaltimento corretto del gruppo manometrico.

Conformità

	<p>Il presente dispositivo soddisfa i criteri di conformità alle normative europee di pertinenza. La dichiarazione di conformità è consultabile al recapito indicato o sul sito Internet di REFCO.</p>
	<p>Il presente dispositivo soddisfa i requisiti di cui alla parte 15 delle normative FCC. Il funzionamento presuppone le condizioni seguenti:</p> <ol style="list-style-type: none"> (1) Il presente dispositivo non deve creare interferenze e (2) Il presente dispositivo deve poter tollerare interferenze, comprese quelle che possono determinare errori di funzionamento. <p>ID FCC: XYPYNINAB1</p>
	<p>Il presente dispositivo è conforme agli standard RSS esenti da licenza di Industry Canada.</p> <p>Il funzionamento presuppone le condizioni seguenti:</p> <ol style="list-style-type: none"> (1) Il presente dispositivo non deve creare interferenze e (2) Il presente dispositivo deve poter tollerare interferenze, comprese quelle che possono determinare errori di funzionamento. <p>ID IC: 8595A-NINAB1</p>

	<p>RCM: Regulatory Compliance Mark</p> <p>Il presente dispositivo è conforme ai requisiti delle normative RCM.</p>
<p>RoHS</p>	<p>RoHS: Restriction of Hazardous Substances</p> <p>Il presente dispositivo soddisfa le disposizioni della direttiva RoHS dell'UE.</p> <p>RoHS 2011/65/EU contiene 2015/863/EU</p> <p>Il dispositivo non contiene sostanze proibite al di sopra del valore limite.</p>
<p>REACH</p>	<p>Sulla base dell'articolo 33 del regolamento REACH 1907/2006 si dichiara che il presente dispositivo e la confezione sono conformi all'articolo 57 del regolamento REACH 1907/2006.</p> <p>Il presente dispositivo e la confezione non contengono sostanze estremamente preoccupanti (SVHC) specificate nell'attuale elenco delle sostanze candidate (articolo 59), in concentrazione superiore allo 0,1%.</p>

Indicazioni importanti di sicurezza

Leggere attentamente e osservare tutte le indicazioni di sicurezza:

Spiegazione dei simboli:

Avvertenza!



... indica una situazione potenzialmente pericolosa che se non eritate, può provocare gravi lesioni personali.

Pericolo!



... contrassegna il pericolo derivante da una corrente elettrica. L'inosservanza delle indicazioni di sicurezza comporta il pericolo di lesioni personali gravi o fatali.

Indicazioni di sicurezza:



Il gruppo manometrico non deve essere impiegato per scopi diversi dall'ambito della climatizzazione e della refrigerazione.



Il gruppo manometrico non deve essere impiegato per pressioni superiori a 60 bar / 870 psi / 6000 kPa / 6 MPa.



Il gruppo manometrico non deve in nessun caso essere impiegato come valvola di riduzione della pressione, specie in caso di utilizzo di azoto N₂.



Il gruppo manometrico non deve essere impiegato con il refrigerante ammoniaca (NH₃ / R717) e non in zone EX.



Il gruppo manometrico non deve essere esposto alla pioggia né essere utilizzato in ambiente umido o bagnato.



Quando si lavora con il gruppo manometrico, indossare sempre occhiali di protezione e guanti.



I prodotti REFCO sono stati sviluppati e fabbricati appositamente per essere utilizzati da tecnici della refrigerazione qualificati. Per la presenza delle alte pressioni e dei gas chimici e fisici utilizzati nei sistemi di refrigerazione, REFCO declina ogni responsabilità civile e penale in caso di incidenti, lesioni personali e morte.



REFCO indica espressamente che i prodotti devono essere utilizzati esclusivamente da professionisti qualificati.

Uso conforme

Il gruppo manometrico è stato sviluppato per misurare e impostare i rapporti di pressione e temperatura in impianti di refrigerazione mobili e fissi come le pompe di calore. L'uso di questo prodotto REFCO è consentito solo a tecnici della refrigerazione qualificati.

3 Specifiche tecniche

Proprietà	Valore	
Intervallo di pressione	da -0.95 a 60 bar	
Sovrapressione max.	80 bar	
Precisione di misura della pressione	±0,5% (classe 0,5)	
Unità di misura della pressione	bar / psi / kPa / MPa / kg/cm ²	
Risoluzione di misura della pressione	0,01 bar / 0,5 psi / 1 kPa / 0,001 MPa / 0,01 kg /cm2	
Sensori temperatura esterni	Intervallo di temperatura	da -40 °C a +125 °C / da -40 °F a +257 °F
	Connettore	Tipo K
	Precisione di misura della temperatura	+/- 1 K
	Risoluzione	0,1°C / 0,1°F
Termometro a pinza	Intervallo di temperatura	da -40 °C a +125 °C / da -40 °F a +257 °F
	Connettore	Tipo K
	Precisione di misura della temperatura	+/- 1 K
	Risoluzione	0,1°C / 0,1°F
	Diametro del tubo TC	Da 6 mm a 38 mm Da ¼" a 1 ½"
	Diametro del tubo WTC	Da 6 mm a 42 mm Da ¼" a 1 ⅝"
Temperatura ambiente	da -20 °C a +50 °C / da -4 °F a +122 °F	
Alimentazione elettrica	4 x 1,5 V AA/Mignon/LR6 o USB	
Temperatura di stoccaggio	da -20 °C a +60 °C / da -4 °F a 140 °F	

4 Descrizione del prodotto e dei componenti

La dotazione comprende i componenti seguenti:

Compresi nella configurazione standard	Altri accessori
Gruppo manometrico digitale 2 sensori di temperatura di tipo K con cavo lungo 1,5 m 5 tubi flessibili di riempimento 4 batterie AA Scheda Micro SD 8GB (inserita nel dispositivo) Valigetta di plastica Istruzione per l'uso Protocollo di calibrazione Cavo USB 1,8 m	2 termometri a pinza di tipo K con cavo lungo 1,5 m 2 termometri a pinza di tipo K wireless

4.1 Descrizione dei componenti

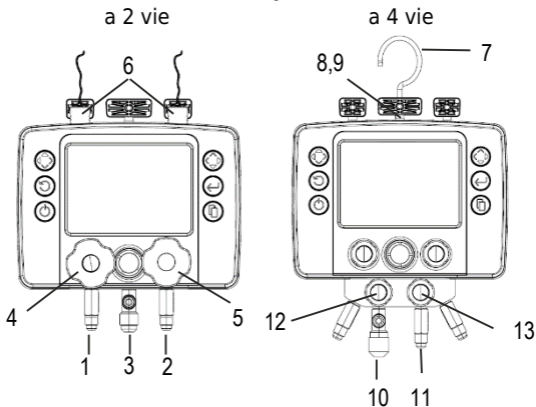

1.	Connettore bassa pressione 1/4" SAE	Per l'attacco di un tubo flessibile
2.	Connettore alta pressione 1/4" SAE	Per l'attacco di un tubo flessibile
3.	Connettore refrigerante / vuoto 1/4" SAE	Per l'attacco di un tubo flessibile
4.	Valvola bassa pressione (blu)	Girare verso sinistra per aprire o ruotare in senso orario per chiudere
5.	Valvola alta pressione (rossa)	Girare verso sinistra per aprire o ruotare in senso orario per chiudere
6.	Presa di tipo K	Presa per il sensore di temperatura o il termometro a pinza
7.	Gancio	Per appendere il dispositivo
8.	Presa Micro USB	Presa per cavo Micro USB per il collegamento a un computer
9.	Presa scheda SD	Presa per la scheda SD
10.	Connettore vuoto 3/8" SAE	Per l'attacco di un tubo flessibile
11.	Connettore refrigerante 1/4" SAE	Per l'attacco di un tubo flessibile
12.	Valvola per vuoto (gialla)	Girare verso sinistra per aprire o ruotare in senso orario per chiudere
13.	Valvola per refrigerante (nera)	Girare verso sinistra per aprire o ruotare in senso orario per chiudere

4.2 Tasti e navigazione



Verso SINISTRA o in
ALTO



Verso DESTRA o
in BASSO



Tasto INDIETRO



INSERIMENTO /
SELEZIONE



(ON/OFF)



Tasto CAMBIO

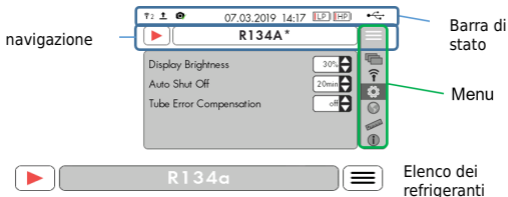

Premere per aprire l'elenco

Premere per andare a destra

R134a Menu

Premere per aprire il menu

Premere per andare a destra

R134a Menu registrazione

Premere per aprire il menu registrazione.

Avvertenze importanti	
La data di decorrenza della garanzia viene definita dopo 5 minuti di utilizzo.	Dalla data della messa in servizio si accorda una sola estensione di garanzia. Tale data viene stabilita la prima volta che si mette in funzione il dispositivo per più di 5 minuti. Questa circostanza può verificarsi anche nel corso di presentazioni nel punto vendita e non può più essere corretta successivamente!
Rimuovere le batterie AA dal REFIMATE dopo l'utilizzo	La fuoriuscita di sostanze chimiche dalle batterie distrugge il REFIMATE. Se non si utilizza il dispositivo per un tempo prolungato, è necessario togliere le batterie AA dal REFIMATE. Non si applica la garanzia su danni dovuti alla fuoriuscita di sostanze chimiche. 
Lasciare la scheda SD nel REFIMATE	Si consiglia di lasciare la scheda SD nel REFIMATE per evitare di perderla!

5 Trasporto, confezione e stoccaggio

5.1 Trasporto

Il gruppo manometrico digitale viene consegnato in una valigetta di plastica per proteggere i diversi componenti. La valigetta di plastica protegge dalle vibrazioni durante il trasporto e il maneggiamento. Utilizzare sempre la valigetta di plastica per proteggere il gruppo manometrico e i relativi accessori e durante il trasporto fissarla sulla superficie di carico. Le condizioni di stoccaggio devono essere rispettate anche durante il trasporto.

5.2 Confezione

La valigetta di plastica è realizzata in polietilene e protegge il gruppo manometrico dai danni dovuti a cadute accidentali. Permette inoltre di trasportare anche gli accessori, vale a dire i sensori di temperatura in dotazione nonché gli accessori opzionali, cioè il termometro a pinza, il termometro a pinza wireless e un sensore di vuoto.

5.3 Stoccaggio

Rispettare le temperature di stoccaggio e tenere chiusa la confezione.

6 Messa in servizio e funzionalità

6.1 Messa in servizio

Operazioni preliminari alla messa in servizio

Inserire 4 batterie nel vano batterie sul retro del dispositivo. Prestare attenzione alla corretta polarità delle batterie. Se non si utilizza il REFMATE per diverso tempo, rimuovere le batterie dal vano batterie.

Togliere la pellicola dello schermo



Avviare il dispositivo

Premere 

Dopo qualche secondo il dispositivo è pronto.

- Controllare lo stato della batteria

Nota: nei primi 5 minuti non è possibile modificare data e ora.



Azzeramento dei sensori di pressione

Tenere premuto il tasto 

- L'indicatore della pressione mostra 0.

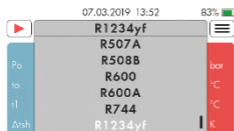

Selezione del refrigerante

Premendo  si accede alla libreria dei refrigeranti.

Scegliere il refrigerante desiderato

premendo  o . Per confermare la selezione, premere

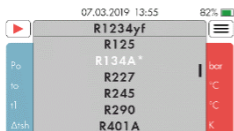

Refrigeranti preferiti

Tenendo premuto  per almeno 3 secondi è possibile selezionare i preferiti.

*I preferiti sono contrassegnati dall'asterisco * e vengono presentati in cima all'elenco.*

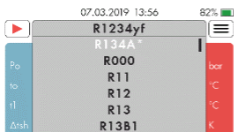

6.1.1 Display analogico

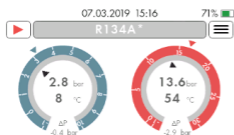
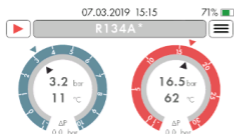
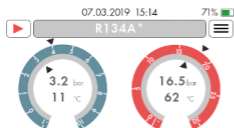
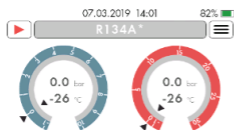

Supris-Caldamento e Sotto-Raffreddamento

Premendo 

è possibile spostarsi tra il display digitale e quello analogico.

Rattappante

Sull'anello esterno del display analogico si mantiene la pressione massima raggiunta.

--.	Senza misura
OOR	Out of range
OCP	Over critical point
no cal.	Calibratura manca

Impostazione della pressione di riferimento

Per impostare una pressione di

riferimento, tenere premuto  per 3 secondi.

Il display mostra inoltre la differenza di pressione.

Per eliminare la pressione di

riferimento, tenere premuto  per 3 secondi.



Le due funzioni indicate sopra sono alla vostra disposizione solo sul display analogico.

6.1.2 Registrazione di dati 

07.03.2019 14:02 81% 

R134A* 



Set	Sample Rate	Duration
	1 Sample/min	4 h
	6 Sample/min	8 h
	30 Sample/min	12 h
	60 Sample/min	24 h
	120 Sample/min	48 h

 

07.03.2019 14:03 81% 

R134A* 



Set	Sample Rate	Duration
	1 Sample/min	8 h
	6 Sample/min	12 h
	30 Sample/min	24 h
	60 Sample/min	48 h
	120 Sample/min	168 h

 

07.03.2019 14:03 81% 

R134A* 

Set	Sample Rate	Duration
	1 Sample/min	8 h
	6 Sample/min	12 h
	30 Sample/min	24 h
	60 Sample/min	48 h
	120 Sample/min	168 h

 

07.03.2019 14:04 81% 



R134A* 

LP		HP	
Po	0,00 bar	Pc	0,00 bar
to	-26,2 °C	tc	-26,2 °C
tl	--,-- °C	ts	--,-- °C
Atsh	--,-- K	Atsc	--,-- K

07.03.2019 14:04 81% 

R134A* 

Set	Sample Rate	Duration
	1 Sample/min	8 h
	6 Sample/min	12 h
	30 Sample/min	24 h
	60 Sample/min	48 h
	120 Sample/min	168 h

 REF_M_20190307_140344.csv 

Registrazione di dati

Accertarsi che la scheda SD si trovi nell'apposito slot.

Sul navigatore andare su 

con  e  ..

Selezionare la velocità di



scansione con  :

Valori compresi tra 1 e 120 S/min
(S/min = punti di misura / minuto)

Selezionare la durata della misu-

razione con  ,  ,  :

Valori compresi tra 15min e 168h

Avviare la registrazione  ,
 ,  :

Il nome del file viene creato e visualizzato automaticamente.

Durante la registrazione, le funzioni di selezione del refrigerante e di impostazione sono bloccate.

Per terminare anticipatamente la registrazione, andare su 

e premere 

0102

Valutazione dati

Opzione 1

Collegare il dispositivo a un computer mediante un cavo USB.

Accendere il REFMATE.

Il dispositivo viene visualizzato sul computer come unità di archiviazione USB.

I dati sono disponibili come file Excel in formato csv.

Opzione 2

Trasferimento dei dati all'APP

Aprire l'App e selezionare "Transfer Logged data"

(Trasferisci dati registrati)  .
Selezionare il file desiderato.

Attendere la visualizzazione dell'avanzamento temporale.

6.1.3

Menu 

Campo Calibrazione con pressione di referenza

Sulla navigazione selezionare



La scheda  permette di eseguire la calibrazione sul campo dei sensori di pressione.

Per avviare la calibrazione, digitare il PIN.

Il PIN è: 0-0-0-9

In questo momento il dispositivo non deve essere sotto pressione!

Premere 

Collegare il dispositivo a un sistema che abbia una pressione definita.

Intervallo di pressione: 10-60bar, 150-850 psi

Maggiore è la pressione di calibrazione, più precisa risulterà la calibrazione!

Aspettate che la pressione di calibrazione conforme alla pressione di riferimento. Premendo  si calibra il singolo sensore di pressione.

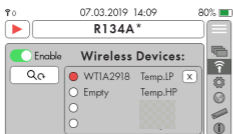
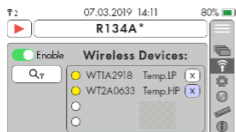
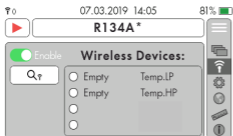

Connessioni

La scheda  elenca le connessioni wireless disponibili.

Impostando "ON" (Enable) si attiva la connessione.

 cerca le connessioni e si collega automaticamente. Attenzione: il nome del WTC deve essere: T1 per LP e T2 per HO.

I dispositivi già connessi una volta memorizzano le impostazioni e si ricollegano automaticamente all'attivazione della funzione wireless.

Il numero di dispositivi collegato è indicato sul display in alto a sinistra. Compare inoltre un indicatore supplementare della batteria, se si rende necessario sostituire la batteria del termometro a pinza wireless.

Significato dei colori visualizzati:

Verde: dispositivo collegato

Giallo: termometro a pinza collegato e sensore di temperatura inserito.

Il sensore inserito ha la priorità e viene visualizzato.

Rosso: il dispositivo memorizzato non è collegato.

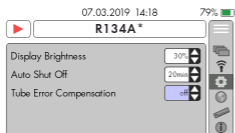
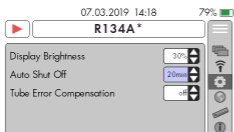



Impostazioni generali

La scheda  permette di impostare vari parametri.

È possibile regolare individualmente la luminosità del display.

Funzione rapida:

Tenere premuto il tasto  mentre si tocca ripetutamente  o . La luminosità cambia a incrementi del 5%.

Alla voce "Spegnimento automatico" si imposta il tempo dopo il quale avviene lo spegnimento automatico. Questa funzione può essere disattivata.

Valori impostabili: da 1 a 60 min e off.

La compensazione dell'errore di misura sul tubo è una funzione di correzione della temperatura che compensa l'errore di misurazione tra tubo e refrigerante.

Questa funzione può essere attivata (ON) e disattivata (OFF).



Impostazione dell'orario e della lingua

La scheda  permette di impostare vari parametri specifici del paese.

È possibile scegliere l'orario, la data e la lingua.

La lingua predefinita è l'inglese.

Impostazione delle unità di misura

La scheda  contiene le unità di misura di pressione e temperatura.

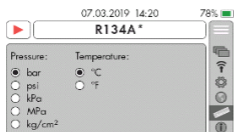

Funzione rapida (Printscreen)

Tenendo premuto  per almeno 5 secondi è possibile produrre un printscreen di qualunque schermata.

Il file viene salvato in formato BMP sulla scheda SD.

 Printscreen eseguito correttamente

 Printscreen non riuscito

I file possono essere valutati come descritto nel paragrafo valutazione dei dati.

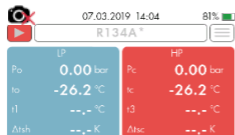





7 Manutenzione

Se si fa un uso intensivo del gruppo manometrico digitale, occorre effettuare gli interventi di manutenzione seguenti:



- Pulire lo schermo e la superficie dell'involucro con un panno e del detergente.
- Per la pulizia del dispositivo non utilizzare detergenti aggressivi o solventi. Possono essere utilizzati detergenti per la casa delicati e acqua saponata.
- Prima di ogni utilizzo, sottoporre i connettori e i tubi di riempimento a un esame visivo per rilevare eventuali danneggiamenti, nel qual caso sostituirli.
- Le guarnizioni di un gruppo manometrico sono naturalmente soggette a un'usura determinata da fattori meccanici e di età. L'utente dovrà dunque verificare regolarmente la tenuta ermetica del gruppo manometrico.
- Se le valvole non sono ermetiche, sostituire il pistone (M4-6-04-R/10).
- Per sostituire lo spioncino del gruppo manometrico, utilizzare l'utensile speciale REFCO M4-6-11-T.



7.1 Aggiornamento dei refrigeranti

1	Eseguire l'accesso sull'APP  e andare alla sezione aggiornamento
2	Alla voce refrigeranti si troveranno le versioni più aggiornate
3	Selezionare l'elenco attuale e mandarselo via e-mail.
4	Collegare il REFMATE al computer mediante un cavo USB 

5	Quando si accende il REFMATE, compare il simbolo di una nuova unità di archiviazione. 
6	Copiare il file arrivato con l'e-mail sull'unità visualizzata.
7	Spegnere il REFMATE  e riaccenderlo  .
8	L'elenco dei refrigeranti è stato aggiornato.

7.2 Aggiornamento della firmware

1	Eseguire l'accesso sull'APP  e andare alla sezione aggiornamento
2	Alla voce Firmware si troverà la versione più aggiornata.
3	Selezionare la firmware attuale e mandarsela via e-mail.
4	Collegare il REFMATE al computer mediante un cavo USB 
5	Quando si accende il REFMATE, compare il simbolo di una nuova unità di archiviazione. 
6	Copiare il file arrivato via e-mail sull'unità visualizzata.

<p>7</p>	<p>Spegnere il REFMATE .</p> <p>Avviare il REFMATE tenendo premuta la combinazione di tasti:</p> <p>Per primo  e poi  contemporaneamente un secondo finché non si accende il display.</p>
<p>8</p>	<p>La firmware attuale viene cancellata dalla memoria e viene installata la nuova versione.</p> <p>Durata dell'operazione: 1,5 minuti circa</p>

8 Risoluzione dei problemi

	Problema	Misura da adottare
Misurazione	Non compare nessuna temperatura	<p>È stato superato l'intervallo di misurazione</p> <p>Modificare l'intervallo di utilizzo o sostituire i sensori di temperatura</p>
	La pressione visualizzata è sbagliata e non può più essere azzerata al valore dell'atmosfera	Effettuare la calibrazione dei sensori di pressione.
	Il tempo di carica della batteria non è sufficiente per il test	Alimentare il dispositivo tramite powerbank USB o con un alimentatore tramite il connettore USB.
Registraz	Non compare nessuna registrazione	<p>Non c'è un supporto dati inserito.</p> <p>La scheda SD deve essere inserita prima di accendere.</p> <p>La scheda dati Micro SD è piena.</p>

	Impossibile leggere la scheda SD	Utilizzare una scheda SD industriale di qualità migliore. Il supporto sarà dato a: <ul style="list-style-type: none"> • SDSC bis 2GB • SDHC 2GB-32GB • SDXC 32GB-2TB
Printscreen	Compare l'icona Printscreen non riuscito	Non c'è un supporto dati inserito. La scheda SD deve essere inserita prima di accendere. La scheda dati Micro SD è piena.
Connessione	Impossibile stabilizzare una connessione Bluetooth al termometro a pinza wireless	Attivare il Bluetooth sul termometro a pinza e attivare il Bluetooth sul REFMATE. Effettuare la verifica in condizioni di campo libero, senza che vi siano ostacoli alla radiotrasmissione. Impostare il termometro a pinza su T1 e T2
Meccanica	Il gancio si è staccate	Reinserire il gancio
Altro	Il programma si blocca	Estrarre la batteria, reinserirla e riavviare il REFMATE.
	Il tempo di accensione è molto lungo	Rimuovere tutti i dati inutili sulla scheda SD (firmware e refriseranti)

9 Garanzia

Il vostro nuovo REFMATE è stato sviluppato secondo le ultime conoscenze in materia di fisiologia del lavoro ed ergonomia e corrisponde all'attuale stato della tecnica. L'azienda REFCO Manufacturing Ltd è stata certificata secondo la norma DIN EN ISO 9001:2008. I regolari controlli di qualità e la lavorazione accurata garantiscono il funzionamento stabile e permettono di rilasciare la garanzia REFCO ai sensi delle condizioni generali di vendita e fornitura in vigore il giorno della consegna. Dalla garanzia sono esclusi i danni provocati da evidenti inaccuratezze nell'uso e dall'usura.

10 Reso e smaltimento

Il gruppo manometrico REFMATE è stato sviluppato per un uso prolungato. Nella scelta dei materiali e nella produzione sono stati tenuti in considerazione il risparmio energetico e la sostenibilità ambientale. REFCO Manufacturing Ltd si considera responsabile "a vita" dei propri prodotti. Per questo motivo REFCO Manufacturing si è fatta certificare secondo la norma DIN EN ISO 14001:2004. Al momento della messa fuori uso del dispositivo, l'utilizzatore dovrà attenersi alle normative sullo smaltimento locale vigente. L'involucro è in ABS e TPE, i metalli sottoposti a pressione sono l'alluminio e l'ottone. La valigetta di plastica è in PE.



11 Parti di ricambio e accessori

Parti di ricambio	Denominazione	Codice art.
Manopole di ricambio (4 vie)	M4-7-SET-B+N+R+Y	4687094
Manopole di ricambio (2 vie)	M2-7-SET-B+R	4687079
Rubinetto completo	M2-10-95-R/2	4687104
Pistoni della valvola	M4-6-04-R/10	4662624
Indicatore con 2 guarnizioni	M4-6-11	4491018
Chiave per indicatore	M4-6-11-T	4493169
Pezzo a Y svasato	A-31452-Y/3	4687951
Rubinetto completo, 4 pezzi	M2-10-95-R/4	4687105
Pistone completo, 4 pezzi	M4-6-04-R/4	4687093

Accessori		
Sensore temperatura	TEMP-SENSOR	4681394
Termometro a pinza	TEMP-CLAMP	4681466
Termometro a pinza wireless	WIRELESS-TEMP-CLAMP	4687785
Valigetta in plastica	REFMATE-CASE	4688082

1	INTRODUCCIÓN	99
2	INFORMACIÓN GENERAL	99
3	DATOS TÉCNICOS	102
4	CONTENIDO Y DESCRIPCIÓN DEL PRODUCTO 103	
4.1	DESCRIPCIÓN DEL PRODUCTO	103
4.2	PERILLAS Y NAVEGACIÓN.....	105
5	TRANSPORTE, EMBALAJE Y ALMACENAMIENTO 106	
5.1	TRANSPORTE	106
5.2	EMBALAJE	106
5.3	ALMACENAMIENTO.....	106
6	PUESTA EN FUNCIONAMIENTO Y USO	107
6.1	PUESTA EN FUNCIONAMIENTO	107
6.1.1	<i>Pantalla analógica</i>	109
6.1.2	<i>Registro de datos</i>	110
6.1.3	<i>Menú</i>	112
7	MANTENIMIENTO	116
7.1	ACTUALIZAR REFRIGERANTES	116
7.2	ACTUALIZAR FIRMWARE	117
8	RESOLUCIÓN DE PROBLEMAS	118
9	GARANTÍA	120
10	INFORMACIÓN MEDIOAMBIENTAL	120
11	RECAMBIOS Y ACCESORIOS	121

1 Introducción



¡Muchas gracias por comprar este producto!

El manual actual está disponible en www.refco.ch

2 Información general

Antes de utilizar este analizador digital, lea atentamente este manual de instrucciones de uso, ya que contiene información importante sobre cómo utilizar, mantener y desechar correctamente este analizador digital.

Conformidad

	<p>Este aparato cumple con la normativa europea aplicable. La declaración de conformidad puede consultarse en la dirección de contacto o en la página web de REFCO.</p>
	<p>Este aparato cumple con los requisitos del apartado 15 de las normas FCC y su uso está sujeto a las dos condiciones siguientes:</p> <ol style="list-style-type: none"> (1) este aparato no puede causar interferencias perjudiciales y (2) este aparato tiene que poder tolerar cualquier interferencia, incluidas aquellas que pudieran causar fallos de funcionamiento no deseados. <p>N.º FCC: XPYNINAB1</p>
	<p>Este aparato cumple con los estándares RSS exentos de licencia de Industry Canada.</p> <p>El uso de este aparato está sujeto a las dos condiciones siguientes:</p> <ol style="list-style-type: none"> (1) este aparato no puede causar interferencias y (2) este aparato tiene que poder soportar cualquier interferencia, incluidas aquellas que pudieran causar fallos de funcionamiento no deseados. <p>N.º IC: 8595A-NINAB1</p>

	<p>Marcado RCM: Regulatory Compliance Mark</p> <p>Este aparato cumple con los requisitos establecidos por las normas RCM.</p>
<p>RoHS</p>	<p>RoHS: Restriction of Hazardous Substances</p> <p>Este aparato cumple con las disposiciones de la directiva europea RoHS.</p> <p>RoHS 2011/65/EU contiene 2015/863/EU</p> <p>El aparato no contiene ninguna sustancia prohibida por encima de los límites establecidos.</p>
<p>REACH</p>	<p>De acuerdo al art. 33 del reglamento REACH 1907/2006, se declara que este aparato y su embalaje son conformes con el art. 57 del reglamento REACH 1907/2006.</p> <p>Este aparato y su embalaje no contienen ninguna sustancia SVHC incluida en la lista actual (art. 59) en una concentración superior al 0,1%.</p>

Advertencias de seguridad importantes

Lea atentamente y tenga en cuenta todas las advertencias de seguridad:

Descripción del símbolo:

¡Advertencia!



... advierte de una situación potencialmente peligrosa que, si no se evita, podría causar lesiones graves.

¡Peligro!



... advierte de un peligro provocado por la corriente eléctrica. El incumplimiento de las advertencias de seguridad podría provocar lesiones graves o mortales.

Advertencias de seguridad:



Este aparato no puede ser utilizado para fines distintos a los propios del ámbito de la refrigeración y el aire acondicionado.



Este aparato no puede ser utilizado por encima de valores de presión superiores a 60 bar / 870 psi / 6000 kPa / 6 MPa.



Este aparato no puede ser utilizado en ningún caso como válvula reductora de presión, especialmente en combinación con nitrógeno N₂.



Este aparato no puede ser utilizado con el refrigerante amoníaco (NH₃ / R717) y no en EX-zonas.



Este aparato no puede exponerse a la lluvia ni ser utilizado en entornos húmedos o mojados.



Durante el uso del aparato es obligatorio llevar gafas protectoras y guantes.



Los productos REFCO han sido diseñados y fabricados para ser utilizados por expertos cualificados en sistemas de refrigeración y aire acondicionado. Debido a las altas presiones y a los gases químicos empleados en los sistemas de refrigeración, REFCO no se responsabiliza de los accidentes, daños o lesiones mortales que pudieran producirse por el uso de sus productos.



REFCO advierte expresamente de que sus productos solo pueden ser utilizados por expertos profesionales debidamente cualificados.



Especificaciones de uso

Este analizador digital está indicado para medir y ajustar los valores de presión y temperatura en sistemas móviles y fijos de refrigeración y aire acondicionado como bombas de calor. Este producto REFCO solo puede ser utilizado por técnicos expertos en sistemas de refrigeración y aire acondicionado.

3 Datos técnicos

Propiedad	Valor	
Rango de presión	entre -0.95 y 60 bar	
Sobrepresión máxima	80 bar	
Precisión de presión	±0,5% (clase 0,5)	
Unidades de presión	bar / psi / kPa / MPa / kg/cm ²	
Resolución de presión	0,01 bar / 0,5psi / 1kPa / 0,001MPa / 0,01 kg /cm ²	
Sensores de temperatura externos	Rango de temperatura	entre -40 °C y +125 °C / entre -40 °F y +257 °F
	Conexión	Tipo K
	Precisión de temperatura	+/- 1 K
	Resolución	0,1 °C / 0,1 °F
Termómetro de pinza	Rango de temperatura	entre -40 °C y +125 °C / entre -40 °F y +257 °F
	Conexión	Tipo K
	Precisión de temperatura	+/- 1 K
	Resolución	0,1 °C / 0,1 °F
	Diámetro del tubo TC	Entre 6 mm y 38 mm Entre ¼" y 1 ½"
	Diámetro del tubo WTC	Entre 6 mm y 42 mm Entre ¼" y 1 ⅝"
Temperatura ambiente	entre -20 °C y 50 °C / entre -4 °F y 122 °F	
Alimentación	4 pilas AA/mignon/LR6 de 1,5 V o batería externa USB	
Temperatura de almacenamiento	entre -20 °C y 60 °C / entre -4 °F y 140 °F	

4 Contenido y descripción del producto

Contenido del suministro:

Contenido de la versión estándar	Otros accesorios
Analizador digital digital 2 sensores de temperatura de tipo K con cable de 1,5 m 5 tubos flexibles de llenado 4 pilas AA Tarjeta microSD de 8 GB (insertada en el aparato) Maletín de plástico Manual de instrucciones Protocolo de calibración Cable USB 1.8 m	2 termómetros de pinza de tipo K con cable de 1,5 m 2 termómetros inalámbricos de pinza de tipo K

4.1 Descripción del producto

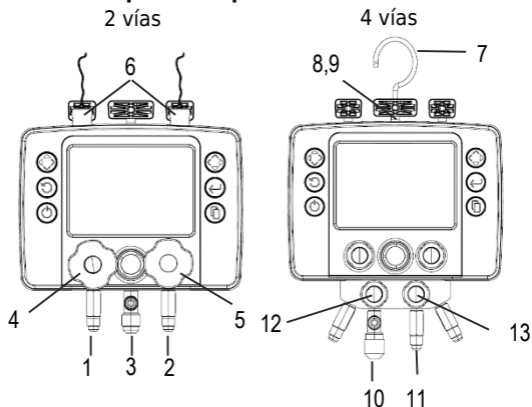

1.	Conexión de baja presión 1/4" SAE	Para conectar un tubo flexible
2.	Conexión de alta presión 1/4" SAE	Para conectar un tubo flexible
3.	Conexión para refrigerante/vacío 1/4" SAE	Para conectar un tubo flexible
4.	Válvula de baja presión (color azul)	Abrir girándola a la izquierda y cerrar girándola en el sentido de las agujas del reloj
5.	Válvula de alta presión (color rojo)	Abrir girándola a la izquierda y cerrar girándola en el sentido de las agujas del reloj
6.	Conexión de tipo K	Para el sensor de temperatura o el termómetro de pinza
7.	Gancho	Para colgar el aparato
8.	Conexión micro-USB	Para conectar el aparato a un ordenador a través de un cable micro-USB
9.	Ranura de tarjetas SD	Para insertar tarjetas SD
10.	Conexión de vacío 3/8" SAE	Para conectar un tubo flexible
11.	Conexión de refrigerante 1/4" SAE	Para conectar un tubo flexible
12.	Válvula de vacío (color amarillo)	Abrir girándola a la izquierda y cerrar girándola en el sentido de las agujas del reloj
13.	Válvula de refrigerante (color negro)	Abrir girándola a la izquierda y cerrar girándola en el sentido de las agujas del reloj

4.2 Perillas y Navegación



A la IZQUIERDA o hacia ARRIBA



A la DERECHA o hacia ABAJO



Volver ATRÁS



ENTRADA / SELECCIÓN



Botón de ENCENDIDO/APAGADO



Botón de CAMBIO de función

Navegación



Barra de estado

Menu



Lista de refrigerantes

Pulse  para acceder a la lista de refrigerantes

Pulse  ir a la derecha

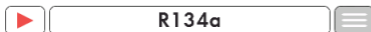

Menú

Pulse  para acceder a la lista de refrigerantes

Pulse  ir a la derecha

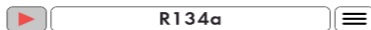

Menú de grabación

Pulse  para acceder a la lista de refrigerantes

Observaciones importantes	
El periodo de garantía se amplía tras los primeros 5 minutos de uso	El periodo de garantía se amplía a partir de la primera puesta en funcionamiento del equipo REFMATE. Para ello se considera la fecha en la que el producto se ha puesto por primera vez en funcionamiento durante más de 5 minutos. Si esto ocurre en el punto de venta con fines de demostración, la fecha no podrá corregirse con posterioridad.
Saque las pilas AA del equipo REFMATE cuando no lo vaya a seguir utilizando	Las fugas químicas de las pilas pueden dañar el equipo REFMATE. Por eso, saque siempre las pilas AA del REFMATE cuando no lo vaya a utilizar durante un largo periodo de tiempo. Los daños provocados por fugas de pilas no están cubiertos por la garantía. 
Deje la tarjeta SD insertada en el equipo REFMATE	Se recomienda dejar la tarjeta SD insertada en el equipo REFMATE para evitar que se pierda.

5 Transporte, embalaje y almacenamiento

5.1 Transporte

Este analizador digital digital se suministra en un maletín de plástico que protege el aparato y sus piezas de vibraciones durante su manejo y transporte. Utilice siempre el maletín de plástico para proteger el aparato y sus accesorios. Durante el transporte, asegure el maletín en la superficie de carga y mantenga las mismas condiciones que las indicadas para su almacenamiento.

5.2 Embalaje

El maletín de plástico, fabricado con material de polietileno, protege el aparato de los daños causados por golpes o caídas. En este maletín pueden guardarse accesorios como los sensores de temperatura incluidos u otros accesorios como termómetros de pinza, termómetros inalámbricos de pinza y sensores de vacío.

5.3 Almacenamiento

Mantener el aparato siempre dentro del embalaje cerrado dentro del rango de temperatura de almacenamiento indicada.

6 Puesta en funcionamiento y uso

6.1 Puesta en funcionamiento

Antes de poner en funcionamiento

Inserte 4 pilas en el compartimento de las pilas situado en la parte trasera del aparato teniendo en cuenta la polaridad indicada. Saque siempre las pilas del compartimento cuando no vaya a utilizar el aparato REFMATE durante un largo periodo de tiempo.

Retire el plástico protector de la pantalla.



Encender el aparato

Pulse 

A los pocos segundos, el aparato estará listo para ser usado.

- Controle el nivel de carga de las pilas.

Observación: Durante los primeros 5 minutos no pueden modificarse la fecha ni la hora.



Puesta a cero de los sensores de presión

Mantenga pulsado 

- La indicación de presión muestra cero.

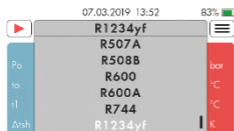

Seleccionar refrigerante

Pulse  para acceder a la lista de refrigerantes.

Seleccione el refrigerante deseado

pulsando  o . Para

confirmar la selección, pulse .

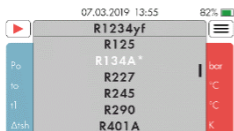

Refrigerantes favoritos

Manteniendo pulsado  durante mín. 3 segundos puede seleccionar sus refrigerantes favoritos.

Los refrigerantes favoritos se marcan con un asterisco () y se muestran en la parte superior de la lista.*

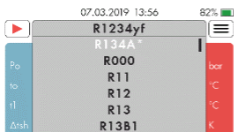

6.1.1 Pantalla analógica

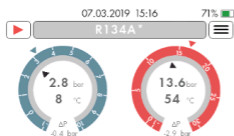
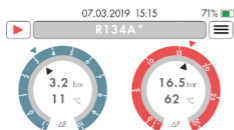
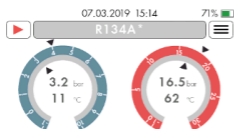
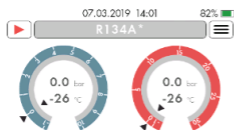

Sobre-Calentamiento y Sub-Enfriamiento



Pulse

para cambiar entre la pantalla digital y analógica.

Puntero de arrastre

La presión más alta alcanzada se mantiene en el círculo externo de la pantalla analógica.

--	Ninguna medición
OOR	Out of range
OCP	Over critical point
no cal.	Calibración falta

Establecer presión de referencia

Para establecer una presión de referencia, mantenga pulsado durante 3 segundos.



La pantalla muestra también la diferencia de presión.

Para eliminar la presión de



referencia, mantenga pulsado durante 3 segundos.





Estas dos últimas funciones solo están disponibles en la pantalla analógica.

6.1.2 Registro de datos 



07.03.2019 14:02 81% 

 R134A* 



Set	Sample Rate	Duration
	1 Sample/min	4 h
	6 Sample/min	8 h
	30 Sample/min	12 h
	60 Sample/min	24 h
	120 Sample/min	48 h

 



07.03.2019 14:03 81% 

 R134A* 



Set	Sample Rate	Duration
	1 Sample/min	8 h
	6 Sample/min	12 h
	30 Sample/min	24 h
	60 Sample/min	48 h
	120 Sample/min	168 h



07.03.2019 14:03 81% 

 R134A* 

Set	Sample Rate	Duration
	1 Sample/min	8 h
	6 Sample/min	12 h
	30 Sample/min	24 h
	60 Sample/min	48 h
	120 Sample/min	168 h



 

07.03.2019 14:04 81% 



 R134A* 

LP		HP	
Po	0,00 bar	Pc	0,00 bar
to	-26,2 °C	tc	-26,2 °C
tl	--,- °C	td	--,- °C
Atsh	--,- K	Atsc	--,- K

07.03.2019 14:04 81% 

 R134A* 

Set	Sample Rate	Duration
	1 Sample/min	8 h
	6 Sample/min	12 h
	30 Sample/min	24 h
	60 Sample/min	48 h
	120 Sample/min	168 h

 REF_M_20190307_140344.csv 

Registrar datos

Asegúrese de que hay una tarjeta SD insertada en la correspondiente ranura.

Acceda al Navegación



Seleccione la tasa de muestreo



Valores entre 1-120 S/min

(S/min = puntos de medición/minutos)

Seleccione la duración de la

medición con .

Valores entre 15 min y 168 h

Comience con el registro con



El nombre del archivo se genera y se muestra automáticamente.

Durante el registro de datos, quedan bloqueadas las funciones de selección de refrigerantes y ajustes.

Para detener el registro de datos antes de tiempo, acceda a

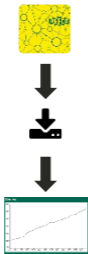

y pulse .

0102**Analizar datos****Opción 1**

Conecte el aparato a un ordenador mediante un cable USB.

Encienda el aparato REFIMATE.

El aparato se muestra en el ordenador como una unidad de disco USB.

Los datos están disponibles en archivos Excel de formato csv.

Opción 2

Transmitir datos a la App:



Abra la App y seleccione

“Transfer Logged data” 
(transferir datos registrados).
Elija el archivo correspondiente.

Visualice la progresión temporal.

6.1.3

Menú **Calibración con presión de referencia**

Acceda al Navegación  con  y .

En  puede efectuar la calibración de los sensores de presión.



Para comenzar la calibración, introduzca el PIN.

El PIN es: 0-0-0-9

¡El aparato no puede estar en este momento bajo presión!

Pulsando 

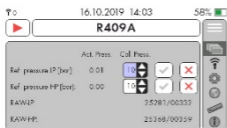

Conecte el aparato a un sistema con una presión determinada.

Rango de presión: 10-60 bar, 150-850 psi

Cuanto más alta sea la presión de calibración, más precisa será la calibración.

Espera hasta que la presión de calibración corresponde al presión de referencia. Pulsando  se calibra cada sensor de temperatura.

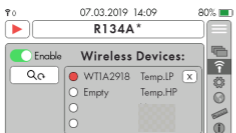
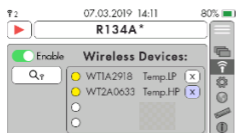

Conexiones

Desde  se accede a todas las conexiones inalámbricas disponibles.

La conexión se activa en la opción "Enable".

Las conexiones se buscan con



y se establecen automáticamente. Observe: los nombres de WTC necesita essere: T1 por LP y T2 por HP.

Todos los dispositivos conectados alguna vez, quedan guardados y se conectan automáticamente al activar la función inalámbrica.

El número de dispositivos conectados se muestra en la parte superior izquierda de la pantalla. También se muestra otra indicación de nivel de carga por si fuera necesario cambiar la pila del termómetro inalámbrico de pinza.

Significado de los colores de indicación:

Verde: aparato conectado

Amarillo: termómetro inalámbrico de pinza conectado y sensor de temperatura insertado

El sensor insertado tiene prioridad y se muestra.

Rojo: aparato guardado no conectado

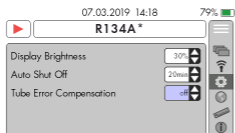
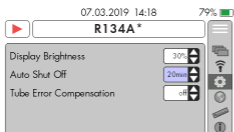

Ajustes generales

En  pueden configurarse distintos ajustes.



La claridad de la pantalla puede regularse a medida.

Función rápida:

Mantenga pulsado el botón  mientras pulsa  o . El nivel de claridad se regula en intervalos del 5%.

En la opción “Apagado automático” se configura el periodo de tiempo tras el que el aparato debe apagarse automáticamente. Esta función puede desactivarse.

Periodo configurable: 1-60 min y off.

La compensación de error de medición en el tubo es una función de corrección de la temperatura que compensa el error de medición de la temperatura del refrigerante en el tubo.

Esta función puede activarse (ON) y desactivarse (OFF).

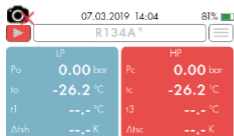
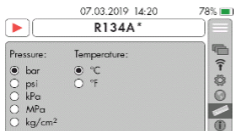

Ajustes de hora e idioma

En  pueden configurarse varios ajustes específicos para cada país.

Aquí, pueden configurarse la fecha, la hora y el idioma.

El idioma configurado por defecto es inglés.

Configuración de unidades

En  pueden configurarse las unidades de temperatura y presión.

Capturas de pantalla (Printscreen)

Manteniendo pulsado  durante 5 segundos, puede crearse una captura de pantalla.

El archivo resultante se guarda en la tarjeta SD en formato BMP.

 Captura de pantalla realizada

 Captura de pantalla fallida



Los archivos de las capturas de pantalla pueden analizarse tal y como se describe en el apartado "Analizar datos".



7 Mantenimiento

Este analizador digital digital requiere un mantenimiento periódico acorde a su uso que incluye las siguientes tareas:



- Limpie la pantalla y la superficie de la carcasa con una bayeta y un producto de limpieza.
- Para limpiar el aparato no pueden utilizarse productos de limpieza o disolventes abrasivos, sino solo productos de limpieza domésticos suaves y soluciones jabonosas.
- Antes de cada uso deben comprobarse visualmente que las conexiones y los tubos de llenado no presentan ningún daño mecánico y deberán cambiarse ante cualquier daño.
- Las juntas de un analizador digital están expuestas de forma natural al desgaste causado por motivos mecánicos y el paso del tiempo. Por lo tanto, el usuario deberá comprobar periódicamente que el analizador digital sigue siendo hermético.
- En las válvulas que no sean herméticas deberá cambiarse el pistón (M4-6-04-R/10).
- El visor del analizador digital se cambia con la llave especial de cambio de visor REFCO M4-6-11-T.



7.1 Actualizar refrigerantes

1	Inicie sesión en la App  y acceda al apartado Actualizaciones.
2	En Refrigerantes se encuentran las versiones actualizadas.
3	Seleccione los refrigerantes actuales y envíelos por correo electrónico.
4	Conecte el aparato REFMATE a su ordenador con un cable USB . 

5	Cuando encienda el aparato REFIMATE, aparecerá el símbolo de una nueva unidad de disco en el ordenador.	
6	Copie a esa nueva unidad de disco el archivo recibido por correo electrónico.	
7	Apague el aparato REFIMATE  y enciéndalo de nuevo  .	
8	La lista de refrigerantes ya está actualizada.	

7.2 Actualizar firmware

1	Inicie sesión en la App  y acceda al apartado Actualizaciones.	
2	En Firmware se encuentra la versión actualizada.	
3	Seleccione el firmware actual y envíeselo por correo electrónico.	
4	Conecte el aparato REFIMATE a su ordenador con un cable USB .	
5	Cuando encienda el aparato REFIMATE, aparecerá el símbolo de nueva unidad de disco en el ordenador.	
6	Copie a esa nueva unidad de disco el archivo recibido por correo electrónico.	

<p>7</p>	<p>Apague el aparato REFIMATE. </p> <p>Inicie el aparato REFIMATE manteniendo pulsados simultáneamente los botones</p> <p>Primero  y después  hasta que la pantalla se encienda.</p>
<p>8</p>	<p>El firmware instalado previamente se borra de la memoria y se instala el nuevo firmware.</p> <p>Duración: aprox. 1,5 min</p>

8 Resolución de problemas

	Problema	Solución
Medir	No se muestra ninguna temperatura.	Se ha excedido el rango de medición. Modifique el ámbito de uso o cambie los sensores de temperatura.
	La presión visualizada es errónea y la presión atmosférica no puede ponerse a cero.	Calibre los sensores de presión.
	Nivel de carga insuficiente para efectuar un test.	Conecte el aparato a la batería externa USB o un adaptador de red con conexión USB.
Registrar	No aparece ningún registro.	No hay ninguna tarjeta de datos insertada. La tarjeta microSD debe estar insertada antes de encender el aparato. La tarjeta microSD está llena.

	No se puede leer la tarjeta SD.	<p>Inserte una tarjeta SD industrial de mayor calidad. Se dará apoyo a:</p> <ul style="list-style-type: none"> • SDSC bis 2GB • SDHC 2GB-32GB • SDXC 32GB-2TB
Capturas de pantalla	Se muestra el icono de captura de pantalla fallida.	<p>No hay ninguna tarjeta de datos insertada.</p> <p>La tarjeta microSD debe estar insertada antes de encender el aparato.</p> <p>La tarjeta microSD está llena.</p>
Conexión	No se puede establecer una conexión Bluetooth con el termómetro inalámbrico de pinza.	<p>Active la función Bluetooth del termómetro de pinza y del aparato REFIMATE.</p> <p>Compruebe la conexión en condiciones de campo libre sin interferencias que obstaculicen la transmisión.</p> <p>Ajuste el termómetro de pinza a T1 y T2.</p>
Mecánica	El gancho se ha soltado.	Empújelo de nuevo hacia dentro.
Otros	El programa se ha bloqueado.	Saque la pila, vuelva a insertarla y encienda de nuevo el aparato REFIMATE.
	Tarda mucho en arrancar.	Borre el firmware y los nuevos refrigerantes de la tarjeta SD.

9 Garantía

El analizador digital REFMATE ha sido diseñado con tecnología avanzada teniendo en cuenta las últimas innovaciones en salud y ergonomía laboral. La empresa REFCO Manufacturing Ltd. está certificada conforme a la norma DIN EN ISO 9001:2008. Los controles de calidad periódicos y la precisión con que se lleva a cabo el proceso de fabricación de nuestros productos garantiza su funcionalidad fiable y son la base de la garantía REFCO aplicable según los términos y condiciones vigentes el día de la entrega del producto. La garantía no cubre los daños provocados por el desgaste o el manejo inadecuado del producto.

10 Información medioambiental

El analizador digital REFMATE ha sido diseñado para optimizar al máximo su duración y, tanto en la adquisición de material como en el proceso de producción, se ha procurado ahorrar energía y ser respetuoso con el medio ambiente. REFCO Manufacturing Ltd. se responsabiliza de sus productos durante "toda su vida". Por eso, REFCO Manufacturing está certificada conforme a la norma DIN EN ISO 14001:2004. Al final de la vida útil del producto, el usuario deberá desecharlo siguiendo la normativa vigente en materia de residuos de su país. La carcasa del producto es de ABS y TPE, los metales sometidos a presión son de aluminio y latón, y el maletín de plástico es de PE.



11 Recambios y accesorios

Recambios	Denominación	Ref.
Botones de recambio (4 vías)	M4-7-SET-+N+R+Y	4687094
Botones de recambio (2 vías)	M2-7-SET-B+R	4687079
Conjunto de válvula completo	M2-10-95-R/2	4687104
Pistón de válvula	M4-6-04-R/10	4662624
Mirilla completa con 2 juntas	M4-6-11	4491018
Desarmador para mirilla	M4-6-11-T	4493169
Pieza roscada con forma de Y	A-31452-Y/3	4687951
Conjunto de válvula completo, 4 piezas	M2-10-95-R/4	4687105
Pistón completo, 4 piezas	M4-6-04-R/4	4687093

Accesorios		
Sensor de temperatura	TEMP-SENSOR	4681394
Termómetro de pinza	TEMP-CLAMP	4681466
Termómetro inalámbrico de pinza	WIRELESS-TEMP-CLAMP	4687785
Maletín de plástico	REFMATE-CASE	4688082

HVAC/R
Service Products



REFCO Manufacturing Ltd.

Industriestrasse 11

CH-6285 Hitzkirch (Switzerland)

Telefon +41 41 919 72 82

Telefax +41 41 919 72 83

info@refco.ch www.refco.ch

4688083 / 4519