



INSTRUMENTS

Eagle 2 Maintenance Data Loader Operator's Manual

Part Number: 71-0191RK

Revision: F

Released: 4/14/17

www.rkiinstruments.com

Warranty

RKI Instruments, Inc. warrants gas alarm equipment sold by us to be free from defects in materials and workmanship, and performance for a period of one year from date of shipment from RKI Instruments, Inc. Any parts found defective within that period will be repaired or replaced, at our option, free of charge. This warranty does not apply to those items which by their nature are subject to deterioration or consumption in normal service, and which must be cleaned, repaired, or replaced on a routine basis. Examples of such items are:

Absorbent cartridges	Batteries
Pump diaphragms and valves	Filter elements
Fuses	

Warranty is voided by abuse including mechanical damage, alteration, rough handling, or repairs procedures not in accordance with the instruction manual. This warranty indicates the full extent of our liability, and we are not responsible for removal or replacement costs, local repair costs, transportation costs, or contingent expenses incurred without our prior approval.

This warranty is expressly in lieu of any and all other warranties and representations, expressed or implied, and all other obligations or liabilities on the part of RKI Instruments, Inc. including but not limited to the warranty of merchantability or fitness for a particular purpose. In no event shall RKI Instruments, Inc. be liable for indirect, incidental, or consequential loss or damage of any kind connected with the use of its products or failure of its products to function or operate properly.

This warranty covers instruments and parts sold to users only by authorized distributors, dealers, and representatives as appointed by RKI Instruments, Inc.

We do not assume indemnification for any accident or damage caused by the operation of this gas monitor and our warranty is limited to replacement of parts or our complete goods.

Table of Contents

Introduction	1
System Requirements	2
Installing the Eagle 2 Maintenance Data Loader Program	3
IrDA Downloading Cable	4
Installing an IrDA Adapter Cable	5
Windows [®] Wireless Link Operation Note	5
Launching the Program	7
Connecting an Eagle 2 to the Maintenance Data Loader Program	8
Control Buttons	10
Get Current Eagle 2 Data	10
Select Distributed File	11
Transmit New Data	12
Power OFF	12
Exit	12
Station and User Tab	13
Conversion Table Tab	17
PID Sensor Tab	22
Obtaining a Relative Response Factor	28
Spare Parts List	40

Introduction

CAUTION: *Read and understand this manual before using the Eagle 2 Maintenance Data Loader Program. Also read and understand the Eagle 2 Operator's Manual included with the Eagle 2 portable gas monitor.*

Using an advanced detection system consisting of up to six gas sensors, the Eagle 2 Personal Gas Monitor detects the presence of combustible gases, oxygen (O₂), carbon monoxide (CO), and hydrogen sulfide (H₂S) simultaneously. The Eagle 2's compact size and easy-to-use design make it ideally suited for a wide range of applications as described in the Eagle 2 Operator's Manual. Please read the Eagle 2 Operator's Manual first before using the Eagle 2 Maintenance Data Loader Program.

The Eagle 2 Maintenance Data Loader Program allows you to change various instrument parameters not accessible in the Eagle 2's user interface. It also allows you to save parameter configuration files based on instruments' parameter settings that can be viewed or used to update another instrument's parameter settings.

The purpose of this manual is to explain how to use the Eagle 2 Maintenance Data Loader Program. You will learn how to:

- install and launch the program
- install the downloading cable (if needed)
- connect to the Eagle 2 with the program
- change parameters in the Eagle 2
- save parameter configuration files that can be opened, viewed, and edited in a word processing program
- save parameter configuration files that can be uploaded to an instrument to change its parameter settings
- upload parameter configuration files to an instrument to change its parameter settings

Before you get started, be sure to review system requirements in the

next section.

CAUTION: *The Eagle 2 detects oxygen deficiency and elevated levels of oxygen, combustible gases, carbon monoxide, and hydrogen sulfide, all of which can be dangerous or life threatening. When using the Eagle 2, you must follow the instructions and warnings in the Eagle 2 Operator's Manual to assure proper and safe operation of the unit and to minimize the risk of personal injury.*

CAUTION: *The operator of this instrument is advised that if the equipment is used in a manner not specified in this manual, the protection provided by the equipment may be impaired.*

System Requirements

To use the Eagle 2 Maintenance Data Loader Program, your personal computer must meet the following requirements:

- **Operating Systems:** Windows[®] 7, Windows[®] 8, or Windows[®] 10.
- **Processor:** IBM[®] compatible PC running Pentium[®] 2 or higher.
- **Memory:** 32 MB RAM minimum
- **Available Hard Disk Space:** 32 MB minimum
- **Infrared port or USB port and a USB/IrDA adapter cable**

Installing the Eagle 2 Maintenance Data Loader Program

1. Launch Windows®.
2. Exit from all applications and open windows.
3. Go to www.rkiinstruments.com/eagle2.
4. Click on the **Download** tab.
5. Click the **Eagle 2 Maintenance Data Loader** link.
6. A .zip file will begin to download. Select whether you want to open or save the .zip file.
7. Extract the contents of the .zip file.
8. Double click the **setup.exe** file.
9. After a few seconds, a screen appears indicating that the InstallShield Wizard is preparing to install the E2 Maintenance Setup, then the E2 Maintenance InstallShield Wizard window appears to guide you through installation.

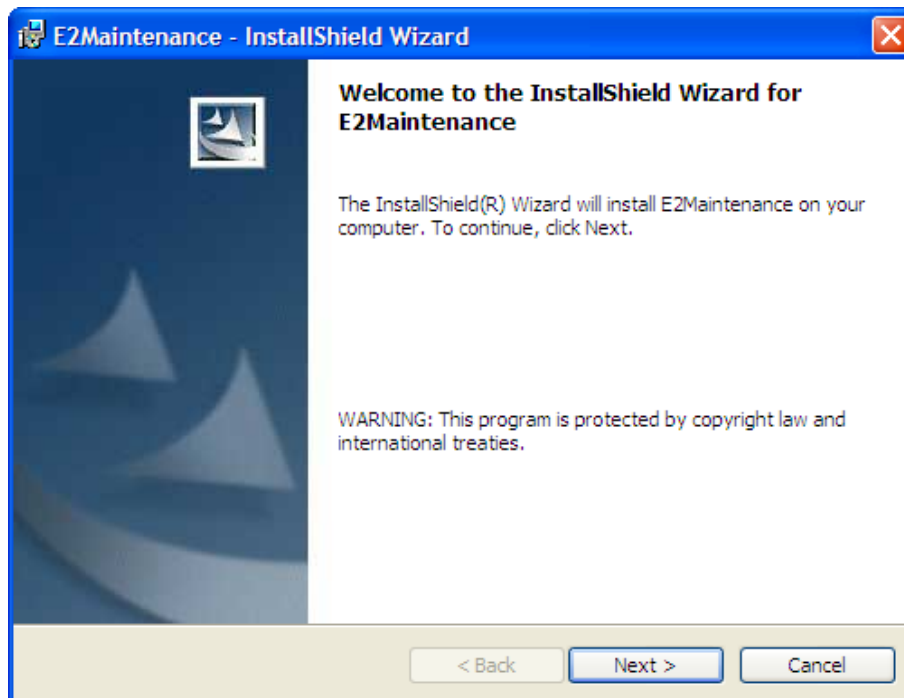

Figure 1: Eagle 2 User Setup Installation Program

10. Follow the on-screen instructions in the InstallShield Wizard Window to install the program.
11. If the InstallShield Wizard finds versions of Windows[®] files on your computer newer than those in the downloaded .zip file, it will ask you if you want to keep these newer files. Click **Yes**.
12. When the InstallShield Wizard indicates that installation is complete, click the **Finish** button.

IrDA Downloading Cable

The Eagle 2 communicates with a computer via an on-board infrared communication port that complies with IrDA protocol standards.

NOTE: If your computer has a built-in infrared port, you do not need an adapter cable to download data.

If your computer does not have an infrared port, you will need to install an IrDA/USB adapter cable on your computer to use the Eagle 2 Maintenance Data Loader Program with your Eagle 2. The IrDA/USB cable is available from RKI Instruments, Inc. See the Spare Parts List at the end of this manual for the RKI part number. This cable can also be found on many electronic supply websites.

Some versions of Windows[®] already have several infrared device drivers loaded in Windows[®] and will automatically recognize a cable during the installation process and guide you in installing the drivers. Other versions of Windows[®] will require you to load device drivers provided by the manufacturer of the cable during the installation process. RKI makes no warranty for the operation or compatibility of the drivers with any particular device.

Installing an IrDA Adapter Cable

After installing the Eagle 2 Maintenance Data Loader Program, connect the IrDA/USB cable to your computer and follow the manufacturer's instructions for installing the cable on your computer. Make sure the cable is compatible with your Windows[®] operating system.

If you do not have instructions from the cable manufacturer for installing your cable, see your Windows documentation. In general, you must go to the Control Panel and use the Add Hardware Wizard to install the cable drivers.

Windows[®] Wireless Link Operation Note

When using an IrDA adapter cable and the Eagle 2 Maintenance Data Loader Program on a Windows[®] computer, it is necessary to make a special setting in the Wireless Link Configuration window for proper communication between the Eagle 2 and the Eagle 2 Maintenance Data Loader Program. This must be done before attempting to use the program. Follow these steps to make this setting:

1. Click **Start** on the Windows[®] Icon Tray.
2. If **Control Panel** is available to select in the **Start** menu, select it. The Control Panel will appear.

If **Control Panel** is not selectable in the Start menu but **Settings** is, select **Settings**, then select **Control Panel**. The Control Panel will appear.

3. Double click on **Wireless Link**. The Wireless Link Configuration window will appear.
4. Click on the Image Transfer tab.
5. Deselect the selection box for "Use Wireless Link to transfer images from a digital camera to your computer."

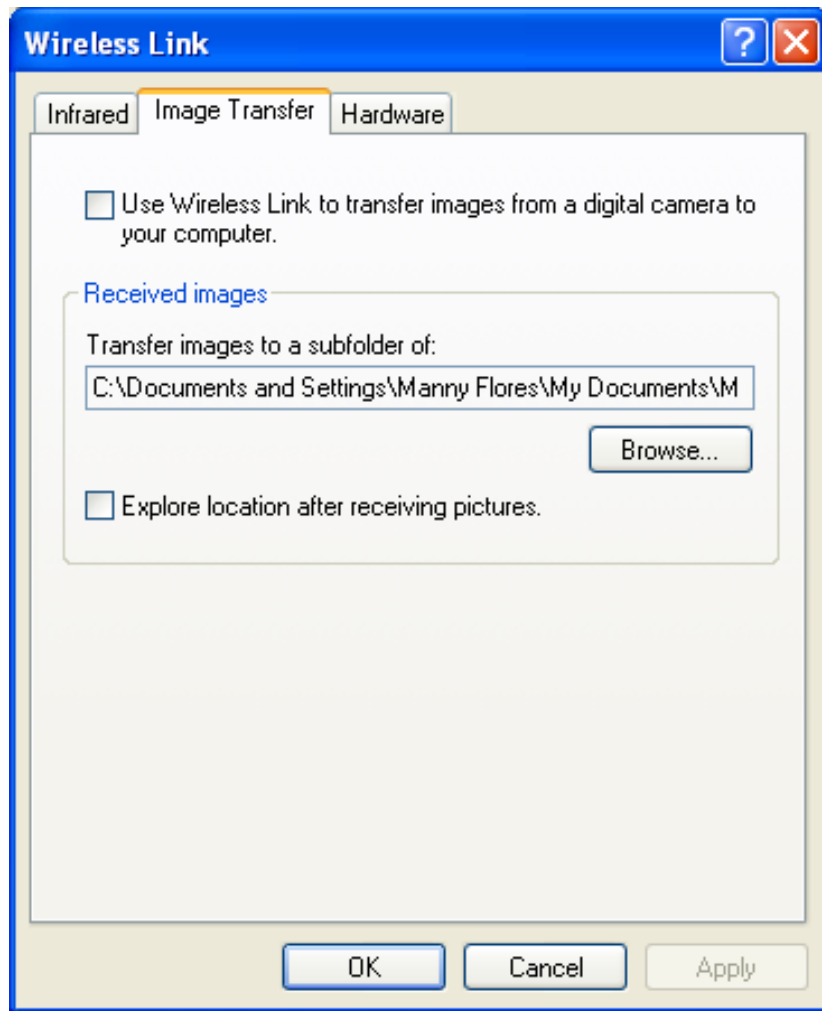

Figure 2: Image Transfer Tab

6. Click **OK**.
7. Close the Control Panel window.

Launching the Program

1. For Windows[®] 7 computers, click the **Start** icon in the Windows[®] Icon Tray, then select **Programs**, then select **E2 Maintenance**. Your operating system may also have a shortcut installed in the **Start** menu.

For Windows[®] 8 and Windows[®] 10 computers, click the **Start** icon in the Windows[®] Icon Tray, then click the downward-pointing arrow icon in the lower left corner of the screen, then select **E2 Maintenance** from the list of apps.

2. The Main Window will appear.

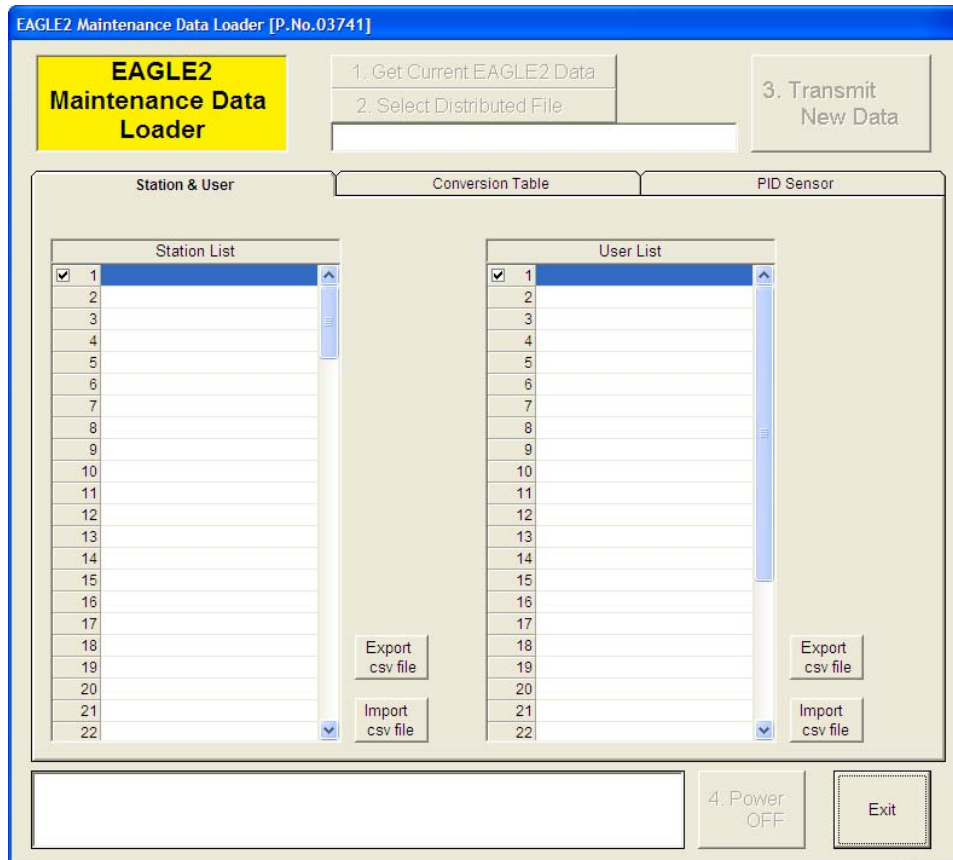

Figure 3: The Main Window

3. For convenience, make a shortcut of the Eagle 2 Maintenance Data Loader Program and place it on the Windows[®] desktop. See your Windows[®] documentation for information about making shortcuts.

Connecting an Eagle 2 to the Maintenance Data Loader Program

Follow these steps to connect an Eagle 2 to the Maintenance Data Loader Program:

1. Launch the Eagle 2 Maintenance Data Loader Program as described in “Launching the Program” on page 7. The Main Window displays.

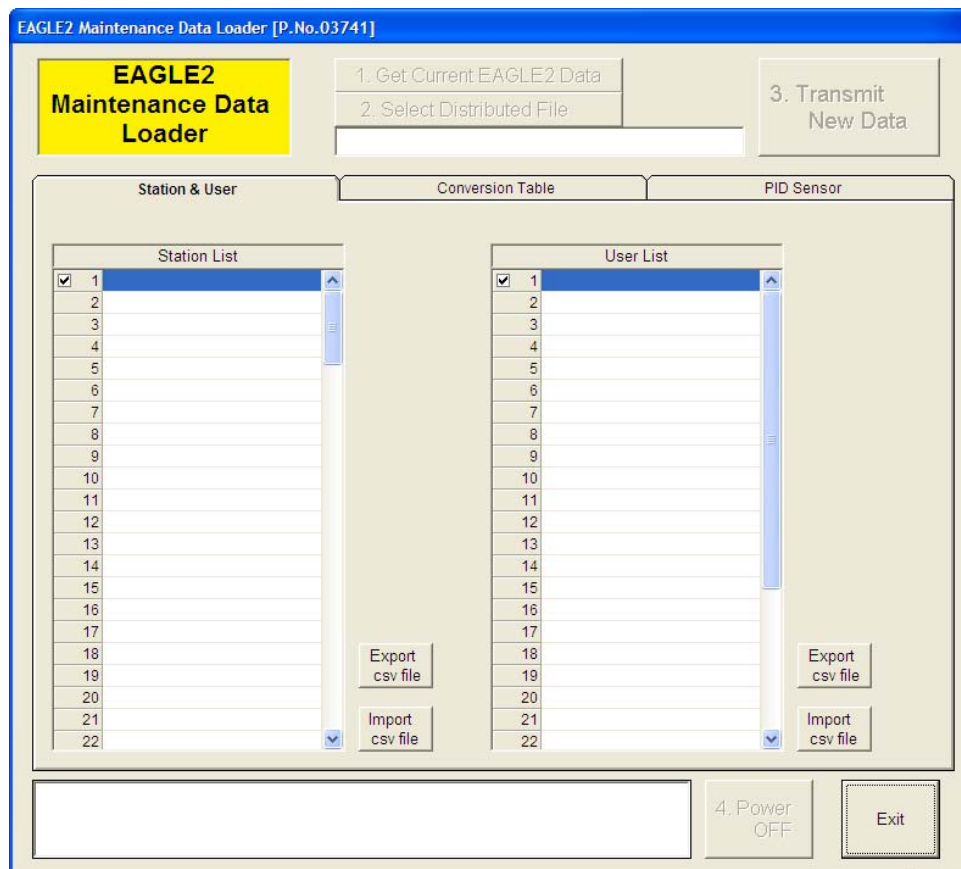

Figure 4: The Main Window

2. Place the Eagle 2 within an inch or two of the infrared port on your computer aligning the infrared port on the front of the Eagle 2 with the infrared port on your computer.
If your computer does not have a built in infrared port, place the Eagle 2 within an inch or two of the infrared port on the IrDA adapter cable as shown in Figure 5 below, aligning the infrared port on the front of the Eagle 2 with the infrared port on the cable.

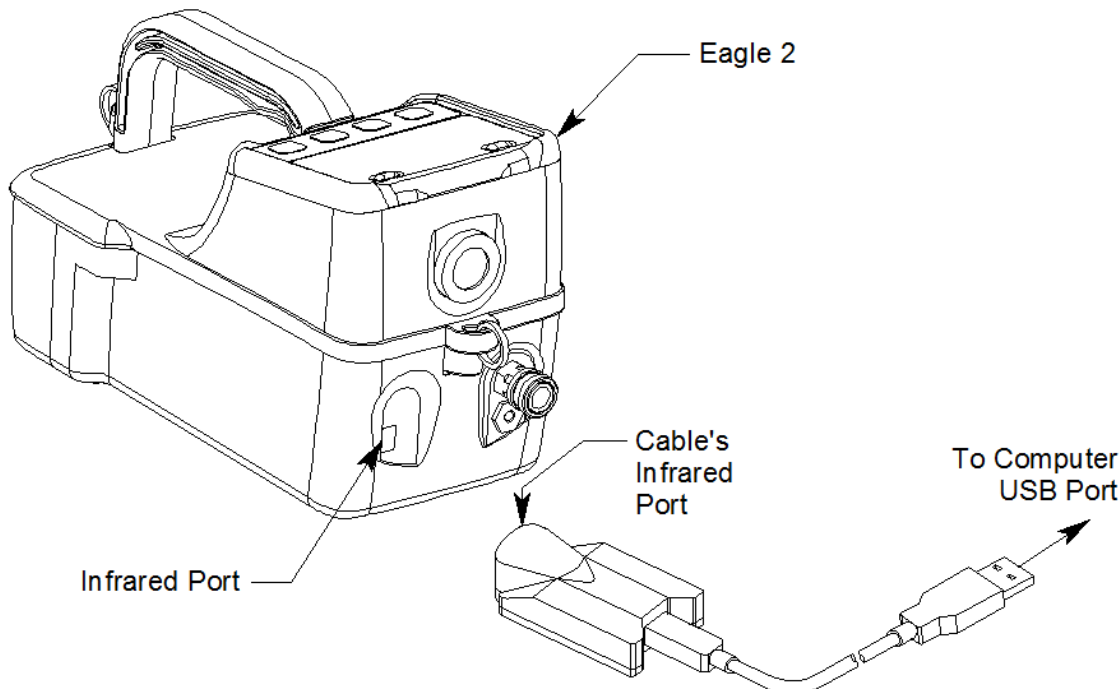

Figure 5: Aligning the Eagle 2 with the Cable Infrared Port

3. Press and hold the **POWER ENTER RESET** button on the Eagle 2 until you hear a beep, then release it. The Eagle 2 will begin its power up sequence. If a successful connection between the Eagle 2 and the computer occurs, the **Get Current EAGLE 2 Data** control button becomes active.

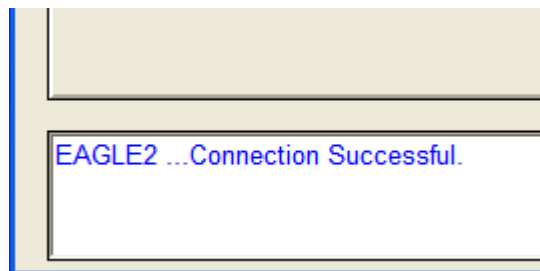

Figure 6: Connection Message

You can now retrieve the connected instrument's configuration information using the **Get Current EAGLE 2 Data** command button. You must retrieve the connected instrument's configuration information before you can perform operations such as saving the instrument's user and station IDs, catalytic combustible user defined relative response gas list, or PID user defined relative response gas list parameter configuration to a file and changing the instrument's parameter configuration.

Control Buttons

There are 5 control buttons on the main screen: **Get Current EAGLE 2 Data**, **Select Distributed File**, **Transmit New Data**, **Power OFF**, and **Exit**. These buttons are used for communication between the Eagle 2 and the Eagle 2 Maintenance Data Loader Program.

Get Current EAGLE 2 Data

Use **Get Current EAGLE 2 Data** to load a connected instrument's user and station IDs, catalytic combustible user defined gases, and PID user defined gas parameter configuration into the Maintenance Data Loader Program so they can be updated if desired. Follow these steps to retrieve a connected instrument's parameter configuration and update parameters that are available in the Eagle 2 Status area:

1. Launch the Eagle 2 Maintenance Data Loader Program as described in "Launching the Program" on page 7.
2. Connect the Eagle 2 to the Maintenance Data Loader Program as described in "Connecting an Eagle 2 to the Maintenance Data Loader Program" on page 8.

3. Click **Get Current EAGLE 2 Data** to retrieve the instrument's user and station ID, catalytic combustible user defined gases, and PID user defined gas parameter configuration. The program indicates that it is downloading information from the instrument.

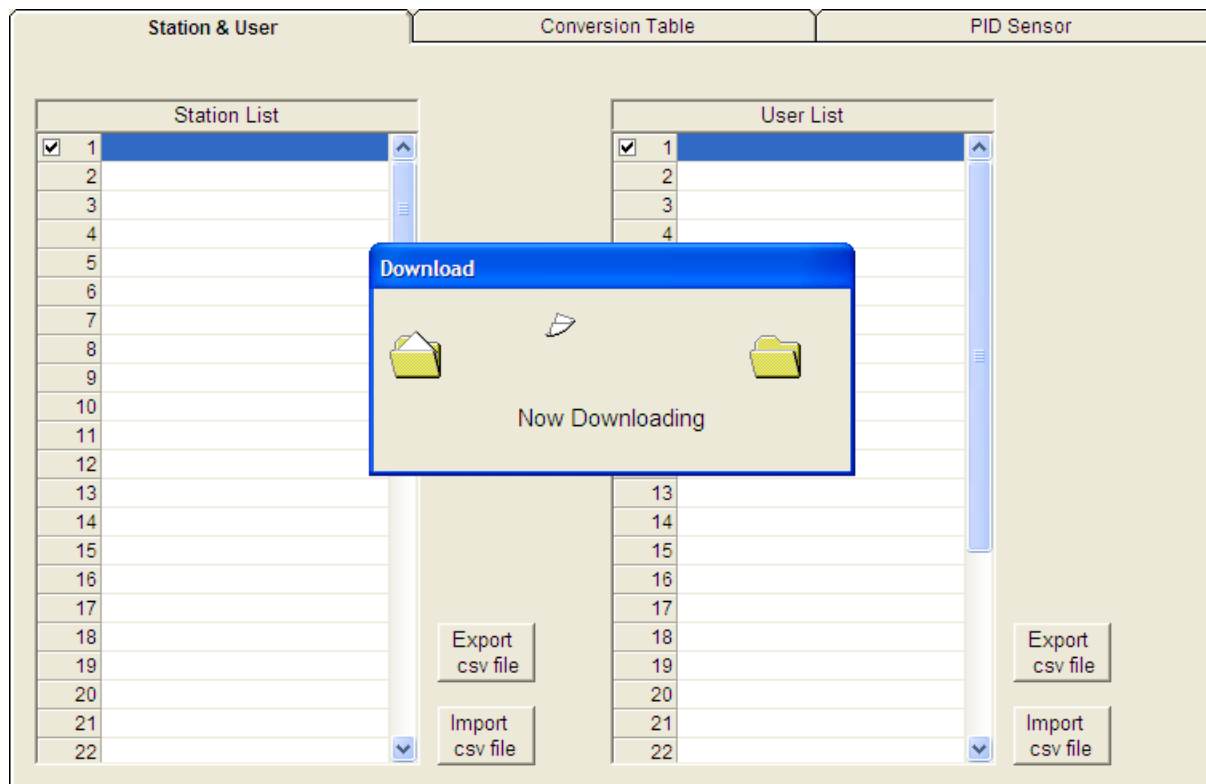

Figure 7: Instrument Information Downloading

4. The instrument's user and station ID, catalytic combustible user defined gases, and PID user defined gas parameter configuration are now loaded in the Maintenance Data Loader Program and the parameters are available for updating.

Select Distributed File

This control button only becomes active after data has been downloaded to the Maintenance Data Loader Program. The function controlled by this button is not needed for normal field use of the program. This function and the text field below it are for use by field service personnel with a factory program at their disposal to generate a distributed file.

Transmit New Data

After information has been updated in the parameter tabs, this button is used to upload that data to the Eagle 2.

NOTE: The Transmit New Data button transfers data from all tabs at once. To prevent the transmitting of empty parameter fields, it is advisable that you download data from the instrument before pressing the Transmit New Data button.

Power OFF

This button is used to turn off the Eagle 2 after all desired updates have been made.

Exit

This button closes the Eagle 2 Maintenance Data Loader Program. Be sure to turn off the Eagle 2 instrument before closing the Maintenance Data Loader Program to prevent the Eagle 2 from remaining on and draining battery voltage.

Station & User Tab

The Station & User tab displays a list of Station IDs and User IDs. The first time the Eagle 2 is connected to the Maintenance Data Loader Program, this list will be blank. No Station IDs or User IDs are loaded into the Eagle 2 at the factory. These are user-defined parameters that may only be configured using the Maintenance Data Loader Program. Up to 128 Station IDs and up to 32 User IDs may be defined.

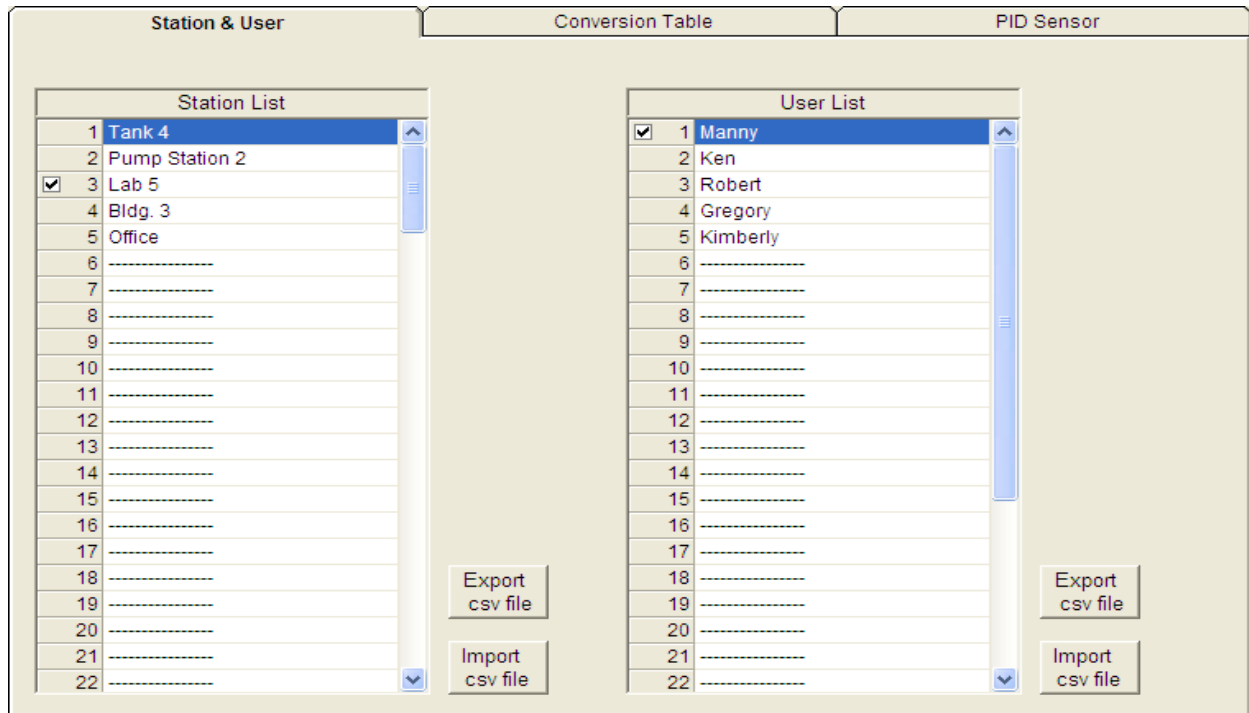

Figure 8: Station & User Tab

CSV Files

To edit the Station ID or User ID list, you will need to import a csv (comma separated values) file into the program. A Station csv file and a User csv file are provided with the program. In addition, you can generate csv files for editing from the program. To access them, you must press the “Export csv file” button for the Station and User IDs in the Station and User tab.

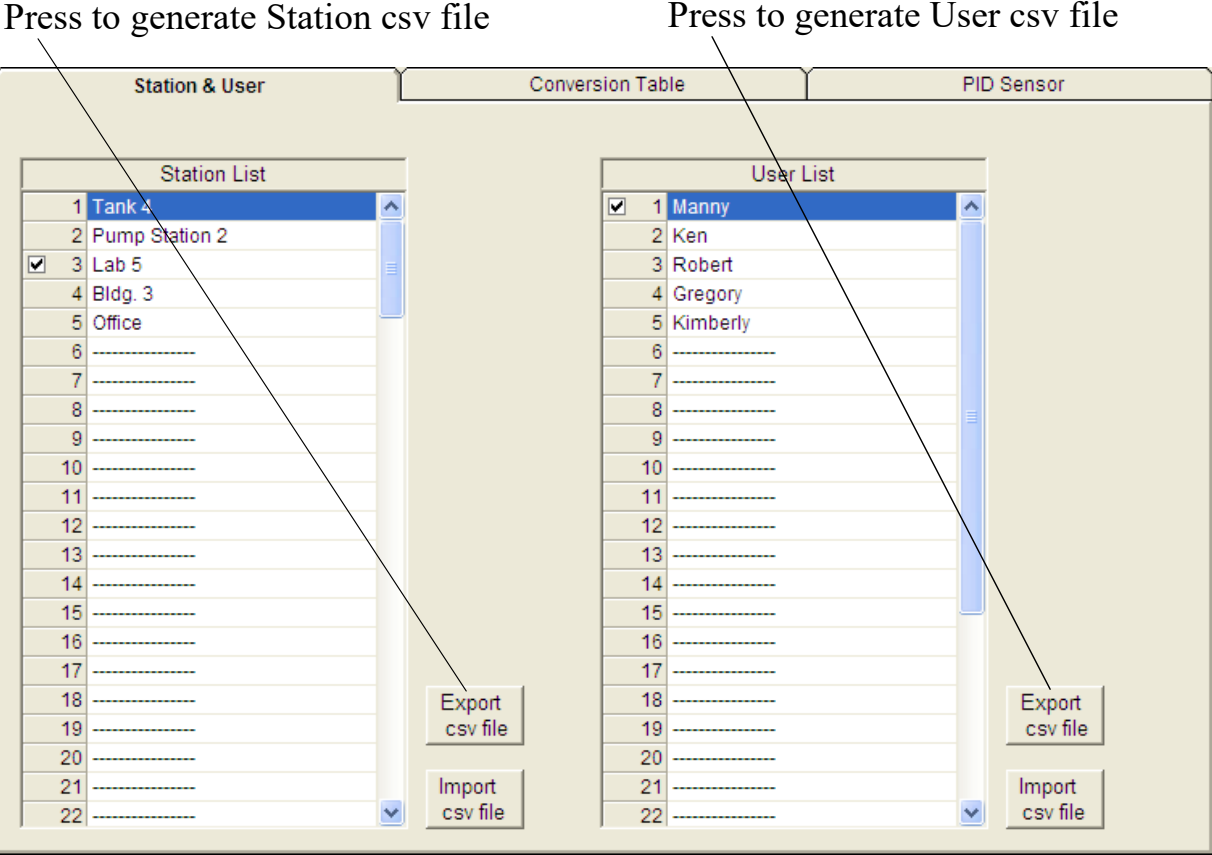

Figure 9: Station csv File

The csv files can be opened, edited, and saved using a word processing program such as Word, WordPad, or Notepad. The Station and User csv files consist of the Station or User ID number and its associated name. Below is an example of a Station csv file opened in WordPad.

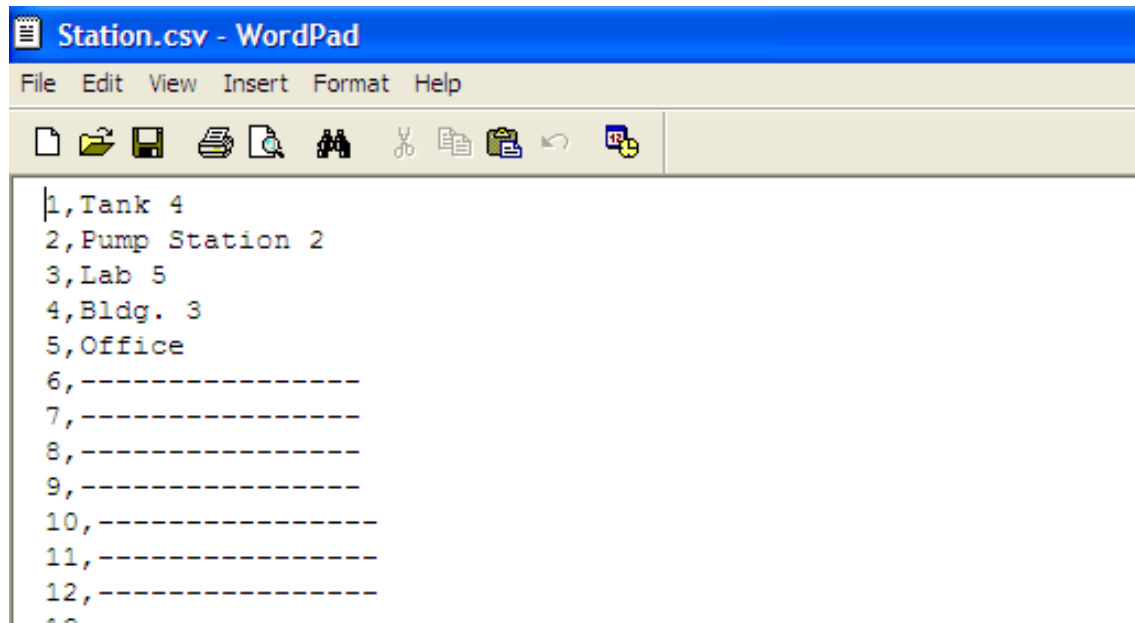

Figure 10: Station csv File

Any existing Station or User IDs will be displayed. Undefined Station or User IDs will appear as dashes. To edit a Station or User ID, delete either the existing name or the dashes and replace them with the desired name. The name may consist of any letter, number, or character. If desired, you can save multiple Station and User ID files.

Loading User and Station IDs

To load new User and Station IDs, do the following:

1. Launch the Eagle 2 Maintenance Data Loader Program and connect and instrument as described in “Connecting an Eagle 2 to the Maintenance Data Loader Program” on page 8.
2. Download the instrument data to the program by pressing **Get Current EAGLE 2 Data**.
3. Locate an existing Station or User csv file or generate a new one for editing. To generate a new one, press “Export csv file” in the Station and User tab for both the Station ID and User ID lists and save the files in a convenient place.

4. Open the saved files in Word, WordPad, or Notepad, enter new Station or User IDs, and save the files.
5. In the Station and User tab, press “Import csv file” for both the Station ID and User ID and select the respective newly edited csv file for each.

Press to import Station csv file

Press to import User csv file

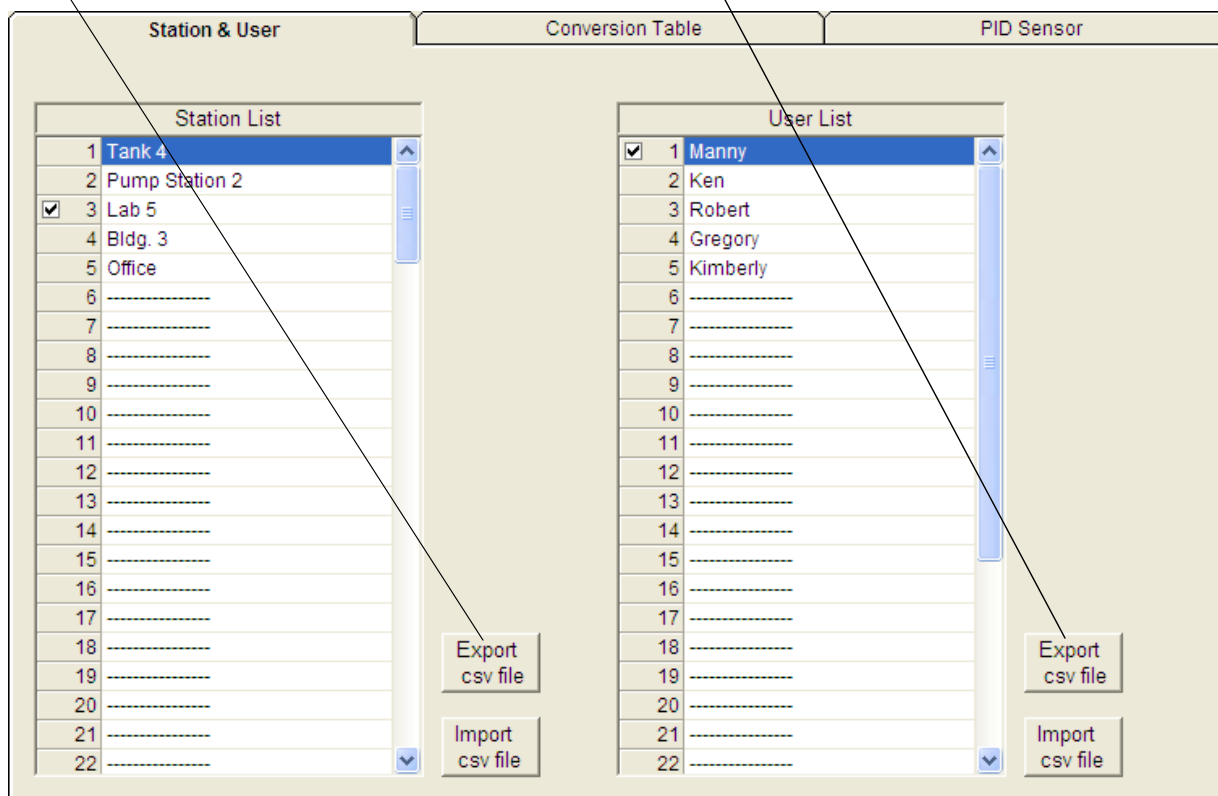

Figure 11: Import csv File

6. Once the Station ID and User ID lists have been generated, select the Station or User ID that will be loaded in the Eagle 2 as the current one by clicking on it. A check mark will appear next to the appropriate Station or User ID.
7. To upload the new information from the Management Data Loader Program to the Eagle 2, press **Transmit New Data**.
8. Turn off the Eagle 2 by pressing the **Power OFF** button

Conversion Table Tab

The Conversion Table tab is used to view the pre-defined relative response gases for the catalytic combustible channel and to edit or add user-defined gases. The pre-defined gases can be found in the Pre-Defined Table tab while the user-defined gases can be found under the User-Defined Table tab.

No	Name	Long Name	Factor	1st	2nd	Ratio	Volt	Available Count
1	ACT	ACETONE	1.40	2500	12500	25000	Normal	29
2	BNZ	BENZENE	1.75	1200	6000	12000	Normal	
3	BAR	BUTYL ACRYLATE	3.95	1700	8500	17000	Normal	
4	BAC	BUTYL ACETATE	3.38	1300	6500	13000	Normal	
5	2BA	2-BUTYL ALCOHOL	1.94	1700	8500	17000	Normal	
6	1BA	1-BUTYL ALCOHOL	2.65	1400	7000	14000	Normal	
7	CYH	CYCLOHEXANE	1.82	1300	6500	13000	Normal	
8	CUM	CUMENE	3.90	900	4500	9000	Normal	
9	EDC	ETHYLENE DICHLORIDE	2.75	6000	31000	62000	Normal	
10	ETA	ETHYL ALCOHOL	1.38	3250	16500	33000	Normal	
11	ECL	ETHYL CHLORIDE	1.26	3750	19000	38000	Normal	
12	EAC	ETHYL ACRYLATE	2.45	1400	7000	14000	Normal	
13	HEX	HEXANE	2.44	1100	5500	11000	Normal	
14	H2	HYDROGEN	1.16	4000	20000	40000	Normal	
15	IBU	ISOBUTANE	1.61	1800	9000	18000	Normal	
16	IPA	ISOPROPANOL	2.22	2000	10000	20000	Normal	
17	CH4	METHANE	1.00	5000	25000	50000	Normal	

Figure 12: Conversion Table

There are 8 columns in both the Pre-Defined Table tab and the User-Defined Table tab:

- No
This column represents the gas number. The gas numbers are 1-30.
- Name
This is what will appear in the Relative Response list of gases. The name can be up to 3 characters long and the characters must be upper case letters or numbers. No special characters may be used in the Name column.
- Long Name
The Long Name column is used to better describe the target gas. It

may contain any character in upper- or lower-case.

- **Factor**
This value is the response factor for the listed gas relative to methane. The factor for each pre-defined gas is factory defined. The factor for any user-defined gases must be obtained through testing as described in “Obtaining a Relative Response Factor” on page 28. Even if not all of the user-defined catalytic combustible channels are being defined, the Factor column must have a valid number entered. A valid number for the Factor is a value between 0.01 and 25.00.
- **1st**
This column is for the low alarm point of each gas in ppm units.
- **2nd**
This column is for the high alarm point of each gas in ppm units.
- **Ratio**
The ratio is the ppm value of the LEL for each gas. This value is specific to each gas and can be easily determined. The maximum value it may be set to is 150,000 ppm. If an invalid number is entered, the box will turn red when the csv file is imported back into the Maintenance Data Loader Program.

NOTE: If you define a gas whose LEL is above 50,000 ppm, the %LEL reading in Measuring Mode will reflect the defined ppm ratio, but the ppm reading in Measuring Mode will not indicate above 50,000 ppm. For example, if you set the ratio to be 150,000 ppm and set the catalytic combustible channel to display the reading in ppm, the gas reading will not indicate higher than 50,000 ppm, the equivalent of 33 %LEL and 5% volume for this ratio, but will continue to indicate %LEL readings up to 100 %LEL and %volume readings up to 15 %volume, the equivalent of 150,000 ppm, if the display units are changed to %LEL or %volume. In addition, all adjustable ppm parameters cannot be set higher than 50,000 ppm.

- Volt
This value determines the sensor voltage for the catalytic combustible sensor. It can be set to 1.3 or 2.4. When set to 1.3, the sensor is in methane elimination mode. When set to 2.4, the sensor is reading at full response. Even if not all of the user-defined catalytic combustible channels are being defined, the Volt column must have a valid number entered. A valid number for the Volt column is either 1.3 or 2.4.

While the pre-defined gases may not be edited, the 5 user-defined gases may be edited by doing the following:

1. With the Maintenance Data Loader Program running, click on the Conversion Data tab and then click on the User-Defined Table tab.

No	Name	Long Name	Factor	1st	2nd	Ratio	Volt
1	GA1	Test Gas 1	1.00	5000	8000	9000	2.4
2	GA2	Test Gas 2	1.00	5000	25000	50000	2.4
3	GA3	Test Gas 3	1.00	5000	25000	50000	1.3
4	GA4	Test Gas 4	1.00	5000	25000	50000	1.3
5	GA5	Test Gas 5	1.00	5000	25000	50000	2.4

Figure 13: User-Defined Table

NOTE: Make sure you have downloaded the data from the EAGLE 2 to avoid erasing its data when updating the instrument using the **Transmit New Data** button.

2. If no user-defined gases have been previously defined for the connected instrument, the columns in User-Defined Table will be

- blank. Any previously defined gases will appear.
- Export the current data by pressing the “Export csv file” button. Choose the file path you wish to save the file in.
 - Open the csv file using Notepad, Word, or WordPad. The example below shows a csv file opened in WordPad. The list of gases are associated with the numbers 1-5.

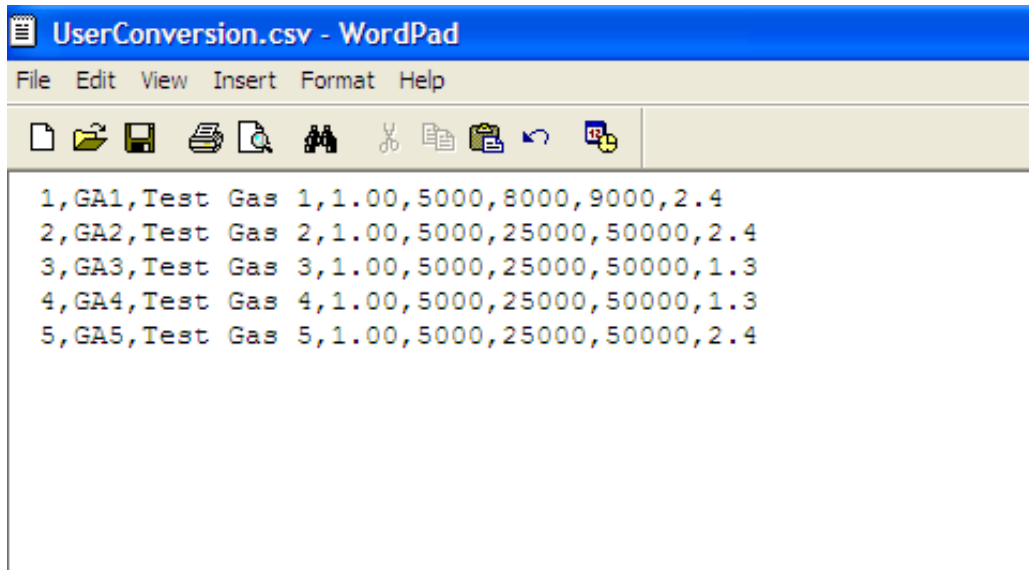

Figure 14: CSV File

If there were no previously defined gases, the csv file will appear as the following:

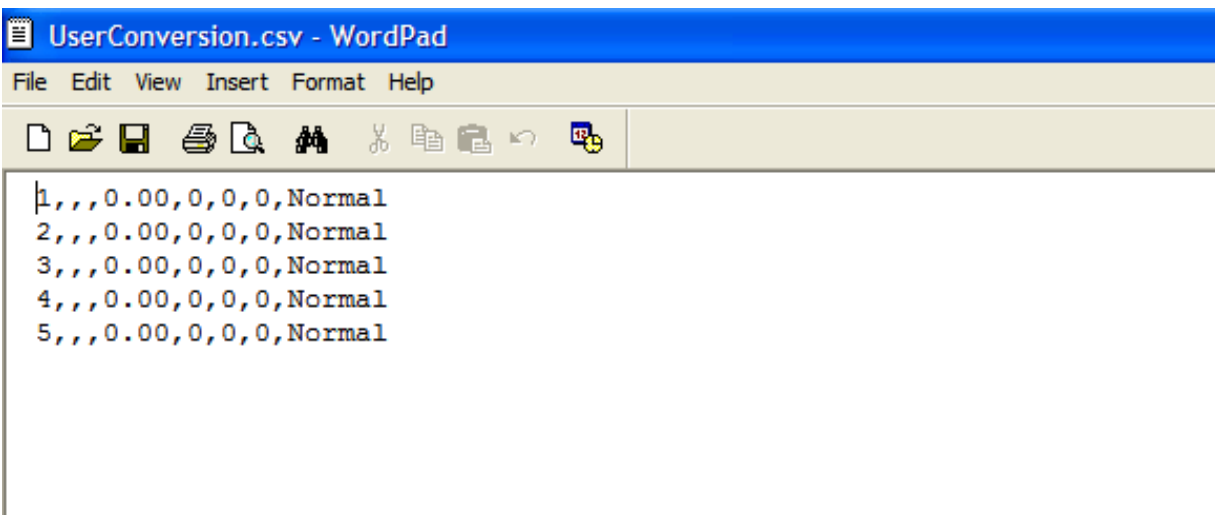

Figure 15: Blank CSV File

- The values in the csv file are all separated by commas. These values are in the same order as the columns in the Maintenance

Data Loader Program. The first value is the gas number, the second is the gas name, etc.

6. Edit the values you wish to change and save and close the file.
7. Return to the Maintenance Data Loader Program with the User-Defined Table tab still up and press “Import csv file”.
8. Choose the file you just edited and press “Open”.
9. The values you entered in the csv file will appear in the User-Defined Table.
10. If the program finds anything wrong with the values that were entered, the box containing those values will turn red. Make sure that you have entered valid characters for each field.
11. Once all of the data you wish to enter has been entered and is correct, transmit the new data to the connected instrument by pressing **Transmit New Data**.

PID Sensor Tab

The PID Sensor tab is used to view the pre-defined relative response gases and to view or define the 1 user-defined relative response gas. Every gas has a low and high range which are displayed in the Low Range tab and High Range tab, respectively.

Station & User			Conversion Table				PID Sensor						
High Range						Low Range							
No	Name	Long Name	FullScale	Point	Unit	Digit	1st	2nd	STEL	TWA	AutoCal	Factor	
1	ACT	ACETONE	1000	1/1	ppm	1	500	750	750	500	500	0.70	
2	BNZ	BENZENE	1000	1/1	ppm	1	50	250	*****	*****	50	0.50	
3	DSL	DIESEL FUEL NO 1	1500	1/1	ppm	1	200	300	*****	200	200	0.80	
4	ETA	ETHANOL	15000	1/1	ppm	10	1000	1500	*****	1000	1000	8.70	
5	GSL	GASOLINE	2000	1/1	ppm	1	300	500	500	300	300	1.10	
6	IBL	ISOBUTYLENE	2000	1/1	ppm	1	400	1000	*****	*****	100	1.00	
7	IPA	ISOPROPANOL	5000	1/1	ppm	2	200	400	400	200	200	4.40	
8	JP5	JP-5 FUEL	1000	1/1	ppm	1	140	210	*****	14	140	0.70	
9	MEK	METHYL ETHYL KETONE	1500	1/1	ppm	1	200	300	300	200	200	0.80	
10	TOL	TOLUENE	1000	1/1	ppm	1	50	150	150	50	50	0.50	
11	HEX	N-HEXANE	5000	1/1	ppm	2	500	1000	1000	500	500	4.20	
12	PRL	PROPYLENE	2500	1/1	ppm	1	500	750	*****	500	500	1.40	
13	STY	STYRENE	500.0	1/10	ppm	0.2	2.0	4.0	4.0	2.0	2.0	0.40	
14	PCE	TETRACHLOROETHYLENE	1000	1/1	ppm	1	25	100	100	25	25	0.70	
15	TCE	TRICHLOROETHYLENE	1000	1/1	ppm	1	50	100	100	50	50	0.70	
16	VCM	VINYL CHLORIDE	4000	1/1	ppm	2	100	500	*****	*****	100	2.10	
17	PID	PID	2000	1/1	ppm	1	*****	*****	*****	*****	*****	1.00	

Figure 16: PID Sensor

There are 13 columns in both the High and Low Range tabs:

- **No**
This column represents the gas number. They are numbered 1-17.
- **Name**
This is what will appear in the Relative Response list of gases. The name can be up to 3 characters long and the characters must be upper case letters or numbers. No special characters may be used in the Name column.
- **Long Name**
The Long Name column is used to better describe the target gas. It may contain any character in upper- or lower-case.

- Full Scale
This is the full scale value for the target gas.
- Point
The point value indicates to what decimal place the gas readings are shown. A value of 1/1 indicates a reading to the “ones” place while a value of 1/100 indicates a reading to the “hundredths” place.
- Unit
The unit describes what units the gas reading is provided in. All units are in ppm. While this parameter may be changed in the csv file, units of ppm are the only acceptable units and changing this parameter to %LEL or %vol will change the unit box to red.
- Digit
The digit is the increment of the gas readings.
- 1st
This column is for the low alarm point of each gas in ppm units.
- 2nd
This column is for the high alarm point of each gas in ppm units.
- STEL
The STEL column displays the STEL values for each gas.
- TWA
The TWA column displays the TWA values for each gas.
- AutoCal
The AutoCal values are those that come up during the auto calibration procedure. They are default values that may be changed if the gas concentration in the calibration cylinder is different.
- Factor
This value is the Relative Response Factor for the PID channel. The factor for each pre-defined gas is factory defined. The factor for the user defined gas must be obtained from Table 4 on page 29 or through testing as described in “Obtaining a Relative Response Factor” on page 28. A valid character for the Factor is a value between 0.01 and 25.00.

There are limitations for the full scale and increment values that depend on the factor for both the high range and the low range. Table 2 and Table 3 below list these limitations.

Table 1: High Range PID

Factor	Full Scale (ppm)	Increment
0.25-0.49	500	0.2
0.50-0.74	1000	1
0.75-0.99	1500	1
1.00-1.24	2000	1
1.25-1.49	2500	1
1.50-1.99	3000	2
2.00-2.49	4000	2
2.50-4.99	5000	2
5.00-7.49	10000	10
7.50-9.99	15000	10
10.00-14.49	20000	10
15.00-24.49	30000	20
25.00	50000	20

Table 2: Low Range PID

Factor	Full Scale (ppm)	Increment
0.20-0.29	10.00	0.01
0.30-0.39	15.00	0.01
0.40-0.49	20.00	0.01
0.50-0.59	25.00	0.01
0.60-0.79	30.00	0.02
0.80-0.99	40.00	0.02

Table 2: Low Range PID

Factor	Full Scale (ppm)	Increment
1.00-1.99	50.00	0.02
2.00-2.99	100.0	0.1
3.00-3.99	150.0	0.1
4.00-5.99	200.0	0.1
6.00-7.99	300.0	0.2
8.00-9.99	400.0	0.2
10.00	500.0	0.2

While the pre-defined gases may not be edited, the 1 user-defined gas may be edited by doing the following:

1. With Maintenance Data Loader Program running, click on the PID Sensor tab and then click on the High Range tab.

High Range			Low Range									
No	Name	Long Name	FullScale	Point	Unit	Digit	1st	2nd	STEL	TWA	AutoCal	Factor
1	ACT	ACETONE	1000	1/1	ppm	1	500	750	750	500	500	0.70
2	BNZ	BENZENE	1000	1/1	ppm	1	50	250	*****	*****	50	0.50
3	DSL	DIESEL FUEL NO 1	1500	1/1	ppm	1	200	300	*****	200	200	0.80
4	ETA	ETHANOL	15000	1/1	ppm	10	1000	1500	*****	1000	1000	8.70
5	GSL	GASOLINE	2000	1/1	ppm	1	300	500	500	300	300	1.10
6	IBL	ISOBUTYLENE	2000	1/1	ppm	1	400	1000	*****	*****	100	1.00
7	IPA	ISOPROPANOL	5000	1/1	ppm	2	200	400	400	200	200	4.40
8	JP5	JP-5 FUEL	1000	1/1	ppm	1	140	210	*****	14	140	0.70
9	MEK	METHYL ETHYL KETONE	1500	1/1	ppm	1	200	300	300	200	200	0.80
10	TOL	TOLUENE	1000	1/1	ppm	1	50	150	150	50	50	0.50
11	HEX	N-HEXANE	5000	1/1	ppm	2	500	1000	1000	500	500	4.20
12	PRL	PROPYLENE	2500	1/1	ppm	1	500	750	*****	500	500	1.40
13	STY	STYRENE	500.0	1/10	ppm	0.2	2.0	4.0	4.0	2.0	2.0	0.40
14	PCE	TETRACHLOROETHYLENE	1000	1/1	ppm	1	25	100	100	25	25	0.70
15	TCE	TRICHLOROETHYLENE	1000	1/1	ppm	1	50	100	100	50	50	0.70
16	VCM	VINYL CHLORIDE	4000	1/1	ppm	2	100	500	*****	*****	100	2.10
17	PID	PID	2000	1/1	ppm	1	*****	*****	*****	*****	*****	1.00

Figure 17: High Range Tab

NOTE: Make sure you have downloaded the data from the EAGLE 2 to avoid erasing its data when updating the instrument using the Transmit New Data button.

2. If no user-defined PID gas has been previously defined for the connected instrument, the name and long name will both appear as PID for the High Range and Low Range tabs. The full scale, digit, and factor values will appear as shown in Table 4 below. The rest of the fields will contain asterisks (*****).

Table 3: Default Values for User Defined PID Gas

	Full Scale (ppm)	Digit	Factor
High Range	2000	2	1.00
Low Range	50.00	0.02	1.00

3. Export the current data by pressing the “Export csv file” button. Choose the file path you wish to save the file in.

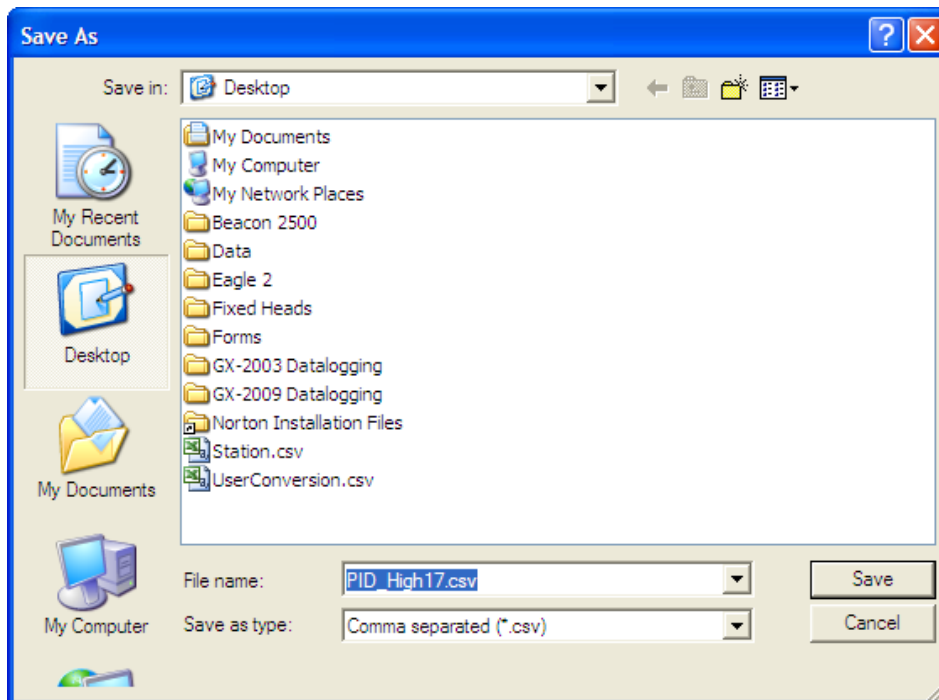

Figure 18: Save As

4. Open the csv file using Notepad, Word, or WordPad. The example below shows a csv file opened in WordPad. The user defined PID gas is number 17.

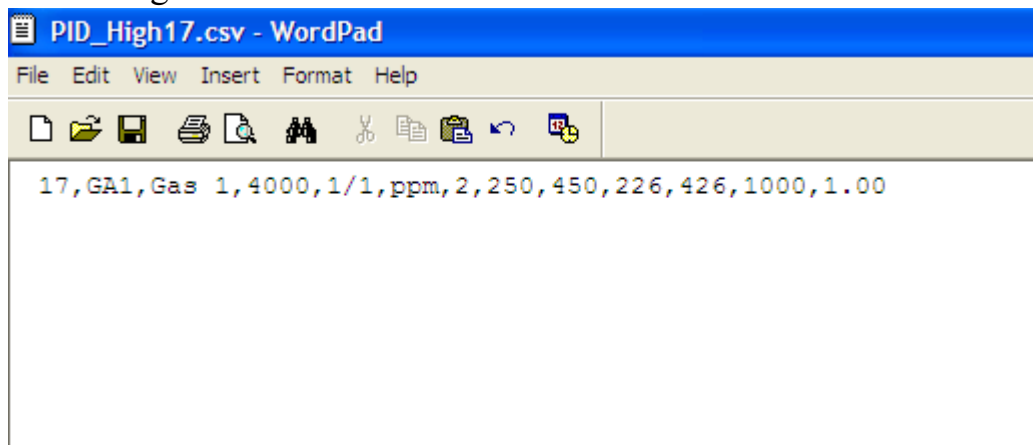

Figure 19: CSV File

5. The values in the csv file are all separated by commas. These values are in the same order as the columns in the Maintenance Data Loader Program. The first value is the gas number, the second is the gas name, etc.
6. Edit the values you wish to change and save the file.
7. Return to the Maintenance Data Loader Program with the High Range tab still up and press "Import csv file".
8. Choose the file you just edited and press "Open".
9. The values you entered in the csv file will appear in the High Range tab.
10. If the program finds anything wrong with the values that were entered, the box containing those values will turn red. Make sure that you have entered valid characters for each field.

NOTE: The Name and Long Name for the Low Range and High Range tabs must agree. If they do not, the program will keep the Low Range Name and Long Name and change the High Range to agree with it.

11. Repeat step 1-step 10 for the Low Range tab.
12. Once all of the data you wish to enter has been entered and is

correct, transmit the new data to the connected instrument by pressing “Transmit New Data”.

Obtaining a Relative Response Factor

If the gas that you want to monitor on the catalytic combustible or PID channel is not included in the catalytic or PID relative response lists, you may define up to 5 gases for the catalytic combustible channel using the Conversion Table tab and 1 gas for the PID channel using the PID Sensor tab. Testing must be done using the desired target gas in order to obtain the response factor value for the catalytic combustible channel. To determine the relative response factor value for the PID channel, first look in Table 4 for the desired gas. If the desired gas does not appear in the table, you must obtain the response factor through the testing procedure described below.

To determine the relative response factor value for the catalytic or PID channels, do the following:

1. For determining the catalytic combustible channel relative response factor, calibrate the catalytic combustible channel to methane. For determining the PID channel relative response factor, calibrate the PID channel to isobutylene.
2. Obtain a gas sample of known concentration for the target gas you wish to define. The sample needs to be at least 10% of the full scale but RKI Instruments, Inc. recommends using 50% of the full scale. If the concentration tested results in an overscale reading, test a lower concentration.
3. Apply the gas sample to the EAGLE 2 and take note of the reading. If the gas sample is of 50 %LEL concentration and the EAGLE 2 display shows a reading of 25 %LEL, then the factor for that gas is 2. Conversely, if the gas sample is of 50 %LEL concentration and the EAGLE 2 display shows a reading of 100 %LEL, then the factor for that gas is 0.5. This conversion factor value is what you will enter in the Factor column of the gas you are defining.

Table 4 below has 4 columns:

- Gas/VOC-The most common name for the VOC (volatile organic

compound)

- CAS No.-Sometimes it is easier to identify a VOC from the internationally recognized CAS (Chemical Abstracts Service) number
- Formula-Molecular formula for each VOC
- Response Factor (RF)-The relative response factor for each gas. This is the value that is plugged into the Eagle 2 Maintenance Data Loader Program.

Some abbreviations that appear in the table are:

- ZR-No response
- NV-Cannot be measured

Table 4: Response Factors Relative to Isobutylene

Gas/ VOC	CAS No.	Formula	Relative Response
Acetaldehyde	75-07-0	C ₂ H ₄ O	4.9
Acetic Acid	64-17-7	C ₂ H ₄ O ₂	36
Acetic Anhydride	108-24-7	C ₄ H ₆ O ₃	4
Acetone	67-64-1	C ₃ H ₆ O	0.7
Acetonitrile	75-05-8	CH ₃ CN	ZR
Acetylene	74-86-2	C ₂ H ₂	ZR
Acrolein	107-02-8	C ₃ H ₄ O	4
Acrylic Acid	79-10-7	C ₃ H ₄ O ₂	2.7
Acrylonitrile	107-13-1	C ₃ H ₃ N	ZR
Allyl alcohol	107-18-6	C ₃ H ₆ O	2.1
Allyl chloride	107-05-1	C ₃ H ₅ Cl	4.5
Ammonia	7664-41-7	NH ₃	8.5
Amyl acetate, n-	628-63-7	C ₇ H ₁₄ O ₂	1.8
Amyl alcohol	71-41-0	C ₅ H ₁₂ O	3.2
Aniline	62-53-3	C ₆ H ₇ N	0.5
Anisole	100-66-3	C ₇ H ₈ O	0.5
Arsine	7784-42-1	AsH ₃	2.5
Asphalt, petroleum fumes	8052-42-4		1
Benzaldehyde	100-52-7	C ₇ H ₆ O	0.9
Benzene	71-43-2	C ₆ H ₆	0.5
Benzenethiol	108-98-5	C ₆ H ₅ SH	0.7
Benzonitrile	100-47-0	C ₇ H ₅ N	0.7
Benzyl alcohol	100-51-6	C ₇ H ₈ O	1.3
Benzyl chloride	100-44-7	C ₇ H ₇ Cl	0.6
Benzyl formate	104-57-4	C ₈ H ₈ O ₂	0.8

Gas/ VOC	CAS No.	Formula	Relative Response
Biphenyl	92-52-4	C12H10	0.4
Bis(2,3-epoxypropyl) ether	7/5/38	C6H10O3	3
Boron trifluoride	7637 07 2	BF3	ZR
Bromine	7726-95-6	Br2	20
Bromine pentafluoride	7789-30-2	BrF5	ZR
Bromobenzene	108-86-1	C6H5Br	0.7
Bromochloromethane	74-97-5	CH2ClBr	ZR
Bromoethane	74-96-4	C2H5Br	5
Bromoethyl methyl ether, 2-	6482-24-2	C3H7OBr	2.5
Bromoform	75-25-2	CHBr3	2.8
Bromopropane, 1-	106-94-5	C3H7Br	1.3
Bromotrifluoromethane	75-63-8	CF3Br	ZR
Butadiene	106-99-0	C4H6	0.8
Butadiene diepoxide, 1,3-	1464-53-5	C4H6O2	4
Butane, n-	106-97-8	C4H10	46
Butanol, 1-	71-36-3	C4H10O	4
Buten-3-ol, 1-	598-32-3	C4H8O	1.2
Butene, 1-	106-98-9	C4H8	1.3
Butoxyethanol, 2-	111-76-2	C6H14O2	1.1
Butyl acetate, n-	123-86-4	C6H12O2	2.4
Butyl acrylate, n-	141-32-2	C7H12O2	1.5
Butyl lactate	138-22-7	C7H14O3	2.5
Butyl mercaptan	109-79-5	C4H10S	0.5
Butylamine, 2-	513-49-5	C4H11N	0.9
Butylamine, n-	109-73-9	C4H11N	1
Camphene	565-00-4	C10H16	0.5
Carbon dioxide	124-38-9	CO2	ZR
Carbon disulfide	75-15-0	CS2	1.4
Carbon monoxide	630-08-0	CO	ZR
Carbon tetrabromide	558-13-4	CBr4	3
Carbon tetrachloride	56-23-5	CCl4	ZR
Carbonyl sulphide	463-58-1	COS	ZR
Carvone, R-	6485-40-1	C10H14O	1
Chlorine	7782-50-5	Cl2	ZR
Chlorine dioxide	10049-04-4	ClO2	1
Chlorine trifluoride	7790-91-2	ClF3	ZR
Chloro-1,1,1,2-tetrafluoroethane	2837-89-0	C2HClF4	ZR
Chloro-1,1,1-trifluoroethane, 2-	75-88-7	C2H2ClF3	ZR
Chloro-1,1,2,2-tetrafluoroethane	354-25-6	C2HClF4	ZR
Chloro-1,1,2-trifluoroethane, 1-	421-04-5	C2H2ClF3	ZR
Chloro-1,1-difluoroethane, 1-	75-68-3	C2H3ClF2	ZR
Chloro-1,1-difluoroethane, 1-	75-68-3	C2H3ClF2	ZR
Chloro-1,1-difluoroethane, 2-	338-65-8	C2H3ClF2	ZR
Chloro-1,2,2-trifluoroethane	431-07-2	C2H2ClF3	ZR

Gas/ VOC	CAS No.	Formula	Relative Response
Chloro-1,3-butadiene, 2-	126-99-8	C4H5Cl	3.2
Chloro-1-fluoroethane, 1-	1615-75-4	C2H4ClF	ZR
Chloro-2-fluoroethane, 1-	762-50-5	C2H4ClF	ZR
Chloroacetaldehyde	107-20-0	C2H3OCl	ZR
Chlorobenzene	108-90-7	C6H5Cl	0.5
Chlorodifluoromethane	75-45-6	CHClF2	ZR
Chloroethane	75-00-3	C2H5Cl	ZR
Chloroethanol 2-	107-07-3	C2H5ClO	10
Chloroethyl methyl ether, 2-	627-42-9	C3H7ClO	2.6
Chlorofluoromethane	593-70-4	CH2ClF	ZR
Chloroform	67-66-3	CHCl3	ZR
Chloromethane	74-87-3	CH3Cl	ZR
Chloropentafluoroethane	76-15-3	C2ClF5	ZR
Chlorotoluene, o-	95-49-8	C7H7Cl	0.5
Chlorotoluene, p-	108-41-8	C7H7Cl	0.5
Chlorotrifluoroethylene	79-38-9	C2ClF3	1
Chlorotrifluoromethane	75-72-9	CClF3	ZR
Citral	5392-40-5	C10H16O	1
Citronellol	26489-01-0	C10H20O	1
Cresol, m-	108-39-4	C7H8O	1.1
Cresol, o-	95-48-7	C7H8O	1.1
Cresol, p-	106-44-5	C7H8O	1.1
Crotonaldehyde	4170-30-3	C4H6O	1
Cumene	98-82-8	C9H12	0.6
Cyanamide	420-04-2	CH2N2	ZR
Cyanogen bromide	506-68-3	CNBr	ZR
Cyanogen chloride	506-77-4	CNCl	ZR
Cyclohexane	110-82-7	C6H12	1.3
Cyclohexanol	108-93-0	C6H12O	2.9
Cyclohexanone	108-94-1	C6H10O	1.1
Cyclohexene	110-83-8	C6H10	0.8
Cyclohexylamine	108-91-8	C6H13N	1
Cyclopentane	287-92-3	C5H10	4
Decane, n-	124-18-5	C10H22	1
Diacetone alcohol	123-42-2	C6H12O2	0.8
Dibenzoyl peroxide	94-36-0	C14H10O4	0.8
Diborane	19287-45-7	B2H6	ZR
Dibromochloromethane	124-48-1	CHBr2Cl	10
Dibromodifluoromethane	75-61-6	CF2Br2	ZR
Dibromoethane 1,2-	106-93-4	C2H4Br2	2
Dibromotetrafluoroethane , 1,2-	124-73-2	C2F4Br2	ZR
Dibutyl hydrogen phosphate	107-66-4	HC8H18 PO4	4
Dichloro-1,1,1-trifluoroethane, 2,2-	306-83-2	C2HCl2F3	ZR

31 • Obtaining a Relative Response Factor

Gas/ VOC	CAS No.	Formula	Relative Response
Dichloro-1,1-difluoroethane, 1,2-	1649-08-7	C ₂ H ₂ Cl ₂ F ₂	ZR
Dichloro-1,2,2-trifluoroethane, 1,2-	354-23-4	C ₂ HCl ₂ F ₃	ZR
Dichloro-1,2-difluoroethane, 1,2-	631-06-1	C ₂ H ₂ Cl ₂ F ₂	ZR
Dichloro-1-fluoroethane, 1,1-	1717-00-6	C ₂ H ₃ Cl ₂ F	ZR
Dichloro-1-fluoroethane, 1,1-	1717-00-6	C ₂ H ₃ Cl ₂ F	ZR
Dichloro-1-fluoroethane, 1,2-	430-57-9	C ₂ H ₃ Cl ₂ F	ZR
Dichloro-1-propene, 2,3-	78-88-6	C ₃ H ₄ Cl ₂	1.4
Dichloro-2,2,-difluoroethane, 1,1-	79-35-6	C ₂ H ₂ Cl ₂ F ₂	ZR
Dichloroacetylene	7572-29-4	C ₂ Cl ₂	5
Dichlorobenzene o-	95-50-1	C ₆ H ₄ Cl ₂	0.5
Dichlorodifluoromethane	75-71-8	CCl ₂ F ₂	ZR
Dichloroethane 1,2-	107-06-2	C ₂ H ₄ Cl ₂	ZR
Dichloroethane, 1,1-	75-34-3	C ₂ H ₄ Cl ₂	ZR
Dichloroethene, 1,1-	75-35-4	C ₂ H ₂ Cl ₂	1
Dichloroethene, cis-1,2-	156-59-2	C ₂ H ₂ Cl ₂	0.8
Dichloroethene, trans-1,2-	540-59-0	C ₂ H ₂ Cl ₂	0.7
Dichloroethylene 1,2-	540-59-0	C ₂ H ₂ Cl ₂	0.8
Dichlorofluoromethane	75-43-4	CHFCl ₂	ZR
Dichloromethane	75-09-2	CH ₂ Cl ₂	39
Dichloropropane, 1,2-	78-87-5	C ₃ H ₆ Cl ₂	ZR
Dichlorotetrafluoroethane, 1,1-	374-07-2	C ₂ Cl ₂ F ₄	ZR
Dichlorotetrafluoroethane, 1,2-	76-14-2	C ₂ Cl ₂ F ₄	ZR
Dicyclopentadiene	77-73-6	C ₁₀ H ₁₂	0.9
Diesel Fuel	68334-30-5		0.8
Diethyl ether	60-29-7	C ₄ H ₁₀ O	0.9
Diethyl maleate	141-05-9	C ₈ H ₁₂ O ₄	2
Diethyl phthalate	84-66-2	C ₁₂ H ₁₄ O ₄	1
Diethyl sulphate	64-67-5	C ₄ H ₁₀ SO ₄	3
Diethyl sulphide	352-93-2	C ₄ H ₁₀ S	0.6
Diethylamine	109-89-7	C ₄ H ₁₁ N	1
Diethylaminoethanol, 2-	100-37-8	C ₆ H ₁₅ ON	2.7
Diethylaminopropylamine, 3-	104-78-9	C ₇ H ₁₈ N ₂	1
Difluoroethane, 1,1-	75-37-6	C ₂ H ₄ F ₂	ZR
Difluoroethane, 1,2-	624-72-6	C ₂ H ₄ F ₂	ZR
Difluoromethane	75-10-5	CH ₂ F ₂	ZR
Dihydrogen selenide	7783 07 5	H ₂ Se	1
Dihydroxybenzene, 1,2	120-80-9	C ₆ H ₆ O ₂	1
Dihydroxybenzene, 1,3	108-46-3	C ₆ H ₆ O ₂	1
Diisobutylene	107-39-1	C ₈ H ₁₆	0.6
Diisopropyl ether	108-20-3	C ₆ H ₁₄ O	0.7
Diisopropylamine	108-18-9	C ₆ H ₁₅ N	0.7
Diketene	674-82-8	C ₄ H ₄ O ₂	2.2
Dimethoxymethane	109-87-5	C ₃ H ₈ O ₂	1.4

Gas/ VOC	CAS No.	Formula	Relative Response
Dimethyl cyclohexane, 1,2-	583-57-3	C ₈ H ₁₆	1.1
Dimethyl disulphide	624-92-0	C ₂ H ₆ S ₂	0.2
Dimethyl ether	115-10-6	C ₂ H ₆ O	1.3
Dimethyl phthalate	131-11-3	C ₁₀ H ₁₀ O ₄	1
Dimethyl sulphate	77-78-1	C ₂ H ₆ O ₄ S	ZR
Dimethyl sulphide	75-18-3	C ₂ H ₆ S	0.5
Dimethylacetamide N,N-	127-19-5	C ₄ H ₉ NO	1.3
Dimethylamine	124-40-3	C ₂ H ₇ N	1.4
Dimethylaminoethanol	108-01-0	C ₄ H ₁₁ NO	1.5
Dimethylaniline, NN-	121-69-7	C ₈ H ₁₁ N	0.6
Dimethylbutyl acetate	108-84-9	C ₈ H ₁₆ O ₂	1.6
Dimethylethylamine, NN-	598-56-1	C ₄ H ₁₁ N	0.8
Dimethylformamide	68-12-2	C ₃ H ₇ NO	0.9
Dimethylheptan-4-one, 2,6-	108-83-8	C ₉ H ₁₈ O	0.8
Dimethylhydrazine, 1,1-	57-14-7	C ₂ H ₈ N ₂	1
Dinitrobenzene, m-	99-65-0	C ₆ H ₄ N ₂ O ₄	3
Dinitrobenzene, o-	528-29-0	C ₆ H ₄ N ₂ O ₄	ZR
Dinitrobenzene, p-	100-25-4	C ₆ H ₄ N ₂ O ₄	5
Dinonyl phthalate	84-76-4	C ₂₆ H ₄₂ O ₄	1
Dioxane 1,2-		C ₄ H ₈ O ₂	1.5
Dioxane 1,4-	123-91-1	C ₄ H ₈ O ₂	1.5
Dipentene	138-86-3	C ₁₀ H ₁₆	0.9
Diphenyl ether	101-84-8	C ₁₂ H ₁₀ O	0.8
Disulphur decafluoride	5714-22-7	S ₂ F ₁₀	ZR
Disulphur dichloride	10025-67-9	S ₂ Cl ₂	3
Di-tert-butyl-p-cresol	2409-55-4	C ₁₁ H ₁₆ O	1
Divinylbenzene	1321-74-0	C ₁₀ H ₁₀	0.4
Dodecanol	112-53-8	C ₁₂ H ₂₆ O	0.9
Enflurane	13838-16-9	C ₄ H ₂ F ₅ ClO	ZR
Epichlorohydrin	106-89-8	C ₃ H ₅ ClO	8
Epoxypropyl isopropyl ether, 2,3-	4016-14-2	C ₆ H ₁₂ O ₂	1.1
Ethane	74-84-0	C ₂ H ₆	ZR
Ethanol	64-17-5	C ₂ H ₆ O	8.7
Ethanolamine	141-43-5	C ₂ H ₇ NO	3
Ethoxy-2-propanol, 1-	1569-02-4	C ₅ H ₁₀ O ₂	2
Ethoxyethanol, 2-	110-80-5	C ₄ H ₁₀ O ₂	29.8
Ethoxyethyl acetate, 2-	111-15-9	C ₆ H ₁₂ O ₃	3
Ethyl (S)-(-)-lactate	97-64-3	C ₅ H ₁₀ O ₃	3
Ethyl acetate	141-78-6	C ₄ H ₈ O ₂	3.6
Ethyl acrylate	140-88-5	C ₅ H ₈ O ₂	2
Ethyl amine	75-04-7	C ₂ H ₇ N	1
Ethyl benzene	100-41-4	C ₈ H ₁₀	0.5
Ethyl butyrate	105-54-4	C ₆ H ₁₂ O ₂	1
Ethyl chloroformate	541-41-3	C ₃ H ₅ O ₂ Cl	80
Ethyl cyanoacrylate	7085-85-0	C ₆ H ₇ O ₂ N	1.5
Ethyl decanoate	110-38-3	C ₁₂ H ₂₄ O ₂	1.8
Ethyl formate	109-94-4	C ₃ H ₆ O ₂	30

Gas/ VOC	CAS No.	Formula	Relative Response
Ethyl hexanoate	123-66-0	C8H16O2	2.6
Ethyl hexanol, 2-	105-76-7	C8H18O	1.5
Ethyl hexyl acrylate, 2-	103-11-7	C11H20O2	1
Ethyl mercaptan	75-08-1	C2H6S	0.7
Ethyl octanoate	106-32-1	C10H20O2	2.3
Ethylene	74-85-1	C2H4	8
Ethylene dinitrate	628-96-6	C2H4O6N2	ZR
Ethylene glycol	107-21-1	C2H6O2	20
Ethylene oxide	75-21-8	C2H4O	15
Ferrocene	102-54-5	C10H10Fe	0.8
Fluorine	7782-41-4	F2	ZR
Fluoroethane	353-33-6	C2H5F	ZR
Fluoromethane	593-53-3	CH3F	ZR
Formaldehyde	50-00-0	CH2O	ZR
Formamide	75-12-7	CH3ON	2
Formic acid	64-18-6	CH2O2	ZR
Furfural	98-01-1	C5H4O2	1.4
Furfuryl alcohol	98-00-0	C5H6O2	2
Gasoline vapors	8006-61-9		1.1
Gasoline vapors	8006-61-9		0.8
Gasoline vapors 92 octane	8006-61-9		0.8
Germane	7782-65-2	GeH4	10
Glutaraldehyde	111-30-8	C5H8O2	0.9
Halothane	151-67-7	CF3CHBrCl	ZR
Helium		He	ZR
Heptan-2-one	110-43-0	C7H14O	0.7
Heptan-3-one	106-35-4	C7H14O	0.8
Heptane n-	142-82-5	C7H16	2.1
Hexachloroethane	67-72-1	C2Cl6	ZR
Hexafluoroethane	76-16-4	C2F6	ZR
Hexamethyldisilazane, 1,1,1,3,3,3-	999-97-3	C6H19NSi2	1
Hexamethyldisiloxane.	107-46-0	C6H18OSi2	0.3
Hexan-2-one	591-78-6	C6H12O	0.8
Hexane n-	110-54-3	C6H14	4.2
Hexene, 1-	592-41-6	C6H12	0.9
Hydrazine	302-01-2	H4N2	3
Hydrazoic acid	7782-79-8	HN3	ZR
Hydrogen	1333-74-0	H2	ZR
Hydrogen bromide	10035-10-6	HBr	ZR
Hydrogen chloride	7647-01-0	HCl	ZR
Hydrogen cyanide	74-90-8	HCN	ZR
Hydrogen fluoride	7664-39-3	HF	ZR
Hydrogen peroxide	7722-84-1	H2O2	4
Hydrogen sulfide	6/4/83	H2S	4

Gas/ VOC	CAS No.	Formula	Relative Response
Hydroquinone	123-31-9	C6H6O2	0.8
Hydroxypropyl acrylate 2-	999-61-1	C6H10O3	1.5
Iminodi(ethylamine) 2,2-	111-40-0	C4H13N3	0.9
Iminodiethanol 2,2'-	111-42-2	C4H11NO2	1.6
Indene	95-13-6	C9H8	0.5
Iodine	7553-56-2	I2	0.2
Iodoform	75-47-8	CHI3	1.5
Iodomethane	74-88-4	CH3I	0.4
Isomyl acetate	123-92-2	C7H14O2	1.6
Isobutane	75-28-5	C4H10	8
Isobutanol	78-83-1	C4H10O	3.5
Isobutyl acetate	110-19-0	C6H12O2	2.3
Isobutyl acrylate	106-63-8	C7H12O2	1.3
Isobutylene	115-11-7	C4H8	1
Isobutyraldehyde	78-84-2	C4H8O	1.2
Isocyanates, all			NV
Isodecanol	25339-17-7	C10H22O	0.9
isoflurane	26675-46-7	C3H2ClF5O	ZR
Isononanol	2452-97-9	C9H20O	1.5
Isooctane	565-75-3	C8H18	1.1
Isooctanol	26952-21-6	C8H18O	1.7
Isopentane	78-78-4	C5H12	6
Isophorone	78-59-1	C9H14O	0.8
Isoprene	78-79-5	C5H8	0.7
Isopropanol	67-63-0	C3H8O	4.4
Isopropyl acetate	108-21-4	C5H10O2	2.2
Isopropyl chloroformate	108-23-6	C4H7O2Cl	1.6
Jet Fuel JP-4			0.8
Jet Fuel JP-5			0.7
Jet Fuel JP-8			0.7
Kerosene	8008-20-6		0.8
Ketene	463-51-4	C2H2O	3
Liquefied petroleum gas	68476-85-7		ZR
Maleic anhydride	108-31-6	C4H2O3	2
Mercaptoacetic acid	68-11-1	C2H4O2S	1
Mercury	7439-97-6	Hg	NV
Mercury alkyls			NV
Mesitylene	108-67-8	C9H12	0.3
Methacrylic acid	79-41-4	C4H6O2	2.3
Methacrylonitrile	126-98-7	C4H5N	5
Methane	74-82-8	CH4	ZR
Methanol	67-56-1	CH4O	200
Methoxyethanol, 2-	109-86-4	C3H8O2	2.7
Methoxyethoxyethanol, 2-	111-77-3	C5H12O3	1.4
Methoxymethylethoxy-2-propanol	34590-94-8	C7H16O3	1.3
Methoxypropan-2-ol	107-98-2	C4H10O2	3

Gas/ VOC	CAS No.	Formula	Relative Response
Methoxypropyl acetate	108-65-6	C6H12O3	1.2
Methyl acetate	79-20-9	C3H6O2	5.2
Methyl acrylate	96-33-3	C4H6O2	3.4
Methyl bromide	74-83-9	CH3Br	1.9
Methyl cyanoacrylate	137-05-3	C5H5O2N	5
Methyl ethyl ketone	78-93-3	C4H8O	0.8
Methyl ethyl ketone peroxides	1338-23-4	C8H18O2	0.8
Methyl formate	107-31-3	C2H4O2	ZR
Methyl isobutyl ketone	108-10-1	C6H12O	0.8
Methyl isocyanate	624-83-9	C2H3NO	ZR
Methyl isothiocyanate	556-61-6	C2H3NS	0.6
Methyl mercaptan	74-93-1	CH4S	0.7
Methyl methacrylate	80-62-6	C5H8O2	1.6
Methyl propyl ketone	107-87-9	C5H10O	0.8
Methyl salicylate	119-36-8	C8H8O3	1.2
Methyl sulphide	75-18-3	C2H6S	0.5
Methyl t-butyl ether	1634-04-4	C5H12O	0.8
Methyl-2-propen-1-ol, 2-	51-42-8	C4H8O	1.1
Methyl-2-pyrrolidinone, N-	872-50-4	C5H9NO	0.9
Methyl-4,6-dinitrophenol, 2-	534-52-1	C7H6N2O5	3
Methyl-5-hepten-2-one, 6-	110-93-0	C8H14O	0.8
Methylamine	74-89-5	CH5N	1.4
Methylbutan-1-ol, 3-	123-51-3	C5H12O	3.4
Methylcyclohexane	108-87-2	C7H14	1.1
Methylcyclohexanol, 4-	589-91-3	C7H14O	2.4
Methylcyclohexanone 2-	583-60-8	C7H12O	1
Methylheptan-3-one, 5-	541-85-5	C8H16O	0.8
Methylhexan-2-one, 5-	110-12-3	C7H14O	0.8
Methylhydrazine	60-34-4	CH6N2	1.3
Methyl-N-2,4, 6-tetranitroaniline, N-	479-45-8	C7H5N5O8	3
Methylpent-3-en-2-one, 4-	141-79-7	C6H10O	0.7
Methylpentan-2-ol, 4-	108-11-2	C6H14O	2.8
Methylpentane-2,4-diol, 2-	107-41-5	C6H14O2	4
Methylpropan-2-ol, 2-	75-65-0	C4H10O	3.5
Methylstyrene	25013-15-4	C9H10	0.5
Mineral oil	8042-47-5		0.8
Mineral spirits	64475-85-0		0.8
Naphthalene	91-20-3	C10H8	0.4
Nitric oxide	10102-43-9	NO	8
Nitroaniline 4-	100-01-6	C6H6N2O2	0.8
Nitrobenzene	98-95-3	C6H5NO2	1.7
Nitroethane	79-24-3	C2H5NO2	ZR
Nitrogen dioxide	10102-44-0	NO2	10
Nitrogen trichloride	10025-85-1	NCI3	1
Nitrogen trifluoride	7783-54-2	NF3	ZR
Nitromethane	75-52-5	CH3NO2	ZR
Nitropropane, 1-	108-03-2	C3H7NO2	ZR

Gas/ VOC	CAS No.	Formula	Relative Response
Nitropropane, 2-	79-46-9	C3H7NO2	ZR
Nitrous oxide	10024-97-2	N2O	ZR
Nonane, n-	111-84-2	C9H20	1.3
Norbornadiene, 2,5-	121-46-0	C7H8	0.6
Octachloronaphthalene	2234-13-1	C10Cl8	1
Octane, n-	111-65-9	C8H18	1.6
Octene, 1-	111-66-0	C8H16	0.7
Oxalic acid	144-62-7	C2H2O4	ZR
Oxalonnitrile	460-19-5	C2N2	ZR
Oxydiethanol 2,2-	111-46-6	C4H10O3	4
Oxygen		O2	ZR
Ozone	10028-15-6	O3	ZR
Paraffin wax, fume	8002-74-2		1
Paraffins, normal	64771-72-8		1
Pentacarbonyl iron	13463-40-6	FeC5O5	1
Pentachloroethane	76-01-7	C2HCl5	ZR
Pentachlorofluoroethane	354-56-3	C2Cl5F	ZR
Pentafluoroethane	354-33-6	C2HF5	ZR
Pentan-2-one	107-87-9	C5H10O	0.8
Pentan-3-one	96-22-0	C5H10O	0.8
Pentandione, 2,4-	123-54-6	C5H8O2	0.8
Pentane, n-	109-66-0	C5H12	7.9
Peracetic acid	79-21-0	C2H4O3	2
Perchloryl fluoride	7616-94-6	ClO3F	ZR
Perfluoropropane	76-19-7	C3F8	ZR
Petroleum ether			0.9
Phenol	108-95-2	C6H6O	1.2
Phenyl propene, 2-	98-83-9	C9H10	0.4
Phenyl-2,3-epoxypropyl ether	122-60-1	C9H10O2	0.8
Phenylenediamine, p-	106-50-3	C6H8N2	0.6
Phosgene	75-44-5	COCl2	ZR
Phosphine	7803-51-2	PH3	2
Picoline, 3-	108-99-6	C6H7N	0.9
Pinene, alpha	80-56-8	C10H16	0.3
Pinene, beta	127-91-3	C10H16	0.3
Piperidine	110-89-4	C5H11N	0.9
Piperylene	504-60-9	C5H8	0.7
Prop-2-yn-1-ol	107-19-7	C3H4O	1.3
Propan-1-ol	71-23-8	C3H8O	4.8
Propane	74-98-6	C3H8	ZR
Propane-1,2-diol, total	57-55-6	C3H8O2	10
Propene	115-07-1	C3H6	1.4
Propionaldehyde	123-38-6	C3H6O	1.7
Propionic acid	79-09-4	C3H6O2	8
Propyl acetate, n-	109-60-4	C5H10O2	2.5
Propylene dinitrate	6423-43-4	C3H6N2O6	ZR

Gas/ VOC	CAS No.	Formula	Relative Response
Propylene oxide	75-56-9	C3H6O	7
Propyleneimine	75-55-8	C3H7N	1.3
Pyridine	110-86-1	C5H5N	0.8
Pyridylamine 2-	504-29-0	C5H6N2	0.8
Silane	7803-62-5	SiH4	ZR
Sodium fluoroacetate	62-74-8	C2H2O2FNa	ZR
Styrene	100-42-5	C8H8	0.4
Sulphur dioxide	9/5/46	SO2	ZR
Sulphur hexafluoride	2551-62-4	SF6	ZR
Sulphur tetrafluoride	7783-60-0	SF4	ZR
Sulphuric acid	7664-93-9	H2SO4	ZR
Sulphuryl fluoride	2699-79-8	SO2F2	ZR
Terphenyls		C18H14	0.6
Terpinolene	586-62-9	C10H16	0.5
Tert-butanol	75-65-0	C4H10O	2.6
Tetrabromoethane, 1,1,2,2-	79-27-6	C2H2Br4	2
Tetracarbonylnickel	13463-39-3	NiC4O4	1
Tetrachloro-1,2-difluoroethane, 1,1,2,2-	76-12-0	C2Cl4F2	ZR
Tetrachloro-1-fluoroethane, 1,1,2,2-	354-14-3	C2HCl4F	ZR
Tetrachloro-2,2-difluoroethane, 1,1,1,2-	76-11-9	C2Cl4F2	ZR
Tetrachloro-2-fluoroethane, 1,1,1,2-	354-11-0	C2HCl4F	ZR
Tetrachloroethane, 1,1,1,2-	630-20-6	C2H2Cl4	ZR
Tetrachloroethane, 1,1,2,2-	79-34-5	C2H2Cl4	ZR
Tetrachloroethylene	127-18-4	C2Cl4	0.7
Tetrachloronaphthalenes, all isomers	20020-02-4	C10H4Cl4	1
Tetraethyl orthosilicate	78-10-4	C8H20O4Si	2
Tetraethyllead	78-00-2	C8H20Pb	ZR
Tetrafluoroethane, 1,1,1,2-	811-97-2	C2H2F4	ZR
Tetrafluoroethane, 1,1,2,2-	359-35-3	C2H2F4	ZR
Tetrafluoroethylene	116-14-3	C2F4	1
Tetrafluoromethane	75-73-0	CF4	ZR
Tetrahydrofuran	109-99-9	C4H8O	1.6
Tetramethyl orthosilicate	681-84-5	C4H12O4Si	ZR
Tetramethyl succinonitrile	3333-52-6	C8H12N2	1
Therminol			1
Thionyl chloride	9/7/19	SOCl2	ZR
Toluene	108-88-3	C7H8	0.5
Toluene-2,4-diisocyanate	584-84-9	C9H6N2O2	1.6
Toluenesulphonyl chloride, p-	98-59-9	C7H7SO2Cl	3
Toluidine, o-	95-53-4	C7H9N	0.5
Tributyl phosphate	126-73-8	C12H27O4P	5

Gas/ VOC	CAS No.	Formula	Relative Response
Tributylamine	102-82-9	C ₁₂ H ₂₇ N	1
Trichloro-1,1-difluoroethane, 1,2,2-	354-21-2	C ₂ HCl ₃ F ₂	ZR
Trichloro-1,2-difluoroethane, 1,1,2-	354-15-4	C ₂ HCl ₃ F ₂	ZR
Trichloro-2,2-difluoroethane, 1,1,1-	354-12-1	C ₂ HCl ₃ F ₂	ZR
Trichloro-2-fluoroethane, 1,1,2-	359-28-4	C ₂ H ₂ Cl ₃ F	ZR
Trichlorobenzene 1,2,4-	120-82-1	C ₆ H ₃ Cl ₃	0.6
Trichloroethane, 1,1,1-	71-55-6	C ₂ H ₃ Cl ₃	ZR
Trichloroethane, 1,1,2-	79-00-5	C ₂ H ₃ Cl ₃	ZR
Trichloroethylene	79-01-6	C ₂ HCl ₃	0.7
Trichlorofluoromethane	75-69-4	CCl ₃ F	ZR
Trichloronitromethane	76-06-2	CCl ₃ NO ₂	ZR
Trichlorophenoxyacetic acid, 2,4,5-	93-76-5	C ₈ H ₅ O ₃ Cl ₃	1
Trichloropropane 1,2,3-	96-18-4	C ₃ H ₅ Cl ₃	ZR
Trichlorotrifluoroethane, 1,1,1-	354-58-5	C ₂ Cl ₃ F ₃	ZR
Trichlorotrifluoroethane, 1,1,2-	76-13-1	C ₂ Cl ₃ F ₃	ZR
Triethylamine	121-44-8	C ₆ H ₁₅ N	0.9
Trifluoroethane, 1,1,1-	420-46-2	C ₂ H ₃ F ₃	ZR
Trifluoroethane, 1,1,2-	430-66-0	C ₂ H ₃ F ₃	ZR
Trifluoroethanol, 2,2,2-	75-89-8	C ₂ H ₃ F ₃ O	ZR
Trifluoromethane	75-46-7	CHF ₃	ZR
Trimethylamine	53-50-3	C ₃ H ₉ N	0.5
Trimethylbenzene mixtures		C ₉ H ₁₂	0.3
Trimethylbenzene, 1,3,5-	108-67-8	C ₉ H ₁₂	0.3
Trinitrotoluene 2,4,6-	118-96-7	C ₇ H ₅ N ₃ O ₆	ZR
Turpentine	8006-64-2	C ₁₀ H ₁₆	0.6
TVOC			1
Undecane, n-	1120-21-4	C ₁₁ H ₂₄	0.9
Vinyl acetate	108-05-2	C ₄ H ₆ O ₂	1.1
Vinyl bromide	593-60-2	C ₂ H ₃ Br	1
Vinyl chloride	75-01-4	C ₂ H ₃ Cl	2.1
Vinyl-2-pyrrolidinone, 1-	88-12-0	C ₆ H ₉ NO	0.9
Xylene mixed isomers	1330-20-7	C ₈ H ₁₀	0.4
Xylene, m-	108-38-3	C ₈ H ₁₀	0.4
Xylene, o-	95-47-6	C ₈ H ₁₀	0.6
Xylene, p-	106-42-3	C ₈ H ₁₀	0.6
Xylidine, all	1300-73-8	C ₈ H ₁₁ N	0.7

Spare Parts List

Table 5: Spare Parts List

Part Number	Description
47-5084RK	USB/IrDA adapter module (without USB cable)
47-5084RK-01	USB/IrDA adapter assembly (with module and USB cable)
47-5085RK	Cable, USB A to USB mini, 6 feet, for USB/IrDA adapter module
71-0154RK	EAGLE 2 Operator's Manual
71-0191RK	EAGLE 2 Maintenance Data Loader Program Operator's Manual (this document)
71-8003RK	Eagle 2 Product CD, Includes the Eagle 2 Data Logger Management Program, the Eagle 2 Maintenance Program, and Operator's Manuals for each