



**Tektronix RSA300, RSA500, and RSA600 Series  
USB Spectrum Analyzers  
Self-Guided Demo**



071333002







**Tektronix RSA300, RSA500, and RSA600 Series  
USB Spectrum Analyzers  
Self-Guided Demo**

[www.tek.com](http://www.tek.com)  
071333002

Copyright © Tektronix. All rights reserved. Licensed software products are owned by Tektronix or its subsidiaries or suppliers, and are protected by national copyright laws and international treaty provisions. Tektronix products are covered by U.S. and foreign patents, issued and pending. Information in this publication supersedes that in all previously published material. Specifications and price change privileges reserved.

TEKTRONIX and TEK are registered trademarks of Tektronix, Inc.

## **Contacting Tektronix**

Tektronix, Inc.  
14150 SW Karl Braun Drive  
P.O. Box 500  
Beaverton, OR 97077  
USA

For product information, sales, service, and technical support:

- In North America, call 1-800-833-9200.
- Worldwide, visit [www.tek.com](http://www.tek.com) to find contacts in your area.

---

# Table of Contents

## Introduction

Demo guide overview .....	5
Over-the-air demo .....	5
EMI spurious search .....	5
Fundamental operations of spectrum analyzers .....	6
Real-time DPX .....	6
Modulation .....	7
Tracking generator .....	7
Setup .....	8
Installing SignalVu-PC .....	11
Activating SignalVu-PC .....	12
Setting up the connection .....	13

## Demo instructions

Demo 1: FM listening (Demo board not needed) .....	17
Demo 2: ISM band DPX (Demo board not needed) .....	22
Demo 3: EMI spurious (Demo board not needed) .....	33
Demo 4: Basic spectrum measurements with markers .....	40
Demo 5: Power measurements with markers .....	49
Demo 6: Traces and detectors .....	52
Demo 7: Save and recall .....	59
Demo 8: DPX and transient capture .....	63
Demo 9: Transient capture - Mask test and act on violation .....	70
Demo 10: Analog modulation analysis .....	76
Demo 11: Digital modulation analysis .....	84
Demo 12: Transmission gain measurement (tracking generator needed, available on the RSA500/600 series) .....	90
.....	93



# Introduction





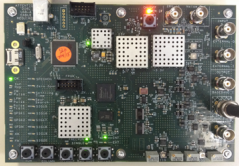

With this guide, you will explore what you can do with the RSA306, RSA306B, RSA503A, RSA507A, RSA603A, and RSA607A USB spectrum analyzers. Applications range from simple frequency / amplitude measurements of RF signals to real-time and modulation analysis that provide you with a complete system view of your device under test.





## Check list for the demo

Before beginning the demo, please be sure you have the following items:

Item	Illustration
RSA USB spectrum analyzer	 The illustration shows two pieces of hardware: a black USB spectrum analyzer module with a silver metal shield and a black rectangular power supply unit with a silver front panel.
RTSA demo board	 The illustration shows a green printed circuit board (PCB) populated with various electronic components, including integrated circuits, capacitors, and connectors. Several LEDs are illuminated, and there are multiple ports along the edges of the board.
USB Y-cable (to power the board)	 The illustration shows a USB Y-cable, which consists of a single USB-A connector on one end and two USB-B connectors on the other, used for power distribution to the demo board.



Item	Illustration
N-BNC adapter	 A silver metal N-BNC adapter with a threaded N-type connector on one end and a BNC connector on the other.
Whip antenna	 A black whip antenna with a BNC connector at one end and a long, thin, flexible whip element.
BNC cable	 A black BNC cable with BNC connectors at both ends, shown in a loop.
USB 3.0 cable	 Two blue USB 3.0 cables with standard USB-A connectors at both ends.

Item	Illustration
N-N Cable (2) (Tracking Generator)	 A black coaxial cable with two N-type connectors, one on each end, coiled into a loose loop.
10 dB Type-N attenuator (Tracking Generator)	 A cylindrical, silver-colored metal component with a threaded N-type connector on one end and a smooth N-type connector on the other.
Bandpass Filter, 1500 to 1620 MHz (Tracking Generator)	 A cylindrical, silver-colored metal component with a threaded N-type connector on one end and a smooth N-type connector on the other. The smooth connector has a red ring around its base.
N-N Male Adapter (Tracking Generator)	 A short, cylindrical, silver-colored metal component with a threaded N-type connector on one end and a smooth N-type connector on the other.

## Demo guide overview

### Over-the-air demo

The Tektronix RSA300 Series, RSA500A Series, and RSA600A Series USB spectrum analyzers can perform off-air applications. This demo shows how to use the analyzer for these applications. Using the whip antenna provided with the analyzer demonstration kit, you can demodulate and listen to the signals from the local FM broadcasting station, see the realtime spectrum of the signals in the ISM band created by your smart phone, and use the analyzer in interference-hunting.

- Demo 1: FM listening
- Demo 2: ISM band DPX

### EMI spurious search

From the first wireless transmissions, electromagnetic interference (EMI) has been a concern for design engineers. General-purpose spectrum analyzers that contain appropriate filters and detectors are often employed in diagnostics and pre-compliance, as they are fast measurement tools that often are already used in the design process and do not require additional capital expense.

- Demo 3: EMI spurious

### **Fundamental operations of spectrum analyzers**

The Tektronix RSA USB Signal Analyzers have the ability to perform basic spectrum measurements that most Spectrum Analyzer users are already accustomed to. The goal of these demonstrations is to show how these instruments perform these basic spectrum analyzer capabilities.

- Demo 4: Basic spectrum measurements with markers
- Demo 5: Power measurements with markers
- Demo 6: Traces and detectors
- Demo 7: Save and recall

### **Real-time DPX**

Two of the most challenging types of signals to identify and capture are low-level signals close to your signal frequency and rarely-occurring transients. Sometimes the interference is so infrequent that you can't detect it at all. You suspect it is there because of seemingly-random errors. DPX Spectrum instantly demystifies these situations by displaying a clear image of the offending signals. Its capture probability is 100% for transients as short as 100  $\mu$ sec.

- Demo 8: DPX and transient capture
- Demo 9: Transient capture: Mask test and act on violation

## Modulation

Digital modulation is used in virtually all modern communication systems. These systems have penetrated every aspect of our lives at a rapid pace. The growth has put increased stress on the ability to quickly and efficiently analyze a wide variety of digital modulation schemes. In some cases, general modulation schemes have been included in complex standards with rigorous specifications involving manual test procedures according to these standards that require lengthy test setups with skilled engineers. Analog modulation is the most fundamental modulation method, and is frequently used to demonstrate principles in education labs.

- Demo 10: Analog modulation analysis
- Demo 11: Digital modulation analysis

## Tracking generator

The tracking generator in the RSA500A Series and RSA600A Series analyzers enables some basic network measurements to be made, thereby providing additional capability beyond basic spectrum analysis. The internal bridge plus a vector calibration routine enables the instrument to make vector-calibrated measurements of return loss, VSWR, cable attenuation and distance-to-fault (DTF).

- Demo 12: Transmission gain measurement

## Setup

As with any test, one of the first steps is to connect the instrument to the device under test. For the initial exploration, a demo board has been provided to output signals needed for the demo. After you've completed the demo and have gained an understanding of how the USB RSA operates, connect to your own system and see how the analyzer can help in your day-to-day work.

### 1. Install SignalVu-PC

- Install the SignalVu-PC software onto your PC. You can download the software from [www.tektronix.com/downloads](http://www.tektronix.com/downloads), or it is available on the flash drive that is provided with the RSA306.

### 2. Set up the RSA

- Power the RSA by connecting the USB 3.0 cable to the USB 3.0 port of your PC.
- Install the N-BNC adaptor on the RSA.

### 3. Setup the demo board

- Connect one end of the USB Y-Cable to the demo board.
- Connect the other end of the USB Y-Cable to 2 USB ports either on your PC or a separate USB power supply.

#### 4. Connect the RSA to the demo board

- Connect one end of the BNC cable to the RF port of the RSA.
- Connect the other end of the BNC cable to the RF port of the board.

**\* Please go to Demo 12 for the setup of the tracking generator**

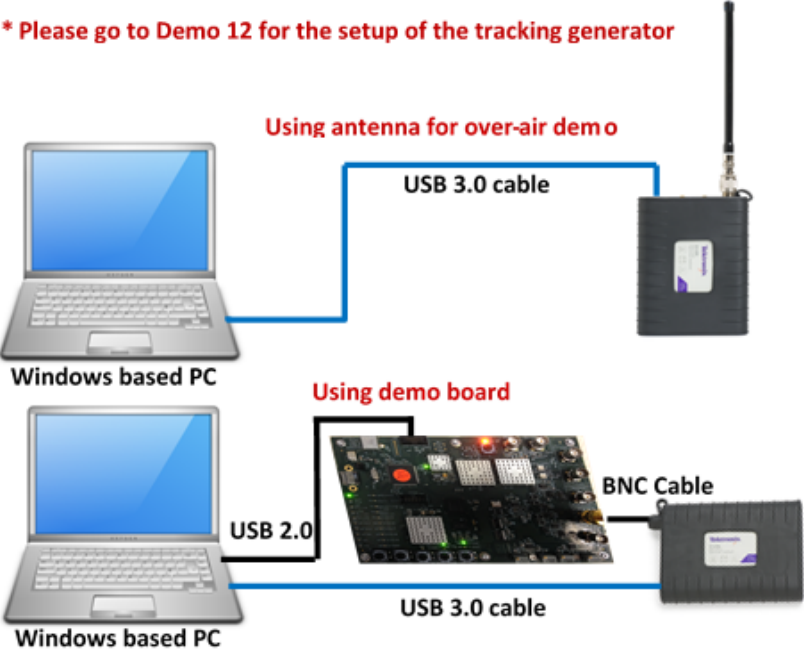



## Installing SignalVu-PC

SignalVu-PC can be downloaded from the Tektronix.com or included in the USB drive in the box.

1. Use Windows Explorer to navigate to the folder you extracted from the archive.
2. Double-click Setup.exe. Follow the on-screen instructions to install the software.
3. When installation is almost complete, a dialog box will appear to let you choose if you want to install TekVISA. TekVISA is optimized for SignalVu-PC, especially for instrument searching, and is the recommended VISA application. You may also use another VISA application, such as NIVISA. To bypass TekVISA installation, uncheck the box.

---

**NOTE.** *TekVISA is not required to run SignalVu-PC with Tektronix USB based spectrum analyzers.*

---

## Activating SignalVu-PC

SignalVu-PC SVE is free to use, so no activation is needed. To activate the other options in SignalVu-PC, do the following:

1. Launch SignalVu-PC. A window will be displayed stating that no license was found.
2. In the dialog, select *I have a key--activate now*.
3. In the Enter Activation Key text box, enter the activation key for SignalVu-PC.
4. Click OK in the License Activation window. SignalVu-PC will contact the license server and install a license file provided by the license server.

## Setting up the connection

1. Double click the **SignalVu-PC** icon on the Desktop of PC to start the application. Please wait for the **automatic connection** process to complete before using the software.



If the SignalVu-PC application is already connected to another instrument (either USB or network), an automated connection will not take place. In this situation, you have to do the following:

Select **Search for Instruments**. You should see the USB connected RSA in the instrument list.

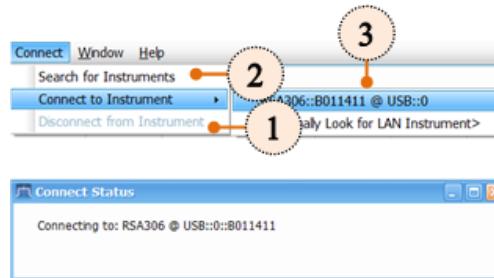

1. Select **Disconnect from Instrument** to end the existing connection.
2. Select **Search for Instruments**. You should see the USB connected RSA in the instrument list.
3. Select the instrument.

A Connect Status dialog box will appear to confirm the instrument is connected and SignalVu-PC can receive live data from the instrument.



A Connect Status dialog box will appear to confirm the instrument is connected and SignalVu-PC can receive live data from the instrument.

**TIP. Connect**

*You can quickly verify connection status by looking at the connection indicator square on the menu bar. It is green  when an instrument is connected. It is red  when it is not. You can also view the name of the instrument that is connected by hovering the mouse indicator over the .*

---



# Demo instructions

## Demo 1: FM listening (Demo board not needed)

The RSA300 Series, RSA500A Series, and RSA600A Series USB Signal Analyzers can demodulate audio signals, which can help you to identify unknown radio signals. You access the Audio Demod tab from the Settings control panel of the DPX Spectrum plot display. This Demo shows how to use the RSA to demodulate the local FM radio signals and listen to the programming.

### Instructions for the antenna

1. Connect the provided whip antenna to the RF input of the RSA.



### Instructions for the RSA

1. Click the **Presets** button.
2. In the DPX display, set the CF to 97.75 MHz and the Span to 20.5 MHz.
3. Set the RefLev to -30 dBm.

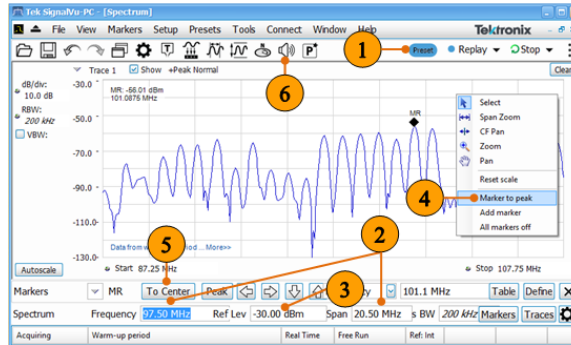

### **TIP. FM broadcasting**

Throughout the world, the FM broadcast band falls within the VHF part of the radio spectrum. Usually the FM band starts from 87.5 MHz to 108.0 MHz. (The frequency modulation radio broadcast band in Japan is 76-90 MHz.)

4. Right click the screen and then click Marker to peak.



5. Click **To Center** in the bottom marker setting area. This sets the center frequency of the analyzer to the center of the signal.
6. Click the **Audio Demod** settings.



---

***TIP. Demodulation frequency***

*The audio listening feature in RSA uses the center frequency of the measurement as the frequency to demodulate the AM/FM broadcasting signals. You can also input the center frequency directly if you know the frequency of the radio station you want to listen to.*

---

7. Select FM – 200 kHz as the demodulation.



---

**TIP. Audio on DPX**

*Audio Demodulation is also available when DPX display is running, but the sound quality may be degraded depending on the processor of the host PC.*

---

8. Click **Run** to start listening to the FM radio signal.
9. Adjust the **Audio Gain** setting so you can hear the demodulated signal. The sound level is also affected by the setting of the Windows volume control.
10. Click the **Browse...** button to select the location you want to save the steam file.
11. Enable the **Activate** button to start saving the audio, and disable the button when you want to stop saving. The saved audio format is .wav, which can be played by Windows media player in your PC.

The screenshot below shows the RSA is tuned to 91.5 MHz center frequency to listen the local FM broadcasting. Drag the marker to other spectrum peaks, center the peaks, and listen to the programming at other channels.



## Demo 2: ISM band DPX (Demo board not needed)

The real time streaming of the RSA combined with the DPX processing of the SignalVu-PC software is designed to address the measurement challenges associated with dynamic RF signals such as the bursted packet transmissions of WLAN and Bluetooth. Combo devices that use both Bluetooth and 802.11b/g/n WLAN networks have a unique set of RF interference problems because they share the same 2.4 GHz Industrial/Scientific/Medical (ISM) frequency band. In this example, we will explore this real-world problem using a whip antenna. The demonstration relies on WLAN and Bluetooth signals from a tablet, phone or PC that you can control on or off.

### Instructions for the antenna

1. Keep the whip antenna attached to the RF input on the RSA as in the last example.



### Instructions for the RSA

1. Click the **Preset** button.
2. Click the Select Displays icon

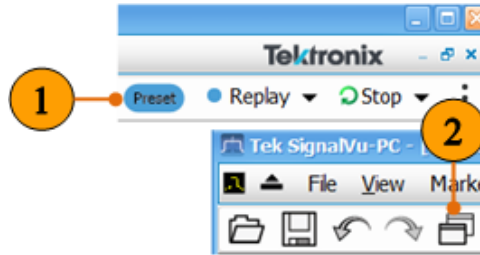

3. In General Signal Viewing, select DPX from the Available displays box.
4. Click the **Add** button. This will add the DPX icon to the Selected Displays box (and remove it from the Available displays box).
5. Select the **Spectrum** display.
6. Click **Remove**.
7. Click the **OK** button.





**TIP. Internal preamp**

In the RSA500A/600A, users have access to turn the internal preamplifier on and off. You can click **Amplitude control panel**, and under the **Internal Settings** tab, select the **Internal Preamp**. This will improve the sensitivity of the measurements.

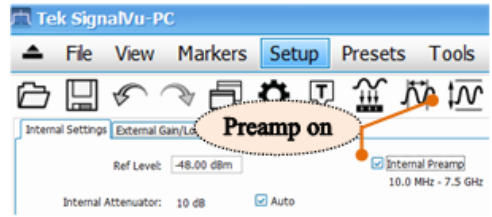

**TIP. 2.4 GHz WLAN channels**

There are 14 channels designated in the 2.4 GHz range (2400–2483.5 MHz) spaced 5 MHz apart. Channels 1 (2412 MHz), 6 (2437 MHz), and 11 (2462 MHz) are the most common channels to choose, and most routers will use one of them as the default channel.

8. In the DPX display, set the **CF** to **2412 MHz** or to the **center frequency of one of the WLAN channels**. See the Tip above. Set the **Span** to **40 MHz**.
9. Select the **Split** view.
10. Set the **RefLev** to **-40 dBm**.
11. Click the **Settings** button.
12. Under the **Bitmap Scale** tab, set the **Max** scale to **3%** for the DPX Spectrum Display.

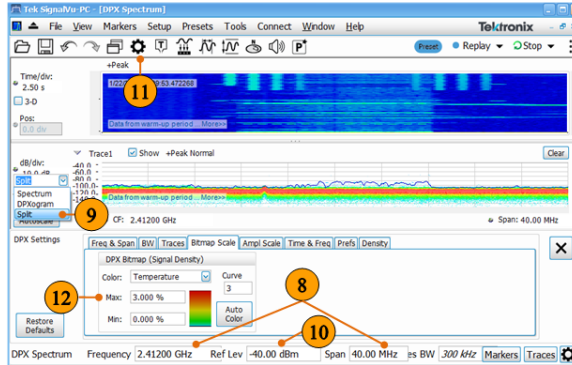



- 13. Under the **Ampl Scale** tab, set the **Max** color scale to **-40 dBm** for the DPXogram Display.
- 14. In the Traces tab, set the **Dot Persistence** to **Infinite**.

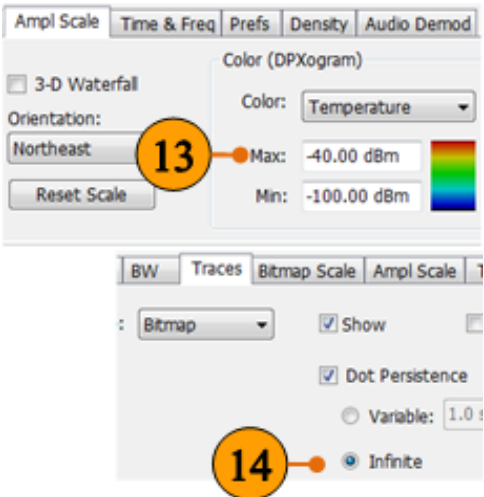



---

**TIP. DPX persistence**

*You can set the Dot Persistence to be Variable or Infinite.*

- *In variable persistence mode, you specify a decay period that limits how long a point will be displayed.*
- *In infinite persistence mode, once a point in the display has been written to, it will remain visible indefinitely.*

*We start with infinite persistence because it ensures that all transients are kept on screen.*

---

- 15. Turn the WLAN function Off, then On in your smart phone/tablet/PC while monitoring with the setup above.

Check the DPX display to see if you can see the spectrum of the WLAN signals. If no signal, you can change the center frequency of the RSA to other channels.

- 16. Turn the Bluetooth function Off, then On in your smart phone/tablet/PC while monitoring with the setup above.



On your smart phone, tablet, or PC



---

**TIP. Wi-Fi test mode**

*To better observe the WLAN activities in the DPX display, you can cause both uplink and downlink activity on your device by navigating to an “internet speed testing” webpage to test both the uploading and downloading speed, and monitor the DPX display of the RSA at the same time.*

---

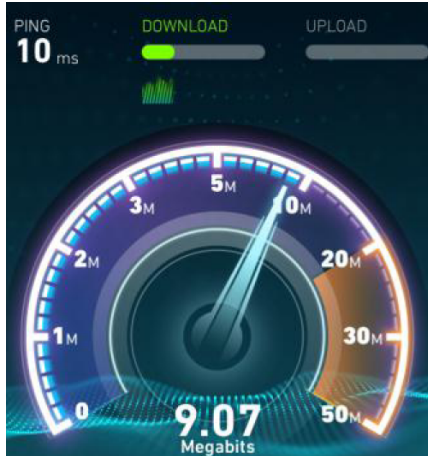

17. Click **Stop** to stop the acquisitions when you have a pattern on the spectrogram you would like to examine.
18. Right click the display, and click **Add markers** twice to add two markers. Then you can measure the distance between hops in frequency and time using the markers on the spectrogram.

The following screen shot shows the real time display in the RSA. You can see a typical WLAN interchange between a nearby smart phone/tablet/PC and a more-distant network access point (AP). The smart phone/tablet/PC signal is nearly 30 dB stronger than the AP's signal because it is closer to the measurement antenna. At the same screen, you can also see the Bluetooth signals, and even the measurements of the time and frequency intervals between those hop signals.

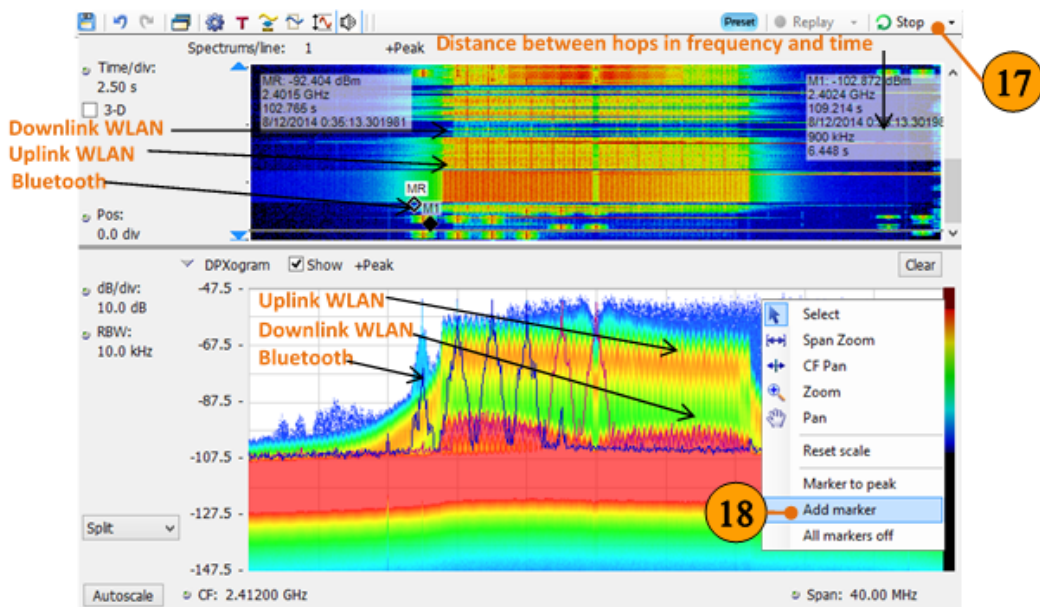

### Demo 3: EMI spurious (Demo board not needed)

The spurious measurement in the RSA is set up to change limits vs. frequency, and antenna correction factors can be applied. Violations above the user-set limits are shown in red on the table. This example shows how to use the spurious display in SignalVu-PC and the RSA to perform EMI pre-compliance and diagnostics.

#### Instructions for the antenna

1. Connect the whip antenna provided in the box into the RF input of the RSA.



### Instructions for the RSA

1. Click **Preset**.
2. Click the Select Displays icon.

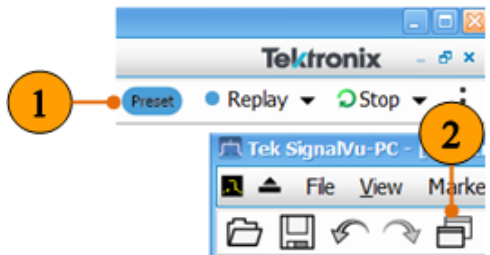



3. In **RF Measurements**, select Spurious from the Available displays box.
4. Click **Add** to add the application to the Selected Displays list.
5. Select the Spectrum icon in the Selected Displays list.
6. Click **Remove** to clear the icon from the list.
7. Click **OK**.
8. Click the Settings icon.

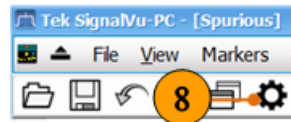

9. In the **Scale** tab, select the **Log** scale to reset the display to show the frequency axis in a logarithmic scale.

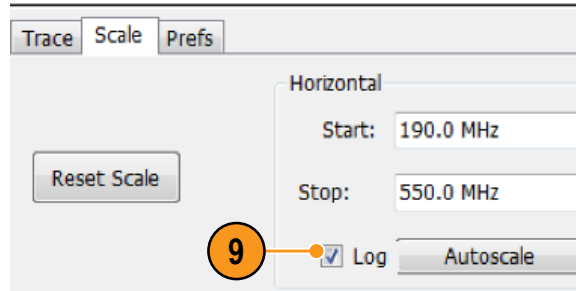

Demo9-Step9



### **TIP. Loss correction**

The *External Gain/Loss Correction* tab under the amplitude control panel () allows you to apply a correction to a signal to compensate for the use of external equipment, such as an amplifier or attenuator. External loss tables can be used to apply a frequency dependent gain/loss correction to the signal.

---

- 10. Under the **Ranges and Limits** tab, click **Load...** to select the appropriate limit line and measurement condition.
- 11. Select **FCC Part 15, Rad, Class A (10m).csv** for this example.
- 12. A larger new resized window of the range and limit table can be displayed by clicking **Expand**.

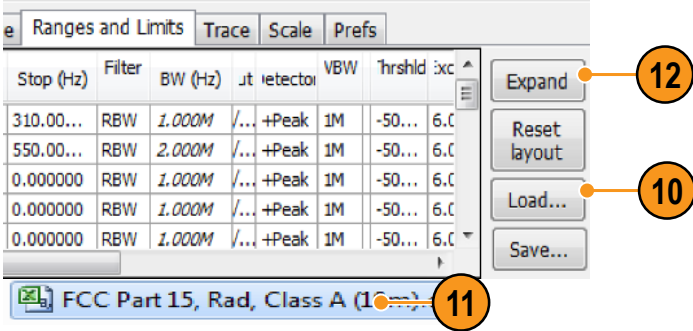

Demo9-Steps10-12

You can edit the start and stop range, filter shape, RBW, VBW, detector, threshold and excursion, and limit line.

Ranges and Limits Table

	On	Start (Hz)	Stop (Hz)	Filter Shape	BW (Hz)	Auto	Detector	VBW (Hz)	VBW On	Threshld (dBm)	Excursn	Mask	Abs Start (dBm)	Abs Stop (dBm)	Abs Same	Rel Start (dB)	Rel Stop (dB)	Rel Same
▶ A	<input checked="" type="checkbox"/>	30.000000M	88.000000M	CISPR	120.000k	<input checked="" type="checkbox"/>	CISPR ...	1k		-87.99	6.0	Abs	-67.99	-67.99		-30.000	-30.0...	
B	<input checked="" type="checkbox"/>	88.000000M	216.00000...	CISPR	120.000k	<input checked="" type="checkbox"/>	CISPR ...	9k		-83.49	6.0	Abs	-63.49	-63.49		-30.000	-30.0...	
C	<input checked="" type="checkbox"/>	216.00000...	960.00000...	CISPR	120.000k	<input checked="" type="checkbox"/>	CISPR ...	3k		-80.49	6.0	Abs	-60.49	-60.49		-30.000	-30.0...	
D	<input checked="" type="checkbox"/>	960.00000...	6.000000G	CISPR	1.000M	<input checked="" type="checkbox"/>	CISPR ...	30k		-77.49	6.0	Abs	-57.49	-57.49		-30.000	-30.0...	
E	<input type="checkbox"/>	0.000000	0.000000	RBW	1.000M	<input checked="" type="checkbox"/>	+Peak	1M		-50.00	6.0	Abs	-50.00	-50.00		-30.000	-30.0...	
F	<input type="checkbox"/>	0.000000	0.000000	RBW	1.000M	<input checked="" type="checkbox"/>	+Peak	1M		-50.00	6.0	Abs	-50.00	-50.00		-30.000	-30.0...	
G	<input type="checkbox"/>	0.000000	0.000000	RBW	1.000M	<input checked="" type="checkbox"/>	+Peak	1M		-50.00	6.0	Abs	-50.00	-50.00		-30.000	-30.0...	
H	<input type="checkbox"/>	0.000000	0.000000	RBW	1.000M	<input checked="" type="checkbox"/>	+Peak	1M		-50.00	6.0	Abs	-50.00	-50.00		-30.000	-30.0...	
I	<input type="checkbox"/>	0.000000	0.000000	RBW	1.000M	<input checked="" type="checkbox"/>	+Peak	1M		-50.00	6.0	Abs	-50.00	-50.00		-30.000	-30.0...	
J	<input type="checkbox"/>	0.000000	0.000000	RBW	1.000M	<input checked="" type="checkbox"/>	+Peak	1M		-50.00	6.0	Abs	-50.00	-50.00		-30.000	-30.0...	
K	<input type="checkbox"/>	0.000000	0.000000	RBW	1.000M	<input checked="" type="checkbox"/>	+Peak	1M		-50.00	6.0	Abs	-50.00	-50.00		-30.000	-30.0...	

After loading the spurious table, your display should look similar to the picture below. The green bar is the loaded limit line as standards suggest.

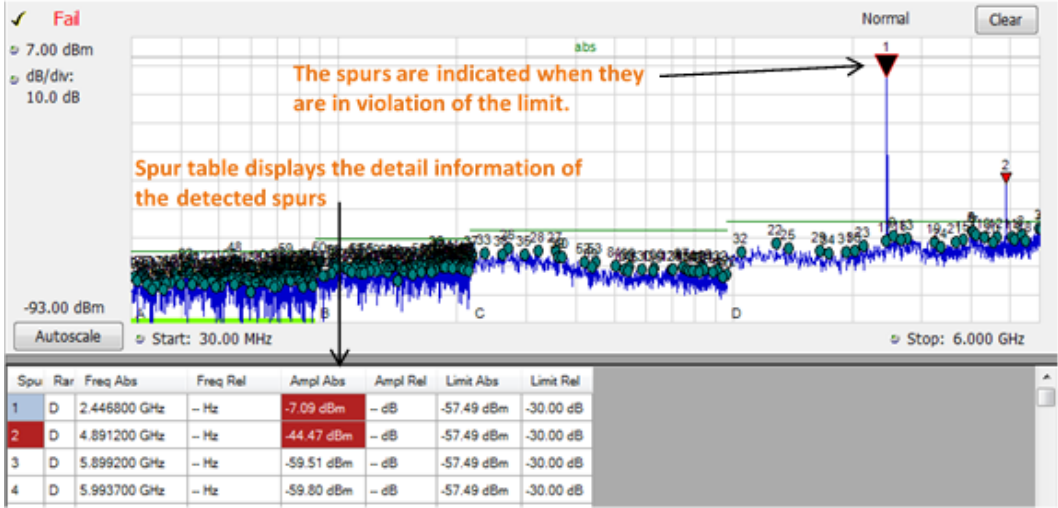

## Demo 4: Basic spectrum measurements with markers

When using a spectrum analyzer, one of the first settings is that of the frequency. In this demonstration, we will use markers to locate the CW signal generated from the demo board, and set the appropriate frequency for the measurement.

### Instructions for the demo board

1. Press the On button to turn on the demo board.
2. Set the reference to INT (internal reference).
3. Set the run mode to FREE RUN.
4. Click the ROW and COLUMN buttons to select CW as the signal to generate.

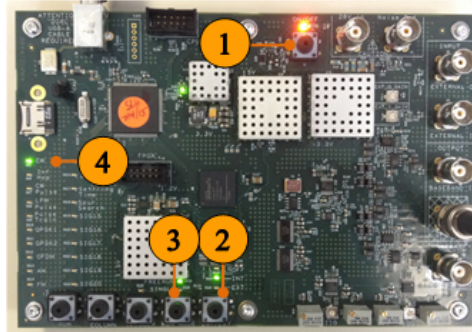

### Instructions for the RSA

1. Click the **Presets** button.
2. Click the Settings icon.
3. Click **Max Span** to set the Span to the maximum value.
4. Right click the screen, and select **Marker to peak**.
5. Click **To Center** in the bottom marker setting area. This sets the center frequency of the analyzer to the center of the signal.

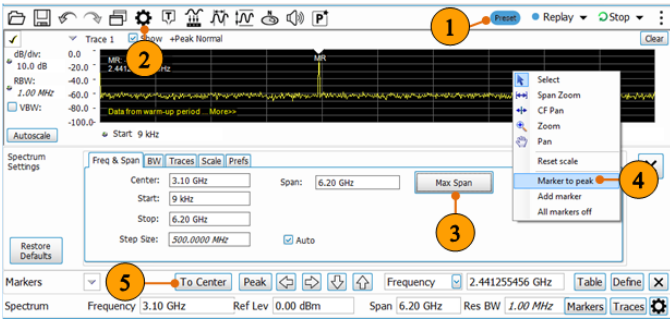



---

***TIP. Right Click on Tablet***

*Touch the screen where you want to right-click, hold until a complete square appears, and then lift your finger. The shortcut menu appears after you lift your finger.*

---







**TIP. For Tablet users**

Activate the on-screen numeric entry of values and Up/Down controls by selecting View: Numeric Keypad. When the Numeric Keypad view is activated, up/down arrows and a numeric keypad icon will pop up whenever a field requiring input is selected. Selecting the 'calculator' numeric keypad icon will pop up a numeric entry box.

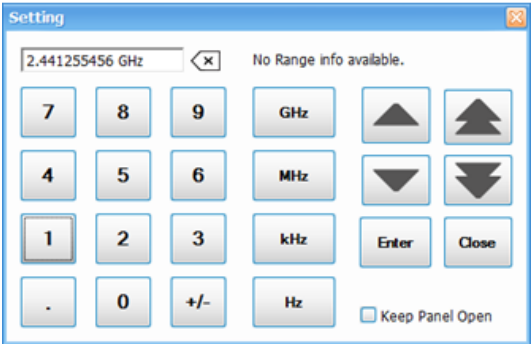
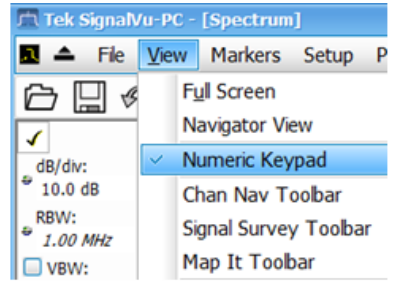

6. Set the Span to 40 MHz.
7. Click **Peak** to locate the center frequency of the signal more precisely.
8. Click **To Center** again.
9. Right click the screen and select **Add marker**.

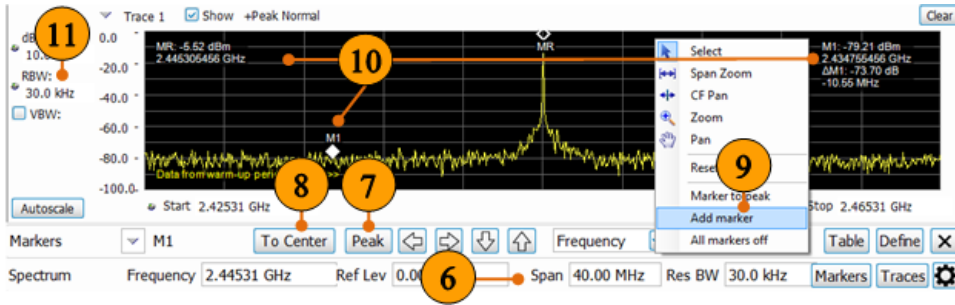

10. Drag the new marker M1 to the noise level. Notice that readouts show:
  - The amplitude and the frequency of the reference marker (MR).
  - The amplitude and the frequency of the selected marker (M1).
  - The difference ( $\Delta M1$ ) between the selected marker position and the position of the reference marker.
  
11. Set the RBW to 30 kHz. The RBW setting is located at the left side of the spectrum display.



---

**TIP. RBW**

*The resolution bandwidth (RBW) determines the fast Fourier transform (FFT) bin size, or the smallest frequency that can be resolved. Smaller RBW improves the selectivity, but degrades the sweep speed and the trace update rate.*

---



---

### **TIP. Undo, Redo, and Recall**

You can undo anything you do with this  control.

*If you are having trouble with this step, recall the setting `Demo1_Cw.tiq` from the directory `C:/SignalVu-PC Files/Example Files`. This will give you the correct amplitude, frequency, span and marker settings automatically. This file also contains data collected from a previous test and creates a trace on screen of the result.*

---

- 12. Select **Options** from the Tools menu.
- 13. Under the **Prefs** tab, set the **Color Scheme** to **Blizzard**.

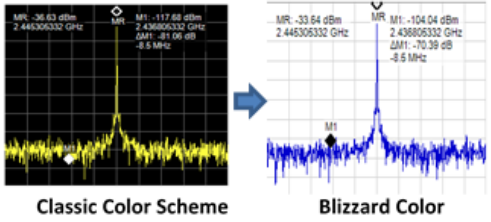
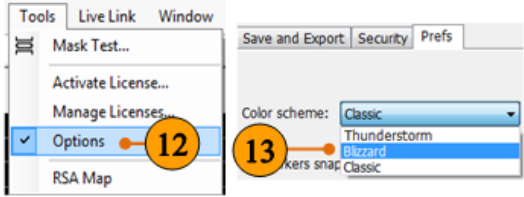
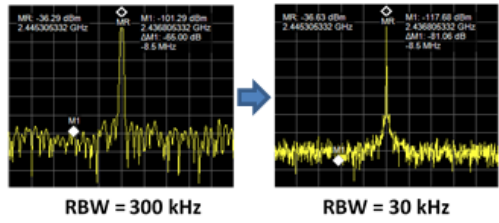



---

**TIP. Ink Saver Mode**

*You can print screen images with a white background. Selecting the scheme color to Blizzard makes the background color changes from black to white in the graphs.*

---

## Demo 5: Power measurements with markers

Integrated power between markers is an easy way to measure the power of a modulated signal without setting up a channel power measurement. SignalVu-PC performs integrated power and power density measurements using power markers. When measuring signal density, the signal is assumed to be noise like, and measurements are corrected to a 1 Hz bandwidth. Selecting power measurement markers automatically switches the trace detector to Ave (RMS) for accurate results. Integrated power between markers is an easy way to measure the power of a modulated signal without setting up a dedicated channel power measurement.

### Instructions for the demo board

1. Keep the same setting as the last demo. Use the ROW and COLUMN buttons to change the signal type from CW to OFDM.



### Instructions for the RSA

1. Keep the same setting as the last demo, or recall the setting Demo1\_Cw.  $\tau i q$ . Click the **Stop** button to pause the measurement.
2. Drag the marker reference (MR) to the left side, and the marker 1 (M1) to the right side, of the OFDM spectrum.
3. Click the **Define** button in the Markers toolbar.
4. Within the Marker Properties tab, select **Power** from the Readouts dropdown menu.



---

**TIP.** You can measure phase noise by setting the delta marker to dBc/Hz.

Advanced channel power measurement and ACLR (adjacent channel leakage power ratio) measurement can be done in “Chan Pwr and ACPR” display.



Chan Pwr  
and ACPR

---



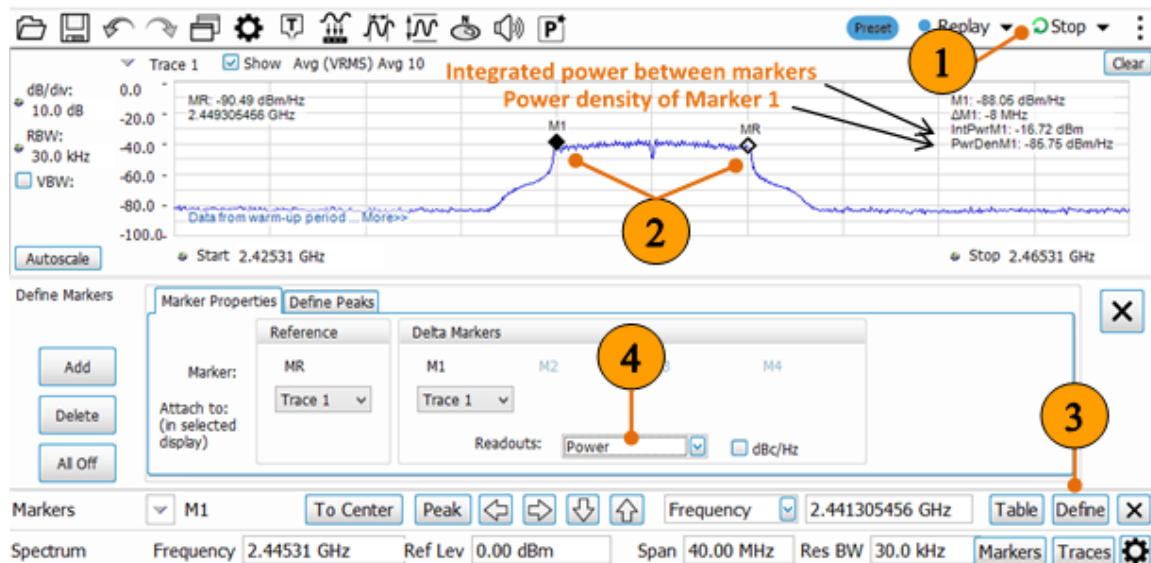

## Demo 6: Traces and detectors

This demo familiarizes you with the trace detection and function controls available in SignalVu-PC used with the RSA.

### Instructions for the demo board

1. Keep the same setting (OFDM signal) as the last demo.



### Instructions for the RSA

1. Keep the same setting, or recall the setting Demo5\_OFDM\_marker.tiq. Click **Run**.



- 2. Right click the screen, and select **All markers off**.

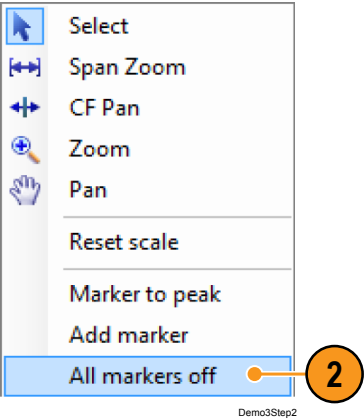

- 3. Click the Settings icon to display the Settings control panel.

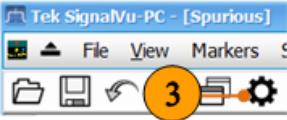

4. In the Traces tab, select Trace 1, and then set Detection to Avg (VRMS) and Function to Avg (VRMS).
5. Select Trace 2, and then set Detection to +Peak, Function to Max Hold, and enable Show.
6. Select the trace to Trace 3, select Detection to -Peak, Function to Min Hold, and enable Show.

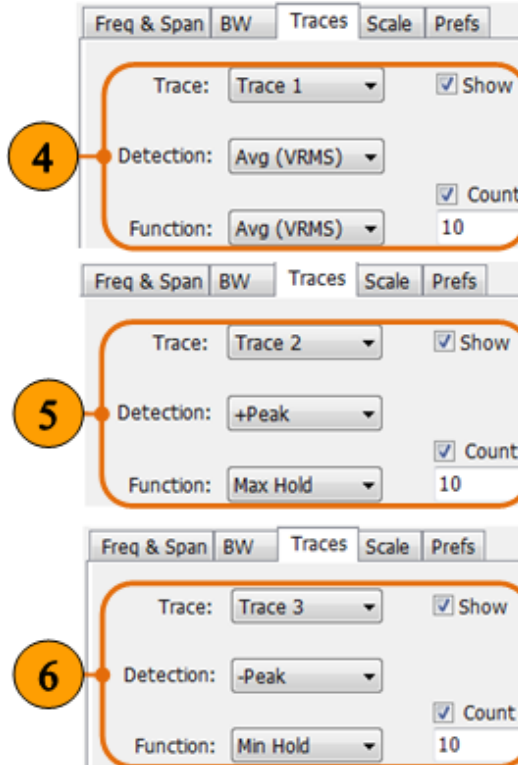



**TIP.** Trace detectors process the data underlying the trace to provide the results you need depending upon your application. Available detection methods are +Peak, -Peak, Avg (VRMS), Sample, and CISPR Pk.

Trace functions are applied to multiple traces as they are displayed. Available settings are Normal, Average, Max Hold, and Min Hold. The Number of Traces setting specifies how many traces are averaged.

The same selections are available in the upper left display selection and mouse-over dropdowns.

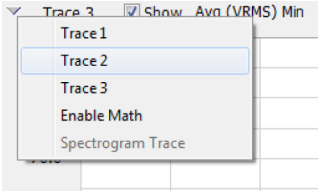

The results show the three difference traces displayed in the screen at the same time.

- The Average trace is generated by multiple traces averaged together. There is one vertical value for each underlying frequency data point. Once the specified number of traces have been acquired and averaged to generate the displayed trace, each new trace takes the place of the oldest trace in the calculation.
- Max Hold trace displays the maximum value in the trace record for each display point. Each new trace display point is compared to the previous maximum value and the greater value is retained for display and subsequent comparisons.
- Min Hold trace displays the minimum value in the trace record for each display point. Each new trace display point is compared to the previous minimum value and the lesser value is retained for display and subsequent comparisons.

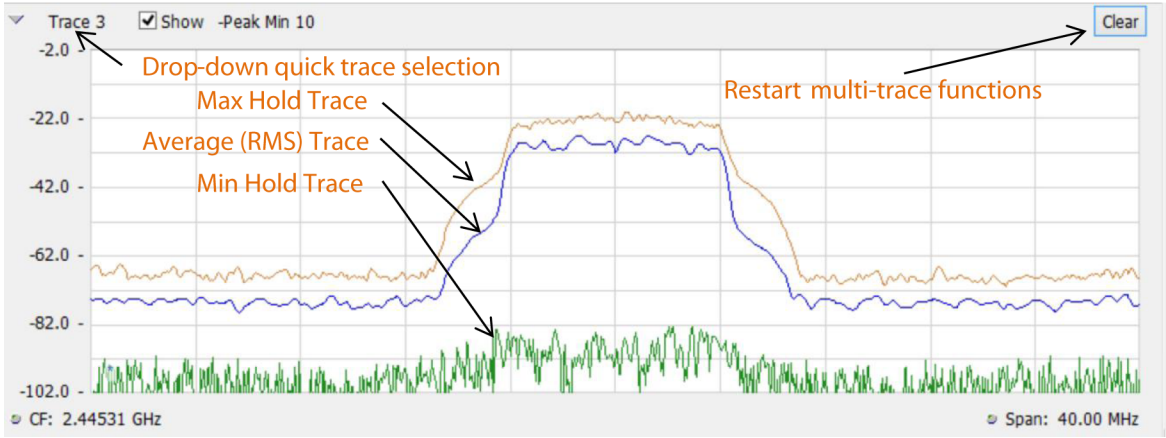

**TIP. Right-click action menu.** You can change marker settings and how waveforms are displayed by using the right-click Actions menu.

Select	Select marker and adjust their position.
Span zoom	Zoom the graph area about the selected point. Right-click in the graph display at a point of interest and drag to increase or decrease the span about the point of interest. Span zoom adjusts the span control.
CF pan	Adjust the center frequency according to horizontal movement.
Zoom	Adjust the horizontal and vertical scale of the graph. The first direction with enough movement becomes the primary scale of adjustment. Adjustment in the secondary direction does not occur until a threshold of 30 pixels of movement is crossed. Drag to the left or down to zoom out and display a smaller waveform (increases the scale value). Drag to the right or up to zoom in and display a larger waveform (decreases the scale value).
Pan	Adjust the horizontal and vertical position of the waveform. The first direction with enough movement becomes the primary direction of movement. Movement in the secondary direction does not occur until a threshold of 30 pixels of movement is crossed.
Marker to peak	Move the selected marker to the highest peak. If no marker is turned on, this control automatically adds a marker.
Add marker	Define a new marker located at the horizontal center of the graph.
All markers off	Remove all markers.



## Demo 7: Save and recall

In SignalVu-PC, you can save different types of data for later recall and analysis.

### Instructions for the demo board

1. Keep the same setting (OFDM signal) as the last demo.



### Instructions for the RSA

1. Keep the same setting, or recall the setting Demo6\_OFDM\_trace.tiq. Select Save As from the File menu to open the Save As dialog box.
2. Navigate to the folder where you want to save the setups, or use the default location. Enter a file name. Select the type of file to Acq data with setup (TIQ)(\* .tiq).
3. Click **Save**.
4. Click the **Preset** button.
5. Click the Recall icon. Navigate to the folder containing the .tiq file you just saved and click **Open**.

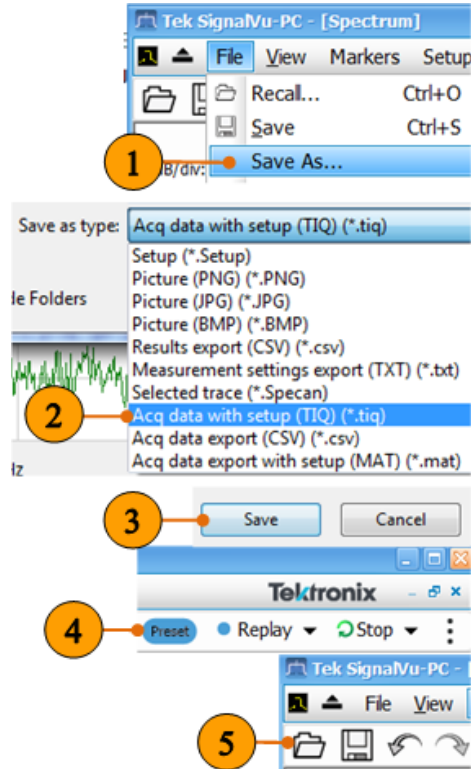



---

**TIP. Save a User Preset**

*To save a setup so that it appears in the User Presets window, save it to C:\SignalVu-PC Files\User Presets. The saved setup will appear in the User Presets window with the name you give the file.*

---



**TIP. File formats you can use to save files**

<i>Setup files (Setup)</i>	<i>Saves all of the setup information for all displays.</i>
<i>Screen shot (PNG/JPG/BMP)</i>	<i>Saves a capture of the screen in the specified format.</i>
<i>Results Export files (CSV)</i>	<i>Saves the trace and numeric data for the selected display. The trace and numeric data are saved as CSV files.</i>
<i>Measurement Settings (TXT)</i>	<i>Saves a list of settings relevant to the selected measurement to a text file. This option is useful for including the measurement settings in reports.</i>
<i>Trace (Various)</i>	<i>Saves a trace for later recall into the display from which it was saved.</i>
<i>Data (TIQ/CSV/MAT)</i>	<i>Saves data and measurement setup for analysis later (TIQ format) or as data to use with external software in either CSV (comma-separated value) or MAT (MATLAB) formats.</i>

## Demo 8: DPX and transient capture

The DPX display helps you to see how traces change over time and displays signal events that cannot be seen on a swept spectrum analyzer. DPX Spectrum indicates how traces change in two ways. First, it uses color shading to show how consistent the shape of a trace is. Second, it uses persistence to hold signals on the screen so you can see them longer. The DPX display reveals transient signal behavior that helps you discover instability, glitches, and interference.

### Instructions for the demo board

1. Keep the same setting as the last demo. Use the ROW and COLUMN buttons to change the signal from OFDM to Inf Hop (Infrequent hopping signals).

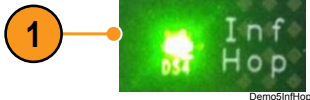

### Instructions for the RSA

1. Keep the same setting, or recall the setting Demo6\_OFDM\_trace.tiq. Click the Select Displays icon.

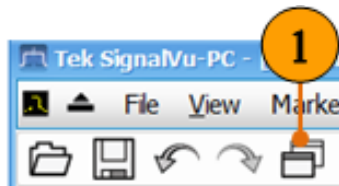

- 2. In General Signal Viewing, select DPX from the Available displays box.
- 3. Click the **Add** button (or double-click the DPX icon). This will add the DPX icon to the Selected Displays box.
- 4. Click the **OK** button.



- 5. In the DPX display, set the CF to 2.4453 GHz and the Span to 40 MHz.  
Select the Split view.

## Demo instructions

You can see the hopping signals displayed in the DPX spectrum, and compare it in the standard spectrum display on the right side. Note that the standard spectrum display nearly or always misses the transient signal.

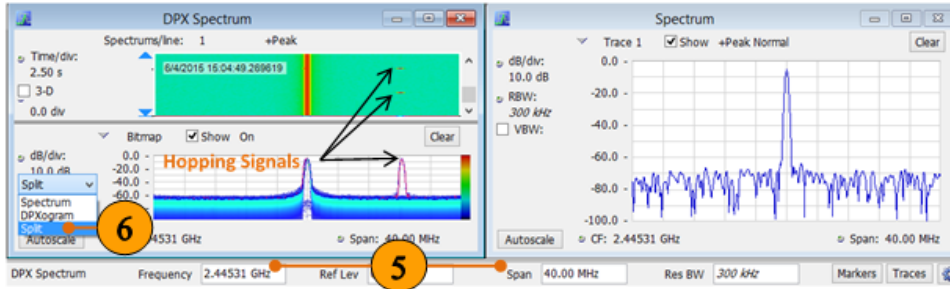



- 6. Select the DPX display by clicking anywhere on it with the mouse, and click the Settings icon.
- 7. Under the Bitmap Scale tab, set the Max scale to 3% for the DPX Spectrum display.
- 8. Under the Ampl Scale tab, set the Min color scale to -80 dBm for the DPXogram display.
- 9. Under the Prefs tab, enable Show parameter readouts.

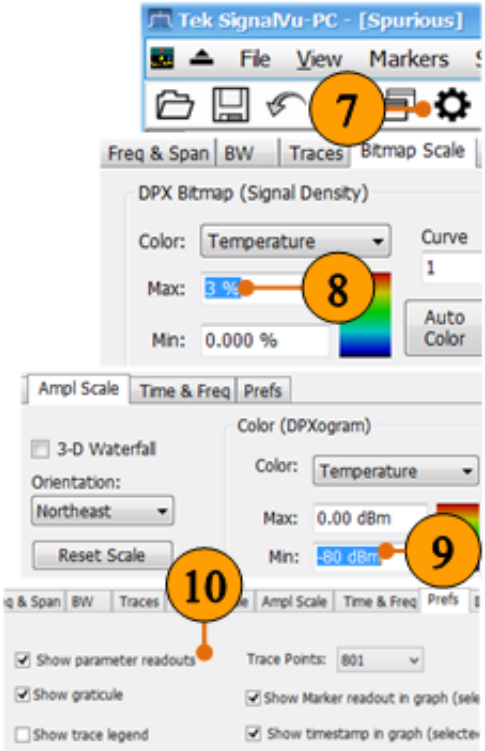



---

**TIP. Changing the color scheme**

*In the “temperature” palette, the highest color (Maximum) is deep red and the lowest (Minimum) is dark blue. Values between Maximum and Minimum are represented by the other colors of the palette.*

---

10. Click **Stop** to pause the measurement. Right click the DPXogram screen, select Add marker, and drag the marker to one hopping signal. Then add another marker and drag it to the closest hopping signal. The delta marker will show the time between two hopping signals is about 1.25 s, or the hop occurs every 1.25 second.
11. You can set the size of the DPX spectrogram by selecting the divider bar between the displays and moving it up or down to add area to the display of interest.

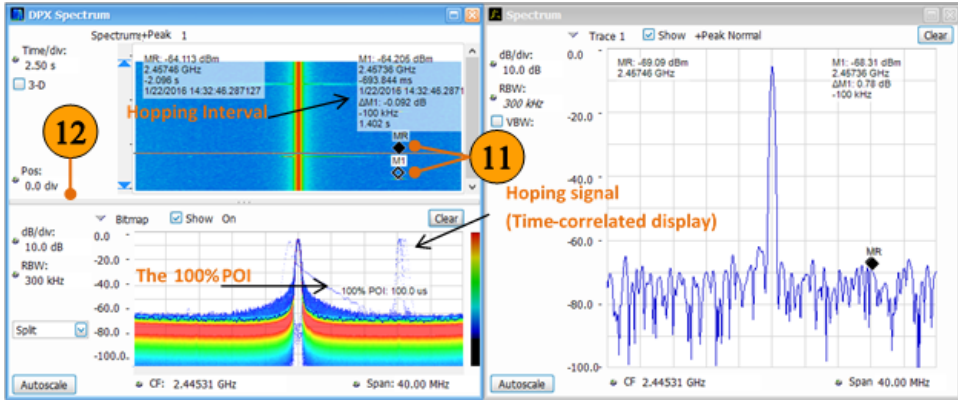

**TIP. 100% POI**

The minimum event duration required to ensure 100% Probability of Intercept (POI) or event capture. It depends on interaction between span, RBW, and FFT length. You can use the POI time value to determine if you are at risk of either missing a narrow transient or of its captured amplitude being less than the actual signal. The minimum 100% POI for RSA306 is 100  $\mu$ s.

## Demo 9: Transient capture - Mask test and act on violation

The mask test feature in SignalVu-PC allows you to save events of interest automatically and allows you to save an acquisition file in an open data format and/or a screen capture when a signal in the frequency domain violates the mask.

### Instructions for the demo board

1. Keep the same setting (Infrequent hopping signals) as the last demo.



### Instructions for the RSA

1. Keep the same setting or recall the setting Demo8\_DPX.tiq. Click **Run**.



- 2. Under the Tools menu, click **Mask Test...**
- 3. Select **DPX: Trace1** in the **Search in:** field .
- 4. Select **is outside mask** in the **Test for:** field.

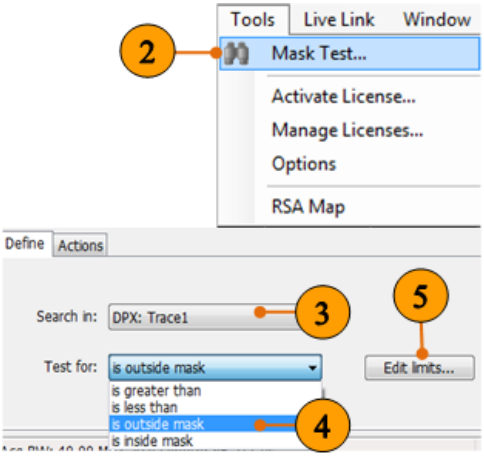

- 5. Click **Edit limits...** to open the Mask Test Editor.

6. In the Mask Test Editor, select the **DPX Trace1** as the Reference.
7. Click **Auto Draw** to generate a mask automatically adjusted to the Reference.
8. Click **Done**.

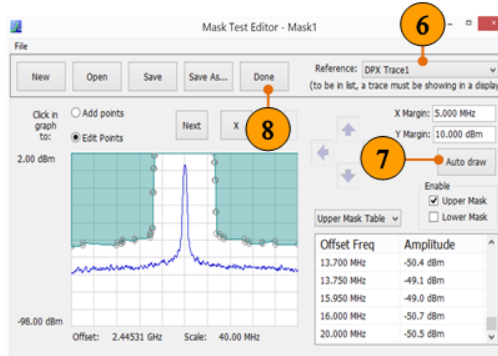

### **TIP. Mask Test Editor**

- *The margins between the mask and the reference trace can be specified by X Margin and Y Margin.*
  - *The points can be added, edited, or deleted.*
  - *You can also create a Frequency Mask by using the manual method.*
-

- 9. Under the Actions tab, select **Beep**, **Save acquisition data**, **Save trace**, and **Save picture**.
- 10. Click **Enable Test**.

When a mask violation is detected, the system will sound a beep, and save all your selected format of files into the selected folder automatically.

## Demo instructions

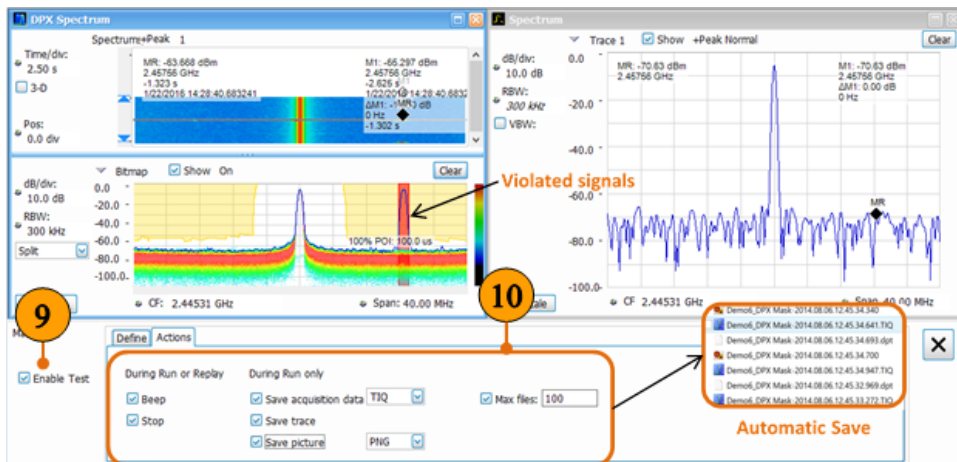



**TIP. Actions for violations**

- *The analyzer can take up to five actions when a match occurs. In Run mode, the analyzer can sound a beep, stop acquisitions, save acquisition data, save trace data, and save a picture of the display. In Replay mode, it can sound a beep and stop analyzing.*
  - *Files can be saved in the native format of SignalVu-PC (.tiq), or in comma separated variable (.CSV) or Matlab level 5 (.MAT) formats.*
  - *The folder for saving files can be selected from **Save as....***
-

## Demo 10: Analog modulation analysis

Analog modulation is the most fundamental modulation method. The analog modulation analysis feature in the RSAs provides measurements to demodulate and analyze amplitude modulation (AM), frequency modulation (FM), and phase modulation (PM). This example shows how to analyze an FM signal with an RSA.

### Instructions for the demo board

1. Keep the same setting as the last demo. Use the ROW and COLUMN buttons to change the signal type from Inf Hop to FM (frequency modulation signals).



### Instructions for the RSA

1. Click the **Preset** button.
2. Click the Select Displays icon.

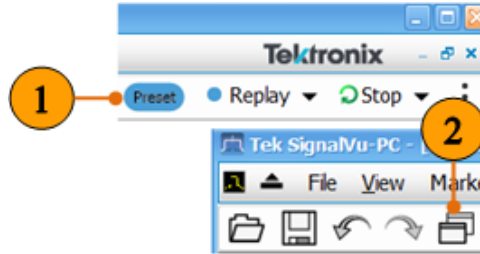

## Demo instructions

---

3. In General Signal Viewing, select DPX from the Available displays box.
4. Click the **Add** button. This will add the DPX icon to the Selected Displays box (and remove it from the Available displays box).

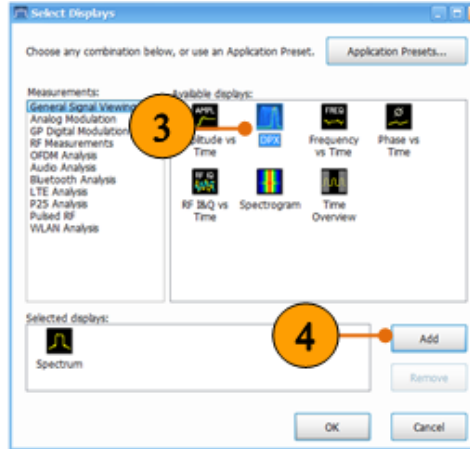

- 5. In Analog Modulation, select FM from the Available displays box.
- 6. Click the **Add** button.
- 7. Click the **OK** button.

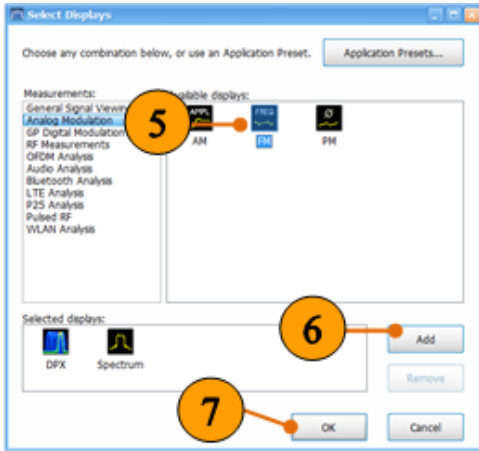

**TIP. Selecting displays**

- You can also double-click the desired display to add or remove it.
- Five application presets are available for the display selection.

8. Select the DPX display by clicking anywhere on it with the mouse, and set the CF to 2.445315 GHz and the Span to 500 kHz.
9. Click the Analysis control button.
10. Under the Analysis Time tab, set the Analysis Length to 10 ms.
11. Click the FM display, and then click the settings button.



12. Under the Parameters tab, set the **Measurement BW** to 200 kHz.

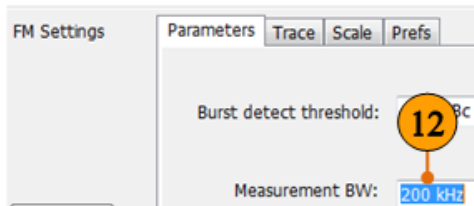

---

**NOTE. FM measurements readout**

- *+Pk: positive frequency deviation*
  - *-Pk: negative frequency deviation*
  - *RMS: RMS value of the deviation*
  - *Pk-Pk: peak-to-peak frequency deviation*
  - *Pk-Pk/2: peak-to-peak frequency deviation divided by two*
-



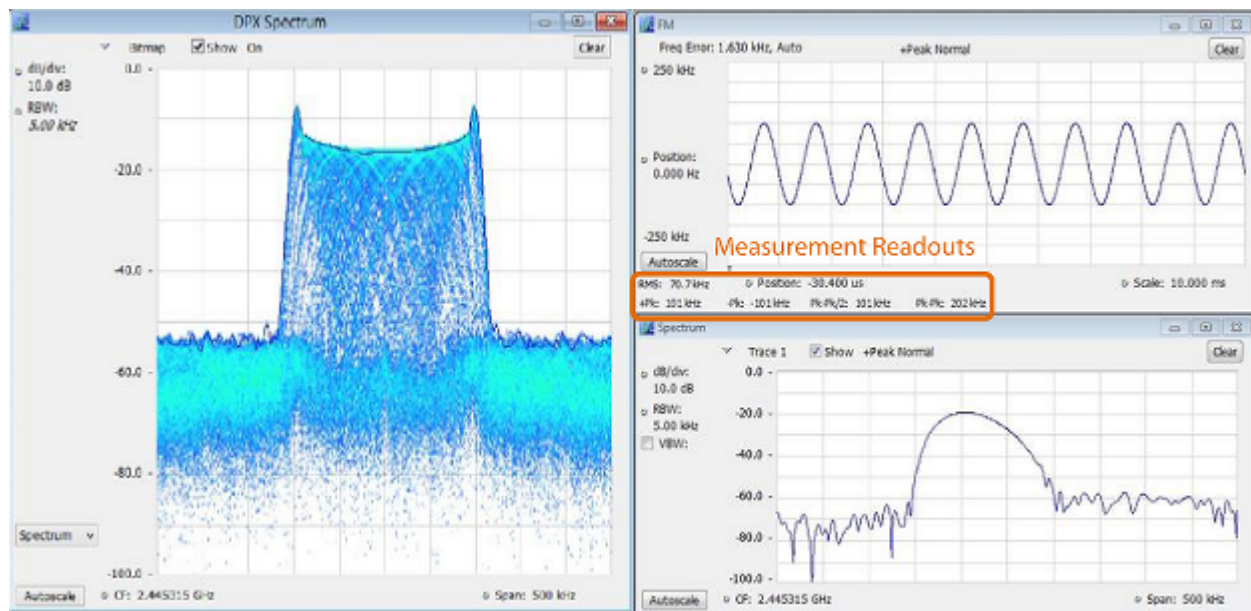

## Demo 11: Digital modulation analysis

The General Purpose Digital Modulation Analysis provides vector signal analyzer functionality. A wide variety of modulation types are supported, allowing you to view your signals in Constellation, Eye and Trellis diagrams, measure the quality of the modulation, display time-domain waveforms for demodulated I & Q signals, EVM, Phase Error, Magnitude Error, and more. This example shows how to demodulate a QPSK signal with an RSA. This demonstration also introduces the concept of application presets to quickly set up for complex analysis tasks. This demonstration relies on the optional modulation analysis capabilities of SignalVu-PC. If you are using a basic version of SignalVu-PC, a trial license for this analysis can be accessed through the Tools > Licenses > Manage menu of the software.

### Instructions for the demo board

1. Use the ROW and COLUMN buttons to change the signal type from FM to QPSK1.

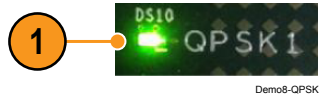

**Instructions for the RSA**

- 1. In the Presets menu, click **Application**.

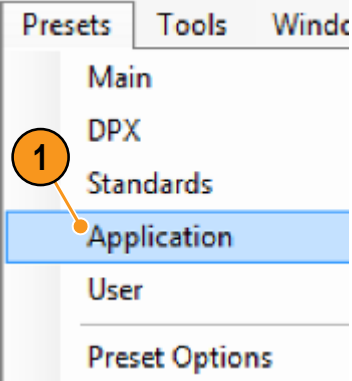

Step1

2. Select **Modulation Analysis** for the Preset.
3. Click **OK**.

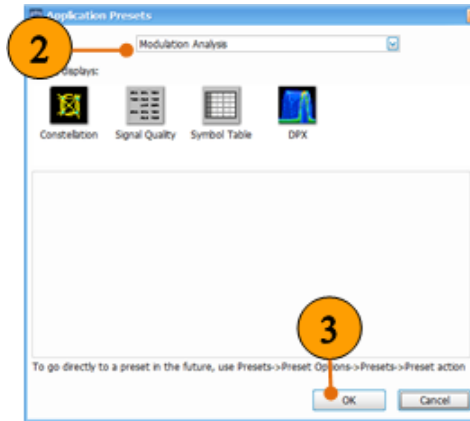

4. Click the DPX display and set the CF to 2.445315 GHz and the Span to 10 MHz.

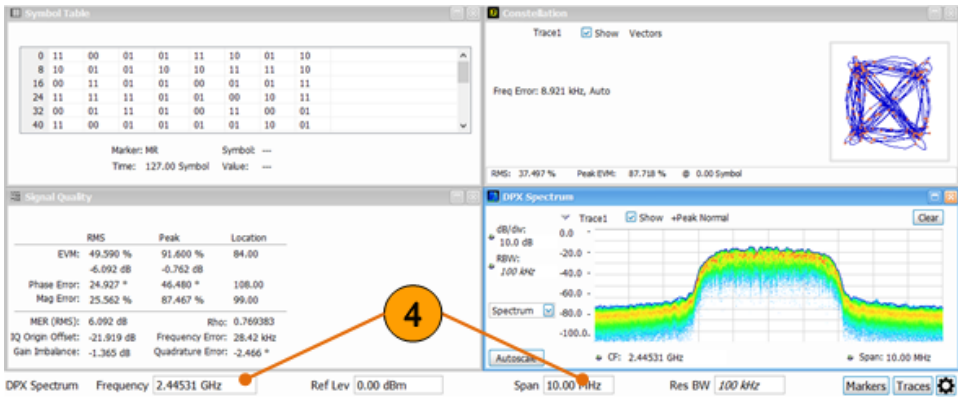

**TIP. Save setups as User Presets**

*To save setups so that they appear in the User Presets window, save your setup in the folder C:\SignalVu-PC Files\User Presets. The saved setup will appear in the User Presets window with the name you give the file.*

## Demo instructions

- Click the Constellation display icon in the Application Presets window, and then click the Settings icon.
- Under the Modulation Params tab, select **QPSK** from the Modulation Type list, set the Symbol Rate to 3.072 MHz, set Measurement Filter to **Root raised cosine**, Reference Filter to **Raised cosine**, and Filter parameter to 0.350.
- Click the **Stop** button.
- Right click the screen and select **Add Marker**.
- Drag the marker to any cell in the Symbol Table. This sets the marker (MR) time value to the starting time for the cell containing the marker.

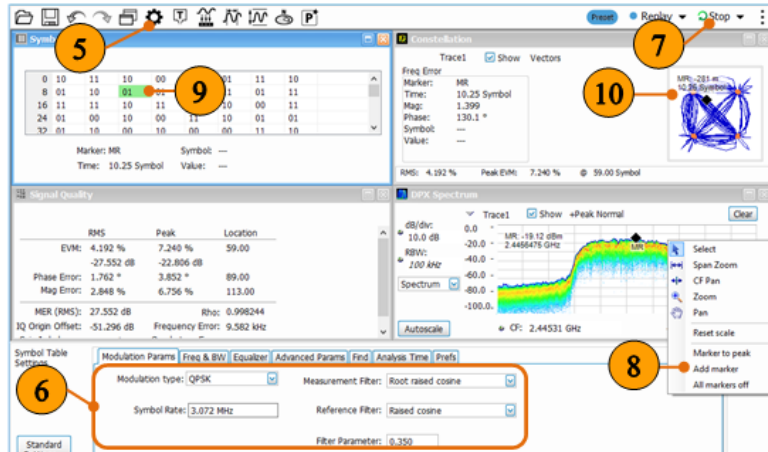

10. Look for MR in the Constellation graph. Move the marker to different cells in the Symbol Table.



---

**TIP. Modulation filters**

*In most modulation schemes, signals are filtered to reduce the bandwidth prior to transmission. When the signal under test has been passed through a modulation filter, a matching Measurement Filter should be selected in the instrument in order to interpret symbols properly. The Reference Filter, while not used for demodulation, is important for making the proper error vector measurement calculations. This filter will normally be defined by the modulation/demodulation standard.*

---



---

**TIP. Symbol table**

*Each symbol value is assigned a position in the Constellation diagram. The Symbol Table will be used to demonstrate the mapping between quadrants in the Constellation diagram and the symbol values.*

---



### **TIP. Correlated display**

*Not only are all the displays correlated through the shared data set, but the markers, which are inherently correlated, make it very easy to see how a data point in one domain relates to a specific data point in any other. This can greatly reduce troubleshooting time.*

---

## **Demo 12: Transmission gain measurement (tracking generator needed, available on the RSA500/600 series)**

A tracking generator (TG) creates a signal present at the center frequency of the spectrum analyzer (SA), so that when the analyzer is swept or stepped across a frequency range, the tracking generator signal is always present. Connecting the TG output to the SA input produces an un-normalized frequency response curve that contains the errors in frequency response due to the generator, analyzer and the connecting cable. These can be removed by running a calibration in the tracking generator application. The measurements made with this type of normalization is done are scalar measurements, and vector parameters are not used.



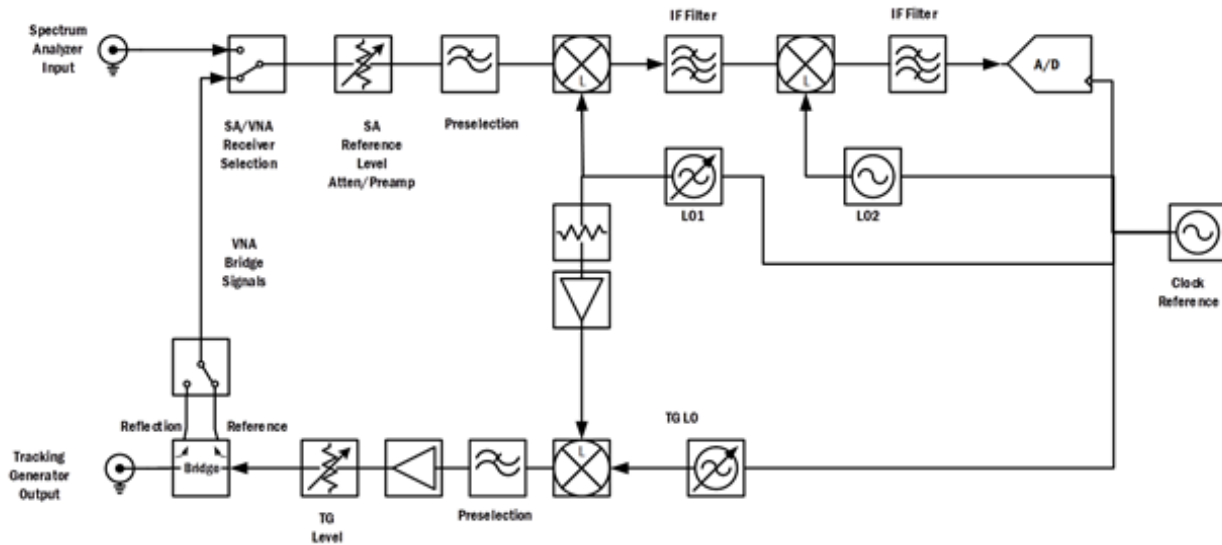

The RSA500A Series and RSA600A Series analyzers contain an internal bridge at the output of the tracking generator. This plus a vector calibration routine enables the instrument to make vector-calibrated measurements of return loss, VSWR, cable attenuation and distance-to-fault (DTF). When the application SV60 is used, the instrument uses a factory calibration of vector parameters at the plane of the output of the tracking generator. In many cases, this calibration yields sufficient measurement accuracy, and no further calibration is required. Should user-calibration be desired, either for best accuracy, or to move the measurement plane from the front panel (for example, if you'd like to remove a length of connecting cable from the measurement results), calibration kits for Open/Short/Load are available for this. For further information on option SV60, please contact your local Tektronix Sales Representative.

**Calibration**

- 1. Make sure the RSA500A/600A is connected to the host PC and then run SignalVu-PC.



## Demo instructions

2. Click **Select Display** button.
3. Select **Spectrum** from the box of selected displays.
4. Click **Remove** to remove the spectrum display.
5. Select **Transmission Gain** from the box of Available displays.
6. Click **Add**.
7. Click **OK**.

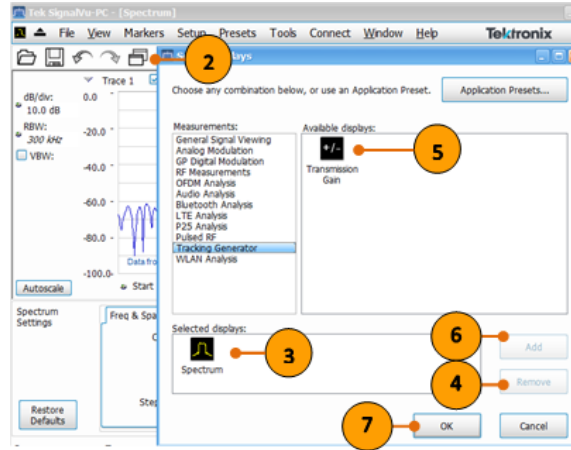

If no cable is connected to the RSA, you may not find the trace on the screen.

- 8. Connect the attenuators, cables, and through connector to the RSA.



You should see the trace now, and it is the trace without any calibration.

 **TIP. Tracking Generator Option**

*To make any tracking generator measurements in SignalVu-PC, please make sure you have a RSA500A/600A with hardware Option 04. Otherwise, the measurements will not be shown in "Available Displays".*

9. Click **Setting** control panel.
10. Set the **Start Freq** and **Stop Freq** according to your device under test. In this example, we set 500 MHz as the start frequency and 2.5 GHz as the stop frequency.
11. Set the **RBW**. Lower RBW can reduce the noise floor of the measurement, but may take longer to measure.
12. Set the number of **Steps**. The higher the number, the more time it takes. 101 steps is recommended as the starting point.
13. Under **Prefs** tab, enable **Show measurement points**, if desired.
14. Click **Calibrate....**

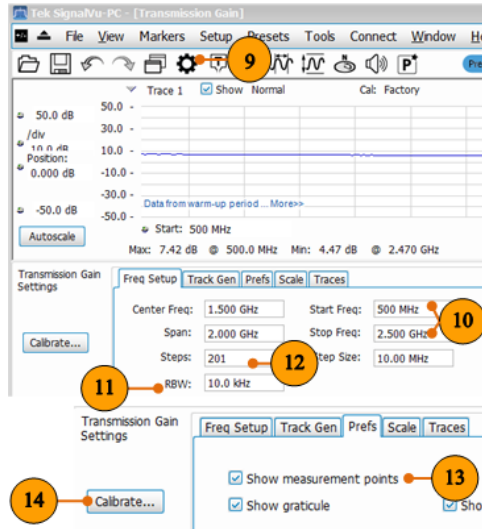

Once you enter the Calibration display, you will see the information of the calibrated condition it made last time, and the change from the last calibration.

**15. Click Perform Calibration....**

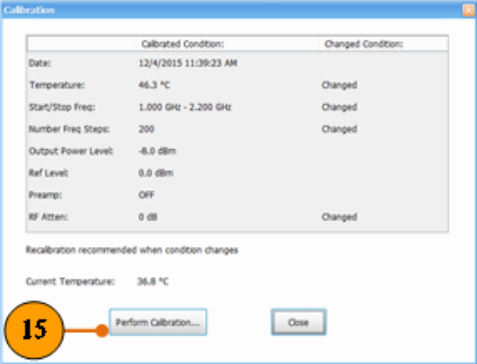

16. Click **Calibrate**, and wait until the calibration finished.

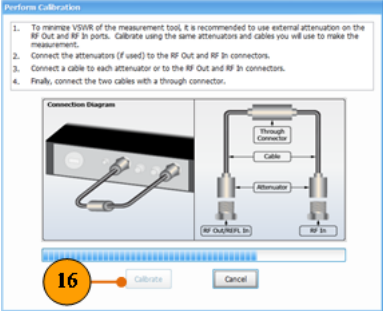

Observe the trace line after the calibration.



### Attenuator Test

1. Under the **Traces** tab, select **Freeze** to keep the current trace (Trace 1) in screen for comparison later.

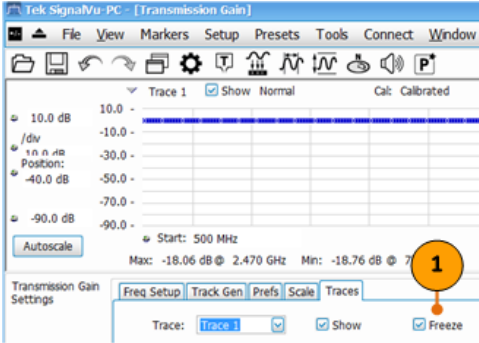

2. Keep the cables and the through connector, and connect the device under test to the cables.

In this example, we test a 10 dB attenuator.



## Demo instructions

- Under the **Traces** tab, select **Trace 2** in Trace.
- Select **Show**.
- Observe the transmission gain of the attenuator from the trace 2 (the orange trace). It should have 10 dB difference to the blue line (without attenuator).
- Click **Autoscale** for a higher resolution display.



1. Keep the cables and the through connector. Remove the 10 dB attenuator. In this example, we connect a 1500-1620 MHz band pass filter as the device under test.
2. Adjust the Scale and Position by clicking . You can also adjust the scale and position manually.
3. Right click the display, and click . Then you can move the marker to see the detail of the gain trace.

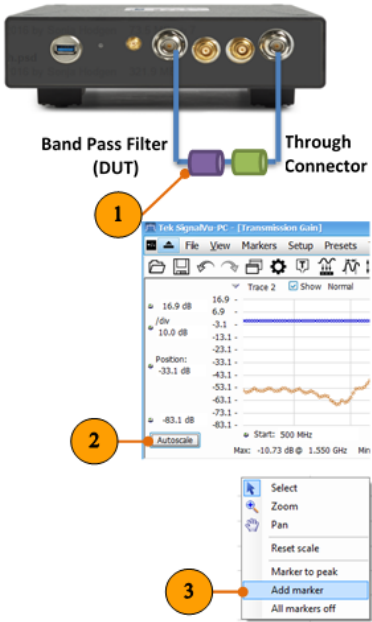

Demo instructions

You can see the gain response of the band pass filter.

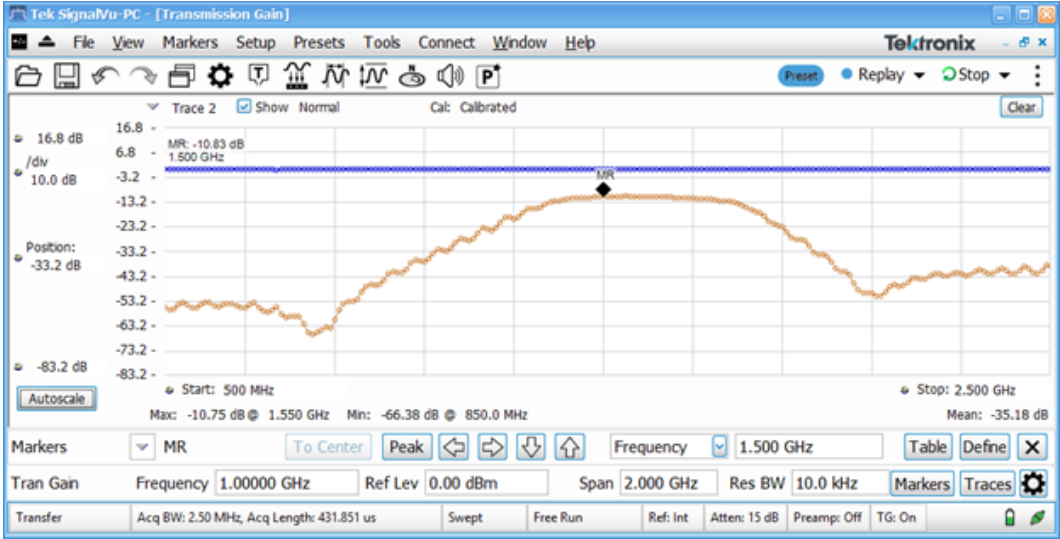

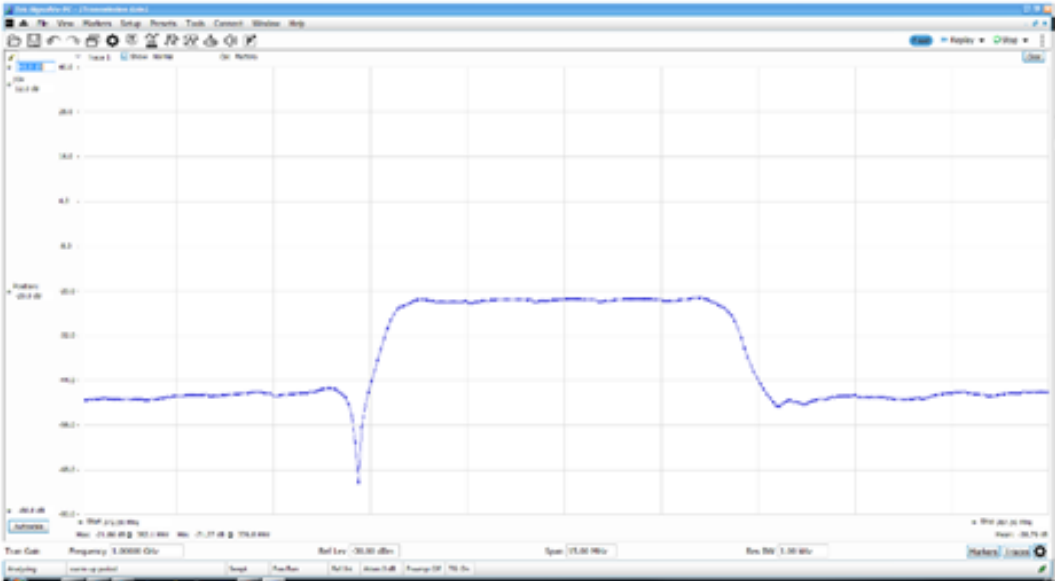

Example I bandpass filter test.

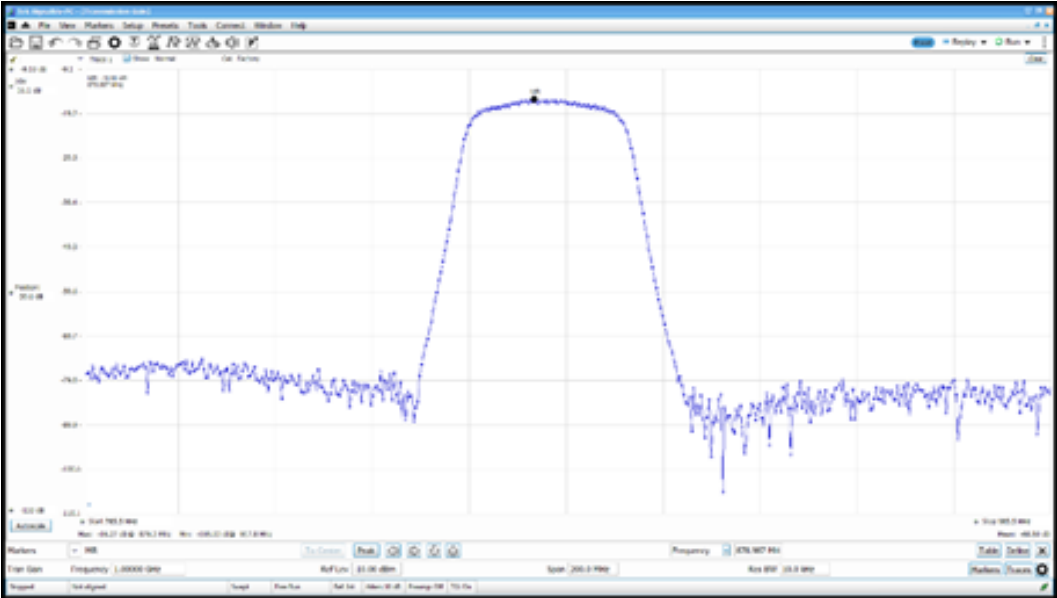

Example II bandpass filter test.