



RX-8248

Ergo™ Long Flush Precision Cut 45° Angle Tapered & Relieved Head Oblique Cutter 0.2 mm-0.8 mm







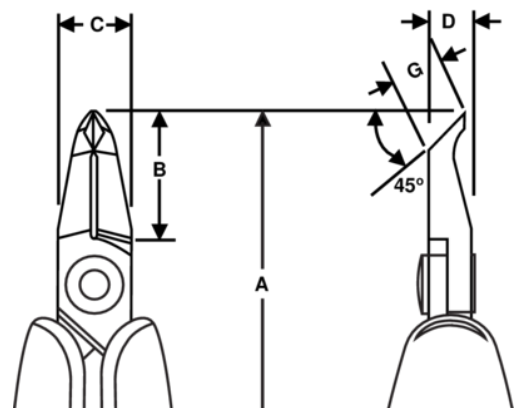

PRODUCT DETAILS

- Ideal for assembly work where accessibility is a consideration
- Two-component Ergo™ handles: thermoplastic surface on tough polypropylene provides superior grip
- Material: High performance alloy steel
- Precision induction hardened edges 63–65 HRC
- ESD safe handles in 2-component synthetic material
- Micro-Touch™: The shape of the handles makes it possible to control and rotate the pliers between thumb and index finger for precision work
- Precision screw joint that minimizes friction and maximizes alignment of cutting edges
- Biospring® reduces tension throughout the working cycle of the tool and can be adjusted in three different positions
- Cutting capacity is listed for solid copper wire
- Phosphated finish



PRODUCT ATTRIBUTES

Product: **RX-8248**

	Angle 45°		S	A	143.0 mm
A	5.63 in	B	18 mm	B	0,71 in
C	10 mm	C	0.39 in	D	6 mm
D	0,24 inch	G	6,7 mm	G	0,26 in
	0.2-0.8 mm		0.01-0.03 in		Flush
	72 g	Ω	Dissipative		