

Automatic Feeder PA-04/H

USER MANUAL

ITDU-70-04-02-18-EN



RADWAG
537888 39300 X1S
456 BN 980 CVB HG1SA
Made in Poland



RADWAG BALANCES AND SCALES
ADVANCED WEIGHING TECHNOLOGIES

FEBRUARY 2018

Contents

1. GENERAL INFORMATION	4
1.1. Intended Use	4
1.2. Precautions.....	4
1.3. Warranty Conditions	4
1.4. User Manual Significance.....	4
2. UNPACKING AND INSTALLATION	5
2.1. PA-04/H Unpacking and Levelling.....	5
2.2. Maintenance	6
2.3. Connecting the Automatic Feeder to the Mains	6
2.4. Connecting the Automatic Feeder to the Weighing Instrument.....	6
3. FEEDER DESIGN	7
3.1. Dimensions	7
3.2. Connectors and Switches Arrangement	8
4. START-UP	9
5. FEEDER CONTROL PANEL	9
6. OPERATION	10
6.1. Automatic Emptying of the Storage Bin.....	10
6.2. Vibration Intensity Control	10
7. MASS CONTROL MODE	10
7.1. Mass Control Mode Activation.....	10
7.2. Mass Control Global Settings	10
7.3. Databases– Mass Controls	11
7.4. Mass Control Process	11
8. DATABASES	13

1. GENERAL INFORMATION

1.1. Intended Use

PA-04/H automatic feeder is dedicated for automatic dispensing of small objects, in particular pills, capsules and small mechanical components. The feeder ensures regular feeding of the elements onto the weighing pan to which it is connected.

PA-04/H, connected to RADWAG-manufactured Y series analytical balance, enables quick statistical control in accordance with strict pharmaceutical requirements.

1.2. Precautions

- A. Prior to first use, carefully read this User Manual. Use the feeder only as intended;
- B. Prior to first use, position the automatic feeder;
- C. Upon feeder levelling, lock its feet against any movement;
- D. The feeder + balance set has to be placed on an anti-vibration table;
- E. Do not load the container with pills eccentrically;
- F. In case of damage, immediately unplug the device from the mains;
- G. Feeder to be decommissioned, should be decommissioned in accordance with valid legal regulations;
- H. Do not use the feeder in areas endangered with explosion. The feeder is not designed to operate in hazardous areas.

1.3. Warranty Conditions

- A. RADWAG feels obliged to repair or exchange all elements that appear to be faulty by production or by construction.
- B. Defining defects of unclear origin and means of their elimination can only be realized with assistance of manufacturer and user representatives.
- C. RADWAG does not bear any responsibility for damage or losses resulting from unauthorized or inadequate performing of production or service processes.
- D. The warranty does not cover:
 - mechanical damage caused by product exploitation other than intended, damage of thermal and chemical origin, damage caused by lightning, overvoltage in the power network or other random event,
 - damage caused by product exploitation other than intended,
 - mechanical defects or defects caused by liquids, water and natural wear,
 - damage caused by inappropriate setting or by electrical wiring failures,
 - inappropriate cleaning habits.
- E. Loss of warranty takes place if:
 - a repair is carried out outside RADWAG authorized service point,
 - service claims intrusion into mechanical or electronic construction by unauthorized people,
 - mechanical damage caused by product exploitation other than intended.
- F. For detailed warranty conditions read the warranty certificate.

1.4. User Manual Significance

Even if you are experienced and have already worked with this type of device, you are obliged to read the user manual carefully before the start-up.

2. UNPACKING AND INSTALLATION

2.1. PA-04/H Unpacking and Levelling

Upon unpacking the automatic feeder and removing transport locks, place the feeder on a stable ground (anti-vibration table is recommended). Procedure:

1. Place the storage bin (plate) on the guides.
2. Assemble the storage bin by turning it clockwise.
3. Apply the top cover.
4. Place the lid in the recess of the top cover.
5. Assemble the chute.
6. Set desired tilt angle using adjusting screw. Upon setting respective angle secure the screw with the nut.

CAUTION: When removing the feeder from the packaging or changing its location, hold the lower part of the device. The cover is not permanently assembled to the housing.

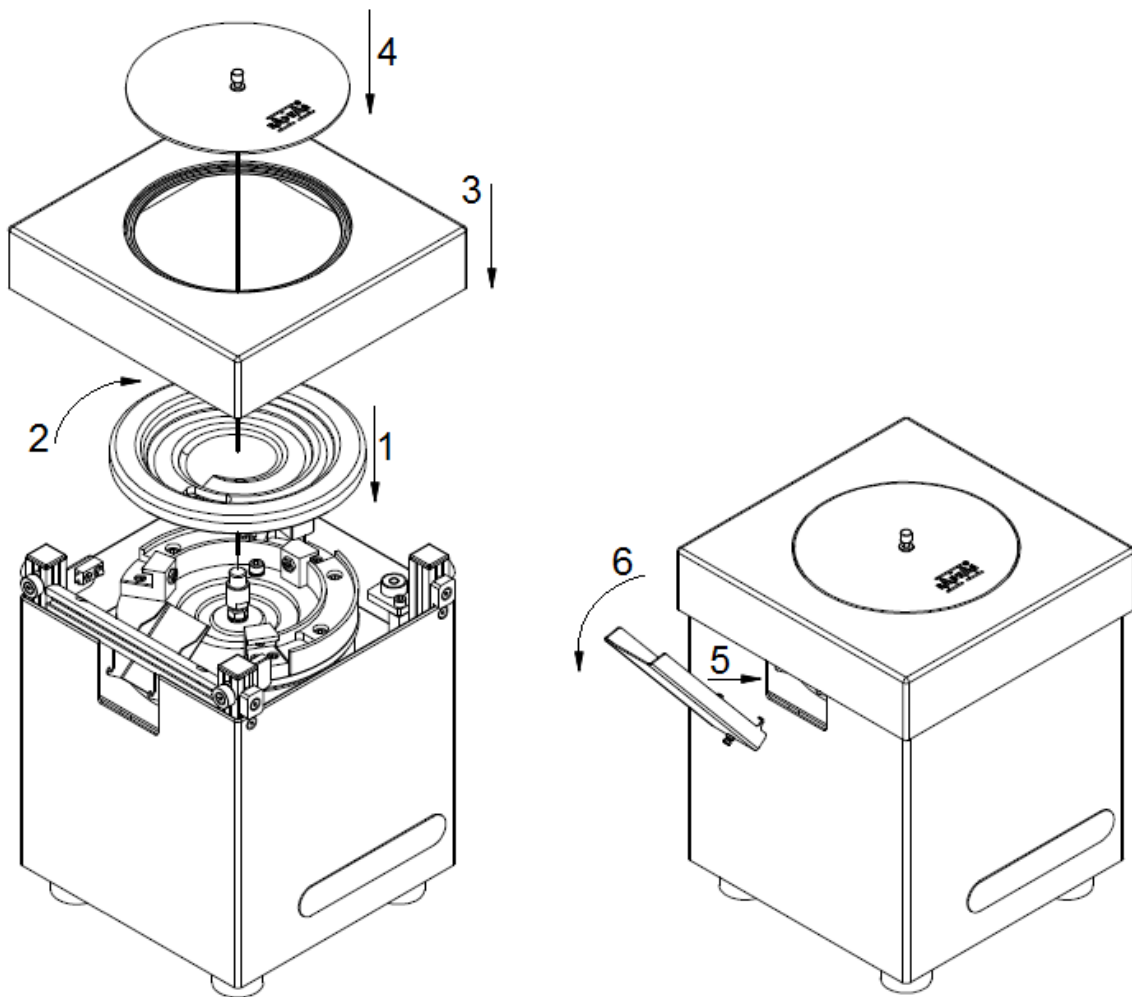

Connect the following cables to the automatic feeder: power and signal cables. Upon connecting the cables, position the feeder using its feet. Keep turning the feet until the air bubble, located under the top cover of the feeder, takes central position.

2.2. Maintenance

Clean the storage bin and the chutes.

CAUTION:

Cleaning the storage bin while still installed may cause damage of the feeder.

To clean the storage bin follow the steps presented below:

- Remove the top cover of the feeder;
- Remove the storage bin, do it counterclockwise;
- Clean (disinfect) the storage bin;
- Upon cleaning process completion, install the feeder. Do it clockwise.
- Install the top cover of the feeder.

2.3. Connecting the Automatic Feeder to the Mains

The feeder must be connected to 230 V AC only by means of an original power cord which comes standard with the feeder. Plug the power cord to the automatic feeder. The feeder's power plug is located at the back of its housing. Turn on the feeder using the switch.

2.4. Connecting the Automatic Feeder to the Weighing Instrument

Connect the feeder to the weighing instrument's COM2 port (connector No. 4, see figure below) using cable that comes standard with the feeder.

Indicator connectors' arrangement:

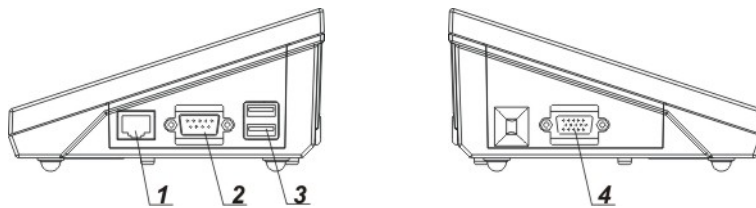



- 1 – Ethernet RJ45 connector
 2 – RS232 (COM1) connector
 3 – USB connector

4 – I/O, RS232 (COM2) connector

Defining communication parameters for communication between weighing instrument the feeder.

Enter **<Devices>** menu and set feeder connection parameters:





Pictogram	Description	Value
	Pills feeder	-
	Port	COM2
	Address	255
	Device type	Radwag feeder

CAUTION:

Address and baud rate are to be found on the feeder's data plate.

Setting COM 2 port on the weighing instrument:

Enter <Communication> menu and set COM 2 port transmission parameters.

Pictogram	Description	Value
	COM2	-
	Baud rate	57600
	Data bits	8
	Stop bits	1
	Parity	None

3. FEEDER DESIGN

3.1. Dimensions

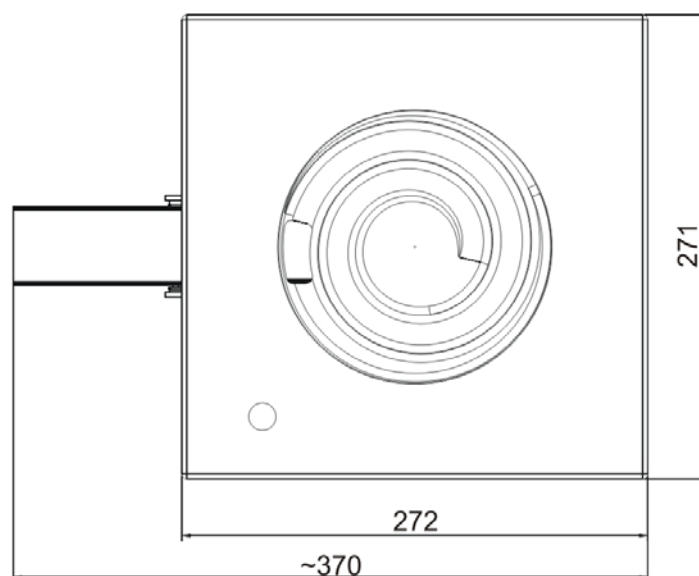
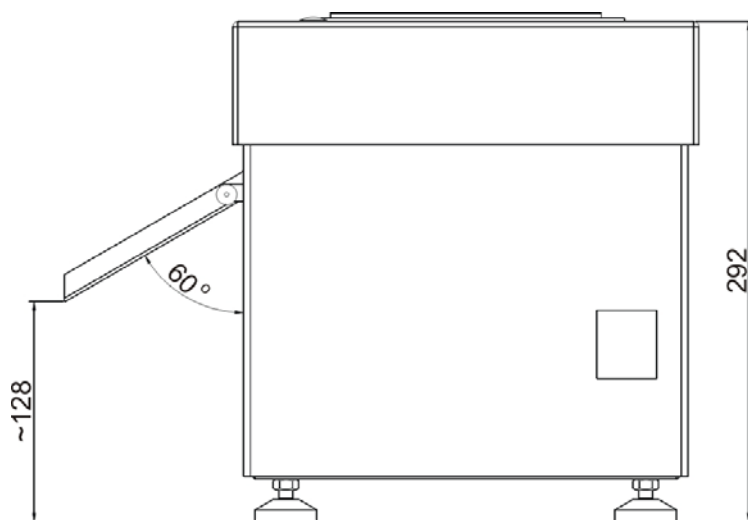

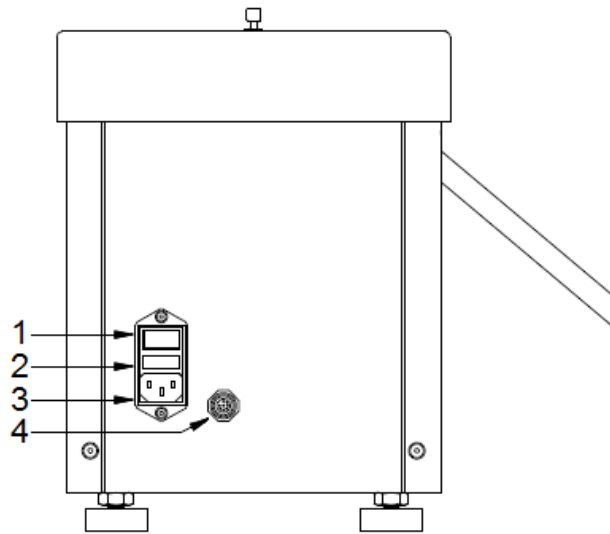

3.2. Connectors and Switches Arrangement



- 1- Switch-key
- 2- Safety device
- 3- Power supply socket
- 4- Communication connector (for connecting weighing instrument)

4. START-UP

- Connect the power supply to the mains, ON/LOAD  diode on the operation panel lights up.
- Press  key located on the top of the operation panel. Within a few seconds the OS Windows and RADWAG software start loading, it is signalled by flickering ON/LOAD red diode.
- Upon completed start-up, the home screen is displayed automatically with Mass control working mode.
- Switch the automatic feeder on.







The feeder is ready for operation.



Exemplary workstation for mass control

5. FEEDER CONTROL PANEL



Key	Description
	Press to start emptying
	Automatic feeder switched on
	Automatic feeder operates
	Vibration intensity indicator
	Press to increase vibration intensity
	Press to decrease vibration intensity

6. OPERATION

6.1. Automatic Emptying of the Storage Bin

Automatic feeder is equipped with function of automatic emptying of the storage bin. Press and hold



key for 3 sec to start emptying the storage bin. Upon storage been emptying and after specified time interval, the feeder stops automatically. To stop the emptying process manually, press the emptying key again.

6.2. Vibration Intensity Control

Upon enabling feeding operation using weighing instrument you can adjust the vibration intensity





using keys. Vibration intensity set on the feeder will be applied until the product is changed or the feeder turned off.

7. MASS CONTROL MODE

<  **Mass control** > is a working mode enabling you to control mass of a product automatically batched (dosed) onto the weighing pan, wherein dosing is carried out using balance-connected PA-04/H automatic feeder. The mode automatically determines quantity and controls a complete batch of tested product.

7.1. Mass Control Mode Activation

Procedure:







- Select <  **Mass control** > mode, the home screen is displayed automatically, wherein the top bar of the screen features  pictogram,
- The following button is displayed:





Press to start mass control process

7.2. Mass Control Global Settings



















To enter Mass control mode settings press grey area workspace on weighing instrument's display and select "Settings" <  > menu, which contains the following:

	Request batch number	The parameter requests a batch number before starting mass control process.
	Batch quantity	The parameter determines quantity of a batch, i.e. number of product units to be controlled.
	Min threshold	The parameter exceeding which causes accepting a measurement record by a balance.
	Max threshold	The parameter exceeding which causes omitting a measurement in the summary, e.g. if two parts (pills) are simultaneously dispensed on the weighing pan.
	Print report	The parameter switches on/off automatic printout of a report on completing mass control process.
	Printout	The parameter enables selecting whether on completing the control process a standard or a non-standard printout are to be printed out.

7.3. Databases– Mass Controls

<  **Mass control**> mode features new database: <  **Mass controls**> where reports of carried out controls are stored.

The reports contain the following information:



 Batch number	Number of controlled batch
 Start date	Control process start date
 End date	Control process end date
 Operator	Operator carrying out control process
 Product	Controlled product
 Average	Mean mass value determined during control
 Standard deviation	Standard deviation of carried out control
 T4- errors quantity	
 T3- errors quantity	
 T2- errors quantity	
 T1- errors quantity	
 T1+ errors quantity	
 T2+ errors quantity	
 T3+ errors quantity	
 T4+ errors quantity	
 Batch quantity	Controlled batch quantity determined in a report
 Measurements graph	
 Probability distribution graph	

Each report can be printed. To do that, select a report and display its details. <  **Print**> pictogram is displayed. Press the pictogram to print out the report.







The database can be exported to a file. To do that, press <  **Export to a file**> button.

7.4. Mass Control Process

Prior to process start carry out the following steps:

- Set batch quantity for carried out mass controls - press the grey area on weighing instrument's display and select <  **Settings**>. Next select <  **Batch quantity**> and enter quantity of pieces controlled within carried out

automatic process control. Press  button to confirm entered value.

- Set  **Min threshold**> value below the mass value of the smallest controlled piece. Select threshold value to avoid saving the measurement on the final report when the dispensed element has lower mass than the smallest element in controlled series (e.g. half of a pill).
- Set  **Max threshold**>. Select threshold value to avoid saving the measurement on the final report when the dispensed element has greater mass than the biggest element in controlled series (e.g. two elements dispensed at the same time). In case of the above situation weighing instrument's program omits such measurement and continues mass control process.
- Set  **Dosing speed**> parameter for controlled product. The speed is determined in [%] between 0% and 100%. Dosing speed has to be determined for each product separately. To set  **Dosing speed**> press SETUP and select  **Databases**>. Next, select  **Product**> database and product for which **Dosing speed** parameter is to be set.
- Select controlled product from the products database  >. Determine: nominal mass (Mass) and error thresholds: with minus sign - **<T4->**, **<T3->**, **<T2->**, **<T1->** and with plus sign - **<T1+>**, **<T2+>**, **<T3+>**, **<T4+>**. Errors are set as percent of nominal mass (Relative value) or in mass unit (Absolute value).
If some thresholds are not determined, they will not be used during control process.

*e.g.: Nominal mass 25.000g; **<T1->**=2.000g; **<T1+>**=1.000g. For such values, samples ranging between 23.000 g and 26.000 g are correct. However samples of mass lower than 23.000 g are classified as samples with **<T1->** error. Samples of mass greater than 26.000 g are classified as samples with **<T1+>** error.*

Mass control process:

- Upon determining all required settings, press  button to start automatic mass control.
- Automatic control is started. The weighing instrument is tared and the feeder starts dispensing the first element onto the weighing pan.
- Upon dispensing the first element onto the weighing pan, the feeder stops dispensing. The element is weighed using weighing instrument; the first stable measurement is carried out.
- Upon saving the measurement, the weighing instrument is zeroed and next element is dispensed onto the weighing pan. The weighing process is carried out analogously to the first element.
- The cycle is repeated until all pieces are weighed.
- The following information is displayed during control process:
 - Reference sample quantity;
 - Product;
 - Average;
 - Standard deviation;
 - T1- errors quantity;
 - T2+ errors quantity.











All reports of carried out controls are to be found in  **Mass controls** database.



CAUTION:

Each control process can be aborted if necessary by pressing  button. The process is stopped and control process is aborted (no report is generated).

8. DATABASES

Weighing device software comprises the following databases:

	Products
	Weighings
	Customers
	Mass controls
	Minimum sample weight
	Ambient conditions
	Packaging
	Warehouses
	Printouts
	Universal variables
	Databases management

To enter  **Databases**> menu, press  button located in the home screen and select  **Databases**> option.

For detailed information on databases and other functions of the weighing instrument refer to its user manual.



RADWAG BALANCES AND SCALES
ADVANCED WEIGHING TECHNOLOGIES

