



ITKB-15-01-10-21-EN

Quick Start

# Indicator

---

- PUE H315

To view the full user manual, go to the website or scan the QR code:

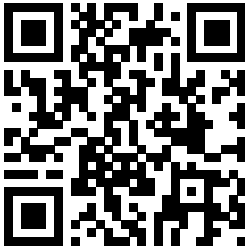

# 1. CONTENT

PUE H315



Indicator  
x1

## 2. NOTES AND WARNINGS

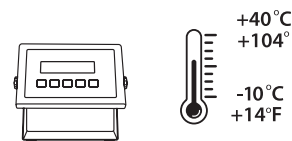

Operate the indicator in a room free from dust where the temperature ranges -10–40 °C (+14–104 °F) and where the relative humidity is below 80%. Potential temperature change shall occur gradually and slowly.

Place the scale on a table or a wall bracket ensuring stability. For the most stable and repeatable results it is recommended to use an anti-vibration table.

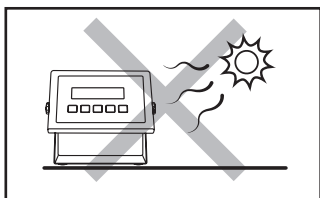

Place the scale away from heat sources. Avoid exposing the scale to the sunlight.

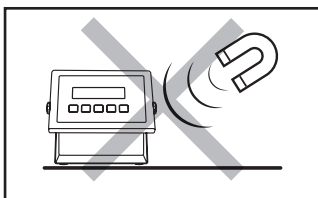

Avoid exposing the scale to the influence of a magnetic field. Do not weigh magnetic substances.

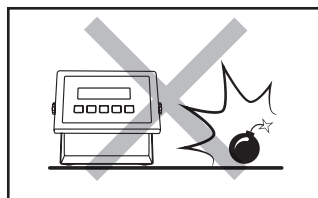

Not intended for use within EX zones. Not intended for weighing explosive or flammable substances.

## 3. PREPARING FOR WORK

### 3.1. Indicator Temperature Stabilization

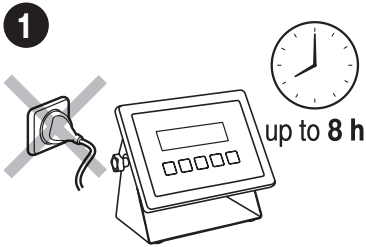

Prior to switching the device on let it reach room temperature (estimated stabilization time: 8 hours).

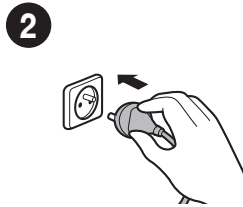

Connect the device to the mains.

### 3.2. Indicator Start-Up

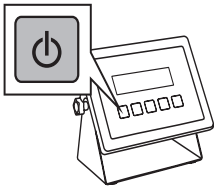

The indicator is ready for operation!

Press ON/OFF key to start the indicator.

## 4. PANEL AND SCREEN

### 4.1. Keypad

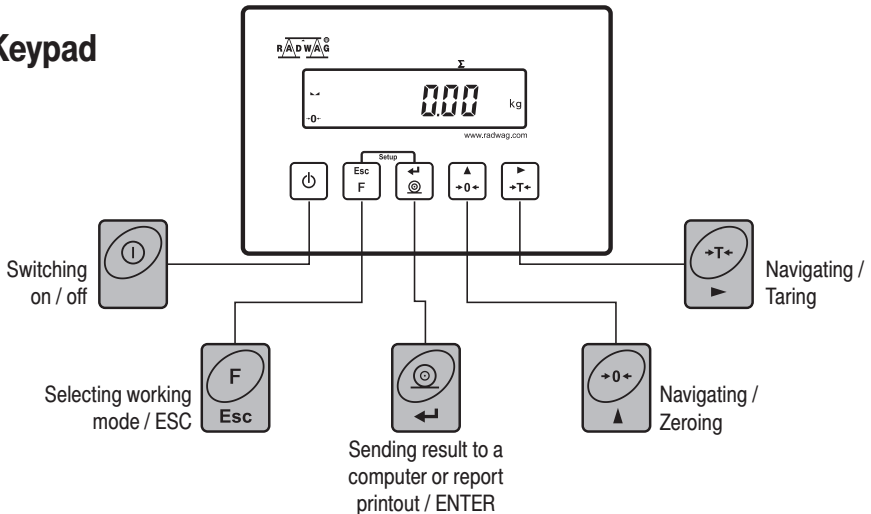

## 4.2. Home Screen



## 5. BASIC OPERATIONS

### 5.1. Working Mode Accessibility

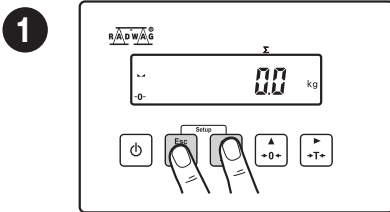

Simultaneously press + keys to enter the home screen.

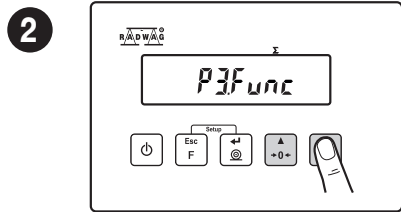

Press key to select "P3.Func" parameter and press key.

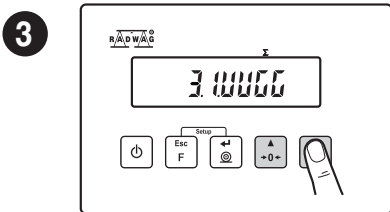

When „3.1.UUGG” parameter is enabled, press key.

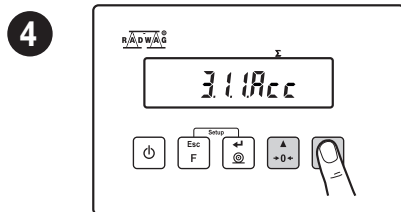

Press key to select "3.1.1.Acc" parameter and press key.

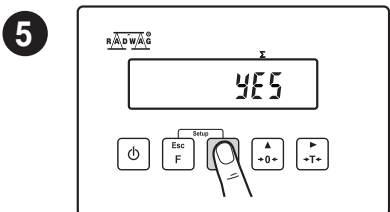

Press key to select „YES” parameter and press key to save settings.



Follow the above procedure to configure other working modes.

## 5.2. Working Modes

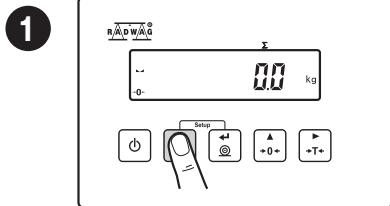

Press key to enter the menu.

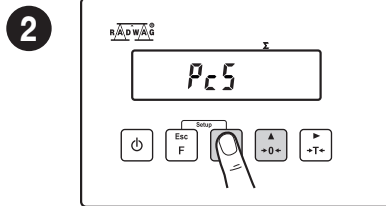

Press key to select working mode and press key to confirm.

### Working modes list:

- Weighing
- Parts counting
- +/- control
- Percent weighing
- Peak hold
- Totalizing
- Animal weighing

For detailed description of working modes and their settings refer to the indicator's full user manual.

## 5.3. Unit Selection



When g (gram) is the main unit, you can select the following units:  
g (gram), kg (kilogram), ct (carat), lb (pound). \*

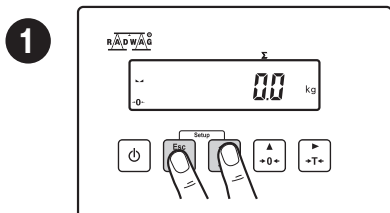

Simultaneously press + keys to enter the home screen.

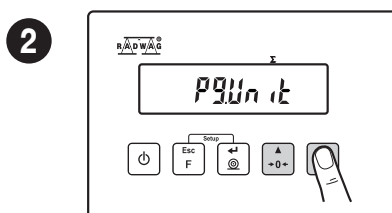

Press key to select 'P9.Unit' parameter and press key.

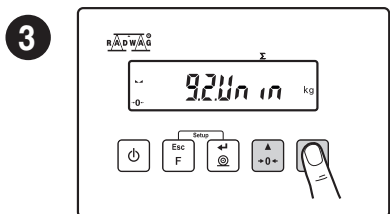

Press key to select "9.2.Unin" parameter and press key.

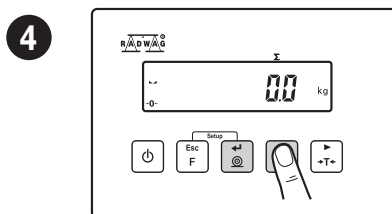

Press key to select mass unit and press key to confirm.

\* Unit pound (lb) not available for verified scales.

## 6. CONNECTING PERIPHERALS

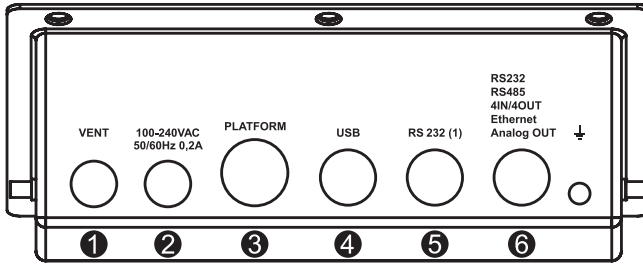

1	Vent
2	Power cord
3	Platform
4	USB connector
5	RS232 (1) connector
6	Universal socket or gland (RS232 (2) or RS485 or Ethernet or IN/OUT)

## 7. CLEANING AND MAINTENANCE

### 7.1. Notes and Warnings

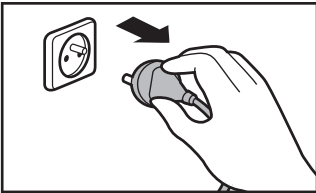

Prior to cleaning it is necessary to disconnect the scale from the mains. Unplug the connector from the electrical socket.

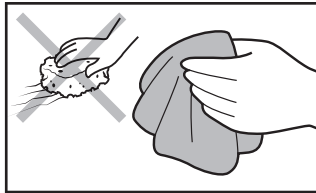

For cleaning use only soft cloths made of microfiber. Do not use any abrasive cloths or any material that may scratch the surface!

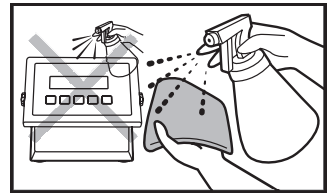

Apply the cleanser onto the cloth first. Avoid applying the cleanser directly onto the device!



---

**Avoid using aggressive cleaning agents (e.g. solvents, cleansers containing chlorine, corrosive substances or bleach).**



---

**Do not use cleansers containing abrasive substances or scouring preparations.**



---

**Make sure that no dust or liquid enters the sockets and the inside of the indicator.**

## 7.2. Cleaning Tips

- Clean plastic components using a soft cloth slightly moistened with a solution of water and a mild detergent (e.g. soap or dishwashing liquid).
- Dry cleaned elements using soft and dry cloth or use dust-free paper towel to absorb the remaining moisture.
- Do not install the components until they are completely dry.

