

PUE H315

WEIGHING INDICATOR

USER MANUAL

ITKU-130-02-09-21-EN











RADWAG® RADWAG BALANCES AND SCALES
ADVANCED WEIGHING TECHNOLOGIES

SEPTEMBER 2021

PRECAUTIONS

Prior to installation, use or maintenance activities, carefully read this user manual and follow the provided guidelines.

| | |
|---|--|
|  | Prior to the first use, carefully read this user manual. Use the device only as intended. |
|  | Protect the indicator against considerable temperature variation, solar and UV radiation, substances causing chemical reactions. |
|  | The weighing device must not be operated in hazardous areas endangered with explosion of gases, and in dusty environments. |
|  | In case of damage, immediately unplug the device from the mains. |
|  | Scales to be decommissioned must be decommissioned in accordance with valid legal regulations. |
|  | Do not let battery discharge in case of prolonged storage of the device in low temperature. |
|  | A worn out battery can be replaced only by the manufacturer or by the authorized service. |
|  | Accumulators do not belong to regular household waste. The European legislation requires discharged accumulators to be collected and disposed separately from other communal waste with the aim of being recycled. Symbols on batteries identify harmful compounds: Pb = lead, Cd = cadmium, Hg = mercury. Dear user, you are obliged to dispose of the worn out batteries as regulated. |

CONTENTS

| | |
|--|-----------|
| 1. INTENDED USE | 5 |
| 2. WARRANTY CONDITIONS | 5 |
| 3. MAINTENANCE ACTIVITIES | 6 |
| 3.1. Cleaning Stainless Steel Components | 6 |
| 3.2. Cleaning ABS Components | 6 |
| 4. DESIGN | 6 |
| 4.1. Dimensions | 6 |
| 4.2. Connectors Arrangement | 7 |
| 4.3. Pins Arrangement | 7 |
| 4.4. Operation panel | 8 |
| 4.5. Technical specifications | 9 |
| 5. INDICATOR INSTALLATION | 9 |
| 5.1. Unpacking and Installation | 9 |
| 5.2. Start-Up | 10 |
| 5.3. Battery Charge Status | 10 |
| 5.4. Battery Charge Status Check | 10 |
| 6. OPERATING THE MENU | 11 |
| 6.1. Return to the Weighing Mode | 11 |
| 7. INSTALLER INSTRUCTION | 11 |
| 7.1. Connecting 6-Wire Load Cell | 11 |
| 7.2. Connecting 4-Wire Load Cell | 12 |
| 7.3. Connecting Load Cell's Cable Shield | 13 |
| 8. FACTORY SETUP | 14 |
| 8.1. Access | 14 |
| 8.2. Factory Parameters List | 15 |
| 8.3. Device Defining | 17 |
| 8.4. Factory Adjustment | 18 |
| 8.4.1. External Adjustment Process | 18 |
| 8.4.2. Start Mass Determination | 18 |
| 8.4.3. Correction of Start Mass Expressed in Converter's Divisions | 19 |
| 8.5. Linearity Correction | 19 |
| 8.5.1. Entering Linearity Correction Points | 19 |
| 8.5.2. Corrections | 20 |
| 8.5.3. Deleting Linearity | 20 |
| 8.6. Gravitational Coefficient | 20 |
| 9. OPTIONAL EXTENSION MODULES | 21 |
| 9.1. Input/Output Module | 21 |
| 9.1.1. Technical Specifications | 21 |
| 9.1.2. I/O Schematic Diagrams | 22 |
| 9.1.3. Input / Output Signals Overview | 22 |
| 9.2. 4-20mA Module | 23 |
| 9.2.1. Technical Specifications | 23 |
| 9.2.2. Wiring Diagrams of 4-20mA Module | 24 |
| 9.3. RS485 Module | 24 |
| 9.3.1. RS485 signals description | 24 |
| 9.4. Ethernet Module | 25 |
| 9.4.1. Ethernet Pins | 25 |
| 9.5. Additional Modules Arrangement | 25 |
| 10. DIAGRAMS OF CONNECTION CABLES | 26 |

1. INTENDED USE

PUE H315 weighing indicator is intended to be a part of construction of industrial scales based on load cells. It is equipped with a stainless steel housing of high IP. Clear weighing result presentation is ensured due to a large display (LCD).

Standard indicator features one RS232 interface and USB connector for connection with peripheral devices (printer, computer, etc.). The indicator can be optionally equipped with an internal battery, this allows its operation in places where there is no access to the mains.

2. WARRANTY CONDITIONS

- A. RADWAG feels obliged to repair or exchange all elements that appear to be faulty by production or by construction.
- B. Defining defects of unclear origin and means of their elimination can only be realized with assistance of manufacturer and user representatives.
- C. RADWAG does not bear any responsibility for damage or losses resulting from unauthorized or inadequate performing of production or service processes.
- D. The warranty does not cover:
 - mechanical damage caused by product exploitation other than intended, damage of thermal and chemical origin, damage caused by lightning, overvoltage in the power network or other random event,
 - inappropriate cleaning habits.
- E. Loss of warranty takes place if:
 - a repair is carried out outside RADWAG authorized service point,
 - service claims intrusion into mechanical or electronic construction by unauthorized people,
 - the device does not bear company protective stickers.
- F. Warranty conditions outline the warranty period for rechargeable batteries attached to the device for 12 months.
- G. For detailed warranty conditions read the warranty certificate.
- H. Contact with the central authorized service: +48 (48) 386 63 30.

3. MAINTENANCE ACTIVITIES

In order to ensure safety in the course of cleaning, it is necessary to disconnect the device from the mains.

3.1. Cleaning Stainless Steel Components

Avoid using cleansers containing any corrosive chemicals, e.g. bleach (including chlorine). Do not use cleansers containing abrasive substances. Always remove the dirt using microfiber cloth to avoid damage of protective coating. In case of a daily maintenance:

1. Remove the dirt using cloth dipped in warm water.
2. For best results, add a little bit of dishwashing detergent.

3.2. Cleaning ABS Components

To clean dry surfaces and avoid smudging, use clean non-colouring cloths made of cellulose or cotton. You can use a solution of water and detergent (soap, dishwashing detergent, glass cleaner). Gently rub the cleaned surface and let it dry. Repeat cleaning process if needed.

In the case of hard to remove contamination, e.g. residues of adhesive, rubber, resin, polyurethane foam etc., you can use a special cleaning agents based on a mixture of aliphatic hydrocarbons that do not dissolve plastics. Before using the cleanser for all surfaces we recommend carrying out tests. Do not use cleansers containing abrasive substances.

4. DESIGN

4.1. Dimensions

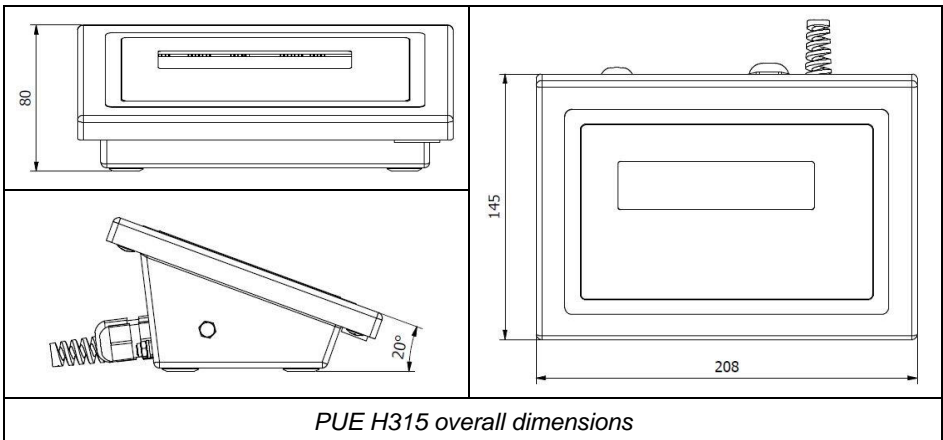

PUE H315 overall dimensions

4.2. Connectors Arrangement

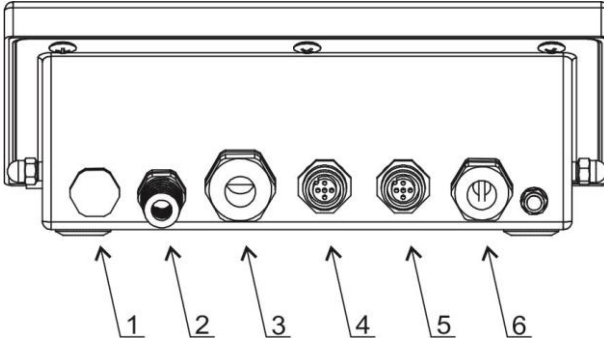

PUE H315 connectors

| | |
|---|--|
| 1 | Vent |
| 2 | Power cord |
| 3 | Platform |
| 4 | USB connector |
| 5 | RS232 (1) connector |
| 6 | Universal socket or gland (RS232 (2) or RS485 or Ethernet or IN/OUT) |





4.3. Pins Arrangement

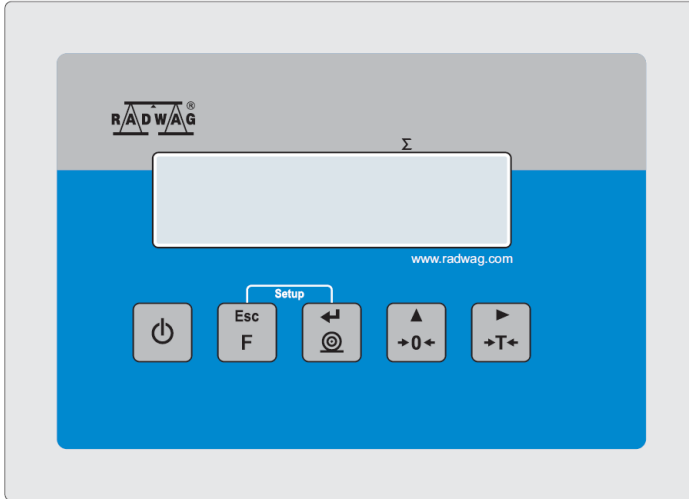



| | | |
|------------------------|--|---|
| RS232 (1) RS232 (2) | | Pin1 – NC Pin2 – RxD Pin3 – TxD Pin4 – NC Pin5 – GND Pin6 – 5VDC Pin7 – NC Pin8 – NC |
| USB | | Pin1 – Vcc Pin2 – D- Pin3 – D+ Pin4 – GND |
| Ethernet | | Pin1 – RX+ Pin2 – TX+ Pin3 – RX- Pin4 – TX- |

4.4. Operation panel



Keys:

| | |
|---|---|
|  | Press to switch the weighing device on/off – hold the key for about 1 second. |
|  | Function key, press to change the working mode. |
|  | Press to send the weighing result to a printer or computer. |
|  | Press to zero the scale. |
|  | Press to tare the scale. |

| | |
|---|--|
|  | <p>Upon pressing  +  keys combination, functions of given keys change. Detailed information concerning use of the  +  keys combination is to be found further down this manual.</p> |
|---|--|

4.5. Technical specifications

| | |
|--|--------------------------|
| Housing | Stainless steel |
| Ingres Protection | IP 66 / IP 67 / IP 69 |
| Operating temperature | -10°C to +40°C |
| Display | LCD |
| Power supply | 100 ÷ 240VAC 50÷60Hz |
| Optional supply | External 12-24VDC |
| OIML Class | II and III |
| Max. of verification interval (n) | 6000 |
| Maximum signal increase | 39mV |
| Min. voltage per verification interval | 0,4uV |
| Min. impedance of load cell | 50Ω |
| Max. impedance of load cell | 1200Ω |
| Load cell supply | 5V |
| Load cell wiring | 4 or 6 wires with shield |
| Max. number of platforms | 1 |
| Multirange | Yes |
| RS232 (1) | M12 8P connector |
| USB | M12 4P connector |

Optional Equipment:

| | |
|---------------------|-------------------------------------|
| RS232 (2) | M12 8P connector |
| RS485 | M16 cable gland |
| Ethernet | M12 4P connector |
| 4-20mA current loop | M16 cable gland |
| 4IN/4OUT | M16 cable gland |
| Battery supply | Rechargeable battery 6 x NiMH AA/R6 |

5. INDICATOR INSTALLATION

5.1. Unpacking and Installation

- A. Take the indicator out of the packaging.
- B. Connect the indicator and the platform and place the set on a flat and even surface. Keep it far away from any sources of heat.
- C. To level the weighing instrument turn its feet. Keep turning the feet until the air bubble takes central position:

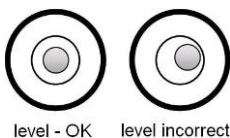

5.2. Start-Up



- Plug the power cord to the mains.
- Press  button. The key is also used to switch the scale on/off.
- Display test proceeds (all symbols are backlit for a moment), program name and number is displayed first, mass indication next.

5.3. Battery Charge Status

The scale of standard design is equipped with an internal battery. Battery state is signalled by  pictogram, the pictogram is displayed in the top bar of the display.

|  pictogram display mode | Meaning |
|--|---|
| No pictogram | Battery charged. Regular scale operation. |
| Pictogram displayed continuously | Too low battery charge (the scale is about to shut down). Charge the battery immediately. |
| Blinking pictogram, blink frequency: ca. 1 s | Battery charge in progress. The device is connected to the power supply charging the battery. |
| Blinking pictogram, blink frequency: ca. 0.5 s | Battery error. Battery is damaged. |

5.4. Battery Charge Status Check















- Press  and  keys combination.
- Depending on the battery state, a respective status is displayed on the screen for 2s:

| | |
|---------------|---|
| 80% | Battery power supply. Battery power given in %. |
| CHARGE | Battery charge in progress. The device is connected to the power supply charging the battery. |
| -Err5- | Battery error. Battery is damaged. |

- Next, the home screen is displayed automatically.

6. OPERATING THE MENU

In order to navigate the program menu use the operation panel.

| | |
|---|--|
|  +  | Press to enter the main menu. |
|  +  | Press to enter tare manually. Press to enter tare from tare database. Press to change value by 1 digit up. Press to scroll the menu up. |
|  +  | Press to check battery/accumulator state. |
|  +  | Press to view date/time. |
|  +  | Press to scroll the menu down. Press to change current parameter value. |
|  +  | Press to enter given submenu. Press to modify given parameter. |
|  | Press to confirm modification. |
|  | Press to exit, function remains unmodified. Press to move one menu level up. |

6.1. Return to the Weighing Mode

Introduced menu modifications are automatically saved to scale memory upon return to the home screen. To return to the home screen press  key repeatedly.

7. INSTALLER INSTRUCTION

The PUE H315 indicator serves as basis of load cell scales.

7.1. Connecting 6-Wire Load Cell

Connect 6-wire load cell to the main board following the diagram below:

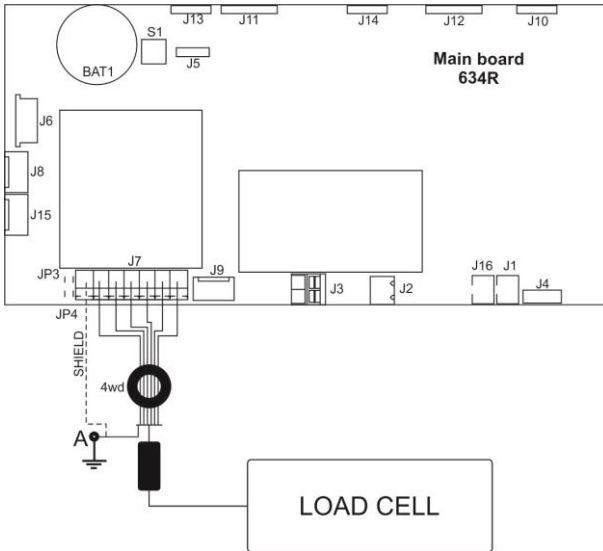

Connecting 6-wire load cells

| J7 Load cell socket | Load cell signals | NOTES |
|---------------------|-------------------|------------------|
| REF+ | SENSE + | JP3 not soldered |
| REF- | SENSE - | JP4 not soldered |
| IN+ | OUTPUT+ | |
| IN- | OUTPUT- | |
| +5V | INPUT+ | |
| AGND | INPUT- | |

7.2. Connecting 4-Wire Load Cell

Connect 4-wire load cell to the main board following the diagram below:

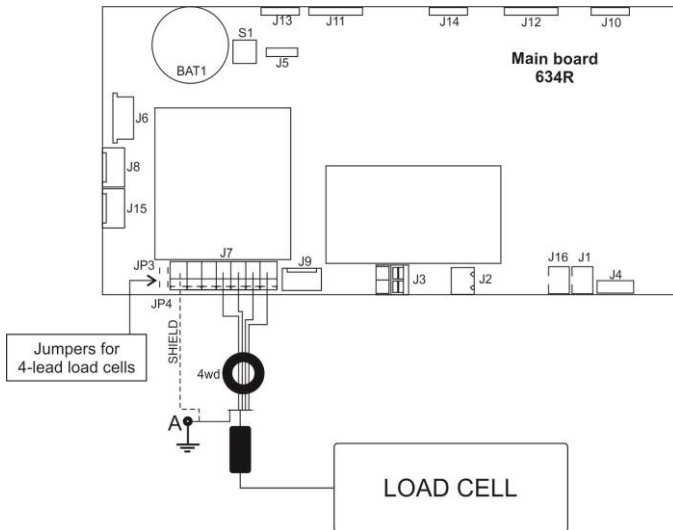

Connecting 4-wire load cells

| J7 Load cell socket | Load cell signals | NOTES |
|---------------------|-------------------|--------------|
| REF+ | SENSE + | JP3 soldered |
| REF- | SENSE - | JP4 soldered |
| IN+ | OUTPUT+ | |
| IN- | OUTPUT- | |
| +5V | INPUT+ | |
| AGND | INPUT- | |

7.3. Connecting Load Cell's Cable Shield



| | | |
|---|---|--|
| | Platforms connected to indicators in metal housing via a cable only | Platforms electrically connected to indicators' metal housings e.g. pillars, racks |
| Load cells with internal shield connection to the load cell body | POINT A | POINT A |
| Load cells without internal shield connection to the load cell body | POINT A | E |

E – Solder pad on the main board and on additional A/D converter boards.

8. FACTORY SETUP



To access and modify both factory settings and parameters that are made available for a user, run Factory Setup mode. Running Factory Setup mode enables the technician to define the balance.

8.1. Access

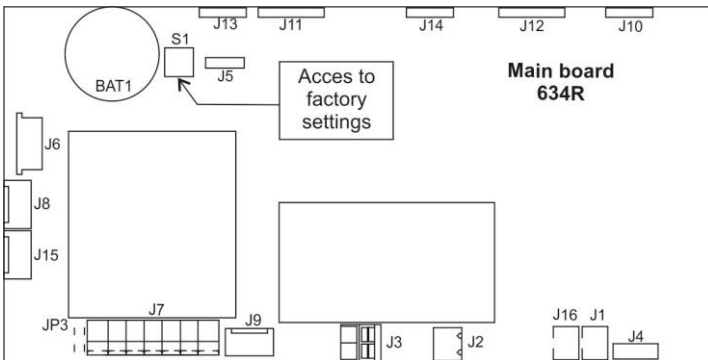
- Switch the weighing device off, to do it press  key.
- Press and hold S1 switch located on the electronics board, while holding the S1 switch, press  key to run the weighing device.



Access to factory setup switch

- Wait as long as the scale restart is in progress.
- Press  and  key combination, message **<P0.Fact>** is displayed.
- Press  key to go to factory parameters' submenu no. 1.



After completed factory parameters setup, restart the weighing device.

8.2. Factory Parameters List

| No. | | Name | Value | Description |
|------------|-------------|-------------|---|---|
| P0. | | FAct | - | Factory parameters |
| | 0.1. | Glob | - | Global parameters |
| | 0.1.1. | duu | - | Defining the weighing device. |
| | 0.1.2. | FAC | | Serial number. |
| | 0.1.3. | tYP | 1, 2, 4, 6, 7, 8, 9, 12 | Weighing device type: 1 - WLC/A2; 2 - WLC/F, WLC/C2, 4 – WTC, 6 – Medical scale, 7 - Medical scale (BMI disabled), 8 – PUE C315; 9 – PUE H315; 12 – WLC/C2. |
| | 0.1.4. | Gcor | 0.9 - 1.1 | Gravity correction factor. |
| | 0.1.7. | tSc | SLA, nInnH, no | Battery selection. |
| | 0.1.8. | CSt | nonE, d, A, V, b, SP, SC, nt | Declaring the customer: nonE - none, d - KERN, A - ADEMI, V - VWR, b - BOECO, SP - Spectrum, SC – Schuller, nt – NEW TECH. |
| | 0.1.9. | rtc | - | RTC synchronisation. |
| | 0.1.A. | ntE | YES, no | US market metrological requirements activation. |
| | 0.2. | nnG | - | Metrology |
| | 0.2.1. | A/d | - | Converter's divisions. |
| | 0.2.2. | Uni | g, kg, lb | Adjustment unit. |
| | 0.2.3. | du1 | 0.0001, 0.0002, 0.0005, 0.001, 0.002, 0.005, 0.01, 0.02, 0.05, 0.1, 0.2, 0.5, 1, 2, 5, 10, 20, 50 | Range 1 reading unit. |
| | 0.2.4. | dE1 | no, 0.001, 0.01, 0.1, 1, 2, 5 | Range 1 verification unit; no - non-verified balance/scale. |
| | 0.2.5. | du2 | 0.0001, 0.0002, 0.0005, 0.001, 0.002, 0.005, 0.01, 0.02, 0.05, 0.1, 0.2, 0.5, 1, 2, 5, 10, 20, 50 | Range 2 reading unit. |
| | 0.2.6. | dE2 | no, 0.001, 0.01, 0.1, 1, 2, 5 | Range 2 verification unit; no - non-verified balance/scale. |
| | 0.2.7. | Ful | - | Maximum range + overload. |
| | 0.2.8. | rn2 | - | Range switching point. |
| | 0.2.9. | uuE | - | External adjustment weight mass. |
| | 0.2.A | uui | - | Internal adjustment weight mass. „ 0 ” - internal adjustment disabled. |





| | | | | | |
|--|-------------|--------|-------------|---|---|
| | | 0.2.b. | Aur | PrF, 0.1d, 0.2d, 0.25d, 0.5d, 0.6d, 0.7d, 0.8d, 0.9d, 1d, 2d, 2.5d, 3d, 4d,5d,6d, 7d, 8d, 9d, 10d | Autozero range: PrF - value taken from program-implemented tables; 0.1d - 10d - value entered directly by a user. |
| | | 0.2.c. | Aut | PrF, 0, 0.2s, 0.4s, 0.6s, 1s, 2s, 3s, 4s, 5s, 6s, 7s, 8s, 9s, 10s, 15s, 20s, | Autozero time: PrF - value taken from program-implemented tables; 0s - 20s - value entered directly by a user. |
| | | 0.2.d. | Str | PrF, 0.1d, 0.2d, 0.25d, 0.5d, 0.6d, 0.7d, 0.8d, 0.9d, 1d, 2d, 2.5d, 3d, 4d,5d,6d, 7d, 8d, 9d, 10d | Stability range: PrF - value taken from program-implemented tables; 0.1d - 10d - value entered directly by a user. |
| | | 0.2.E. | Stt | PrF, 0, 0.2s, 0.4s, 0.6s, 1s, 2s, 3s, 4s, 5s, 6s, 7s, 8s, 9s, 10s, 15s, 20s, | Stability time: PrF - value taken from program-implemented tables; 0s - 20s - value entered directly by a user. |
| | | 0.2.F. | rAn | YES, no, 50%, dEF | Start mass control: YES – range: from -10% to +10% of start mass, no – off, 50% – range: from -50% to +50% of start mass, dEF – range declared in 0.2.G. parameter. |
| | | 0.2.G. | rnt | 10% - 90% | Start mass range in [%]. |
| | | 0.2.H. | Ldn | no, YES | Digit marker for non-verified scales. |
| | 0.3. | | CAL | - | Adjustment |
| | | 0.3.1. | CLE | - | External adjustment process. |
| | | 0.3.2. | Std | - | Determination of start mass for external adjustment. |
| | | 0.3.3. | CLI | - | Internal adjustment process. |
| | | 0.3.4. | Stu | - | Start mass expressed in converter's divisions. |
| | | 0.3.5. | AdF | - | Adjustment factor. |
| | | 0.3.6. | CAC | 0.1, 1, 2, 3, 4, 5, 6, 7, 8, 9, 10, 11, 12. | Setting time interval, in [h], after which internal adjustment is triggered. |
| | | 0.3.7. | CAt | 0.1, 0.2, 0.3, 0.4, 0.5, 0.6, 0.8, 1, 1.5, 2, 2.5, 3, 4, 5, 6, 8, 10 | Setting temperature difference, in [°C], for which internal adjustment is triggered. |
| | | 0.3.8. | CAS | - | Internal adjustment weight weighing procedure. |
| | | 0.3.9. | CAu | - | Internal weight relocation, up-down direction. |
| | | 0.3.A | tP | - | Display of current temperature, in [°C]. |
| | 0.4. | | LinE | - | Linearity |
| | | 0.4.1. | dSG | - | Entering linearity correction points. |
| | | 0.4.2. | dEL | - | Deleting linearity. |

| | | | | |
|-------------|--------|-------------|---------|--|
| | 0.4.3. | Cor | - | Entering correction values for linearity. |
| 0.5. | | Adnn | | Additional modules activation |
| | 0.5.1. | UFA | YES, no | Wireless communication module: YES - enabled, no - disabled. |
| | 0.5.2. | I_O | YES, no | IN/OUT module: YES - enabled, no - disabled. |
| | 0.5.3. | rS3 | YES, no | RS485 module: YES - enabled, no - disabled. |
| | 0.5.4. | EtH | YES, no | Ethernet module: YES - enabled, no - disabled. |
| | 0.5.5. | CL | YES, no | 4-20mA module YES - enabled, no - disabled. |
| 0.6. | | Boot | | Bootloader |
| 0.7. | | dFLt | - | Default settings. |

8.3. Device Defining

Defining the device at the production stage requires entering basic balance/scale parameters: serial number, weighing device type, weighing range.

Procedure:



- Enter factory setup **<P0.FAct>**.
- Go to **<0.1.Glob / 0.1.1.duu>** submenu, text **<Cont?>** is displayed.
- Press  key, text **<nr FAc>** is displayed, next you see window for entering the serial number.
- Enter the serial number, do it using the operation panel.
- Press  key to confirm, text **<type>** is displayed, next you see window for balance/scale type selection.
- Select balance/scale type, do it using operation panel (refer to factory parameters table, section 8.2 of this manual).
- Press  key to confirm, weighing range window is displayed.
- Select appropriate weighing range, do it using the operation panel.
- Press  key to confirm, **<0.1.1duu>** submenu is displayed.
- Exit to home screen, to do it press  key repeatedly.





While defining balance/scale type, additional parameters are set automatically. These are among many battery type, internal adjustment accessibility, additional modules and communication interfaces accessibility.

8.4. Factory Adjustment

8.4.1. External Adjustment Process

- Enter factory setup submenu: **<P.0.FAct / 0.3.CAL>**.
- Enter **<0.3.1.CLE>** function, text **<UnLoAd>** is displayed.
- Unload the weighing pan.
- Press  key, adjustment zero point gets determined.
- With adjustment zero point determined, first text **<LoAd>**, next mass of an adjustment weight that is to be loaded onto the weighing pan is displayed.
- Load the weighing pan with the required adjustment weight.
- Press  key, adjustment starts.
- After adjustment completion, **<0.3.1.CLE>** submenu is displayed automatically.
- Exit to the home screen, to do it press  key repeatedly.



8.4.2. Start Mass Determination

- Enter factory setup submenu: **<P.0.FAct / 0.3.CAL>**.
- Enter **<0.3.2.Std>** function, text **<UnLoAd>** is displayed.
- Unload the weighing pan.
- Press  key, start mass determination starts.
- Upon completed determination process, **<0.3.2.Std>** submenu is displayed.
- Exit to the home screen, to do it press  key repeatedly.



If start mass determination or adjustment factor determination takes more than 360 seconds then <Err8> error is displayed and short sound signal is heard. In such a case the scale requires readjustment/recalibration, perform it providing as stable ambient conditions as possible!





8.4.3. Correction of Start Mass Expressed in Converter's Divisions

- Enter factory setup submenu: **<P.0.FAct / 0.3.CAL>**.
- Enter **<0.3.4.Stu>** submenu, value of start mass expressed in converter's divisions is displayed.
- Correct the value, to do it use operation panel, next press  key to confirm changes.
- Exit to the home screen, to do it press  key repeatedly.

8.5. Linearity Correction

Prior to linearity correction it is necessary to determine real scale characteristics. Correction mechanism allows to enter corrections in 20 points maximum.

8.5.1. Entering Linearity Correction Points

- Enter factory setup submenu: **<P.0.FAct / 0.4.Line / 0.4.1.dSG>**, text **<Cont?>** is displayed.
- Press  key to confirm. Text **<Pnt1>** is displayed (linearity connection point no. 1).
- Press  key, window for entering mass value for linearity correction point no. 1 is displayed.
- Enter the given value, next press  key to confirm, text **<Pnt2>** is displayed (linearity connection point no. 2).
- Press  key, the program automatically suggests value for the next linearity correction point.
- Press  key to confirm the suggested value, or enter a new value (do it using the operation panel).
- Keep repeating this procedure until you enter value close to maximum capacity value.







While attempting to enter correction point value greater than maximum capacity value, <Err Hi> error is signalled.

- In order to finish entering linearity correction points press  key, **<0.4.1.dSG>** submenu is displayed.



8.5.2. Corrections

It is possible to enter extra corrections for declared linearity correction points.

Procedure:

- Enter factory setup submenu: **<P.0.FAct / 0.4.Line / 0.4.3.Cor>**, value of linearity correction point no.1 is displayed.
- Press  key, window for entering correction value for linearity correction point no. 1 is displayed.
- If there is a need to enter negative value, go to the first digit and press  key.
- Press  key to confirm, modified correction point value is displayed.
- Go to the next linearity correction point, to do it press  key.
- Correcting the linearity correction point no. 2 is analogous.
- In order to finish correcting linearity correction points press  key, **<0.4.3.Cor>** submenu is displayed.

8.5.3. Deleting Linearity

- Enter factory setup submenu: **<P.0.FAct / 0.4.Line / 0.4.2.dEL>**, text **<Cont?>** is displayed.
- Press  key to confirm.
- Exit to the home screen, to do it press  key repeatedly.

8.6. Gravitational Coefficient

The function of gravity correction compensates changes of gravity force being a result of different latitude. It allows to carry out correct scale calibration/adjustment away from the place of subsequent use. The value of gravity correction must be entered with reference to tables prepared by „RADWAG Wagi Elektroniczne” or calculated using the below formula:

$$G_{cor} = \frac{g_{uzyt.}}{g_{kal.}}$$

Correction value ranges between 0.90000 ÷ 1.99999.

| | |
|---|---|
|  | <p><i>If the scale is adjusted in the place of use then the value of gravitational coefficient, <0.1.4.Gcr> parameter, must be 1.00000. If the scale is adjusted away from the place of use (longitudinal change) the value must be corrected.</i></p> |
|---|---|

9. OPTIONAL EXTENSION MODULES

9.1. Input/Output Module

The 637R module expands the PUE H315 indicator functionality by additional 4 inputs and 4 outputs. The module is intended to be mounted inside the indicator. It is equipped with optoisolated inputs and semiconductor outputs, and enables free configuration of both the inputs and the outputs (using indicator menu). The indicator's housing cover features an additional cable gland through which 3-metre cable 10 x 0.5 mm² is fed, which cable is terminated with numbered, isolated wires.

9.1.1. Technical Specifications

| Output parameters | |
|--------------------------|---------------------------|
| Output quantity | 4 |
| Output type | Solid-state relay |
| Cable cross-section | 0.14 – 0.5mm ² |
| Maximum output current | 0.5 A DC |
| Maximum output voltage | 30 V DC, AC |
| Input parameters | |
| Input quantity | 4 |
| Input type | Optoisolated |
| Cable cross-section | 0.14 – 0.5mm ² |
| Input voltage range | 5 – 24 V DC |

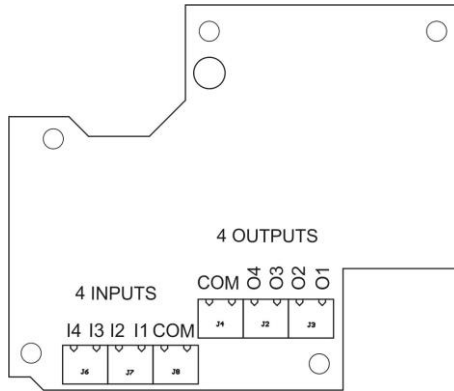

4WE/4WY 637R module

9.1.2. I/O Schematic Diagrams

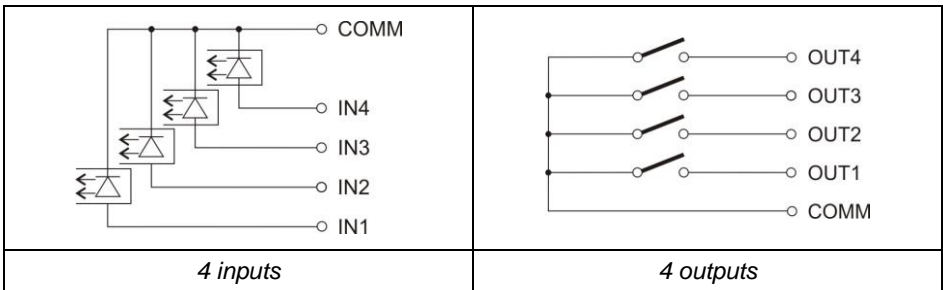

9.1.3. Input / Output Signals Overview

| INPUTS | | OUTPUTS | |
|-------------|---------|-------------|----------|
| Wire number | Signal | Wire number | Signal |
| 1 | IN1 | 6 | OUT1 |
| 2 | IN2 | 7 | OUT2 |
| 3 | IN3 | 8 | OUT3 |
| 4 | IN4 | 9 | OUT4 |
| 5 | COMM_IN | 10 | COMM_OUT |

9.2. 4-20mA Module

The 636R module expands the PUE H315 indicator functionality by 4-20mA analog output. The module is intended to be mounted inside the indicator. The 636R module is a passive module. The indicator's housing cover features an additional cable gland through which 3-metre cable 2 x 0.25 mm² is fed, which cable is terminated with isolated wires.

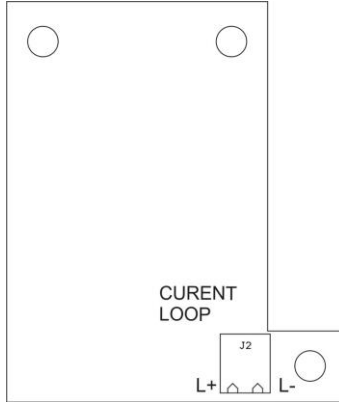

4-20mA 636R module

9.2.1. Technical Specifications

| | |
|----------------------------|----------------|
| Output resolution | 16bit |
| Linearity error | +/- 0,01% |
| Indication error 4mA | +/-0,1% |
| Temperature error for 4mA | +/- 25ppm/C |
| Indication error 20mA | +/- 0,1% |
| Temperature error for 20mA | +/- 25ppm/C |
| Power supply | 24VDC +/- 15% |
| Power loss | 450mW |
| Maximum load resistance | 500Ω |
| Operating temperature | -10°C to +40°C |

9.2.2. Wiring Diagrams of 4-20mA Module

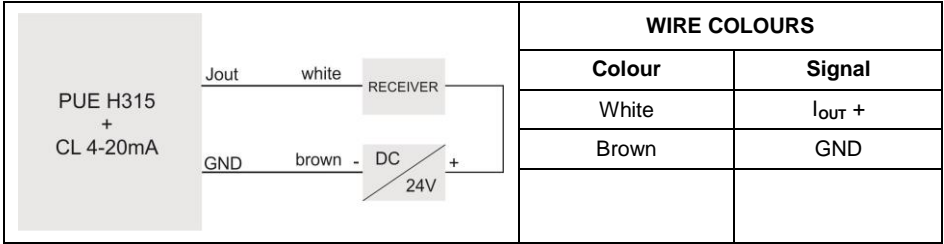

9.3. RS485 Module

The 635R module expands the PUE H315 indicator functionality by RS485 interface. The module is intended to be mounted inside the indicator. The indicator's housing cover features an additional cable gland through which 3m cable is fed.

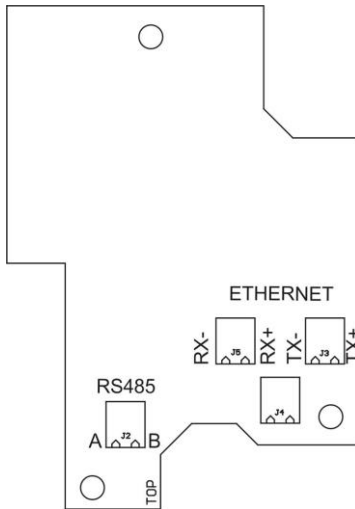

RS485 635R module

9.3.1. RS485 signals description

| Wire Colour | Signal |
|----------------|--------|
| Green | A |
| Orange | A |
| White - green | B |
| White - orange | B |

9.4. Ethernet Module

The 635R module expands the PUE H315 indicator functionality by Ethernet interface. The module is intended to be mounted inside the indicator. The indicator's housing cover features an additional M12 4P D-coded connector (Ethernet standard).

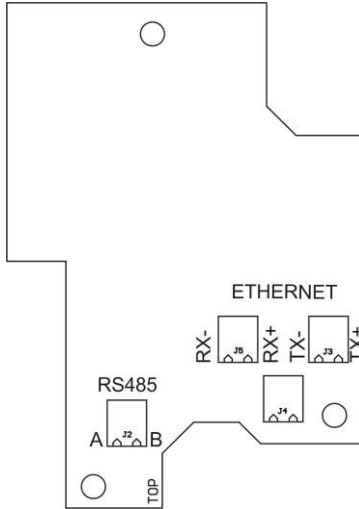

RS485 635R module

9.4.1. Ethernet Pins

| | | |
|----------|--|--|
| Ethernet | | Pin1 – RX+ Pin2 – TX+ Pin3 – RX- Pin4 – TX- |
|----------|--|--|

9.5. Additional Modules Arrangement

635R board includes both RS485 module and Ethernet module. The main board, 634R, can feature all additional modules. The only limitation is the quantity of available cable glands on the back of the indicator.

Exemplary assignment of modules on 634R board:

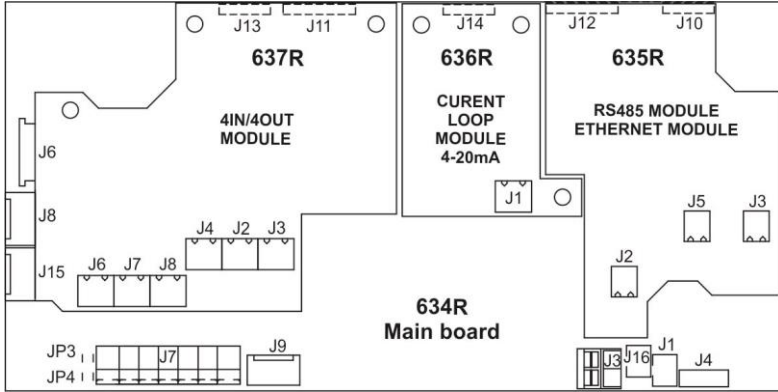

Additional modules arrangement

10. DIAGRAMS OF CONNECTION CABLES

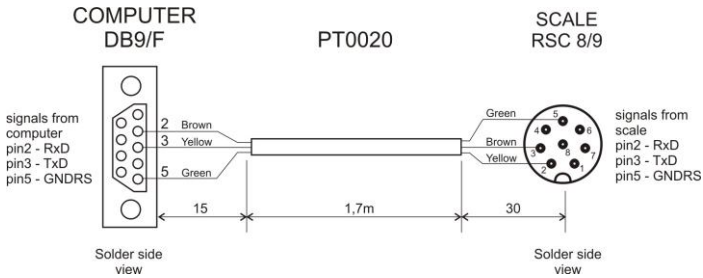

Indicator - computer cable

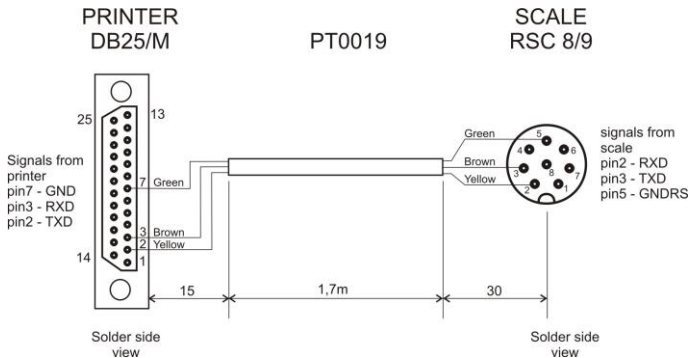

Indicator - printer cable (EPSON)

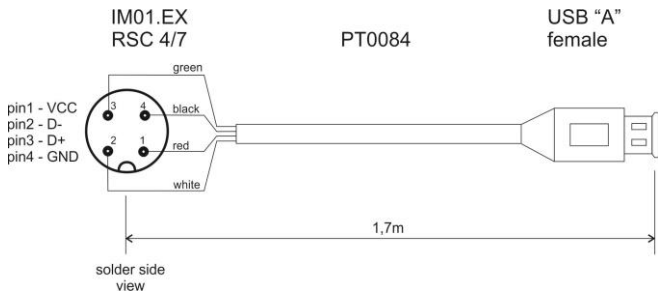

Indicator - USB adapter cable



RADWAG BALANCES AND SCALES
ADVANCED WEIGHING TECHNOLOGIES

