



More information on the website
radwag.com/en/info,w1,H7B

Anti-Draft Chamber



Overview

The anti-draft chamber is intended for balances featuring a weighing pan 128×128 mm. It is an optional equipment for balances operating in unfavourable ambient conditions (air movement air drafts). It is installed as replacement of a standard pan draft shield. The anti-draft chamber features slidable top and side doors ensuring unbounded access to the weighing pan.

Compatible with

PS X2 Precision Balance
PS R1 Precision Balance
PS R2 Precision Balance

WLC X2 Precision Balance
PS X2 Balances for PGC

Device dimensions

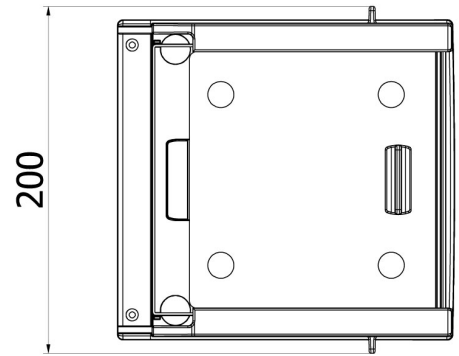
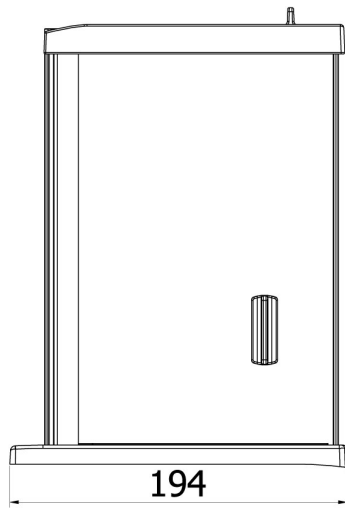
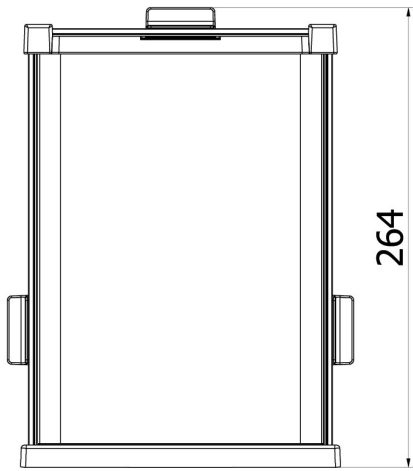

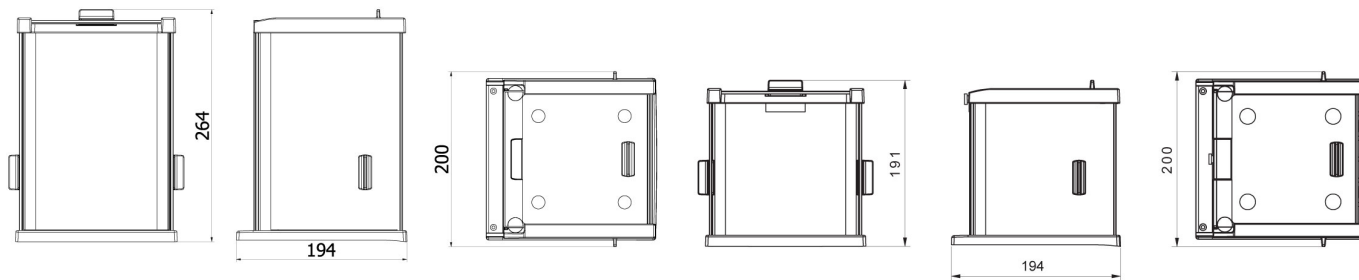

Anti-draft chamber for balances with 128x128 mm weighing pan

Anti-draft chamber for X2 and R2 precision balances

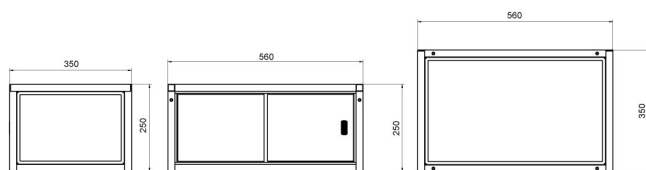

Anti-draft chamber for microbalances

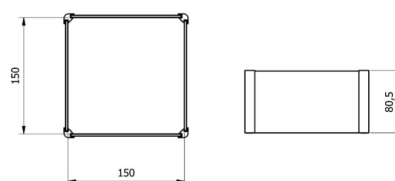

Draft shield for precision balances

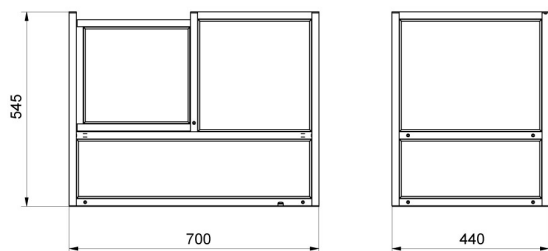

Anti-draft chamber for APP-00-SK mass comparators

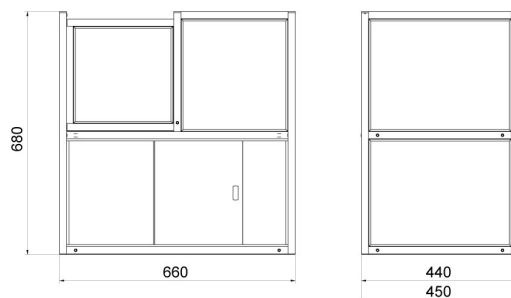

Anti-draft chamber for APP-KO-SK mass comparators

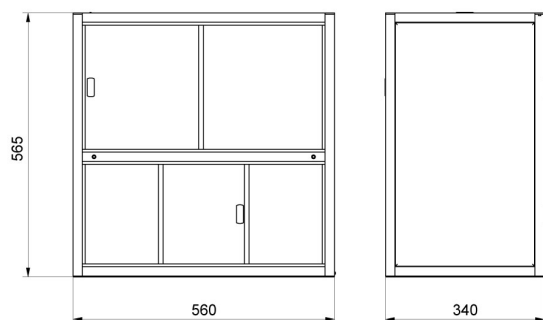

Anti-draft chamber for WAY-KO-SK mass comparators

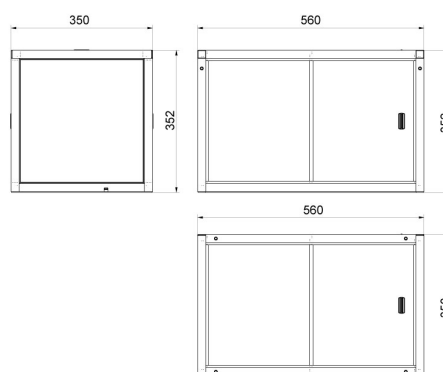

Anti-draft chamber for XA 4Y / XA 4Y PLUS balances