

Service manual

Weighing terminal

PUE 5.15

PUE 5.19

For cooperation with strain gauge load cells

Manual number:

ITKU-84-02-10-13-PL



**MANUFACTURER OF ELECTRONIC
WEIGHING EQUIPMENT**

RADWAG Wagi Elektroniczne, 26 – 600 Radom, Bracka 28, POLAND

Phone: +48 (0-48) 38 48 800, fax. +48 (0-48) 385 00 10

Sales department: +48 (0-48) 366 80 06

export@radwag.com

www.radwag.com

OCTOBER 2013

Table OF CONTENTS

1. INTENDED USE	5
2. PRECAUTIONS MEASURES	5
3. WARRANTY CONDITIONS	6
4. UNPACKING AND INSTALLATION	6
5. TERMINAL CONSTRUCTION	7
5.1. Overall dimensions	7
5.2. Description of ports	9
6. WEIGHING MODULE MW-04	11
7. INTERFACES MODULE	11
7.1. Configuration of COM serial ports	12
7.2. RS485 – COM2	13
8. STARTUP	13
9. STRUCTURE OF „MwManager” PROGAM	13
9.1. MwManager start-up	14
9.2. Parameters edition	15
9.3. Weighment display	17
9.4. Application settings	18
9.4.1. Connection settings	18
9.4.2. Language	21
9.4.3. Other	22
9.5. Parameters	23
9.5.1. User parameters	23
9.5.2. Communication settings	24
9.5.3. INPUT/OUTPUT functions	26
9.5.4. Available platforms preview	28
9.5.5. Available A/D converters preview	29
9.6. Functions	30
9.6.1. Dosing	30
9.6.2. Checkweighing	34
9.6.3. Input/Output state	35
10. WEIGHMENT	36
10.1. Terms of use	36
10.2. Scales zeroing	37
10.3. Taring	37
10.4. Weighment for dual range scales	38
10.5. Measuring unit change	38
11. SCALES PARAMETERS	39
11.1. Autozero function	40
11.2. Median filter	40
11.3. Filter	41
12. CHECKWEIGHING	42
12.1. LO threshold	42
12.2. MIN/MAX threshold	43
13. DOSING	44
14. PARAMETERS SAVED TO FILE	46
14.1. Save to file	47
14.2. Read from file	48
15. OFFLINE MODE	49

16. ERROR MESSAGES	52
17. CABLES DIAGRAMS	52
17.1. USB cable for a printer.....	52
17.2. Cable RS232 for EPSON, CITIZEN printer	53
17.3. Cable RS232 terminal – computer	53
17.4. Cable RS232, RS485.....	53
17.5. Ethernet cable.....	54
18. EXTRA MODULES SPECIFICATION	54
18.1. A/D converter	54
18.1.1. Technical specification of A/D converter.....	56
18.1.2. Strain gauge load cells connection	56
18.2. 4 inputs / 4 outputs module	59
18.2.1. Technical parameters of 4IN/4OUT module	59
18.2.2. Input/output schematic diagram	60
18.2.3. 4IN/4OUT in sockets	60
18.2.4. 4IN/4OUT through cable gland	60
18.3. Profibus	61
19. TECHNICAL PARAMETERS	63
20. EXTRA EQUIPMENT	64

1. INTENDED USE

PUE 5.15, PUE 5.19 terminals are designed for scales that work with strain gauge load cells. The terminals' housing is made of stainless steel. PUE 5.15, PUE 5.19 are intended to be used in industry.

A big colourful screen of the terminal with a touch panel makes the software operation much more comfortable since there is no need to use a keyboard.

PUE 5 terminal is a genuine device that consists of two units: the computer and the weighing module, placed in one housing. Both of these units are connected via an internal interface. The possibility of using common operating systems allows external companies to create its software or to use the existing one.

Such common devices as PC computers can be used with the terminal, which is a great advantage while creating a network. Individual workstation with the PC device is as well possible.

The terminal can work with 4 weighing platforms (option).

2. PRECAUTIONS MEASURES

- A. Before the first use read the Service Manual carefully and follow the instructions. Use the device as intended.
- B. The weighed products should be placed in the central part of a scales pan.
- C. Do not use any means causing corrosion for cleaning.
- D. The gross mass of weighed products must be lower than the scales maximum load.
- E. Great loads shouldn't be left on the scales pan too long.
- F. In case of a failure the device power supply should be instantly switched off.
- G. If the device is to be put out of operation it must be utilized in accordance with the actual law regulations.

3. WARRANTY CONDITIONS

- A. RADWAG company will repair or replace the elements that turn out to be faulty in terms of production or construction.
- B. Agreeing on the ways of any defects elimination in case of their unclear origin can be done only in presence of the producer and the user representatives.
- C. RADWAG is not responsible for any loss or damages in case of unauthorized or incorrect execution of production or service processes.
- D. Warranty does not cover:
 - Mechanical defects caused by product exploitation other than intended, defects of thermal and chemical origin, defects caused by lightning, overvoltage in the power network or other random event,
 - maintenance (the cleaning process).
- E. Loss of warranty takes place if:
 - A repair is carried out outside RADWAG sales office or authorized service point,
 - Service claims intrusion into mechanical or electronic construction by unauthorized people,
 - The device does not bear company's protective stickers.
- F. Detailed warranty conditions are listed on a service card.
- G. Authorized Service phone number:
(0-48) 384 88 00 extension numbers: 106 and 107.

4. UNPACKING AND INSTALLATION

- A. Take terminal out of its factory packaging.
- B. Connect the terminal to a weighing platform and place it on a smooth, even, thick surface away from any heat sources,
- C. It is necessary to level scales. Turn right and left the levelling feet. The correct levelling is obtained when an air bubble is placed in a centre of the small ring.



5. TERMINAL CONSTRUCTION

5.1. Overall dimensions

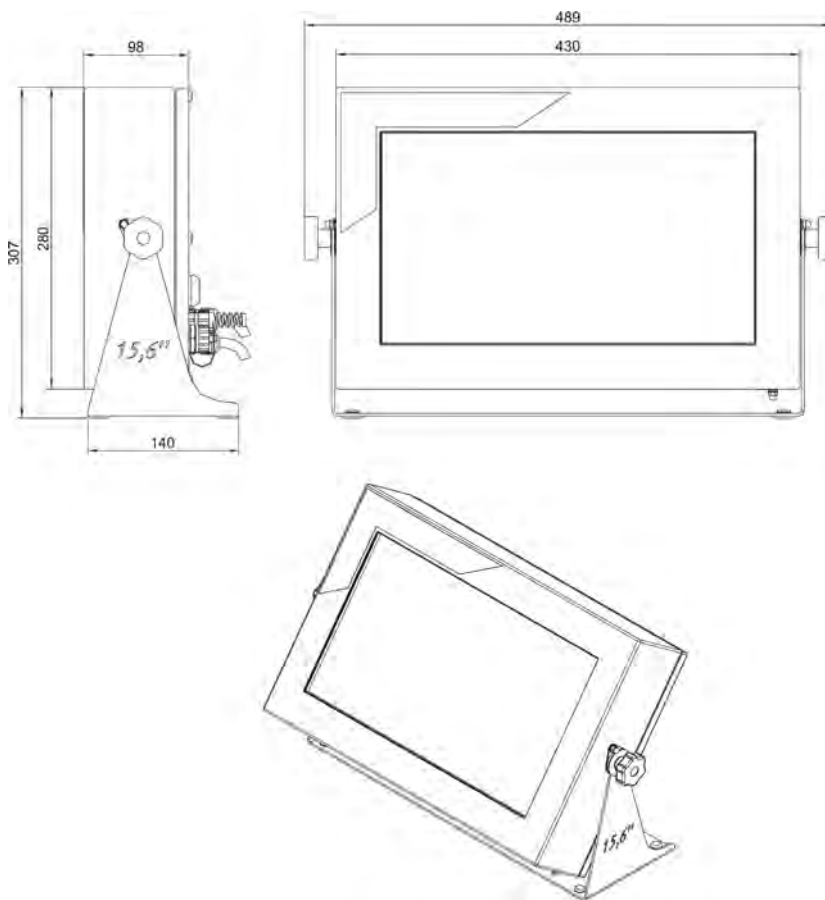

Fig.1 PUE 5.15 terminal dimensions

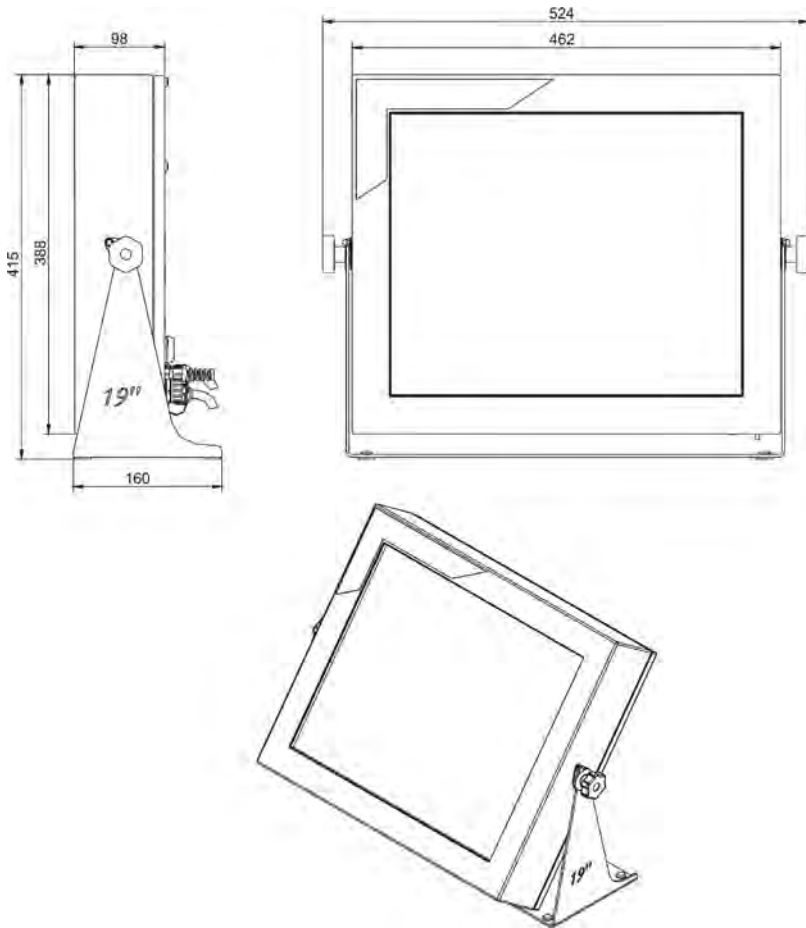

Fig.2 PUE 5.19 terminal dimensions

5.2. Description of ports

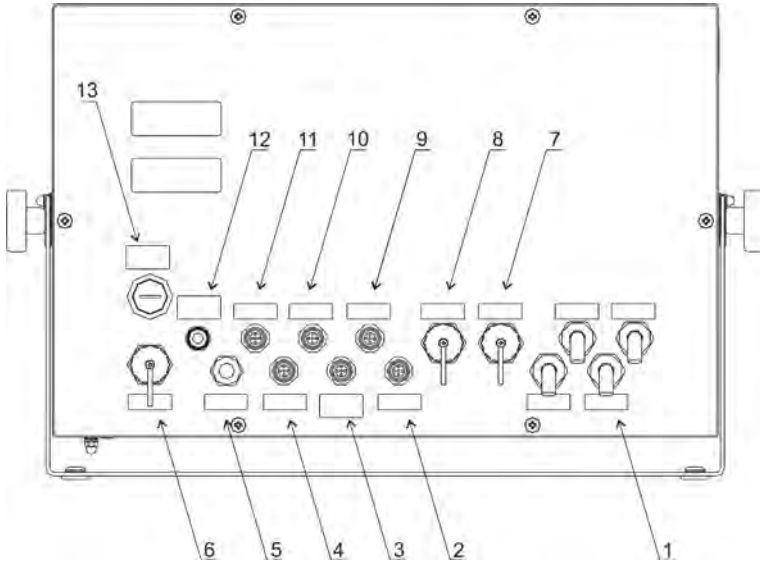
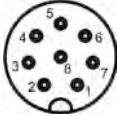

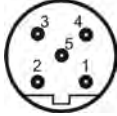
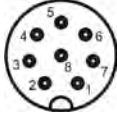
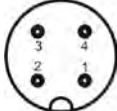
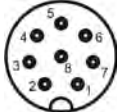
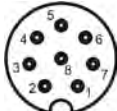

Fig.3 Back board view of PUE 5.15, PUE 5.19

- 1 Cable gland of the strain gauge load cell (x4items)
- 2 USB M12 4 pin port
- 3 RS232 port
- 4 4WY port (option)
- 5 Cable gland for the cable RS485 (option)
- 6 Panel USB port
- 7 Panel USB port
- 8 RJ45 ethernet port
- 9 USB M12 4 pin port
- 10 RS232, RS485 or 2xPROFIBUS (IN, OUT) port
- 11 4WE port (option)
- 12 Power supply cable gland
- 13 ON/OFF power switch-key

- Standard version ports:
 - Power supply cable: through PG7 cable gland,
 - Weighing platform cable: through PG11 cable gland,
 - RS232, RS485: M12 8pin ports,
 - Ethernet: RJ45 port,
 - USBx2: M12 4pin port,
 - USBx2: type A panel port
- Depending on the version of the terminal PUE 5.15, PUE 5.19 it is possible to optionally equip it with the following ports:
 - Extra weighing platforms
 - Ethernet cable through the PG9 cable gland
 - Cable RS485 through the PG9 cable gland
 - 4WE/4WY cable through the PG9 cable gland
 - 4 IN/4OUT in M12 5 pin connector
 - Profibus communication module
- Ports typology

RS232, RS485		Pin1 – B (RS485) Pin2 – RxD Pin3 – TxD Pin4 – A (RS485) Pin5 – GND Pin6 - +5VDC Pin7 – NC Pin8 – NC
PROFIBUS IN (male)		Pin1 – NC Pin2 – A Pin3 – NC Pin4 – B Pin5 – NC
PROFIBUS OUT (female)		Pin1 - +5V Pin2 – A Pin3 – GND Pin4 – B Pin5 – NC
RS232		Pin1 – NC Pin2 – RxD Pin3 – TxD Pin4 – NC Pin5 – GND Pin6 - +5VDC

USB		Pin1 – Vcc Pin2 – D- Pin3 – D+ Pin4 – GND
Ethernet	RJ45	Standard RJ45
USB panel	USB A	Standard USB A
4WE		Pin1-WE1 Pin2-WE2 Pin3-WE3 Pin4-WE4 Pin5-COMM Pin6-+24VDC Pin7-GND
4WY		Pin1-WY1 Pin2-WY2 Pin3-WY3 Pin4-WY4 Pin5-COMM Pin6-+24VDC Pin7-GND

Caution:

Depending on how many extra modules have been installed the number of ports and cable glands and their position may change.

6. WEIGHING MODULE MW-04

PUE 5 weighing terminal is equipped with weighing module MW-04. It can serve as a fully functional scales without a screen. Its parameters are kept in a permanent storage of the module. It communicates with an internal PC module via RS232 (COM6) interface.

„**MwManager**” program serves to maintain weighing module MW-04. Its description is to be found further down this User Manual.

7. INTERFACES MODULE

Interfaces module allows connection of terminal ports and sockets that are available on its back board. Weighing module MW-04 – RS232 (COM6) is also connected to the Interfaces module.

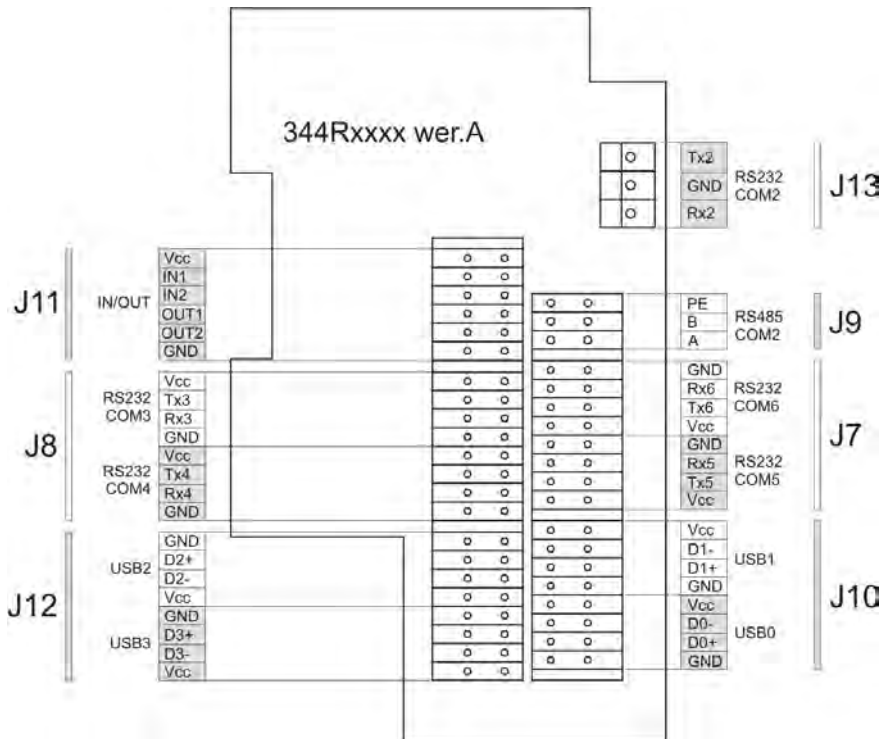



Fig.4 Interfaces module TOP view

7.1. Configuration of COM serial ports

Chart below presents assignment of COM ports detectable by Windows operating system to proper ports of a terminal back board.

Caution:

- Weighing module MW-04 communicates with a PC module by COM6
- Chart presents factory assignment of COM ports, detectable by Windows operating system
- Any changes of COM ports assignment in Windows operating system may result in faulty functioning of applications installed on a terminal.

Socket	Pins view	COM
RS232 RS485		RS232 – COM3 RS485 – COM2
RS232		RS232 – COM5
MW-04 module (J6 on 334Rxxxx board)		RS232 – COM6

7.2. RS485 – COM2

COM2 can be configured as RS485 or RS232. By default it is configured as RS485 (standard positioning of the ports).

In this case COM2 available on the J7 port of 344Rxxxx interfaces module is not active.

8. STARTUP

- Press **ON/OFF** button to turn on the device. The button is placed at the back of the terminal housing.
- Wait for the operating system loading procedure to start.
- Operating system Windows activates automatically after the loading procedure has finished.

9. STRUCTURE OF „MwManager” PROGRAM

„MwManager” is a basic application installed on a terminal. It operates a weighing module. This application serves as a display and a control panel. It enables the scales maintenance and configuration.

The program enables reading of the mass, taring, zeroing, filtering, input/output simulation and dosing function simulation for a given weighing platform. Besides it enables setting input/output functions, which may be assigned to a particular platform.

Caution:

1. The manual complies with **1.0.3.1** version of „**MwManager**” program (and the following versions) and with weighing module MW-04 – version **1.1** and following versions.
2. Pressing the **Save** button saves all the changes in the weighing module. All temporary parameters that haven't been saved permanently into the module are marked with red colour.
3. The view of some windows of the „**MwManager**” program depends on the number of operated A/D converter connected with the weighing platforms and their configuration in the weighing module MW-04.

9.1. MwManager start-up



To start the program press **MwManager** icon, or use **START/PROGRAMS/MwManager** menu of Windows system.

Wait to see a main window of the program.

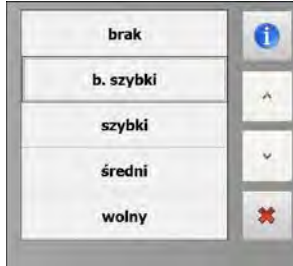



Fig.5 Main window of the program

9.2. Parameters edition





Parameters edition depends on a parameter type, to do it:

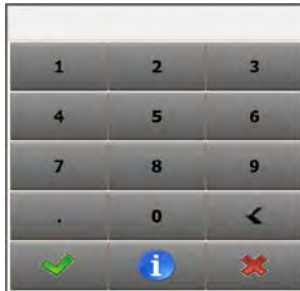

- Press  button and choose a demanded menu out of a list.







- Click a window of a given parameter  and use a program keyboard to write a value.



- Press a button responsible for decrease  of a parameter value or its increase  ,    [s].

- Press  button to select a given option, press  button to unselect it.

Functions of the key buttons:

	-	Confirmation of a change of a parameter
	-	Canceling change of a parameter
	-	Scrolling the list of available parameter values up
	-	Scrolling the list of available parameter values down
	-	Information button, displays information about settings of a given parameter

Saving the settings:

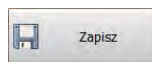

Changes will be stored in a weighing module after **Save button** has been pressed. All temporary parameters that haven't been saved permanently will be marked with a red colour.

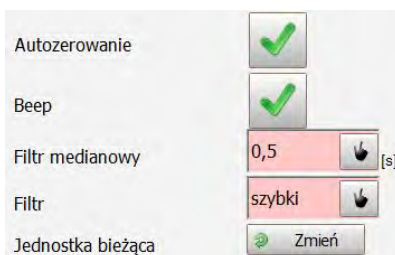

Procedure:

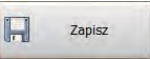
- Press **Save button** ,
- When you see a following message press **<YES>**

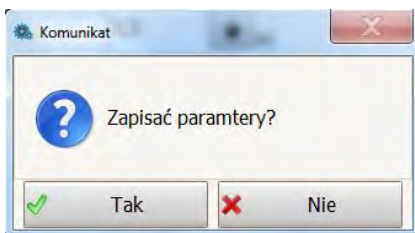

- You will see the confirmation message:

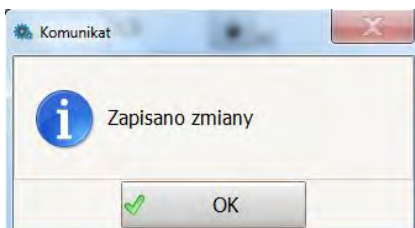

- Press <OK>,
- Changes have been saved in a permanent storage of a weighing module.

If any setting changes will be done but not saved the user may press

Refresh button  to view the present settings.

9.3. Weighment display



Fig.6 Weighment display view



Symbols:

- 0 ← - exact zero
- ▾ ▾ - stable measurement result

kg - weighing unit

 - weighing platform number

Functions of the key buttons:

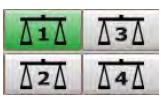
	-	Zeroing
	-	Taring
	-	Selection of a weighing platform (when a module works with more than one platform). Green colour indicates the presently operated platform.

Caution:

Zeroing and taring function is available for a presently operated platform.

9.4. Application settings

Application settings bookmark contains: settings of connection with a weighing module, list of available program interface languages and other

options 

9.4.1. Connection settings

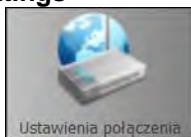

Connection settings  button, located in application settings

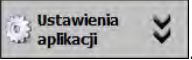
bookmark , starts settings of connection with a weighing module.

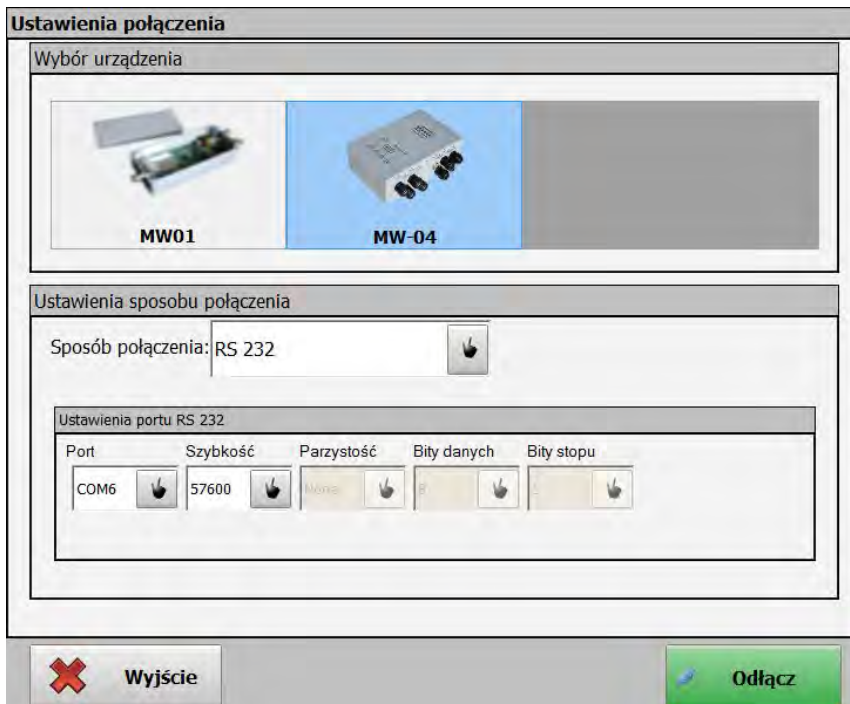



Fig.7 Connection settings window



Press MW-04 button to connect to module MW-04. This button is located in a “device selection” bookmark.

Description:

Device selection	The device to which the user wants to connect
 <p>MW01</p>	weighing module MW-01
 <p>MW-04</p>	weighing module MW-04 To be selected in case of cooperation with weighing module MW-04

Connection types	Selection of interface connection with a weighing module
RS 232	Connection via RS232 port
TCP/IP	Connection via Ethernet network
RS 485	Connection for RS 485 network
Offline	Offline mode is used for saving and edition of all indispensable parameters. Saving and edition is carried out in a configuration file.

RS232:

Port	Choice of COM port number to which the module is physically connected
Speed	Transmission speed of RS232 communication port By default 57600 bps
Parity	Parity state. By default „none” (not editable value)
Data bits	Number of data bits. By default 8 data bits (not editable value)
Stop bits	Number of stop bits. By default 1 stop bit (not editable value)

TCP/IP:

IP address	Device IP address, by default 192.168.0.2
Port	Port set in the weighing module, by default 4001

RS485:

Port	Choice of COM port number to which a module is physically connected
Speed	Transmission speed of RS485 communication port By default 57600 bps
Parity	Parity state. By default „none” (not editable value)
Data bits	Number of data bits. By default 8 data bits (not editable value)
Stop bits	Number of stop bits. By default 1 stop bit (not editable value)
Address	Weighing module IP address

Caution:

1. *Weighing module MW-04 used in PUE 5 terminal communicates with an internal PC module of the terminal via RS232 interface of COM6 port, with the default transmission speed of **57600** bit per second.*
2. *Parameters **<Connection settings>** are not active in case of connection with the weighing module.*

Description of buttons:



Connecting with a module. After the connection has been established the button function switches from “**Connect**” to “**Disconnect**” and its colour changes from red to green.



Disconnecting from a module. In case of accidental disconnection the button’s function switches to „**Connect**” and the colour changes to red again.



Closing „**MwManager**” application.

9.4.2. Language

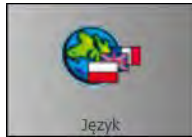

Language button, which is located in application settings

bookmark , opens the window of language settings.



Fig.8 Language settings window

After selection of a language version press **Apply** button  in order to save changes. Present version of the program offers following languages:

- English
- Polish

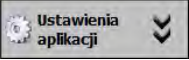
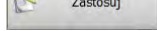

9.4.3. Other

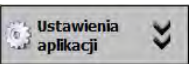

Other button, which is located in application settings

bookmark , lets to operate other available options.

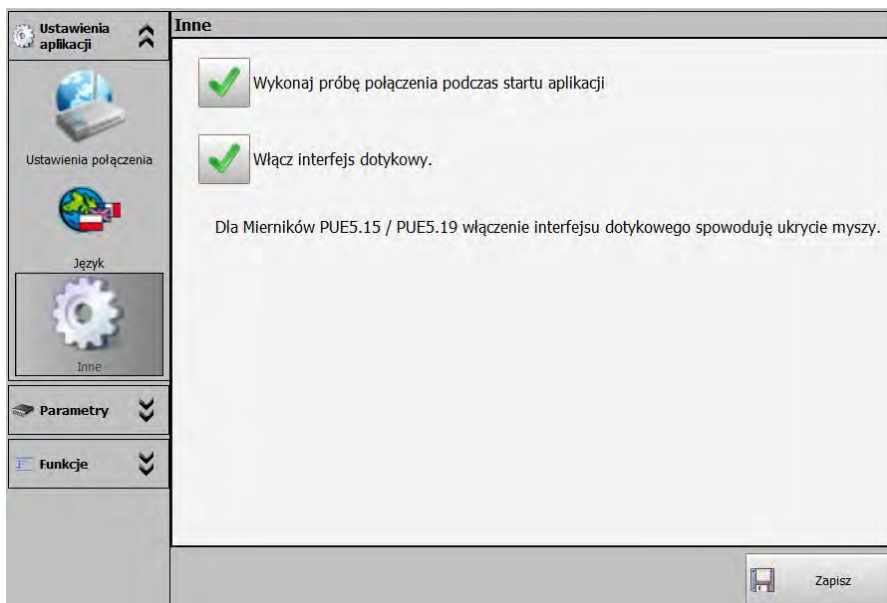

Fig.9 Other options window

„Carry out a test connection during the application starting procedure”

– this option enables the program to automatically connect with the weighing module. It connects either by its default type of connection or the recently chosen one.

„Turn on a touch interface” – this option adapts a visual image of **”MwManager”** program to make it able to work with PUE5 weighing terminal, it turns on a touch panel and it turns off a mouse.

After setting the options press **Save** button

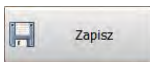

in order to save introduced changes.

9.5. Parameters

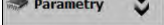
Parameters bookmark  contains user parameters, weighing module communication parameters, INPUT/OUTPUT functions and a preview of available scales platforms and A/D converters.

9.5.1. User parameters

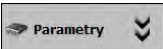

User parameters button , which is located in **Parameters**

bookmark  opens a user parameters window. These parameters are an active platform parameters, they can be edited by each of the users.

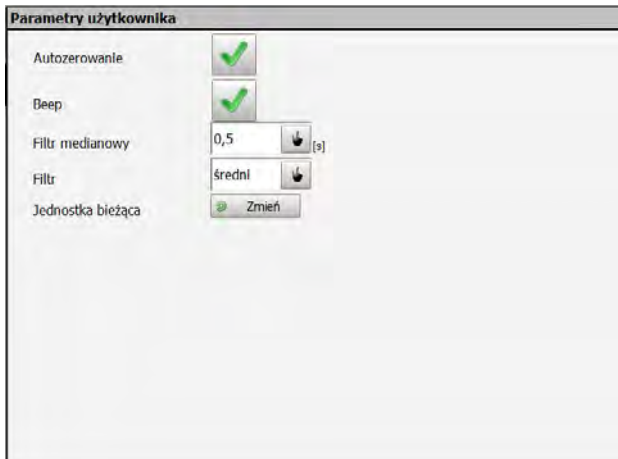

Fig.10 User parameters window

List of user parameters:

Autozeroing	-	Turning on/off autozeroing function
-------------	---	-------------------------------------

Beep	-	Sound signal (unavailable for MW-04 module)
Median filter	-	Median filter value settings None – median filter turned off
Filter	-	The moving average filter speed settings None – filter turned off
Current unit	-	Change of a current unit

Caution:

When few platforms are being operated by MW-04 module at one time, only parameters for a selected platform are displayed and can be edited .



9.5.2. Communication settings



Communication button, which is located in **Parameters**

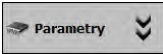

bookmark opens a weighing module parameters window. These parameters can be viewed and edited by each of the users who connect to the weighing module.

- **Ethernet**

Komunikacja

Ethernet RS 232/485

Adres IP	192.168.0.2
Maska podsieci	255.255.255.0
Brama domyślina	192.168.0.1
Port	4001 < >
Timeout	0 < > [s]

Fig.11 Ethernet communication parameters window

Description of fields:

IP address	-	Device IP address, by default 192.168.0.2
Subnet mask	-	Ethernet subnet mask, by default 255.255.255.0
Default gateway	-	Ethernet default gateway, by default 192.168.0.1
Port	-	TCP communication port, by default 4001 .
Timeout	-	Number of seconds of the device inactivity that results in disconnection of the device, number of seconds ranges from 0 to 300 [s].

- **RS 232/485**

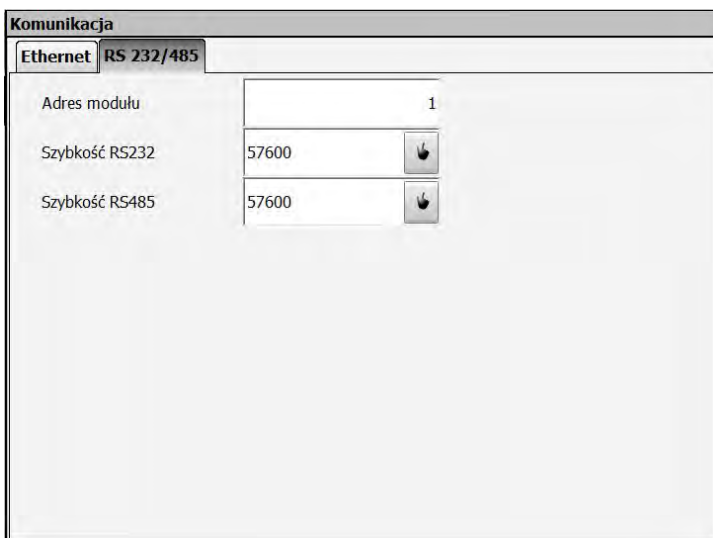

Fig.12 RS communication parameters window

Description of fields:

Module address	-	Weighing module address on RS485 network (a separate IP address is given to each of the network devices), default value is 1. Values range from 1 to 254.
Speed RS232	-	RS232 communication interface speed transmission. By default 57600 bps

Speed RS485	-	RS485 communication interface speed transmission. By default 57600 bps
-------------	---	---

To save changes of communication parameters it is necessary to execute restarting procedure of a weighing module.

One must remember that new parameters have to be written in the *Connection settings window*. See point 9.4.1 of this manual.

Caution:

*Internal weighing module MW- 04 used in the PUE5 terminal is physically connected to the PC module of the terminal via RS232 interface of COM6 port and it works with a default transmission speed of **57600** bps.*

9.5.3. INPUT/OUTPUT functions.

Weighing module MW-04 can have up to 4 inputs and 4 outputs.



INPUT/OUTPUT button **Funkcje We/wy**, which is located in **Parameters**

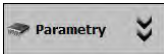

bookmark opens a window allowing the user for configuration of weighing module Inputs and Outputs. Select number of scales/platform for which the function is to be realized.

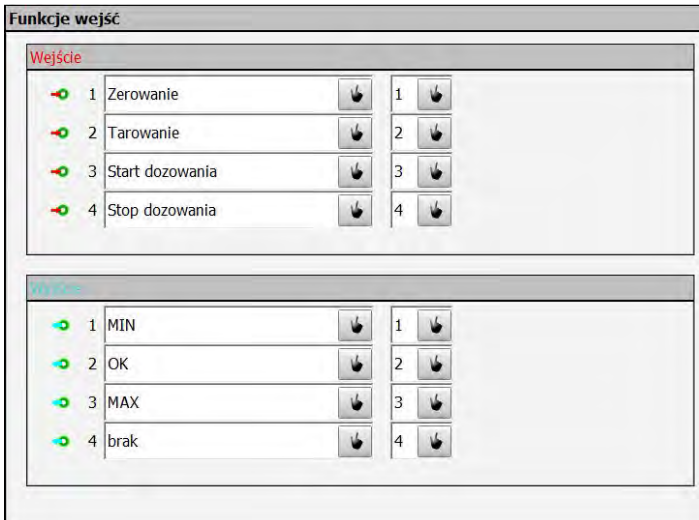

Fig. 13 Inputs/Outputs configuration window

- **Inputs configuration** 

Inputs functions:

None	Inactive Input
Taring	Selected platform taring
Zeroing	Selected platform zeroing
Dosing Start	Start of a dosing process for a selected platform
Dosing Stop	Stop of a dosing process for a selected platform

- **Outputs configuration** 

Outputs functions:

None	Inactive Output
Stable	Stable weighing result over the LO mass, on a selected platform
Stable MIN	Stable weighing result over LO mass and below MIN threshold, for a selected platform
MIN	Unstable weighing result over LO mass and below MIN threshold, for a selected platform
Stable OK stabilny	Stable weighing result between MIN and MAX thresholds, for a selected platform
OK	Unstable weighing result between MIN and MAX thresholds, for a the selected platform
Stable MAX	Stable weighing result over MAX threshold, for a selected platform
MAX	Unstable weighing result over MAX threshold, for a selected platform

Caution:

If the user sets a function for a given Output and if at the same time on this Output a function of fast dosing or fine dosing is set then upon start of a dosing and during its duration the outputs will be activated according to dosing parameters settings. After the process has finished the set functions will swap to Output.

9.5.4. Available platforms preview



The button , which is located in **Parameters** bookmark

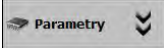

opens scales windows preview of all the scales being operated by MW-04 module. For each platform the following information is displayed: A/D converter(s) divisions, calibration coefficient and an input mass.

Caution:

Window preview depends on the number of A/D converters, the number of platforms connected to the device and their configuration.

4			
 <div style="text-align: center; font-size: 24pt; font-weight: bold;">0.004</div> <div style="text-align: right; font-size: 12pt;">11 kg</div> <div style="display: flex; justify-content: space-around; margin-top: 5px;"> <div style="text-align: center;">   </div> <div style="text-align: center;">ADC 1</div> </div>	Dziełki przetwornika Współczynnik kalibracji Masa startowa	<div style="border: 1px solid gray; padding: 2px; text-align: center;">18331</div> <div style="border: 1px solid gray; padding: 2px; text-align: center;">1378820</div> <div style="border: 1px solid gray; padding: 2px; text-align: center;">12281</div>	
 <div style="text-align: center; font-size: 24pt; font-weight: bold;">0.013</div> <div style="text-align: right; font-size: 12pt;">22 kg</div> <div style="display: flex; justify-content: space-around; margin-top: 5px;"> <div style="text-align: center;">   </div> <div style="text-align: center;">ADC 2</div> </div>	Dziełki przetwornika Współczynnik kalibracji Masa startowa	<div style="border: 1px solid gray; padding: 2px; text-align: center;">69783</div> <div style="border: 1px solid gray; padding: 2px; text-align: center;">646125</div> <div style="border: 1px solid gray; padding: 2px; text-align: center;">61062</div>	
 <div style="text-align: center; font-size: 24pt; font-weight: bold;">0.262</div> <div style="text-align: right; font-size: 12pt;">31 kg</div> <div style="display: flex; justify-content: space-around; margin-top: 5px;"> <div style="text-align: center;">   </div> <div style="text-align: center;">ADC 3</div> </div>	Dziełki przetwornika Współczynnik kalibracji Masa startowa	<div style="border: 1px solid gray; padding: 2px; text-align: center;">685045</div> <div style="border: 1px solid gray; padding: 2px; text-align: center;">2111222</div> <div style="border: 1px solid gray; padding: 2px; text-align: center;">131368</div>	
 <div style="text-align: center; font-size: 24pt; font-weight: bold;">0.000</div> <div style="text-align: right; font-size: 12pt;">43 kg</div> <div style="display: flex; justify-content: space-around; margin-top: 5px;"> <div style="text-align: center;">   </div> <div style="text-align: center;">ADC 4</div> </div>	Dziełki przetwornika Współczynnik kalibracji Masa startowa	<div style="border: 1px solid gray; padding: 2px; text-align: center;">20773</div> <div style="border: 1px solid gray; padding: 2px; text-align: center;">91099,34</div> <div style="border: 1px solid gray; padding: 2px; text-align: center;">20693</div>	

Fig. 14 Example of 4 weighing platforms preview window

9.5.5. Available A/D converters preview

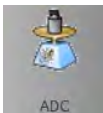

ADC button , which is located in **Parameters** bookmark

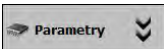

opens a preview of reading units, calibration coefficient, mass, correction coefficient and input mass of the available A/D converters.

Caution:

Window preview depends on the number of A/D converters, the number of platforms connected to the device and their configuration.

ADC			
>>1<<	2	3	4
Działki przetwornika 981866	Działki przetwornika 981866	Działki przetwornika 981866	Działki przetwornika 981866
Współczynnik kalibracji 599908,5	Współczynnik kalibracji 607110	Współczynnik kalibracji 417978,7	Współczynnik kalibracji 627942,5
Działki przetwornika Masa Współczynnik korekcji Masa startowa	981853 0.000 1 879251	ADC 1	

Fig.15 A/D converter divisions preview window

9.6. Functions

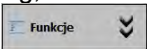
Dosing, checkweighing, state and Input/Output simulations are set in functions bookmark .

9.6.1. Dosing

Dosing button

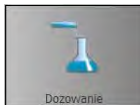

, which is located in **Functions** bookmark

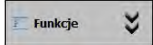

opens a windows with settings for a dosing process of a weighing platform (presently selected one).

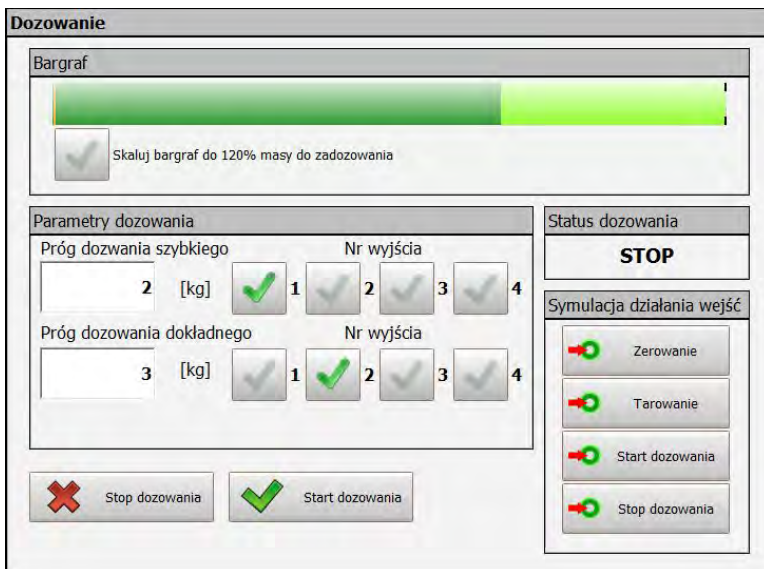

Fig.16 Dosing parameters window

- **Bargraph**

Dosing window contains a graphic bar that visualizes mass readout within a weighing range of a weighing module.

Bargraph can be graduated upto 120% of an extreme dosing threshold if a fine dosing threshold option has been selected. If a fine dosing threshold option is turned off then the bargraph is graduated in accordance with a fast dosing threshold.



Fig.17 Graduation of bargraph for a fast dosing threshold

Parametry dozowania	
Próg dozowania szybkiego	Nr wyjścia
<input type="text" value="50"/> [kg] <input checked="" type="checkbox"/>	<input checked="" type="checkbox"/> 1 <input type="checkbox"/> 2 <input type="checkbox"/> 3 <input type="checkbox"/> 4
Próg dozowania dokładnego	Nr wyjścia
<input type="text" value="120"/> [kg] <input type="checkbox"/>	<input type="checkbox"/> 1 <input checked="" type="checkbox"/> 2 <input type="checkbox"/> 3 <input type="checkbox"/> 4

Fig.18 Graduation of bargraph for a quick and fine dosing threshold

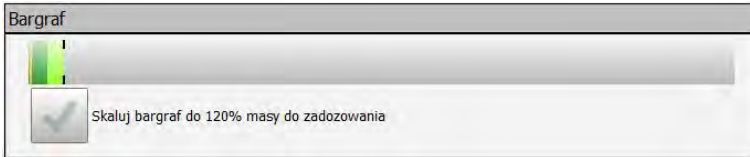

Fig.19 Bargraph for a small amount of mass with a graduation option turned off

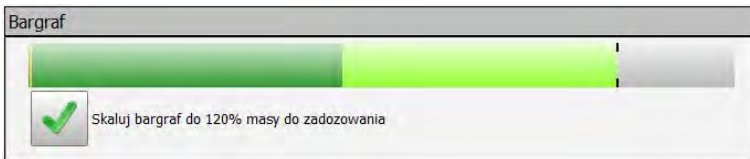

Fig.20 Bargraph for the same amount of mass with a graduation option turned on

- **Dosing parameters**

Parametry dozowania	
Próg dozowania szybkiego	Nr wyjścia
<input type="text" value="90"/> [kg] <input checked="" type="checkbox"/>	<input checked="" type="checkbox"/> 1 <input checked="" type="checkbox"/> 2 <input type="checkbox"/> 3 <input type="checkbox"/> 4
Próg dozowania dokładnego	Nr wyjścia
<input type="text" value="120"/> [kg] <input type="checkbox"/>	<input type="checkbox"/> 1 <input checked="" type="checkbox"/> 2 <input type="checkbox"/> 3 <input type="checkbox"/> 4

Fig.21 Dosing parameters settings window

Depending on the need dosing process may be carried out in two stages or one stage.

Fields description:

Fast dosing threshold	Output number
Mass value which finishes the 1 st stage of a dosing process. (switching on to the second stage, not in case of one-stage dosing process.)	Choice of an output or few outputs active during the 1 st dosing process stage (for a presently operated weighing platform).

Fine dosing threshold	Output number
Mass value which finishes the 2 nd stage of a dosing process. (the end of the dosing process.)	Choice of an output or few outputs active during the 1 st dosing process stage (for a presently operated weighing platform).

Dosing parameters

Dosing status window informs about a present state of a dosing process on a given weighing platform.



Description:

Dosing status	Dosing process state: DOZING – dosing in progress SUSPENDED – suspending the dosing process. STOPPED – stopping the dosing process, FINISHED – dosing is finished.
----------------------	--

Inputs simulation

Inputs simulation allows for simulation of an operation of a function assigned to a particular Input. *See point 9.5.3 of this manual.*

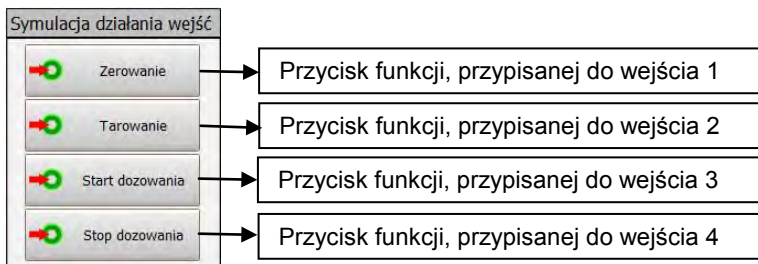

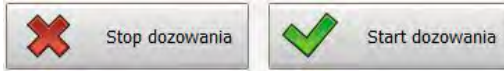

- **Dosing simulation**

There are Stop dosing and Start dosing buttons in the bottom part of a dosing simulation window. No matter what functions have been assigned on Inputs, these buttons enable dosing process start and stop.

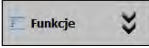

9.6.2. Checkweighing

Turning on  option and pressing  button opens checkweighing settings window for a presently selected weighing platform.

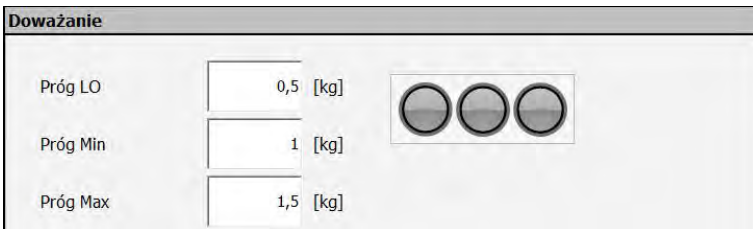

Fig.22 Checkweighing parameters window

Description of the fields:

LO threshold	Gross value of mass, checkweighing function is active if this value is exceeded
Min threshold	Mass value for estimation of tolerance threshold. - MIN threshold value is signaled below the Min threshold value
Max threshold	- OK threshold is signaled between Min threshold - Max threshold values. - MAX threshold value is signaled over the Max threshold value

Functions signalling within thresholds:



Caution:

Checkweighing signalling is available after the Output functions have been set. See point 9.5.3 of this manual.

9.6.3. Input/Output state

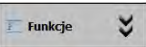
Window of Inputs signaling which also allows configuration of Outputs state opens upon activation of functions  option and pressing

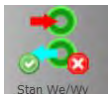



Input/Output state  button.



Fig.23 Inputs/Outputs states window

Input/output numbers in program accord with the numeration in a module.

	Active input/output
	Inactive input/output

Simulation of output operation is possible after this output number has been pressed. This very output activates immediately if only no other function has been assigned to it.

Output activity simulation is available in a dosing window.

10. WEIGHMENT

Put a product to be weighted on a scales pan. Read a measurement when a marker ▲ has been displayed.

Caution:

In case of cooperation of weighing module MW-04 with more than one weighing platform the user must select a correct platform in a weighment display in order to get the correct mass reading.

10.1. Terms of use

In order to assure long device usage and accurate mass measurements the user should:

- avoid applying mechanical shocks while loading a scales pan:

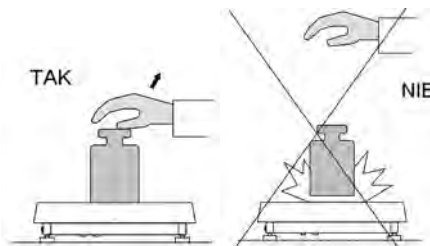

- put loads precisely in the centre of a scales pan (errors of eccentric weighing are defined by PN-EN 45501 standard, point 3.5 and 3.6.2):

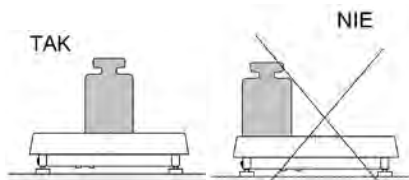

- not load a scales pan with concentrated force:

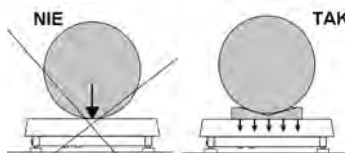

- avoid side loads, especially side shocks:

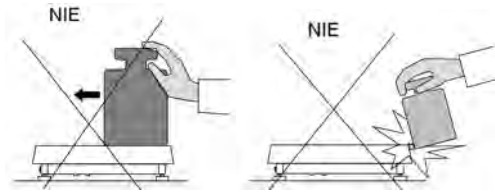

10.2. Scales zeroing

In order to zero mass readout of a presently selected platform the user has to press  button which is to be found in a weightment display of a „MwManager” program (the top right hand corner) or he has to initiate zeroing function defined for a given input (See point 9.5.3 of this manual).

On a display mass readout with zero value will be shown next to symbols: **-0-** and .

Zeroing means estimating a new zero point which will be recognized by scale as an exact zero. Zeroing is possible only when display states are stable.

Caution:

*Zeroing a display state is possible only within the range upto $\pm 2\%$ of the maximum scales load. If zeroing value is greater than $\pm 2\%$ of the maximum load then the message **Err2** is displayed.*

10.3. Taring

To estimate net mass for a presently selected platform the user needs to put packaging on a device and wait for a readout to stabilize, next (s)he may press button . The other possibility is to initiate tare function defined for a given input (See point 9.5.3 of this manual).

On a display mass readout with zero value is be shown next to symbols : **Net** i . The scales has been tared.

While using tare function the user has to pay attention to maximal weighing range. It cannot be exceeded. The readout which is a sum of tarred mass will be displayed after the load and the package have been taken off. Minus sign will be seen in front of a displayed value.

Caution:

*Taring process cannot be executed when a display shows minus mass value or a zero mass value. In such a case the message **Err3** is displayed.*

10.4. Weighment for dual range scales

1st range weighing proceeds to **2nd range** weighing automatically without any interference of the user (immediately after the 1st range weighing maximum has been exceeded). The 2nd range weighing is signaled with a display of a **→2←** sign in the top left hand corner of the display. After a load has been taken off the indication is zero. The weighment accuracy is the 2nd range accuracy up to the moment of getting back to zero.



Fig.24 2nd range scales window

Return from the **2nd range** weighing to the **1st range weighing** proceeds automatically after the load has been taken off and after the scales has entered AUTOZERO zone – instead of the 2nd range weighing **→0←** symbol is displayed. The scale returns to the 1st range weighing accuracy mode.

10.5. Measuring unit change

To change a measuring unit for a presently selected platform the user has to press a Change  button, which is to be found in in users parameters window. To open user parameters window the user needs to open „MwManager” program window first.



Fig. 25 User parameters window

Possible choices:

- When a main unit of scales is [kg], the user can select following units: [kg, lb, oz, ct, N, g], for verified scales [lb, oz, N] are unavailable;
- When a main unit of scales is [g], the user can select following units: [g, kg, lb, oz, ct, N], for verified scales [lb, oz, N] are unavailable;

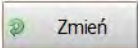
11. SCALES PARAMETERS

The user can adapt scale to an outdoor environmental conditions (filters order) or his own needs (active autozero)

These parameters are to be found in parameters bookmark

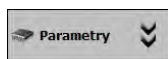

>



Parametry użytkownika



. They are available for each of the platforms, and for each of the platforms they can be edited.

List of parameters:

- Autozeroing,
- Median filter,
- Filter.

11.1. Autozero function

For ensuring accurate balance readouts „AUTOZERO” function has been introduced. This function automatically controls and corrects zero readouts.

When this function is active several measuring results are compared at regular intervals. If value differentiating these results is lower than declared AUTOZERO range, e.g. 1 reading unit, than zeroing is automatic. Markers of stable result -  and zero readout -  are displayed.

When AUTOZERO function is active each measurements start with an exact zero which is useful. Although there are cases when this function can be a drawback. One of such examples might be putting load on a pan very slowly (e.g. pouring the load). Zero readout correction system in such a case might distort readout of a real mass of the load.

Procedure:

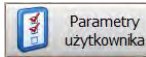
- Enter user parameters window ,
- Select or unselect **<Autozeroing>** parameter

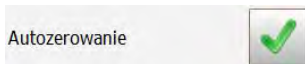

- autozeroing function on

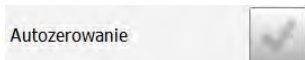



- autozeroing function off

11.2. Median filter

Median filter eliminates short-term impulse noise (e.g. mechanical shock).

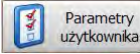
Procedure:

- Enter user parameters window 
- Select **<Median filter>** parameter, press 

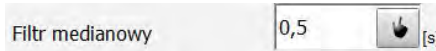

- Select a desired setting out of the available list

Available parameters:



None - median filter turned on

0.5, 1, 1.5, 2, 2.5 - median filter turned off

11.3. Filter

Moving average filter adjusts scales to outdoor environmental conditions.

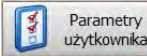
Procedure:

- Enter user parameters window 
- Select **<Filter>** parameter, press 

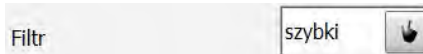

- Select a desired setting out of the available list

Available parameters:

none, very fast, fast, medium, slow

Caution:

The higher the order of a filter is the longer time of measurement stabilization it needs.



12. CHECKWEIGHING

Checkweighing is a function that enables precise weighing of a sample for which minimum and maximum weighing threshold, so called checkweighing thresholds, have been determined (LO – to little mass of the sample, HI – to big mass of the sample, OK – correct mass of the sample).

These states are presented through light signaling or through steering of peripheral devices systems.



Fig.26 States range for checkweighing function

Caution:

Starting procedure of checkweighing function and its signaling have been presented in point 9.6.2 of this manual.

12.1. LO threshold

<LO threshold> parameter determines net mass upon exceeding which the checkweighing function activates.

Procedure:

- Click parameter window:



- Enter **LO** threshold value.

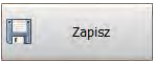

- Press  button to close dialog window
- Press Save  button to save introduced changes into a permanent storage of a module.

12.2. MIN/MAX threshold

<MIN threshold> parameter determines net mass threshold of a checkweighing function. For the determined net mass the state swaps between Min and OK.

<MAX threshold> parameter determines net mass threshold of checkweighing function. For the determined net mass the state swaps between OK and MAX.

Outputs signaling starts over the set net **LO threshold** value.

Procedure:

- Click **<Min threshold>** parameter window or **<Max threshold>** parameter window,



- Enter a threshold value

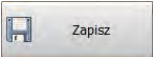

- Press  button to close a dialog window,
- Press Save  button to save introduced changes into a permanent storage of a module.

13. DOSING

Dosing function enables precise weighing of a given product up to desired value.



<Fast dosing threshold> parameter stands for net mass value of fast (rough) dosing below which one or more outputs are active. (Outputs are assigned to fast dosing).

<Fine dosing threshold> parameter stands for net mass value of slow dosing below which (but at the same time not below mass value of fast dosing threshold) one or more outputs are active. (Outputs are assigned to fine dosing).

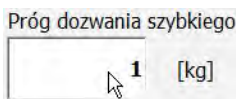

Procedure:

- Click **<Fast dosing threshold>** parameter window or **<Fine dosing threshold>** parameter window,



- Enter a threshold value



- Press  button to close the dialog window,
- Press Save  Zapisz button to save introduced changes into a permanent storage of a module.
- Changes will be confirmed with the following message:

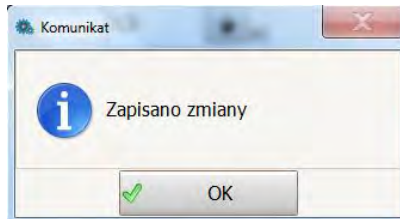

- If any threshold values will be changed but not saved than present settings can be read out, to do it the user has to use a Readout

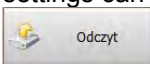

button.

- Readout will be confirmed with a following message:

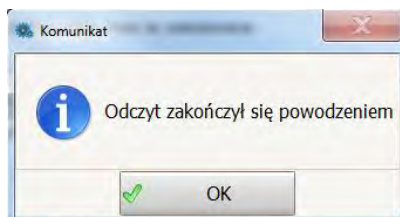

Caution:

Description of a dosing function and its parameters are to be found in the point 9.6.1 of this manual.

14. PARAMETERS SAVED TO FILE

„MwManager” program allows saving set parameters into *.sav file format. This function can be useful when saving module settings as a safety copy in case of a weighing module breakdown. Parameters saved on a safety copy can be used for further configuration purposes with a greater number of weighing modules.

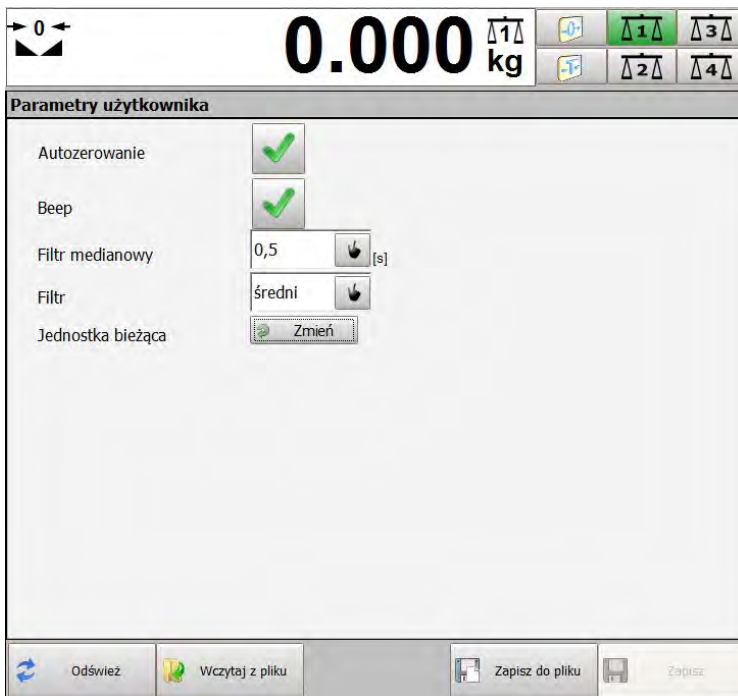

Fig.27 An example of a window with available options **Save to file and Read from file.**

File format:

MW04_(factory number)_RRRR-MM-DD_HH-MM.sav

14.1. Save to file

Procedure:

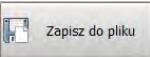
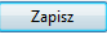
- Press **Save to file**  button after the weighing module parameters have been set
- In an operating system window select file destination folder and press Save  button.

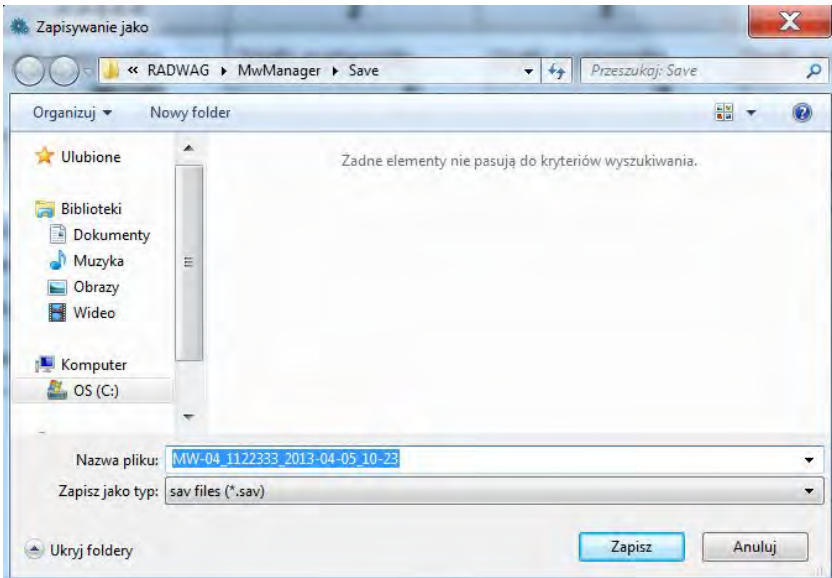
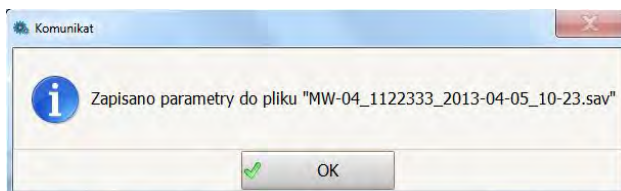

Fig.28 „Save as” system window

- The following message will inform about correctly saved parameters.



Caution:

Preview of an operating system window depends on the installed operating system therefore it may differ from the one presented in Fig.28.

14.2. Read from file

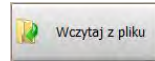

Procedure:

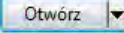
- In order to read the parameters press **Read from file** button
- Open operating system window, see Fig 29, and select a previously saved file, next press **Open**  button.

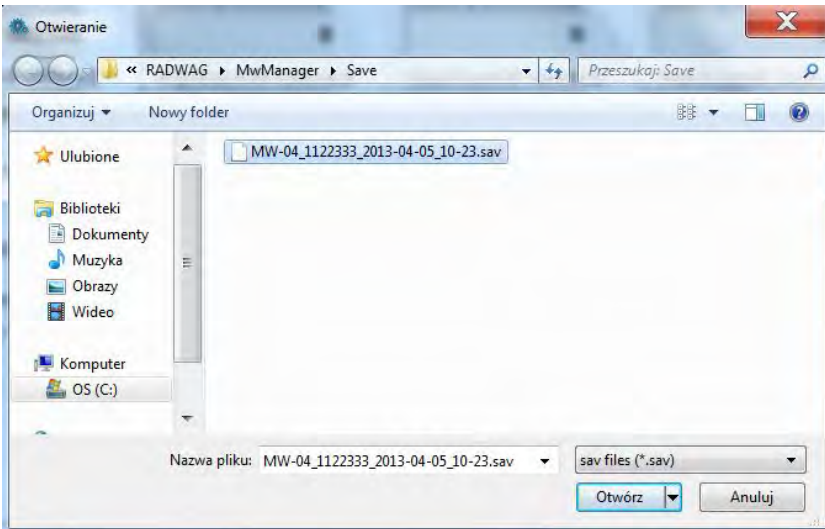

Fig. 29 „Open” window

- In **Parameters groups selection** window select **Read all parameters** option or **Read chosen parameters** option and press **<OK>**.

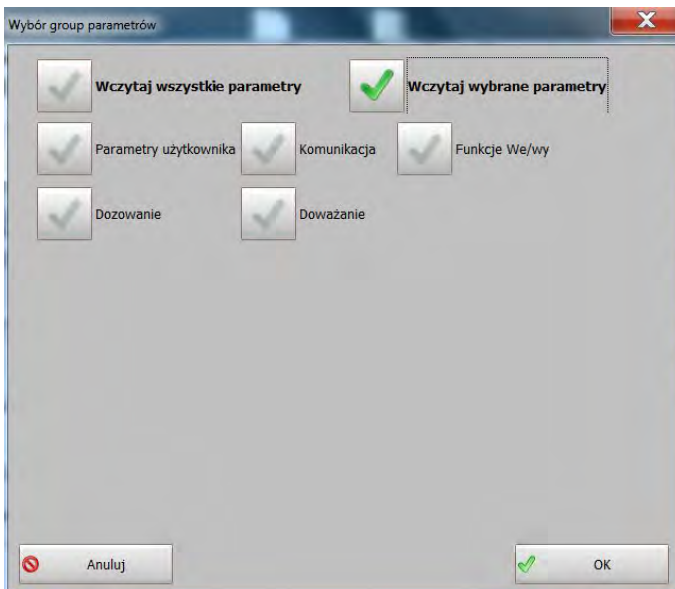
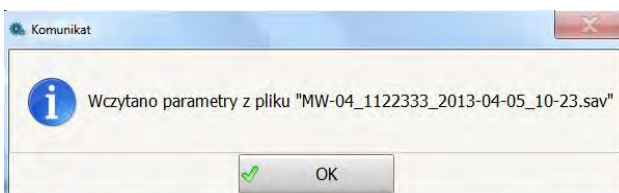

Fig.30 Parameters groups selection window.

- If parameters have been read correctly the following message will be displayed:



15. OFFLINE MODE

Offline mode allows for operation of a selected options of a program without the need of connecting it to a weighing module. Through this indispensable parameters can be saved without a physical connection with the device.

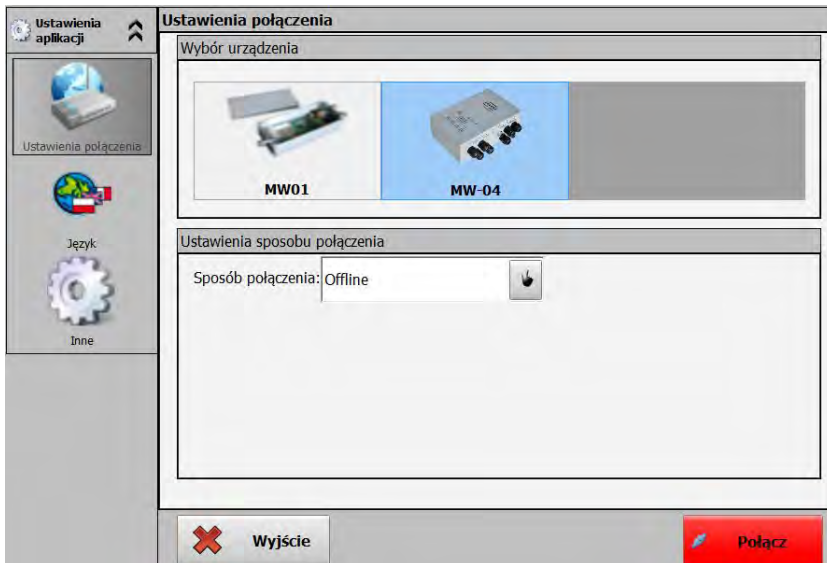
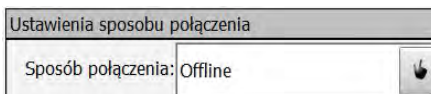

Fig.31 Offline mode window preview.

Procedure:

- Press **Connection settings**  button, which is to be found in **Application settings**  bookmark
- In **Connection types settings** window select **Offline** option



- Press **Connect**  button
- „Offline” message will be displayed on the scales screen.



- Set chosen parameters and save the configuration to file, see description in point 14.1.

16. ERROR MESSAGES

Err2	-	Value beyond zeroing range
Err3	-	Value beyond taring range
Err8	-	Tarring/zeroing time limit exceeded
NULL	-	Zero value from the load cell
FULL	-	Measuring range exceeded
HI	-	Display state exceeded
LH	-	Input mass error, readout beyond range (from -5% to +15% of an input mass)

17. CABLES DIAGRAMS

Scales of STANDARD made design can cooperate with:

- a computer,
- KAFKA, EPSON receipt printers,
- CITIZEN, ZEBRA label printers,

17.1. USB cable for a printer

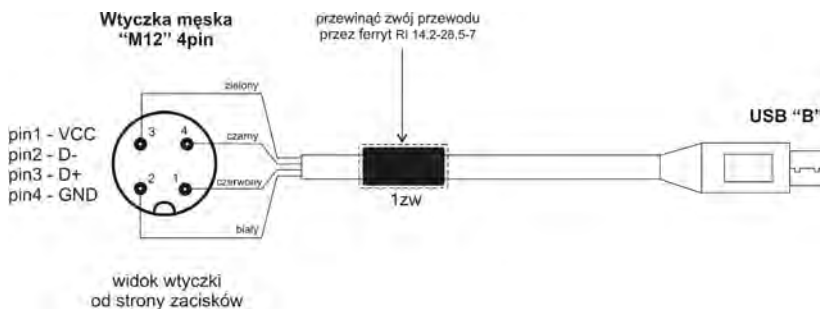

Fig.32 USB cable for a printer - PT0087

17.2. Cable RS232 for EPSON, CITIZEN printer

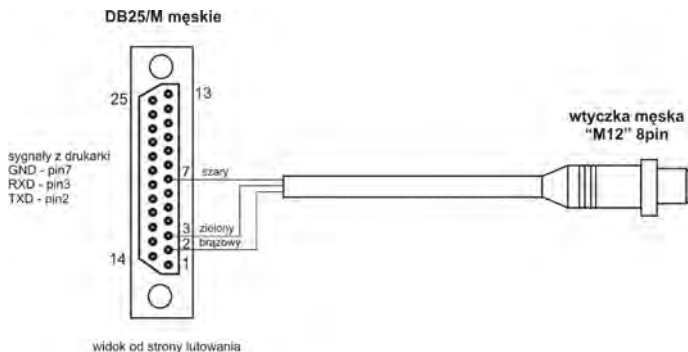

Fig.33 Cable RS232 for Citizen, Epson printers - PT0019

17.3. Cable RS232 terminal – computer

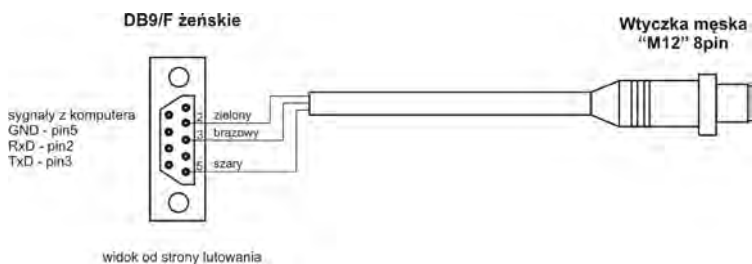

Fig.34 Cable RS232 terminal – computer - PT0020

17.4. Cable RS232, RS485

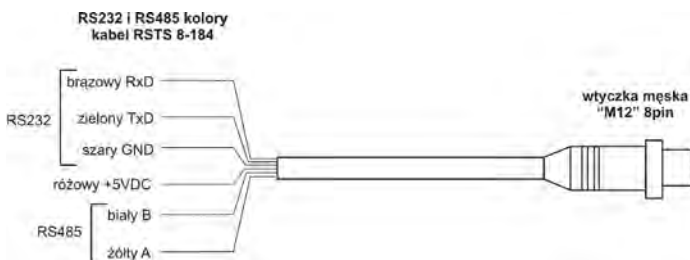

Fig.36 Cable RS232, RS485 – wires colors

Caution:

These are colours for cables of “M12” standard. The figure shows just an example cable type.

17.5. Ethernet cable

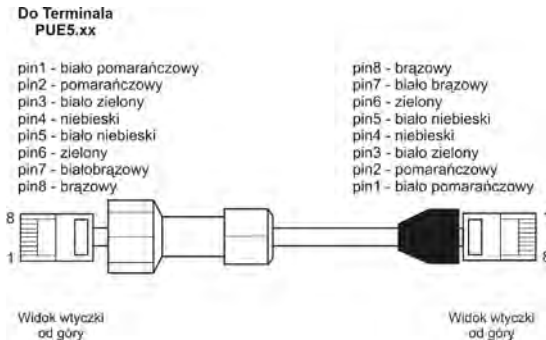

Fig.35 P0212 Ethernet cable

18. EXTRA MODULES SPECIFICATION

Scales with PUE5 terminal can optionally be expanded with an extra modules positively influencing the device functionality:

- Extra A/D converter module
- 4 Inputs / 4 outputs module
- Profibus DP interface.

18.1. A/D converter

A/D converters influence PUE 5 terminal functionality. Additional weighing modules can work with PUE 5 thanks to them. A/D converter board is fixed onto weighing module MW-04, inside PUE 5 gauge. It is possible to fix up to 4 A/D converter boards. On a housing lid an additional cable gland is installed through which load cell cable is led out. Parameters of all load cells are identical.

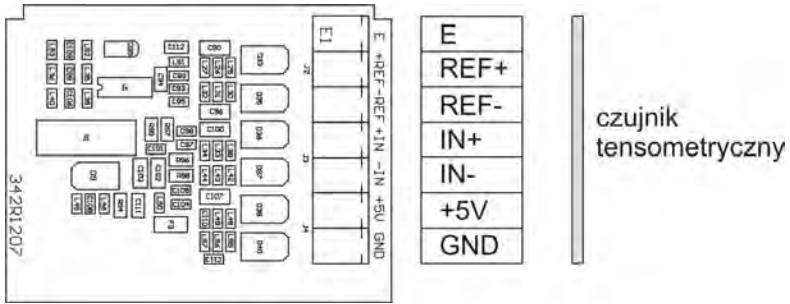

Fig.38 A/D converter board

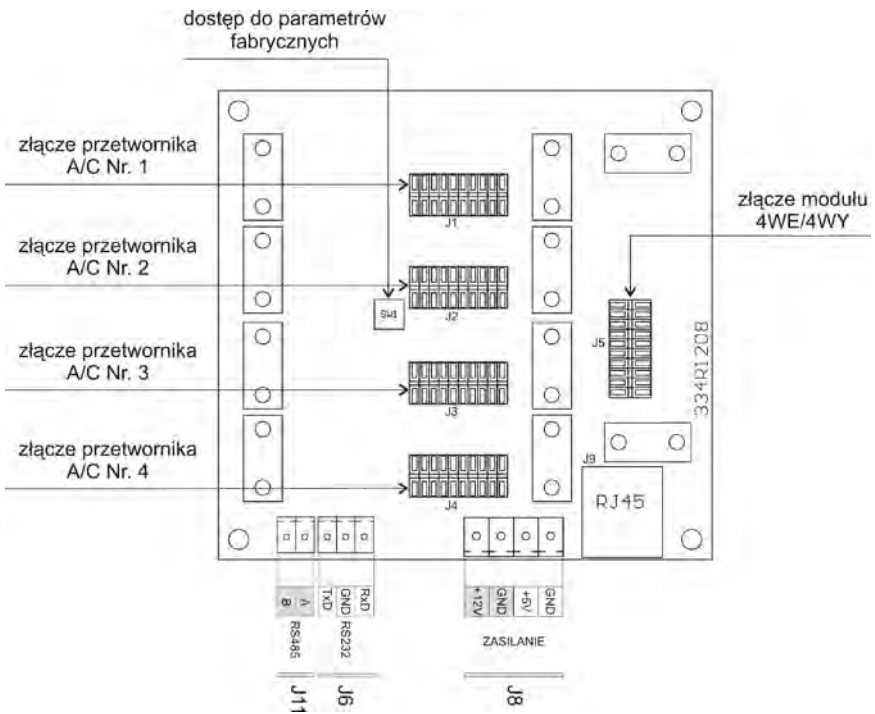

Fig.39 Weighing module MW-04

18.1.1. Technical specification of A/D converter

Maximal number of divisions from A/D converter	8 388 608
OIML class	III
Number of verification intervals	6000e
Max increase of signal	19.5mV
Max voltage per 1 verification interval	3.25 μ V
Min voltage per 1 verification interval	0.4 μ V
Min impedance of strain gauge load cells	80 Ω
Max impedance of strain gauge load cells	1200 Ω
Strain gauge load cells feeding voltage	5V
Strain gauge load cells type	4 or 6 cables + screen

18.1.2. Strain gauge load cells connection

- **6-wire load cells**

For 6-wire strain gauge load cells do the connection as follows:

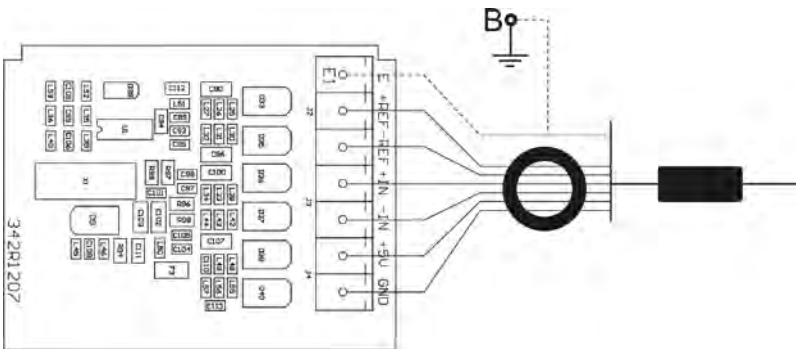

Fig.40 6-wire strain gauge load cell connection

Interface on load cell board	Strain gauge load cell signal	Notes
E	SCREEN	See strain gauge load cell connection rules
REF+	SENSE +	
REF-	SENSE -	
IN+	OUTPUT+	
IN-	OUTPUT-	
+5V	INPUT+	
AGND	INPUT-	

- **4-wire load cells**

For 4-wire load cells do the connection as follows:

Connect REF+ with +5V and REF- with AGND using the LiY 0,34mm² cable.

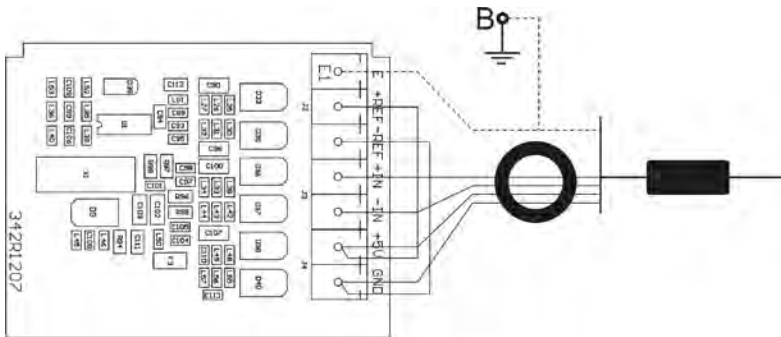

Fig.41 4-wire load cell connection

Interface on load cell board	Strain gauge load cell signal	Notes
E	SCREEN	See the strain gauge load cell connection rules
REF+	-	Connect to +5V
REF-	-	Connect to AGND
IN+	OUTPUT+	
IN-	OUTPUT-	
+5V	INPUT+	
AGND	INPUT-	

- **Strain gauge load cell screen connection rules.**

While connecting signal cable screen of a strain gauge load cell the following connection rules must be obeyed in order to ensure correct weighment.

In both cases (scales platforms with 6-wire and 4-wire signal cable) the same rule of connection is obligatory:

	Permanent galvanic connection of the screen and the construction of the scales arm, done by the producer	No galvanic connection of the screen and the construction of the scales arm
Scales with metal head connected with platform via signal cable	POINT B	POINT B
Compact mechanical construction of scales (e.g. Scales with head on a mast), head in a metal housing.	POINT B	E

Point B – electrical connection with housing of a terminal (e.g. threaded pin, threaded hole to be used for screwing of a soldering eye),

E – soldering point of A/D converter board

- **Test of galvanic connection of a strain gauge load cell screen with a platform construction**

To carry out a test ohmmeter is needed.

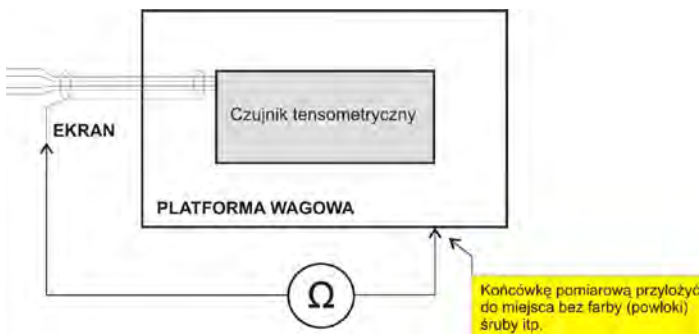

18.2. 4 inputs / 4 outputs module

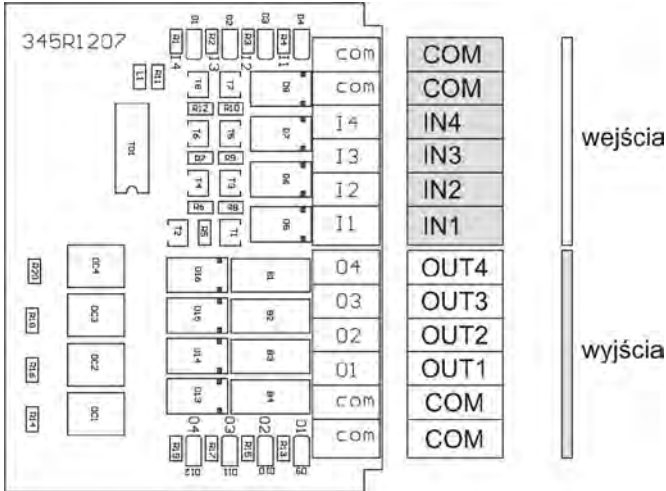

Fig.42 4Inputs/4Outputs module – description of cable outlets

4IN/4OUT module is installed inside a terminal on weighing module MW-04 board (Fig. 39).

Two optional versions are available:

- 4IN/4OUT fed on hermetic socket
- 4IN/4OUT fed through cable glands.

18.2.1. Technical parameters of 4IN/4OUT module

Input parameters	
Inputs number	4
Inputs type	OptoMOS
Max switching current	0,2A DC
Max forward voltage	50V DC
Outputs parameters	
Outputs number	4
Outputs type	Optoinsulated
Steering voltage range	5 -24V DC

18.2.2. Input/output schematic diagram

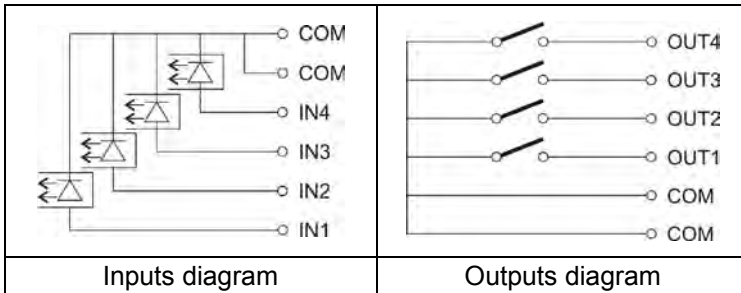

Fig.43 Input/output schematic (demonstrating) diagram

18.2.3. 4IN/4OUT in sockets

Configuration for an optional made design of a terminal.

Signals are fed on hermetic M12 8P sockets, one socket for inputs, the other one for outputs.

Chart below presents signals distribution for each pin of a socket.

4IN		Pin1-IN1 Pin2-IN2 Pin3-IN3 Pin4-IN4 Pin5-COMM Pin6-+24VDC Pin7-GND
4OUT		Pin1-OUT1 Pin2-OUT2 Pin3-OUT3 Pin4-OUT4 Pin5-COMM Pin6-+24VDC Pin7-GND

18.2.4. 4IN/4OUT through cable gland

Configuration for an optional made design of a terminal.

Signals are fed on two cables, one cable for inputs, the other one for outputs.

Chart below presents signals distribution for each wire of a cable.

Cable for INPUTS		Cable for OUTPUTS	
WIRE NUMBER	SIGNAL	WIRE NUMBER	SIGNAL
1	IN1	1	OUT1
2	IN2	2	OUT2
3	IN3	3	OUT3
4	IN4	4	OUT4
5	COM	5	COM
6	+24V	6	+24V
7	GND	7	GND

18.3. Profibus

Configuration for an optional made design of a terminal. PROFIBUS module is installed on an interface board, inside PUE 5 gauge. Signals are fed on hermetic M12 5P PROFIBUS IN, PROFIBUS OUT sockets (type B ports coding - PROFIBUS)

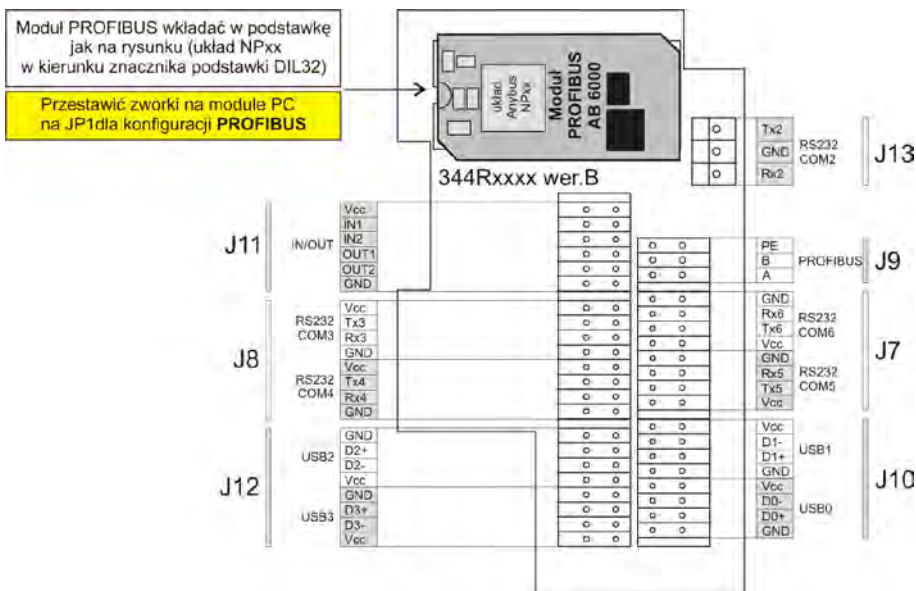

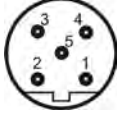

Fig.44 Interfaces board with an installed PROFIBUS module.

Chart below presents signals distribution for each pin of a socket.

<p>PROFIBUS IN (male)</p>		<p>Pin1 – NC Pin2 – A Pin3 – NC Pin4 – B Pin5 – NC</p>
<p>PROFIBUS OUT (female)</p>		<p>Pin1 - +5V Pin2 – A Pin3 – GND Pin4 – B Pin5 – NC</p>

Caution:

For a correct work reconfiguration of jumpers on a PC module is required – JP1 jumpers

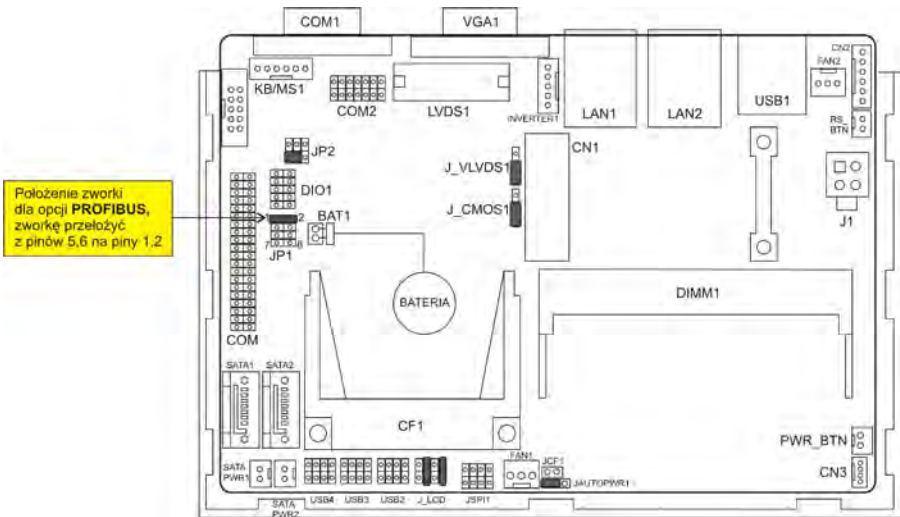

Fig.45 Jumpers configuration on a PC module for PROFIBUS

19. TECHNICAL PARAMETERS

	PUE 5.15	PUE 5.19
Housing	Stainless steel	
IP rating (degree of protection)	IP65	
Display	TFT 15"±15,6" IR with touch panel	TFT 19"IR with touch panel
Power	100±240VAC 50-60Hz	
Temperature range	Work temperature: 0°C to +40°C Storage temperature: -20°C to +60°C	
Max number of load cell reading units	8 388 608	
OIML class	III	
Number of verification intervals	6000e	
Max increase of signal	19.5mV	
Max voltage per 1 verification interval	3.25µV	
Min voltage per 1 verification interval	0.4µV	
Min impedance of a strain gauge load cell	80 Ω	
Max impedance of a strain gauge load cell	1200 Ω	
Strain gauge load cells feeding voltage	5V	
Strain gauge load cells type	4 or 6 cables + screen	
Processor	Intel® Atom™ D525 Dual-Core 1.8 GHz	
RAM	2 GB DDR3 800 MHz	
Data storage	HDD SATA lub SSD SATA	
Graphics storage	max. 224 MB	
Ethernet	10/100/1000 Mbit	
Standard interfaces	2xRS232, RS485, 4xUSB 2.0, Ethernet	
Optional interfaces	Profibus, or other communication modules marked with the CE sign.	
Optional IN/WY	4 INputs, 4 OUTputs	

20. EXTRA EQUIPMENT

- | | |
|-----------------------|---|
| Extra A/D converter | - Metrological parameters like in the main platform |
| Inputs/Outputs module | - Additional 4 inputs / 4 outputs |
| Profibus DP interface | - Slave mode operation |

MANUFACTURER
OF ELECTRONIC WEIGHING EQUIPMENT



RADWAG WAGI ELEKTRONICZNE
26 – 600 Radom, ul. Bracka 28

Phone: +48 48 38 48 800, fax. + 48 48 385 00 10

Sales department: + 48 48 366 80 06

e-mail: export@radwag.com

www.radwag.com

