

4Y Series

PM 4Y Precision Balances

USER MANUAL

IMMU-24-03-05-18-EN



www.radwag.com

If you are reading this, it means that you are bound to achieve success. You have purchased a device that was designed and manufactured to give you years of service. Congratulations and thank you for selecting RADWAG product.

PM series balances are based on the below technology:



MAY 2018

CONTENTS

1. General Information	8
1.1. Dimensions	8
1.2. Connectors	10
1.3. Intended Use	10
1.4. Precautions	10
1.5. Warranty Conditions	11
1.6. Metrological Parameters Monitoring	11
1.7. User Manual Significance	11
1.8. Balance User Training	11
2. Transport and Storage	11
2.1. Delivery Checklist	11
2.2. Package	11
3. Unpacking and Installation	12
3.1. Place of Use and Assembling	12
3.2. Unpacking	12
3.3. Standard Delivery Components List	12
3.4. Maintenance Activities	13
3.5. Powering the Device	14
3.6. Temperature Stabilization	14
3.7. Connecting Peripheral Equipment	14
3.8. Balances Featuring Terminal-Weighing Module Wireless Connection	14
3.8.1. Start-up Procedure	15
3.8.2. Pictograms Description	16
3.8.3. Settings	16
4. Start-Up	17
5. Keyboard – Buttons’ Functions	17
6. Software Structure	17
7. Weighing Mode Home Screen	18
8. Logging	19
9. Operating Balance Menu	20
9.1. Soft Keys List	20
9.2. Return to Weighing Mode	20
10. Adjustment	21
10.1. Internal Adjustment	21
10.2. External Adjustment	21
10.3. User Adjustment	21
10.4. Adjustment Test	21
10.5. Automatic Adjustment	22
10.6. Automatic Adjustment Time	22
10.7. Scheduled Balance Adjustment	22
10.8. Report Printout	24
10.9. GLP Project	24
10.10. Adjustment History	25
11. Users	25
12. Permissions levels	26

13. Profiles	28
13.1. Creating a Profile	28
13.2. Profile structure	29
13.2.1. Settings	29
13.2.2. Working Modes	29
13.2.3. Readout	29
13.2.4. Measuring Units	31
14. Working Modes	31
14.1. Running Working Mode	33
14.2. Parameters Related to a Working Mode	33
14.3. Quick Access Keys, Proximity Sensors	34
14.3.1. Proximity Sensors.....	34
14.4. Information.....	34
14.5. Printouts.....	35
14.6. Profiles	36
15. Weighing Operation	36
15.1. Weighing Unit Selection	36
15.2. Good Weighing Practice	37
15.3. Balance Levelling	37
15.4. Balance Zeroing.....	38
15.5. Balance Taring.....	38
15.6. Use of Air Buoyancy Compensation Factor	39
15.7. Additional Parameters for a Weighing Process	41
15.8. Minimum Sample Weight.....	43
15.9. Cooperation with Titrators	45
16. Parts Counting	45
16.1. Supplementary Settings for Parts Counting Mode.....	46
16.2. Setting Reference Mass by Entering Determined Part Mass.....	47
16.3. Setting Reference Mass by Determining Part Mass	47
16.4. Acquiring Part Mass From a Database	47
16.5. Updating Part Mass in a Database.....	48
16.6. Parts Counting Procedure	48
16.7. Checkweighing for Parts Counting Mode	48
16.8. Dosing for Parts Counting Mode	49
17. Checkweighing	50
17.1. Making Use of Checkweighing Thresholds	50
17.2. Supplementary Settings for Checkweighing Mode	51
18. Dosing	51
18.1. Making Use of Products Database for Dosing Operation	51
18.2. Supplementary Settings for Dosing Mode	52
19. Percent Weighing	52
19.1. Comparison of a Sample and a Reference Mass	53
19.2. Checkweighing and Dosing for Percent Weighing Mode	54
19.3. Bargraph - a Tool for Function Interpretation	55
19.4. Supplementary Settings for Percent Weighing Mode.....	55
20. Density	55
20.1. Solids Density Determination	56
20.2. Determining Density of Liquids.....	57

20.3. Air Density	57
20.4. Determining Density Using Pycnometer	58
20.5. Supplementary Settings for Density Mode.....	59
20.6. Printouts.....	60
20.7. Report on Completed Density Determination Process.....	61
21. Animal Weighing	61
21.1. Animal Weighing Mode Settings	62
21.2. Supplementary Settings for Animal Weighing Mode.....	62
22. Formulations	62
22.1. Supplementary Settings for Formulations Mode.....	63
22.2. Adding Formulation to Formulations Database	64
22.3. Using Formulations in Weighing	65
22.4. Printouts.....	67
23. Statistics	68
23.1. Buttons and Information Setup	68
23.2. Supplementary Settings for Statistics Mode	68
23.3. Series of Measurement Related Parameters	69
24. Differential Weighing	70
24.1. Supplementary Settings for Differential Weighing Mode	71
24.2. Quick Access Keys.....	71
24.3. Adding Series to Series Database	72
24.4. Differential Weighing Process Example	73
24.5. Copy Tare	77
24.6. Sample Selection	78
24.7. Deleting Values.....	78
24.8. Printouts.....	78
25. Statistical Quality Control - SQC	79
25.1. SQC Activation	80
25.2. Supplementary Settings for SQC Mode	82
25.3. Control Operation.....	82
25.4. SQC control Report.....	83
26. Peak Hold	84
26.1. Supplementary Settings for Peak Hold Mode	84
26.2. Means of Operation	84
27. Prepackaged Goods Controls.....	85
27.1. Prepacked Goods Control Mode Start-Up	86
27.2. Control Settings.....	86
27.3. PGC Mode Local Settings.....	86
27.4. Editing Product for Control	87
27.5. Control Start Procedure.....	88
27.6. Abort Control Procedure	89
27.7. Aborted Control Restoring Procedure, Power Loss Case.....	90
27.8. Non-destructive Average Tare Control Mode.....	90
27.9. Non-destructive Empty-Full Control Mode	96
27.10. Destructive Empty-Full and Full-Empty Control Mode	97
27.11. Control According to Internal Criteria	97
27.12. Reports	99

28. Mass Control	100
28.1. Mass Control Global Settings	100
28.2. Mass Control Process	100
28.3. Printouts.....	102
28.4. Report on Completed Mass Control Processes.....	102
29. Databases	103
29.1. Processes Carried Out on Databases	104
29.2. Products	105
29.3. Weighing Records	106
29.4. Customers	107
29.5. Formulations	107
29.6. Formulations Reports.....	107
29.7. Density Reports	108
29.8. Prepacked Goods Controls	109
29.9. Average Tares	110
29.10. Series	110
29.11. SOC Reports	111
29.12. Minimum Sample Weight.....	112
29.13. Mass Controls.....	114
29.14. Ambient Conditions	115
29.15. Packages	115
29.16. Warehouses	116
29.17. Printouts.....	116
29.18. Universal Variables.....	118
29.19. Databases Management.....	118
29.19.1. Export Weighing Database	118
29.19.2. Delete Databases	120
29.19.3. Delete Weighings and Reports.....	121
30. Communication	122
30.1. RS 232 Settings.....	122
30.2. ETHERNET Settings	122
30.3. Wi-Fi Settings.....	123
30.4. TCP Settings.....	124
31. Peripherals.....	124
31.1. Computer	124
31.2. Printer	125
31.3. Barcode Scanner.....	127
31.3.1. Barcode Scanner's Port	127
31.3.2. Prefix/Suffix	127
31.3.3. Field Selection	128
31.3.4. Test.....	129
31.4. Transponder Card Scanner	129
31.5. Additional Display	130
31.6. Ambient Conditions Module	130
31.7. Automatic Feeder	130
32. Inputs/Outputs	131
33. Miscellaneous.....	132
33.1. Interface language	132

33.2. Date and Time Setting	133
33.3. 'Beep' Sound	134
33.4. Volume.....	134
33.5. Display Sleep Mode	134
33.6. Display Brightness.....	135
33.7. Touch Panel Calibration.....	135
33.8. Level Control	135
33.9. Sensors Sensitivity	136
33.10. IR Sensors Timeout.....	136
33.11. Autotest	136
33.12. Startup Logo	140
33.13. Export of System Events	140
34. Update	140
35. About	141
36. Movies.....	141
37. Communication Protocol	142
37.1. List of Commands	143
37.2. Response Format	144
37.3. Manual Printout/Automatic Printout	155
38. Connecting Peripherals	156
39. Error Messages.....	156
40. Additional Equipment	156
41. APPENDIX A – Variables for Printouts.....	157
41.1. List of Variables	157
41.2. Variables Formatting	165
42. APPENDIX B – Programmable Buttons List.....	167
43. APPENDIX D- Settings of ZEBRA Printers	169
44. APPENDIX E – Communication with Barcode Scanner	169
45. APPENDIX F – Menu Structure	170

1. GENERAL INFORMATION

1.1. DIMENSIONS

PM xx.4Y, d=0.01g

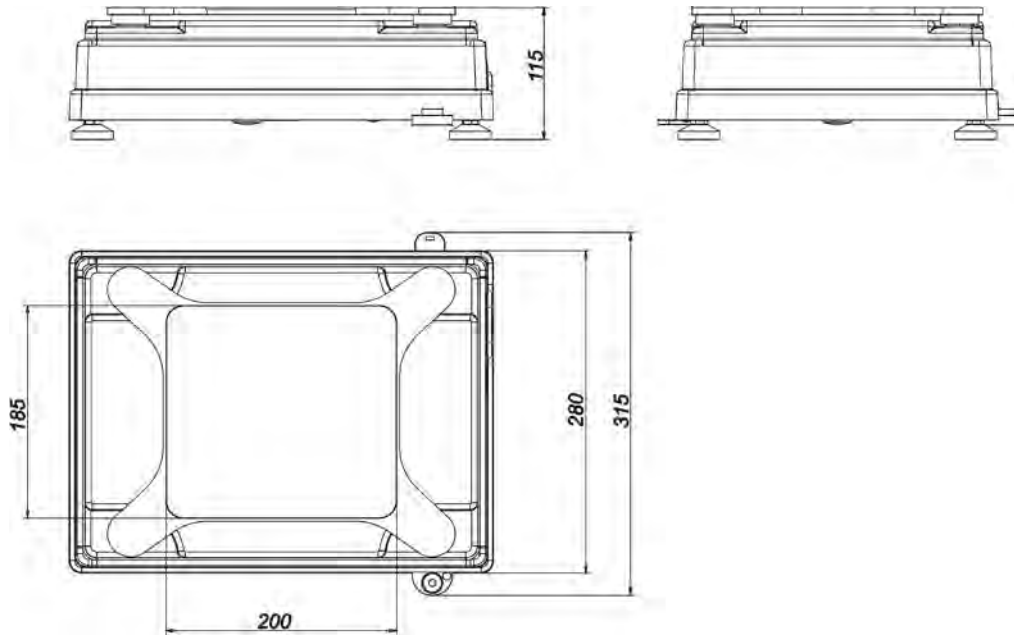

PM xx.4Y, d=0.1g

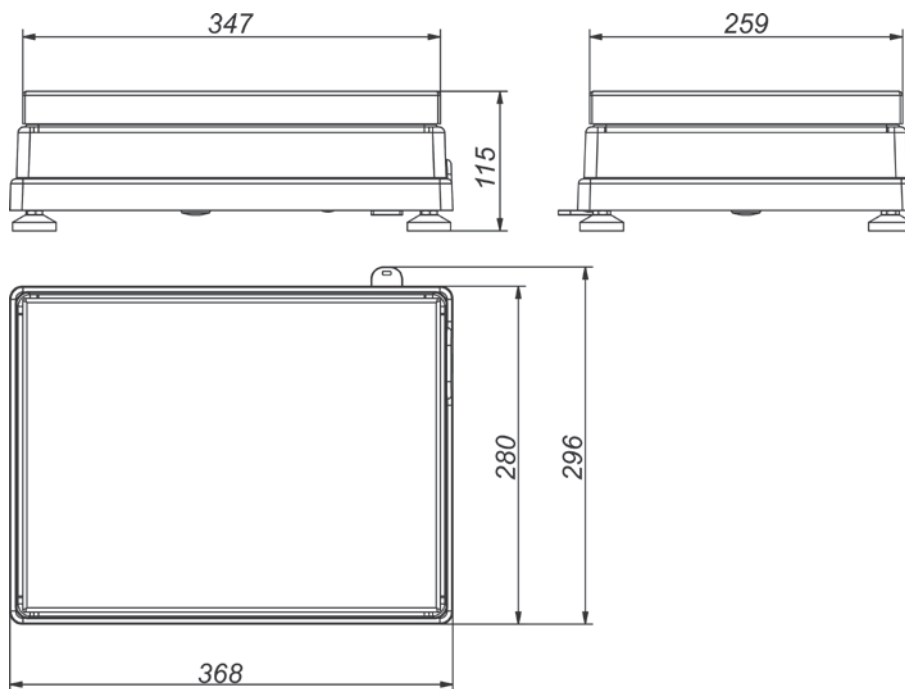

PM xx.4Y, d=0.5g, d=1g

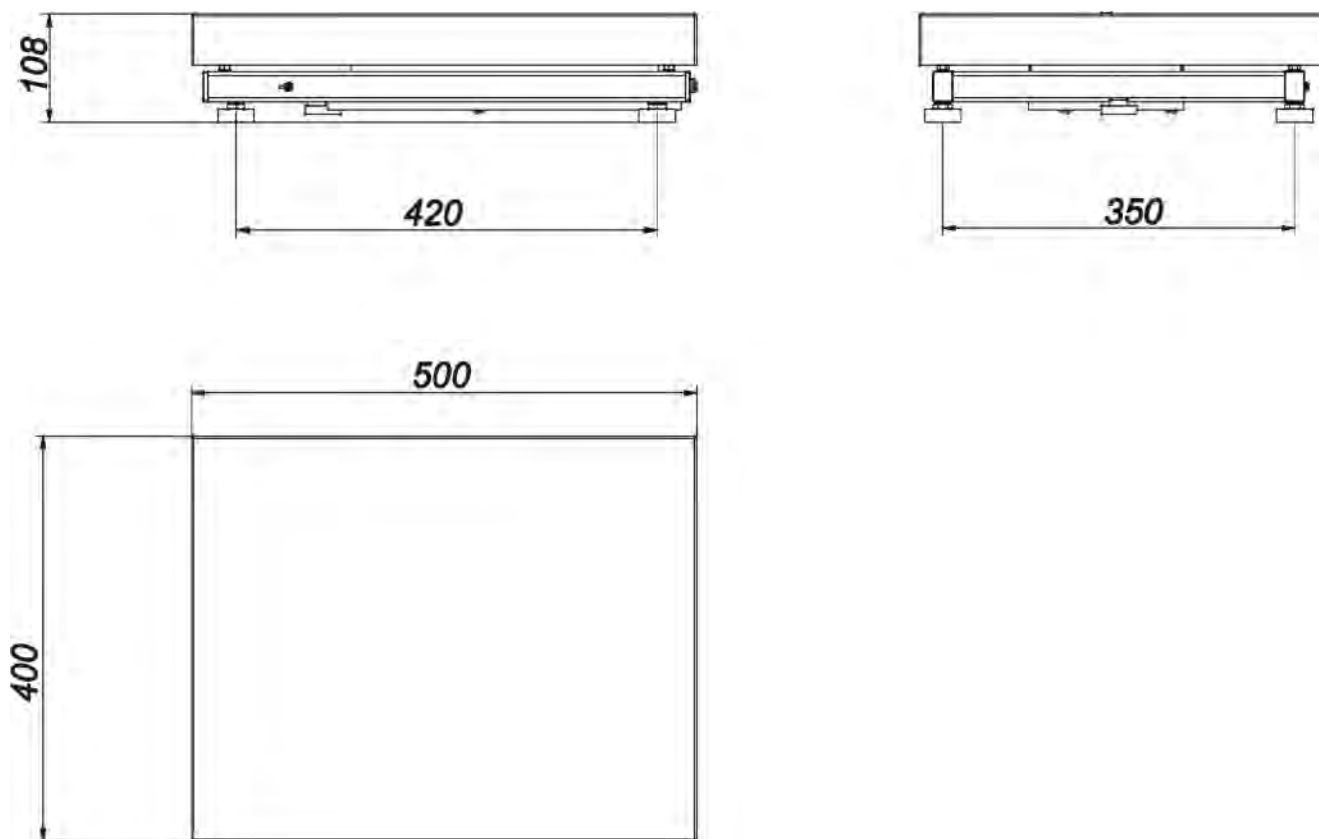

Indicator

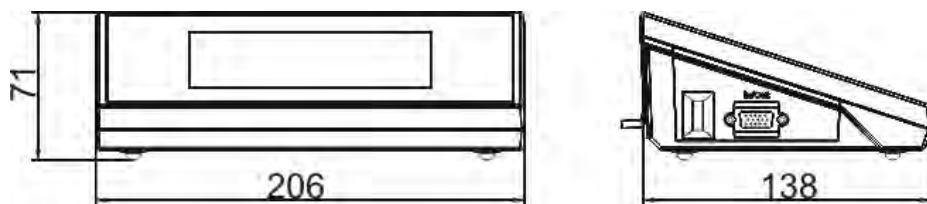

1.2. CONNECTORS

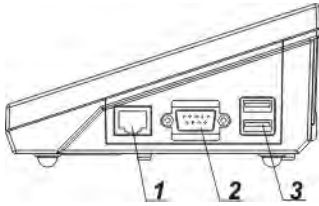

- 1 – Ethernet RJ45 connector
 2 – RS232 connector (COM1)
 3 – USB connector

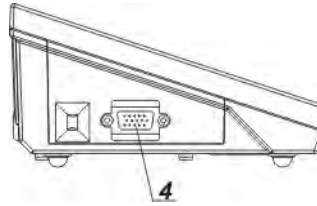

- 4 – IN/OUT, RS232 connector (COM2)

CAUTION! “Balance-Ethernet” cable is a standard cable terminated with RJ45 connector on both ends.



Balance – computer cable (RS232)

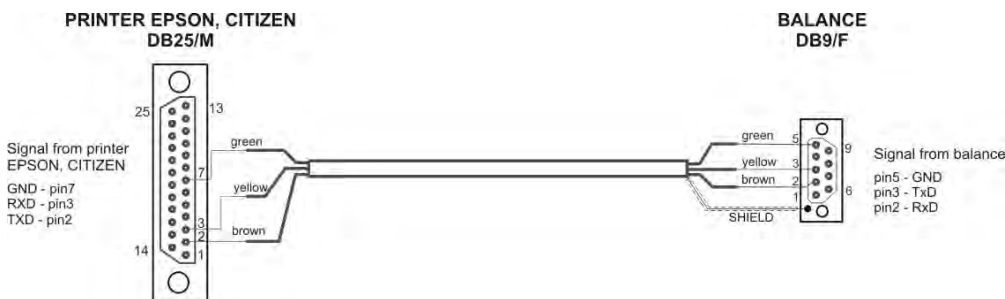

Balance – printer cable (EPSON printer)

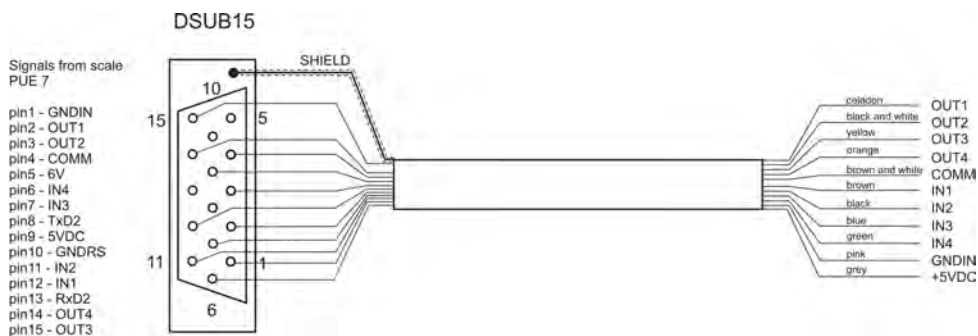

IN/OUT cable

1.3. INTENDED USE

3Y series balances are intended for precise mass measurement under laboratory conditions.

1.4. PRECAUTIONS

- Prior the first use, it is highly recommended to carefully read this User Manual, and operate the balance as intended.
- Do not operate the touch panel using sharp-edged tools (knife, screwdriver, etc.).
- While loading the balance make sure that loads are placed in the very center of the weighing pan.
- Load the weighing pan with loads, gross weight of which does not exceed instrument’s measuring range (maximum capacity).
- Do not leave heavy loads on the weighing pan for a longer period of time.
- In case of failure, immediately unplug the instrument from the mains.
- Balances to be decommissioned, have to be decommissioned in accordance with valid legal regulations.

- Do not use the balance in areas endangered with explosion. The PM series is not designed to operate in EX zones.

1.5. WARRANTY CONDITIONS

- A. RADWAG feels obliged to repair or exchange all elements that appear to be faulty by production or by construction,
- B. Defining defects of unclear origin and means of their elimination can only be realized with assistance of manufacturer and user representatives,
- C. RADWAG does not bear any responsibility for defects or losses resulting from unauthorized or inadequate performing of production or service processes,
- D. Warranty does not cover:
 - mechanical defects caused by product exploitation other than intended, defects of thermal and chemical origin, defects caused by lightning, overvoltage in the power network or other random event,
 - balance defects if it is utilized contrary to its intended use,
 - balance defects, if service claims removing or destroying protective stickers which secure the balance's housing against unauthorized access,
 - mechanical defects or defects caused by liquids and natural wear,
 - balance defects caused by inappropriate setting or by electrical wiring failures,
 - defects caused by overloading the mechanical measuring system,
 - maintenance activities (cleaning).
- E. Loss of warranty takes place if:
 - a repair is carried out outside RADWAG sales office or authorized service point,
 - service claims intrusion into mechanical or electronic construction by unauthorized people,
 - other version of the operating system is installed in a balance,
 - the balance does not bear company protective stickers.
- F. Detailed warranty conditions are listed on a service card.

1.6. METROLOGICAL PARAMETERS MONITORING

Metrological characteristics of the balance require periodical inspection to be carried out by its user. Inspection frequency is dependent on ambient conditions in which the balance is used, types of performed processes and accepted quality management system in organization.

1.7. USER MANUAL SIGNIFICANCE

It is very important to read the user manual carefully before switching on and starting up balance operation, even if you are experienced and have worked with this type of balance before.

1.8. BALANCE USER TRAINING

The balance has to be utilized and supervised only by users who are trained and experienced in using such type of weighing instruments.

2. TRANSPORT AND STORAGE

2.1. DELIVERY CHECKLIST

Upon delivery it is necessary to check the package and the device, make sure that your package bears no signs of damage. If it does contact the manufacturer's representative.

2.2. PACKAGE

Keep all package elements should your balance be transported in the future. Remember that only original packaging can be used for shipping purposes. Prior packing uncouple any cables, remove

any separable components (weighing pan, shields, inserts). Pack the device components into an original packaging. The original packaging protects the equipment against potential damage during transportation.

3. UNPACKING AND INSTALLATION

3.1. PLACE OF USE AND ASSEMBLING

- The balance has to be stored and used in locations free of vibrations and shakes, free of air movement and dust.
- Ambient air temperature cannot exceed the range of: $+10\text{ °C} \div +40\text{ °C}$.
- Ambient relative humidity cannot exceed 80%.
- During balance operation, ambient temperature in the weighing room cannot change rapidly.
- The balance has to be located on a stable wall console desk or a stable working table which is not affected by vibrations and distant from heat sources.
- Take special precaution when weighing magnetic objects, as part of the balance is a strong magnet. Should such loads be weighed, use under-pan weighing option, which removes the weighed load from area influenced by the balance's magnet. The hook for under-pan weighing is installed in balance's base.

3.2. UNPACKING

Cut the adhesive tape. Take the device out of the packaging. Open the accessory box, take the device components out of it.

3.3. STANDARD DELIVERY COMPONENTS LIST

- balance
- weighing pan
- power supplier
- User Manual – CD version

PM balance

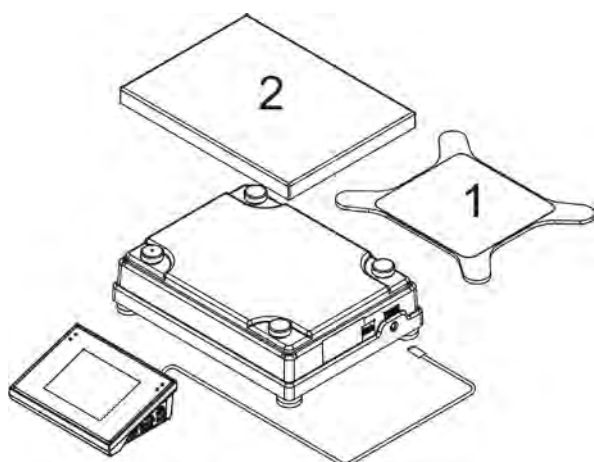

Install a weighing pan 1 for PM with $d=0.01\text{g}$ or pan 2 for other PM 4Y model.

Make sure the weighing pan is placed properly on shock absorbers: the weighing pan cannot touch the housing and has to be stable.

Connect an indicator using port located at the back, next connect supplementary equipment.

Now, connect the device to the mains (power supply socket is located at the indicator).

3.4. MAINTENANCE ACTIVITIES

CAUTION!

Cleaning anti-draft chamber while still installed may cause damage of the measuring system.

1. Disassembly a weighing pan and other detachable components (the components differ depending on a balance type – see *Unpacking and Installation* section). Be careful while detaching the components so as not to cause any damages to the balance mechanism.

Cleaning ABS components:

To clean dry surfaces and avoid smutching use clean non-colouring cloths made of cellulose or cotton. You can use a solution of water and detergent (soap, dishwashing detergent, glass cleaner). Gently rub the cleaned surface and let it dry. Repeat cleaning process if needed.

In the case when contamination is hard to remove, e.g. adhesive, rubber, resin, polyurethane foam residues etc., you can use a special cleaning agents based on a mixture of aliphatic hydrocarbons that do not dissolve plastics. Before using the cleanser for all surfaces we recommend carrying out tests. Do not use products containing abrasive substances.

Cleaning anti-draft chamber panes:

Select dissolvent depending on a dirt. Never soak the glass panes in alkaline solutions since they interact with glass and may cause damage. Do not use abrasive substances.

For organic dirt use acetone first, next use water or detergent. For other than organic dirt use diluted acid solutions (soluble salts of hydrochloric or nitric acid) or base solutions (ammonium or sodium base).

To remove ACIDS use protofilic solvent (sodium carbonate), to remove BASE use protogenic solvent (mineral acid of various concentration).

In case of heavy contamination use brush or detergent nevertheless avoid detergents containing large and hard molecules which could potentially scratch glass panes.

Use soft brush with wooden or plastic handle exclusively to avoid risk of scratches. Do not use wire brush.

At the end of the cleaning process rinse the pane using running water first, distilled next.

Rinsing is a necessary cleaning process stage allowing to remove remaining soap, detergents and other cleansers from the panes prior their reinstallation.

Avoid drying the panes either using paper towel or forced air circulation since some fibres, grains or contamination of other type could permeate into the panes thus causing weighing errors.

One shall not use driers when drying measuring glass tools.

It is a frequent treatment to leave glass components on a rack to dry.

Cleaning stainless steel components:

Avoid using cleansers containing any corrosive chemicals, e.g. bleach (containing chlorine). Do not use abrasive substances. Always remove the dirt using microfiber cloth to avoid damage of protective coating.

In case of a daily maintenance:

1. Remove the dirt using cloth dipped in warm water.
2. For best results, add a little dishwashing detergent.

Cleaning powder-coated components:

For preliminary cleaning stage you need running water or wet sponge featuring large holes, this will help you to remove loose, heavy dirt.

Do not use cleansers containing abrasive substances.

Next using cloth and cleanser-water solution (soap, dishwashing liquid) gently rub the cleaned surface.

Avoid using cleanser without water since it may result with damage of the cleaned surface, please mind that large amount of water mixed with cleanser is a must.

Cleaning aluminium components:

While cleaning aluminium components use products acid by nature, e.g. spirit vinegar, lemon. Do not use abrasive substances. Avoid using hard brush, this may cause scratches. It is recommended to use microfibre cloth.

While polishing the surface use circular movements. Use clean, dry cloth.

3.5. POWERING THE DEVICE

The balance has to be plugged to the mains using the original power adapter exclusively. Plug the power adapter's to the power supply socket located at the back of the housing.

3.6. TEMPERATURE STABILIZATION

Before measurement it is necessary to wait until the balance reaches thermal stabilisation. For balances that were stored in much lower temperatures before plugging to the mains, thermal stabilisation period shall take at least 8 hours for PM balances. During the thermal stabilization, the indications on a display panel can change. It is recommended that ambient temperature changes at place of use were insignificant (slow to change).

3.7. CONNECTING PERIPHERAL EQUIPMENT

Use only accessories and peripheral equipment recommended by the manufacturer. The balance must be unplugged before connecting or disconnecting any peripherals (printer, PC computer, computer keyboard). On connecting the peripherals, plug the balance to the mains.

3.8. BALANCES FEATURING TERMINAL-WEIGHING MODULE WIRELESS CONNECTION

(an option)



The terminal operates on batteries, wireless connection ensures its cooperation with the weighing module. This, in contrast to a standard design, allows to eliminate cable connecting the devices. Wireless connection solution is marked by letter , e.g. **PM 10.4Y.B.**

Features:

Maximum range: 10 m

Maximum operation time of the terminal (without the necessity to charge batteries): 8 h

Advantages:

1. Lack of additional sources of vibration

Terminal located elsewhere than the weighing table eliminates vibrations being a result of operation. This ensures stable working conditions for balances with the highest resolution. No specific weighing workstations are needed.

2. Comfort of weighing in fume cupboards and laminar flow cabinets

Wireless connection between a terminal and a weighing module positively influences weighing process making it more comfortable and safer.

3. Elimination of unfavourable influence factors

Due to wireless connection the weighing module may be completely separated from the operator by being placed in an anti-draft chamber. This makes weighing of contaminated and toxic substances possible without putting one's health and life to risk.

4. Improved pipetting ergonomics

Pipettes calibration process requires precision and quickness of operation. Wireless connection redefines comfort of operation and guarantees high measurement accuracy.

Wireless solutions are equipped with 2 power suppliers. One used for supplying the weighing module, the other for powering the terminal.

3.8.1. Start-up Procedure

On unpacking and placing the balance onto its workstation it is necessary to connect the weighing module and the terminal to the mains. Next proceed like in case of a standard design (description to be found further down this user manual).

Home screen for wireless connection solution:

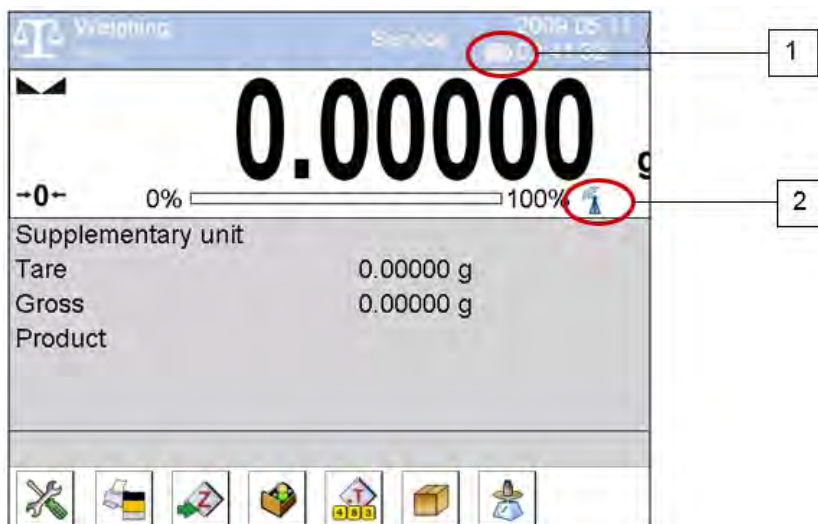

Home screen for wireless connection solution features two extra pictograms when compared to a standard design:

1. battery charge status pictogram
2. wireless connection pictogram

Operation and functions are identical like for standard design balances.

3.8.2. Pictograms Description

Battery charge status pictogram:

No.	Pictogram	Description
1		Battery charging
2		Battery charged, terminal connected to the mains
3		Battery charged, terminal not connected to the mains
4		Battery status (about 50%), terminal not connected to the mains
5		Low battery status, necessity of connecting the terminal to the mains



Wireless connection pictogram:

No.	Pictogram	Description
1		Correct connection of wireless modules – correct cooperation
2		Connection interrupted – loss of connection

3.8.3. Settings



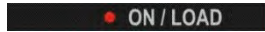



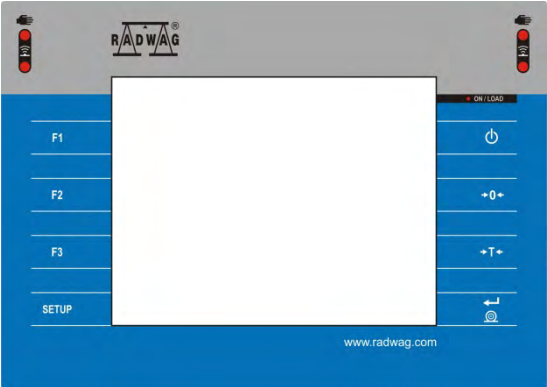

In order to provide long enough operation while powering the device by means of battery, the correct parameters of group Miscellaneous must be set, <Sleep mode> <Display brightness>. For detailed information go to section 34 of this user manual: *Miscellaneous*.

4. START-UP

1. On plugging the balance to the mains, instrument's diode ON/LOAD  located on indicator's housing is lit up.
2. Press  power key located on the left. Within a few seconds the OS Windows and RADWAG software start loading, it is signaled by flickering red diode ON/LOAD.
3. On completing the startup procedure, the main window of the balance software is displayed.
4. The balance starts up with no user logged in. In order to start operation it is necessary to log in. (logging procedure description to be found further down this user manual).

CAUTION! Remember to start the balance when unloaded.

5. KEYBOARD – BUTTONS' FUNCTIONS













	Key	Description
		Press to switch the balance ON/OFF
		Press to Zero the balance
		Press to Tare the balance
		Press to send measurement to a printer or a computer
		Press to enter the main menu of a balance
		Press to select working mode
		Press to select user profile
		Press to trigger an internal adjustment

6. SOFTWARE STRUCTURE

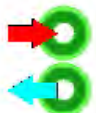
The main menu has been divided into function groups. Each group comprises parameters grouped by their reference. For detailed description of each menu group read later sections of this user manual.

List of groups - Parameters

Balance's main menu is accessed by pressing SETUP function key or  button located in the bottom tool bar of balance's display. The menu comprises parameters referring to balance settings, functions and profiles.

			
ADJUSTMENT	USERS	PROFILES	DATABASES
			
COMMUNICATION	PERIPHERALS	INPUTS/OUTPUTS	ACCESS LEVEL
			
MISCELLANEOUS	UPDATE	INFORMATION ON SYSTEM	MOVIES

7. WEIGHING MODE HOME SCREEN

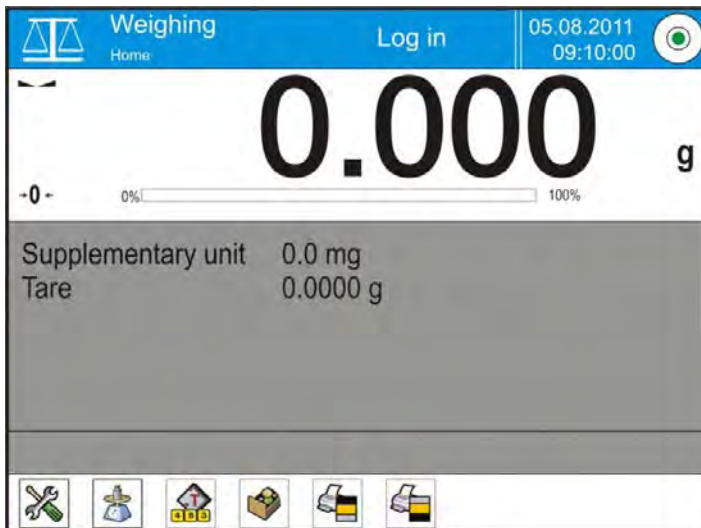

The main window of balance software can be divided into 4 sections:

- Top section displaying data on active working mode, logged operator, date, time, active connection to a computer and current level status of a balance.

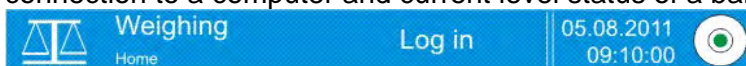

- Section presenting the weighing result and a current measuring unit.



- Grey workspace containing additional data on currently carried out activities.

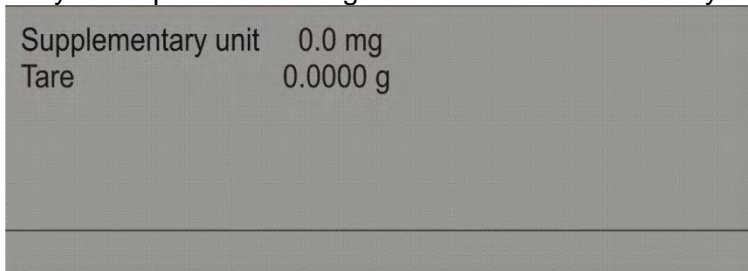

CAUTION!

Data contained in the workspace is freely configurable. For detailed information on data configuration refer to section 14.4 of this user manual.

- Workspace with set of soft keys:





CAUTION!

You can define the on-screen function buttons. For detailed instruction go to section 14.3 of this user manual.

8. LOGGING

Full access to user parameters and to editing databases requires logging as an operator with **<Administrator>** permissions level. Carry out logging procedure on each switching on of the balance.

First Log In operation - procedure:

1. Run home screen and press **<Log in>** button, operators database window opens with list of available users and  **<Admin>** entry.
2. Select  **<Admin>** parameter, the software activates an on-screen keyboard, use it to enter operator's password: „1111”.
3. Press  button to confirm.
4. Home screen of the software is displayed again automatically, **<Log in>** sign is replaced with **<Admin>** sign.
5. When logged, add users and set the permissions levels (for the procedure of assigning permissions levels read section 11 and 12).

On future Logging In, select a user from the list and enter the password, the software initiates operation with permissions level set for the selected user.

















Log out operation – procedure:

1. Run home screen and press logged user name, operators database window opens.
2. Press **<Log out>** button (position no. 1 of the list of operators).
3. Home screen of the software is displayed again automatically, **<Admin>** sign is replaced with **<Log in>** sign.

9. OPERATING BALANCE MENU

Operation of balance software menu is intuitive and uncomplicated. The touch panel makes the software operation easy. Pressing a function key, a soft key or an area on the display initiates an assigned function or process.



9.1. SOFT KEYS LIST

	or		Press to enter the main menu.
			Press to scroll the menu „up”.
			Press to scroll the menu „down”.
			Press to scroll the menu „up-down” fast.
			Press to confirm changes.
			Press to resign form introducing function modifications.
			Press to add a new record to a database.
			Press to search for a particular record in a database by date.
			Press to search for a particular record in a database by name.
			Press to search for a particular record in a database by code.
			Press to print out a particular record from a database.
			Press to clear the editing field.
			Press to enable / disable an on-screen keyboard.
			Press to read printout template from a file format *.lb (function key is active on plugging a USB flash drive to terminal's USB port)
			Press to select variables for a printout from a list.
			Press to move (exit) one level up.

9.2. RETURN TO WEIGHING MODE

Introduced modifications are automatically saved to menu on return to the weighing mode.

Procedure:

1. Press  soft key repeatedly, keep pressing the key until the balance home screen is displayed.
2. Press  soft key located on the balance overlay for immediate display of a home screen.

10. ADJUSTMENT

3Y series balances feature automatic internal adjustment system which ensures correct measurement accuracy. Menu <ADJUSTMENT> contains functions controlling operation of balance adjustment process.

10.1. INTERNAL ADJUSTMENT

Internal adjustment is carried out by means of an internal adjustment weight. **<Internal adjustment>** button, when pressed, automatically triggers adjustment process. Upon adjustment process completion respective message, informing about process end and about its status, is displayed.

CAUTION!

Adjustment procedure requires stable environmental conditions (no air drafts or ground vibrations). The process must be carried out with an empty weighing pan.





10.2. EXTERNAL ADJUSTMENT

External adjustment is carried out by means of an external mass standard of specified accuracy class and weight. Both, accuracy class and mass standard weight depend on balance type and max capacity. The process takes semi-automatic form, successive stages are signalled with prompts.

CAUTION!

External adjustment is possible for balances that are not a subject to conformity assessment (verification).

Procedure:

1. Enter <Adjustment> submenu, next select “ External adjustment” parameter.
2. “Remove weight” prompt is displayed.
3. Take the weight off the weighing pan and press  button. Whereas balance determines start mass, “Start mass determination” message is displayed.
4. Upon completed start mass determination procedure “Put weight ...” prompt is displayed along with particular mass standard value.
5. Put the required weigh on a pan and press  button.
6. Upon completed procedure “Remove weight” prompt is displayed.
7. Take the weight off the weighing pan, press  button, the balance proceeds to the weighing mode.

10.3. USER ADJUSTMENT

User adjustment is carried out with an optional standard of mass ranging between 0.15 Max and Max. User adjustment and external adjustment procedures are likewise with one exception, before user adjustment start a message box for entering mass of a standard used for user adjustment is opened.

CAUTION!

User adjustment is possible for balances that are not a subject to conformity assessment (verification).

In order to start user adjustment, enter <Adjustment> submenu and select ‘ User adjustment’ parameter. Then follow the prompts displayed on a screen.

10.4. ADJUSTMENT TEST

<Adjustment test> function enables comparing the result of an internal automatic adjustment with the value recorded in balance factory parameters. The comparison is used for determining balance sensitivity drift over time.

10.5. AUTOMATIC ADJUSTMENT

This menu is for declaring a value initiating an automatic adjustment. Accessible options:

- None – automatic adjustment disabled,
- Time – adjustment takes place in time intervals declared in menu <Automatic adjustment time> (10.6),
- Temperature – adjustment is triggered by temperature change only,
- Both – adjustment is triggered by both, temperature changes and time.

CAUTION!

Parameter settings can be modified only for balances that are not a subject to conformity assessment (verification).

10.6. AUTOMATIC ADJUSTMENT TIME

<Automatic adjustment time> parameter determines time interval between successive internal adjustments carried out automatically. The time interval is declared in hours and ranges between 1 and 12 hours.

To set time interval for automatic adjustment:

- select <Automatic adjustment time> parameter,
- using displayed menu, select appropriate time interval (given in hours) which is a time gap elapsing from the last carried out internal automatic adjustment until activation of the following automatic internal adjustment.

CAUTION!

Parameter settings can be modified only for balances that are not a subject to conformity assessment (verification).

10.7. SCHEDULED BALANCE ADJUSTMENT

<Scheduled adjustments> parameter allows you to specify precisely time for adjustment performance and interval between successive adjustments. The parameter is independent from automatic adjustment and criteria that trigger it (time, temperature). You can plan when internal and external adjustment shall be performed. In order to design schedule for external adjustment, it is necessary to record into balance memory mass standards for adjustment performance.

Parameter values:

1. Enter data of mass standards intended for external adjustment performance.
2. Enter user menu, select <Adjustment> parameter group and find <Mass standards> parameter, enter necessary data:

Edit record		Edit record		Adjustment weights	
1	Name	1	Name ETALON 01	1	ETALON 01
2	Code	2	Code		
3	Class None	3	Class E2		
4	Serial number	4	Serial number 123/RADWAG-2015		
5	Mass 0 g	5	Mass 100 g		
6	Set number	6	Set number 123456		

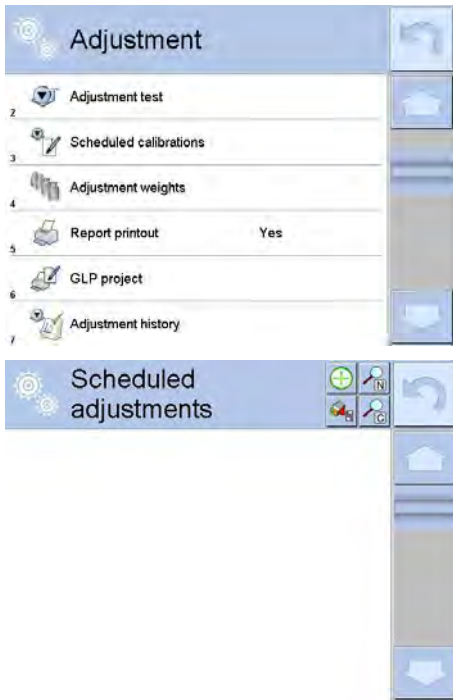

Enter user menu, select <Adjustment> parameter group and find <Scheduled adjustments> parameter.

Enter <Scheduled adjustments> parameter, wait for 'Scheduled adjustments' window to open, add adjustment procedures. Remember, only Administrator can add new positions.

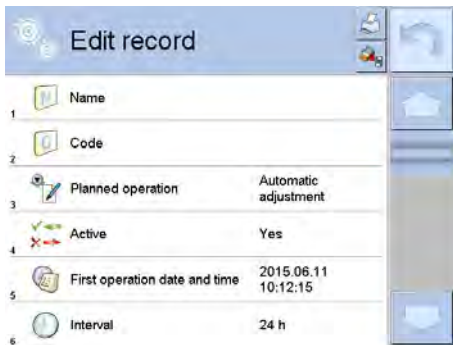

In order to add a new position, click  button, wait for a window with data on planned balance adjustment to open.

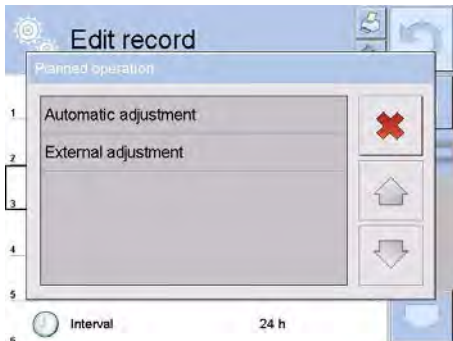

Select task: automatic adjustment (internal) or external adjustment.

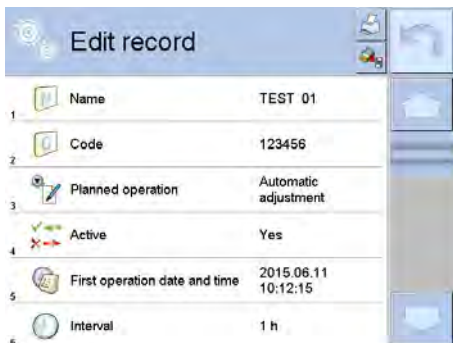

For automatic adjustment option, enter data on the adjustment and its schedule.

Edit record	
2	Code 654321
3	Planned operation External adjustment
4	Adjustment weight ETALON 01
5	Active Yes
6	First operation date and time 2015.06.11 11:00:00
7	Interval 24 h

Scheduled adjustments	
1	TEST 01
2	TEST 02



For external adjustment option, enter data on the adjustment, mass standard used for the adjustment performance and its schedule.

When all necessary data has been introduced, go back to the previous window. The window features newly added position relating to planned balance adjustment procedure.

Upon entering all data exit the menu.

Now all the adjustments are carried out automatically as planned and with specified time intervals.

10.8. REPORT PRINTOUT

Parameter  Report printout > determines whether or not a report on automatic internal adjustment is to be automatically printed on its completion. In order to set automatic report printout on adjustment completion go to parameter:  Report printout > and select value <YES>.

10.9. GLP PROJECT

GLP is one of many methods for documenting work in accordance with adopted quality system. Data selected for printing is printed on each release of a report on balance adjustment.

Information and signs to be used in a GLP report:

- adjustment (adjustment mode)
- working mode (working mode name)
- date, time,
- user,
- balance type,
- balance ID,
- level status,
- nominal mass,
- current mass
- difference
- temperature,
- blank line,
- dashes,
- signature,
- non-standard printout.

10.10. ADJUSTMENT HISTORY

Adjustment history contains data on all carried out adjustment processes. The record is carried out automatically. Each entry on adjustment comprises basic data on completed process. Balance menu enables displaying the list of completed adjustment processes, and each report is printable.

In order to print a report on adjustment process, enter <Adjustment> submenu, next enter <Adjustment history>, select adjustment to be printed. On displaying details of a record, press < > print key on display's top bar.

CAUTION!

If the balance memory is full then the oldest record gets automatically deleted.

If internal procedures of an organization require maintaining complete documentation from all carried out adjustment processes, then the list with records on adjustment has to be periodically printed and filed.

Searching for adjustment record

Balance enables searching for a specific record from completed adjustment processes:

– Press search icon  and insert date of adjustment process.

Exporting data on completed adjustment process

Connect a USB flash drive to balance's USB port. Press <Data export> button located in the top right corner of balance's display. The process is fully automatic, and on its completion, a file with extension *.tdb is saved on a USB flash drive connected to the USB port. The file can be edited using Excel spreadsheet or a text editor.

11. USERS

"Users" menu contains list of operators, who are authorized to operate the instrument.

The following data can be defined for each balance user:

- Name
- Code
- Password
- Access level
- Language
- Profile
- Card no.

New user can be added by the Administrator exclusively.

Procedure:

1. Enter Users menu, press <Add>  key,
2. Define all necessary fields.

CAUTION!

It is possible to search for a user in a database of users by code or name.

Edit data on a user:

Procedure:

1. Press field with name of a user.
2. The display indicates data on a specific user.
3. Select and change necessary data.

New user can be deleted by the Administrator exclusively.

Procedure:

1. Press and hold user name.
2. Menu referring to a user record is displayed.
3. Select <Delete> parameter.

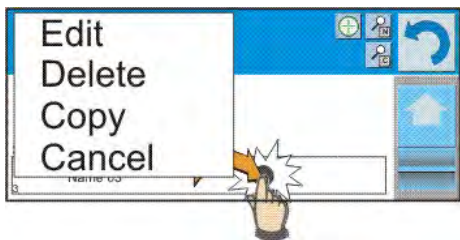

12. PERMISSIONS LEVELS





Access levels specify which operations are enabled/disabled for a particular user. This menu can be modified by the Administrator exclusively.

Anonymous user

The Administrator can grant access level to a balance user who is not logged in (Anonymous user).

Procedure:



1. Enter < Access level> menu.
2. Select < Anonymous user> parameter.
3. Set appropriate access level for the anonymous user. Available access levels for an anonymous user: Guest, User, Advanced User, Administrator.

CAUTION! Selecting <Guest> access level for not logged in user prevents him/her from modifying any balance settings.

Date and time

Default settings enable a user logged as the **Administrator** to modify date and time settings. The software enables changing access level for < Date and time> parameter.

Procedure:



1. Enter < Access level> menu.
2. Select < Date and time> parameter.
3. Set desired access level required to modify the settings. Available access levels for changing date and time settings are: Guest, User, Advanced User, Administrator.

CAUTION! Selecting <Guest> access level provides free access to date and time settings (no need to log in).

Printouts

Default settings enable a user logged as the **Administrator** to edit default printout templates. The software enables changing access level for < Printouts> parameter.

Procedure:



1. Enter < Access level> menu.
2. Select < Printouts> parameter and select one of available parameters: Guest, User, Advanced User, Administrator.

CAUTION! Selecting <Guest> access level provides free access to printouts settings (no need to log in).

Printout/Value Release

Default settings enable a user logged as the **User** to edit default printout templates. The software enables changing access level for < Value Release> parameter.

Procedure:

1. Enter < Access level> menu.
2. Select < Value Release> parameter and select one of available parameters: Guest, User, Advanced User, Administrator.

CAUTION!



Selecting <**Guest**> access level provides free access to printouts settings (no need to log in).

Movies

Default settings allow <Movies> menu to be accessed by the **Administrator** exclusively, as a result it is only the Administrator who can perform adding or deleting operations. Providing that respective modifications have been introduced by the Administrator, it is possible for remaining users to access

< Movies> menu options too.

Procedure:

1. Enter < Access level> menu.
2. Select < Movies> parameter, select one of available parameters: Guest, User, Advanced User, Administrator.



CAUTION!

Selecting <**Guest**> access level provides free access to movies settings (no need to log in).

Auto logout

Auto logout parameter has been designed to trigger logout operation when the balance stays inactive for specified time interval given in minutes. By default the parameter is set to <None> parameter.



Procedure:

1. Enter < Access level> menu.
2. Select < Auto logout> parameter, select one of available parameters: None/3/5/15/30/60. Time given in [min].

Databases

The Administrator is authorized to set appropriate access level required in order to enable modification of databases.

Procedure:

1. Enter < Access level> menu.
2. Select < Databases> parameter, set required access level: Guest, User, Advanced User, Administrator for each of the databases.

CAUTION!

Selecting <**Guest**> access level provides free access to databases editing.

13. PROFILES

A Profile is a data pack determining:

- functioning of working modes, e.g. parts counting, percent weighing, etc.,
- data to be displayed during working mode operation,
- function keys to be active,
- measuring units to be accessible
- criteria determining speed of operation and measurement stability,

Balance software allows you to create numerous profiles, this enables:

- each balance user to design an individual working environment
- customized balance operation, enabling/activating selected function keys and information (improving ergonomics of operation)

13.1. CREATING A PROFILE

A default profile is named <Home>. The Administrator can create new profiles by:

- Copying an already existing profile, modifying it,
- Creating a new profile.



Copying an existing profile

Procedure:

1. Enter main menu, to do it press **Setup** key.
2. Enter < Profiles> submenu.
3. Press and hold profile that is to be copied.
4. Menu referring to a profile record is displayed.
5. Select <Copy> parameter.
6. A new <Copy *name*> profile is created, all new profile setting and base profile settings are likewise.
7. Modify necessary data: (name, etc.).

Adding a new profile

Procedure:

1. Enter main menu, to do it press **Setup** key.
2. Enter < Profiles> submenu.
3. Press  key, message box: <Create new record?> is displayed.
4. Press  key to confirm. The software automatically adds a new record and enters its editing mode.

Deleting a profile

Procedure:

1. Enter main menu, to do it press **Setup** key.
2. Enter < Profiles> submenu.
3. Press and hold profile that is to be deleted.
4. Menu referring to a profile record is displayed.
5. Select <Delete> parameter.
6. Message box: <Confirm to delete> is displayed.
7. Press  key to confirm, the profile gets deleted.

CAUTION!

In order to operate profiles it is necessary to log in as an Administrator.

13.2. PROFILE STRUCTURE

Each profile contains the following entries:

Settings	Enter this menu to set an individual profile name (a order of alphanumeric characters), and to declaring a default working mode (the selected mode is activated as default on profile selecting).
Working modes	Contains the following submenu: <ul style="list-style-type: none">• Additional setting of a working mode• Function keys• Displayed information• Printouts
Readout	Contains the following submenu: <ul style="list-style-type: none">• Filter• Value release• Autozero• Autozero: Dosing• Last digit
Units	Enter this menu to declare the start unit, the supplementary unit, 2 custom units and to enter the value of gravitational acceleration force in balance's operation place.

13.2.1. Settings

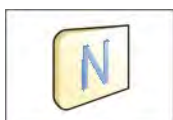

Name

On entering this option, the display opens a message box with keyboard. Insert name of a profile and press  key to confirm. The name is assigned to the profile.



Default working mode

On entering this option you can select a specific working mode, which is set as default in a profile. For <None> parameter set, upon selecting the profile, the balance activates the most recently used working mode.

13.2.2. Working Modes

On entering Working Modes option, the display opens a window containing all accessible working modes. Settings for each of the working modes can be customized, particular profile when activated runs with given set of parameters.

List of parameters to be modified:

- **Settings**
contain specific parameters relating to a working mode and universal settings, such as: result control, tare mode, automatic footer printout, printout mode, printout.
- **Functions of quick access keys**
declaring quick access keys to be visible in the bottom display bar
- **Information**
declaring information to be displayed in the grey workspace
- **Printout**
declaring type of a printout or defining a non-standard printout

13.2.3. Readout

The function enables you to adjust balance operation to ambient conditions (filter settings) or your individual needs. <Readout> menu contains the following elements:

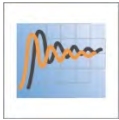

FILTER

Each measurement signal before being displayed is electronically processed in order to provide correct parameters specific for stable measurement result, i.e. ready to read.

You can determine signal processing extend, there are five different filters for you to select form:

- very fast
- fast
- average / normal
- slow
- very slow

While setting the filter consider the actual operating conditions. In case of very good operating conditions select average/normal or fast filter, in case of rough conditions select slow or very slow filter.

CAUTION!

For precision balances it is recommended to select very fast, fast or average filter.

For analytical balances and microbalances it is recommended to select average, slow, very slow filter.



Value release

The parameter has been designed to determine when the stability marker is to be displayed.

There are three different settings for value release parameter:

- fast
- fast + reliable /recommended/
- reliable



CAUTION!

Both parameters, filter and value release, determine how long it takes to obtain stable result.



Autozero function

The function has been designed to enable automatically carried out monitoring and correction of zero indication.

If the function is enabled, the following measurement results are compared to each other in constant time intervals. If the results differ less than declared AUTOZERO range, e.g. 1 division, the balance is automatically zeroed, and the markers of stable indication  and precise zero  are displayed.

Active AUTOZERO means, that each measurement starts from the precise zero point. There are, however, cases where the function may disturb the weighing process. For instance during very slow load placing or pouring onto the balance's weighing pan. In such case, the correcting system of zero indication may also correct the actual indication of a load placed on the weighing pan.

Accessible settings:

NO - autozero function disabled

YES - autozero function enabled



Autozero function: Dosing

The function has been designed to set autozero to default value selected for dosing.

Accessible settings:

NO - autozero operation is automatically disabled on entering dosing mode

YES - autozero operation is automatically enabled on entering dosing mode



Last digit

The function has been designed to enable/disable visibility of the last decimal place of measurement result.

Accessible settings:

ALWAYS: all the digits visible

NEVER: last digit invisible

WHEN STABLE: last digit visible only for a stable measurement

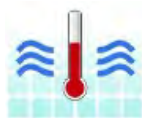

Ambient conditions

The parameter refers to ambient conditions. By default it is set to value **Stable**.

For unstable ambient conditions it is advisable to set the parameter to value **Unstable**.

Stable setting results with faster operation, i.e. weighing takes much less time than in case of setting to value **Unstable**.

Accessible settings:

Unstable

Stable

13.2.4. Measuring Units

For a selected profile you can declare start unit, supplementary unit and two custom measuring units.

A custom measuring unit features:





- A multiplier
- A name (3 characters)











Upon completed operation of designing a custom unit its name is added to the list of accessible measuring units.

Units menu additionally enables entering the value of gravitational acceleration force for balance's place of use. It is obligatory should a balance be used to determine mass in [N].

14. WORKING MODES

Standard 3Y series features the following working modes:

 Weighing	 Parts Counting
<p>Means of operation: weight of a load is determined through an indirect measurement. A balance measures gravitational force which attracts the load. An obtained result is processed to a digital format and displayed in a form of measurement result.</p>	<p>Means of operation: based on a determined mass of a single part it is possible to count another parts, assuming that mass of a single part is determined with sufficient accuracy, and that the following parts are equal in mass.</p>
 Checkweighing	 Dosing
<p>Means of operation: control of sample mass with applied thresholds. You have to specify the value of low threshold <LO> and high threshold <HI>.</p>	<p>Means of operation: you have to specify sample's target mass to be obtained by pouring.</p>

 Percent Weighing	 Density
<p>Means of operation: control of percent ratio of a sample in relation to a standard mass (reference weight). Obtained data provides percent ratio on how test sample differs from the accepted standard mass (reference sample).</p>	<p>Means of operation: based on Archimedes principle, a balance determines density of solids and liquids. The mode requires an optional density determination kit.</p>
 Animal Weighing	 Formulations
<p>Means of operation: mass measurement takes place with application of filters dampening animal moves on a weighing pan, thus enabling obtaining a correct measurement result.</p>	<p>Means of operation: by adding a order of ingredients, you can prepare an optional mixture or formulation. Before mixing balance software requires designing a formulation by specifying its ingredients and their mass.</p>
 Statistics	 Differential Weighing
<p>Means of operation: carried out measurements are used to calculate statistical data, such as Min, Max, deviation, etc.</p>	<p>Means of operation: analysis of mass sample change over time.</p>
 Statistical Quality Control	 Peak Hold
<p>Working mode is intended to carrying out different types of product packing processes and aimed at monitoring and / or controlling the packing process. It enables detecting excess or lack of product quantity in a packaging.</p>	<p>Means of operation: freeze of max weight value on a display (max. indication reflecting the greatest force exerted on a pan).</p>
 Mass Control	 Prepacked Goods Controls
<p>Working mode intended to carrying out quick statistical control of samples in accordance with the requirements on a quality system and/or internal standards. (mode not available in balance's standard version)</p>	<p>Working mode intended for PGC processes in accordance with the regulation on prepacked goods. (mode not available in balance's standard version)</p>

Working mode settings include special functions specific to a given mode. They enable customization of particular mode's operation. The special settings are activated on selecting a particular profile. For detailed overview of particular mode's special functions read section providing information on the mode in question.

14.1. RUNNING WORKING MODE

To run a particular working mode:

1. Press active working mode name, it is displayed in the top left hand corner.

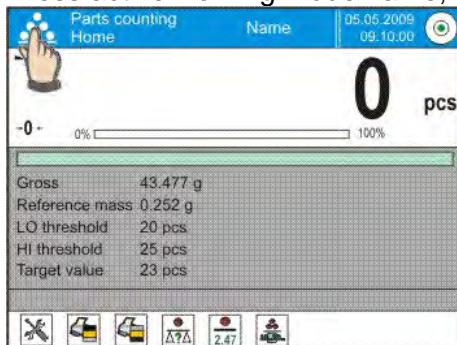

2. Wait for a list of available working modes to be displayed.
3. Select a particular working mode and press its name.

14.2. PARAMETERS RELATED TO A WORKING MODE

Each working mode has programmable parameters determining its functioning.

Procedure for entering the parameters:

1. Press grey workspace area
2. Wait to see the following menu:
 - <Settings> - additional options
 - <Keys> - defining quick access keys
 - <Information> - selecting information to be displayed in the workspace
 - <Printouts> - selecting printout type and content
 - <Profile> - selecting a profile to be active in the course of operation

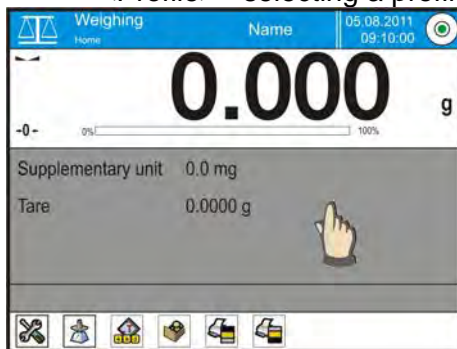

3. Enter particular submenu and select the component which is to be modified

For detailed information on parameters of <Settings> menu go to section 15.8 "Additional Parameters for a Weighing Process". For detailed overview of particular mode's parameters read section providing information on the mode in question.

14.3. QUICK ACCESS KEYS, PROXIMITY SENSORS

You can define up to 7 quick access keys, which are displayed in the bottom bar.

On assigning a function to a button a corresponding pictogram appears in the bottom navigation bar of the main window. It is a so called quick access key, dedicated for most often used functions and processes.

Each working mode features customized set of buttons. For complete buttons list read Appendix B.

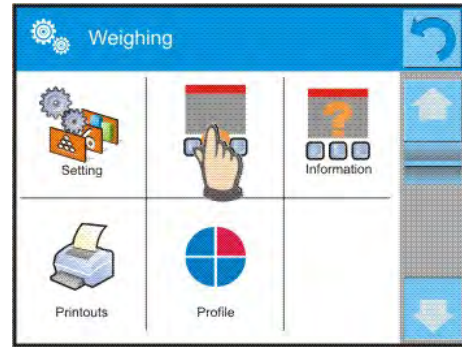

Caution:

You can view user manual saved to balance memory. In order to take advantage of this function help button



must be placed on a tool bar.

14.3.1. Proximity Sensors

The balance features two proximity sensors enabling touch-free balance control.

The software detects four motions performed around the sensors:

1. hand in a close vicinity to the left sensor <Left sensor>,
2. hand in a close vicinity to the right sensor <Right sensor>,
3. Hand motion to the left <Proximity sensor: left motion>,
4. Hand motion to the right <Proximity sensor: right motion>.

CAUTION!

Using **LEFT MOTION** or **RIGHT MOTION**, it is necessary to remember that <Proximity sensors delay> parameter must be set to value **500 ms!**

To each of the motions you can assign one of the available options: [None; Profile; Adjustment; Zeroing; Taring; Tare setting; Tare switch off; Reset tare; Packaging; Print; Header printing; Footer printing; Unit; Universal Variable 1; Universal Variable 2; Universal Variable 3; Universal Variable 4; Universal Variable 5; Confirm; Abort; User; Left door; Right door; Open/Close door; Parameters; Product, Warehouse; Customer].

The selected option is recognized by the software and performed when activated by a particular motion.

In order to ensure correct operation it is necessary remember to set the right sensors sensitivity and the right value for proximity sensors delay (for more information go to section 34 of this user manual).

14.4. INFORMATION

Information on weighing process is displayed in the grey workspace. It can contain up to 6 data. If larger amount of data is selected, then only the first 6 are displayed. Each parameter features two options:

- YES, information enabled (displayed in the workspace).
- NO, information disabled.

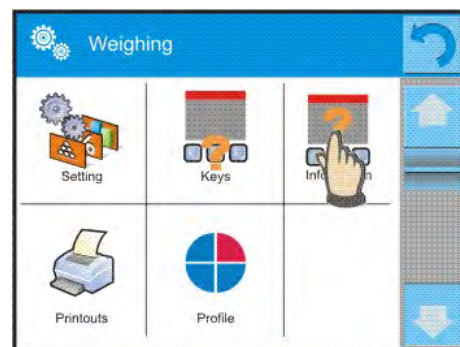

14.5. PRINTOUTS

Printouts menu comprises two separate sections:

- standard printouts,
- non-standard printouts.

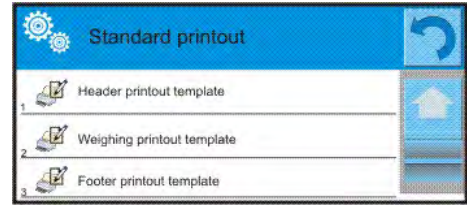

Standard printout

Standard printout comprises three internal sections featuring different variables. For each variable set option YES to include it in a standard printout. If option NO is selected, then the variable is disabled, i.e. it is not printed.

Procedure:

1. Press field with name of a template to be edited (Header – Weighing – Footer) and select variables to be printed.
2. If a printout is a non-standard one, create it.

Header

- Dashes
- Working mode
- Date
- Time
- Balance type
- Balance ID
- User
- Level status
- Customer
- Warehouse
- Product
- Packaging
- Universal variable 1 ... 5
- Empty line
- GLP report
- Non-standard printout

Weighing

- N (measurement quantity)
- Date
- Time
- Level status
- Customer
- Warehouse
- Product
- Packaging
- Universal variable 1 ... 5
- Net
- Tare
- Gross
- Current measurement result
- Supplementary weighing unit
- Mass
- Non-standard printout



Footer

- Working mode
- Date
- Time
- Balance type
- Balance ID
- User
- Level status
- Customer
- Warehouse
- Product
- Packaging
- Universal variable 1 ... 5
- Dashes
- Empty line
- GLP report
- Signature
- Non-standard printout

Basic principles related to printouts

1. In order to print WEIGHING section variables press PRINT button on balance's overlay, only variables with attribute YES can be printed (see the above list).
2. Variables with YES attribute present in the HEADER and FOOTER are printed ONLY on pressing PRINT HEADER and PRINT FOOTER pictograms. The pictograms have to be added to the bottom bar of the display, as quick access keys.

For detailed instruction on how to add quick access keys to the bottom bar of the display go to section 14.3.

	
Print header data	Print footer data

CAUTION!

Measuring units for mass indication:

- Net – main measuring unit (adjustment unit)
- Tare – main measuring unit (adjustment unit)
- Gross – main measuring unit (adjustment unit)
- Current result – currently displayed measuring unit
- Supplementary unit – supplementary measuring unit
- Mass – main measuring unit (adjustment unit)

Non-standard printout

Non-standard printout may contain: TEXTS and VARIABLES (which are acquired from the software). Each non-standard printout is a separate project, featuring specific name, by which it is identified, and saved to the database of printouts.

Procedure:

1. Press <Non-standard printout> field.
2. Press < Add> button, a window featuring Name/Code/Project data opens.
3. Set name and code of a printout.
4. Press <Project> button, a keyboard is opened on the display for editing the printout.
5. Use the keyboard to design printout template, the printout may contain texts and variables.

CAUTION!

It is possible to add a printout by importing configured texts from flash drives connected to balance's USB port. Printout's name is ONLY a NAME, and it is not part of its content. For information on how to design a non-standard printout template read section 30.19 <Printouts>.



14.6. PROFILES

Profiles function has been described in section 13 Profiles.

15. WEIGHING OPERATION

Load a weighed object on a balance weighing pan. On stabilization of weighing result, indicated by stability marker  visible on the left side of balance display, read the measurement result.

Record / printout of the measurement result is available on pressing <PRINT> key:

- for verified balances – only stable measurement result can be saved or printed (stability marker  visible on balance's display),
- for non-verified balances – stable or unstable measurement result can be saved or printed (regardless of stability marker  absence). For unstable measurement result question mark <?> is printed next to the mass value.

15.1. WEIGHING UNIT SELECTION

Change of weighing unit is carried out by pressing the weighing unit icon visible next to the value of measurement result. Clicking the unit triggers display of available units list. Select the unit you need, the software automatically recalculates indicated value.

Units list:

Unit	Denotation	Verified balance	Unit	Denotation	Verified balance
gram	[g]	yes	Taele Hongkong	[tlh]	no
milligram	[mg]	yes *	Taele Singapore	[tls]	no
kilogram	[kg]	yes *	Taele Taiwan	[tlt]	no
carat	[ct]	yes *	Taele China	[tlc]	no

pound	[lb]	no	Momme	[mom]	no
ounce	[oz]	no	Grain	[gr]	no
ounce Troy	[ozt]	no	Newton	[N]	no
pennyweight	[dwt]	no	Tical	[ti]	no

* - Accessibility of measuring units is conditioned by balance type.
 SI system units are accessible for non-verified balances

15.2. GOOD WEIGHING PRACTICE

In order to ensure long lasting use of a balance plus correct and reliable measurement of weighed loads, follow below procedures:

- Start the balance with no load on the weighing pan (permissible value of load on the weighing pan on balance start is $\pm 10\%$ of its maximum capacity).
- Load the weighing pan steadily avoiding shocks:

YES

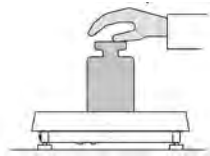

NO



- Place weighed loads centrally on the weighing pan:

YES

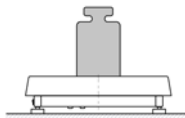

NO

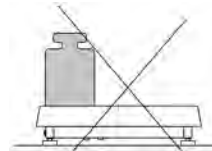

- Avoid side loading, in particular side shocks:

NO

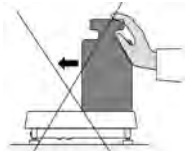

NO

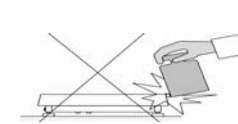



15.3. BALANCE LEVELLING

The PM series features AutoLEVEL System, which continuously monitors level status during balance operation. The level status is signaled in the top right hand corner of a display. The system continuously controls level, and on detecting any change it indicates appropriate information on the display and/or starts an alarm, as a result a window for adjusting the level is displayed.

Balance levelling procedure

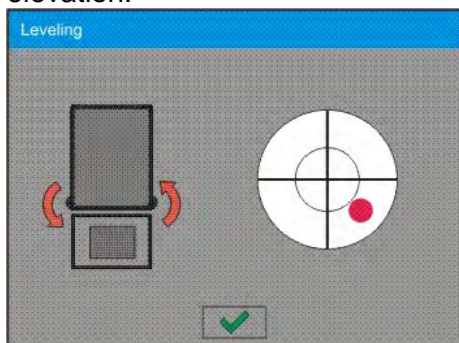
1. Press level status pictogram  located in the top right hand corner of the display.
2. Control panel of leveling function is displayed, it features level status and balance's top elevation.





3. Level the balance, to do it turn the feet in a way indicated by blinking pictograms on the display  – the level point moves towards the center of the level circle.
4. As the level point is in the center point, its colour changes from red to green – which is a confirmation for correct level status.

CAUTION!

The balance is equipped with Automatic Level Control mechanism. For detailed information go to section 34.8 of this user manual.

15.4. BALANCE ZEROING



Zeroing is a function allowing to zero mass indication. In order to zero mass indication, press  button. Mass indication of zero value is displayed together with precise zero **+0+** and stability  markers.

Zeroing process is an equivalent for determining new zero point, recognized by the balance as precise zero. Zeroing is possible only for stable status of display indication.

CAUTION!

Zeroing the display indication is possible only within $\pm 2\%$ range of instrument's maximum capacity. If the zeroed value is above $\pm 2\%$ of the maximum capacity, then the software indicates a respective error message, **Err2**.

15.5. BALANCE TARING

Taring is a function allowing to determine net weight of a measured object. In order to determine net weight of the object, place object's container (packaging) on the weighing pan, and on stabilization of measurement result press  key. The display indicates mass equal zero and symbols: **Net** and . On taking off the weighed load and its packaging from the weighing pan, the display indicates sum of total tared mass with minus sign.

The software enables assigning tare value to a database-stored product. Using this option, the software automatically uploads data on tare value for a particular product upon its selection from the database.

CAUTION!

Taring negative values is impossible. On taring negative values the balance responds with an **Err3** message. In such case, zero balance indication and repeat taring procedure.

Manual tare determination

Procedure:

1. While in optional mode press quick access key, .

2. An on-screen numeric keyboard is displayed.
3. Enter tare value and press  key.
4. The balance returns to the weighing mode, and the display indicates entered tare value with minus '-' sign.

Deleting tare

The tare value indicated on a balance display can be deleted by pressing  key on a balance overlay, or by using programmable function key <Deactivate tare>.



PROCEDURE 1 – on taking the tared load off the weighing pan

1. Press  key.
2. The NET marker is deleted, and new zero point of the balance is determined.

PROCEDURE 2 – with tared load on the weighing pan

1. Press  key.
2. The NET marker is deleted, and new zero point of the balance is determined.
3. When tare value exceeds 2% of the maximum capacity, Err message is displayed in order to inform you about the fact operation cannot be carried out.

PROCEDURE 3 – when the tared load is on the weighing pan or on taking the tared load off the weighing pan

1. Press programmable key <Deactivate tare> .
2. The NET marker is deleted.
3. The display indicates tare value.
4. Press <Restore tare>  key to restore the last tare value .

15.6. USE OF AIR BUOYANCY COMPENSATION FACTOR

The application enables correcting mass measurement errors in the course of:

1. weighing loads of density considerably different from the density of standard that has been used to adjust the balance; typically the balance is adjusted with a steel mass standard with density $\sim 8.0\text{g/cm}^3$ or a brass mass standard with density $\sim 8.7\text{g/cm}^3$; if loads made of other substances are weighed, then ratio indicated on below chart applies.

Error value in relation to density of weighed sample

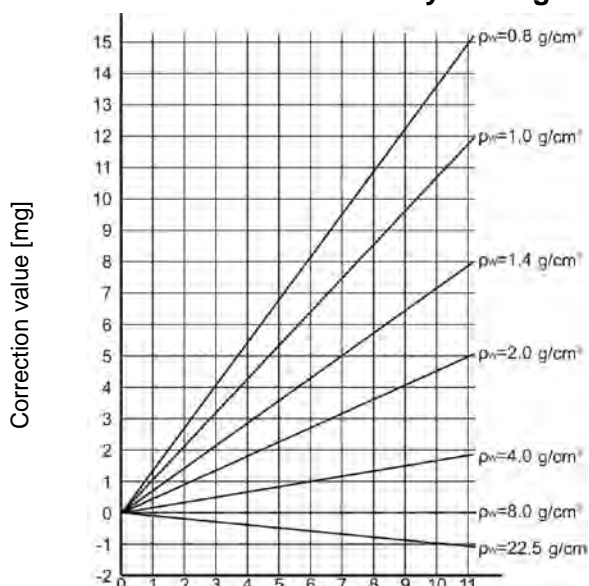

The chart presents correction values for mass in relation to the density of weighed load, assumption that air density is constant and equals 1.2 kg/m^3 is taken.

Sample mass [g]

2. testing sample mass change within a few hours long period of time for a case when the sample mass is relatively constant (minor changes); it is assumed that air density changes affect considerably the final result, wherein the density is influenced by changes of pressure, temperature and humidity.

In order to carry out a reliable measurement it is necessary to know the measuring methods, features of tested sample, air density in the laboratory room and density of weighed sample.

Functioning

The air buoyancy compensation procedure is to be used as follows:

1. Method 1:
Enter air density value and value of weighed sample density to balance's memory. Wait, the software automatically calculates the correction factor for weighed mass, next corrected value of weighed mass is displayed. In order to avoid mistakes, the corrected mass value is accompanied by <!> symbol, the symbol is visible on a display and a printout.
2. Method 2:
Determine air density value with use of balance software (semi-automatic operation) and enter value of weighed sample density to balance's memory.
Determination of air density is carried out using a set of two mass standards, one made of stainless steel, and the other one of aluminum. Based on mass indications of the two standards, the software automatically calculates the air density and saves the value in balance's memory on operator's confirmation. Now, enter value of weighed sample density to balance's memory. Wait, the software automatically calculates the correction factor for weighed mass, next corrected value of weighed mass is displayed. The corrected mass value is accompanied by <!> symbol, the symbol is visible on a display and a printout.

In order to enable/disable the air buoyancy compensation procedure go to the user menu. The procedure is valid for weighing mode exclusively.

Air Buoyancy Compensation Start-Up

Procedure:

1. Enter home screen and press grey workspace.
2. Select <Settings> parameter.
3. Select < Air buoyancy compensation> parameter.

Parameter values:

- Air buoyancy compensation – YES/NO.
- Sample density (enter value of weighed sample density). If you use products from databases, then on product selection its density value is automatically uploaded.
- Air density – parameter designed to enable selecting the method of entering the air density value.

PARAMETER VALUES:

VALUE – select to open a window where you enter specified air density value (e.g.: determined by means of other methods). The entered value is used in the course of compensation. It is assigned

automatically upon completed air density determination after <> key has been pressed.

ONLINE – select to make the balance acquire air density value from a connected THB sensor at a real time, if such is connected to the balance, or from internal sensor installed in the balance.

If your balance features both types of sensors (THB module and internal sensor), then data from the THB module supersedes the other, in such case go to **Setup/Ambient Conditions/Ambient Conditions Module** and set SAVE or SAVE & ALERTS parameter.

If your balance features only one set of sensors recording temperature, humidity and pressure, then correct ONLINE operation requires setting the following parameters:

- internal sensors exclusively – go to **Setup/Ambient Conditions/Ambient Conditions Module** and set NONE value,
- external THB module exclusively – go to **Setup/Ambient Conditions/Ambient Conditions Module** and set SAVE or SAVE & ALERTS value.

For correct balance cooperation with the THB module it is necessary to set port's transmission parameters, they must be compatible with those of the THB module. The THB module transmission parameters are detailed on its data plate.

On returning to the weighing mode, the display indicates an additional symbol <!>, as indicated on the figure below. From now on the value of indicated mass is corrected including the air buoyancy compensation factor and sample density.



The measurement result can only be compensated by a correct value if the operator enters the actual value of the air density and correct value of weighed sample density to balance's memory.

CAUTION!

If the <AIR BUOYANCY COMPENSATION> parameter is set to <ONLINE> parameter, then pictogram <!> is not displayed. This means that parameter **Setup/Ambient Conditions/Ambient Conditions Module** is set to SAVE or SAVE & ALERTS value, and that there is no physical connection between a balance and a THB module, or that balance-module communication parameters are incorrect. In such case plug a THB module to balance's ports COM 1 or COM 2 and set appropriate communication parameters, for the parameters refer to a data plate.

15.7. ADDITIONAL PARAMETERS FOR A WEIGHING PROCESS

Modification of weighing functions enables programming balance operation.

Procedure:

1. Press grey workspace.
2. Settings, Keys, Information, Printouts, Profile submenus are displayed.
3. Select submenu, press it, select submenu item that is to be modified.
 - <Settings> - additional options related to weighing mode
 - <Keys> - defining quick access keys
 - <Information> - supplementary data on weighing process displayed in Info field
 - <Printouts> - selecting printout type
 - <Profile> - selecting profile that is to be active during balance operation
 - <SETTINGS> - weighing process related data such as:

Tare mode

- SINGLE
mass value stored in balance memory on single pressing of TARE key, the following pressing of TARE key determines new value of tare. Selection of product or packaging with assigned tare value causes automatic deleting of previously assigned tare value;
- SUM OF ACTIVE
sum of product tare value and packaging tare value (this operation is a consequence of selecting a product and a packaging from database) plus tare value entered using balance's numeric keyboard if needed. When new tare value for a product or packaging is entered then tare value entered manually gets deactivated.
- SUM OF ALL
Sum of all entered tare values.
- AUTOTARE

Means of operation:

Each first stable measurement result is tared. The NET pictogram is displayed. Now you can determine net mass of weighed load. On unloading the weighing pan, and as the indication returns to autozero zone, the software automatically deletes tare value.

Automatic footer printout

Options:

- MODE – No – manual footer printout,
Sum of measurements – footer is printed when mass value entered in <Threshold> parameter is out of range
Measurements quantity – footer is printed when a pre-defined measurements quantity (a batch) set in parameter <Threshold> is carried out
- THRESHOLD – setting the threshold value determining footer printout.
For <Sum of measurements> parameter threshold is determined in measuring unit [g], for <Measurements quantity> parameter the unit is not determined, provided value specifies carried out measurements quantity.

Printout mode / release

- PRINT / release button, (manual operation)
Never – printout deactivated
First stable – the first stable measurement is printed
Each stable – all stable measurements are set for printing
Each – all measurements are printed (stable and unstable), in case of a verified balance only stable ones (as in setting <Each stable>)
- AUTOMATIC MODE
Never – printout deactivated
First stable – the first stable measurement result obtained after placing a load on balance's weighing pan is recorded, record of the following measurement result takes place only on unloading the weighing pan, returning of the mass indication below set threshold's value, and placing another load on the weighing pan
Last stable – only the last stable measurement is accepted, i.e. measurement recorded before taking the load off the weighing pan. The record takes place on taking the load off the weighing pan, and returning of the mass indication below set threshold's value.
With interval – automatic printout and record of weighing results, carried out in a cyclic manner as often as specified by <INTERVAL> parameter. The interval is set in minutes, values range is 1 – 9999.
CAUTION!
Each weighing result is printed and recorded (both stable and unstable for non-verified balance, stable for verified balance).
The measurements start to be printed and recorded as soon as you enable automatic operation with interval. First stable weighing result of value higher than THRESHOLD value is recorded as the first measurement. Successive measurements are printed as often as specified by <INTERVAL> parameter. To end automatic operation with interval disable this function.
- THRESHOLD
mass value obligatory for operation of automatic printout, set in grams.
- INTERVAL
Record frequency for automatic operation with interval

Printout

Printout type related to a working mode. Printout is activated by pressing PRINT key on the overlay.

Options:

- STANDARD PRINTOUT
Enables declaring printout content: HEADER, WEIGHING DATA and FOOTER. Select <YES> parameter for the components that are to be printed on pressing printout activating function key.
- NON-STANDARD PRINTOUT

Enables selecting one of database-stored non-standard printouts from a list of <PRINTOUTS> menu, or designing a unique printout which is automatically added to the database.

Caution: For information on how to design printouts go to section 14.5.

Air buoyancy compensation

Parameters allowing you to switch on the compensation and to enter weighed sample density data and air density data.

CAUTION! The function is valid for weighing mode exclusively.

For information on how to set air buoyancy compensation go to the previous section.

15.8. MINIMUM SAMPLE WEIGHT

The weighing mode settings comprise <Minimum sample weight> function. In order to use the function it is necessary to enter data related to minimum sample weight determination methods and minimum sample weight values for a given method. The data must be entered to < Minimum sample weight> database. The database is empty in standard balance version.

Determining minimum sample weight and adding data to the database: </Minimum sample weights> database can be carried out by an authorized “RADWAG” personnel exclusively.

Should you use the minimum sample weight function, and need data on minimal sample weight to be entered to balance menu, please contact the local representative of “RADWAG” company.

An authorized RADWAG representative determines the minimum sample weight depending on packaging mass. The process is carried out with mass standards, in balance place of use and in accordance with the requirements of the accepted quality system. The obtained values are entered to balance software: <Minimum sample weights> database.

A minimum sample weight determining method may have a few tare values defined, along with assigned values of minimum sample weights, expiry dates of the carried out measurements and entered data. The settings are not to be edited by a balance user.

Using <Minimum sample weight> function guarantees that the results of completed weighing processes are within set tolerance limits, and they comply with the requirements of the quality system accepted by an organization.

CAUTION! The function is valid for weighing mode exclusively.

PARAMETER VALUES:

- **METHOD**
Option allowing you to designate used quality standard. Press METHOD field to open a window with a list of database-stored methods by means of which the minimum sample weights were determined. In order to add a new method you have to go to <Databases /Minimum sample weights>
- **MODE**
Lock – select in order to make the balance display pictograms informing you on status of weighed mass (weighed mass below/above minimum sample weight) and to disable accepting the measurement result if it is below the minimum sample weight limit
Warn – select in order to make the balance display pictograms informing you on status of weighed mass (weighed mass below/above minimum sample weight). You can accept the measurement result if it is below the minimum sample weight limit, mind that on a printout it will be preceded by an asterisk (*).

CAUTION!

For information on how to enter a method for minimum sample weight go to section 30.14 <Databases /Minimum sample weights>. New minimum sample weight values can be entered by an authorized “RADWAG” personnel exclusively.

Weighing with use of <MINIMUM SAMPLE WEIGHT> function

With <Minimum sample weight> function on you are informed whether the measurement is out of minimum sample weight limit determined for a specific weighing range. To turn the function on go to the weighing mode settings.

Procedure:

1. Press grey workspace.
2. Settings, Keys, Information, Printouts and Profiles submenus are displayed.
3. Select <Settings> menu - additional weighing process options.
4. Press <Minimum sample weight> field.
5. Wait for Minimum sample weight window to open.

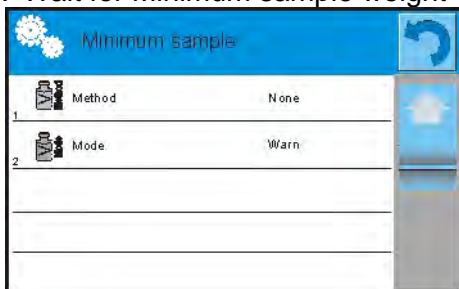

6. Press <Method> field, window with a list of database-stored methods opens.
7. Select the method you need.
8. Previous screen is displayed.
9. Press <Mode> field, window with the following parameters opens:
Lock – select in order to make the balance display pictograms informing you on status of weighed mass (weighed mass below/above minimum sample weight) and to disable accepting the measurement result if it is below the minimum sample weight limit
Warn – select in order to make the balance display pictograms informing you on status of weighed mass (weighed mass below/above minimum sample weight). You can accept the measurement result if it is below the minimum sample weight limit, mind that on a printout will be preceded by an asterisk (*).
10. Set the parameters and exit the menu.
11. A new pictogram is displayed in mass field. The pictogram indicates current status of mass in relation to the pre-determined value of minimum sample weight.

<p>Mass below the set minimum sample weight value specified for a given tare range.</p>	<p>Mass above the set minimum sample weight value specified for a given tare range.</p>

Minimum sample weight function pictograms:

	<p>Mass below the set minimum sample weight value.</p>
	<p>Mass above or equal to the set minimum sample weight value.</p>
	<p>Mass below the set minimum sample weight value, a pictogram with a clock informs on expiry of the minimum sample weight validity period (it is displayed two weeks before the determined expiry date).</p>
	<p>Mass above the set minimum sample weight value, a pictogram with a clock informs on expiry of the minimum sample weight validity period (it is displayed two weeks before the determined expiry date).</p>

	<p>The validity period of the minimum sample weight has expired. The minimum sample weight settings need to be modified. The minimum sample weight settings can be modified by an authorized RADWAG personnel exclusively.</p>
---	--

CAUTION!

If more than one reference tare value is programmed (with corresponding minimum sample weight mass) then the indicated value automatically moves to a range corresponding to the weight of the tared container. At the same time the required minimum mass is changed.

15.9. COOPERATION WITH TITRATORS

In order to provide correct cooperation with Titrators, go to settings of standard printout content and set <Mass value for a titrator> parameter to <Yes> parameter. With this, other variables for the printout are turned off.

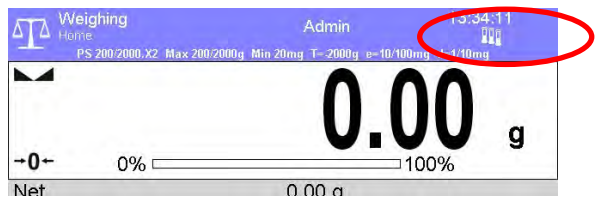
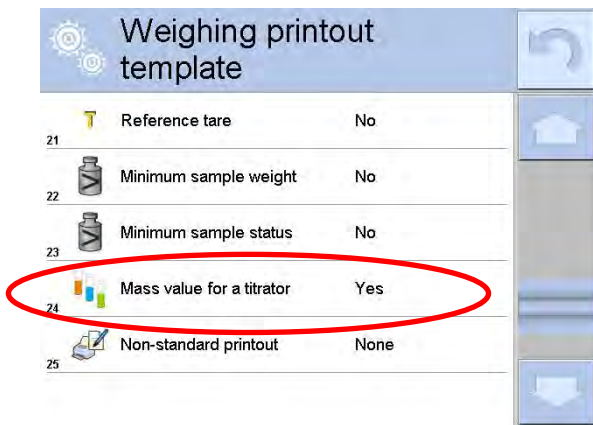



With <Yes> parameter on, a respective pictogram is displayed in the top bar of a home screen. The pictogram informs on special format of mass printout, permissible by TITRATORS.

16. PARTS COUNTING

< **Parts counting**> is a working mode enabling determination of quantity of small parts with equal weight. Determined mass of a single part is used for the counting procedure. The single part mass may be:

- determined from a reference quantity of parts subjected to weighing,
- acquired from database of products,
- entered manually as a numeric value.

Procedure for activation of Parts Counting mode:

1. Go to the home screen, press  pictogram.
2. <Working modes> submenu with list of available operation modes opens.
3. Select < Parts counting> mode, home screen featuring parts counting pictogram  in a top bar is automatically displayed.

Parts Counting mode screen.

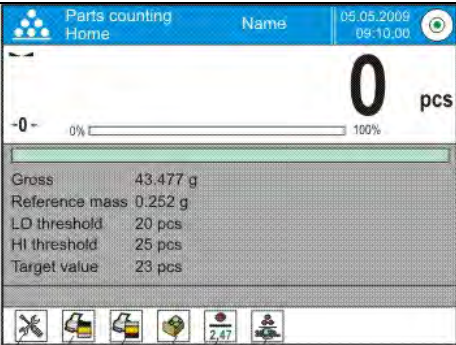
	<ol style="list-style-type: none"> 1. Setup – press to access balance menu 2. Print header – press to print data declared in the header 3. Print footer – press to print data declared in the footer 4. Products Database – press to select products from a corresponding database 5. Set part mass – press to edit field for entering mass of a single part 6. Determine part – press to set mass of a single part using reference sample comprising specified number of parts, e.g.: 10 pcs, 20 pcs, 75 pcs, etc.
---	---

16.1. SUPPLEMENTARY SETTINGS FOR PARTS COUNTING MODE

The supplementary settings enable adjusting the working mode to your needs and requirements. To access the settings follow the below procedure.

Procedure:

1. Press grey field, menu is displayed.
2. Select <Settings> parameter, list of functions related to Parts Counting mode is displayed:

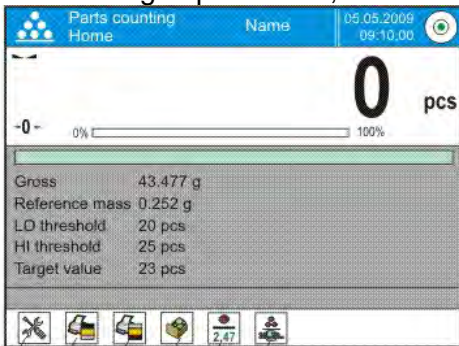

- **ACAI**, Automatic Accuracy Correction values:
 - YES, single part mass is updated,
 - NO, single part mass is not updated.
- **Minimum reference mass**: 1unit, 2units, 5units, 10units, it is the minimal mass value of a single part. Unless the condition is met, counting process cannot start.
- **Result control**:
 - YES, print and save only those measurements which are included within the Lo and Hi thresholds.
 - NO, all measurements are printed and saved.
- **Tare mode**
- **Automatic footer printout**
- **Printout mode / Value release**
- **Printouts**

For means of operation of ACAI function read below, to find out more about the remaining functions go to section 15.8.



Means of operation of ACAI function:

1. Number of parts (on adding) on the weighing pan has to be greater than before.
2. Number of parts (on adding) on the weighing pan must be less than twice the amount displayed before adding the parts.

3. Current quantity of parts must be within $\pm 0,3$ tolerance of the total value.
4. Measurement result has to be stable.

16.2. SETTING REFERENCE MASS BY ENTERING DETERMINED PART MASS

Procedure:





1. Press  Determine part mass> key or the label, <Reference mass> editing window featuring an on-screen keyboard is displayed.
2. Enter the requested value and confirm by pressing  key,  Parts counting> mode is run with automatically specified part mass.

CAUTION!

If you enter weight of value that is lower than 0.1 reading unit, then <Value too low> message is displayed.

16.3. SETTING REFERENCE MASS BY DETERMINING PART MASS

Procedure:

1. Put a container on a weighing pan, tare its mass.
2. Press  Determine part mass> button, <Reference quantity> editing window featuring an on-screen keyboard is displayed.
3. Enter the requested value and confirm by pressing  key.
4. Message on number of parts to be loaded is displayed: <Number of parts to be loaded: xx> (where xx – previously entered value).
5. Put specified number of parts on the weighing pan, when the result is stable ( stability pictogram displayed) press  key to confirm.
6. The software automatically recalculates single part mass, next it moves to  Parts counting> mode displaying number of parts loaded on the weighing pan (pcs marking).

CAUTION!

It is important to remember the following:

- Total mass of all parts loaded on the weighing pan must not exceed the maximum capacity (weighing range) of the balance;
- Total mass of all parts loaded on the weighing pan must not be lower than value declared in parameter “Minimum reference mass”. Unless this condition is met, the balance displays a message: <Sample mass too low>;
- Mass of a single part must not be lower than 0,1 of balance reading unit. Unless this condition is met, the balance displays a message: <Single part mass too low>.

16.4. ACQUIRING PART MASS FROM A DATABASE

Each product recorded in a database of products features set of information which allow to identify it. Among the information there is mass value used during part counting process.

Procedure:

Operating  Parts counting> mode, press  Products> button and using the list select a particular product.

Entering reference mass to balance memory

Procedure for entering single part mass to products database:

1. Press <Setup> button, next press <Databases> button.
2. Go to products database and press <Products> button.
3. Press product name and modify weight value (field [5]).
4. Return to <Parts counting> mode.

Procedure for entering single part mass to products database when there is no data entered yet:

1. Press <Setup> button, next press <Databases> button.

2. Go to products database and press <  Add > button.
3. Fill in product related fields, weight value (field [5]) among many.
4. Return to <Parts counting> mode.

16.5. UPDATING PART MASS IN A DATABASE

Determined single part mass can be assigned to a product in the database of products. This option is applied while using ACAI (Automatic Accuracy Correction) function in order to determine part mass with high accuracy.

Procedure:

1. Determine single part mass.
2. Press <  Products > button.
3. Press and hold name of a product mass of which is to be updated.
4. Contextual menu is displayed.
5. Select < **Assign reference sample mass** > parameter, reference mass is saved to a product record under < **Mass** > entry.

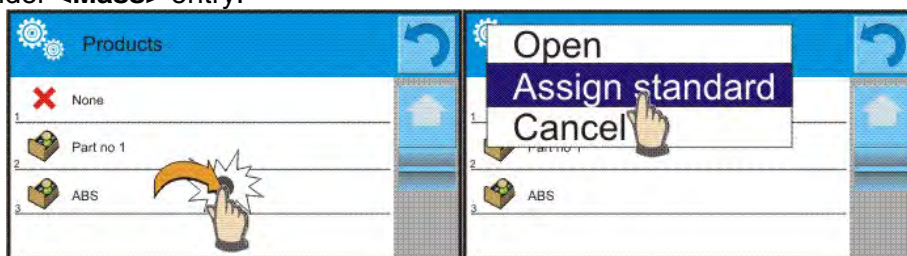

16.6. PARTS COUNTING PROCEDURE

The first step for Parts Counting mode is obtaining data on mass of a single part. Select one of available options:

- Give weight value of a single part (see section 16.3) and put parts to be counted on the weighing pan, balance displays total amount of parts.
- Determine mass of a single part from a given quantity of parts (see section 16.4.). Put parts to be counted on the weighing pan, the balance displays total amount of parts. In the course of calculation, ACAI function pictogram <  > is displayed (providing the function is active).
- Acquire mass of a single part from database of products (see section 16.5.) by selecting a desired product record. Put parts to be counted on the weighing pan, the balance displays total amount of parts.

CAUTION!

Any additional elements (packaging) shall be tared prior to counting process start.

16.7. CHECKWEIGHING FOR PARTS COUNTING MODE

Parts counting process can be aided by checkweighing function, i.e. control whether indication is within set thresholds.

Checkweighing requires setting values for two thresholds:

- LOW threshold [Min= ... parts]
- HIGH threshold [Max= ... parts]

and setting YES value for Bar graph. The Bar graph displays relation:
CURRENT NO. OF PARTS / CHECKWEIGHING THRESHOLDS.

In order to define Low and High thresholds' values open Products Database and edit the Product record, or use a quick access key, < Defining thresholds>.

Procedure:

1. Press grey workspace, next select <Information> parameter.
2. Set Bar graph to YES value, return to parts counting mode.
3. Press grey workspace, next select <Keys> parameter.
4. Assign <Checkweighing Thresholds> parameter to one of the quick access keys displayed in the bottom bar.
5. Return to parts counting mode.
6. Press < Checkweighing thresholds> key and enter values for LOW and HIGH thresholds, return to parts counting mode.
7. Bar graph is displayed, its colour corresponds to the status of parts counting process.
 - Yellow: current number of parts below the set Low threshold value
 - Green: current number of parts within set thresholds
 - Red: current number of parts above the set High threshold value

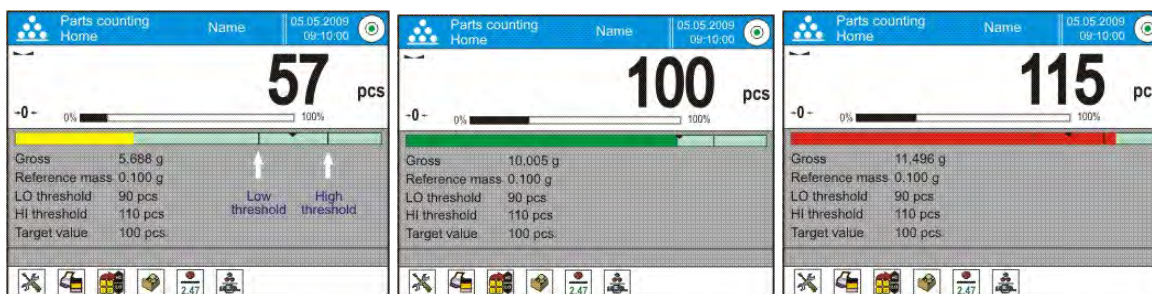

16.8. DOSING FOR PARTS COUNTING MODE

Parts counting process can be aided by dosing function, i.e. control aiming to observe whether the indication does not exceed the set target value. Dosing requires setting a target value, e.g. 100 parts, and a % tolerance. The bar graph displays the target value as a bracket.

In order to define target mass value press quick access key, < Target Value>.

Procedure:

1. Press grey workspace, next select <Information> parameter.
2. Set Bar graph to YES value, return to parts counting mode.
3. Press grey workspace, next press <Keys> parameter.
4. Assign <Target Value> parameter to one of the quick access keys displayed in the bottom bar.
5. Return to parts counting mode.
6. Press < Target Value> key and enter value corresponding to number of parts you want to have.
7. Bar graph is displayed. It provides the following information:
 - Current number of parts on the weighing pan (indicated by means of colour – see section 16.7.),
 - Target Mass value (black marker).

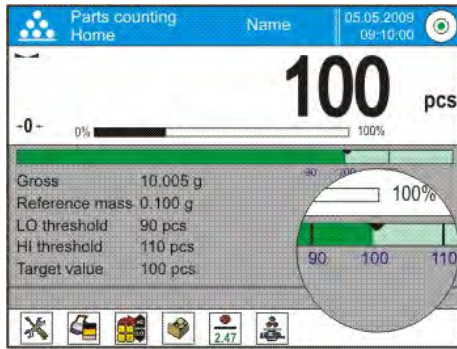

CAUTION!

The checkweighing and dosing functions can operate simultaneously in the parts counting mode. In such case the dosing tolerance is controlled by Lo and Hi thresholds of the checkweighing function.

17. CHECKWEIGHING

Checkweighing is a working mode using two thresholds (Min and Max) for control of samples weight. Usually the weight is considered to be correct if it is comprised within threshold values.

Checkweighing mode screen.

	<ol style="list-style-type: none"> 1. Setup – press to access balance menu 2. Print header – press to print data declared in the header 3. Print footer – press to print data declared in the footer 4. Products Database – press to select products from a corresponding database 5. Set Tare – press to enter tare 6. Checkweighing thresholds – press to declare low and high threshold values.
--	--

17.1. MAKING USE OF CHECKWEIGHING THRESHOLDS

In order to use checkweighing thresholds:



- Press Products> button and select product with Min and Max threshold declared.
- Enter numerical value for the thresholds using button, in this case thresholds do not refer to any product.

PROCEDURE 1 – selecting product from Products Database

1. Press Products> button.
2. Using product list, select the product that is to be weighed.
3. Threshold values are displayed automatically within an INFO area.
4. Bar graph is displayed, its colour corresponds to the current status of weight.
 - Yellow: weight value below Min threshold value
 - Green: weight value within set threshold values
 - Red: weight value above Max threshold value

PROCEDURE 2 – entering checkweighing thresholds manually



1. Press <  Checkweighing Thresholds> button.
2. Select Min threshold button and enter low limit value.
3. Press <  > button for confirmation.
4. Select Max threshold button and enter high limit value.
5. Press <  > button for confirmation.

CAUTION!

Max threshold value has to be greater than Min threshold value.

17.2. SUPPLEMENTARY SETTINGS FOR CHECKWEIGHING MODE

The supplementary settings enable adjusting the working mode to your needs and requirements. For information on how to access the settings go to section 15.8.

18. DOSING



<  **Dosing**> is a working mode enabling performance of sampling process, wherein the sampling takes as long as it is necessary to obtain pre-defined target weight.

Dosing mode screen.

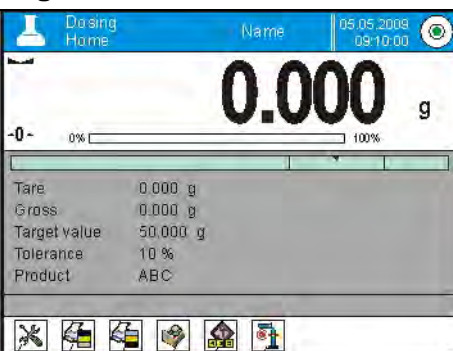
	<ol style="list-style-type: none"> 1. Setup – press to access balance menu 2. Print header – press to print data declared in the header 3. Print footer – press to print data declared in the footer 4. Products Database – press to select products from a corresponding database 5. Set Tare – press to enter tare 6. Target value – press to declare target value.
--	---

18.1. MAKING USE OF PRODUCTS DATABASE FOR DOSING OPERATION

You can use target values assigned to a product or values recorded in Product Database. You can also define temporary target values. In Product Database target value is determined by Mass field.

PROCEDURE 1 – selecting product from Products Database



1. Press <  Products> button.
2. Using product list, select the product that is to be weighed.
3. Target and tolerance values are displayed automatically within an INFO area.
4. Target value with minus sign is displayed.

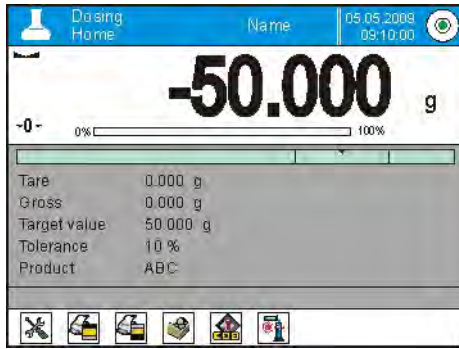

5. Bar graph is displayed, its colour corresponds to the current status of weight.
 - Yellow: weight value below Target Value - Tolerance
 - Green: weight value within tolerance, Target Value +/- Tolerance
 - Red: weight value above Target Value + Tolerance

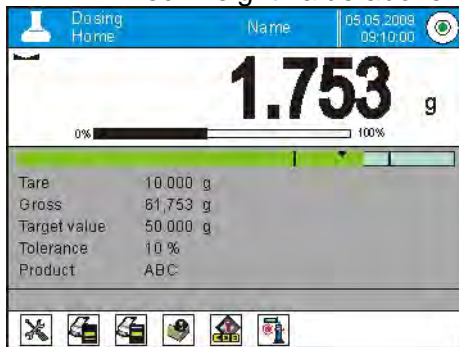

PROCEDURE 2 – target value entered manually

1. Press <  Target Value > button.
2. Window for entering target value and tolerance is displayed, provide the values.
3. Return to weighing.

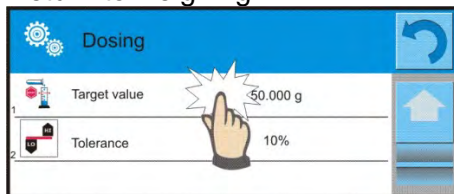

CAUTION!

For a product acquired from Products Database the Target Value and Tolerance data are already given. The data can be edited and modified.

18.2. SUPPLEMENTARY SETTINGS FOR DOSING MODE

The supplementary settings enable adjusting the working mode to your needs and requirements. For information on how to access the settings go to section 15.8.

19. PERCENT WEIGHING



< **Percent weighing** > is a working mode enabling comparison of a measured sample with the reference mass. The result is expressed in [%].

PERCENT WEIGHING function can be aided by DOSING and CHECKWEIGHING functions. Mind that these are not started automatically, neither is bar graph.

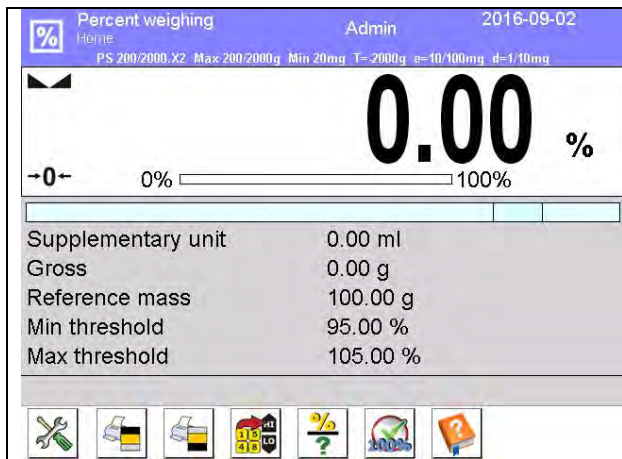

Percent weighing mode screen.





1. Setup – press to access balance menu
2. Print header – press to print data declared in the header
3. Print footer – press to print data declared in the footer
4. Products Database – press to select products from a corresponding database
5. Percent Weighing – press to set reference mass
6. Percent Weighing – press to set as 100%.
7. Help manual

19.1. COMPARISON OF A SAMPLE AND A REFERENCE MASS

Comparison methods:

- Entering mass of a standard, to do it use  Set reference mass> button.
- Accepting current mass loaded on the weighing pan as a reference mass, to do it use  Set as 100%> button.
- Selecting a product from products database (mind that the selected product mass has to be specified), to do it use  Products> button.



PROCEDURE 1 – manual declaring of reference mass

1. Press  Set reference mass> button.
2. Window for entering reference mass value opens, enter the value and press  button for confirmation.
3. Mass of all weighed products is compared to reference mass, the weight difference is displayed in [%].

PROCEDURE 2 – accepting current load mass as reference mass (standard)

1. Put the sample on a weighing pan.
2. On measurement result stabilization, press  Set as 100%> button.
3. 100.000% indication is displayed, loaded part weight is accepted as a reference mass, it is automatically recorded and displayed in reference mass field.
4. Remove the sample form the weighing pan.
5. All samples weighed afterwards are compared with the reference mass, and the display indicates the difference, expressed in [%], for each weighed sample in relation to the reference mass.

PROCEDURE 3 – selecting a product from Products Database

1. Press  Products> button, using displayed product list select the product that is to be weighed.
2. „Info” field automatically displays new information on reference mass and product.
3. Reference mass relating to the product is recorded automatically and displayed in reference mass field, to modify the value press  > button.
4. 0.00 % indication is displayed (for unloaded pan).
5. All samples weighed afterwards are compared with the reference mass, and the display indicates the difference, expressed in [%], for each weighed sample in relation to the reference mass.

19.2. CHECKWEIGHING AND DOSING FOR PERCENT WEIGHING MODE

PERCENT WEIGHING function can be aided by DOSING and CHECKWEIGHING functions. In order to make them accessible assign them to an on-screen key. Remember to provide percent values for both of the functions.

Procedure:



1. Press grey workspace.
2. Settings, Keys, Information, Printouts and Profiles submenus are displayed.
3. Select <Keys> submenu.
4. The display indicates a list of soft keys, functions and proximity sensors.
5. Press one of available options and assign a corresponding function.



CHECKWEIGHING

Checkweighing function facilitates control of sample mass, mind that low and high thresholds, given in [%], are required.

Procedure:

1. Press < Checkweighing Thresholds> button.
2. Select Min threshold button and enter low limit value in [%].
3. Press < > button for confirmation.
4. Select Max threshold button and enter high limit value in [%].
5. Press < > button for confirmation.



CAUTION!

Max threshold value has to be greater than Min threshold value.

DOSING

Dosing function requires target value to be specified (it must be given in [%]) along with dosing tolerance, i.e. permissible +/- surplus or shortfall.

Procedure:

1. Press < Target Value > button.
2. Enter the target value in [%].
3. If tolerance applies, set its value.
4. Press < > button for confirmation.
5. Select Max threshold button and enter high limit value in [%].
6. Press < > button for confirmation.

19.3. BARGRAPH - A TOOL FOR FUNCTION INTERPRETATION

The DOSING and CHECKWEIGHING functions are aided by a graphic indication, i.e. bar graph.

Example of simultaneous operation of DOSING and CHECKWEIGHING functions.

- Checkweighing thresholds Low Limit = 90%, High Limit = 110%.
- Target value = 105% ; tolerance = 5%.

- Reference mass = 19.986 g <  ? >



19.4. SUPPLEMENTARY SETTINGS FOR PERCENT WEIGHING MODE

The supplementary settings enable adjusting the working mode to your needs and requirements. For information on how to access the settings go to section 15.8.

20. DENSITY



< **Density** > is a working mode enabling to determine density of:

- solid bodies,
- liquids,
- air (available for AS 3Y, XA 3Y),
- various substances with use of pycnometer.

In order to operate this mode, an optional density kit (supplementary equipment), appropriate to a model of used balance, is required. Prior to installing the kit it is necessary to remove the weighing pan and an anti-draft chamber.

Density mode screen.

	<ol style="list-style-type: none"> 1. Setup – press to access balance menu 2. Print header – press to print data declared in the header 3. Print footer – press to print data declared in the footer 4. Density of solid 5. Density of liquid 6. Density of air 7. Pycnometer
---	--

20.1. SOLIDS DENSITY DETERMINATION

Prior the procedure start it is necessary to determine the following process related data:

- liquid type (distilled water, ethanol, other liquid with determined density),
- liquid temperature (required in case of water or ethanol),
- liquid density (set automatically for water or ethanol upon the temperature has been entered, set manually for <Other> liquid).





The density of solids is calculated using the following formula:

$$\rho = \frac{A}{A-B} \rho_o$$

Where:

- ρ - density of a sample
- A - sample mass measured in the air
- B - sample mass measured in liquid
- ρ_o - liquid density

Procedure:

1. Install the density determination kit.
2. In order to record density value for a particular product in products database, go to <Settings> menu, set <Assign density to product> parameter and press <Product> quick access key to make the product active.
3. Press  Density of solids > button, respective menu is displayed, using it set the following parameters: Standard liquid, Temperature, Standard liquid density.
4. Press  START > button, solids density determining begins.
5. Load the TOP density kit pan with a sample, wait for a stable measurement result and press  button.
6. Load the BOTTOM density kit pan (immersed in liquid) with a sample, wait for a stable measurement result and press  button.
7. Density result is displayed.
8. Press  button to finish the procedure.

CAUTION!

Pressing  key starts another density determining process with the same settings.

20.2. DETERMINING DENSITY OF LIQUIDS



In order to determine density of liquid first determine sinker's density in the air, next in the liquid. The density of liquid is calculated according to a formula:

$$\rho = \frac{A - B}{V} + d$$





Where:

- ρ - density of liquid
- A - sinker's mass measured in the air
- B - sinker's mass measured in tested liquid
- V - sinker's volume
- d - air density (max 0,001 g/cm³)

Install the density determination kit, and enter sinker's volume to balance's memory.

- Press  Liquid density> button, a respective menu is displayed, using it press < Sinker's volume> button and enter sinker's volume value, take it from the sinker's hanger.
- Liquid density determining begins.

Procedure:

1. Install the density determination kit.
2. In order to record density value for a particular product in products database, go to <Settings> menu, set <Assign density to product> parameter and press <Product> quick access key to make the product active.
3. Press < START > button, follow the prompts.
4. Carry out measurement in the air, wait for a stable measurement result and press < > button.
5. Carry out measurement in the tested liquid, wait for a stable measurement result and press < > button.
6. Density result is displayed.
7. Press < > button to finish the procedure.

CAUTION!

Pressing < > key starts another density determining process with the same settings

20.3. AIR DENSITY

< > Air density value is required for calculation of correction of measurement result related to air BUOYANCY compensation. Another value required for the calculation is weighed sample density. The function of air density determining is enabled only in balances with reading unit lower than d=1mg.

Determining density of air requires using a dedicated set of mass standards (additional equipment), specific for a balance model.

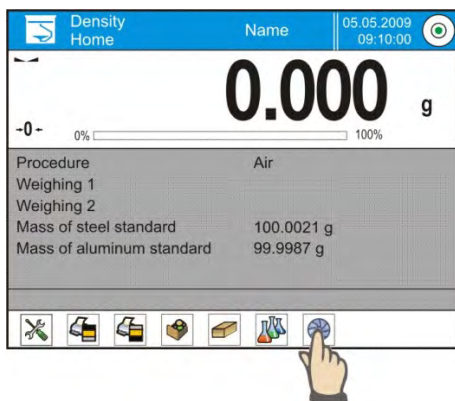

Procedure:

1. Press < Air density > button.
2. Options related to Air density mode are displayed.

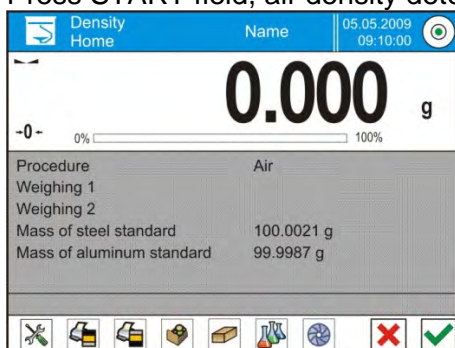

3. Press field for entering steel mass standard weight and enter the mass standard value as provided in its calibration certificate.
4. Press field for entering aluminium mass standard weight and enter the mass standard value as provided in its calibration certificate.
5. Press field for entering steel mass standard density and enter the density value.
6. Press field for entering aluminium mass standard density and enter the density value.
7. Press START field, air density determining begins.



8. Load the pan with steel mass standard, wait for a stable measurement result and press  button.
9. Load the pan with aluminium mass standard, wait for a stable measurement result and press  button.
10. Density result is displayed.
11. Press  button to finish the procedure.

The value of determined air density is automatically assigned to <Air density> parameter in <Settings/ Air buoyancy compensation> menu for weighing working mode.

20.4. DETERMINING DENSITY USING PYCNOMETER

Prior the procedure start it is necessary to determine the following process related data:

- Pycnometer weight (if pycnometer weight is known, it is measured once only when filled with substance)
- Pycnometer volume

The density of solids is calculated according to a formula:

$$\rho = \frac{A}{A-B} \rho_0$$





Where:

ρ - density of a sample

A - sample mass measured in the air

B - sample mass measured in liquid
 ρ_o - liquid density





Procedure 1 – when the pycnometer weight has been entered

1. In order to record density value for a particular product in products database, go to <Settings> menu, set <Assign density to product> parameter and press <Product> quick access key to make the product active.
2. Press < Pycnometer> button, respective menu is displayed, using it set the following parameters: pycnometer weight, pycnometer volume.
3. Press < START> button, density determining begins.
4. Fill in the pycnometer with tested substance, follow the pycnometer guidelines.
5. Load the pan with a pycnometer, wait for a stable measurement result and press < > button.
6. Density result is displayed.
7. Press < > button to finish the procedure.

CAUTION!

Pressing < > key starts another density determining process with the same settings.

Procedure 2 – when pycnometer weight has not been entered

1. In order to record density value for a particular product in products database, go to <Settings> menu, set <Assign density to product> parameter and press <Product> quick access key to make the product active.
2. Press < Pycnometer> button, respective menu is displayed, using it set the following parameters: pycnometer volume.
3. Press < START> button, density determining begins.
4. Load the pan with an empty pycnometer, wait for a stable measurement result and press < > button.
5. Take the pycnometer off the pan, fill it with tested substance, follow the pycnometer guidelines.
6. Load the pan with a pycnometer containing the substance, wait for a stable measurement result and press < > button.
7. Density result is displayed.
8. Press < > button to finish the procedure.

CAUTION!

Pressing < > key starts another density determining process with the same settings.

20.5. SUPPLEMENTARY SETTINGS FOR DENSITY MODE

The supplementary settings enable adjusting the working mode to your needs and requirements. For information on how to access the settings read section 15.8.

- **Request sample number:** **NO** (sample number not required; single measurement), **YES** (sample number required; series of measurements).

- **Measuring unit:** [g/cm³], [kg/m³], [g/l] (selected unit is valid for all density determining options and for final indication printouts).
- **Assign density to a product: YES/NO** – if option <YES> is selected, the software automatically assigns the value of determined density of solid or liquid to <Density> parameter in a product record of the database of products. To use this function first enter products database and select a product for which the density procedure is carried out, next start density determining process. (if density has already been determined for this product, it is replaced with new value),
- **Tare mode,**
- **Printout mode / Value release,**
- **Printout.**

20.6. PRINTOUTS

Printouts option has been designed to enable you to determine content of particular standard printout and to define non-standard printout.

Standard Printout

Standard printout comprises four internal blocks, each featuring different variables. Each variable can be attributed with parameter YES – i.e. printed, or NO – i.e. not printed.

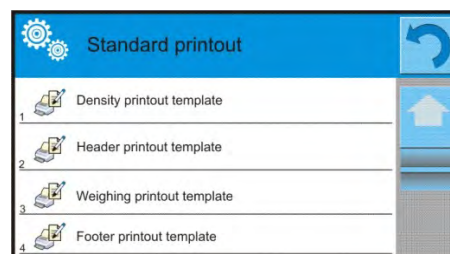

Settings for header printout, weighing printout, and footer printout are specified in section 14.5; settings for density printout template are presented below.

You can design content of a report for each of carried out procedures. On pressing <Density printout template> parameter a window is opened enabling setting the content of each report.

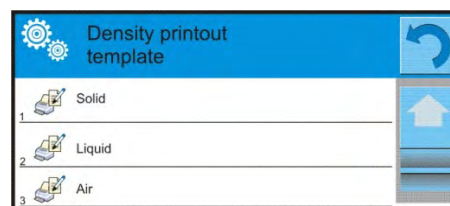

Particular reports content

SOLID	LIQUID	AIR	PYCNO METER
<ul style="list-style-type: none"> • Working mode • Procedure • Sample no. • User • Balance type • Balance ID • Date • Time • Standard liquid • Temperature • Density of standard liquid • Weighing 1 • Weighing 2 • Density • Volume • Product • Warehouse • Customer 	<ul style="list-style-type: none"> • Working mode • Procedure • Sample no. • User • Balance type • Balance ID • Date • Time • Sinker volume • Temperature • Weighing 1 • Weighing 2 • Density • Product • Warehouse • Customer • Empty line • Dashes • Signature 	<ul style="list-style-type: none"> • Working mode • Procedure • Sample no. • User • Balance type • Balance ID • Date • Time • Mass of steel standard • Mass of aluminium standard • Density of steel standard • Density of aluminium standard • Weighing 1 	<ul style="list-style-type: none"> • Working mode • Procedure • Sample no. • User • Balance type • Balance ID • Date • Time • Pycnometer weight • Pycnometer volume • Weighing 1 • Weighing 2 • Density • Product • Warehouse • Customer • Empty line

<ul style="list-style-type: none"> • Empty line • Dashes • Signature • Non-standard printout 	<ul style="list-style-type: none"> • Non-standard printout 	<ul style="list-style-type: none"> • Weighing 2 • Density • Product • Warehouse • Customer • Empty line • Dashes • Signature • Non-standard printout 	<ul style="list-style-type: none"> • Dashes • Signature • Non-standard printout
--	---	---	--

20.7. REPORT ON COMPLETED DENSITY DETERMINATION PROCESS

On completing any type of density determining processes, i.e. solid, liquid or air, a report is generated. The report is saved to the <  **Density reports**> database. The files are named by date and time (hour) of density determining process.

An exemplary solid density determination report:



```

----- Density -----
----- Solid Body -----
User                               Admin
Balance ID                         400010
Date                               2013.07.16
Time                               09:17:16
Standard liquid                     Water
Temperature                         22 °C
Density of standard liquid 0.9978 g/cm3
Weighing 1                          10.526 g
Weighing 2                          2.586 g
Density                             1.322776 g/cm3
-----
Signature

```

Making use of data contained in the header and footer.

Should data from header and/or footer be used, follow the below procedure:

1. Press <  Print header> button.
2. Carry out density determination procedure.
 - A report is printed automatically on completing the second measurement (Weighing 2),
 - When density determination result is displayed, it is possible to print it for numerous times by multiple pressing of <  **PRINT**> key.
3. After completing the density determination procedure press <  Print footer> button.

CAUTION! Remember to select data to be printed in the header, footer and report. For detailed information go to section 14.5.

21. ANIMAL WEIGHING

<  **Animal weighing**> is a working mode enabling reliable determination of mass of weighed objects in motion. In principle, this type of objects generate unstable measurement, thus it requires using a different filtering method of measurement signal.





Animal Weighing mode screen.

	<ol style="list-style-type: none"> 1. Setup – press to access balance menu 2. Print header – press to print data declared in the header 3. Print footer – press to print data declared in the footer 4. Database – press to select product out of the database 5. Set tare 6. Animal weighing
--	---

21.1. ANIMAL WEIGHING MODE SETTINGS

Set Animal Weighing mode with reference to weighed object analysis method.

Procedure:

1. Press <  Animal weighing > button.
2. List of Animal Weighing parameters is displayed:
 - Averaging time** - amount of time during which measurement records of weighed sample are analysed. Obtained data is used to determine measurement result.
 - Automatic operation** - determines start criterion for measurements: whether they are initiated manually /on pressing a key/ or automatically.
A measurement starts automatically if indication on balance's display exceeds the value of set threshold.
The following measurement can start on unloading the weighed object from balance's pan (the indication has to return below the value set in threshold), loading a new object on balance's pan and exceeding the threshold's value by the indication.
 - Threshold** - it is a value expressed in mass measuring units.
in order to start measurement, the indication has to exceed value set in the threshold.
3. Set parameters and return to weighing.
4. Load the weighing pan with an object to be weighed, press <  > button.
5. "Locked" measurement result is displayed.
6. In order to proceed to the next measurement press <  > button:
 - in case of manual operation mode, press <  > button,
 - in case of automatic operation mode, unload the weighing pan and load it with the new object to be weighed.

21.2. SUPPLEMENTARY SETTINGS FOR ANIMAL WEIGHING MODE

The supplementary settings enable adjusting the working mode to your needs and requirements. For information on how to access the settings read section 15.8.

22. FORMULATIONS

<  **Formulations** > is a working mode enabling you to prepare multi-ingredient mixture. The whole process is performed automatically.
While making mixtures you can:

- **use formulations database**, the software helps you dose particular ingredients, you are prompted with messages providing you with respective instruction,
-
- **make mixture on your own**, without using formulations database, with this option you control ingredients dosing, order and quantity by yourself.

If you want to use formulations database, first you have to make formulation, next apply it. Making formulations is possible using Formulation Database option. Read down below for detailed procedure.

Formulations mode screen.

	<ol style="list-style-type: none"> 1. Setup – press to access balance menu 2. Print header – press to print data declared in the header 3. Print footer – press to print data declared in the footer 4. Formulation – press to select formulation out of the database 5. Formulation multiplier (formulation is activated on setting <Multiplier's editing> parameter to <NO> parameter) 6. Target mass 7. Formulation using out of database ingredients
--	---

22.1. SUPPLEMENTARY SETTINGS FOR FORMULATIONS MODE

The supplementary settings enable adjusting the working mode to your needs and requirements. For information on how to access the settings read below.

Procedure:

1. Press grey workspace.
2. Settings, Keys, Information, Printouts and Profiles submenus are displayed.
3. Press <Settings> key.
4. The display indicates functions related to formulation making process.

Formulation making process functions:

Automatic ingredients naming:

- YES
- NO

Apply tare from database:

- YES - each ingredient has a tare value assigned (the value is assigned on the basis of data for a particular product saved to the products database);
- NO - tare is not applied

Means of ingredient verification:

Use this function to specify how to determine ingredient mass during formulation making process, by TOLERANCE or by THRESHOLDS.

- TOLERANCE: the software accepts mass of an ingredient as correct if it is within percent tolerance of total ingredient's mass ($\pm\%$) - (data acquired from database of products).
- THRESHOLDS: the software accepts mass of an ingredient as correct if it is within set thresholds (data acquired from database of products).

Specified method is in effect for all ingredients in the formulation making process.

If during formulation making process one of the ingredients is weighed in excess (its mass is out of high tolerance limit) the following message is displayed upon ingredient weight confirmation: <VALUE OUT OF RANGE, RECALCULATE THE FORMULATION?>. Confirm,

the software automatically recalculates mass of other ingredients so that the mixture proportions are correct.

In order to make THRESHOLDS option active, the product/ingredient related data in database **must correspond** with value selected for <MEANS OF INGREDIENT VERIFICATION> parameter, i.e. ingredient thresholds are specified and <THRESHOLDS> parameter is selected for <MEANS OF INGREDIENT VERIFICATION> parameter, otherwise particular ingredients mass recalculation is not possible, i.e. ingredient thresholds are specified and <TOLERANCE> parameter is selected for <MEANS OF INGREDIENT VERIFICATION> parameter.

Multiplier's editing

Function designed to enable making multiple mixtures according to a selected formulation in a single weighing process:

- YES - on selecting a formulation for processing the software requests for multiplier's value, the provided value is in effect for all ingredients in the formulation making process, i.e. each ingredient is multiplied by the value.
- NO - multiplier value is disabled, default value is set to <1>



Printout, for information on how to operate this function read section 15.8. "Additional Parameters for a Weighing Process".

22.2. ADDING FORMULATION TO FORMULATIONS DATABASE

Formulation database contains formulations names, ingredients names and their weight. Each product used for formulation making process is saved to the database of products. When preparing a formulation, first name it, next add ingredients.

The software is intuitive and you are guided by means of respective prompts. Since each ingredient must have its name and mass specified you have to know the exact composition of the total mixture. In order to add a new formulation enter the formulation database.

Procedure:

1. Enter  Databases> submenu, press <Formulations> button.
2. Press <  Add> button for adding a new formulation.

New record is added and edited automatically. Enter necessary data.

List of formulation parameters:

- Name: click Name button, new window opens, go to the window and enter formulation name.
- Code: click code button, enter code number.
- Ingredients: click ingredients button, list of formulation ingredients is displayed (for new formulation the list is empty), add the ingredients:
 - press <  Add> button,
 - select one of the following options:
 - <New ingredient>** - select to add a new product, first enter name, next specify mass to be weighed during formulation making process. The software automatically adds the products to the products database.
CAUTION! In order to enter remaining product data it is necessary to go to product database.
 - <New ingredient from database>** - select to view a list of database stored products, choose the product you need for your mixture, the software weighs as much product/ingredient as specified by product database mass parameter. Mass value can be edited and modified for each added product. The introduced modifications do not affect mass value saved to the database.
- Number of ingredients: non-editable parameter updated by the software on adding an ingredient to a formulation.
- Sum: target mass of a formulation, i.e. sum of all formulation ingredients, non-editable parameter updated by the software on adding an ingredient to a formulation.

22.3. USING FORMULATIONS IN WEIGHING

With FORMULATIONS function activated, you can prepare mixture either manually or by selecting formulation out of database.

Mixture preparation options:

- formulation that is not saved to the Formulation Database – i.e. “manually”,
- formulation that is saved to the Formulation Database,
- formulation that is saved to the Formulation Database – using multiplier function.
- formulation that is saved to the Formulation Database – determining target mass of complete formulation

CAUTION!

In order to use the above options it is necessary to add respective quick access keys to the bottom bar and set formulations mode parameters.

Select a particular formulation, weigh each of its ingredients. Wait for the indication to stabilize next





press  button, with this weight of each ingredient is tared, i.e. it is accepted for the total mass of the formulation.

Press  button to cancel the formulation making process. Now you can prepare a different formulation.

PROCEDURE 1 – preparing formulation that is not saved to the Formulation Database – i.e. “manually”.

Following the prompts:







1. Press  Formulation using out of database ingredients> button to be found on bottom bar.
2. Name the formulation.
3. You are prompted to select ingredients for a formulation.
4. Select the first ingredient (new or from database of products).
5. Home screen is displayed.
6. Load the weighing pan with a container for a weighed product, wait for a stable measurement indication and carry out taring operation.
7. Press  button for confirmation.
8. You are prompted to select remaining ingredients for a formulation.
9. Weigh all required ingredients, take the same set of actions like in case of the first formulation ingredient.
10. With all the ingredients weighed, select one of the following options:
<Save and close> - select to save the process to formulations database, the process is finished automatically, the final report is recorded in formulation database.
<Close> - select to complete without saving the process to formulations database the process is finished automatically, the final report is recorded in formulation database.
11. Press  button for confirmation.
12. Formulation home screen is displayed, message “Completed” is visible in the bottom bar. To proceed press  button.

CAUTION!

It is possible to abort formulation making process at any moment, to abort the process press  Abort> button.

PROCEDURE 2 – Preparing formulation that is saved to the Formulation Database. Basic option for creating recipes. Procedure 2 facilitates preparing mixtures with multiplied amount of ingredients.





Following the prompts:

1. Press < Formulation> button.
2. List of formulations is displayed, select the formulation that is to be carried out.
3. Press < Formulation with multiplier> button.
If in Formulation mode settings option <Multiplier editing> is disabled (set to <NO>) the software automatically skips to formulation making process. If the option <Multiplier editing> is enabled (set to <YES>) the software displays a window with a keyboard for inserting the multiplier value. Mass of all formulation ingredients is multiplied by the specified value (mass of each ingredient is a product of mass saved to a formulation and multiplier value).
4. Press < > button to confirm entered multiplier value, the software proceeds to formulation making process. The following parameters are displayed: selected formulation name, the first ingredient name, ingredient number, mass to be weighed and target mass.
5. Load the weighing pan with a container for a weighed product, wait for a stable measurement indication and carry out taring operation.
6. Pour as much product/ingredient in the container as required.
7. Press < > button to confirm, the software automatically adds the mass to the sum of weighed formulation ingredients, the next ingredient weighing begins.
8. With all formulation ingredients weighed a report on completed process is printed and saved to reports database (report template is editable, to edit a report template go to <Printouts> parameter), message “Completed” is visible in the bottom bar. To proceed press < > button.

PROCEDURE 3 – Preparing formulation that is saved to the Formulation Database – determining target mass of complete formulation. This procedure is useful when you need to prepare a mixture with pre-determined mass, that is different from the mass resulting from summing of used ingredients.

In such case, there is no need for you to carry out complex calculations of ingredients' mass. The software adjusts mass of each ingredient in relation to pre-defined target mass of the complete formulation.

Following the prompts:

1. Press < Formulation> button.
2. List of formulations is displayed, select the formulation that is to be carried out.
3. Press < Masa ? Formulation with target mass> button.
4. Window with an on-screen keyboard for entering target mass of a mixture is displayed.
5. Enter the target mass value and press < > button to confirm, the software proceeds to formulation making process. The following parameters are displayed: selected formulation name, the first ingredient name, ingredient number, mass to be weighed and target mass. Mass of each ingredient is automatically recalculated (proportionally) to the value of defined target mass of the complete formulation.
6. Load the weighing pan with a container for a weighed product, wait for a stable measurement indication and carry out taring operation.
7. Pour as much product/ingredient in the container as required.
8. Press < > button to confirm, the software automatically adds the mass to the sum of weighed formulation ingredients, the next ingredient weighing begins.

9. With all formulation ingredients weighed a report on completed process is printed and saved to reports database (report template is editable, to edit a report template go to <Printouts> parameter), message “Completed” is visible in the bottom bar. To proceed press <  > button.

In order to print report on completed formulation making processes enter Formulation Reports Database.

22.4. PRINTOUTS

Printouts option has been designed to enable you to determine content of particular standard printouts and to define non-standard printout.

Standard Printout

Standard printout comprises four internal blocks, each featuring different variables. Each variable can be attributed with parameter YES – i.e. printed, or NO – i.e. not printed.

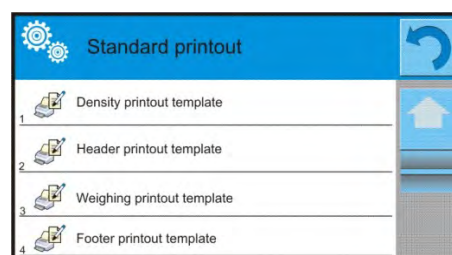

Settings for header printout, weighing printout, and footer printout are specified in section 14.5; settings for formulation report are presented below.

You can design content of a report.

CAUTION!

In order to specify which measurement data is to be printed on a report it is necessary to modify settings for <Weighing printout template> parameter. To enable particular measurement data printout set <YES> parameter for it. Upon completion of any formulation making process a report is generated. The report is saved

to the <  **Formulation Reports**> database. The files are named by date and time (hour) of formulation making process.

Report content

- Working mode
- User
- Customer
- Warehouse
- Formulation
- Formulation code
- Start date
- End date
- Number of ingredients
- Measurements quantity
- Measurements
- Target value
- Sum
- Formulation difference
- Status
- Empty line
- Dashes
- Signature
- Non-standard printout

An exemplary solid density determination report:

```

----- Formulation Report -----
User                               John Smith
Formulation name                    Mixture 1
Start Date                          2016.03.08 13:21:40
End Date                            2016.03.08 13:21:40
Ingredients quantity                 5
Completed measurements quantity     5
----- Measurement 1 -----
19.994 g
----- Measurement 2 -----
49.993 g
----- Measurement 3 -----
9.999 g
----- Measurement 4 -----
1.001 g
----- Measurement 5 -----
19.995 g
Total mass                           100.982 g
  
```

Target mass 101.000 g
 Difference -0.018



Status OK

 Signature

23. STATISTICS

<  Statistics > is a working mode enabling you to acquire data from series of measurements and to produce statistics using the acquired data. Settings of this function determine which data is displayed.

Procedure for activation of Parts Counting mode

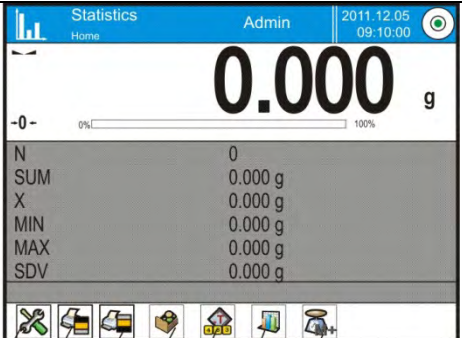

Go to the home screen, press  pictogram, <Working modes> submenu with list of available operation modes opens. Select <  Statistics > mode, home screen featuring statistics pictogram  in a top bar is automatically displayed.

Statistics mode screen.

	<ol style="list-style-type: none"> 1. Setup – press to access balance menu 2. Print header – press to print data declared in the header 3. Print footer – press to print data declared in the footer 4. Products Database – press to select products from a corresponding database 5. Set tare 6. Statistics 7. Add to statistics
--	--

23.1. BUTTONS AND INFORMATION SETUP

Buttons crucial for series of measurement:

- <  PRINT > button – press to trigger printout and to add measurement to statistics,
- <  Add to statistics > - press to add measurement to statistics, printout is not triggered.

Each working mode features automatically displayed set of default keys. The set can be modified so can be the default “INFO” field information.

23.2. SUPPLEMENTARY SETTINGS FOR STATISTICS MODE

The supplementary settings enable adjusting the working mode to your needs and requirements. For information on how to access the settings read section 15.8.

23.3. SERIES OF MEASUREMENT RELATED PARAMETERS

Series of measurement enables the following operations: previewing results, printing report, deleting last measurement, deleting all results in statistics.

Procedure:

1. Press  Statistics> button .

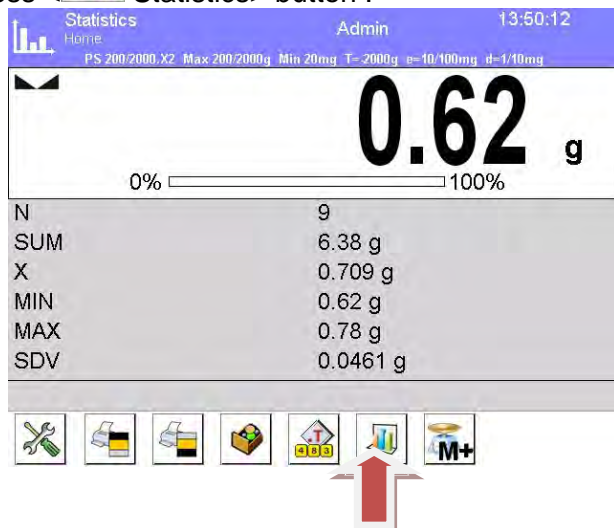

2. The following options are displayed: Result, Print, Delete last, Delete, Measurements Chart, Distribution Probability Chart.
3. Select:

Result – to preview statistics report

Print – to print a report

An exemplary report:

```

----- Statistics -----
N                               9
SUM                             455.600 g
X                               50.6222 g
MIN                             49.939 g
MAX                             51.380 g
D                               1.441 g
SDV                             0.39605 g
RDV                             0.78 %
-----
  
```

Delete last – to cancel the last measurement

Delete – to remove all statistics data

Measurements chart – to make the software generate and display a chart with distribution of measurements in the coordinates mass/measurement for completed measurement series.

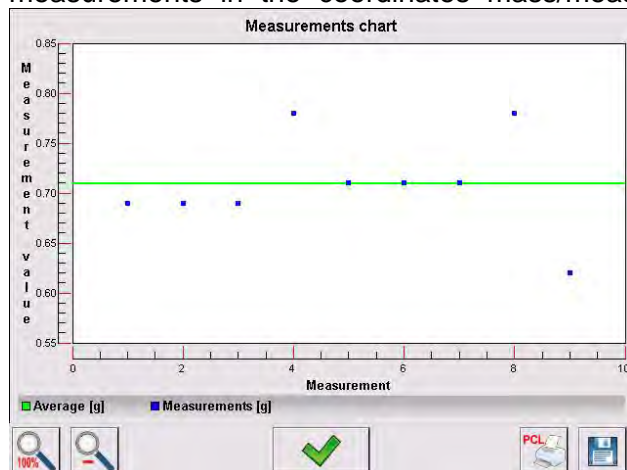

Probability distribution chart – to make the software generate and display a chart of probability distribution for completed measurement series. The bar chart demonstrates number of identical results in a series.

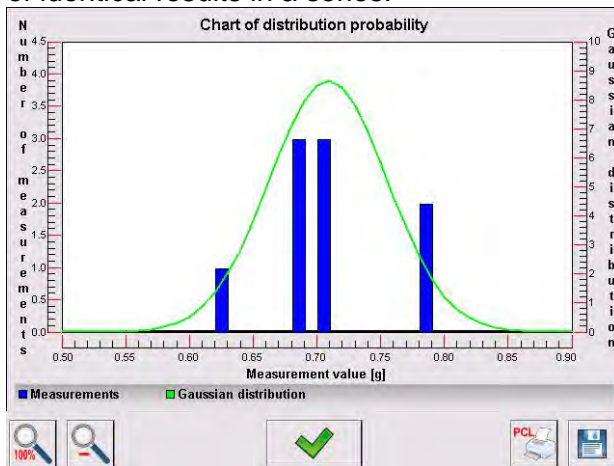

Bottom bar buttons:



Press to display complete chart.

Press to zoom out the screen content.



Press to go back to the previous window.



Press to print the chart using PCL printer.



Press to save the chart as *.bmp file to USB flash drive connected to USB port.

24. DIFFERENTIAL WEIGHING



< **Differential weighing** > is a working mode enabling you to analyse changes of mass of a single sample or multiple samples.

The process is carried out by determining sample's initial mass, next the sample is subjected to different processes, as a result some sample's ingredients are either separated or added. Finally, the sample is repeatedly weighed (differential weighing). After the final weighing, the balance determines the difference between the two mass values (initial and final).

Differential weighing mode enables you to:

- Determine **a series**, where each series may contain several samples
- Assign a name for each series, print or export data on a series to a connected USB flash drive;
- For each sample: determine tare value, initial mass and carry out up to five measurements for the final mass.

In order to operate differential weighing mode, first it is necessary to enter weighing series to the database, define samples in the series, next trigger the series. To create series go to series database. For more information on how to create series read further down this user manual.

Pipettes Calibration mode screen.

	<ol style="list-style-type: none">1. Setup – press to access balance menu2. Series3. Sample4. Weighing A5. Weighing B6. Weighing T+A7. Help manual
---	--

24.1. SUPPLEMENTARY SETTINGS FOR DIFFERENTIAL WEIGHING MODE

The supplementary settings enable adjusting the working mode to your needs and requirements. For information on how to access the settings read below.

Procedure:

1. Press grey workspace.
2. Settings, Keys, Information, Printouts, Series and Profiles submenus are displayed.
3. Press <Settings> key.
4. The display indicates functions related to differential weighing process.

Differential weighing process functions:

Threshold: mass value (maximum mass of a sample, e.g. filter)

Ambient conditions: use this function to force operator to enter temperature and humidity prior to weighing operation: <Weighing A, Weighing T+A, Taring T>

- NO – value not required;
- ONLINE – values taken from ambient conditions module cooperating with the balance
- VALUE – values taken from device other than ambient conditions module must be entered manually.

Maximum number of weighing records: use this function to declare how many times final weighing is to be repeated – 5 times maximum, the parameter setting is valid for all measuring series.

For overview of remaining functions go to section 15.8. “Additional Parameters for a Weighing Process”.

24.2. QUICK ACCESS KEYS

Each working mode features automatically displayed set of default keys. The set can be modified by assigning out-of-list quick access keys to on-screen keys. Such operation requires particular permissions level.

This section presents only those buttons that are characteristic for Differential Weighing mode.



Weighing A

Press to start weighing initial mass <A>. The process is carried out as a separate operation.



Weighing (T+A)

Press to start sample container taring which is next followed automatically by sample weighing (non-separable operations). On initiation you are asked to set sample's name.

**Tare (T)**

Press to start sample container taring. The process is carried out as a separate operation. On initiation you are asked to set sample's name.

**Weighing B**

Press to start weighing final mass . The button triggers differential weighing mode.

**Series**

Press to select a sample for which the differential weighing process is to be carried out.

**Sample**

Press to select a sample for currently carried out process of a particular series.

**Copy tare**

Press to copy tare value, determined for a given sample, to all current series samples (for which the tare value has not been assigned yet).

**Delete value**

Press to delete the most recently recorded mass value (tare, weighing A or weighing B).

Add sample

Press to add new sample, window with an on-screen keyboard is displayed, use it to provide new sample name.





In order to add a new sample first it is necessary to select series for which the sample is to be added. Mind not to start weighing operation before selecting the series and adding the sample.

24.3. ADDING SERIES TO SERIES DATABASE

Series Database comprises series and series samples. While creating a series, first set its name, next add samples. The software is intuitive and you are guided by means of respective prompts. Provide a name for each sample. To add a series go either to series database or differential weighing mode.

Procedure:

1. Press < Databases> button, next press <Series> button.
2. Press < Add > button, a series is added.

A new record is automatically added to the database, it is opened in an editing mode. Enter the necessary parameters.

List of series parameters:

- Name: press "Name" field, a window for entering series name opens.
- Code: enter series code.
- Customer: select a customer for whom the series measurements are to be carried out.
- Samples: press to view list of samples, for a new series the list is empty, add new samples. To do it press < Add > button, the sample is added automatically, its name can be edited and changed
- Number of samples: option editing disabled, the number is updated at real time by the software on adding a new sample to the series.

For each sample on the list its current differential weighing status is displayed (weighing process stage).

Newly added samples do not have any status assigned – the field is empty. The status is updated at real time after each completed weighing process stage.

24.4. DIFFERENTIAL WEIGHING PROCESS EXAMPLE

Activate DIFFERENTIAL WEIGHING mode, next:

1. Select information to be displayed in the grey workspace
2. Select appropriate quick access keys
3. Add a series to balance's memory (a name identifies a series)
4. Add samples to a series (a name identifies a sample)
5. On adding samples return to the differential weighing home screen

SELECTING a series:

Press <SERIES> quick access key, a window with series database opens.

Enter the database, press field with series that is to be carried out.

Selected series name is displayed in the grey workspace (provided that such information is enabled to be displayed the workspace).

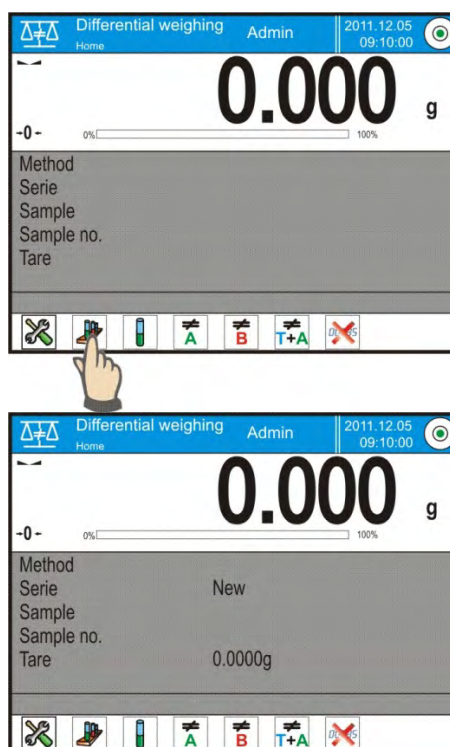

Upon selecting a series, press one of the following buttons determining how the differential weighing is to be carried out:



Weighing A
Press to start weighing initial mass.



Weighing (T+A)
Press to start sample container taring which is next followed automatically by sample weighing (non-separable operations).



Tare (T)
Press to start sample container taring.



Weighing B
Press to start weighing final mass. The button is enabled only for a series containing samples for which weighing A has been carried out.

Weighing A

- On pressing Weighing A button, the balance searches samples list in order to find the first sample for which weighing <A> is still to be carried out. If there are no such samples the balance displays a message informing you that the operation is disabled.
- If the operation is enabled then new data on initiated process is displayed in the grey workspace. You are guided through the process by means of prompts visible either in the workspace or bottom bar.
- Load the weighing pan with a sample and press  button. For <Ambient condition> parameter set to <Value> parameter a window for entering temperature and humidity values is displayed. For <Ambient condition> parameter set to <ONLINE> parameter a window for confirmation of values taken from ambient conditions module is displayed.

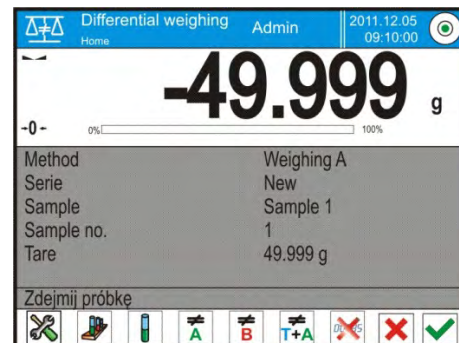
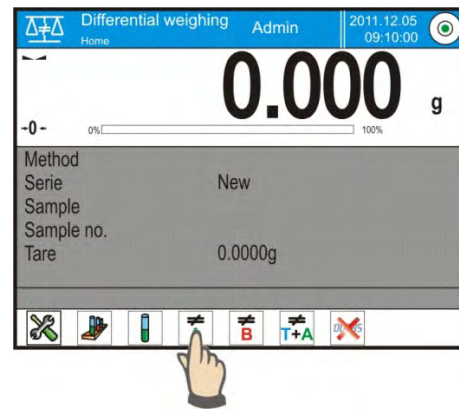

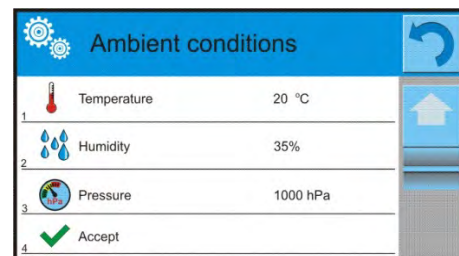

Caution:
If <Ambient conditions> parameter for the differential weighing mode is set to <No> parameter the software skips this part of the process.



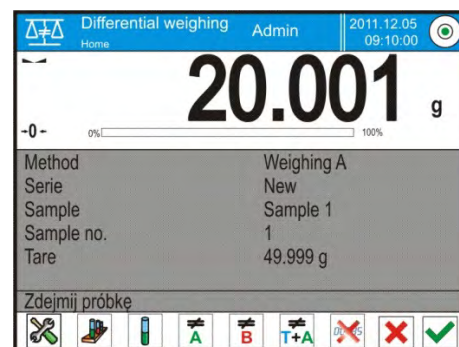

- Press  button to confirm ambient conditions values, differential weighing home screen is displayed, you are prompted to unload the weighing pan.



- Unload the weighing pan and press  button. The balance searches samples list again in order to find the first sample for which weighing <A> is still to be carried out. Follow the above procedure and weigh the remaining samples.
- In order to abort the process press  button.



Weighing T

- On pressing Weighing T button, the balance searches samples list in order to find the first sample for which weighing <T> is still to be carried out. If there are no such samples the balance displays a message informing you that the operation is disabled.
- If the operation is enabled then new data on initiated process is displayed in the grey workspace. You are guided through the process by means of prompts visible either in the workspace or bottom bar.

- Load the weighing pan with a sample container and press <  > button.
- You are prompted to unload the weighing pan.
- Unload the weighing pan and press <  > button. The balance searches samples list again in order to find the first sample for which weighing <T> is still to be carried out. Follow the above procedure and weigh the remaining containers.
- In order to abort the process press <  > button.



Weighing T+A

- On pressing Weighing T button, the balance searches samples list in order to find the first sample for which weighing <T> is still to be carried out. If there are no such samples the balance displays a message informing you that the operation is disabled.
- If the operation is enabled then new data on initiated process is displayed in the grey workspace. You are guided through the process by means of prompts visible either in the workspace or bottom bar.

- Load the weighing pan with a sample container and press <  > button.
- Container mass value is assigned to a sample as tare value, balance indication is zeroed, and you are prompted to place the sample in the container. Follow the prompt and press <  > button. For <Ambient condition> parameter set to <VALUE> parameter a window for entering temperature and humidity values is displayed. For <Ambient condition> parameter set to <ONLINE> parameter a window for confirmation of values taken from ambient conditions module is displayed.

Caution:

If <Ambient conditions> parameter for the differential weighing mode is set to <No> parameter the software skips this part of the process.

- Press <  > button to confirm ambient conditions values, differential weighing home screen is displayed, you are prompted to unload the weighing pan.
- Unload the weighing pan and press <  > button. The balance searches samples list again in order to find the first sample for which weighing <T> is still to be carried out. Follow the above procedure and weigh the remaining containers.
- In order to abort the process press <  > button.

Measurement of series samples can be carried under the following procedures: weighing A, weighing T or weighing T+A. Each of the series samples features status informing you on a process stage for a given sample. On entering the series database and selecting a particular series for preview you are provided with list of samples recorded for the series.

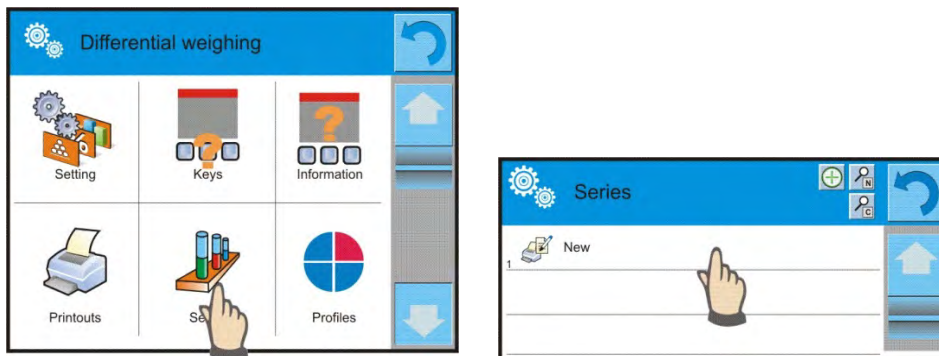

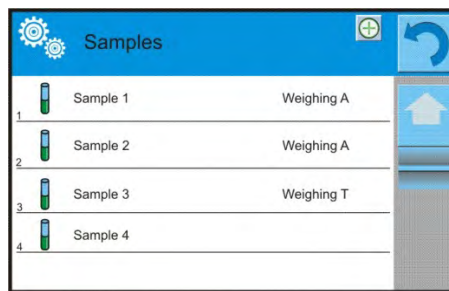
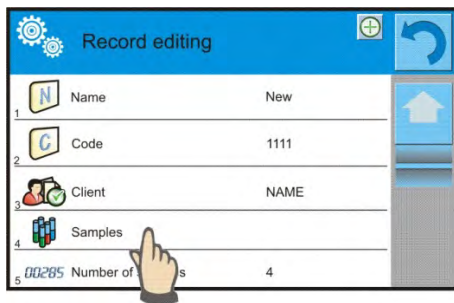

Status overview:

- weighing A, measurements completed for <Weighing A> or <Weighing T+A> procedure,
- weighing T, measurements completed for <Weighing T> procedure.

In order to preview detailed information on a sample, press field with its name. Sample window contains the following data:

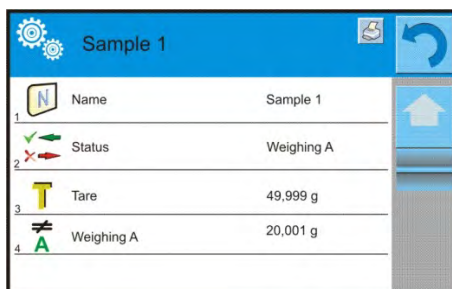

For sample measured under:

- weighing A procedure only – tare value is <0>,
- weighing T procedure only – weighing A value is <0>,
- weighing T+A procedure – tare and weighing A values is mass.

You can print weighed sample data, to do it press a printer pictogram located in the top bar. In order to preview data on weighing A, press <Weighing A> field:

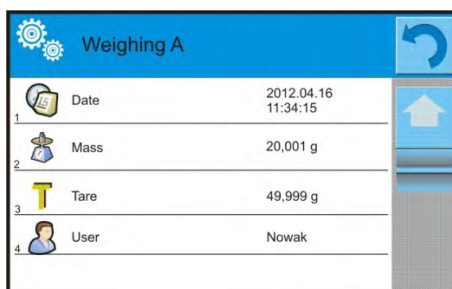

If a given series already contains samples for which weighing A (initial mass) has been carried out you can proceed to carrying out weighing B (final mass).

Weighing B

- On pressing Weighing B button, the balance searches samples list in order to find the first sample for which weighing is still to be carried out. If there are no such samples the balance displays a message informing you that the operation is disabled.
- If the operation is enabled then new data on initiated process is displayed in the grey workspace.

Caution:

Next to <Weighing B> caption you can see digits 1/3 where <1> means the first measuring cycle of type B, and <3> means that <REPETITIONS QUANTITY> parameter is set to <3> parameter (3 cycles).



The software prompts you to carry out the <FIRST> cycle, out of <3> cycles, for all samples in the series for which the measurement is enabled (it is required that weighing A is already completed for the sample).

- You are guided through the process by means of prompts visible either in the workspace or bottom bar.
- If tare is assigned to a sample, then its value is displayed with '-' sign. Load the weighing pan

with a sample (if tare is assigned load the sample in a container) and press <  > button. For <Ambient condition> parameter set to <VALUE> parameter a window for entering temperature and humidity values is displayed. For <Ambient condition> parameter set to <ONLINE> parameter a window for confirmation of values taken from ambient conditions module is displayed.

Caution:

If <Ambient conditions> parameter for the differential weighing mode is set to <No> parameter the software skips this part of the process.

- Press <  > button to confirm ambient conditions values, differential weighing home screen is displayed, you are prompted to unload the weighing pan.
- Unload the weighing pan and press <  > button. The balance searches samples list again in order to find the next sample in the series. Follow the above procedure and weigh the next sample.
- In order to abort the process press <  > button.

On completing measurements of final mass for the samples in a series, you can check the results in the series database.

To check the results, enter the database, select a series, then select samples and a specific sample for which <Weighing B> has been carried out.



Sample 1	
1	Name: Sample 1
2	Status: Weighing B
3	Tare: 49,999 g
4	Weighing A: 20,001 g
4	Weighing B: 20,001 g

Particular weighing preview mode provides you with values. Numbers referring to weighing inform on the measuring cycle.

Data on a specific series can be printed or exported to a file.

24.5. COPY TARE

Copy Tare option enables copying once selected tare value (in a series) to all samples which do not have tare value assigned, and for which differential weighing process (status other than Weighing B) has not been completed.

Procedure:

- Press <  > button.
- List of samples with tare values assigned is displayed.
- Press tare value that is to be applied to other samples which do not have tare assigned yet.
- The selected tare value is assigned automatically.

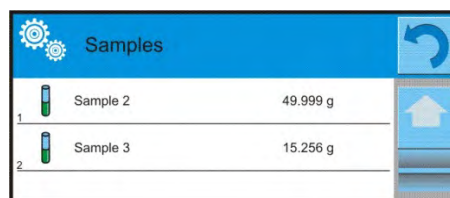

Samples	
1	Sample 2: 49.999 g
2	Sample 3: 15.256 g

24.6. SAMPLE SELECTION

Sample Selection option enables selecting a sample for weighing, with use of this option you do not have to weigh samples in an order suggested by software. The option is available only after initiating a given process.

Procedure:

1. Go to differential weighing mode, select a series, press procedure button, e.g. <Weighing A> procedure.
2. Press <  > button:
3. List of samples for which the selected procedure can be carried out is displayed.
4. Select a sample that is to be weighed
5. This option is particularly useful if a series contains a large number of samples, and you want to weigh a sample that is at the end of a series.



24.7. DELETING VALUES

Delete option enables deleting last weighing record added to the database. It refers to all processes in the working mode. The software enables deleting only the most recent measurement operation.

Procedure:

1. If you have saved a weighing record by mistake (sample or tare), i.e. wrong sample or container has been used, press <  > button.
2. The weighing record is automatically deleted, the software returns to the previous step of the procedure.

The process can be carried out once only, otherwise respective message informing on error is displayed, deleting a record is aborted.

24.8. PRINTOUTS

Printouts option has been designed to enable you to determine content of particular standard printouts and to define non-standard printout.

Standard Printout

Standard printout comprises five internal blocks, each featuring different variables. Each variable can be attributed with parameter YES – i.e. printed, or NO – i.e. not printed.

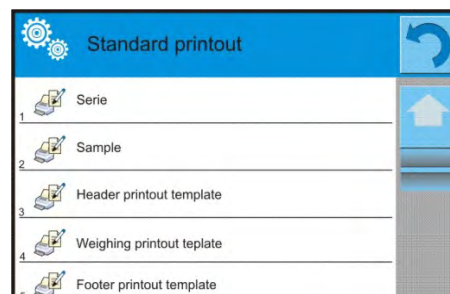

Settings for header printout, weighing printout, and footer printout are specified in section 14.5; settings for series and sample printout template are presented below.

You can design content of a report.

Particular reports content

Series printout content	Samples printout content
<ul style="list-style-type: none"> Dashes 	<ul style="list-style-type: none"> Dashes

<ul style="list-style-type: none"> • Customer • Samples • Empty line • Dashes • Signature • Non-standard printout 	<ul style="list-style-type: none"> • Sample • Sample no. • Status • Tare • Temperature • Humidity • Pressure • Non-standard printout • Weighing A <ul style="list-style-type: none"> • Weighing A • Date • Time • Level status • Warehouse • Product • Packaging • Universal variable 1...5 • Net • Tare • Non-standard printout • Weighing B <ul style="list-style-type: none"> • Weighing B • Date • Time • Level status • Warehouse • Product • Packaging • Universal variable 1...5 • Net • Tare • Interval • Difference • Difference % • Residue % • Non-standard printout
---	---

25. STATISTICAL QUALITY CONTROL - SQC



< Statistical Quality Control > is a working mode enabling support control of product packing process.

It enables detecting surplus or shortfall of product in a packaging. If the weighing results are stored in the database, then trend analysis can be carried out and displayed in a form of a chart.

The software provides the possibility of controlling a batch comprising up to 1000 samples.

Each completed control process is saved to the SQC database, and its results are ready for previewing in an optional moment. Each series has a determined set of parameters that are stored in the database: maximum, minimum, standard deviation and average value for each batch, etc.

SQC control process can be carried out manually (by pressing <PRINT> button for each measurement) or automatically (automatically carried out record of stable measurements).

The balances feature module for statistical control processes. It is supported by a database containing list of products with error values (<T2->, <T1->, <T1+>, <T2+>) declared for each product.

The control process is initiated automatically and completed on controlling a required quantity of samples. As a user you define how many samples are to be controlled, to do it go to SQC settings. After completed control process a final report can be generated and/or printed. Data on a control is also automatically saved to the Database of SQC Reports.

Control process:

- User selection,
- Product selection,
- Control start,
- Acquiring weighing records,
- Control finish (carried out automatically when predefined number of samples is weighed - batch),
- Control report print.

25.1. SQC ACTIVATION



In order to activate SQC control procedure you need to have particular permissions level.

CAUTION!







Starting a control requires that permissions level of the logged operator is at least <user>. If a logged user or an anonymous user have access level set to <guest> parameter then on control start the software opens a message box informing on: <Unauthorized access>.













For information on logging procedure read section 8 of this user manual, for information on how to grant permissions levels read section 12 of this user manual.

Procedure:

1. Log in,
2. Set < SQC> mode parameters, for detailed information read section 26.2,
3. Select a product that is to be controlled (press < > button located in the bottom bar or on the overlay), mind to select a product with correctly entered control data,



List of data to be entered prior control start:

	Mass	Nominal mass of a product
	Tare	Packaging mass in the adjustment unit
	SQC	
	Batch quantity	Declaring quantity of controlled batch
	Error value [T4-]	Max permissible negative T4 error value with nominal weight value as point of reference
	Error value [T3-]	Max permissible negative T3 error value with nominal weight value as point of reference
	Error value [T2-]	Max permissible negative T2 error value with nominal weight value as point of reference

	Error value [T1-]	Max permissible negative T1 error value with nominal weight value as point of reference
	Error value [T1+]	Max permissible positive T1 error value with nominal weight value as point of reference
	Error value [T2+]	Max permissible positive T2 error value with nominal weight value as point of reference
	Error value [T3+]	Max permissible positive T3 error value with nominal weight value as point of reference
	Error value [T4+]	Max permissible positive T4 error value with nominal weight value as point of reference
	Quantity of disqualifying samples [Qn – T4]	Max permissible quantity of T4 low limit errors with nominal weight as point of reference
	Quantity of disqualifying samples [Qn – T3]	Max permissible quantity of T3 low limit errors with nominal weight as point of reference
	Quantity of disqualifying samples [Qn – T2]	Max permissible quantity of T2 low limit errors with nominal weight as point of reference
	Quantity of disqualifying samples [Qn – T1]	Max permissible quantity of T1 low limit errors with nominal weight as point of reference
	Quantity of disqualifying samples [Qn + T1]	Max permissible quantity of T1 high limit errors with nominal weight as point of reference
	Quantity of disqualifying samples [Qn + T2]	Max permissible quantity of T2 high limit errors with nominal weight as point of reference
	Quantity of disqualifying samples [Qn + T3]	Max permissible quantity of T3 high limit errors with nominal weight as point of reference
	Quantity of disqualifying samples [Qn + T4]	Max permissible quantity of T4 high limit errors with nominal weight as point of reference

CAUTION!

For information on how to edit product records read section 30.2 of this user manual.

4. Return to  **SQC** mode home screen, press  button (control start) located in the bottom bar,
5. **<Batch Number>** window with an on-screen keyboard opens (only if **<Request batch number>** parameter is set to **<YES>** parameter),
6. Enter the number of controlled product batch, press  button for confirmation.

CAUTION!

You can abort the control process at any time, to do it press  button (control stop) located in the bottom bar.

In the course of control other soft keys and function keys, the  and  keys are locked.

25.2. SUPPLEMENTARY SETTINGS FOR SQC MODE

The supplementary settings enable adjusting the working mode to your needs and requirements.

SQC functions:



Request batch number: use this function to force the user to enter batch number of a product prior each control procedure start.

Procedure:

1. Select <Request batch number> parameter, window with NO/YES values is displayed.
2. Select NO value to disable the function, select YES value to enable the function. The previous screen is displayed automatically.

Batch number: use this function to enter identification number for controlled products batch.



Procedure:

1. Select  <Batch number> parameter, Batch Number window with an alphanumeric keyboard is displayed.
2. Enter the required batch number and press  > button for confirmation.

For information on remaining functions read section 15.8. of this user manual “Additional Parameters for a Weighing Process”.

25.3. CONTROL OPERATION

Procedure:

1. Press  <Product> button to select product to be controlled.
2. Press  button located in the bottom bar to initiate the control; an editing window with an on-screen keyboard opens.
3. Enter the batch number and press  button for confirmation, the software proceeds to the next process steps.

In the course of the control, measurement results are analysed in real time and the following prompts are displayed:

- Batch quantity 1 / 10** - A command on process course and the quantity of all measurements in a tested batch
- Product** - Controlled product name

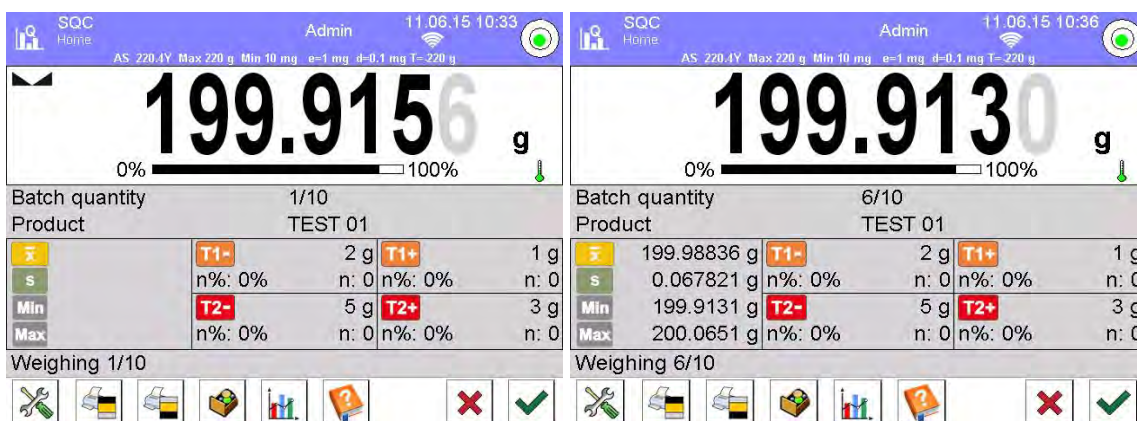

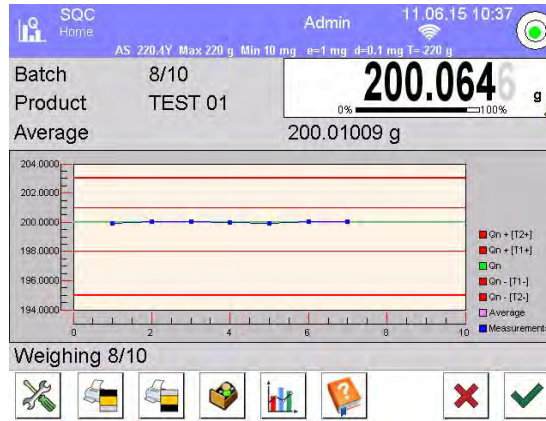

Control status

There are different control status options differentiated by colour. Particular colour informs you whether the permissible error quantities are out of range or not. Error values and permissible error quantities are specified for a particular product.

T1-	-1 g
Max: 2	n: 1

- yellow means that no more T1- error can occur

T2-	-3 g
Max: 1	n: 1

- red means that T2- error deciding on negative control result has occurred

Upon process completion a report is generated and recorded in database.

CAUTION!

For a template and an example of a report on a control process read section 26.4 of this user manual.

25.4. SQC CONTROL REPORT

An exemplary SQC control report:

```

----- SQC -----
Balance type                xx 4Y
Range                       xx g
Reading unit                 xx g
Balance ID                   442566
Start date                   2012.10.19 12:27:09
End date                     2012.10.19 12:37:20
Operator                     Kowalski
Product                      TEST 01
Batch number
Nominal mass                 50 g
Tare                         0 g
[T1-] error value            1 g
[T2-] error value            3 g
[T1+] error value            1.5 g
[T2+] error value            4 g
Batch quantity               100
Measurements quantity        30
[T1-] errors quantity        0
[T2-] errors quantity        0
[T1+] errors quantity        0
[T2+] errors quantity        0
Min                           50.0525 g
Max                           50.3638 g
  
```

Average	50.291163 g
Sum	1508.7349 g
Standard deviation	0.133916 g
Method	SQC
Indication	Positive

Measurements

1. 50.0525 g
2. 50.0525 g
3. 50.0525 g
4. 50.0525 g

Signature
.....

Report template

Procedure:

1. Open  **Printouts** /  **SQC report printout template** section to edit a template of a report. Only variables with <YES> attribute are printed on a report.

26. PEAK HOLD

 **< ↑ Peak Hold >** is a working mode enabling you to snap value of maximum force applied to the weighing pan during one loading. Apart from standard settings for this mode (described in the weighing mode), additional parameter has been introduced, it sets threshold value determining function activation.

26.1. SUPPLEMENTARY SETTINGS FOR PEAK HOLD MODE

The supplementary settings enable adjusting the working mode to your needs and requirements. For information on how to access the settings read below.

Procedure:

1. Press grey workspace.
 2. Settings, Keys, Information, Printouts and Profiles submenus are displayed.
 3. Press <Settings> key.
 4. The display indicates functions related to Peak Hold mode.
- **THRESHOLD** - function determining start point for peak hold control performed by the balance software. Remember to set this threshold prior to the measuring process.

26.2. MEANS OF OPERATION

Procedure:

1. Enter <PEAK HOLD> mode
 2. Once you select the mode, the function is active.
 3. Set the threshold in grams - determining point beyond which the function starts to register maximum force applied.
- From now on the balance registers and holds every single indication which is above the threshold, and which is higher than the result of the previous peak hold. If the software detects

mass above the threshold, the highest detected indication is held on the main display and the pictogram <Max> is shown on the left over the measuring unit.

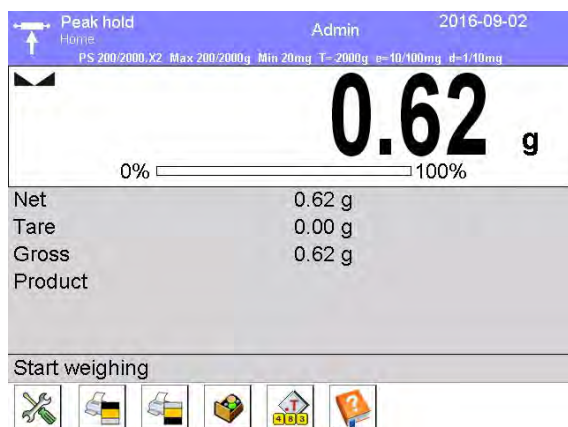

- Press  button in order to print the result.
- The start of the next process of peak hold measurement is possible only after removing the

load from the weighing pan and pressing  button. This causes returning to the home screen of <PEAK HOLD> mode, pictogram <Max> is automatically deleted.

27. PREPACKAGED GOODS CONTROLS

(disabled for standard balance versions)

< **Prepacked Goods Controls**> is a working mode enabling realizing prepackaged goods controls (single stand control or multi-stand control) supported by a database containing products and users. A control initiated from a balance is automatically finished after a pre-set number of packages (samples) has been controlled.

Balances may connect to **E2R SYSTEM** software and form a multi-stand system (network). Each balance is an independent weighing stand and information on control progress is transmitted continuously to software. The software enables collection of real-time data from each connected balance. Control may be activated either by means of a balance or the software.

Collected data allow you to assess quality of produced prepacked goods and their conformity with:

- regulations concerning prepacked goods control of a given country;
- a company quality control system (internal control).

Control cycle scheme:



- Select a user.
- Select a product.
- Start control.
- Acquire weighing records.
- Automatically switch off the control after a determined number of packages (sample) has been weighed.
- Print a report on completed control.

CAUTION!

For detailed instruction on how to establish connection with  **E2R System**> go to section 32.1 'Computer' of this user manual.

27.1. PREPACKED GOODS CONTROL MODE START-UP

Procedure:

1. Go to balance home screen, press  button located in the top bar, <Working modes> submenu opens.
2. Select  **Prepacked Goods Controls** mode, Prepacked Goods Controls home screen is displayed.
3. **<Start control>** message is visible in the bottom bar along with  button, press it to start the control.



27.2. CONTROL SETTINGS

CAUTION!

Before entering control settings it is necessary to log in.

Press  button located in a  **Prepacked Goods Controls** mode window to open control settings window:

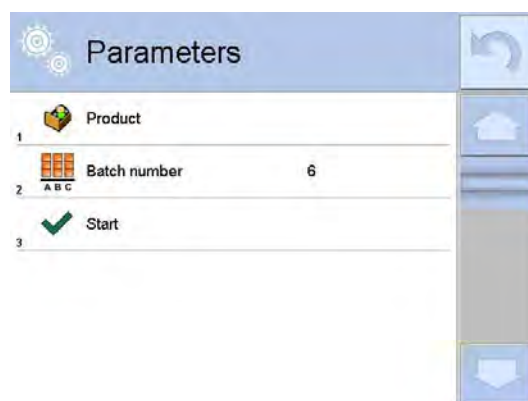

Where:



Press to select a product from a database



Press to edit batch number



Press to start control

27.3. PGC MODE LOCAL SETTINGS

In order to access  **Prepacked Goods Controls** mode local settings, click grey workspace of PGC mode home screen.

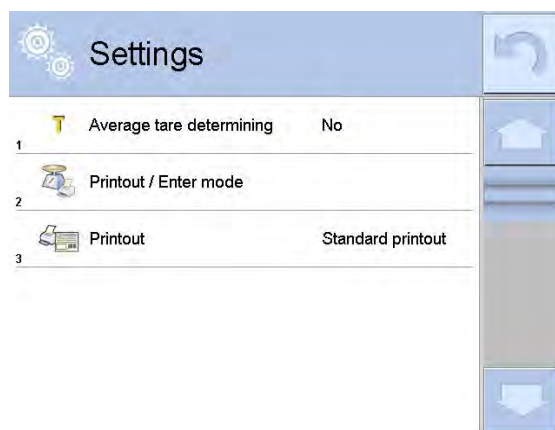

	Average tare determination	Press to switch on/off option of average tare determination before control start.
	Printout mode / approvals	For detailed description read section <ADDITIONAL PARAMETERS FOR A WEIGHING PROCESS>
	Printout	

27.4. EDITING PRODUCT FOR CONTROL

In order to edit a product go to „ / **Database**” submenu.

CAUTION!





For cooperation with *E2R System*> software database editing is blocked on a balance. Products editing and export is carried out by means of the software.

Procedure:

1. Enter „ / **Database**” submenu.
2. Enter **<Products>** database, select a particular record.

List of data defined for control:

Pictogram	Data	Overview
	Name	Product name
	Code	Product code
	EAN code	Product EAN code
	Mass	Product nominal mass
	Tare	Tare value of a product (pre-set automatically while selecting a product out of the database)
	PGC mode	Control type: Non-destructive average tare, Non-destructive empty – full, Destructive full – empty, Destructive empty – full
	Batch	Series of measurements for control: Non-destructive empty – full, Destructive full – empty, Destructive empty – full
	Unit	Unit of a product: [g] or [ml]
	Batch quantity	Declaration of number of items of controlled batch

	Time interval for average tare determination	Time interval given in [h] determining how often average tare must be estimated for a given product
	Quantity of packages	Declaration of number of packages that are to be subjected to process of average tare determination (for Non-destructive average tare type of control)
	Internal control	Submenu for defining criteria for internal control (see the next chart)
	Density	Product density (value range 0,1g/cm ³ - 5g/cm ³)

Apart from the above listed options there are other ones which may be used for different working modes (e.g. CHECKWEIGHING, THRESHOLDS, etc.)

List of data for internal criteria:

Internal control	Internal control criteria on <YES> / off <NO>
Samples quantity	Sample quantity for a product
Error value [- T]	Max permissible low limit error T (-T), given in unit set for a product. Measurements lower than value of Qn-T are regarded as invalid.
Error value [+ T]	Max permissible high limit error T (+T), given in unit set for a product. Measurements higher than value of Qn+T are regarded as invalid.
Disqualifying quantity of samples [Qn-2T]	Number of minus errors (-2T) of a tested sample which disqualifies control.
Disqualifying quantity of samples [Qn+2T]	Number of plus errors (+2T) of a tested sample which disqualifies control.
Disqualifying quantity of samples [Qn-T]	Number of minus errors (-T) of a tested sample which disqualifies control.
Disqualifying quantity of samples [Qn+T]	Number of plus errors (+T) of a tested sample which disqualifies control.
Average limit	Mode for determination of average limit value (constant or automatic).
Average limit -	Average limit value (minus) for a tested sample (value of average limit as "constant").
Average limit +	Average limit value (plus) for a tested sample (value of average limit as "constant").
Coefficient value [-Wk]	Multiplier of standard deviation for value of average limit (minus) calculated automatically.
Coefficient value [+Wk]	Multiplier of standard deviation for value of average limit (plus) calculated automatically.

27.5. CONTROL START PROCEDURE

Procedure:

1. Log in, make sure your access level allows you to carry out control (for more information read section on logging of this user manual).
2. Select product with correctly entered control data.

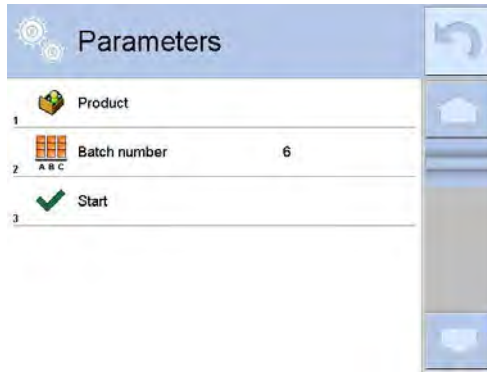

3. Enter weighing mode parameters:

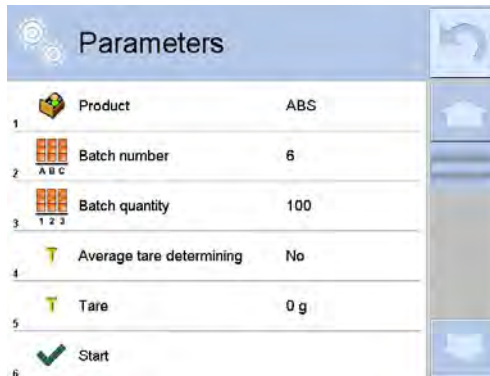

Where:

- Batch number** – identification of controlled products batch
- Batch quantity** – software controls specified number of samples
- Average tare determining**
- Quantity of packages** – more than 10

4. Remove load from the weighing pan.

5. Press  START soft key located in the bottom of a parameters settings window. The software proceeds to the main window of product control, used for entering data.

Caution:

If before control:



- Load has not been removed from the weighing pan or if other zeroing requirements have not been fulfilled (e.g. unstable indication), balance shows message: <-Err 2>. Upon noticing <-Err 2> message unload the balance and wait until all zeroing requirements are met.
- You have not logged in or you are logged but not assigned with the right access to perform control, then message: "No authorization" is displayed.
- You have not selected the product out of database, a message: "Product is not selected" is displayed.

27.6. ABORT CONTROL PROCEDURE

Procedure:

1. Press  (ABORT CONTROL) soft key to abort control procedure. The following message is displayed:



2. Press  button to return to the ongoing control. Press  button to abort control, program returns to Prepacked Goods Controls working mode.

Control report with status <ABORTED> is saved to  **Prepacked Goods Controls** database.

27.7. ABORTED CONTROL RESTORING PROCEDURE, POWER LOSS CASE

In case of disconnection from the mains, to prevent loss of data for control being in progress, program continuously keeps records of control results.



For power loss case the software allows to complete an aborted control upon reconnection to the mains.

Caution:

Remember to restart the balance when unloaded.

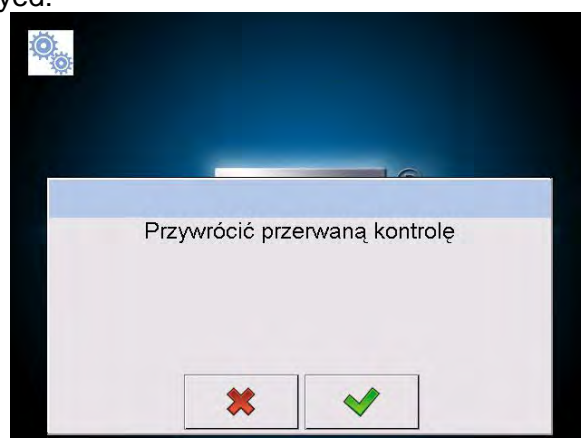
During balance restart the software searches for any in course control procedure. If there is one, the following message is displayed:



- Press  button to leave control procedure and proceed to weighing.
- Press  button to complete aborted control procedure.

27.8. NON-DESTRUCTIVE AVERAGE TARE CONTROL MODE

Prior control you can determine average tare by weighing packagings.

Procedure:

1. Go to setting window of PGC mode.
2. Activate **<Average tare determining>** function by pressing grey field of the main display of **<SETTINGS>** parameters.

The following window is displayed:

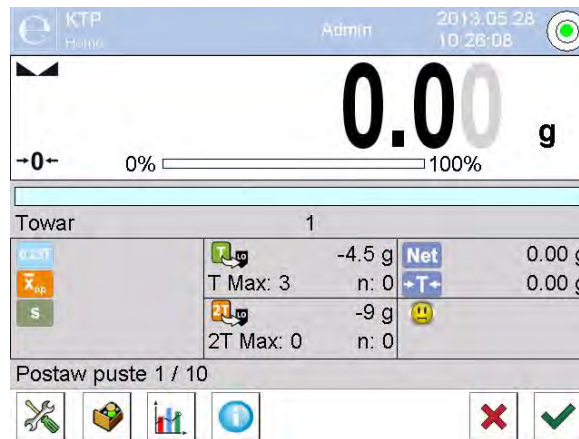

Where:

Product

0.25T

\bar{x}_{op}

s

T

2T

Net

T

Load empty



- Product name
- Condition value **0,25T** , given in [g]
- Average mass of a packaging, given in [g]
- Standard deviation
- Characteristics of sample's negative errors T1
- Characteristics of sample's negative errors 2T1
- Net mass of a controlled packaging
- Tare of a packaging
- Control status of a packaging
- Command for process in progress with specified number of all packagings to be weighed
Work pane in a form of graph.
- Graph applies to control of mass, while estimating average tare value preview of packaging mass distribution is not possible.
- Information on control
- Abortion of a control process

Caution:

If a product is to be controlled by "Non-destructive average tare" mode, then accordingly to regulation standard deviation "S" for its packaging mass, based on at least 10 measurements, cannot be greater than 0.25 of maximum permissible negative error T, for nominal packaging mass.

After the last packaging mass measurement has been performed, the following message is displayed:



- Press  button to proceed to control without saving the newly estimated average packaging mass to product data.
- Press  button to proceed to control with saving the newly estimated average packaging mass to product data.

Measurements results are analysed continuously during control and displayed in respective fields:

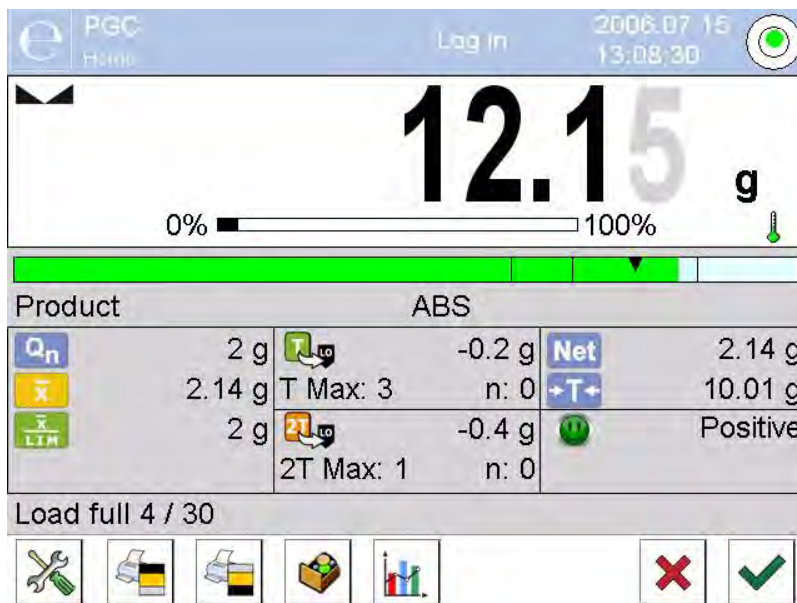

Where:

Bar graph

Information on product net mass in a form of graph:

green bar graph – mass within tolerance range: between $[-T]$ and $[+T]$ of net mass.

yellow bar graph – mass within tolerance range: between $[-T]$ and $[-2T]$ of net mass.

red bar graph – mass below net mass $[\text{NETTO} - 2T]$.

Product

Controlled product name



Nominal value of a controlled product



Average mass of a controlled product



Value of disqualifying average

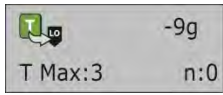

Characteristics of sample's negative errors T

-9g – value of negative error T,
T Max – permissible number of negative errors T,
n - actual number of negative errors T

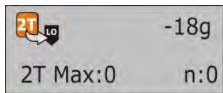

Characteristics of sample's negative errors 2T:

-18g - value of negative error 2T,
2T Max - permissible number of negative errors 2T,
n - actual number of negative errors 2T



Net mass of a controlled product



Tare



Control status: positive, negative

Load full

Command for process in progress with specified number of all packagings to be weighed



Work pane options: numerical data / graph



Display of information on control or weighing results of performed control



Abortion of a control process

• Control status

Control status is presented by the following pictograms:



- positive,



- negative (control of sample 2 permitted)



- negative

For status  respective field of a work pane turns to yellow:



- yellow warns that occurrence of another T error will end with negative result of control.

For status  respective field of a work pane turns to red:

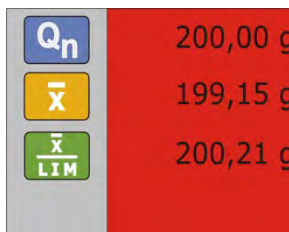

- average mass of controlled product is lower than disqualifying average value

• Work pane

1. Upon pressing  button the work pane takes form of a graph with weighing results:

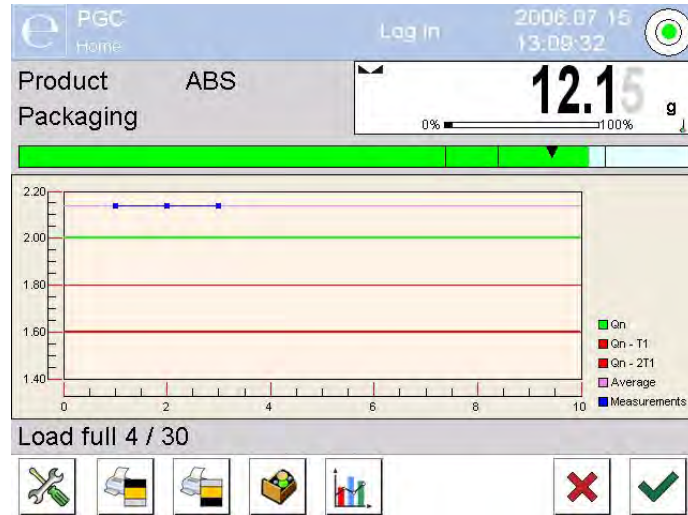

2. Press  button again to switch the graph off.

- **Information on control**

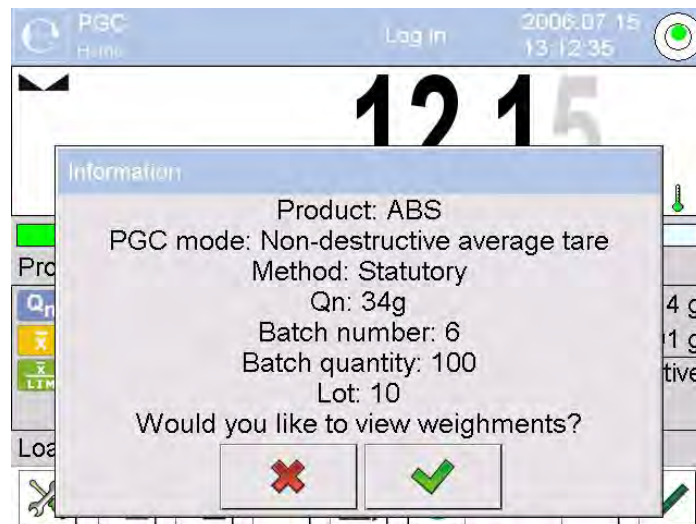

Upon pressing  button, respective window with information on control settings is displayed:

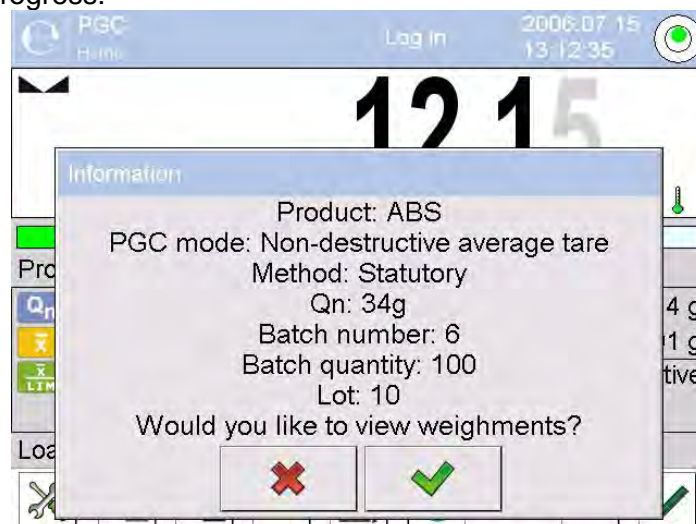

Window for control in progress:



Press  button to see a window with measurements performed for actual control:

Measurements		
1	 2006.07.15 13:12:29	2.14 g
2	 2006.07.15 13:12:30	2.14 g

Upon control completion, summary of the process is generated, control is automatically saved to database:

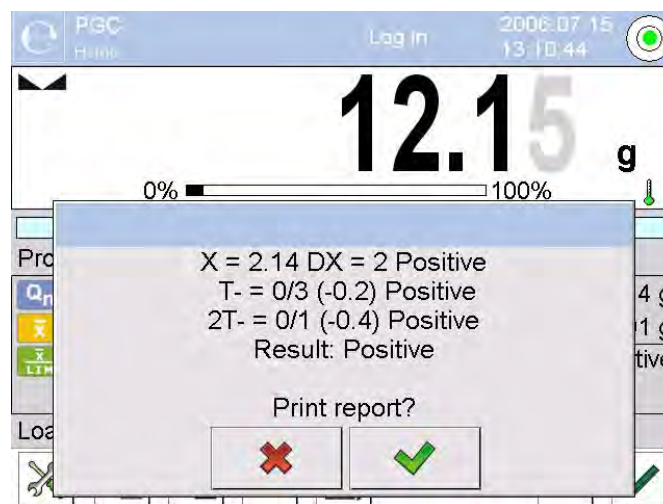

The screenshot shows the PGC control interface. At the top, it displays 'PGC Home', 'Log in', and the date '2006.07.15' with time '13:10:44'. A large digital scale display shows '12.15 g' with a 0% to 100% progress bar below it. A summary dialog box is overlaid on the screen, containing the following text:

```

X = 2.14 DX = 2 Positive
T- = 0/3 (-0.2) Positive
2T- = 0/1 (-0.4) Positive
Result: Positive

Print report?
  
```

At the bottom of the dialog box are two buttons: a red 'X' button and a green checkmark button.

- Press  button to print report on a printer connected to the balance.
- Press  to get back to setting window of **<Prepacked Goods Controls>** mode without printing the report.

Caution:

For cooperation with  **E2R System** summary process message shall not contain a query for report printout. All data is automatically sent to a computer program, report may be printed by means of a computer.

If during the control course the number of negative T errors detected by the software requires controlling another sample from the batch (as specified by the regulation on CPG), then on completing the measuring process of sample 1, the following message is displayed:



Press  button to confirm, the text and permissible errors quantity get updated. Upon completion of second sample control the software generates summary of the control. Report on performed control may be printed on a balance-connected printer.

Caution:
For example and a template of a report on average tare determination and product control go further down this user manual.

27.9. NON-DESTRUCTIVE EMPTY-FULL CONTROL MODE

It is possible to preset in a product data batch portion to be measured in a **Non-destructive empty-full** control.

The software, accordingly to the pre-set batch portion, displays a message asking you to weigh empty packagings first, full next in the same order:

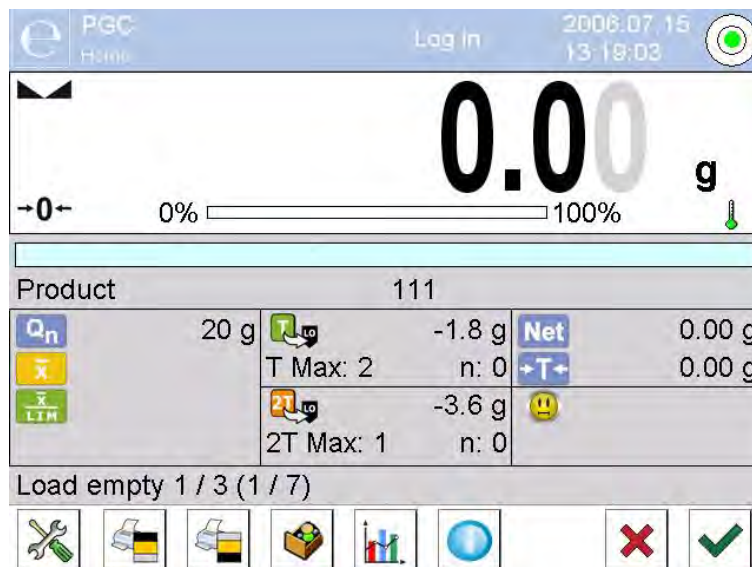







Where:

Product Code



- Controlled product name
- Controlled product code
- Controlled product nominal value
- Controlled product average mass
- Disqualifying average value

	-4,5g	-	Characteristics of sample's negative errors T
T Max:2	n:0	-	
	-9g	-	Characteristics of sample's negative errors 2T
2T Max:0	n:0	-	
		-	Net mass of controlled product
		-	Tare
		-	Control status
Load empty 1/3		-	Command for process in progress; measuring batch portion value
		-	Work pane options: numerical data / graph
		-	Abortion of a control process

On control completion, a report is generated and saved to the balance's database.

Caution:

For example and a template of a report on a control go further down this user manual.

27.10. DESTRUCTIVE EMPTY-FULL AND FULL-EMPTY CONTROL MODE

In the **Destructive** control mode, for the size of product lot over 100 parts, sample set by the software for testing is always 20 parts. The other control assessing criteria are set in accordance with the law regulations.

Procedure:

1. Select a product using the list; set its parameters for destructive control and determine a measuring **batch portion**.
2. Start destructive control; prompts helping you to go through control process are displayed (as in case of the controls described above).

Depending on enabled control mode, the order of products to be weighed is either: “**empty-full**” or “**full-empty**”.

Caution:

It is necessary to weigh empty packages in the same order as packages filled with product. With this the software calculates mass of a load placed in its corresponding packaging correctly.

On control completion, a report is generated and saved to the balance's database.

Caution:

For example and a template of a report on a control go further down this user manual.

27.11. CONTROL ACCORDING TO INTERNAL CRITERIA

Procedure:

1. Select appropriate product with data on control entered correctly in accordance with internal criteria (see: previous sections of this user manual).
2. Enter PGC mode parameters into balance memory (follow user manual instruction).
3. Press  button to start control.
4. The following prompts on continuous analysis of measurements results are displayed:

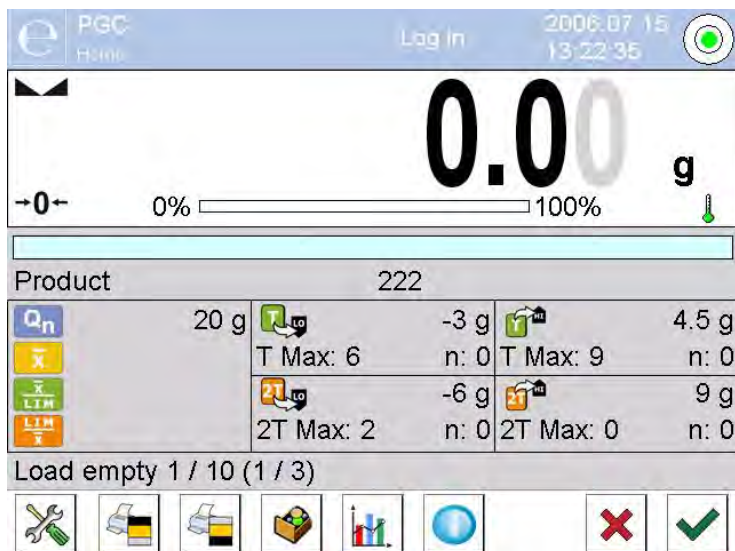

Where:

Product

Code



	-3g
T Max:2	n:0
	-6g
2T Max:6	n:0
	4,5g
T Max:0	n:0
	9g
2T Max:9	n:0

Load empty 1/30







- Controlled product name
- Controlled product code
- Controlled product nominal value
- Controlled product average mass
- Disqualifying negative average value
- Disqualifying positive average value
- Characteristics of sample's negative errors **T** (according to section 28.4 of this user manual)
- Characteristics of sample's negative errors **2T** (according to section 28.4 of this user manual)
- Characteristics of sample's positive errors **T**:
4,5g – value of positive error **T**,
T Max – permissible positive **T** errors quantity,
n – actual number of positive errors **T**
- Characteristics of sample's positive errors **2T**:
9g - value of positive error **2T**,
2T Max - permissible positive **2T** errors quantity,
n - actual number of positive errors **2T**
- Command for process in progress
- Work pane options: numerical data / graph
- Abortion of a control process

On control completion a report is generated and saved to the balance's database.

Caution:



For example and a template of a report on a control go further down this user manual.

27.12. REPORTS

<i>A report on determining average tare value</i>	<i>A report on product control</i>																																																																														
<p>Report on average tare: U/22/08/12/14/21/T</p> <p>-----</p> <table border="0"> <tr><td>Balance type</td><td>xx 4Y</td></tr> <tr><td>Max capacity</td><td>xx g</td></tr> <tr><td>Reading unit</td><td>xx g</td></tr> <tr><td>Balance ID</td><td>303</td></tr> <tr><td>Date</td><td>2013.05.07 13:37:30</td></tr> <tr><td>Product</td><td>1</td></tr> <tr><td>Tare</td><td>33.447 g</td></tr> <tr><td>0.25 T1</td><td>2.25 g</td></tr> <tr><td>Measurements quantity</td><td>10</td></tr> <tr><td>Standard deviation</td><td>0. 00483 g</td></tr> <tr><td>Result</td><td>Positive</td></tr> </table> <p>Measurements</p> <ol style="list-style-type: none"> 1. 33.44 g 2. 33.44 g 3. 33.44 g 4. 33.45 g 5. 33.45 g 6. 33.45 g 7. 33.45 g 8. 33.45 g 9. 33.45 g 10. 33.45 g <p>-----</p> <p>Signature</p> <p>.....</p>	Balance type	xx 4Y	Max capacity	xx g	Reading unit	xx g	Balance ID	303	Date	2013.05.07 13:37:30	Product	1	Tare	33.447 g	0.25 T1	2.25 g	Measurements quantity	10	Standard deviation	0. 00483 g	Result	Positive	<p>----- PCG Report: U/22/08/12/14/22 -----</p> <p>-----</p> <table border="0"> <tr><td>Balance type</td><td>xx 4Y</td></tr> <tr><td>Max capacity</td><td>xx g</td></tr> <tr><td>Reading unit</td><td>xx g</td></tr> <tr><td>Balance ID</td><td>303</td></tr> <tr><td>Start date</td><td>2013.05.06 14:15:49</td></tr> <tr><td>End date</td><td>2013.05.06 14:17:04</td></tr> <tr><td>User</td><td></td></tr> <tr><td>Product</td><td>2</td></tr> <tr><td>Batch no.</td><td>99</td></tr> <tr><td>Nominal mass</td><td>100 g</td></tr> <tr><td>Tare</td><td>0 g</td></tr> <tr><td>Value of T1 error</td><td>4.5 g</td></tr> <tr><td>Value of 2T1 error</td><td>9 g</td></tr> <tr><td>Value of +T1 error</td><td>g</td></tr> <tr><td>Value of +2T1 error</td><td>g</td></tr> <tr><td>Batch quantity</td><td>500</td></tr> <tr><td>Measurements quantity</td><td>30</td></tr> <tr><td>No. of T1 errors</td><td>0</td></tr> <tr><td>No. of 2T1 errors</td><td>0</td></tr> <tr><td>Min</td><td>98.579 g</td></tr> <tr><td>Max</td><td>100.02 g</td></tr> <tr><td>Average</td><td>99.72983 g</td></tr> <tr><td>Total</td><td>2991.895 g</td></tr> <tr><td>Average limit</td><td>99.70685 g</td></tr> <tr><td>Average limit [+]</td><td>g</td></tr> <tr><td>Standard deviation</td><td>0.582804 g</td></tr> <tr><td>PGC mode</td><td>Non-destructive average tare</td></tr> <tr><td>Result</td><td>Positive</td></tr> </table> <p>Measurements</p> <ol style="list-style-type: none"> 1. 100.008 g 2. 98.579 g 3. 98.582 g 4 . . . 28. 100.013 g 29. 100.012 g 30. 100.012 g <p>-----</p> <p>Signature</p> <p>.....</p>	Balance type	xx 4Y	Max capacity	xx g	Reading unit	xx g	Balance ID	303	Start date	2013.05.06 14:15:49	End date	2013.05.06 14:17:04	User		Product	2	Batch no.	99	Nominal mass	100 g	Tare	0 g	Value of T1 error	4.5 g	Value of 2T1 error	9 g	Value of +T1 error	g	Value of +2T1 error	g	Batch quantity	500	Measurements quantity	30	No. of T1 errors	0	No. of 2T1 errors	0	Min	98.579 g	Max	100.02 g	Average	99.72983 g	Total	2991.895 g	Average limit	99.70685 g	Average limit [+]	g	Standard deviation	0.582804 g	PGC mode	Non-destructive average tare	Result	Positive
Balance type	xx 4Y																																																																														
Max capacity	xx g																																																																														
Reading unit	xx g																																																																														
Balance ID	303																																																																														
Date	2013.05.07 13:37:30																																																																														
Product	1																																																																														
Tare	33.447 g																																																																														
0.25 T1	2.25 g																																																																														
Measurements quantity	10																																																																														
Standard deviation	0. 00483 g																																																																														
Result	Positive																																																																														
Balance type	xx 4Y																																																																														
Max capacity	xx g																																																																														
Reading unit	xx g																																																																														
Balance ID	303																																																																														
Start date	2013.05.06 14:15:49																																																																														
End date	2013.05.06 14:17:04																																																																														
User																																																																															
Product	2																																																																														
Batch no.	99																																																																														
Nominal mass	100 g																																																																														
Tare	0 g																																																																														
Value of T1 error	4.5 g																																																																														
Value of 2T1 error	9 g																																																																														
Value of +T1 error	g																																																																														
Value of +2T1 error	g																																																																														
Batch quantity	500																																																																														
Measurements quantity	30																																																																														
No. of T1 errors	0																																																																														
No. of 2T1 errors	0																																																																														
Min	98.579 g																																																																														
Max	100.02 g																																																																														
Average	99.72983 g																																																																														
Total	2991.895 g																																																																														
Average limit	99.70685 g																																																																														
Average limit [+]	g																																																																														
Standard deviation	0.582804 g																																																																														
PGC mode	Non-destructive average tare																																																																														
Result	Positive																																																																														
<p>Report template: You can edit a template of a report on product control. To do it enter  Printouts/  Printout template of a report on average tare > submenu. The report printout features variables attributed to <YES> parameter.</p>	<p>Report template: You can edit a template of a report on product control. To do it enter  Printouts/  Printout template of a CPG report > submenu. The report printout features variables attributed to <YES> parameter.</p>																																																																														



28. MASS CONTROL







(not available in standard balance version)

<  **Mass control** > is a working mode enabling you to control mass of a product automatically batched (dosed) onto the weighing pan, wherein batching is carried out using balance-connected PA-02 automatic feeder. <  **Mass control** > automatically determines quantity and controls a complete batch of tested product.

28.1. MASS CONTROL GLOBAL SETTINGS

Procedure:



1. To enter <  **Mass control** > working mode press grey workspace on balance's display,
2. Select <  **SETTINGS** > parameter, which contains the following:

	Request batch number	The parameter requests a batch number before starting mass control process.
	Batch quantity	The parameter determines quantity of a batch, i.e. number of product units to be controlled.
	Low limit	The parameter exceeding which causes accepting a measurement record by a balance.
	High limit	The parameter exceeding which causes omitting a measurement in the summary, e.g. if two parts (pills) are simultaneously dispensed on a weighing pan.
	Print report	The parameter switches on/off automatic printout of a report on completing mass control process.
	Printout	The parameter enables selecting whether on completing the control process the balance is to trigger a standard or a non-standard printout.

28.2. MASS CONTROL PROCESS

Before starting the mass control process carry out the following steps:

Set batch quantity of a carried out mass control process:

1. Press grey workspace on a display and select <  **Settings** > parameter.
2. Select <  **Batch quantity** > parameter and enter quantity of units controlled in a current automatic mass control process.
3. Press  button to confirm.

Set <  **Low limit** > parameter. Provide value lower than weight value of the lightest controlled part. While setting the low limit value make sure that the set value prevents improper record of mass on a final report. Improper record may happen when the mass of a part is below the lightest part of the controlled batch, e.g. a half of a pill.

Set <  **High limit** > parameter. Provide value higher than weight value of the heaviest controlled part. While setting the high limit value make sure that the set value prevents improper record of mass on a final report. Improper record may happen when the mass of a part is greater than the heaviest part of the controlled batch, e.g. two pills simultaneously dispensed onto a weighing pan. In such case, the software skips the measurements and continues mass controlling process.

Set <  **Dosing power** > parameter. Provide value in [%] ranging from 0% to 100%.





Set nominal mass (Mass).

Set limits for errors: negative - <T1-> (Min) and positive - <T1+> (Max). Provide value in % of nominal mass value.

The dosing power, mass and error parameters are to be determined for each controlled product separately.

It is impossible to determine <T2-> and <T2+> errors. Their values are doubled values of errors <T1-> and <T1+>.

Procedure – setting control parameters:

1. Press **SETUP** button in the main window of <  **Mass control** > mode.
2. Select <  **Databases** > and <  **Products** > parameters.
3. Select product for which batch quantity, low limit, high limit, dosing power, nominal mass and limits for errors parameters need to be set.
4. Set required parameters and return to the main menu.
5. Select product to be controlled from the Database <  >.
6. Press  button to start automatic mass control process.
7. The balance automatically tares and the feeder dispenses first part onto weighing pan.
8. The feeder stops, weighs the first part and saves the first stable measurement result.
9. The indication zeroes and the feeder dispenses next part onto weighing pan.
10. The feeder stops, weighs the second part and saves the second stable measurement result.
11. The cycle repeats until all of the declared parts are checked (weighed) in the <Batch quantity> parameter.
12. During control process, the following parameters on the carried out control are displayed:
 - Set standard quantity
 - Product
 - Average
 - Standard deviation
 - T1- errors quantity
 - T1+ errors quantity
13. The measuring process for a specific batch completes.
14. The report is generated, saved to balance's database and printed on a balance-connected printer.

CAUTION:

Each control process can be aborted at any moment, to do it press  button. The process stops and the control cancels (no report is generated for an aborted control).

28.3. PRINTOUTS

Printouts option has been designed to enable you to determine content of particular standard printouts and to define non-standard printout.

Standard printout:

Standard printout comprises four internal blocks, each featuring different variables. Each variable can be attributed with parameter YES – i.e. printed, or NO – i.e. not printed.

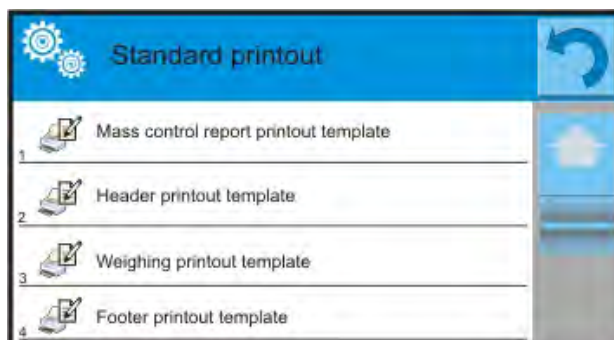

Settings for header printout, weighing printout, and footer printout are specified in section 14.5; settings for mass control report are presented below.

You can design content of a report.

CAUTION!

In order to specify which measurement data is to be printed on a report it is necessary to modify settings for <Weighing printout template> parameter. To enable particular measurement data printout set <YES> parameter for it.

Report content:

- | | |
|---------------------|--------------------------|
| - Working mode | - Threshold T2+ |
| - Date | - Measurements |
| - Time | - Quantity of errors T2- |
| - Balance type | - Quantity of errors T1- |
| - Balance ID | - Quantity of errors T1+ |
| - Report no. | - Quantity of errors T2+ |
| - User | - Average |
| - Product | - Average [%] |
| - Start date | - Standard deviation |
| - End date | - Standard deviation |
| - Batch no. | - Standard deviation [%] |
| - Standard quantity | - Empty line |
| - Nominal mass | - Dashes |
| - Threshold T2- | - Signature |
| - Threshold T1- | - Non-standard printout |

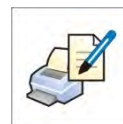



















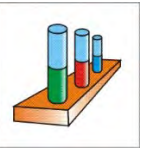

28.4. REPORT ON COMPLETED MASS CONTROL PROCESSES

On completing any type of mass control processes a report is generated and saved to the <  **Mass controls**> database. The files are named by date and time (hour) of control process.

29. DATABASES

Software of 3Y series balances features the following databases <  >:

 PRODUCTS	 WEIGHING RECORDS	 CUSTOMERS
 FORMULATIONS	 FORMULATIONS REPORTS	 DENSITY REPORTS
 PREPACKED GOODS CONTROLS	 AVERAGE TARES	 PIPETTES
 PIPETTE CALIBRATION REPORTS	 SERIES	 SQC REPORTS
 MINIMUM SAMPLE WEIGHT	 MASS CONTROLS	 AMBIENT CONDITIONS
 PACKAGES	 WAREHOUSES	 PRINTOUTS
 UNIVERSAL VARIABLES	 MANAGE THE DATABASE	

29.1. PROCESSES CARRIED OUT ON DATABASES

Databases can be operated only by an authorized personnel.

Procedure:

1. Press and hold for a moment a button with a respective database icon
2. Wait to see a database menu
3. Select one of available options (options depend on a database type)

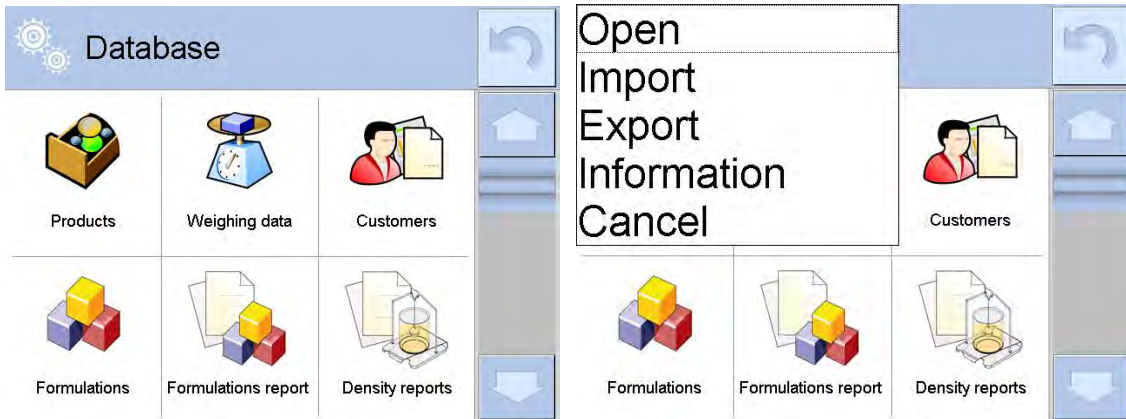

Options overview:



- OPEN – option allows to enter a chosen database (result is similar to the one obtained by a single click)
- IMPORT – option allows to import data from a USB flash drive. Plug the USB flash drive to a chosen USB port, upon its detection a window with a list of saved files opens. Select file with data to be imported. The copying starts automatically. Upon completion of the process a message: “Completed” is displayed. Confirm completion.
- EXPORT - option allows to export data from a selected database to a USB flash drive. Plug the USB flash drive to a chosen USB port, upon its detection the software automatically starts a copying process. On completion of the copying process a window with both, a file name to which data has been saved and message: “Completed” is displayed. Confirm completion.
- INFORMATION – option allows to display data about database content (see the picture below).



Press  button to return to the previous window.



- CANCEL - the software returns to the main window.

The following processes can be carried out in almost any of databases:

1. Adding entry to a database <  >
2. Searching for a record in a database by name <  >
3. Searching for a record in a database by code <  >



4. Searching for a record in a database by date < >
5. Exporting database content to a USB flash drive through USB port < >
6. Printing data on a specific record from a database < >

The above processes are carried out by pressing dedicated soft keys located in the upper right corner of the display. Follow the prompts displayed by the balance's software.

29.2. PRODUCTS

Database of products contains names of all products that are weighed, counted or controlled.

Procedure:

1. Enter submenu < Databases>, and press < Products> field.
2. Press < Add > button to add a new product to the database.
3. Select one of available options:

List of parameters defined for a product:

Name	
Description	
Product code	
EAN code	
Mass	[Unit mass of a product]
Dosing power	[Enabled only in <Mass control> mode, and determined in [%] from 0% to 100 %. It is operation power of the automatic feeder PA-02. The value of dosing power has to be determined by tests dependent on size, shape and mass of dispensed parts (pills)]
Min	[Minimal mass for weighing the product using result control thresholds – LO. Value of error <T1-> in working mode <Mass control> determined as percent of the nominal mass]
Max	[Maximal mass for weighing the product using result control thresholds – HI. Value of error <T1+> in working mode <Mass control> determined as percent of the nominal mass]
Tolerance	[% value calculated in relation to mass (5), denoting measuring area in which the measurement is recognized as correct.]
Tare	[Product's tare value, set automatically on selecting a product from the database]
Price	[Unit price of a product]
PGC mode	[Control mode (Non-destructive average tare, Non-destructive empty – full, Destructive full – empty, Destructive empty – full)]
Batch	[Measuring batch for control: Non-destructive empty – full, Destructive full – empty, Destructive empty – full]
Unit	[Product measuring unit]
Batch quantity	[Option available only for <PGC> mode, specifies controlled product batch quantity]
Average tare estimation interval	[Option available only for <PGC> mode, specifies minimal time interval needed for estimation of a

	packaging average tare; given in [h]; if software detects that pre-set time interval has passed it displays a message: “ Estimate average tare ”. It is the you who decides whether to estimate the tare again or not. The message has an informative function only.]
Number of packagings	[Option available only for <PGC> mode, specifies number of packagings needed for estimation of average tare]
Internal control	[Option available only for <PGC> mode, allows for specification of internal control criteria accordant with company standards for a given product]
SQC	[Option available only for <SQC> mode, allows for specification of internal control criteria accordant with company standards for a given product]
Density	[Product’s density, used for compensating air buoyancy, as sample density] - [g/cm ³]
Shelf-life time in days	
Date	[Set product’s date (constant)]
VAT	[VAT value related to a product]
Ingredients	[Editing field for inserting names of ingredients used for preparing a product, e.g. if a product is a mixture, or if a product requires additional description of its features or application]
Printout	[Printing a template assigned to a product]



CAUTION:

Remember to assign products to corresponding functions, as some of data values are attributed according to their modes, e.g. thresholds in <Checkweighing> mode are set in [g], while thresholds in <Parts counting> mode are set in [pcs]. The values are selected automatically depending on which mode is enabled while entering a database.

29.3. WEIGHING RECORDS

Each measurement result sent from a balance to a printer or a computer is saved to the database of weighing records (see an exception – section 16.1. – Result control). You can preview data from each weighing record.

Procedure:

1. Enter  **Databases**> submenu.
2. Enter  **Weighing records**> database and press desired record.

List of parameters for a weighing record saved to the database:



1. Measurement date
2. Measurement result
3. Tare value
4. Determination of measurement status (stable / unstable)
5. Product name
6. User
7. Customer, Customer name
8. Working mode name
9. Warehouse, name of source warehouse
10. Packaging, name of tare applied during weighing product’s weighing process

11. Result control, information on threshold in which the weighed product was placed:
 MIN – below LOW threshold (possible only if <Result control> is set to <NO>)
 OK – between the LOW and HIGH thresholds,
 MAX – above HIGH threshold (possible only if <Result control> is set to <NO>),
12. Weighing platform no., field denoting number of a weighing platform (balance/scale) on which a measurement was carried out,
13. Levelling, demonstrates if level status was maintained during measurement,
14. Ambient conditions alerts, demonstrates if temperature and humidity were stable during measurement.

29.4. CUSTOMERS

Customers database contains name of Customers for whom the measurements are carried out.

Procedure:

1. Enter submenu  <Databases>, and press < Customers> field.
2. Press  Add > button.
3. If a customer already exists in the database of customers, press field with its name.



List of parameters defined for a customer:

Customer name	
Customer code	[internal code identifying a customer]
VAT no.	[tax identification no.]
Address	
Postal code	
City	
Discount	
Printout	[type of printout, label declared to a customer]

29.5. FORMULATIONS

Formulations database contains list of designed formulations, which can be prepared by weighing each of formulations' ingredients.

Procedure:

1. Enter submenu  <Databases>, and press < Formulations> field.
2. Press  Add > button, should a new formulation be designed.
3. If a formulation already exists in the database, press field with its name.

List of parameters defined for a formula:

1. Name
2. Code
3. Ingredients
4. Number of ingredients
5. Sum

29.6. FORMULATIONS REPORTS

Formulations reports contain data on completed formulations. Each report can be previewed, searched by name, date, code or exported and printed.

Procedure:

1. Enter submenu < Databases>, and press < Formulations reports> button.
2. Press field of a desired report record, unless it is visible on the top of the list, wind the list forward using navigating keys.
3. Report's name consists of date and time of its creation, e.g.: 2011.10.12 15:12:15.

Caution:

It is possible to use an option for searching a report.



List of parameters on a report on formulation:

1. Start date
2. End date
3. Formulation
4. Sum
5. Target value
6. User
7. Customer
8. Warehouse
9. Measurements quantity
10. Status

29.7. DENSITY REPORTS

Density reports contain data on carried out density determination processes of solids, liquids and air. Each report can be previewed, searched by name, date, code or exported and printed.

Procedure:

1. Enter submenu < Databases>, and press <  Density reports> key.
2. Press field of a desired report record, unless it is visible on the top of the list, wind the list forward using navigating keys.
3. Report's name consists of date and time of its creation, e.g.: 2011.12.12 11:12:15.

Caution:

It is possible to use an option for searching a report.

List of parameters in density report:

Sample number	[field with a value, if in Density mode option: Request sample number is set = YES]
Start date	
End date	
Density	[calculated density of a sample of solid, liquid or air]
Volume	[calculated volume of tested sample, <i>density measurement of solid object</i>]
Procedure	[depending on selected procedure, data contained on a report may change]
User	[name of a user carrying out the procedure]
Product	[name of tested sample]
Standard liquid	[name of liquid used for determining density <i>measurement of solid object</i>]
Standard liquid density	[<i>density determination of solid object</i>]
Temperature	[temperature of liquid used for carrying out a measurement, <i>density determination of solid object</i>]
Plunger volume	[<i>density determination of liquid</i>]

Mass of steel standard	[density determination of air]
Mass of aluminium standard	[density determination of air]
Density of steel standard	[density determination of air]
Density of aluminium standard	[density determination of air]
Weighing 1	[mass measurement of tested sample or a plunger in the air, or mass of measured steel standard]
Weighing 2	[mass measurement of tested sample or a plunger in liquid, or mass of measured aluminium standard]

29.8. PREPACKED GOODS CONTROLS

(not available in standard balance version)

Each product control carried out in SQC or PGC mode is sent to a connected printer and saved to the  **Prepacked Goods Controls** database. Each control saved to the database features its specific number set at the moment of its completion.

Control number format:

X / y y / M M / d d / H H / m m, where:

X - control type which takes the following values:

U – control regulated by the act,

Z – control completed by a user,

W - control regulated by an internal criteria for PGC or SQC mode

yy – year of control end,

MM – month of control end,



dd – day of control end,

HH – hour of control end,

mm – minute of control end.

You can preview data on each control.

Procedure:

1. Enter submenu  **Databases** in accordance with section 30 of this user manual.
2. Enter  **Prepacked Goods Controls** database and select a desired control record.

List of parameters defined for a control:

- | | |
|---------------------------|---|
| 1. Batch number | [batch no. of a controlled product] |
| 2. Result | [status (result) of a control] |
| 3. Start date | [date of control start] |
| 4. End date | [date of control end] |
| 5. Product | [name of a controlled product] |
| 6. User | [name of a user carrying out the control] |
| 7. Average | [average value from carried out measurements] |
| 8. Average limit | [average disqualifying value] |
| 9. Standard deviation | [average standard deviation] |
| 10. Batch quantity | [the value of batch quantity (batch size) for which the software accepts the size of tested sample in accordance with the regulation] |
| 11. Measurements quantity | [no. of completed measurements] |
| 12. Method | [control method (internal criteria, regulated by the act)] |

29.9. AVERAGE TARES

(function not available in standard balance version)

Before starting a **<Non-destructive average tare>** control an average tare value may be determined by weighing the packages. Each of above processes is automatically saved to the  **Average tares** database. Each control saved to the database on determining average tare value features its specific number set at the moment of its completion.

Control number format:

X / y y / M M / d d / H H / m m, T where:

X - control type which takes the following values:

- U – control regulated by the act,
- Z – control completed by a user,
- W - control regulated by an internal criteria,

yy – year of control end,

MM – month of control end,

dd – day of control end,



HH – hour of control end,

mm – minute of control end,

T – control with determining the average tare value.

You can preview data on each process of average tare determination.

Procedure:

1. Enter submenu  **Databases** in accordance with section 30 of this user manual.
2. Enter  **Average tares** database and select a desired record.



List of parameters defined for a control:

- | | |
|--------------------------|---|
| 1. Product | [name of a product which packaging is checked for average tare determining process] |
| 2. Status | [status (result) of a process] |
| 3. Date | [date of carried out process] |
| 4. Tare | [determined value of packaging tare] |
| 5. S | [average standard deviation] |
| 6. 0.25 T1 | [the value of a criterion for process result] |
| 7. Measurements quantity | [number of completed measurements of tare value] |
| 8. User | [name of a user carrying out the process] |
| 9. Method | [control method (internal criteria, regulated by the act)] |

29.10. SERIES

Series database contains data saved for a series and measurements of samples.

Procedure:

1. Enter submenu  **Databases**, and press  **Series** field.
2. Press  **Add** > key to add a new series.
3. If a series already exists in the database, press field with its name to edit data that can be modified.

List of data defined for series:

1. Name
2. Code
3. Customer
4. Samples
5. Number of samples

29.11. SQC REPORTS

Each report on completed product control is sent to a printer and saved to the **<SQC Reports>** database. Each record features its individual number assigned on its completion.

Control number format:

yy / MM / dd / HH / mm / ss, where:

yy – year of control end,
MM – month of control end,
dd – day of control end,
HH – hour of control end,
mm – minute of control end,
ss – second of control end.

You can preview data contained in each of control records.

Procedure:

1. Enter submenu  Databases > in accordance with section 30 of this user manual.
2. Enter database < SQC Reports > and press a needed record from a completed control.

List of data defined for control:

Batch number	[Batch number of a controlled product]
Indication	[Control status]
Start date	[Date of control start]
End date	[Date of control end]
Product	[Name of controlled product]
User	[Name of operator carrying out a control]
Average	[Average value from completed measurements]
Average limit	[Value of disqualifying average]
Standard deviation	[Average standard deviation]
Batch quantity	[Quantity of batch; based on this value the software sets the amount of measured sample in accordance with the act]
Measurements quantity	[Number of carried out measurements]
Method	[Control method (statutory, internal, SQC)]
Control process chart:	

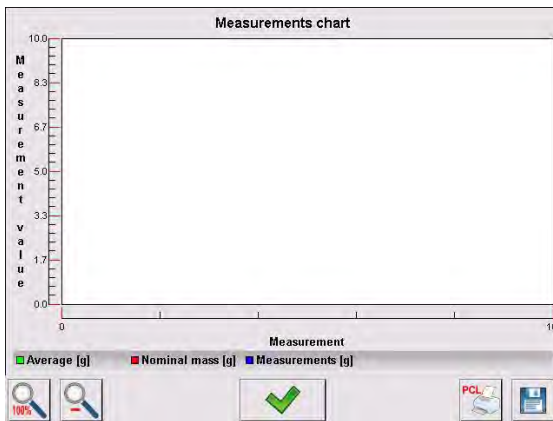

Control process chart with thresholds:

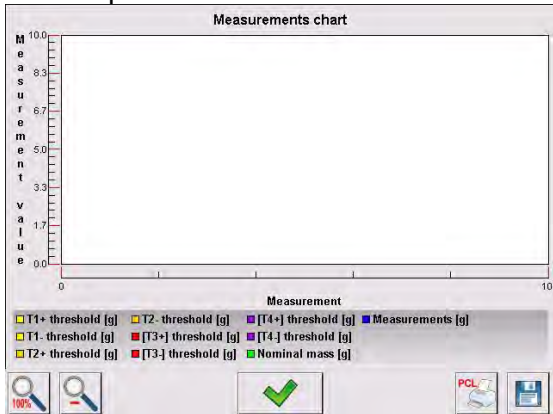

Distribution probability chart:

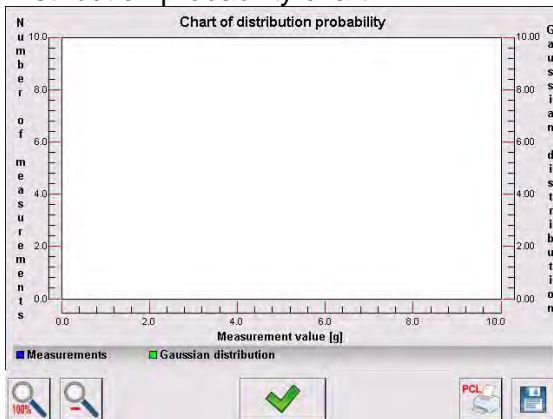



29.12. MINIMUM SAMPLE WEIGHT

Minimum sample weight database contains data on declared methods and minimum sample weights.

Caution:

Only authorized RADWAG personnel can enter new minimum sample weight records or make changes in those stored in the database.

Procedure

1. Enter submenu  Databases> and press  Minimum sample weight>.
2. Press  Add > button to add new minimum sample weight.
3. If a record on minimum sample weight is already stored in the database, then press field with its name to enter its details that can be modified.

List of parameters determined for a minimum sample weight:

- Name – name of method used for determining minimum sample weight.
- Code – method code.
- Description – method description
- Subsequent control – a field for entering expiry date of the minimum sample weight. 2 weeks before the expiry date, an icon of a clock displays next to the status icon. Contact RADWAG representative to carry out necessary changes in minimum sample weight settings.
- Thresholds – option that enables entering data on minimum sample weight mass and range of packaging mass (tare) with applicable criteria:

Tare – maximum value of tare for which the minimum sample weight is valid.

The software enables entering three characteristic quantities: 0.000g, optional mass from balance measuring range and Max balance measuring range (see example below).

Minimum mass – the value of minimum mass that is determined for a balance in its place of use in accordance with appropriate methods.

Example no. 1:

The following values were determined for this balance:

No.	Tare value	Minimum sample weight	Means of operation
1	0.0000 g	0.1000 g	The minimum sample weight refers to all net weighments that are weighed without a packaging (the <TARE> button is not applied)
2	10.0000 g	1.0000 g	The minimum sample weight refers to all net weighments that are weighed in a packaging that mass ranges from 0.0001 g to 10.0000 g inclusive (the <TARE> button applied)
3	50.0000 g	2.5000 g	The minimum sample weight refers to all net weighments that are weighed in a packaging that mass ranges from 10.0001 g to 50.0000 g inclusive (the <TARE> button applied)
4	200.0000 g	4.0000 g	The minimum sample weight refers to all net weighments that are weighed in a packaging that mass ranges from 50.0001 g to 200.0000 g inclusive (the <TARE> button applied)

Example no. 2:

No.	Tare value	Minimum sample weight	Means of operation
1	220.0000 g	0.5000 g	The minimum sample weight refers to all net weighments that are weighed in a packaging with optional mass from full measuring range of a balance (the <TARE> button applied), as well as on weighing samples without the packaging (the <TARE> button is not applied).

Example no. 3:

No.	Tare value	Minimum sample weight	Means of operation
1	0.0000 g	0.2500 g	The minimum sample weight refers to all net weighments that are weighed without a packaging (the <TARE> button is not applied). Minimum sample weight is valid only for weighing samples without packaging. If taring option is applied, then the software disables the pictogram informing on minimum sample weight in use, and renders the weighment as carried out with tare applied (minimum sample weight is not determined).

You can preview entered data, but data editing is disabled.

29.13. MASS CONTROLS

(mode not available in standard version of the balance)

Each product control carried out on a balance is sent to a connected printer and saved to the **<Mass controls>** database. Each control saved to the database features its specific number set at the moment of its completion.

Mass control number format:

y y / M M / d d / H H / m m, where:

yy – year of control end,
MM – month of control end,
dd – day of control end,
HH – hour of control end,
mm – minute of control end.







You can preview data on each control.

Procedure:

1. Enter submenu  **Databases** in accordance with section 30 of this user manual.
2. Enter **< Mass Controls >** database and select a desired control record.

List of data defined for a mass control:

A report on mass control features the following data:

 Batch number	Number of a batch under control
 Start date	Date of control start
 End date	Date of control end
 User	An operator carrying out the control
 Product	Product under control
 Average	Average mass determined based on carried out control process



Average [%]

Average mass determined based on carried out control process expressed in percent



Standard deviation

Standard deviation based on carried out control process



Standard deviation [%]

Standard deviation based on carried out control process expressed in percent



Quantity of errors T2-



Quantity of errors T1-



Quantity of errors T1+



Quantity of errors T2+



Batch quantity

Quantity of a controlled batch determined on a report

Each report can be printed.

Procedure:

1. Select the report and display its details.
2. Press < **Print**> key locator on the upper bar.
3. The printer connected to balance's terminal prints the report.

Additionally, the complete database can be exported to an external file by pressing a < **Export to file**> button located in the upper bar.

29.14. AMBIENT CONDITIONS

Ambient conditions database contains parameters related to ambient conditions. Depending on balance's settings, a report may contain data on temperature, humidity and value of atmospheric pressure. If THB ambient conditions module is connected to a balance, its records are also saved.

Procedure:

1. Enter submenu < Databases>, and press < Ambient conditions > key.
2. Press key of a desired report record, unless it is visible on the top of the list, wind the list forward using navigating keys.
3. Report's name consists of date and time.

Caution:

It is possible to use an option for searching a report.

29.15. PACKAGES

Packages database contains list of packages for which a name, code and mass value are specified. The tare value is automatically applied when a name of packaging is selected from the database during weighing process. The display indicates mass value with minus sign.

Procedure:

1. Enter submenu < Databases>, and press < Packages> key.
2. Press < Add > key to add new packaging.
3. If a packaging record already exists in the database, press field with its name, and insert data on the packaging.



Caution:

It is possible to use an option for searching a record by name or code.

29.16. WAREHOUSES

Depending on work organizing, the Database of Warehouses contains list of places used for picking up a sample for weighing or list of places to which a weighed sample was delivered. Each Warehouse has to have its name, code and description specified. While weighing process, and on selecting name of a Warehouse, it is automatically assigned to the measurement result.

Procedure:

1. Enter submenu < Databases>, and press < Warehouses> key.
2. Press < Add > key to add new warehouse.
3. If a warehouse record already exists in the database, press field with its name, and insert identifying data.



Caution:

It is possible to use an option for searching a record by name or code.

29.17. PRINTOUTS

Printouts database contains all NON-STANDARD printouts. Each printout features a name, code and a template.

Procedure:



1. Enter submenu < Databases> and press < Printouts> key.
2. Press < Add > key to add new printout or edit existing one.
3. If a non-standard printout template already exists in the database, press field with its name, and insert identifying data.

Caution:

It is possible to use an option for searching a record (printout) by name or code.

Designing new printout template

Procedure:

1. Enter submenu < Databases> and press < Printouts> key.
2. Press < Add > key to create a new printout.

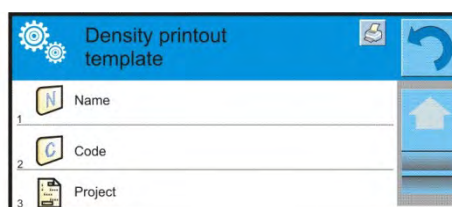
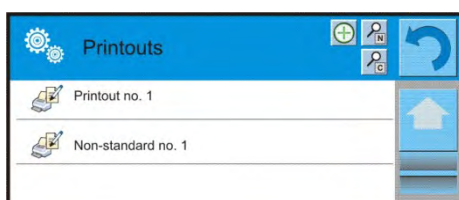

3. In the <Record editing> field press <Template> key.
4. A window is opened for creating an optional printout.
5. While designing a printout use on-screen keyboard displayed on the touch panel. It features the same options as a regular computer keyboard.

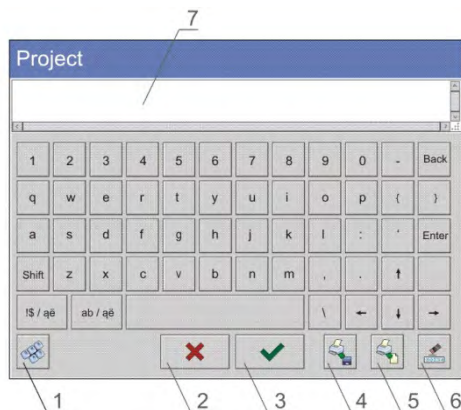

- 1 – enlarging the editing field (7), recommended while using an external computer keyboard connected to balance's USB port,
- 2 – cancel key
- 3 – confirmation key
- 4 – download a printout template from a file
- 5 – list of variables for use while designing a printout
- 6 – delete all printout content
- 7 – printout editing field

6. Save designed printout.

Caution:

To erase characters in a printout press Back key. To move cursor press navigating arrows.

Example of Printout no. 1 – using large editing field

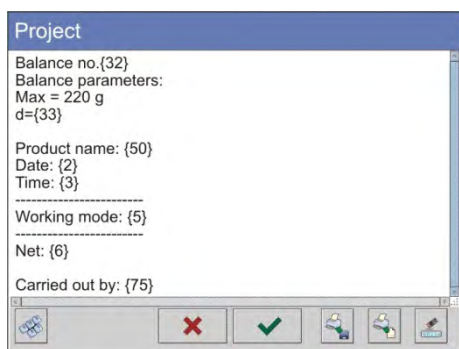

Template

Balance no. 400015
 Balance parameters:
 Max = 220 g
 d= 0.001 g

Product name:
 Date: 2011.10.24
 Time: 11:48:06

 Working mode: Weighing

 Net weight: 94.147

Carried out by: Admin

Printout template

Example of Printout no. 2 – printout from a file

All printout templates can be designed in a form of external files, that are imported to a balance. Such file has to have an extension: *.txt or *.lb and contain all constant and variable data. On importing, the content of a printout template can be modified.

Procedure:



1. Design a *.txt or *.lb file in an optional editor.
2. Copy the file to a USB flash drive.
3. Connect the USB flash drive to balance's USB port.

4. Press [4] < download a printout from a file > key.
5. Balance's display shows data stored on the USB flash drive connected to the USB port.
6. Search for a file with printout template and press its name.
7. The printout template is automatically copied to an editing field.

29.18. UNIVERSAL VARIABLES

Universal Variables are a set of alphanumerical data which are combined with printouts, products or other information related to weighing. Each variable has to have its name, code and value specified.

Procedure:

1. Enter submenu < Databases> and press < **Var** Universal variables > key.
2. Press < Add > key to add a new universal variable.
3. If a universal variable already exists in the database, press field with its name, and insert required modifications to the following fields: code, name, value.

Caution:

It is possible to use an option for searching a record by name or code.

29.19. DATABASES MANAGEMENT

Function allows to manage database data. It comprises three options: Export weighing database, Delete databases and Delete weighments and reports.

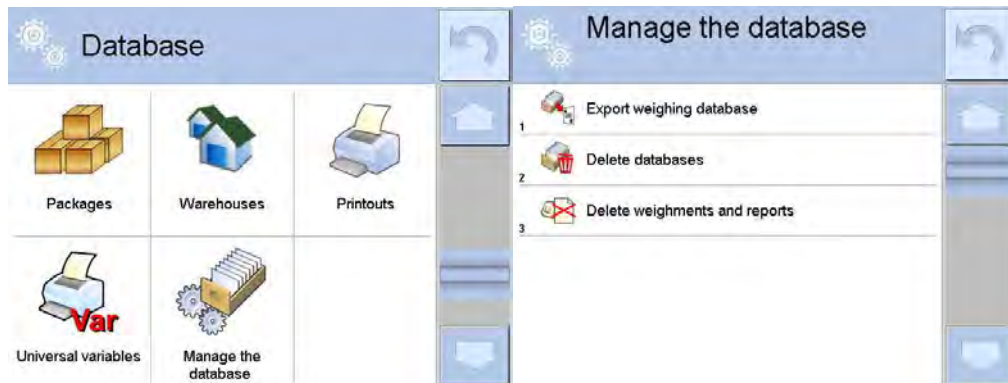

29.19.1. Export Weighing Database

All carried out measurements are saved to a database and can be exported to a file using a USB flash drive.

Procedure:

1. Insert a USB flash drive to balance's USB port.
2. Press < Export database of weighing records to a file>, the software opens a window where export options have to be set.

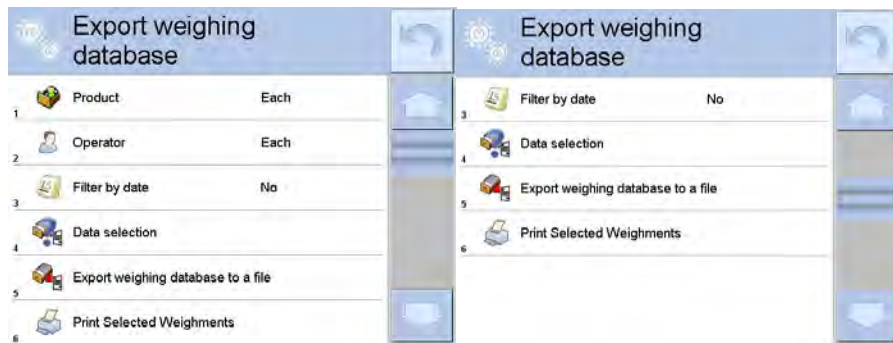

3. <Data selection> parameter allows you to specify which data related to measurement are to be exported.

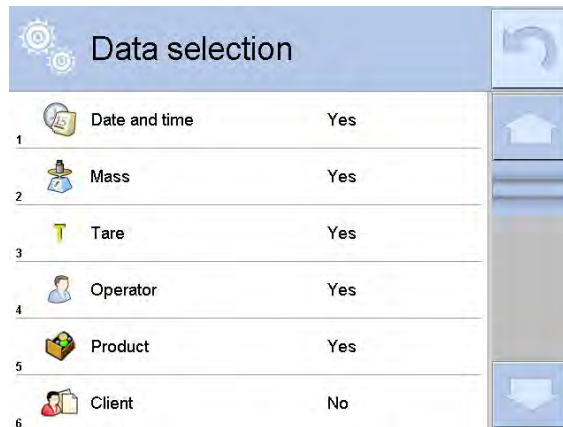

4. Set option and click <Export weighing database to a file>, software automatically exports weighing database.

5. Upon completion a respective message, information on number of exported data and the file name (with file extension *.txt) is displayed, next the software returns to the previous window.

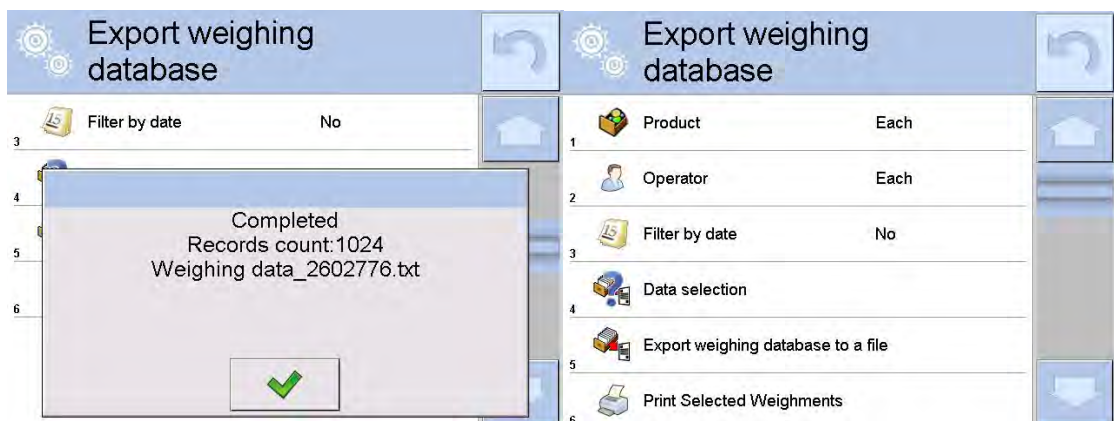

6. You may return to a weighing procedure or proceed to other settings.

Caution:

If a balance software cannot identify the USB flash drive then upon entering option <Export weighings database> a message <Operation failed> is displayed.

7. A name of created file consists of database name and balance serial number, e.g. <Weighing date_2602776.txt>.

8. Unplug the USB flash drive from the USB port.

Template of created file:

The file is created in a form of chart, columns of which are separated with <Tab>. This allows for direct export of the file to spread sheet document <Excel>.

The chart contains the following data:

1. Date and time,
2. Mass and mass unit,
3. Tare and tare unit,
4. Series number,
5. Operator's name,
6. Customer's name,
7. Packaging's name,
8. Source warehouse name,
9. Target warehouse name,
10. Control result.

29.19.2. Delete Databases

Function allows to delete data of a chosen database.

Procedure:

1. Activate <Delete databases>, a window with databases is displayed.
2. Select a database data of which is to be deleted.

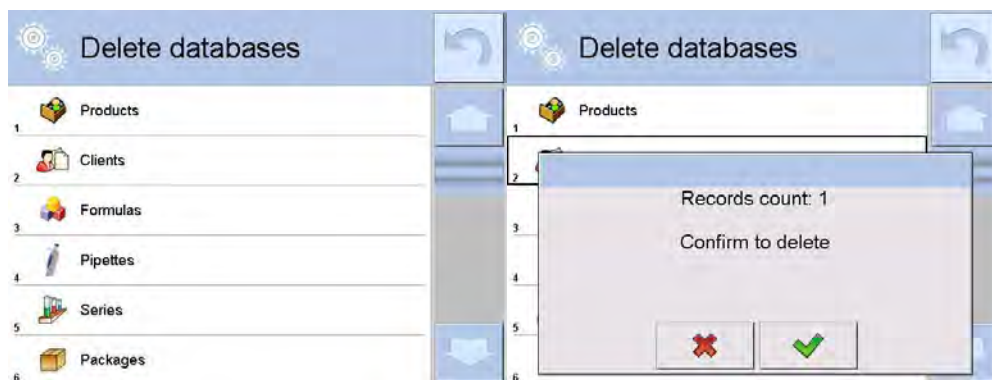

3. Upon confirmation the software deletes data and displays a message:



4. Upon confirmation the software returns to a previous window; you may continue a weighing procedure or proceed to other operations.

29.19.3. Delete Weighings and Reports

Function allows to delete weighments and reports of a given database.

Procedure:

1. Activate <Delete weighments and reports> a window with a numeric keyboard is displayed.
2. Enter a date specifying which data is to be removed using the keyboard.
3. Date is given in the following form: year-month-day.

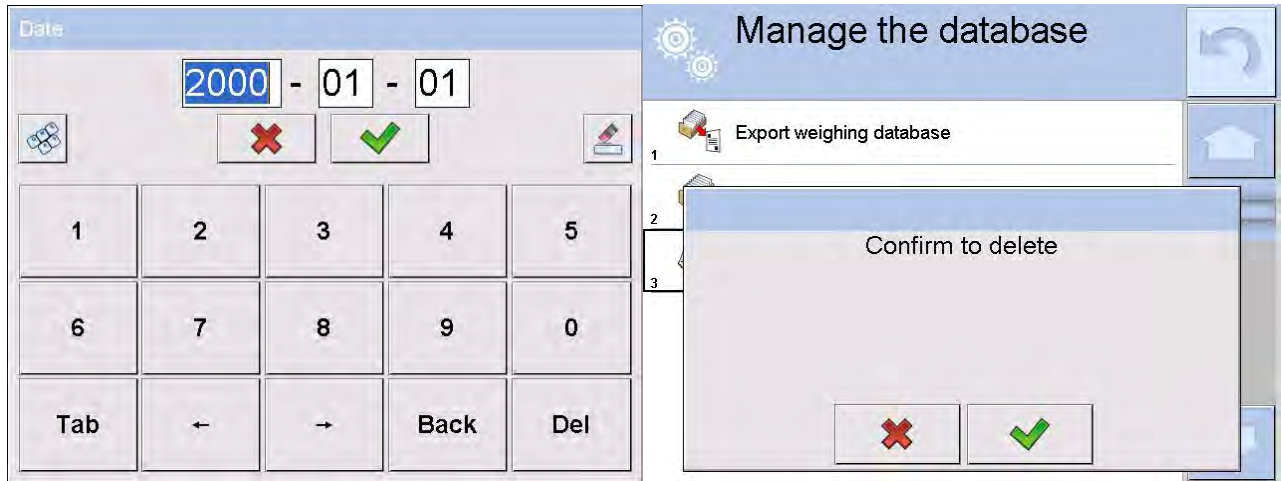

4. Upon confirmation of entered date all weighments and reports older than those specified by the date are removed.
5. Number of removed weighments and reports is displayed.

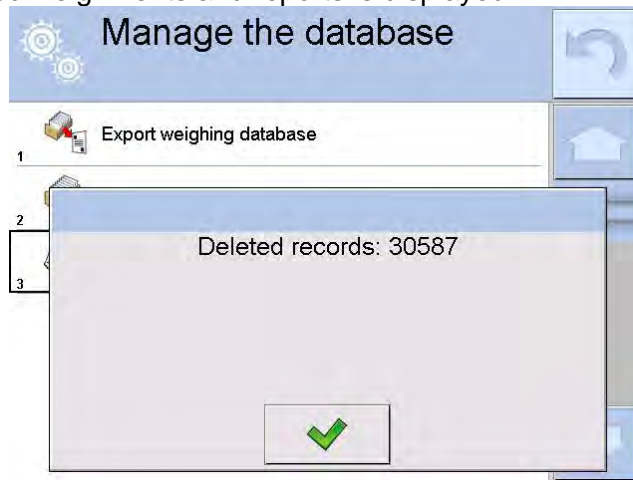





30. COMMUNICATION

Communication menu is located in a Parameters menu group.

It is accessed by pressing Setup key or <  Setup > quick access key.

The balance enables communicating with peripheral devices through the following ports:

-  COM 1 (RS232),
-  COM 2 (RS232),
-  Wifi,
-  Ethernet,
-  TCP.

Procedure:

1. Press  key to open <  Communication > parameters.
2. Configure ports.

30.1. RS 232 SETTINGS

Procedure:

1. Select communication port <  COM1 > or <  COM2 >.
2. Set appropriate values.

There are following transmission parameters for RS 232 ports:

- Baud rate - 4800, 9600, 19200, 38400, 57600, 115200 bit/s
- Data bits - 5, 6, 7, 8
- Stop bits - None, 1, 1.5, 2
- Parity - None, Odd, Even, Marker, Interval

30.2. ETHERNET SETTINGS

Procedure:

1. Select communication port <  Ethernet >.
2. Set appropriate values:

- DHCP - Yes – No
- IP Address - 192.168.0.2
- Subnet mask - 255.255.255.0
- Default gate - 192.168.0.1

Caution:

Above settings are for information purpose only. Transmission parameters have to be selected in accordance with the settings of customer's local network.

3. On carrying out changes, press  key; the following message is displayed:
<Restart balance to implement changes>
4. Return to weighing mode and restart the device.

30.3. WI-FI SETTINGS

Balance equipped with Wi-Fi module displays:



Procedure:

1. Select <  Wifi > communication interface.
2. Set the following parameters:
 - DHCP - Yes – No
 - IP Adresse - 10.10.9.155
 - Subnet mask - 255.255.255.0
 - Default gate - 10.10.8.244

Caution:

Above settings are for information purpose only. Transmission parameters have to be selected in accordance with the settings of customer's local network.

3. Upon completing modifications press  key, the following message is displayed:

<Restart balance to implement changes>

4. Return to weighing mode and restart the device.

You may use <Available networks> parameter to view the list of networks detected by the balance:

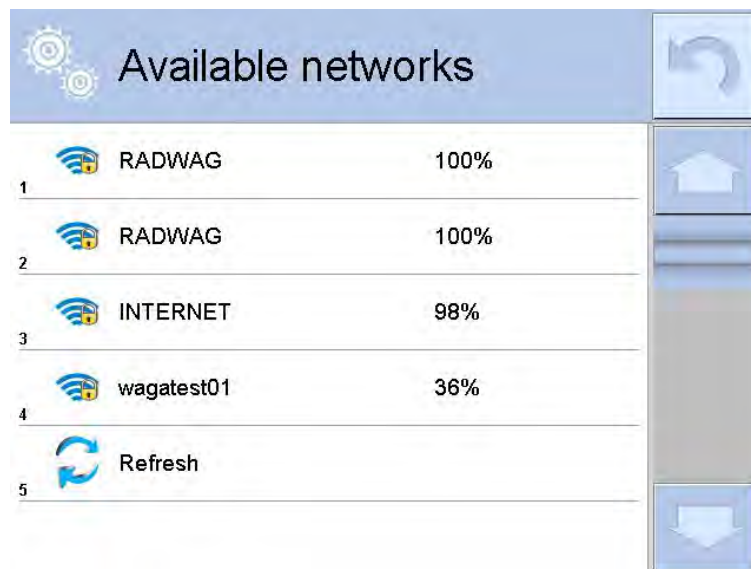

Icon with a padlock means that the password is required. Press <Refresh> icon to search for available networks.

Press <Network status> field to check selected network parameters. The following message is displayed:

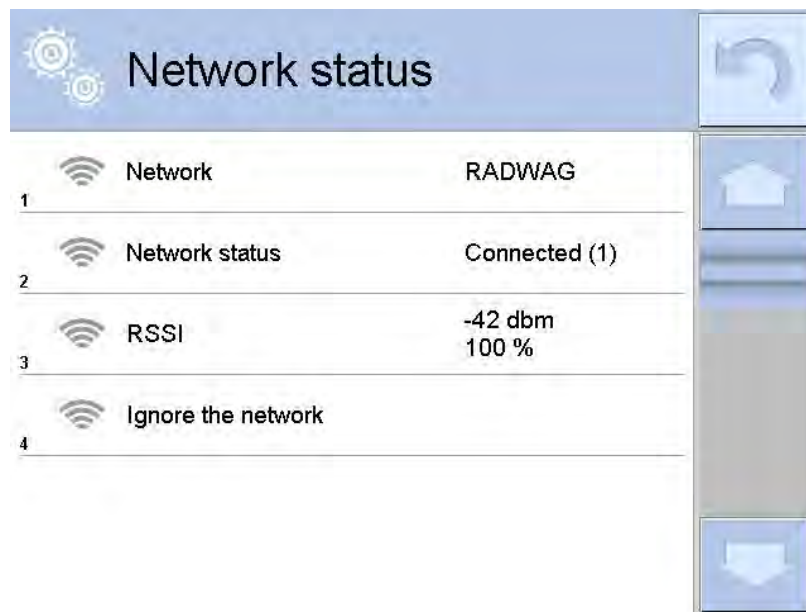





Selected network and parameters for connection are stored in the balance's memory. The software connects to the network using the stored parameters each time the balance is activated. You may change this by selecting <Ignore the network> which disconnects given network.

30.4. TCP SETTINGS

TCP (Transmission Control Protocol) operating in customer-server mode enables communicating two computers. Customer establishes connection on port specified by server. Follow procedure below to set port for TCP.



Procedure:

1. Enter <  Communication > parameters.
2. Select: „  Tcp /  Port “; a <Port> window opens with on-screen keyboard.
3. Insert required port number and confirm by pressing  key.



31. PERIPHERALS

Peripherals menu is located in menu Parameters. Press Setup button or <Setup  > icon to open it to see list of peripheral devices for cooperation with the balance.

31.1. COMPUTER

 icon displayed in the upper bar of the main window signals active connection between a balance and a computer. <  Computer > submenu enables configuring connection settings.

Procedure:

1. Press  key and next press “  Peripheral devices /  Computer “ key.
2. Set the following parameters:
 - computer port:
 - available options: none, COM 1, COM 2, TCP
 - address
 - give address of balance connected to a computer
 - continuous transmission

available options: NO, YES (*printout format depends on printout template set in a balance – see next parameter*).

- interval:
parameter allows for setting printout frequency for continuous transmission. Printout frequency is set in seconds, with 0.1s accuracy. You can set frequency in a range from 0.1 to 1000 seconds for continuous transmission activated using balance and computer.
- weighing printout template
it is possible to design an individual printout send to a computer using a dedicated window with printout template. Principles on creating printouts are described in section 30.19 of this user manual.
- E2R System
E2R System performs supervision and control over all weighing processes carried out using balance. On enabling the option, the processes carried out on some of the databases are carried out only from the computer level (mode not available in balance's standard version).

Caution:



<E2R System> can only be enabled by balance manufacturer or authorized personnel. To provide correct cooperation with E2R System continuous transmission has to be activated.

31.2. PRINTER

<Printer> submenu enables:

- Setting communication port with a printer.
- Defining printer's code page (default 1250).
- Defining controlling codes for PCL printer or EPSON label printer.
Caution: CODES MUST BE ENTERED IN A HEXADECIMAL FORM!
- Defining printout standards.

Speed of transmission respective for a printer (See: Printer settings) must be chosen for the balance to ensure its right cooperation with a printer (diacritical signs specified for a given language). Additionally, printout and printer code pages must be identical.

Code page accordance may be obtained as follows:

- by setting the right code page in the printer (see the printer manual) – respective to printout code page set in a balance; or
- by sending control code from a balance to the printer, which automatically sets the right code page (respective to code page set in a balance) in advance before execution of the data printout – it is possible only for printers supplied with such option.

Exemplary balance settings for a correct cooperation (Polish diacritical signs printout) with EPSON printer connected to RS232 port:

1. **EPSON TM-U220B Dot matrix printer**

Communication parameters:

- *baud rate* – 9600 bit/s
- *data bits* – 8
- *stop bits* – 1
- *parity* – none

Printer's parameters:

- *port* – COM1 or COM2 (the one to which the printer is connected)
- *code page* – **852**
- *controlling codes* – **1B7412**

2. Thermal printer EPSON TM-T20

Communication parameters:

- *baud rate* – 38400 bit/s
- *data bits* – 8
- *stop bits* – 1
- *parity* – none

Printer's parameters:

- *port* – COM1 or COM2 (the one to which the printer is connected)
- *code page* – **1250**
- *controlling codes* – **1B742D**

or

Printer's parameters:

- *port* – COM1 or COM2 (the one to which the printer is connected)
- *code page* – **852**
- *controlling codes* – **1B7412**

If there are any unexpected signs on the printout in the place of the last digit (for verified balances), then <CONTROLLING CODES> parameter has to also incorporate code of the UK signs chart: **1B5203**. In such case the <CONTROLLING CODES> parameter setting has to be as follows: controlling codes - **1B74121B5203**.

A printout standard describes how to print information from databases. Printout standard can be modified if insufficient. In order to check format of printout standard, print data related to e.g. product parameters – function activated on moving to <Products/Edit product> database and pressing printer icon.

Default values for each of printout standards:

Product printout template	{50}
	{51}
User printout template	{75}
	{76}
Customer printout template	{85}
	{86}
Warehouse printout template	{130}
	{131}
Packaging printout template	{80}
	{81}
	{82}

Ambient conditions printout template:

```
----- AMBIENT CONDITIONS -----  
Date and time: {275}  
Temperature of sensor 1: {value} °C  
Temperature of sensor 2: {value} °C  
Temperature THBS: {value} °C  
Humidity THBS: {value} %  
-----
```

Formulation printout template:

```
----- Formulation -----  
Formulation name:          {165}  
Number of ingredients:    {167}  
Target mass:              {168} g  
Formulation ingredients:  {169}  
-----
```

31.3. BARCODE SCANNER

Balance enables cooperating with a barcode scanner used to quick searching for the following products:

- Products
- Users
- Customers
- Packagings
- Warehouses
- Formulations
- Pipettes
- Series in a differential weighings
- Universal variables

To configure barcode scanner follow instruction below:



„ /  **Peripherals** /  **Barcode scanner**”.

Caution:

< *Communication*> submenu requires setting baud rate to compatible with the one used by barcode scanner (default 9600b/s). For detailed description of communicating the balance with a barcode scanner go to APPENDIX E of this user manual.

31.3.1. Barcode Scanner's Port





Procedure:

1. Open < **Peripherals**> group of parameters.
2. Press < **Barcode scanner**>.
3. Select suitable option of those presented below.

Ports:

- RS 232 (COM1),
- RS 232 (COM2),
- USB



31.3.2. Prefix/Suffix





You can edit <  **Prefix**> and <  **Suffix**> to synchronize balance's program with barcode scanner.

Caution

In RADWAG balances prefix contains character (byte) presented as 01 hexadecimal, whereas suffix contains character (byte) 0D hexadecimal. For detailed description of communicating the balance with a barcode scanner go to APPENDIX E of this user manual.

Procedure:



1. Open < **Barcode scanner**> submenu.
2. Select <  **Prefix**> parameter and enter hexadecimal value using on-screen keyboard.











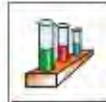

3. Press  to confirm changes.
4. Select   **Suffix** parameter and enter hexadecimal value using on-screen keyboard.
5. Press  to confirm changes.

31.3.3. Field Selection







You can customize field selection in databases after which searching is carried out.

Procedure:

1. Open <  Peripherals > group of parameters.
2. Select <  **Barcode scanner** /  **Fields selection** >.
3. The following list is displayed:

	Product		Series
	User		Universal variable 1
	Customer		Universal variable 2
	Packaging		Universal variable 3
	Warehouse		Universal variable 4
	Formulation		Universal variable 5
	Pipette		

4. Select one item from the list. The following parameters may be edited:

	Filtering	Selecting object for which the searching is carried out (see table below)
	Offset	Setting first significant barcode sign from which the searching is carried out. All preceding signs are omitted.
	Code length	Setting number of barcode signs used for searching.
	Start marker	Selecting starting point of scanned code used for searching.
	End marker	Selecting ending point of scanned code used for searching.
	Ignore marker	Selecting using or ignoring start and end markers when comparing scanned code with code saved to the balance.



List of Filtering items:

Field selection	Filtering
Product	None, Name, Code, EAN code
User	None, Name, Code,
Customer	None, Name, Code,
Packaging	None, Name, Code,
Warehouse	None, Name, Code,
Formulation	None, Name, Code,
Pipette	None, Name, Code,
Series	None, Name, Code,
Universal variables	None, Active

31.3.4. Test

 **Test** function enables correct operation of barcode scanner connected to balance.

Procedure:

1. Open  **Barcode scanner** submenu.
2. Press  **Test** parameter; **Test** window opens with ASCII and HEX fields in it.
3. Scanned barcode is entered into ASCII or HEX field; result of test is displayed in the bottom part of the window.

When:

- **Prefix** and **Suffix** are identical for both – balance settings and scanned barcode – the test is **Positive**.
- **Prefix** and **Suffix** differ for both – balance settings and scanned barcode – the test is **Negative**.

31.4. TRANSPONDER CARD SCANNER

You can log in to the balance by means of:

- Inserting user's password using on-screen keyboard,
- Transponder card scanner, by approximating a registered card to the scanner.

Caution:

For correct balance's cooperation with a transponder card scanner set appropriate baud rate value in submenu  **Communication** (default 9600b/s).

Transponder card scanner port



The balance enables communicating with a transponder card scanner using the following ports:

- RS 232 (COM1),
- RS 232 (COM2).

In order to log in an operator using a transponder card scanner, first assign a number of an already registered card to a selected user in the database of operators.

Procedure:

1. Connect a transponder card scanner to a balance's port (RS 232 COM1 or RS 232 COM2), select communication port in balance settings for the transponder card scanner.
2. In  **Communication** submenu set baud rate for compatible with the one of the transponder card scanner (default 9600b/s).

3. Enter operators database, go to  **<RFID Card no.>** parameter and edit desired operator's record.
4. On entering editing mode in  **<RFID Card no.>** parameter, an editing window **<Card no.>** is opened with an on-screen keyboard.
5. Approximate the card to the transponder card scanner. The balance automatically displays number of detected card in the **<Card no.>** field.
6. Accept recognized number by pressing  key and return to the weighing.





31.5. ADDITIONAL DISPLAY

The balance enables communicating with an additional display using the following ports:

- RS 232 (COM1),
- RS 232 (COM2),
- TCP.

Type of data displayed on an additional display is declared in variable **<Project>**.

Procedure – designing a variable:

1. Enter  **Peripheral devices** parameters of parameters.
2. Press  **Additional display /**  **Project** field, a **<Project>** editing window with an on-screen keyboard is displayed.
3. Use on-screen keyboard to insert desired value of a standard, or
4. Press  key and select desired value of a standard using a list.
5. Press  to confirm.

Caution:

Balance 3Y series cooperates with WD5/3Y additional display manufactured by RADWAG.

Ensuring correct cooperation between the balance and the additional display, requires that the  **Standard** parameter has a variable number set to value **{140}**, and the baud rate value set to 38400 bits/s for a port to which the additional display is plugged.

31.6. AMBIENT CONDITIONS MODULE

3Y series balance enables connecting THB module using ports COM 1 or COM 2. Enter connection address and baud rate of port to which THB module is plugged (specified on module data plate) to ensure correct cooperation between the module and the balance.

31.7. AUTOMATIC FEEDER

(mode not available in balance's standard version)

Balance 3Y series enables cooperation with an automatic feeder using ports:

- RS 232 (COM1),
- RS 232 (COM2),
- Com internal.

Set appropriate address (specified on the data plate of the automatic feeder) of the device to ensure correct cooperation between the feeder and the balance.

32. INPUTS/OUTPUTS

Application of inputs:





The set of inputs is used to control balance's operation. Each of 4 inputs is connectable to the following functions or keys:

- Checkweighing thresholds
- Target value
- Profile
- Adjustment
- Zero
- Tare
- Set tare
- Disable tare
- Restore tare
- Packaging
- Print
- Header printout
- Footer printout
- Universal variable 1 ÷ 5
- Accept
- Abort
- User
- Left door
- Right door
- Parameters
- Statistics
- Add to statistics
- Product
- Warehouse
- Customer
- Parts counting: set part mass
- Parts counting: determine part mass
- Percent weighing: set reference mass
- Percent weighing: set 100%
- Solid density
- Liquid density
- Air density
- Automatic Weight Crane Control
- Task
- Standard

On changing the logic status of the input system, e.g. from [0] to [1], a function that is assigned to the system is carried out. For instance:

- Carrying out automatic adjustment process to check balance's accuracy,
- Displaying the value of set checkweighing thresholds, or
- Restoring tare value to weigh net mass of measured load.

Procedure:

1. Press  key and next press: " **Inputs / Outputs**" key.
2. Enter submenu  **Inputs / Outputs**>, select and press  **Inputs**> key.
3. Enter editing mode of a selected input; list of available functions is displayed.
4. Select a function from displayed list and return to weighing.





Application of outputs:

Outputs are used to SIGNAL the status of measurement result. Change of logic status of the output system, e.g. from [0] to [1], takes place on meeting a requirement assigned to the output. Each of 4 outputs is connectable to the following data:

Available options	Balance status switching output logic
None	-----

Stable	Each stable measurement switches the logic of the system.
MIN stable	Stable measurement below [MIN] threshold switches the logic of the system.
MIN unstable	Unstable measurement below [MIN] threshold switches the logic of the system.
OK stable	Stable measurement within [MIN] [MAX] thresholds switches the logic of the system.
OK unstable	Unstable measurement within [MIN] [MAX] thresholds switches the logic of the system.
MAX stable	Stable measurement below [MAX] threshold switches the logic of the system.
MAX unstable	Unstable measurement below [MAX] threshold switches the logic of the system.
Confirmation of cycle completion	End of procedure.

Procedure:

1. Press  and next press: “ **Inputs / Outputs**” key.
2. Enter < **Inputs / Outputs**> submenu, select and press < **Outputs**> key.
3. Enter editing mode of a selected output; list of available functions is displayed.
4. Select a function from displayed list and return to weighing with saving carried out changes.

33. MISCELLANEOUS



This menu contains global parameters on balance operation, such as: language, date-time, beep sound, display calibration, level control.

Procedure:

1. Press  button.
2. Press < **Miscellaneous**> parameter.

33.1. INTERFACE LANGUAGE

Procedure:

1. Enter < **Miscellaneous**> submenu.
2. Press < **Language**> parameter and select language.

Available languages:

- Polish
- English
- German
- French
- Spanish
- Korean
- Turkish

- Chinese
- Italian
- Czech
- Romanian
- Hungarian
- Russian

33.2. DATE AND TIME SETTING





You can set date, time and their formats. There are two ways to enter date and time settings:

- Press “**Date and time**” field located in the upper bar of the display (in main menu mode),
- Press  key, and select menu: “ **Miscellaneous** /  **Date and Time**”.

Procedure:

1. Enter date and time settings, an on-screen keyboard is displayed.
2. Set date and time in the following order: year, month, day, hour, minute.
3. Press  key to confirm.

 /  **Miscellaneous** /  **Date and time**> submenu contains additional functions for defining date and time format:

Icon	Name	Value	Description
	Time zone	(UTC+01:00) Sarajevo, Skopje, Warsaw, Zagreb	Parameter's setting is: zone/country name, which informs of summer/winter time change. The information comes from Microsoft website.
	Automatically adjust clock for daylight saving time	Yes No	Function enables or disables automatic clock adjustment. On parameter change restart the balance.
	Date and time	2016.04.04 08:00:00	Balance's date and time setting.
	Date format	yyyy.MM.dd *	Selecting date format. Available settings: d.M.yy, d/M/yy, d.M.yyyy, dd.MM.yy, dd/MM/yy, dd-MM-yy, dd.MM.yyyy, dd/MM/yyyy, dd-MMM-yy, dd.MMM.yyyy, M/d/yy, M/d/yyyy, MM/dd/yy, MM/dd/yyyy, yy-M-dd, yy/MM/dd, yy-MM-dd, yyyy-M-dd, yyyy.MM.dd, yyyy-MM-dd.
	Time format	HH:mm:ss **	Selecting time format. Available settings: H.mm.ss, H:mm:ss, H-mm-ss, HH.mm.ss, HH:mm:ss, HH-mm-ss, H.mm.ss tt, H:mm:ss tt, H-mm-ss tt, HH.mm.ss tt, HH:mm:ss tt, HH-mm-ss tt, h.mm.ss tt, h:mm:ss tt, h-mm-ss tt, hh.mm.ss tt, hh:mm:ss tt, hh-mm-ss tt

*) – For date format: y – year, M – month, d – day

**) – For time format: H – hour, m – minute, s – second

<  **Date and time**> parameter allows to preview declared date and time formats.

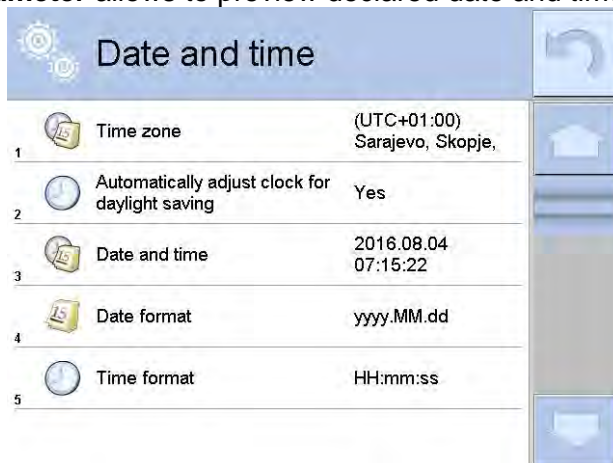



Caution:

<  **Date and time**> parameter can be accessed only by a user with appropriate access level. Access level can be modified by administrator in <Access level> menu.

33.3. 'BEEP' SOUND

Procedure:



1. Enter <  **Miscellaneous**> submenu.
2. Select <  **Beep**> parameter.
3. Set appropriate option.

- | | |
|--------------|---|
| None | - Beep sound inactive for keys and proximity sensors. |
| Keys/Buttons | - Beep sound active for keys/buttons |
| Sensors | - Beep sound active for proximity sensors |
| All | - Beep sound active for keys and proximity sensors |

33.4. VOLUME

You can change volume of the weighing terminal loudspeaker.



Procedure:

1. Press  and next press <  **Miscellaneous/Volume**>; an on-screen keyboard is displayed.
2. Enter volume in percent, 100% - maximum volume, 0% - minimum volume (loudspeaker off).

33.5. DISPLAY SLEEP MODE

You can turn on display sleeping mode.

Procedure:

1. Press  and next press: <  **Miscellaneous / Display sleep mode**>.
2. Select one of the following options: [None; 1; 2; 3; 5; 10; 15]; digit values stand for a number of minutes.
3. On selecting desired value program returns to the previous menu.



Caution:

Display turns to sleep mode only when the balance is not operated (the indication on the screen remains the same). On mass change, or key on an overlay pressing the balance returns to weighing.

33.6. DISPLAY BRIGHTNESS

Display brightness influences balance operation time, when the balance is powered with battery. To lengthen the operation reduce the brightness of the display.



Procedure:

1. Press  and next press:  **Miscellaneous / Display brightness**.
2. Enter desired value [0% - 100%]; display automatically changes brightness and the software returns to the previous menu.

33.7. TOUCH PANEL CALIBRATION

Display calibration is required if the touch panel does not react correctly during operation.

Procedure:

1. Enter submenu  **Miscellaneous**.
2. Select parameter  **Touch panel calibration**, an editing window is displayed.
3. Use finger or a thin (but not sharp edged) and soft stylus to press and hold a display area occupied by a cross. After pressing the fifth cross in order, accept the changes by pressing  key.



Caution:

The process can be aborted by pressing Esc key on an external keyboard connected to the balance's terminal.

33.8. LEVEL CONTROL

3Y series balance features an Automatic Level Control system. In case of non-verified instruments, you can define the operation of Automatic Level Control system. In case of verified instruments, the settings are hidden and the balance operates in accordance with factory settings, i.e. **<Active with lock>**. Weighing process is possible only if balance is properly leveled.

Procedure:

1. Enter  **Miscellaneous** submenu.
2. Select  **Level control** parameter, an editing window is displayed.
3. Select one of available options:
 - None – level indicator is not displayed, the balance does not control level status,
 - Active – level indicator is displayed, the balance alerts level change by changing colour of level indicator (green → level status OK., red → level status lost)
 - Active with lock – level indicator is displayed, the balance alerts level change by changing colour of level indicator (green → level status OK., red → level status lost). If level indicator is red, the display also shows an alert – no Level - , and blocks weighing function until level status is restored.

Caution:

Balance levelling is described in section 15.3 of this user manual.

33.9. SENSORS SENSITIVITY

The parameter is adjustable between 0 – 9, and it determines the distance from which the IR proximity sensors react.

As standard, the sensitivity is set within the range of 5 to 7.



Procedure:

1. Enter  **Miscellaneous** submenu.
2. Select **<Sensors sensitivity>** parameter, an editing window is displayed.
3. Select one of available options. The selection causes immediate returning to the menu window.

33.10. IR SENSORS TIMEOUT

Parameter for setting timeout of proximity sensors expressed in [ms]. The default value is <0>.

When using option of motion recognition you must remember about setting **<IR sensors timeout>** parameter to value **<500ms>**.

Procedure:

1. Go to  **Miscellaneous** submenu.
2. Select **<Proximity sensors delay>** parameter, an on-screen keyboard is displayed.
3. Enter value **<500>**.
4. Confirm. The software returns to menu window.

33.11. AUTOTEST



<AUTOTEST> function is designed to aid you in both assessing balance's operation and diagnosing the reasons for occurrence of errors in weighing which exceed the maximum permissible values for a given balance model.

By means of a simple, repeatable and fully documented way the function enables optimizing balance's settings to maintain the best possible repeatability and weighing time at a workstation. The main purpose of function operation is the possibility of monitoring the above mentioned parameters at optional moment and saving records from carried out tests.

The functions is divided into two modules:

- AUTOTEST FILTER
- AUTOTEST GLP

Before testing the balance controls its level status, temperature and humidity.



AUTOTEST FILTER

It is process of 10 times loading and unloading of the internal weight for all possible settings of balance's filter and value release. The test controls 2 parameters:

- Repeatability;
- Stabilization time of measurement result.

The whole testing process takes approximately 1 hour. On completing the test for all possible settings, balance displays a message with obtained results.

You are given information on optimum balance settings in present ambient conditions. The function provides data on the best possible balance settings for obtaining the highest measurement repeatability and the shortest measurement time with acceptable value of repeatability.

Test results are stored in balance memory until the balance is turned off.

Additionally the function enables:

- Printing test results
- Selecting optimum parameters from the balance's option level.

On completed autotest, a summary with results is displayed. The software automatically informs on filters settings by means of respective icons displayed by the results:



settings providing the fastest measurement (the shortest time interval for measurement performance)



settings providing the most accurate measurement (the lowest possible value of deviation for 10 measurements)



settings providing optimal measurement (the lowest value of time and deviation product)



current settings for filters

Measurement results:

- Filter type
- Setting of **<Value release>** parameter
- Repeatability of indications expressed as standard deviation
- Average time of measurement stabilization

Example:

Autotest Filter		Weight	Time
3	Very fast Reliable	0.0010 g 3.650 s	
4	Fast Fast	0.0005 g 1.536 s	
5	Fast Fast and reliable	0.0005 g 2.038 s	
6	Fast Reliable	0.0004 g 3.181 s	
7	Normal Fast	0.0005 g 2.393 s	
8	Normal Fast and reliable	0.0011 g 2.881 s	
9	Normal Reliable	0.0005 g 4.073 s	

You can quickly modify filters settings and settings for results approval.

Procedure:

1. Select a group of results for particular settings that are to be saved.
2. Press **<Activate>**.

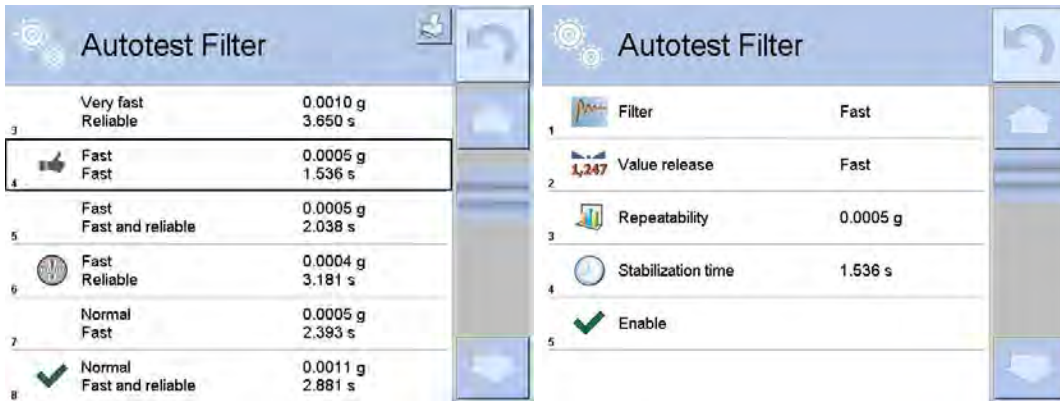

Report template:

----- Autotest Filter: Report -----

Balance type xx 4Y
 Balance ID 442566
 User Hubert
 Software rev. NL1.6.5 S
 Date 2015.05.07
 Time 09:34:48

 Reading unit 0.0001/0.0001 g
 Internal weight mass 148.9390 g
 Temperature: Start 25.26 °C
 Temperature: Stop 25.66 °C

 Filter Very fast
 Value release Fast
 Repeatability 0.0042 g
 Stabilization time 4.505 s

.
 .
 Filter Very slow
 Value release Reliable
 Repeatability 0.0207 g
 Stabilization time 5.015 s
 Signature

Procedure:

1. On function activation, the process is automatically initiated. The display indicates progress of the process course.
2. On completing the process, the software displays a summary and marked values of currently set filter values. The report can be printed.

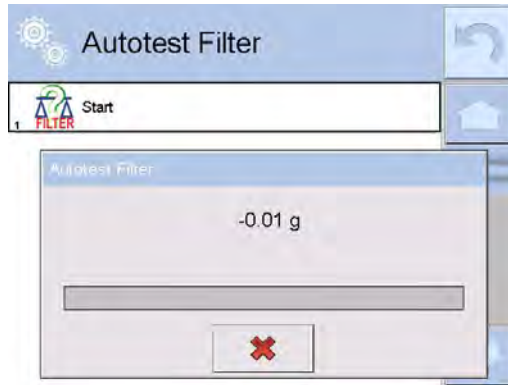

You can abort the process at any moment. To do that press <X> key in the testing window.



AUTOTEST GLP

The test controls repeatability of placing the internal weight and determining error of indication with reference to balance's Max capacity.

Procedure:

1. Two times loading of the internal weight, followed by 10 times loading of the internal weight.
2. Balance internal adjustment.
3. Calculating and storing the value of standard deviation.
4. In balances with automatically opened doors, door opening and closing test is carried out.

Additionally the function enables:

- Displaying and printing a report on available printers
- Saving the report in balance's memory.

The report contains basic data on balance's parameters, ambient conditions and test results.

Test results:

- Deviation for Max.
- Value of repeatability of indication expressed as standard deviation
- Result of door test (positive / negative) – if a balance features automatic door opening system.

Report template:

----- Autotest GLP: Report -----

Balance type xx 4Y
 Balance ID 400010
 User Admin
 Software rev. L0.0.21 S
 Date 2012.01.16
 Time 09:17:16

 Measurements quantity 10
 Reading unit 0.001/0.01 g
 Internal weight 1402.094 g
 mass
 Filter Average
 Value release Fast &
 Reliable

 Deviation for Max. -0.118 g
 Repeatability 0.0088 g
 Signature

Procedure:

1. On pressing a field with test name, the balance displays a message box.
2. On this level, you can carry out the following:
 - Start the following AUTOTEST GLP process,
 - Preview results of completed autotests, and export all saved test results as file with extension *.csv,
 - Delete all saved test results.

You can abort the process at any moment by pressing **<X>** key in the testing window.

Results of carried out autotests are displayed as a table (each line features date and time of autotest procedure and its result).

To preview detailed data of an autotest, press a specified line of the table with test results.

In order to print a result of a single autotest, enter its details (see above) and generate a printout by pressing **<Print>** key located in the upper bar of the balance's display.

Autotest results can be exported by pressing **<Export>** field on the level of all saved reports in a table. Data is sent to a USB flash drive connected to balance's USB port as a file with extension *.csv.

33.12. STARTUP LOGO

(option enabled only for authorized balance operators)

The parameter enables changing a logo that appears on the balance's display on a start-up procedure.

33.13. EXPORT OF SYSTEM EVENTS

(option enabled only for authorized balance operators)

The parameter enables generating a special type of a file that is automatically saved upon option enabling on a USB flash drive plugged to balance's USB port.

The file is used by RADWAG service for diagnosing any potential problems occurring during balance operation.

Procedure:

1. Plug a USB flash drive to balance's USB port.
2. Enter submenu  **<Miscellaneous>**.
3. Select **<Export system events>** parameter.
4. The software generates a file and automatically saves it on the USB flash drive.
5. The generated file has to be sent to RADWAG.

34. UPDATE

The function contains modules which enable updating:

- Help files available from the user level
- Area of a user: APPLICATION
- Metrological parameters: main board (only administrator).

Updating process takes place automatically by loading data from a USB flash drive connected to balance's USB port.

Procedure

1. Prepare a USB flash drive with update file. Required file extension: *.lab2.
2. Connect the USB flash drive to balance's USB port.

3. Select menu **<Application>**.
4. The display previews content saved on the USB flash drive, search for the update file and press its name.
5. Updating process takes place automatically.

The process of updating help files and the main board file takes places analogously to the above described procedure, but the required extension of the update file is: *.hlp - help, *.mbu – main board.

35. ABOUT

This menu contains data on balance specification and installed applications. Most of parameters in this menu are for the information purpose only.

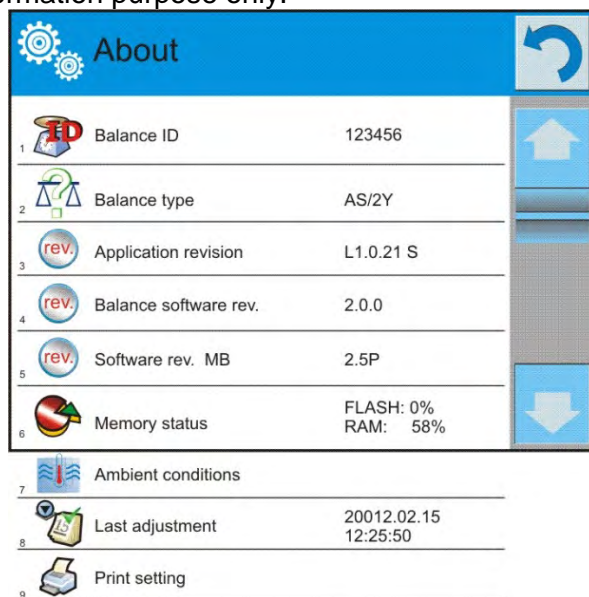

About		
1	Balance ID	123456
2	Balance type	AS/2Y
3	Application revision	L1.0.21 S
4	Balance software rev.	2.0.0
5	Software rev. MB	2.5P
6	Memory status	FLASH: 0% RAM: 58%
7	Ambient conditions	
8	Last adjustment	20012.02.15 12:25:50
9	Print setting	

<Ambient conditions> parameter enables previewing present ambient conditions in a balance: temperature, humidity, pressure (if a balance features corresponding ambient conditions sensors). On selecting parameter **<Print settings>** the balance sends all settings to a printer.

36. MOVIES

Option activating instructional movie explaining how to operate balance functions.

Procedure:

1. Open **<Movies>** parameter group.
2. Select the demanded file and press to watch the movie stored in the balance memory.
3. The software plays *.wmv files.

<Movies> parameter group allows the user with **<Administrator>** access level to add/delete movies from the balance memory. Other users may only watch the movies stored in the balance memory.

To add a movie you have to:



1. Save the movie on a memory stick.
2. Plug the memory stick to balance USB port.
3. Enter **<Movies>** parameter group.
4. Press **<+>** icon located in a top toolbar.
5. Select demanded file.
6. The movie is stored to the balance memory.

To play the movie you have to:

1. Save the movie to the balance memory (see instruction above).
2. Enter **<Movies>** parameter group.
3. Press the name of a movie to be watched.



The movie starts automatically. Functions available for playback are as follows:

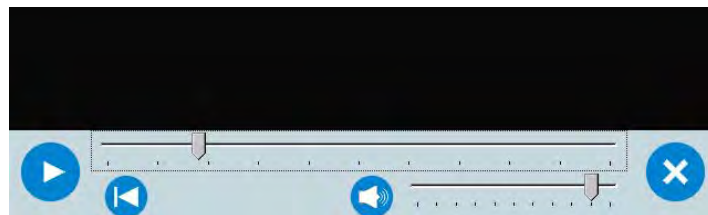

	Play/ Pause playing
	Stop playing
	Increase/decrease the volume (volume power adjusted, for settings go to <MISCELLANEOUS> parameters group).
	Enabling/Disabling the volume
	Restart video

37. COMMUNICATION PROTOCOL

General information

- A. A character based communication protocol balance-terminal is designed for establishing communication between a RADWAG balance and a peripheral device via RS-232C serial interface.
- B. It consists of commands sent from a peripheral device to the balance and responses from the balance.
- C. Responses are sent from the balance on each receipt of a command as a reaction to a specific command.
- D. Commands, forming the communication protocol, enable both, obtaining data on balance status and influencing balance operation, e.g.: acquiring measurement results from the balance, zeroing, etc.

37.1. LIST OF COMMANDS

Command	Command overview
Z	Zero balance
T	Tare balance
OT	Give tare value
UT	Set tare
S	Send stable measurement result in basic measuring unit
SI	Immediately send measurement result in basic measuring unit
SIA	Immediately give results from all platforms in basic measuring units
SU	Send stable measurement result in current measuring unit
SUI	Immediately send measurement result in current measuring unit
C1	Switch on continuous transmission in basic measuring unit
C0	Switch off continuous transmission in basic measuring unit
CU1	Switch on continuous transmission in current measuring unit
CU0	Switch off continuous transmission in current measuring unit
DH	Set min checkweighing threshold
UH	Set max checkweighing threshold
ODH	Give value of min checkweighing threshold
OUH	Give value of max checkweighing threshold
SM	Set mass value of a single item
TV	Set target mass value
RM	Set reference mass value
NB	Give balance serial number
PROFILE	Select balance profile
LOGIN	Operator Logging
LOGOUT	Operator Logout
SS	Value release
IC	Internal adjustment performance

IC1	Disable automatic internal adjustment of the balance
IC0	Enable automatic internal adjustment of the balance
K1	Lock balance keypad
K0	Unlock balance keypad
BP	Activate sound signal
OMI	Give available working modes
OMS	Set working mode
OMG	Give current working mode
PC	Send all implemented commands
BN	Give balance type
FS	Give Max capacity
RV	Give program version
A	Set autozero function
EV	Set ambient conditions state
FIS	Set filter
ARS	Set value release
LDS	Set last digit
UI	Give accessible units
US	Set unit
UG	Give current unit
NT	Cooperation with PUE 7.1, PUE 10 terminal

Caution:
Each command must end with CR LF characters.

37.2. RESPONSE FORMAT

On receipt of a command, the terminal responds as follows:

XX_A CR LF	command understood and in progress
XX_D CR LF	command carried out (appears only after the command XX_A)
XX_I CR LF	command understood but not accessible at this moment
XX_^ CR LF	command understood but max threshold is exceeded
XX_v CR LF	command understood but min threshold is exceeded
XX_OK CR LF	command carried out
ES_CR LF	command not recognised
XX_E CR LF	time limit exceeded while waiting for a stable measurement result (time limit is balance characteristic parameter)

Where:

XX - name of a sent command
_ - spaces

COMMANDS OVERVIEW

Zero balance

Format: **Z CR LF**

Response options:

- Z_A CR LF - command understood and in progress
- Z_D CR LF - command carried out
- Z_A CR LF - command understood and in progress
- Z_^ CR LF - command understood but zeroing range is exceeded
- Z_A CR LF - command understood and in progress
- Z_E CR LF - time limit exceeded while waiting for a stable measurement result
- Z_I CR LF - command understood but not accessible at this moment

Tare balance

Format: **T CR LF**

Response options:

- T_A CR LF - command understood and in progress
- T_D CR LF - command carried out
- T_A CR LF - command understood and in progress
- T_v CR LF - command understood but taring range exceeded
- T_A CR LF - command understood and in progress
- T_E CR LF - time limit exceeded while waiting for stable measurement result
- T_I CR LF - command understood but not accessible at this moment

Give tare value

Format: **OT CR LF**

Response: **OT_TARE CR LF** - command carried out

Response format:

1	2	3	4-12	13	14	15	16	17	18	19
O	T	space	tare	space	unit			space	CR	LF

Tare - 9 characters with right justification

Unit - 3 characters with left justification

CAUTION!

Tare value is always given in calibration unit.

Set tare

Format: **UT_TARE CR LF**, where **TARE** – tare value

Response options:

- UT_OK CR LF - command carried out
- UT_I CR LF - command understood but not accessible at this moment
- ES CR LF - command not recognised (tare format incorrect)

CAUTION!

Use dot in tare format as decimal point.

Send stable measurement result in a basic measuring unit

Format: **S CR LF**

Response options:

S_A CR LF - command understood and in progress
 S_E CR LF - time limit exceeded while waiting for stable measurement result
 S_I CR LF - command understood but not accessible at this moment
 MASS FRAME - response: mass value in a basic measuring unit

Response format:

1	2-3	4	5	6	7-15	16	17	18	19	20	21
S	space	stability marker	space	character	mass	space	unit			C	L
										R	F

An example:

S CR LF - command send form a computer
 S_A CR LF - command understood and in progress
 S _ _ _ _ _ . 8 . 5 _ g _ _ CR LF - command carried out, response: mass value in a basic measuring unit.

where: _ - space

Immediately send measurement result in a basic measuring unit

Format: **SI CR LF**

Response options:

SI_I CR LF - command understood but not accessible at this moment
 MASS FRAME - immediate response: mass value in a basic measuring unit

Response format:

1	2	3	4	5	6	7-15	16	17	18	19	20	21
S	I	space	stability marker	space	character	mass	space	unit			C	L
											R	F

An example:

S I CR LF - command sent from a computer
 S I _ ? _ _ _ _ _ 1 8 . 5 _ k g _ CR LF - command carried out, immediate response: mass value in a basic measuring unit

where: _ - space

Immediately send measurement results from all weighing platforms in basic measuring units

Format: **SIA CR LF**

Accessible responses:

SIA_I CR LF - command understood but not accessible at this moment
 MASS FRAME „P1” CR LF - immediate response of mass value in basic measuring unit from all weighing platforms
 MASS FRAME „P2” CR LF

Frame format with mass from each weighing platform:

1	2	3	4	5	6	7-15	16	17	18	19	20	21
P	n	space	stability marker	space	character	mass	space	unit			C	L
											R	F

Where:

n weighing platform number
mass 9 characters with right justification
unit 3 characters with left justification

An example:

In case there are two weighing platforms.

S I A CR LF - command sent from a computer
 P 1 _ ? _ _ _ _ _ 1 1 8 . 5 _ g _ _ CR LF - command carried out, immediate response

P 2 _ _ _ _ _ 3 6 . 2 _ k g _ C R L F

is mass value from both weighing platforms in basic measuring unit specific for each of the weighing platforms.

Send stable measurement result in a current measuring unit

Format: **SU CR LF**

Response options:

- SU_A CR LF - command understood and in progress
- SU_E CR LF - time limit exceeded while waiting for a stable measurement result
- SU_I CR LF - command understood but not accessible at this moment
- MASS FRAME - response: mass value in a current measuring unit

Response format:

1	2	3	4	5	6	7-15	16	17	18	19	20	21
S	U	space	stability marker	space	character	mass	space	unit			C	L
											R	F

An example:

- S U CR LF - command send form a computer
- S U _ A CR LF - command understood and in progress
- S U _ _ _ - _ _ 1 7 2 . 1 3 5 _ N _ _ CR LF - command carried out, response: mass value in a current measuring unit

where: _ - space

Immediately send measurement result in a current measuring unit

Format: **SUI CR LF**

Response options:

- SUI_I CR LF - command understood but not accessible at this moment
- MASS FRAME - immediate response: mass value in a current measuring unit

Response format:

1	2	3	4	5	6	7-15	16	17	18	19	20	21
S	U	I	stability marker	space	character	mass	space	unit			C	L
											R	F

An example:

- S U I CR LF - command sent from a computer
- S U I ? _ - _ _ _ 5 8 . 2 3 7 _ k g _ CR LF - command carried out, immediate response: mass value in a current measuring unit

where: _ - space

Switch on continuous transmission in a basic measuring unit

Format: **C1 CR LF**

Response options:

- C1_I CR LF - command understood but not accessible at this moment
- C1_A CR LF - command understood and in progress
- MASS FRAME - response: mass value in a basic measuring unit

Response format:

1	2	3	4	5	6	7-15	16	17	18	19	20	21
S	I	space	stability marker	space	character	mass	space	unit			C	L
											R	F

Switch off continuous transmission in a basic measuring unit

Format: **C0 CR LF**

Response options:

- C0_I CR LF - command understood but not accessible at this moment
- C0_A CR LF - command understood and carried out

Switch on continuous transmission in a current measuring unit

Format: **CU1 CR LF**

Response options:

CU1_I CR LF - command understood but not accessible at this moment

CU1_A CR LF - command understood and in progress

MASS FRAME - response: mass value in a current measuring unit

Response format:

1	2	3	4	5	6	7-15	16	17	18	19	20	21
S	U	I	stability marker	space	character	mass	space	unit			CR	LF

Switch off continuous transmission in a current measuring unit

Format: **CU0 CR LF**

Response options:

CU0_I CR LF - command understood but not accessible at this moment

CU0_A CR LF - command understood and carried out

Set min checkweighing threshold

Format: **DH_XXXXX CR LF**, where: _ - space, **XXXXX** – mass format

Response options:

DH_OK CR LF - command carried out

ES CR LF - command not recognised (mass format incorrect)

Set max checkweighing threshold

Format: **UH_XXXXX CR LF**, where: _ - space, **XXXXX** - mass format

Response options:

UH_OK CR LF - command carried out

ES CR LF - command not recognised (mass format incorrect)

Give value of min checkweighing threshold

Format: **ODH CR LF**

Response: **DH_MASA CR LF** - command carried out

Response format:

1	2	3	4-12	13	14	15	16	17	18	19
D	H	space	mass	space	unit			space	CR	LF

Mass - 9 characters with right justification

Unit - 3 characters with left justification

Give value of max checkweighing threshold

Format: **OUH CR LF**

Response: **UH_MASA CR LF** - command carried out

Response format:

1	2	3	4-12	13	14	15	16	17	18	19
U	H	space	mass	space	unit			space	CR	LF

Mass - 9 characters with right justification

Unit - 3 characters with left justification

Set mass value of a single item (only for PARTS COUNTING)

Format: **SM_XXXXX CR LF**, where: _ - space, **XXXXX** – mass format

Response options:

SM_OK CR LF - command carried out

SM_I CR LF - command understood but not accessible at this moment (e.g. mode other than PARTS COUNTING)

ES CR LF - command not recognised (mass format incorrect)

Set target mass value (e.g. for DOSING)

Format: **TV_XXXXX CR LF**, where: _ - space, **XXXXX** - mass format

Response options:

TV_OK CR LF - command carried out
TV_I CR LF - command understood but not accessible at this moment (e.g. mode other than DOSING)
ES CR LF - command not recognised (mass format incorrect)

Set reference mass value (e.g. for DEVIATIONS)

Format: **RM_XXXXX CR LF**, where: _ - space, **XXXXX** – mass format

Accessible responses:

RM_OK CR LF - command carried out
RM_I CR LF - command understood but not accessible at this moment (e.g.: ot working mode, not PERCENT WEIGHING)

ES CR LF - command not recognized (incorrect mass format)

Give balance serial number

Format: **NB CR LF**

Response options:

NB_A_"x" CR LF - command understood, response: serial number
NB_I CR LF - command understood but not accessible at this moment
x – serial number of the device (inserted in between inverted commas)

An example:

Command: NB CR LF – return serial number

Response: NB_A_"1234567" – serial number of the device – "1234567"

Set balance mode

Format: **PROFILE_Name CR LF**

where: _ - space (Name must be accordant with the name form entered in a balance – *lowercase and uppercase letters*)

Response options:

PROFILE OK CR LF - command understood, new PROFILE activated
LOGIN ERROR CR LF - command understood, an error in PROFILE name, log in failed
ES CR LF - command not recognized (error in format)

User log in

Format: **LOGIN Name, Password CR LF** (Name and password have to be inserted as they a set in the balance – small and capital letters)

Response options:

LOGIN OK CR LF - command understood, new user is logged in
LOGIN ERROR CR LF - command understood, an error in name or password occurred, log in failed
ES CR LF - command not recognized (error in format)

User log out

Format: **LOGOUT CR LF**

Response options:

LOGOUT OK CR LF - command understood, user is logged out
ES CR LF - command not recognized (error in format)

Value release

Format: **SS CR LF**

Response options:

SS_OK CR LF - command understood and in progress
Command's function is similar to function of PRINT button located on an overlay,

Internal adjustment

Format: **IC CR LF**

Response options:

IC_A CR LF - command understood and in progress

IC_D CR LF - calibration completed
 IC_A CR LF - command understood and in progress
 IC_E CR LF - time limit exceeded while waiting for a stable measurement result
 IC_I CR LF - command understood but not accessible at this moment

Disable automatic internal adjustment of the balance

Format: IC1 CR LF

Response options:

IC1_I CR LF - command understood but not accessible at this moment
 IC1_E CR LF - operation disabled, e.g. for verified balance
 IC1_OK CR LF - command carried out

Operation is disabled for verified balances.

For non-verified balances the command inhibits internal calibration until it is enabled via IC0 command or until the balance is turned off. The command does not modify settings specifying calibration start.

Enable automatic internal adjustment of the balance

Format: IC0 CR LF

Response options:

IC0_I CR LF - command understood but not accessible at this moment
 IC0_OK CR LF - command carried out

Operation is disabled for verified balances.

Lock balance keypad

Format: K1 CR LF

Response options:

K1_I CR LF - command understood but not accessible at this moment
 K1_OK CR LF - command carried out

Command locks the balance keypad (proximity sensors, touch panel) until the moment of turning the balance off or until sending K0 command

Unlock balance keypad

Format: K0 CR LF

Response options:

K0_I CR LF - command understood but not accessible at this moment
 K0_OK CR LF - command carried out

Activate sound signal

Command overview: command activates BEEP sound signal for a specified amount of time

Format: BP_CZAS CR LF

Response options:

BP_OK CR LF – command carried out, BEEP sound signal activated
 BP_E" CR LF – no parameter or incorrect format
 BP_I CR LF – command understood but not accessible at this moment
TIME -parameter, decimal value specifying how long the sound lasts, parameter given in [ms]. Recommended range <50 - 5000>. If value greater than the permissible high limit is given, than BEEP sound is operated for the maximum permissible amount of time.

An example:

Command: BP_350 CR LF – activate BEEP for 350 ms
 Response: BP_OK CR LF – BEEP activated

CAUTION!

BEEP sound activated via BP command is inhibited if in-course of its activation the sound is activated by means of other device: keypad, touch panel, proximity sensors.

Give available working modes

Command overview: Command returns accessible working modes.

Format: OMI CR LF

Response options:

OMI CR LF

n_ "Nazwa modu" CR LF : – command carried out, response: accessible working modes

OK CR LF

OMI_I CR LF – command understood but not accessible at this moment

Mode name – parameter, working mode name, inserted in between inverted comas. The name takes form given on a particular balance display, it is provided in a currently selected language.

n – parameter, decimal value determining working mode number.

- n →
- 1 – Weighing
 - 2 – Parts Counting
 - 3 – Deviations
 - 4 – Dosing
 - 5 – Formulations
 - 6 – Animal Weighing
 - 8 – Solids Density
 - 9 – Liquids Density
 - 10 – Peak Hold
 - 11 – Totalizing
 - 12 – Checkweighing
 - 13 – Statistics

CAUTION! Working modes numbering is identical for each kind of balance. The numbers are assigned to working modes names. Some balances give only the number as a response.

An example

1:

Command: OMI CR LF – return accessible working modes
Response: OMI CR LF
2_ "Parts counting" CR LF – accessible working modes are given in return:
4_ "Dosing" CR LF mode number + name
12_ "Checkweighing" CR LF
OK CR LF – command carried out

An example 2:

Command: OMI CR LF – return accessible working modes
Response: OMI CR LF
2 CR LF – accessible working modes are given in return:
4 CR LF mode number
12 CR LF
OK CR LF – command carried out

Set working mode

Command overview: Command sets particular working mode.

Format: OMS_n CR LF

Response options:

OMS_OK CR LF – command carried out
OMS_E CR LF – error in-course of command execution, no parameter or incorrect format
OMS_I CR LF – command understood but not accessible at this moment

n – parameter, decimal value determining working mode number. To see detailed description go to OMI command

An example:

Command: OMS_13 CR LF – set Statistics mode
Response: OMS_OK CR LF – Statistics mode set

Give current working mode

Command overview: Command returns currently set working mode.

Format: OMG CR LF

Response options:

OMG_n_OK CR LF – command carried out, response: current working mode
OMG_I CR LF – command understood but not accessible at this moment
n – parameter, decimal value determining working mode number. To see detailed description

go to OMI command.

An example:

Command: OMG CR LF – return current working mode
Response: OMG_13_OK CR LF – balance operates in Statistics working mode

Send all implemented commands

Format: **PC CR LF**

Command: PC CR LF - send all implemented commands
Response: PC_A_"Z,T,S,SI..." - command carried out, the terminal displays all implemented commands.

Give balance type

Format: **BN CR LF**

Response options:

BN_A_"x" CR LF - command understood, response: balance type
BN_I CR LF - command understood but not accessible at this moment
x – series of types for a particular balance (in between inverted commas), with general balance type in front

An example:

Command: BN CR LF – return balance type
Response: BN_A_"PM" – balance type: "PM 4Y"

Give max capacity

Format: **FS CR LF**

Response options:

FS_A_"x" CR LF - command understood, response: balance type
FS_I CR LF - command understood but not accessible at this moment
x – Max value of reading units (in between inverted commas)

An example:

Command: FS CR LF – return balance type
Response: BN_A_"220.0000" – Max capacity 220 g

Give program version

Format: **RV CR LF**

Response options:

RV_A_"x" CR LF - command understood, response: program version
RV_I CR LF - command understood but not accessible at this moment
x – program version (in between inverted commas)

An example:

Command: RV CR LF – return program version
Response: RV_A_" 1.1.1" – program version: "1.1.1"

Set AUTOZERO function

Format: **A_n CR LF**

Response options:

A_OK CR LF – command carried out
A_E CR LF – error in-course of command execution, no parameter or incorrect format
A_I CR LF – command understood but not accessible at this moment
n – parameter, decimal value determining autozero settings
n → 0 – autozero off
 1 – autozero on

CAUTION!

Command changes settings for a current working mode.

An example:

Command: A_1 CR LF – turn autozero function on
Response: A_OK CR LF – autozero function is on
AUTOZERO function operates until it is turned off by A 0 command.

Set ambient conditions state

Format: **EV_n CR LF**

Response options:

EV_OK CR LF – command carried out
 EV_E CR LF – error in-course of command execution, no parameter or incorrect format
 EV_I CR LF – command understood but not accessible at this moment
n – parameter, decimal value determining ambient conditions state
 n → 0 – unstable ambient conditions
 1 – stable ambient conditions

CAUTION!

Command changes settings for a current working mode.

An example:

Command: EV_1 CR LF – set value ‘stable’ for ambient conditions option
 Response: EV_OK CR LF – ambient conditions option set to value ‘stable’
 <AMBIENT CONDITIONS> parameter is set to value <STABLE> until command EV 0 swaps it to value <UNSTABLE>.

Set filter

Format: FIS_n CR LF

Response options:

FIS_OK CR LF – command carried out
 FIS_E CR LF – error in-course of command execution, no parameter or incorrect format
 FIS_I CR LF – command understood but not accessible at this moment
n – parameter, decimal value determining filter number
 n → 1 – very fast
 2 – fast
 3 – average
 4 – slow
 5 – very slow

CAUTION!

The numbering is assigned to a particular filter name and it is identical for all balance types.

The command changes settings for a current working mode if, for a particular balance type, filter settings are assigned to the working mode.

An example:

Command: FIS_3 CR LF – set average filter
 Response: FIS_OK CR LF – average filter set

Set Value release

Format: ARS_n CR LF

Response options:

ARS_OK CR LF – command carried out
 ARS_E CR LF – error in-course of command execution, no parameter or incorrect format
 ARS_I CR LF – command understood but not accessible at this moment
n – parameter, decimal value determining value release options
 n → 1 – fast
 2 – fast+reliable
 3 – reliable

CAUTION!

The numbering is assigned to a particular value release option and it is identical for all balance types.

The command changes settings for a current working mode if, for a particular balance type, value release settings are assigned to the working mode.

An example:

Command: ARS_2 CR LF – set value release parameter to fast+reliable option
 Response: ARS_OK CR LF – fast+reliable option set

Set last digit

Format: LDS_n CR LF

Response options:

LDS_OK CR LF – command carried out
 LDS_E CR LF – error in-course of command execution, no parameter or incorrect format
 LDS_I CR LF – command understood but not accessible at this moment
 n – parameter, decimal value determining last digit settings
 n → 1 – always
 2 – never
 3 – when stable

CAUTION!

The numbering is assigned to a particular last digit option and it is identical for all balance types. The command changes settings for a current working mode if, for a particular balance type, last digit settings are assigned to the working mode.

An example:

Command: LDS_1 CR LF – set last digit option to value ‘always’
 Response: LDS_OK CR LF – ‘always’ value set

Give accessible units

Command overview: Command returns units available for a particular device and for a current working mode.

Format: UI CR LF

Response options:

UI_”x₁,x₂, ... x_n”_OK CR LF – command carried out, returns accessible units
 UI_I CR LF – command understood but not accessible at this moment

x – unit symbols, separated by means of comas

x → g, mg, ct, lb, oz, ozt, dwt, tlh, tls, tlt, tlc, mom, gr, ti, N, baht, tola, u1, u2

An example:

Command: UI CR LF – return available units
 Response: UI_”g, mg, ct”_OK CR LF – response: available units

Set current unit

Command overview: Command sets current unit for a particular device.

Format: US_x CR LF

Response options:

US_x_OK <CR><LF> – command carried out, response: current unit
 US_E CR LF –error in-course of command execution, no parameter or incorrect format
 US_I CR LF – command understood but not accessible at this moment

x – parameter, units symbols: g, mg, ct, lb, oz, ozt, dwt, tlh, tls, tlt, tlc, mom, gr, ti, N, baht, tola, msg, u1, u2, next

CAUTION! if x=next, the command swaps to another available unit on the list (it simulates „unit” button pressing).

An example:

Command: US_mg CR LF – set „mg” unit
 Response: US_mg_OK CR LF – „mg” set as a current unit

Give current unit

Command overview: command returns current unit.

Format: UG CR LF

Response options:

UG_x_OK CR LF – command carried out, response: current unit
 UG_I CR LF – command understood but not accessible at this moment

x – parameter, unit symbol

An example:

Command: UG CR LF – return current unit
 Response: UG_ct_OK CR LF – currently set unit is „ct”

Cooperation with PUE 7.1, PUE 10 terminal

Format: NT CR LF

Response options:

ES CR LF - command not understood (format error)
 MASS FRAME - response: mass value in a basic measuring unit

Response format:

1	2	3	4	5	6	7	8	9-18	19	20-22	23	24-32	33	34-36	37	38	39	40
N	T	space	stability marker	zero marker	range marker	digit marker	space	mass	space	mass unit	space	tare	space	tare unit	space	Hidden digits quantity	CR	LF

NT - command
 Stability marker - [space] if stable, [?] if unstable
 Zero marker - [space] for any value but zero, [Z] for zero value
 Range marker - marker informing on range within which mass value is comprised: [space] I range balance, [2] II balance, [3] III balance
 Digit marker - [zero] no digit, [1] one digit marker, [2] two digits marker, [3] three digits marker, [4] four digits marker, [5] five digits marker
 Mass -10 characters for net mass given in adjustment unit (with dot and a floating-point "-" sign)
 Mass unit -3 characters - left justification
 Tare -9 characters with dot - right justification (when floating-point tare gets turned off automatically then zero value is sent)
 Tare unit -3 characters - left justification
 Hidden digits quantity -Number specifying quantity of hidden digits: [space] when no digits are hidden, [1] when 1 digit is hidden

An example:

NT CR LF - command sent from a computer
 N T _ ? _ _ 0 _ _ _ _ _ - 5 . 1 1 3 _ g _ - command carried out, response: mass value and remaining data
 _ _ _ _ _ 0 . 0 0 0 _ g _ _ _ 0 CR LF

Where: _ - space

37.3. MANUAL PRINTOUT/AUTOMATIC PRINTOUT

3Y series balance enables generating manual or automatic printouts:

- Manual printout: press  key on stabilization of indication (measurement result).
- Automatic printout is generated automatically, in accordance to the settings of automatic printout (see section 14.5 of this user manual).

The content of a printout depends on setting in menu <Standard printout> - <Weighing printout template>(see section 14.5 of this user manual).

Format of mass printout:

1	2	3	4 -12	13	14	15	16	17	18
stability marker	space	character	mass	space	unit		CR	LF	

Stability marker [space] if stable
 [?] if unstable
 [!] if air buoyancy compensation mode is enabled
 [^] if error of exceeding range to + occurs
 [v] if error of exceeding range to – occurs
 Character [space] for positive values
 [-] for negative values
 Mass 9 characters with decimal point and right justification

Unit

3 characters with left justification

Example:

____ 1 8 3 2 . 0 _ g _ _ CR LF – a printout generated from a balance on pressing key, according to settings of <Weighing printout template>



N (measurements quantity)	NO	Universal variable 1 ... 5	NO
Date	NO	Net	NO
Time	NO	Tare	NO
Level status	NO	Gross	NO
Customer	NO	Current result	NO
Warehouse	NO	Supplementary unit	NO
Product	NO	Mass	YES
Packaging	NO	Non-standard printout	NO

38. CONNECTING PERIPHERALS

Y series balances can cooperate with the following peripheral devices:

- Computer,
- Receipt printer: KAFKA, EPSON,
- PCL printer,
- Additional display,
- Barcode scanner,
- An optional peripheral device operating in communication protocol ASCII.

39. ERROR MESSAGES

- Err2** Value beyond zero range
- Err3** Value beyond tare range
- Err8** Taring / Zeroing operation time exceeded
- NULL-** Zero value from converter
- FULL-** Measurement range (Max. capacity) exceeded
- LH-** Start mass error
- no level-** not levelled balance
- Err 100-** weighing module restart
- In process** in-course process resulting in unstable measurement (automatic feeder – pills feeding process or comparator – load change process)
- HI** display range overflow

40. ADDITIONAL EQUIPMENT

Type	Name
P0136	RS232 cable for KAFKA printer
P0151	RS232 cable for EPSON printer
KAFKA	Thermal printer

EPSON	Dot matrix printer
	PCL printer
WD- xx	Additional display in plastic housing
CK-01	Transponder card scanner
LS2208	Barcode scanner
AP2-1	Power loop output
SAL	Anti-vibration bench for laboratory balances
	PC keyboard

Computer software:

- „LABEL EDITOR”,
- „PW-WIN”,
- „RAD-KEY”.

41. APPENDIX A – VARIABLES FOR PRINTOUTS

41.1. LIST OF VARIABLES

Caution:

Each of defined variables must be contained in braces:

{x}, where x – stands for variable number.

List of variables is accessible in the system for defining the look of standard printout templates and data displayed in the grey workspace:

Symbol	Variable description
{0}	Standard printout in adjustment unit
{1}	Standard printout in current measuring unit
{2}	Date
{3}	Time
{4}	Date and time
{5}	Working modes
{6}	Net mass in current measuring unit
{7}	Net mass is adjustment unit
{8}	Gross mass
{9}	Tare
{10}	Current measuring unit
{11}	Adjustment unit
{12}	Low threshold
{13}	High threshold
{15}	Statistics: Number

{16}	Statistics: Sum
{17}	Statistics: Mean
{18}	Statistics: Minimum
{19}	Statistics: Maximum
{20}	Statistics: SDV
{21}	Statistics: D
{22}	Statistics: RDV

{26}	Indication control
{27}	Value
{28}	Level status
{30}	Gross value
{31}	Weighing platform no.
{32}	Factory no.
{33}	Balance reading unit
{34}	Range
{35}	Parts counting: Mass of a standard
{36}	Percent Weighing: Reference mass
{38}	Universal variable: Name
{39}	Universal variable: Value
{43}	Net mass in supplementary unit
{44}	Supplementary unit
{45}	Target value
{46}	Tolerance
{47}	Difference
{48}	Balance type
{50}	Product: Name
{51}	Product: Code
{52}	Product: EAN code
{53}	Product: Mass
{54}	Product: Tare
{55}	Product: Price
{56}	Product: Minimum

{57}	Product: Maximum
{58} ²⁾	Product: PGC mode
{59}	Product: Shelf-life time in days
{60}	Product: VAT
{61}	Product: Date
{62}	Product: Shelf-life time
{63}	Product: Density
{64}	Product: Ingredients
{65}	Product: Description
{66}	Product: Tolerance
{75}	User: Name
{76}	User: Code
{77}	User: Access level
{80}	Packaging: Name
{81}	Packaging: Code
{82}	Packaging: Mass
{85}	Customer: Name
{86}	Customer: Code
{87}	Customer: VAT no.
{88}	Customer: Address
{89}	Customer: Postal code
{90}	Customer: City
{91}	Customer: Discount
{100} ²⁾	PGC Report: Batch number
{101} ²⁾	PGC Report: Start date
{102} ²⁾	PGC Report: End date
{103} ²⁾	PGC Report: Result
{104} ²⁾	PGC Report: Batch quantity
{105} ²⁾	PGC Report: Measurements quantity
{106} ²⁾	PGC Report: Value of T1 error
{107} ²⁾	PGC Report: Value of 2T1 error
{108} ²⁾	PGC Report: Number of T1 errors
{109} ²⁾	PGC Report: Permissible number of T1 errors

{110} ²⁾	PGC Report: Number of 2T1 errors
{111} ²⁾	PGC Report: Sum
{112} ²⁾	PGC Report: Min
{113} ²⁾	PGC Report: Max
{114} ²⁾	PGC Report: Average
{115} ²⁾	PGC Report: Average limit
{116} ²⁾	PGC Report: Standard deviation
{117} ²⁾	PGC Report: Measurements
{118} ²⁾	PGC Report: Unit
{119} ²⁾	PGC Report: Report no.
{120} ²⁾	Average Tare Report: Date
{121} ²⁾	Average Tare Report: Result
{122} ²⁾	Average Tare Report: Standard deviation
{123} ²⁾	Average Tare Report: 0,25T1
{124} ²⁾	Average Tare Report: Measurements quantity
{125} ²⁾	Average Tare Report: Measurements
{126} ²⁾	Average Tare Report: Report no.
{130}	Warehouse: Name
{131}	Warehouse: Code
{132}	Warehouse: Description
{141}	Additional display: WD
{142}	Additional display: WWG
{143}	Hex
{144}	Hex UTF-8
{146}	Gross mass in current measuring unit
{147}	Tare in current measuring unit
{150}	Epson printer: Paper cut
{151}	PCL printer: Page offset
{155}	Cooperation with RADWAG CONNECT software
{165}	Formulation: Name
{166}	Formulation: Code

{167}	Formulation: Number of ingredients
{168}	Formulation: Sum
{169}	Formulation: Ingredient
{170}	Formulation: Ingredient no.
{175}	Report on formulation: Start date
{176}	Report on formulation: End date
{177}	Report on formulation: Sum
{178}	Report on formulation: Target value
{179}	Report on formulation: Difference
{180}	Report on formulation: Measurements quantity
{181}	Report on formulation: Status
{182}	Report on formulation: Measurements
{188}	Ingredient: Target mass
{189}	Ingredient: Difference
{190} ²⁾	Comparator: Report no.
{191} ²⁾	Comparator: Start date
{192} ²⁾	Comparator: End date
{193} ²⁾	Comparator: Order no.
{194} ²⁾	Comparator: Tested standard no.
{195} ²⁾	Comparator: Difference
{196} ²⁾	Comparator: List of Measurements
{197} ²⁾	Comparator: Mean difference
{198} ²⁾	Comparator: Standard deviation
{199} ²⁾	Comparator: Number of cycles
{200} ²⁾	Comparator: Method
{201} ²⁾	Comparator: Min temperature
{202} ²⁾	Comparator: Max temperature
{203} ²⁾	Comparator: Min Humidity
{204} ²⁾	Comparator: Max Humidity
{205} ²⁾	Comparator: Min Pressure
{206} ²⁾	Comparator: Max Pressure
{207} ²⁾	Comparator: Task
{208} ²⁾	Comparator: Selected Task

{209} ²⁾	Comparator: Measurements
{210}	Adjustment history: Type of adjustment
{211}	Adjustment history: Nominal mass
{212}	Adjustment history: Current mass
{213}	Adjustment history: Difference
{214}	Adjustment history: Temperature
{215}	Adjustment history: Level status
{216}	Adjustment history: Weighing platform no.
{219}	Adjustment history: Date and time of recently performed adjustment
{220} ²⁾	Mass control: Start date
{221} ²⁾	Mass control: End date
{222} ²⁾	Mass control: Batch no.
{223} ²⁾	Mass control: Average
{224} ²⁾	Mass control: Standard deviation
{225} ²⁾	Mass control: Standard quantity
{226} ²⁾	Mass control: Measurements
{227} ²⁾	Mass control: Report no.
{228} ²⁾	Mass control: Number of T2M error
{229} ²⁾	Mass control: Number of T1M error
{230} ²⁾	Mass control: Number of T1P error
{231} ²⁾	Mass control: Number of T2P error
{232} ²⁾	Mass control: T2- threshold
{233} ²⁾	Mass control: T1- threshold
{234} ²⁾	Mass control: T1+ threshold
{235} ²⁾	Mass control: T2+ threshold
{236} ²⁾	Mass control: T2- threshold value
{237} ²⁾	Mass control: T1- threshold value
{238} ²⁾	Mass control: T1+ threshold value
{239} ²⁾	Mass control: T2+ threshold value
{240} ²⁾	Mass control: Average in percent (DX)
{241} ²⁾	Mass control: Standard deviation in percent
{250}	Density: Start date
{251}	Density: End date

{252}	Density: Procedure
{253}	Density: Standard liquid
{254}	Density of standard liquid
{255}	Density: Temperature if standard liquid
{256}	Density: Plunger volume
{257}	Density: Density determined
{258}	Density: Unit
{259}	Density: Sample no.
{260}	Density: Weighing 1
{261}	Density: Weighing 2
{263}	Density: Volume
{266}	Density: Mass of steel standard
{267}	Density: Mass of aluminum standard
{268}	Density: Density of steel standard
{269}	Density: Density of aluminum standard
{275}	Ambient conditions report: Date and time
{276}	Ambient conditions report: Temperature THB
{277}	Ambient conditions report: Humidity THB
{278}	Ambient conditions report: Temperature 1
{279}	Ambient conditions report: Temperature 2
{280}	Ambient conditions report: Pressure THB
{281}	Ambient conditions report: Air density
{282}	Ambient conditions report: Humidity
{283}	Ambient conditions report: Pressure
{285} ²⁾	Mass Comparator: (Reference) Standards: Name
{286} ²⁾	Mass Comparator: (Reference) Standards: Code
{287} ²⁾	Mass Comparator: (Reference) Standards: Class
{288} ²⁾	Mass Comparator: (Reference) Standards: Factory no.
{289} ²⁾	Mass Comparator: (Reference) Standards: Mass
{290} ²⁾	Mass Comparator: (Reference) Standards: Set no.
{295}	Animal weighing: Threshold
{296}	Animal weighing: Averaging time
{300} ²⁾	Tasks: Name

{301} ²⁾	Tasks: Code
{302} ²⁾	Tasks: Class
{303} ²⁾	Tasks: Mass
{304} ²⁾	Tasks: Order no.
{305} ²⁾	Tasks: Tested standard no.
{310}	Pipettes: Name
{311}	Pipettes: Code
{312}	Pipettes: Model
{313}	Pipettes Tips
{314}	Pipettes: Nominal volume
{315}	Pipettes: Minimal volume
{316}	Pipettes: Number of channels
{317}	Pipettes: Type
{318}	Pipettes: Type of volume
{319}	Pipettes: Tested volumes
{350}	Lot: Name
{351}	Lot: Code
{352}	Lot: Samples
{353}	Lot: Number of samples
{355}	Sample: Name
{356}	Sample: Status
{357}	Sample: Tare
{358}	Sample: Temperature
{359}	Sample: Humidity
{360}	Sample: Pressure
{361}	Sample no.
{365}	Weighing B: Interval
{366}	Weighing B: Difference
{367}	Weighing B: Difference %
{368}	Weighing B: Residue %
{369}	Weighing B: Number

{375}	Differential weighing: Method
{380} ²⁾	Drying program: Name
{381} ²⁾	Drying program: Code
{385} ²⁾	Drying mode
{386} ²⁾	Drying mode parameters
{387} ²⁾	Finish mode
{388} ²⁾	Finish mode parameters
{389} ²⁾	Drying report: Unit
{390} ²⁾	Drying report: Printout interval
{395} ²⁾	Moisture analyzer: Set temperature
{396} ²⁾	Moisture analyzer: Current temperature
{397} ²⁾	Moisture analyzer: Drying time
{398} ²⁾	Moisture analyzer: Status
{399} ²⁾	Moisture analyzer: Drying time and result
{400} ²⁾	Moisture analyzer: Humidity content
{401} ²⁾	Moisture analyzer: Dry content
{402} ²⁾	Moisture analyzer: Humid/Dry ratio
{403} ²⁾	Moisture analyzer: Heating source test – Power [%]
{405}	SQC: Batch no.
{406}	SQC: Start date
{407}	SQC: End date
{408}	SQC: Batch quantity
{440}	Minimum sample weight: Name
{441}	Minimum sample weight: Reference tare
{442}	Minimum sample weight
{443}	Minimum sample weight: Status

2) Variables are not operated by software version: “**Standard**”.

41.2. VARIABLES FORMATTING

You can randomly format numerical variables, text variables and date which are dedicated for printing, and which are displayed in the grey workspace of the display.

Formatting types:

- Variables with left justification,
- Variables with right justification,
- Determining number of characters for printing / displaying,
- Determining number of decimal places for numerical variables,
- Converting the format of date and hour,
- Converting numerical variables into a code type EAN13,
- Converting numerical variables and date into a code type EAN128.

Special formatting signs:

Sign	Description	Example
,	Sign separating variables for formatting	{7,10} – Net mass in adjustment unit with constant length of 10 characters, with right justification
-	Minus sign or left justification	{7,-10} – Net mass in adjustment unit with constant length of 10 characters, with left justification
:	Sign proceeding formatting or time separator (i.e. hours, minutes and seconds)	{7:0.000} – Net mass in adjustment unit always with three decimal places; {3:hh:mm:ss} – Current time in format: hour : minute : second
.	First detected dot in a digit is recognized as separator of integer and decimal parts. Each following dot is ignored.	{55:0.00} – Product’s unit price always with two decimal places; {17:0.0000} – Average from measurements, always with four decimal places;
F	Sign formatting digits to a chain of sign in format “-ddd.ddd...” (where: d stands for a single digit, minus is for digits with negative value only) or determining number of decimal places	{7:F2} – Net mass in adjustment unit always with two decimal places; {7,9:F2} – Net mass in adjustment unit always with two decimal places and fixed length of 9 characters with right justification;
V	Formatting mass and quantities derivatives of mass in EAN13 code	{7:V6.3} – Net mass in a form of EAN13 code (6-character code) with three decimal places
T	Formatting mass and quantities derivatives of mass in EAN128 code	{7:T6.3} – Net mass in a form of EAN128 code with three decimal places;
/	Date separator between days, months and years	{2:yy/MM/dd} – Current date in format: year - month - day, where yy stand for two less meaningful characters of a year;
\	Sign “escape” deleting a formatting function from the following sign, so that it is recognized as text	{2:yy\MM\dd} – Current date in format: year / month / day; {2:yy\:MM\:dd} – Current date in format: year : month : day. Should “\” be used in literal meaning, insert: \\;



























Application list of formatted variables:

CODE	DESCRIPTION
{7:V6.3}	Net mass in EAN 13 code (6-character code)

{7:V7.3}	Net mass in EAN 13 code (7-character code)
{27:V6.3}	Net value in EAN 13 code (6-character code)
{27:V7.3}	Net value in EAN 13 code (7-character code)
{7:T6.3}	Net mass in EAN 128 code
{8:T6.3}	Gross mass in EAN 128 code
{55:T6.2}	Product price in EAN 128 code
{2:yyMMdd}	Data in EAN 128 code
{61:yyMMdd}	Product data in EAN 128 code
{62:yyMMdd}	Product's shelf-life time in EAN 128 code

42. APPENDIX B – PROGRAMMABLE BUTTONS LIST

Ikona	Nazwa funkcji	Ikona	Nazwa funkcji
	Profiles		Right door opening/closing
	Adjustment		Open/Close door
	Zero		Parameters
	Tare		Products
	Set tare		Warehouses
	Disable tare		Customers
	Enable tare		Help
	Packages		Parts counting: determine part
	Print		Parts counting: set part mass
	Header printout		Parts counting: determine mass using 5 parts
	Footer printout		Parts counting: determine mass using 10 parts

	Units		Parts counting: determine mass using 20 parts
	Universal variable 1		Parts counting: determine mass using 50 parts
	Universal variable 2		Parts counting: determine mass using 100 parts
	Universal variable 3		Parts counting: assign standard to product
	Universal variable 4		Pipettes
	Universal variable 5		Differential weighing: Series
	Checkweighing thresholds		Differential weighing: Sample
	Statistics		Differential weighing: Tare
	Add to statistics		Differential weighing: Weighing A
	Target value		Differential weighing: Weighing B
	Percent weighing: give reference mass		Differential weighing: Weighing T + A
	Percent weighing: set 100%		Differential weighing: Delete value
	Density: solid density		Differential weighing: Copy tare
	Density: liquid density		Differential weighing: Add sample
	Density: air density		Moisture analyzer: drying mode
	Animal weighing		Moisture analyzer: measurements chart
	Formulation		Moisture analyzer: sample description

	Formulation with multiplier		Prepacked Goods Controls: Show additional information
	Formulation with target mass		Prepacked Goods Controls: Measurements chart
	Formulation using out of database ingredients		Default working mode
	Skip ingredient		User
	Accept		Left door opening/closing
	Abort		

43. APPENDIX D- SETTINGS OF ZEBRA PRINTERS

Baud rate 9600b/sec
Parity control none
Bits 8bit
Stop bits 1 bit

Data on a printout from a printer regarding RS 232:

Serial port : **96, N, 8, 1**

Means of activating an information (test) printout and carrying out changes in printer's settings is specified in a user manual of ZEBRA printers.

44. APPENDIX E – COMMUNICATION WITH BARCODE SCANNER

1. For communication with barcode scanners RADWAG balances 3Y series use RS232 interfaces and simplex transmission (one direction) without handshaking. Only two wires are required for assuring such a transmission. Therefore, used scanners have to be equipped with such interface with disabled both hardware and software handshaking.
2. Both balances and scanners have the possibility of setting of transmission parameters. Both devices are required to have the same parameters set : baud rate, number of data bits, parity control, stop bits. e.g. 9600,8,N,1 – baud rate 9600 bit/s , data 8-bits, no parity control, 1 stop bit.
3. Barcode scanners can send additional information apart from the expected barcode e.g. type of barcode. It is advisable to disable such information because RADWAG devices and software do not use it.
4. Some RADWAG systems can omit unnecessary information by using parameters that mark the beginning and the length of the code required to analyse.

5. Should a barcode be recognized by a balance, it needs to have some particular features. A code requires programming a characteristics prefix and suffix. In a standard accepted by RADWAG, a prefix is a sign (byte) 01 hexadecimal and a suffix is a sign (byte) 0D hexadecimal.
6. Most barcode scanners allow to enable/disable different barcode types.
7. Programming of scanners is usually performed by scanning special barcodes or by using an external software tool.

Barcode with required prefix and suffix in hexadecimal format	Barcode without required -fixes in ASCII format	Code type
01 30 30 32 31 30 31 32 36 0D	00210126	EAN-8
01 30 31 32 33 34 35 36 37 38 39 0D	0123456789	KOD 2 Z 5
01 43 4F 44 45 20 33 39 20 54 45 53 54 0D	CODE 39 TEST	CODE 39
01 31 31 30 31 32 33 34 35 36 37 38 39 31 0D	1101234567891	EAN-13
01 43 6F 64 65 20 31 32 38 20 54 65 73 74 0D	CODE 128 Test	CODE 128

45. APPENDIX F – MENU STRUCTURE

User adjustment

Description	Value
Internal adjustment	Function
External adjustment	Function
User adjustment	Function
Adjustment test	Function
Automatic adjustment time	1 - 12
Report printout	No / Yes
GLP Project . . →→	

Name	Setting
» Adjustment	No / Yes
» Working mode	No / Yes
» Date	No / Yes
» Time	No / Yes
» User	No / Yes
» Balance type	No / Yes
» Balance ID	No / Yes
» Level status	No / Yes
» Nominal mass	No / Yes

	» Difference	No / Yes
	» Temperature	No / Yes
	» Current mass	No / Yes
	» Empty line	No / Yes
	» Dashes	No / Yes
	» Signature	No / Yes
	» Non-standard printout	No / Yes
Adjustment history	Displays a report on completed external adjustments	

Databases

- Products
- Weighing records
- Customers
- Formulation
- Formulations reports
- Density reports
- Controls
- Average tares
- Pipettes
- Pipette calibration reports
- Series
- Ambient conditions
- Packages
- Warehouses
- Printouts
- Universal variables
- Delete data older than
- Export database of weighing records to file

Communication

Description	Value
COM 1	-
» Baud rate	9600
» Data bits	8
» Stop bits	1
» Parity	No
COM 2	-
» Baud rate	9600
» Data bits	8
» Stop bits	1
» Parity	No

Ethernet	-
» DHCP	No
» IP address	192.168.0.2
» Subnet mask	255.255.255.0
» Default gate	192.168.0.1
Tcp	-
Port	4001

Peripherals

Description	Value
Computer	-
» Port	COM 1
» Address	1
» Continuous transmission	No / Yes
» Printout template	Settings
» E2R System	Settings
Printer	
» Port	COM 2
» Code page	1250
» Printouts	Settings
Barcode scanner	
» Port	None / COM 1/ COM 2
» Offset	0
» Code length	0
Transponder card scanner	
Port	None / COM 1/ COM 2
Additional display	
Port	None / COM 1-2 / Tcp
Project	Settings
Ambient conditions module	
Port	None / COM 1-2 / Com internal
Address	3

Inputs / Outputs

Description	Value
-------------	-------

Inputs		
	» Input 1	Selection
	» Input 2	Selection
	» Input 3	Selection
	» Input 4	Selection
Outputs		
	» Output 1	Selection
	» Output 2	Selection
	» Output 3	Selection
	» Output 4	Selection

Access level

Description	Value
Anonymous user	
» Guest	Selection
» User	Selection
» Advanced user	Selection
» Administrator	Selection
Date and time	
» Guest	Selection
» User	Selection
» Advanced user	Selection
» Administrator	Selection
Printouts	
» Guest	Selection
» User	Selection
» Advanced user	Selection
» Administrator	Selection
Databases	
Products	Selection: - Guest - User - Advanced user - Administrator
Customers	
Formulation	
Packages	
Warehouses	
Printouts	

Delete data older than

Miscellaneous

Description	Value
Language	Selection
Date and time	Settings
Beep	Selection
Touch panel calibration	Function
Level control	Selection
Autotest	Selection

User manual no.:
IMMU-24-03-05-18-EN



RADWAG BALANCES AND SCALES
ADVANCED WEIGHING TECHNOLOGIES

