



**RADWAG BALANCES AND SCALES**  
ADVANCED WEIGHING TECHNOLOGIES

IMMB-13-01-09-20-EN

Start up Guide

# Microwave Moisture Analyzer

---

- PMV

To view a complete User Manual go to the website or scan QR code:



[radwag.com/en/manuals/13807](http://radwag.com/en/manuals/13807)

# 1. CONTENT

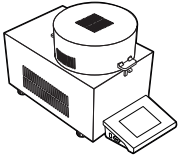

Moisture analyzer  
x1



Disposable pan  
x10



Cross-shaped  
holder  
x1



Power cord\*  
x1

*\*The plug type may vary by country.*

# 2. UNPACKING

1

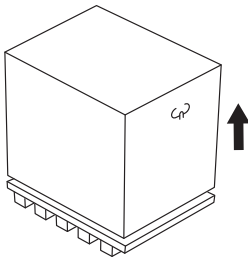

2

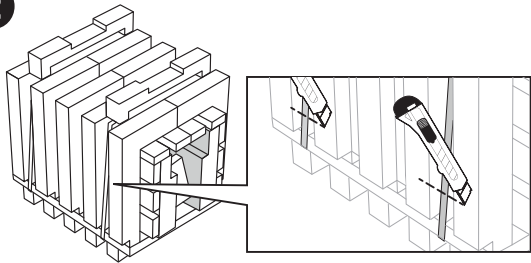

4

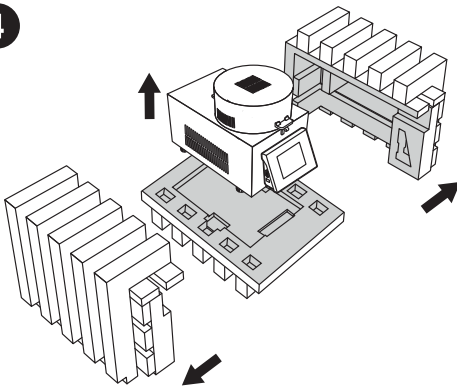

Keep the packaging should a warranty claim or service be required.

### 3. RECOMMENDATIONS AND WARNINGS

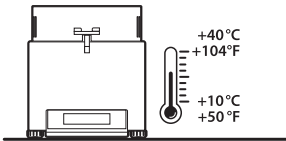

Operate the device in a room where the temperature ranges between 10–40 °C (50–104 °F) and where the relative humidity is below 80%.

Place the moisture analyzer on a solid surface to ensure stability. To obtain stable and repeatable weighing results, an anti-vibration table is recommended.

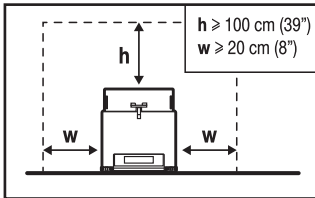

Keep free space around the device:  
 $h = \text{min. } 100 \text{ cm (39 in.)}$ ,  
 $w = \text{min. } 20 \text{ cm (8 in.)}$ .

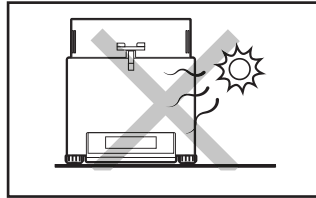

Place the device away from heat sources. Avoid exposing the device to the sunlight.

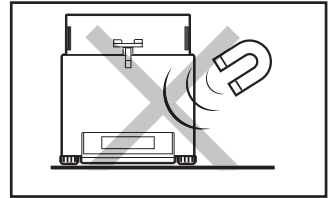

Avoid exposing the device to a magnetic field. Do not weigh magnetic substances.

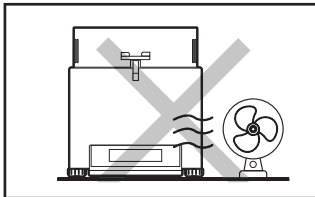

Avoid air drafts and air movements at the workstation.

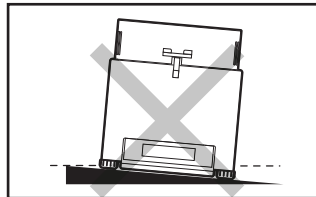

Make sure that the device is placed on an even surface.

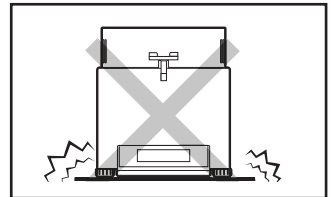

Do not place the device on an unstable surface exposed to shocks and vibrations.

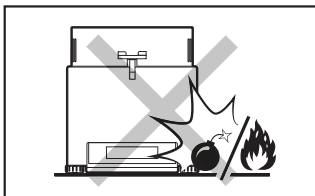

Do not place the device in a hazardous area. Do not weigh explosive or flammable materials.

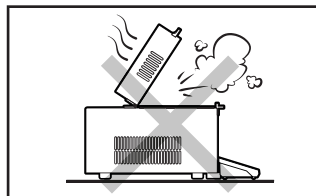

Do not open in the course of operation since the heating components reach very high temperature.

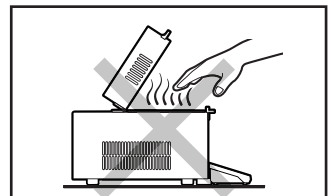

Be extremely careful while taking the sample out. The sample and the moisture analyzer elements may be hot.

## 4. COMPONENTS ASSEMBLY

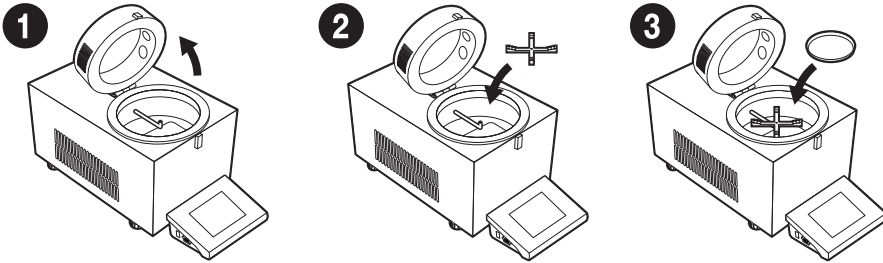

## 5. PREPARING FOR WORK

 Place the device at the workstation, wait until it reaches room temperature.

### 5.1. Temperature stabilization

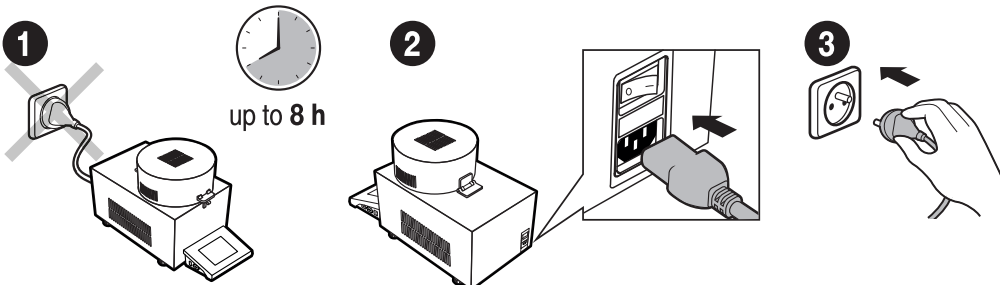

Prior to switching the device on let it reach room temperature (estimated stabilisation time: up to 8 hours).

Connect the power cord to the AC socket located at the back of the device.

Connect the device to the mains.

### 5.2. Switching the device on

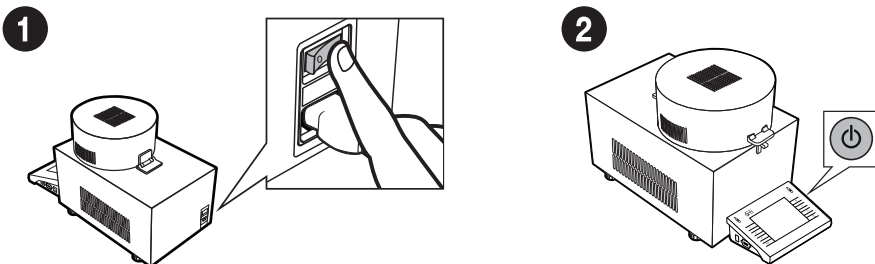

Press the switch located next to the power supply socket at the back of the housing to switch on the device.

To switch the device on, press ON / OFF key.

## 5.3. Balance levelling

1

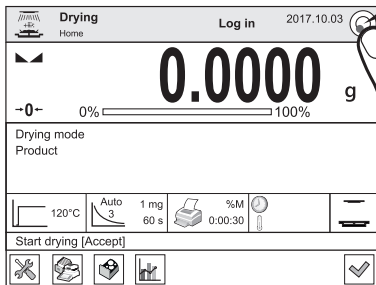

Press "Levelling" icon.

2

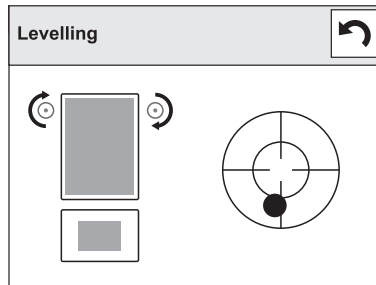

Check the balance level state. The arrows shows how to move the balance foets to level the balance.

3

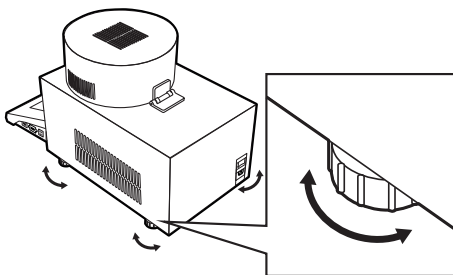

To level the balance turn its feet, keep turning the feet until the level indicator takes central position.

4

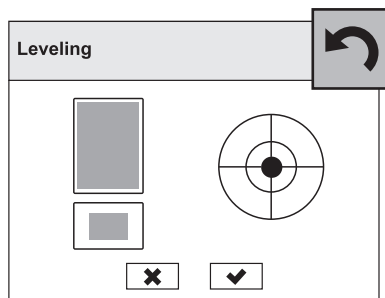

Balance has been levelled. To close the levelling window press  button.



### The moisture analyzer is ready to use!

Before using WEIGHING mode, carry out instrument adjustment: refer to section 8.1. (adjustment is not required for DRYING mode).

# 6. PANEL AND SCREEN

## 6.1. Panel keys

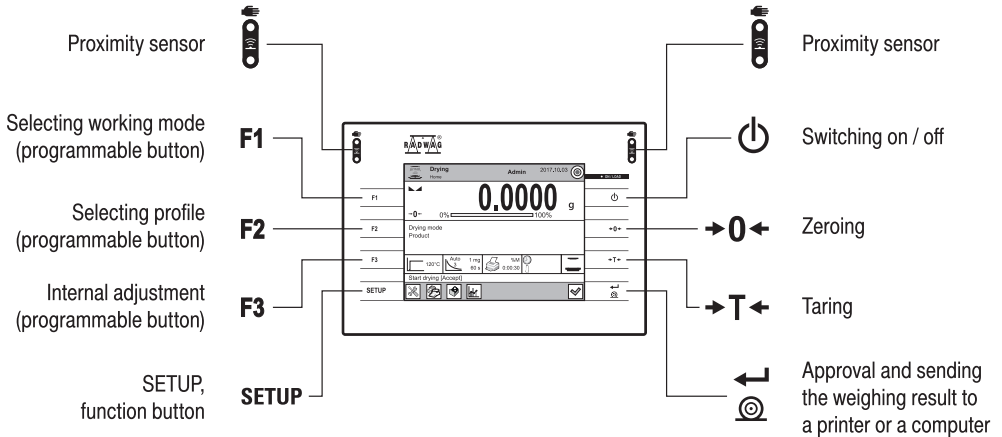

## 6.2. Home screen

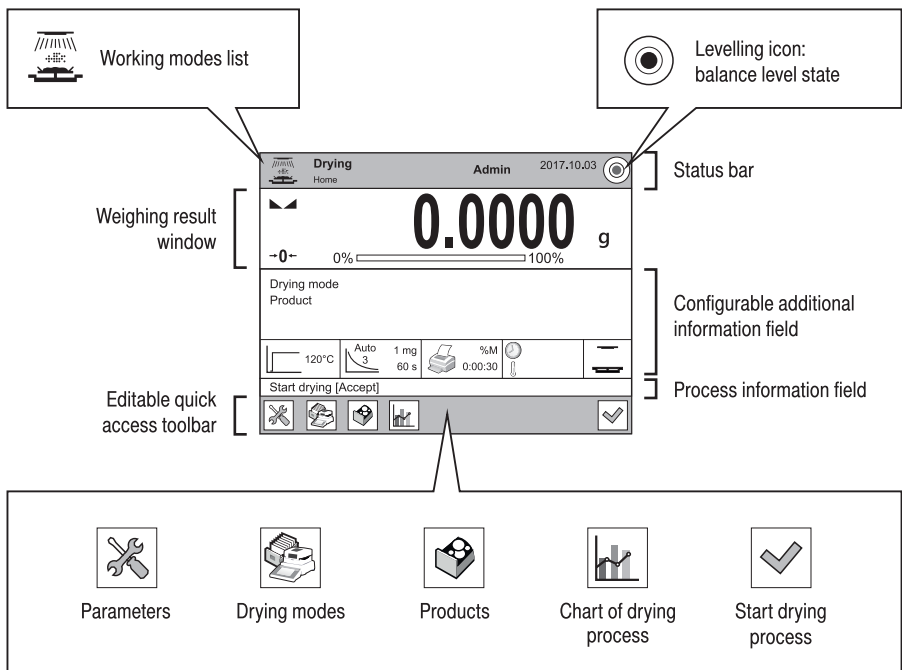

# 7. BASIC OPERATIONS

## 7.1. Adjustment

It is recommended to carry out adjustment operation prior to running the WEIGHING mode (adjustment is not required for DRYING). External adjustment is carried out using an external mass standard of the right accuracy and weight value, which value depends on device type and capacity.



The adjustment mass standard does not come with the moisture analyzer. Prior to adjustment prepare the right mass standard. You are recommended to use mass standard of class F1 or F2. View the table and select the mass standard you need.

Balance model	Mass standard [g]
PMV 50	50

**Caution!** Make sure that the disposable weighing pan has been installed (read point 4.3). Do not close the drying chamber in the course of adjustment.

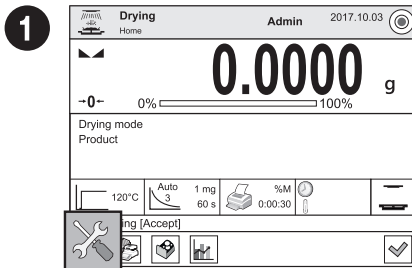

Press "Parameters" button.

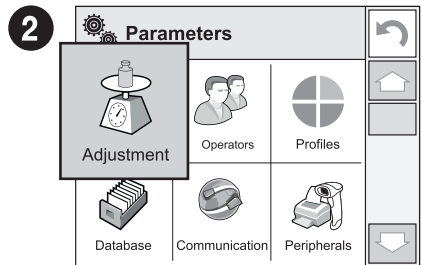

Press "Adjustment" button.

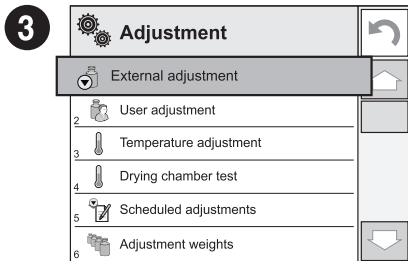

Press "External Adjustment" parameter.

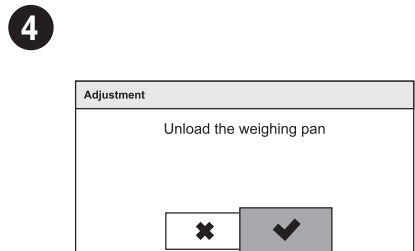

Unload the weighing pan and press  button for confirmation.



5

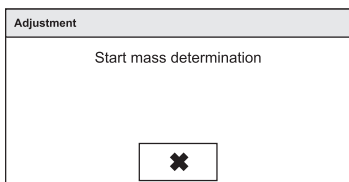

Determination of start mass in progress. Wait for determination completion.

6

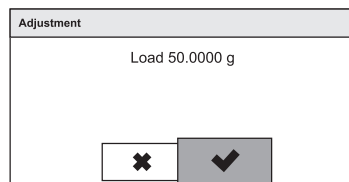

Load the weighing pan with mass standard and press  button for confirmation.

7

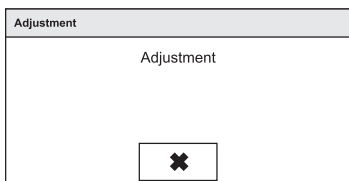

Wait for the process completion.

8

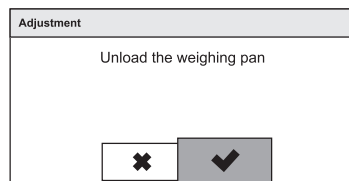

Unload the weighing pan and press  button for confirmation.

9

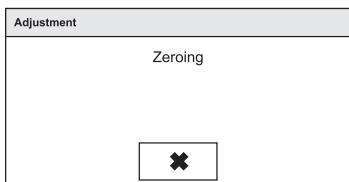

Zeroing in progress. Wait for zeroing completion.

10

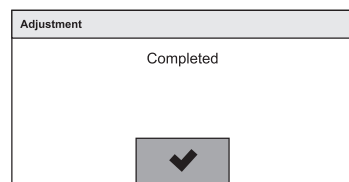

Adjustment completed. Press  button for confirmation.

## 7.2. Zeroing

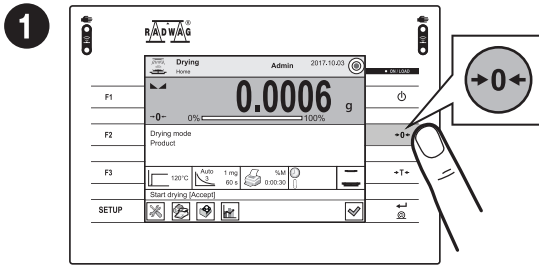

Make sure that the weighing pan is empty and press "Zero" button.

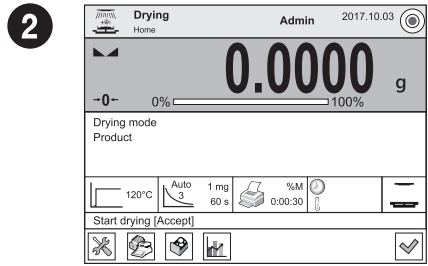

The balance has been zeroed.

## 7.3. Taring

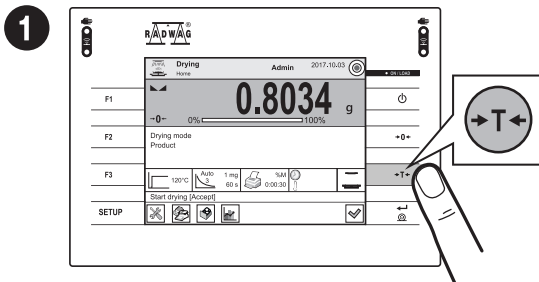

With loaded weighing pan: upon stabilisation of the weighing result, press "Tare" button.

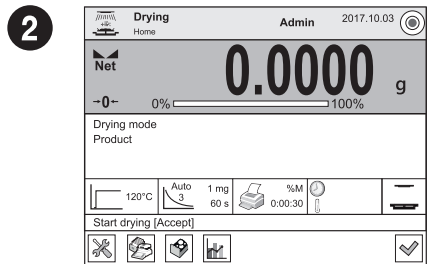

Balance has been tared.

## 7.4. Drying profiles / drying process finish modes



Prior to drying profiles / drying process finish modes setup, log in as Administrator (point 8.1).

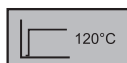

Press to view list of drying profiles.

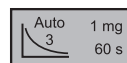
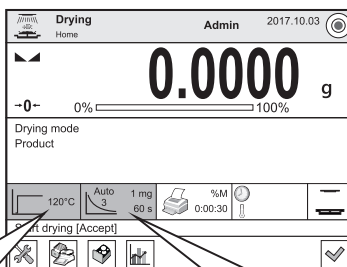

Press to view list of drying process finish modes.

**Drying profile**

Drying profile Standard

Temperature 120°C

Drying profile

Standard

**Drying profiles:**

- Standard:**  
the most precise moisture content measurement
- Mild:**  
the most precise moisture
- Fast:**  
for samples with moisture content 5% - 15%
- Step:**  
for substances with moisture content higher than 15%

**Finish mode**

Finish mode Automatic 3

STOP = 1 mg / 60 mg

Automatic 3

**Drying process finish modes:**

- Automatic:**  
triggered in accordance with automatic settings
- Time-defined:**  
triggered after passage of declared time
- Manual:**  
triggered manually by the user
- User-defined:**  
triggered in accordance with user settings
- Test:**  
Enables adjusting finish mode parameters to a tested sample

## 8. SETTINGS

 Some balance settings are accessible for Administrator exclusively.  
Prior to balance parameters setup, log in as the Administrator.

### 8.1. Administrator's logging in

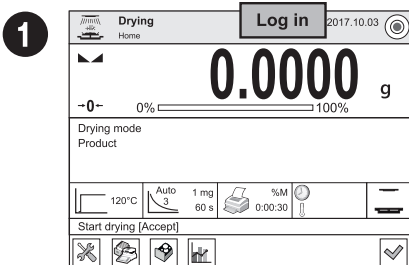

To enter "Users" menu press "Log in" button.

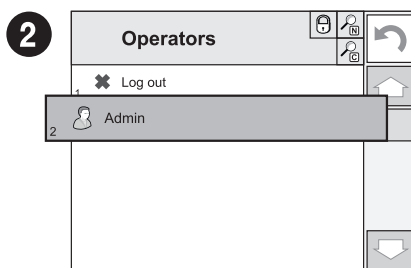

Users list is displayed, select "Admin" option.

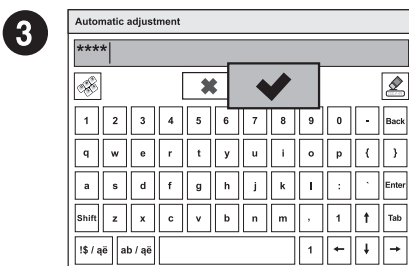

Enter "1111" password and press  button to confirm.

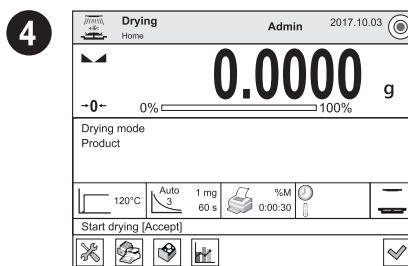

You have logged in as the Administrator.

### 8.2. User settings

 Prior to balance users setup, log in as Administrator (point 9.1.).

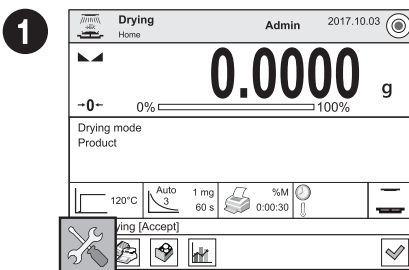

Press "Parameters" button.

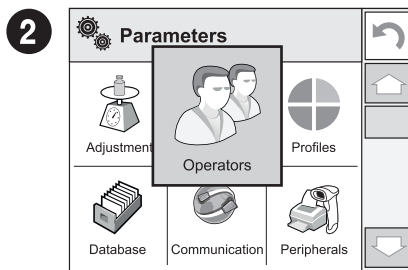

Press "Operators" button.

3

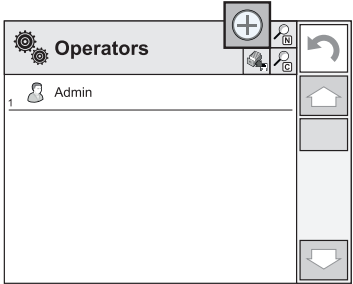

Press "Add" button.

4

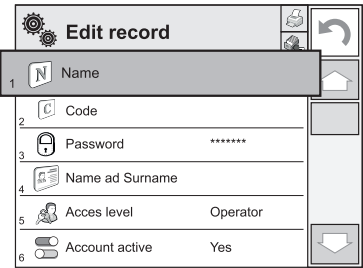

Select "Name" parameter.

5

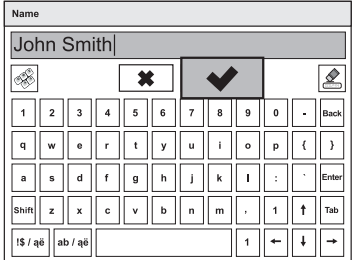

Enter user name and press  button to confirm.

6

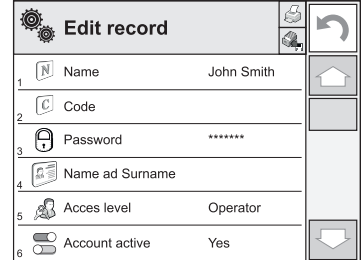

User name has been entered.

7

Following the above procedure, set remaining parameters:

**Code:**  
Enter user ID

**Password:**  
Enter user password

**First and last name:**  
Enter user's first and last name

**Access levels:**  
Set respective access level  
(user, advanced, admin)

**Account status:**  
(active or inactive)

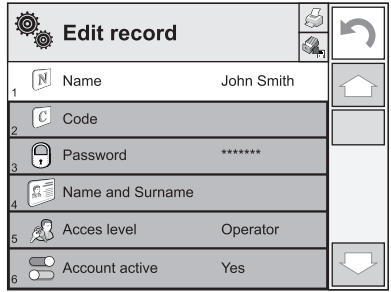

## 8.3. Proximity sensors setup



Prior to balance proximity sensor setup, log in as Administrator (point 9.1.).

You can assign the proximity sensors with different functions for each working mode (the sensors will trigger different operation for each working mode). See the below procedure of sensors setup for the “weighing” mode.

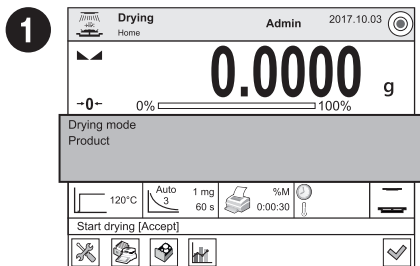

Press information field to access current working mode options.

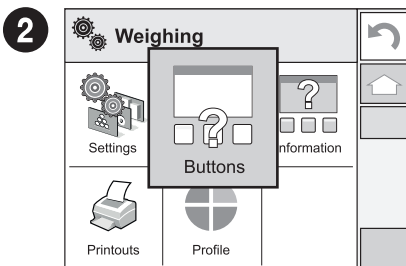

Press “Buttons” button.

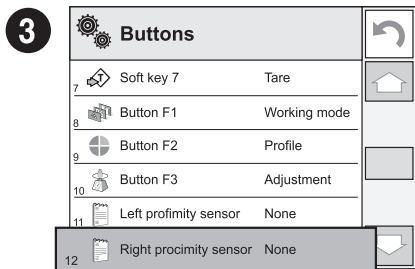

Select the appropriate sensor (right or left).

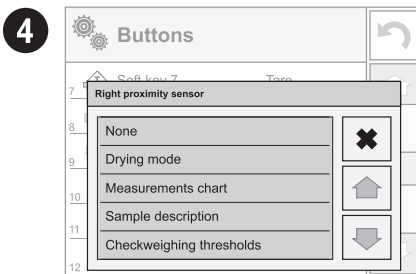

Select function that is to be assigned to the chosen sensor.



Following the above procedure you can configure sensors for other working modes.

## 9. SAMPLES AND DRYING METHODS

### 9.1. Preparing samples



Optimal sample structure and size are crucial features influencing measurements speed, accuracy and repeatability.



#### Solids:

- sample crushing necessary,
- sample of low weight required,
- large sample surface.



#### Samples with low moisture content:

- sample of heavy weight required (10 - 15 g).

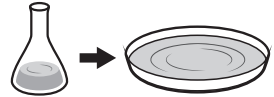

#### Liquids:

- large sample surface.

### 9.2. Handling hazardous samples



Some sample types require particular caution!

They may pose risk for people and objects. It is the moisture analyzer operator who is responsible for potential loss being a result of such samples use.



**Substances that in the course of heating may emit vapours causing corrosion (e.g. acids).**

Apply small amount of samples, this helps to prevent risk of settling of vapour over cool housing components.



**Explosive and flammable and materials that in the course of heating emit flammable vapours.**

Apply small amount of samples and lower drying temperature, this helps to prevent flames from rising and explosion. Use glasses and protective gloves.



**Toxic and corrosive substances and substances that in the course of heating emit toxic vapours.**

Due to risk of eyes, skin and lungs irritation, and due to risk of death, such samples must be dried in fume cupboard.

# 10. PERIPHERAL DEVICES CONNECTORS

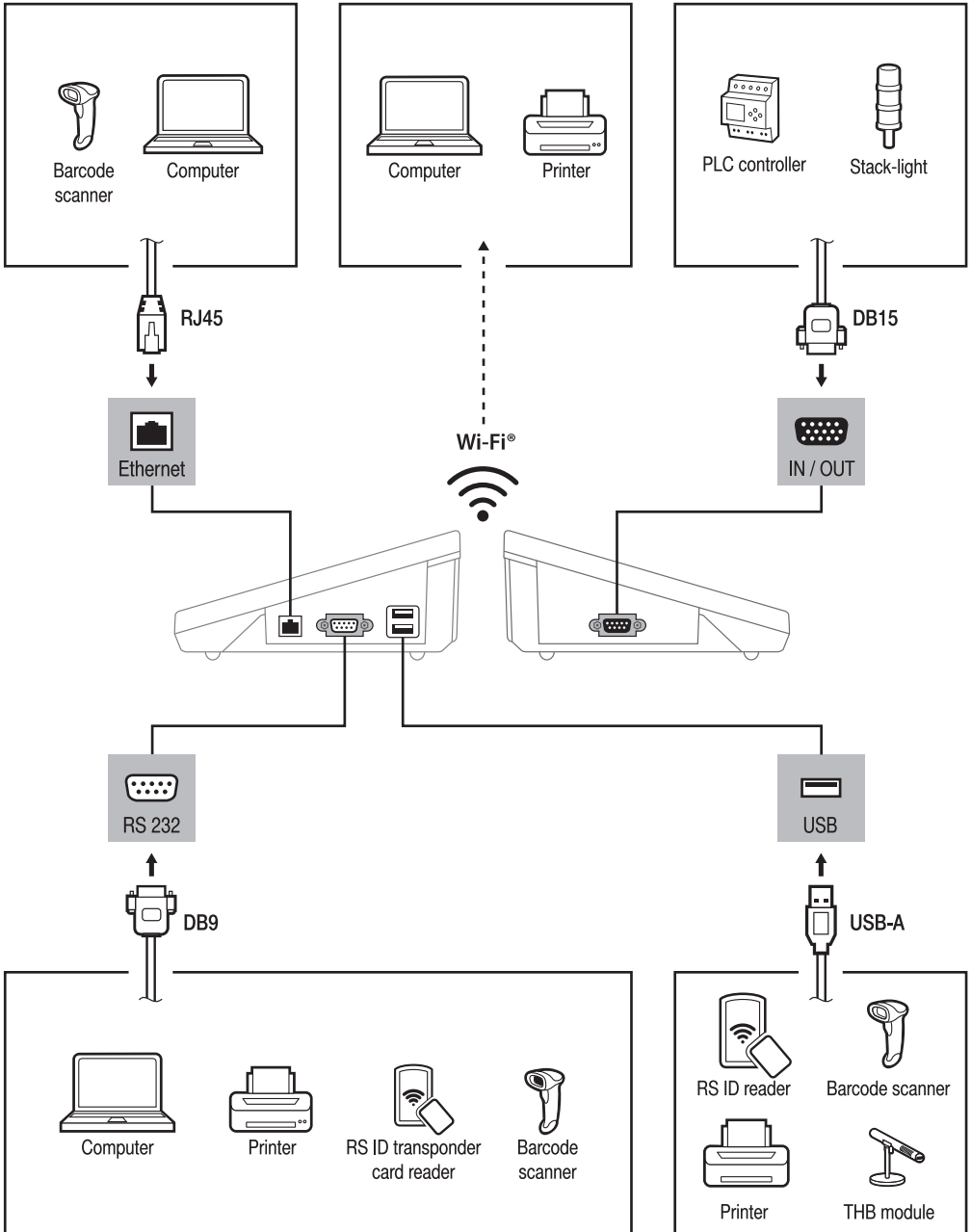



# 11. DEVICE CLEANING

## 11.1. General recommendations

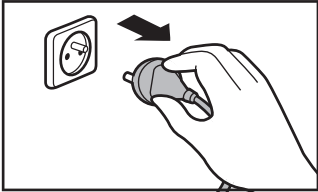

Prior to cleaning it is necessary to disconnect the device from the mains! Remove the plug from the outlet, disconnect all cables.

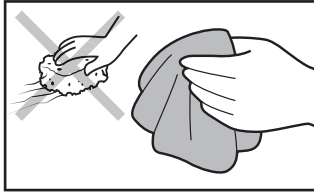

Use soft cloths made of microfiber, natural fiber or man-made fiber. Avoid using abrasive cloths or cloths that might scratch the surface.

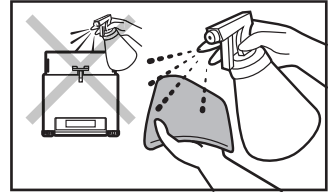

Apply the cleanser onto the cloth first. Avoid applying the cleanser directly onto the device.



Do not use aggressive cleaning agents (e.g. solvents, chlorine preparations, corrosive chemicals, bleach).



Neither use substances of sharp structure nor intended for scrubbing.



Make sure that neither dust nor liquid gets inside the weighing system (device inside).

## 11.2. Cleaning instructions

- **GLASS PANES AND COMPONENTS** can be cleaned using window cleaner.
- **WEIGHING PANS AND STAINLESS STEEL OR ALUMINIUM COMPONENTS** can be cleaned using a cloth slightly soaked in a solution of water and gentle cleanser (e.g. soap or dishwashing liquid).
- **OPERATION PANEL AND HOUSING** can be cleaned using a cloth slightly soaked in a solution of water and gentle cleanser (e.g. soap or dishwashing liquid).
- Dry sample leftovers can be removed using either brush or handheld vacuum cleaner.
- Clean components can be dried using soft cloth or dust-free paper towel, with this the remaining moist will be absorbed.
- **Install all the components providing they are completely dry.**







[www.radwag.com](http://www.radwag.com)