



RIGOL

DG800 Pro Series

Function/Arbitrary Waveform Generator

Quick Guide

Nov. 2023



Guaranty and Declaration

Copyright

© 2023 RIGOL TECHNOLOGIES CO., LTD. All Rights Reserved.

Trademark Information

RIGOL® is the trademark of RIGOL TECHNOLOGIES CO., LTD.

Software Version

Software upgrade might change or add product features. Please acquire the latest software version from **RIGOL** website or contact **RIGOL** to upgrade the software.

Notices

- RIGOL products are covered by P.R.C. and foreign patents, issued and pending.
- RIGOL reserves the right to modify or change parts of or all the specifications and pricing policies at the company's sole decision.
- Information in this publication replaces all previously released materials.
- Information in this publication is subject to change without notice.
- RIGOL shall not be liable for either incidental or consequential losses in connection with the furnishing, use, or performance of this manual, as well as any information contained.
- Any part of this document is forbidden to be copied, photocopied, or rearranged without prior written approval of RIGOL.

Product Certification

RIGOL guarantees that this product conforms to the national and industrial standards in China as well as the ISO9001:2015 standard and the ISO14001:2015 standard. Other international standard conformance certifications are in progress.

Contact Us

If you have any problem or requirement when using our products or this manual, please contact RIGOL.

E-mail: service@rigol.com

Website: <http://www.rigol.com>

1 Safety Requirement

1.1 General Safety Summary

Please review the following safety precautions carefully before putting the instrument into operation so as to avoid any personal injury or damage to the instrument and any product connected to it. To prevent potential hazards, please follow the instructions specified in this manual to use the instrument properly.

- | | | | |
|---|--|----|--|
| 1 | Only the exclusive power cord designed for the instrument and authorized for use within the destination country could be used. | 8 | Do not operate the instrument with suspected failures. |
| 2 | Ensure that the instrument is safely grounded. | 9 | Provide adequate ventilation. |
| 3 | Observe all terminal ratings. | 10 | Do not operate in wet conditions. |
| 4 | Use proper overvoltage protection. | 11 | Do not operate in an explosive atmosphere. |
| 5 | Do not operate without covers. | 12 | Keep instrument surfaces clean and dry. |
| 6 | Do not insert objects into the air outlet. | 13 | Prevent electrostatic impact. |
| 7 | Avoid circuit or wire exposure. | 14 | Handle with caution. |



WARNING

Equipment meeting Class A requirements may not offer adequate protection to broadcast services within residential environment.

1.2 Safety Notices and Symbols

Safety Notices in this Manual:



WARNING

Indicates a potentially hazardous situation or practice which, if not avoided, will result in serious injury or death.



CAUTION

Indicates a potentially hazardous situation or practice which, if not avoided, could result in damage to the product or loss of important data.

Safety Notices on the Product:

- **DANGER**
It calls attention to an operation, if not correctly performed, could result in injury or hazard immediately.
- **WARNING**
It calls attention to an operation, if not correctly performed, could result in potential injury or hazard.
- **CAUTION**
It calls attention to an operation, if not correctly performed, could result in damage to the product or other devices connected to the product.

Safety Symbols on the Product:

**Hazardous
Voltage**



Safety Warning



**Protective Earth
Terminal**

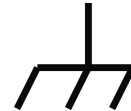

Chassis Ground



Test Ground

1.3 Measurement Category

Measurement Category

This instrument can make measurements in Measurement Category I.

**WARNING**

This instrument can only be used for measurements within its specified measurement categories.

Measurement Category Definitions

- **Measurement category I** is for measurements performed on circuits not directly connected to MAINS. Examples are measurements on circuits not derived from MAINS, and specially protected (internal) MAINS derived circuits. In the latter case, transient stresses are variable. Thus, you must know the transient withstand capability of the equipment.
- **Measurement category II** is for measurements performed on circuits directly connected to low voltage installation. Examples are measurements on household appliances, portable tools and similar equipment.
- **Measurement category III** is for measurements performed in the building installation. Examples are measurements on distribution boards, circuit-breakers, wiring (including cables, bus-bars, junction boxes, switches and socket-outlets) in the fixed installation, and equipment for industrial use and some other

equipment. For example, stationary motors with permanent connection to a fixed installation.

- **Measurement category IV** is for measurements performed at the source of a low-voltage installation. Examples are electricity meters and measurements on primary overcurrent protection devices and ripple control units.

1.4 Ventilation Requirement

This instrument uses a fan to force cooling. Please make sure that the air inlet and outlet areas are free from obstructions and have free air. When using the instrument in a bench-top or rack setting, provide at least 10 cm clearance beside, above and behind the instrument for adequate ventilation.



CAUTION

Inadequate ventilation may cause an increase of temperature in the instrument, which would cause damage to the instrument. So please keep the instrument well ventilated and inspect the air outlet and the fan regularly.

1.5 Working Environment

Temperature

Operating: 0°C to +40°C

Non-operating: -20°C to +60°C

Humidity

- **Operating:**
0°C to +40°C: ≤80% RH (without condensation)
- **Non-operating:**
-20°C to +40°C: ≤90% RH (without condensation)
Below +60°C: ≤80% RH (without condensation)



WARNING

To avoid short circuit inside the instrument or electric shock, never operate the instrument in a humid environment.

Altitude

- **Operating:** below 3 km
- **Non-operating:** below 12 km

Protection Level Against Electric Shock

ESD $\pm 8\text{kV}$

Installation (Overvoltage) Category

This product is powered by mains conforming to installation (overvoltage) category II.



WARNING

Ensure that no overvoltage (such as that caused by a bolt of lightning) can reach the product. Otherwise, the operator might be exposed to the danger of an electric shock.

Installation (Overvoltage) Category Definitions

Installation (overvoltage) category I refers to signal level which is applicable to equipment measurement terminals connected to the source circuit. Among these terminals, precautions are done to limit the transient voltage to a low level.

Installation (overvoltage) category II refers to the local power distribution level which is applicable to equipment connected to the AC line (AC power).

Pollution Degree

Pollution Degree 2

Pollution Degree Definition

- **Pollution Degree 1:** No pollution or only dry, nonconductive pollution occurs. The pollution has no effect. For example, a clean room or air-conditioned office environment.
- **Pollution Degree 2:** Normally only nonconductive pollution occurs. Temporary conductivity caused by condensation is to be expected. For example, indoor environment.
- **Pollution Degree 3:** Conductive pollution or dry nonconductive pollution that becomes conductive due to condensation occurs. For example, sheltered outdoor environment.
- **Pollution Degree 4:** The pollution generates persistent conductivity caused by conductive dust, rain, or snow. For example, outdoor areas.

Safety Class

Class 2

1.6 Care and Cleaning

Care

Do not store or leave the instrument where it may be exposed to direct sunlight for long periods of time.

Cleaning

Clean the instrument regularly according to its operating conditions.

1. Disconnect the instrument from all power sources.
2. Clean the external surfaces of the instrument with a soft cloth dampened with mild detergent or water. Avoid having any water or other objects into the chassis via the heat dissipation hole. When cleaning the LCD, take care to avoid scarifying it.



CAUTION

To avoid damage to the instrument, do not expose it to caustic liquids.



WARNING

To avoid short-circuit resulting from moisture or personal injuries, ensure that the instrument is completely dry before connecting it to the power supply.

1.7 Environmental Considerations

The following symbol indicates that this product complies with the WEEE Directive 2002/96/EC.



The equipment may contain substances that could be harmful to the environment or human health. To avoid the release of such substances into the environment and avoid harm to human health, we recommend you to recycle this product appropriately to ensure that most materials are reused or recycled properly. Please contact your local authorities for disposal or recycling information.

You can click on the following link <https://int.rigol.com/services/services/declaration> to download the latest version of the RoHS&WEEE certification file.

2 Document Overview

This manual gives you a quick overview of the front and rear panels, user interface as well as basic operation methods of DG800 Pro series function/arbitrary waveform generator.



TIP

For the latest version of this manual, download it from RIGOL official website (www.rigol.com).

Publication Number

QGB14100-1110

Format Conventions in this Manual

1. Key

The front panel key is denoted by the menu key icon. For example,  indicates the "Default" key.

2. Menu

The menu item is denoted by the format of "Menu Name (Bold) + Character Shading" in the manual. For example, **Setup**.

3. Operation Procedures

The next step of the operation is denoted by ">" in the manual. For example, .

> **Utility** indicates first clicking or tapping  and then clicking or tapping **Utility**.

Content Conventions in this Manual

DG800 Pro series function/arbitrary waveform generator includes the following models. Unless otherwise specified, this manual takes the two-channel model DG852 Pro as an example to illustrate the functions and operation methods of DG800 Pro series.

Model	No. of Channels	Sample Rate	Max. Output Frequency
DG821 Pro	1	625 MSa/s	25 MHz
DG822 Pro	2	625 MSa/s	25 MHz
DG852 Pro	2	625 MSa/s	50 MHz

3 General Inspection

1. Inspect the packaging

If the packaging has been damaged, do not dispose the damaged packaging or cushioning materials until the shipment has been checked for completeness and has passed both electrical and mechanical tests.

The consigner or carrier shall be liable for the damage to the instrument resulting from shipment. RIGOL would not be responsible for free maintenance/rework or replacement of the instrument.

2. Inspect the instrument

In case of any mechanical damage, missing parts, or failure in passing the electrical and mechanical tests, contact your RIGOL sales representative.

3. Check the accessories

Please check the accessories according to the packing lists. If the accessories are damaged or incomplete, please contact your RIGOL sales representative.

Recommended Calibration Interval

RIGOL suggests that the instrument should be calibrated every 12 months.

4 Product Overview

With up to 625 MSa/s sample rate and 2 Mpts/CH arbitrary waveform length, the DG800 Pro series function/arbitrary waveform generator is an all-in-one generator that integrates Function Generator, Arbitrary Waveform Generator, Noise Generator, Pulse Generator, Harmonics Generator, Analog/Digital Modulator, and Counter. It is a high-performance, cost-effective, and multi-functional dual-channel function/arbitrary waveform generator.

4.1 Appearance and Dimensions

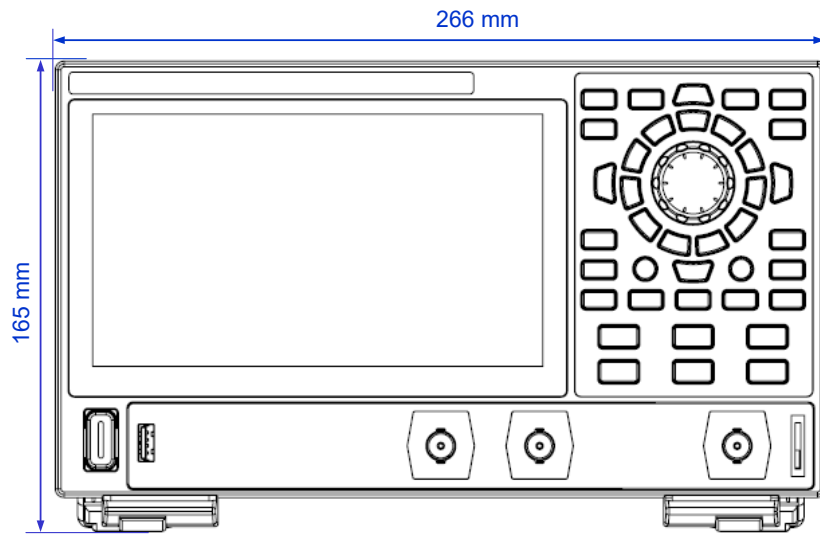

Figure 4.1 Front View

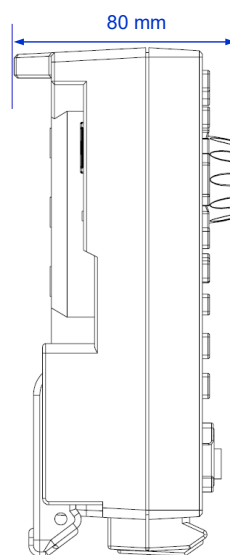

Figure 4.2 Side View

4.2 Front Panel Overview

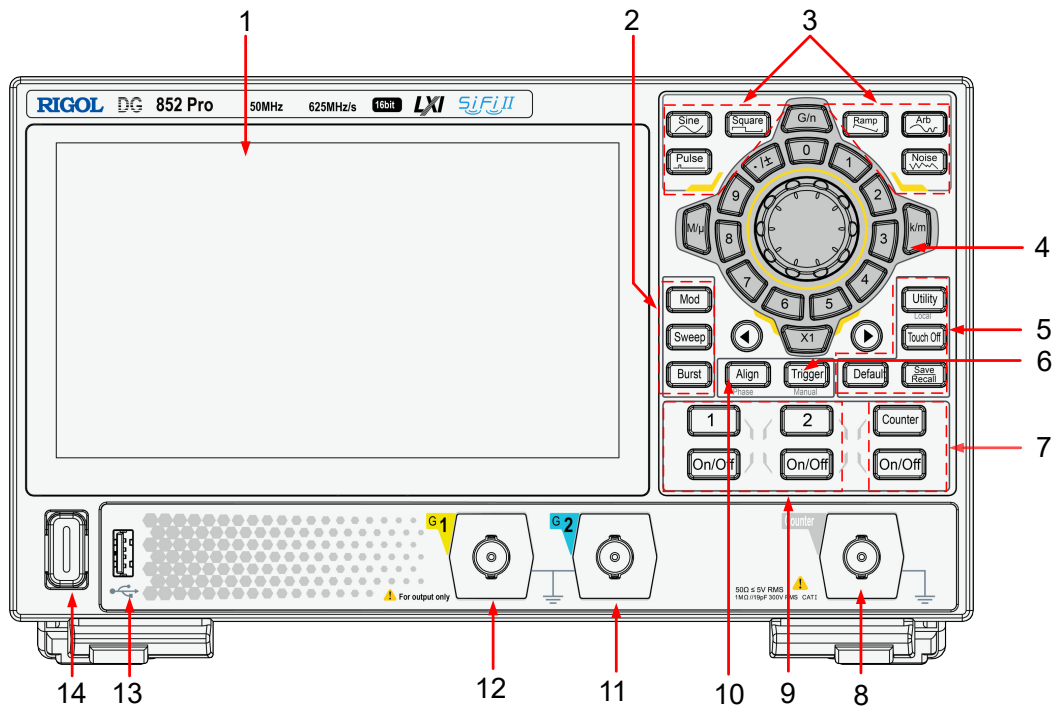

Figure 4.3 Front Panel

1	7-inch Touch Screen	8	Input Connector for the Signal Measured by Counter
2	Output Mode Selection Area	9	Channel Output Control Area
3	Basic Waveform Selection Area	10	Align Key
4	Parameter Input Area	11	CH2 Output Connector
5	Quick Operation Key	12	CH1 Output Connector
6	Manual Trigger Key	13	USB HOST Interface
7	Counter Control Area	14	Power Key

4.3 Rear Panel Overview

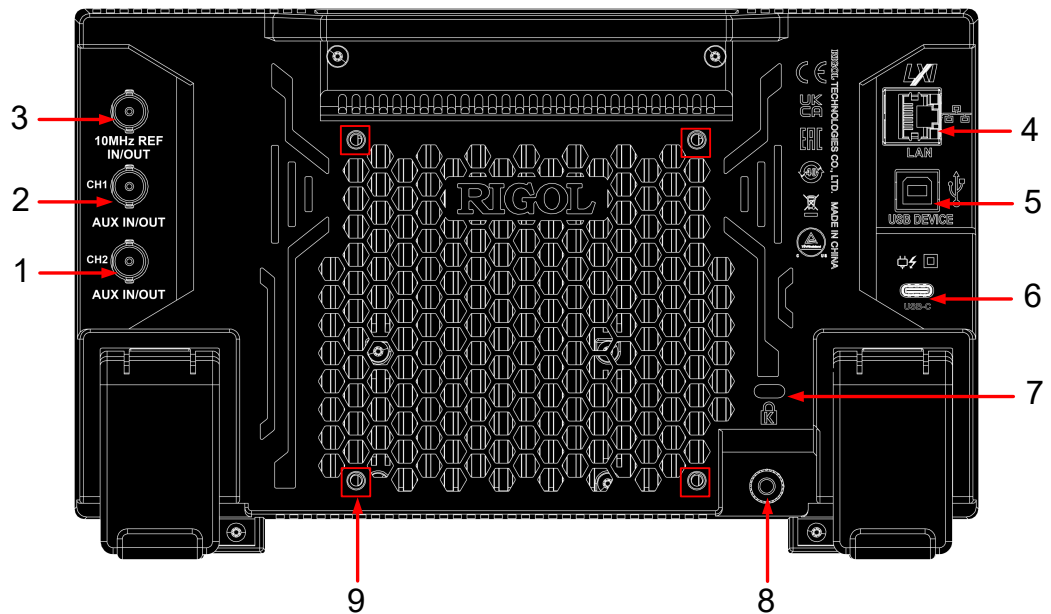

Figure 4.4 Rear Panel

- 1 CH2 Sync/Ext Mod/Trig Connector
- 2 CH1 Sync/Ext Mod/Trig Connector
- 3 10 MHz In/Out Connector
- 4 LAN Interface
- 5 USB DEVICE Interface
- 6 USB Type-C Power Connector
- 7 Security Lock Hole
- 8 Ground Terminal
- 9 Mounting Screw Holes (VESA 100 x 100)

4.4 User Interface Overview

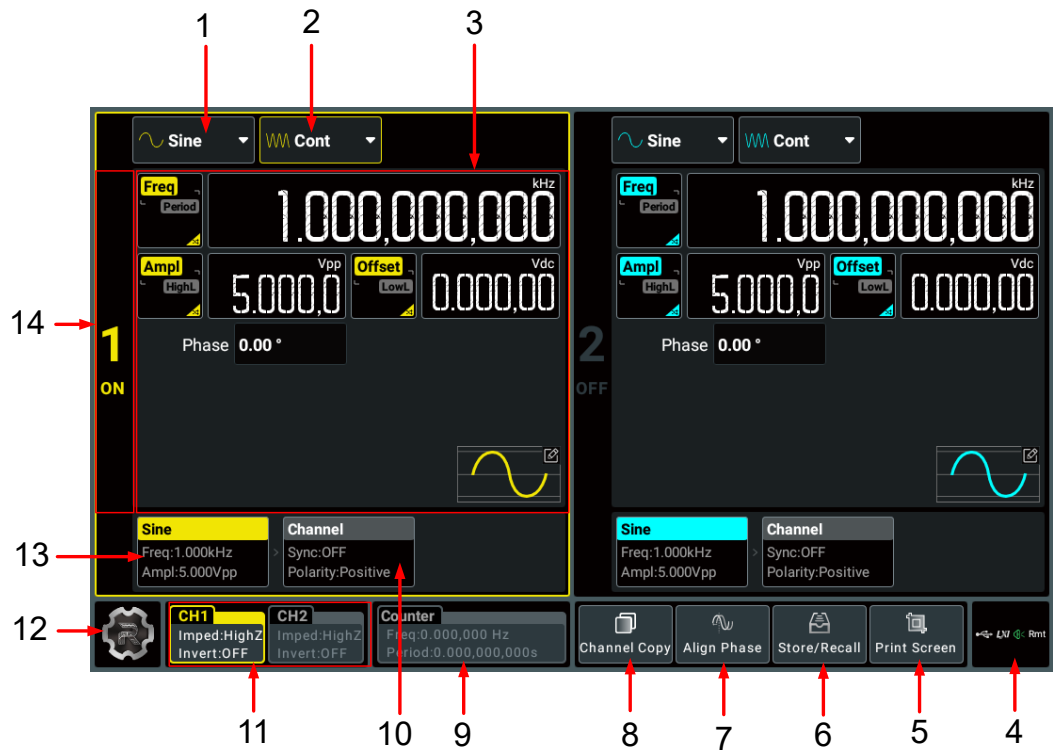

Figure 4.5 User Interface

1	Wave Type Drop-down Button	8	Channel Copy Function Key
2	Output Mode Drop-down Button	9	Counter Label
3	Parameter Configuration Area	10	Channel Tab
4	Notification Area	11	Channel Labels
5	Screen Capture Key	12	Function Navigation Icon
6	Store/Recall Key	13	Waveform Tab
7	Align Phase Function Key	14	Channel Identifier

5 To Prepare for Use

5.1 To Adjust the Supporting Legs

Adjust the supporting legs properly to use them as stands to tilt the instrument upwards for stable placement of the instrument as well as better operation and observation. You can also fold the supporting legs when the instrument is not in use for easier storage or shipment, as shown in the figure below.

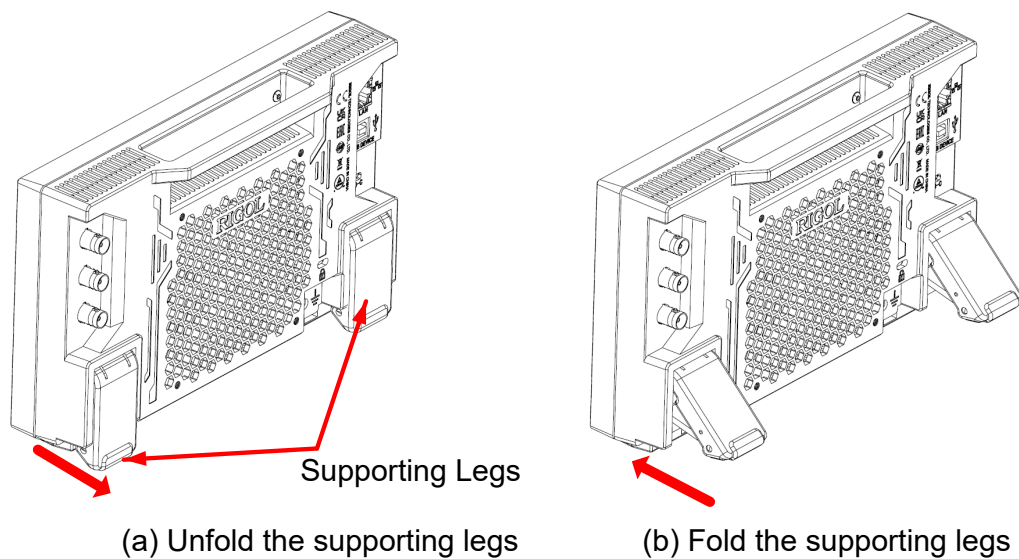

Figure 5.1 Adjust the Supporting Legs

5.2 To Connect to Power

The power requirements of this signal source are USB PD 15 V, 3 A. Please use the power adaptor provided in the accessories to connect the instrument to the AC power source (100 V to 240 V, 50 Hz to 60 Hz), as shown in the figure below.

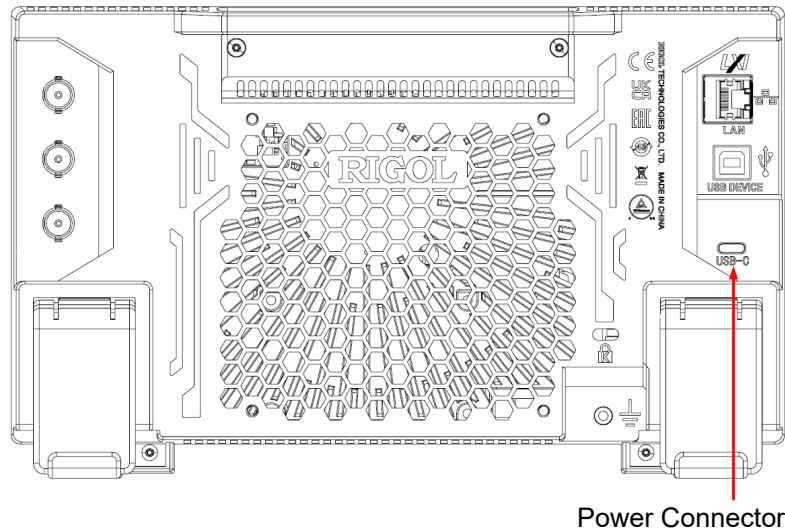

Figure 5.2 Connect to Power

Table 5.1 Power Adaptor Specifications

Item	Description
Input	100 V to 240 V, 50 Hz to 60 Hz, 1.6 A Max
Output	USB PD 15 V, 3 A, 45 W



CAUTION

The power adaptor provided in accessories can only be used to power RIGOL instruments. Do not use it for mobile phone and other devices.



WARNING

To avoid electric shock, please ensure that the instrument is correctly grounded.





5.3 Turn-on Checkout

After the instrument is connected to the power source, press **0** at the lower-left corner of the front panel to power on the instrument. During the start-up process, the instrument performs a series of self-tests. After the self-test, the splash screen is

displayed. You can also click or tap  > **Utility** > **Setup** to set the "Power Set" to "Auto". The instrument powers on once connected to power. If the instrument won't start, please refer to *Troubleshooting* to address it.

**TIP**

You can shut down the instrument in the following ways.

- Click or tap  > **Shut Down** or press the front-panel  and a dialog box "Do you need to shut down the instrument?" is displayed. Click or tap **Shut Down** to shut down the instrument.
- Press  twice to shut down the instrument.
- Press  for three seconds to shut down the instrument.

5.4 To Set the System Language

The instrument supports system languages including Chinese and English. You can

click or tap  > **Utility** > **Setup** to enter the basic settings menu. Then click or tap the drop-down button of **Language** to set the system language to Chinese or English.

6 To Use the Built-in Help System

The built-in help file provides information about the functions and menu

introductions of the instrument. Click or tap  > **Help** to enter the help system.

In the help system, you can get its help information by clicking on or tapping the link for the specified chapter.

7 To Use the Security Lock

If necessary, you can lock the instrument to a fixed location by using a standard laptop security lock (please purchase it by yourself), as shown in the figure below.

The method is as follows: align the lock with the lock hole and plug it into the lock hole vertically, turn the key clockwise to lock the instrument, and then pull the key out.

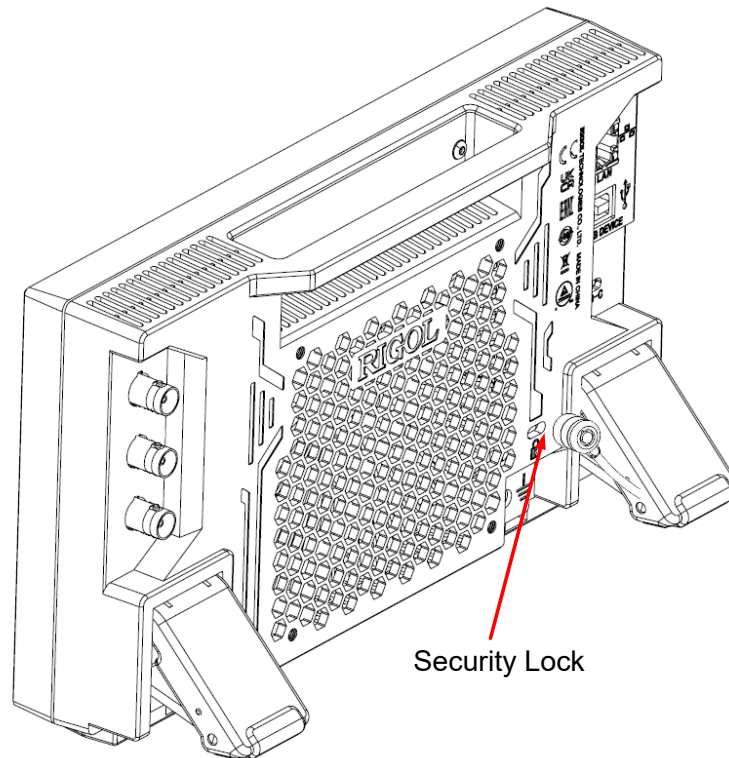

Figure 7.1 Use the Security Lock



CAUTION

Please do not insert other objects into the security lock hole to avoid damaging the instrument.

8 Parameter Setting Method

This instrument allows you to use the front-panel parameter input area and the touch screen to set parameters for the instrument.

8.1 To Set Parameters with the Front-panel Keys and Knobs

You can use the front-panel parameter input area to set some parameters of the instrument. The parameter input area consists of a knob, a numeric keypad, unit selection keys, and arrow keys, as shown in the figure below.

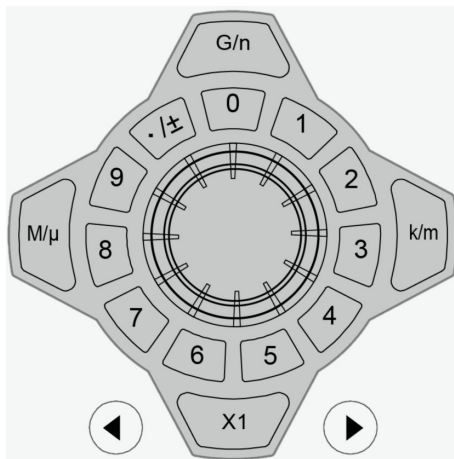

Knob



You can rotate the knob to move the cursor and navigate through the menu items. Then perform the following operations:

- **If the cursor selects a parameter input field**, you can press the knob to enter the parameter editing mode. Then you can use the front-panel arrow keys to move the cursor to select the digit place to be modified. Rotate the knob clockwise to increment the value at the selected digit place or counter-clockwise to decrement the value. Press the knob again to confirm the parameter setting and disable the parameter editing mode.
- **If the cursor selects a drop-down button**, you can press the knob to expand the drop-down menu and then rotate the knob to select a parameter in the menu. After that, press the knob again to confirm your selection and collapse the drop-down menu.
- **If the cursor selects a key, on/off switch, or tab control**, pressing the knob is equivalent to tapping the corresponding key, on/off switch, or tab control using the touch screen.

Numeric Keypad













Ring-type numeric keypad composed of numeric keys (from 0 to 9) and the decimal point/symbol key. If the current cursor selects the input field, you can press the

numeric key to input a number and press  to input ".", "-", or "+". When using the ring-type numeric keypad, you can also perform the following operations:

- Press the knob to confirm the input.
- Press  to delete characters.
- Press  to cancel the input.

Unit Selection Keys



When setting parameter with the ring-type numeric keypad on the front panel, you can use the keys to select the unit of the parameter.

- : sets the parameter unit to the default one. For example, when setting the phase, press  >  to set the phase to 1°; when setting the frequency, press  >  to set the frequency to 1 Hz.
-  /  / : when setting the frequency, use the unit (M/k/G) before "/"; when setting time/amplitude/offset, use the unit (μ/m/n) after "/". For example, when setting the frequency, press  >  to set the frequency to 1 kHz; when setting the period, press  >  to set the period to 1 ms.

TIP

When the set value exceeds the limit value, the instrument automatically adjusts the parameter to meet the requirements.

Arrow keys

- In normal mode, you can use the keys to move the cursor to select the desired menu item. It is equivalent to rotating the knob.
- In parameter editing mode, you can use the keys to select the digit place to be modified.
- When inputting parameters using the ring-type numeric keypad,  is used to delete the character while  is used to cancel the input and close the input field.

8.2 To Set Parameters with the Touch Screen

For this instrument, you can use the touch screen function to set all of its parameters. Click or tap the parameter input field and a virtual keypad will be displayed. You can use the pop-up keypad to complete your parameter setting. The method of using the virtual keypad is as follows.

Input a Value

When setting or modifying a function parameter, you can input an appropriate value with the numeric keypad.

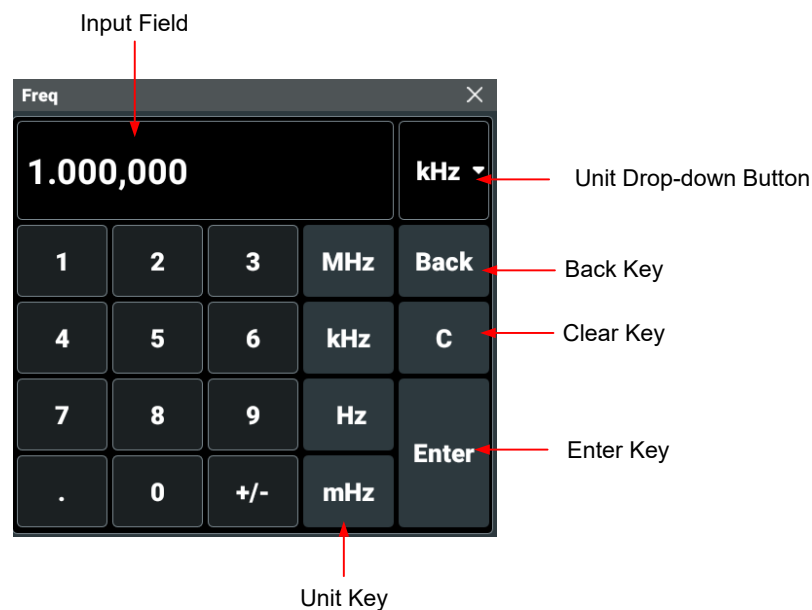

Figure 8.1 Numeric Keypad

Use the numeric keys in the numeric keypad to input a value. Then select the desired unit, and the numeric keypad is turned off automatically. This indicates that you have completed the parameter setting. The unit drop-down menu includes all available units. You can also click or tap the unit drop-down button to select the desired unit when multiple units are available. Then click or tap "Enter" to confirm input and close the numeric keypad.

9 Remote Control

The following ways of remote control are supported:

- **User-defined Programming**

Users can program and control the instrument by using the SCPI (Standard Commands for Programmable Instruments) commands. For details about the SCPI commands and programming, refer to *Programming Guide* of this product series.

- **PC Software**

You can use the PC software to send SCPI commands to control the instrument remotely. RIGOL Ultra Sigma is recommended. You can download the software from RIGOL official website (<http://www.rigol.com>).

Operation Procedures:

- Set up communication between the instrument and PC.
- Run Ultra Sigma and search for the instrument resource.
- Open the remote command control panel to send commands.

- **Web Control**

This instrument supports Web Control. Connect the instrument to the network, then input the IP address of the instrument into the address bar of the browser of your computer. The web control interface is displayed. Click Web Control to enter the web control page. Then you can view the display of the real-time interface of the instrument. Through the Web Control method, you can migrate the device control to the control terminals (e.g. PC, Mobile, iPad, and other smart terminals) to realize remote control of the instrument. You have to log in before using the Web Control to modify network settings. When you first log in to the Web Control, the user name is "admin" and password is "rigol".

This instrument can be connected to the PC via the USB and LAN interface to set up communication and realize remote control through the PC.

CAUTION

Before connecting the communication cable, please turn off the instrument to avoid causing damage to the communication interfaces.



10 Troubleshooting

1. When I power on the instrument, the instrument stays black and does not display anything.

- a. Check whether the power supply has been connected correctly.
- b. Check whether the power key is really pressed.
- c. Restart the instrument after finishing the above inspections.
- d. If the problem still persists, please contact RIGOL.

2. The settings are correct but no waveform is generated.

- a. Check whether the output cable is connected to the corresponding channel output terminal tightly.
- b. Check whether the output cable has internal damage.
- c. Check whether the output cable is connected to the test instrument tightly.
- d. If the problem still persists, please contact RIGOL.

3. The USB storage device cannot be recognized.

- a. Check whether the USB storage device can work normally when connected to other instruments or PC.
- b. Make sure that the USB storage device is FAT32, NTFS, or exFAT type. The instrument doesn't support hardware USB storage device.
- c. After restarting the instrument, insert the USB storage device again to check whether it can work normally.
- d. If the USB storage device still cannot work normally, please contact RIGOL.

4. Performance verification test is failed.

- a. Check whether the generator is within calibration period (1 year).
- b. Check whether the generator has been warmed up for at least 20 minutes before the test.
- c. Check whether the generator is under the specified temperature.
- d. Check whether the test is under strong-magnetism environment.
- e. Check whether the power supplies of the generator and test system have a strong interference.
- f. Check whether the performance of the test device used meets the requirement.

- g.** Make sure that the test device used is within the calibration period.
- h.** Check whether the test device used meets the required conditions of the manual.
- i.** Check whether all the connections are tight.
- j.** Check whether any cable has internal damage.
- k.** Make sure that the operations conform to settings and processes which are required by the performance verification manual.
- l.** Check whether the error calculation has faults.
- m.** Correctly understand the definition of "typical value" for this product: the performance specification of this product under specified conditions.

5. The touch-enabled operation does not work.

- a.** Check whether you have locked the touch screen. If yes, unlock the touch screen.
- b.** Check whether the screen or your finger is stained with oil or sweat. If yes, please clean the screen or dry your hands.
- c.** Check whether there is a strong magnetic field around the instrument. If the instrument is close to the strong magnetic field (e.g. a magnet), please move the instrument away from the magnet field.
- d.** If the problem still persists, please contact RIGOL.

11 More Product Information

Click or tap  > **Utility** > **About** to obtain the information of this instrument, such as the model, serial number, and hardware version number.

You can also click or tap the notification area at the lower-right corner of the screen and obtain the information by clicking or tapping **About** in the pop-up **Utility** menu.

For more information about the instrument, refer to the relevant manuals by logging in to the official website of RIGOL (<http://www.rigol.com>) to download them.

- *DG800 Pro User Guide* introduces the functions of the instrument and the operation methods, remote control methods, possible failures and solutions in using the instrument, specifications, and order information.
- *DG800 Pro Programming Guide* provides detailed descriptions of SCPI commands and programming examples of the instrument.
- *DG800 Pro Data Sheet* provides the main features and technical specifications of the instrument.

HEADQUARTER

RIGOL TECHNOLOGIES CO., LTD.
No.8 Keling Road, New District, Suzhou,
JiangSu, P.R.China
Tel: +86-400620002
Email: info@rigol.com

EUROPE

RIGOL TECHNOLOGIES EU GmbH
Carl-Benz-Str.11
82205 Gilching
Germany
Tel: +49(0)8105-27292-0
Email: info-europe@rigol.com

NORTH AMERICA

RIGOL TECHNOLOGIES, USA INC.
10220 SW Nimbus Ave.
Suite K-7
Portland, OR 97223
Tel: +1-877-4-**RIGOL**-1
Fax: +1-877-4-**RIGOL**-1
Email: info@rigol.com

JAPAN

RIGOL JAPAN CO., LTD.
5F,3-45-6,Minamiotsuka,
Toshima-Ku,
Tokyo,170-0005,Japan
Tel: +81-3-6262-8932
Fax: +81-3-6262-8933
Email: info-japan@rigol.com

RIGOL® is the trademark of **RIGOL TECHNOLOGIES CO., LTD.** Product information in this document is subject to update without notice. For the latest information about **RIGOL**'s products, applications and services, please contact local **RIGOL** channel partners or access **RIGOL** official website: www.rigol.com