

RIGOL

快速指南

DP800A 系列可编程线性直流电源

2013 年 8 月
RIGOL Technologies, Inc.

保证和声明

版权

© 2012 北京普源精电科技有限公司版权所有。

商标信息

RIGOL 是北京普源精电科技有限公司的注册商标。

文档编号

QGH03004-1110

声明

- 本公司产品受已获准及尚在审批的中华人民共和国专利的保护。
- 本公司保留改变规格及价格的权利。
- 本手册提供的信息取代以往出版的所有资料。
- 对于本手册可能包含的错误，或因手册所提供的信息及演绎的功能，以及因使用本手册而导致的任何偶然或继发的损失，**RIGOL** 概不负责。
- 未经 **RIGOL** 事先书面许可不得影印复制或改编本手册的任何部分。

产品认证

RIGOL 认证本产品符合中国国家产品标准和行业产品标准及 ISO9001:2008 标准和 ISO14001:2004 标准，并进一步认证本产品符合其它国际标准组织成员的相关标准。

联系我们

如您在使用此产品或本手册的过程中有任何问题或需求，可与 **RIGOL** 联系：

电子邮箱：service@rigol.com

网址：www.rigol.com

安全要求

一般安全概要

了解下列安全性预防措施，以避免受伤，并防止损坏本产品或与本产品连接的任何产品。为避免可能的危险，请务必按照规定使用本产品。

使用正确的电源线。

只允许使用所在国家认可的本产品专用电源线。

将产品接地。

本产品通过电源电缆的保护接地线接地。为避免电击，在连接本产品的任何输入或输出端子之前，请确保本产品电源电缆的接地端子与保护接地端可靠连接。

查看所有终端额定值。

为避免起火和过大电流的冲击，请查看产品上所有的额定值和标记说明，请在连接产品前查阅产品手册以了解额定值的详细信息。

使用合适的过压保护。

确保没有过电压（如由雷电造成的电压）到达该产品。否则操作人员可能有遭受电击的危险。

请勿开盖操作。

请勿在仪器机箱打开时运行本产品。

使用合适的保险丝。

只允许使用本产品指定规格的保险丝。

避免电路外露。

电源接通后，请勿接触外露的接头和元件。

怀疑产品出故障时，请勿进行操作。

如果您怀疑本产品出现故障，请联络**RIGOL**授权的维修人员进行检测。任何维护、调整或零件更换必须由**RIGOL**授权的维修人员执行。

保持适当的通风。

通风不良会引起仪器温度升高，进而引起仪器损坏。使用时应保持有良好的通风，定期检查通风口和风扇。

请勿在潮湿环境下操作。

为避免仪器内部电路短路或发生电击的危险，请勿在潮湿环境下操作仪器。

请勿在易燃易爆的环境下操作。

为避免仪器损坏或人身伤害，请勿在易燃易爆的环境下操作仪器。

请保持产品表面的清洁和干燥。

为避免灰尘或空气中的水分影响仪器性能，请保持产品表面的清洁和干燥。

防静电保护。

静电会造成仪器损坏，应尽可能在防静电区进行测试。在连接电缆到仪器前，应将其内外导体短暂接地以释放静电。

注意搬运安全。

为避免仪器在搬运过程中滑落，造成仪器面板上的按键、旋钮或接口等部件损坏，请注意搬运安全。

安全术语和符号

本手册中的术语。以下术语可能出现在本手册中：



警告

警告性声明指出可能会危害操作人员生命安全的条件和行为。



注意

注意性声明指出可能导致本产品损坏或数据丢失的条件和行为。

产品上的术语。以下术语可能出现在产品上：

危险

表示您如果进行此操作可能会立即对您造成危害。

警告

表示您如果进行此操作可能会对您造成潜在的危害。

注意

表示您如果进行此操作可能会对本产品或连接到本产品的其他设备造成损坏。

产品上的符号。以下符号可能出现在产品上：



高电压



安全警告



保护性接地端



壳体接地端



测量接地端

保养与清洁

保养

请勿将仪器放置在长时间受到日照的地方。

清洁

请根据使用情况经常对仪器进行清洁。方法如下：

1. 断开电源。
2. 用潮湿但不滴水的软布（可使用柔和的清洁剂或清水）擦拭仪器外部的浮尘。清洁带有液晶显示屏的仪器时，请注意不要划伤 LCD 显示屏。



注意

请勿使任何腐蚀性的液体沾到仪器上，以免损坏仪器。



警告

重新通电之前，请确认仪器已经干透，避免因水分造成电气短路甚至人身伤害。

环境注意事项

以下符号表明本产品符合欧盟根据关于废弃电气、电子设备（WEEE）的Directive 2002/96/EC 所制定的要求。



设备回收

本产品中包含的某些物质可能会对环境或人体健康有害，为避免将有害物质释放到环境中或危害人体健康，建议采用适当的方法回收本产品，以确保大部分材料可正确地重复使用或回收。有关处理或回收的信息，请与当地权威机构联系。

文档概述

本手册用于指导用户快速了解DP800A系列可编程线性直流电源的前后面板、用户界面以及基本操作方法。您可登录**RIGOL**网站（www.rigol.com）下载所需文档的最新版本。

文档格式的约定

1 按键

用“按键字符（加粗）+文本框”，表示前面板功能按键，如 **Utility** 表示“系统辅助功能设置”按键。

2 菜单

用“菜单文字（加粗）+字符底纹”，表示一个菜单选项，如 **系统信息** 表示 **Utility** 按键下“系统信息”菜单选项。

3 操作步骤

操作步骤：用箭头“→”表示下一步操作，例如：**Utility** → **系统设置** 表示按下前面板上的 **Utility** 功能键后，再按 **系统设置** 菜单键。

文档内容的约定

DP800A系列可编程线性直流电源包含以下型号，本手册以DP831A为例说明DP800A系列的功能和操作方法。

型号	通道	输出通道电压/电流
DP831A	3	8V/5A、30V/2A、-30V/2A
DP832A	3	30V/3A、30V/3A、5V/3A
DP821A	2	60V/1A、8V/10A
DP811A	1	20V/10A（档位1）、40V/5A（档位2）

目录

保证和声明	I
安全要求	II
一般安全概要	II
安全术语和符号	IV
保养与清洁	V
环境注意事项	V
文档概述	VI
快速入门	1
一般性检查	1
外观尺寸	2
前面板	3
后面板	13
连接电源	15
开机检查	15
更换保险丝	16
用户界面	17
使用内置帮助系统	19
故障处理	20

快速入门

一般性检查

1. 检查运输包装

如运输包装已损坏，请保留被损坏的包装或防震材料，直到货物经过完全检查且仪器通过电性和机械测试。

因运输造成仪器损坏，由发货方和承运方联系赔偿事宜。**RIGOL**公司恕不进行免费维修或更换。

2. 检查整机

若存在机械损坏或缺失，或者仪器未通过电性和机械测试，请联系您的 **RIGOL** 经销商。

3. 检查随机附件

请根据装箱单检查随机附件，如有损坏或缺失，请联系您的**RIGOL**经销商。

外观尺寸

DP800A 系列不同型号的尺寸大小相同，但前面板和后面板的设计有所不同（不同之处请参考“前面板”和“后面板”中的介绍）。本节以 DP831A 为例介绍 DP800A 的外观尺寸（如图 1 和图 2 所示）。



图 1 正视图

单位：mm

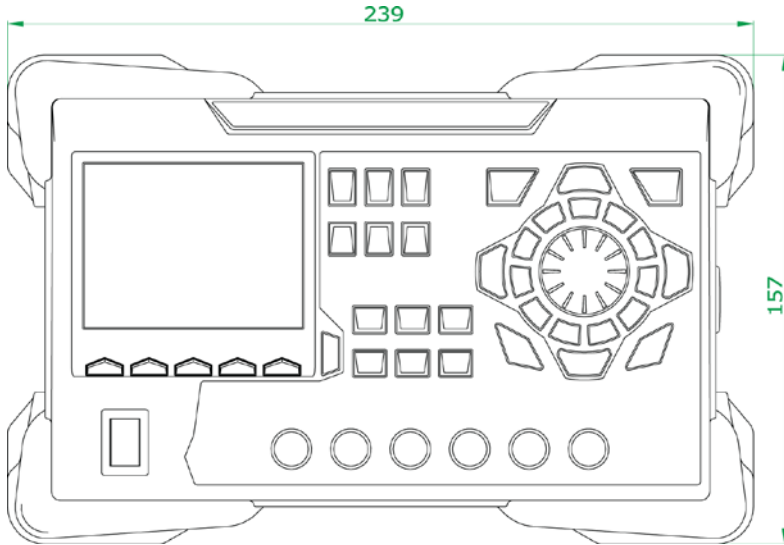

图 2 侧视图

单位：mm

前面板

DP800A 系列不同型号的前面板如下图所示，本节主要以 DP831A（如图 3 所示）为例来介绍 DP800A 系列前面板。

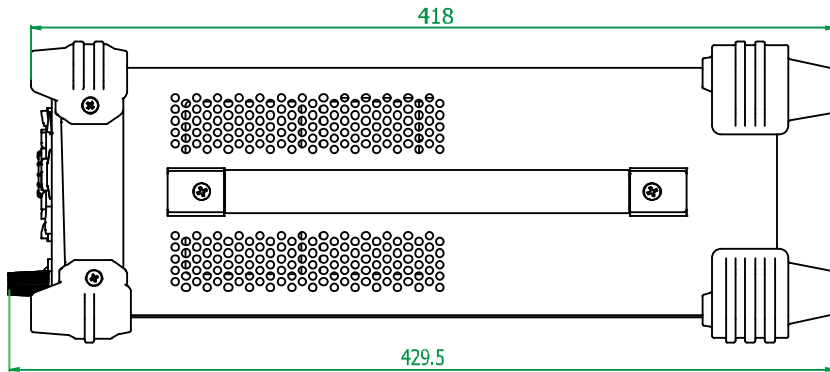

图 3 DP831A 前面板



图 4 DP821A 前面板

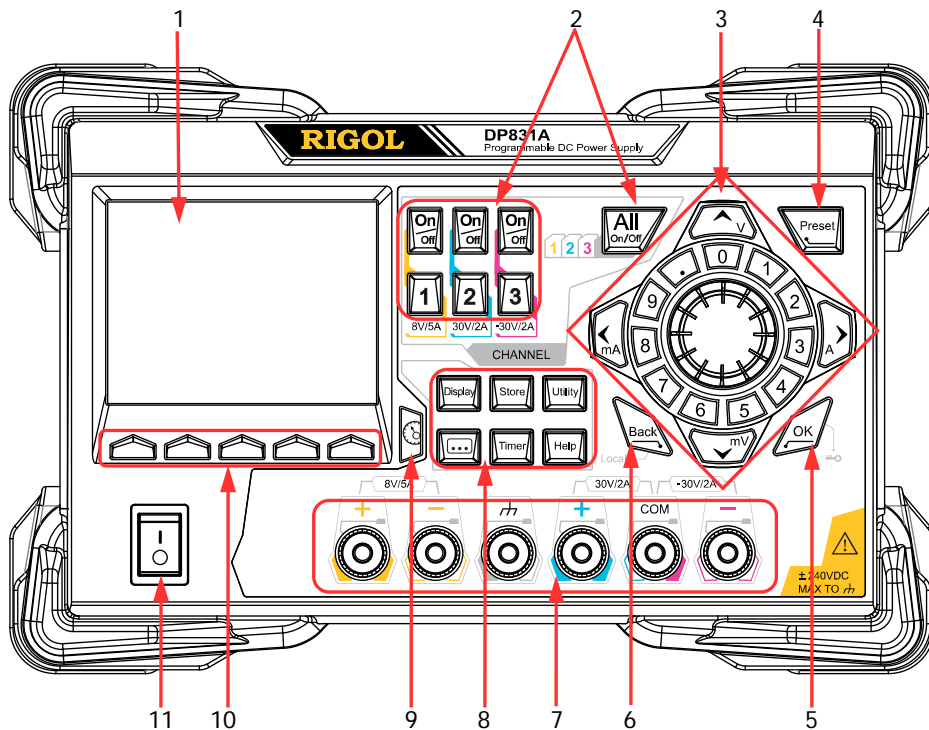

图 5 DP811A 前面板

1. LCD

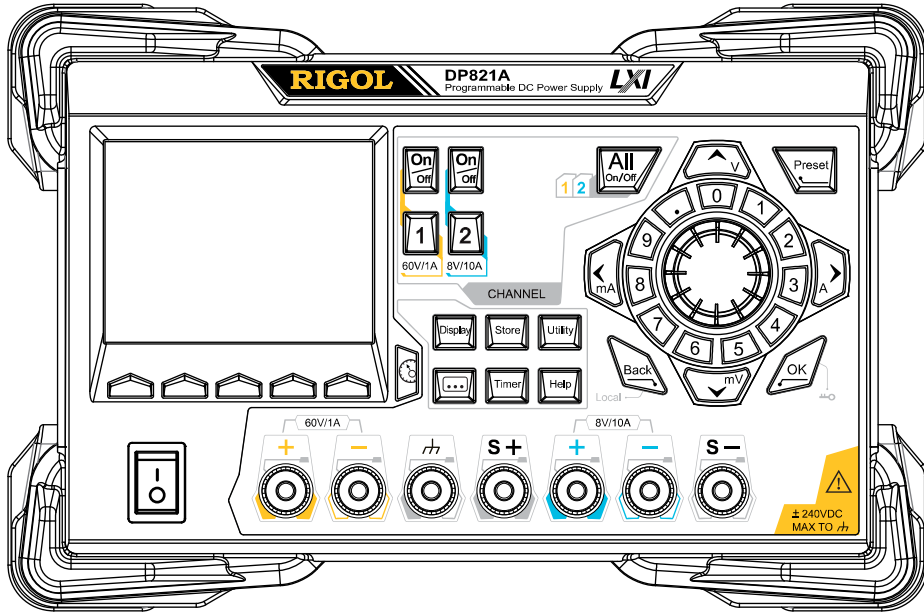
3.5 英寸的 TFT 显示屏，用于显示系统参数设置、系统输出状态、菜单选项以及提示信息等。

2. 通道（档位）选择与输出开关

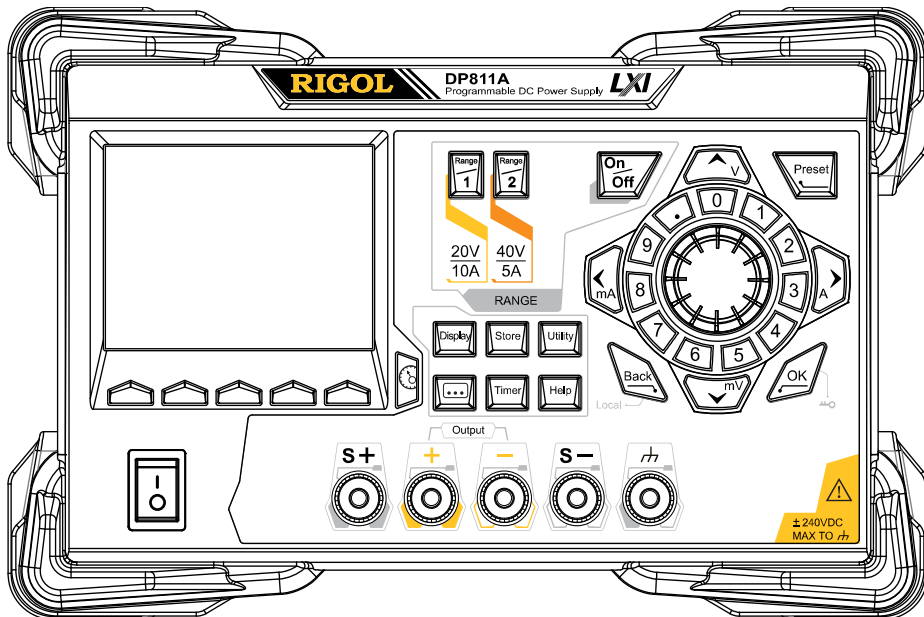
对于多通道型号，此处为通道选择与输出开关。对于单通道型号（DP811A），此处为档位选择与输出开关。

多通道型号（以 DP831A 为例）：

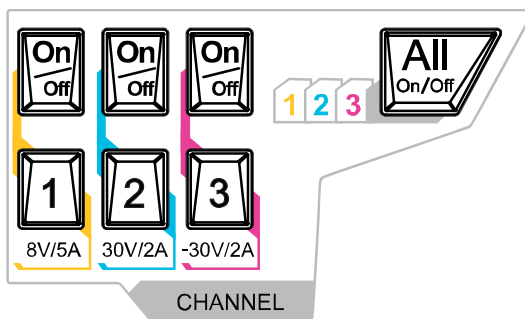

按该键，可选择通道 1 并设置该通道的电压、电流、过压/过流保护等参数。



按该键，可选择通道 2 并设置该通道的电压、电流、过压/过流保护等参数。



按该键，可选择通道 3 并设置该通道的电压、电流、过压/过流保护等参数。



按该键，可打开或关闭对应通道的输出。



按该键，仪器弹出是否打开所有通道输出的提示信息，按 **确认** 可打开所有通道的输出。再次按该键，关闭所有通道输出。

单通道型号 (DP811A):

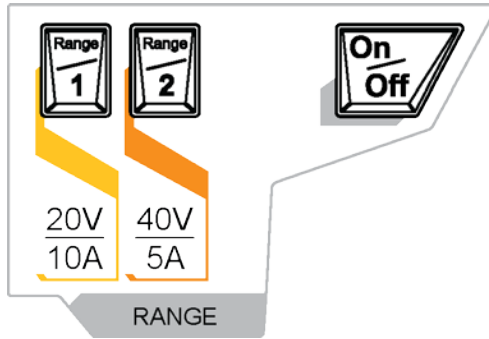

按该键，可选择 20V/10A 档位并可设置通道的电压、电流、过压/过流保护等参数。



按该键，可选择 40V/5A 档位并可设置通道的电压、电流、过压/过流保护等参数。



按该键，可打开或关闭通道的输出。

3. 参数输入区

参数输入区如下图所示，包含方向键（单位选择键）、数字键盘和旋钮。

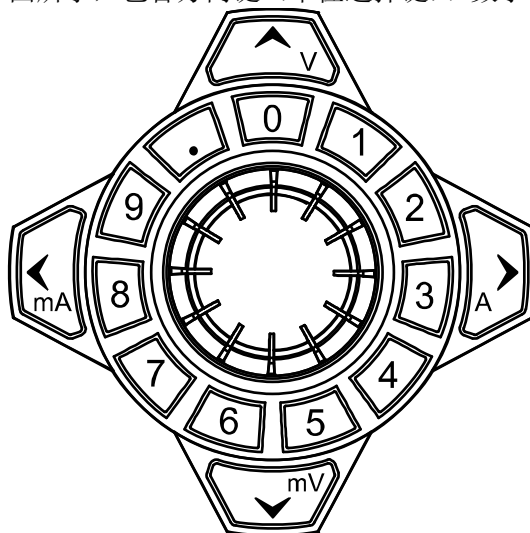

- (1) 方向键和单位选择键
方向键：可以移动光标位置。
单位选择键：使用数字键盘输入参数时，单位选择键用于选择电压单位（V 和 mV）和电流单位（A 和 mA）。
- (2) 数字键盘
圆环式数字键盘：包括数字 0-9 和小数点，按下对应的按键，可直接输入数字。
- (3) 旋钮
设置参数时，旋转旋钮可以增大或减小光标所在位的数值。
浏览设置对象（定时参数、延时参数、文件名输入等）时，旋转旋钮，可快速移动光标位置。

4. **Preset**



用于将仪器所有设置恢复为出厂默认值，或调用用户自定义的通道电压/电流配置。

5. **OK**



用于确认参数的设置。
长按该键，可锁定前面板按键，此时，除各通道对应的输出开关键  之外，前面板其他按键不可用。再次长按该键，可解除锁定。键盘锁密码打开时，解锁过程必须输入正确的密码(2012)。

6. **Back**



用于删除当前光标前的字符。
当仪器工作在远程模式时，该键用于返回本地模式。

7. 输出端子

DP800A 系列不同型号的输出端子有所不同。

DP831A:

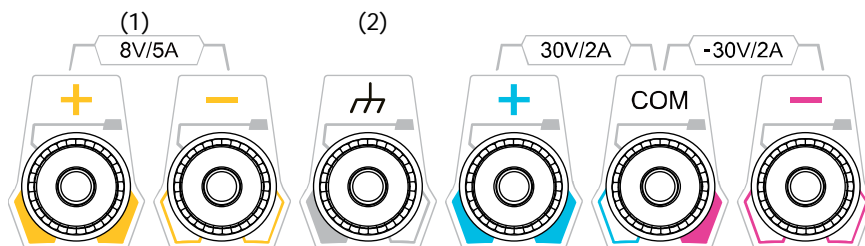

DP821A:

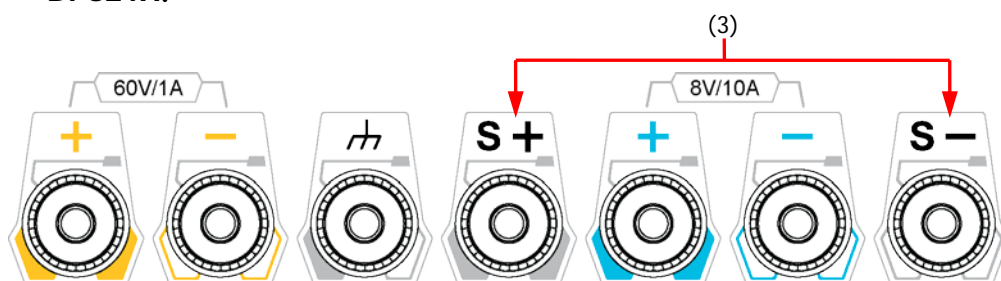

DP811A:

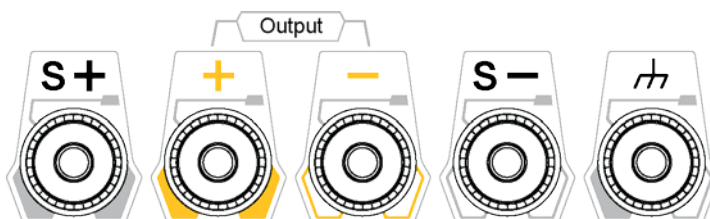

- (1) 用于输出通道的电压和电流。
- (2) 该端子与机壳、地线（电源线接地端）相连，处于接地状态。
- (3) 用于检测负载端实际电压以补偿负载引线引起的电压降。

输出端子的连接方法：

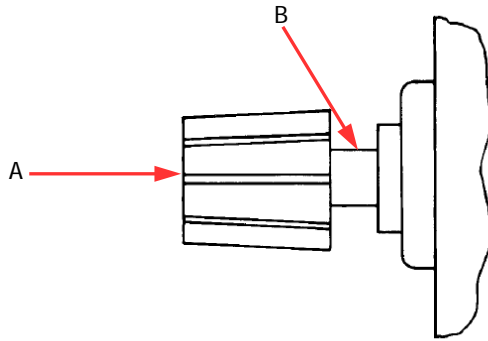

方法 1：

将测试引线与输出端子的 A 端连接。

方法 2：

逆时针旋转输出端子外层螺母，将测试引线与输出端子的 B 端连接，顺时针拧紧输出端子的外层螺母。该方法可避免由输出端子自身电阻引入的误差。

注意：将测试引线的正端与通道输出的 (+) 端连接，将测试引线的负端与通道输出的 (-) 端连接。

8. 功能菜单区

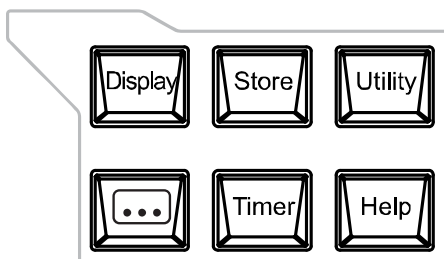

按该键进入显示参数设置界面，可设置屏幕的亮度、对比度、颜色亮度和显示模式的参数。



按该键进入文件存储与调用界面，可进行文件的保存、读取、删除、复制和粘贴等操作。存储的文件类型包括状态文件、录制文件、定时文件、延时文件和位图文件，仪器支持内外部存储与调用，外部存储支持 FAT32 文件管理系统。



按该键进入系统辅助功能设置界面，可设置远程接口参数、系统参数、打印参数等；此外，您还可以校准仪器、查看系统信息、定义 **Preset** 键的调用配置等。



按该键进入高级功能设置界面，可设置录制器、分析器、监测器和触发器的相关参数。



按该键进入定时器和延时器设置界面，可设置定时器和延时器的相关参数以及打开和关闭定时器和延时器功能。



按该键打开内置帮助系统，按下需要获得帮助的按键，可获取对应的帮助信息。详细介绍请参考“**使用内置帮助系统**”一节。

9. 显示模式切换/返回主界面



可以在当前显示模式(普通或波形)和表盘显示模式之间进行切换。此外,当仪器处于各功能界面时,按下此键可退出功能界面并返回主界面。

10. 菜单键



与其上方的菜单一一对应,按任一菜单键选择相应菜单。

11. 电源开关键



可打开或关闭仪器。

后面板

DP800A 系列各个型号的后面板如下图所示，本节以 DP831A（如图 6 和表 1 所示）为例介绍 DP800A 系列的后面板。



图 6 DP831A 后面板



图 7 DP811A 后面板

表 1 DP800A 后面板说明

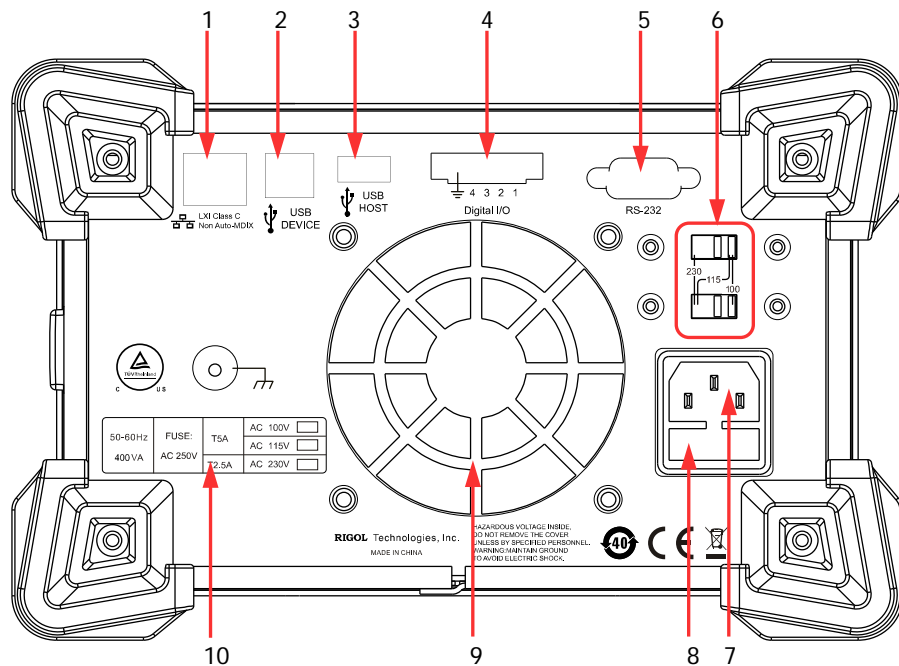
编号	名称	说明
1	LAN 接口	通过 RJ45 接口接入局域网
2	USB DEVICE	仪器作为“从设备”与外部 USB 设备（如计算机）连接
3	USB HOST	仪器作为“主设备”与外部 USB 设备（如 U 盘）连接
4	Digital I/O	数字 I/O 接口
5	RS232 接口	串行通信接口
6	电压选择器	用于选择输入电压的规格（100V、115V、230V）
7	电源插孔	交流电源输入接口
8	保险丝	不同型号的仪器或选择不同输入电压时，保险丝规格不同
9	风扇	
10	输入电源要求	输入电源的频率、电压与保险丝的对应关系
11	输出接口	仅 DP811A 提供该接口，该接口的功能与前面板“输出端子”功能相同

注意：前面板“输出端子”和后面板“输出接口”不可同时进行输出，同一时刻只能选择其中一种方式进行输出（前面板输出端子的输出精度更高）。

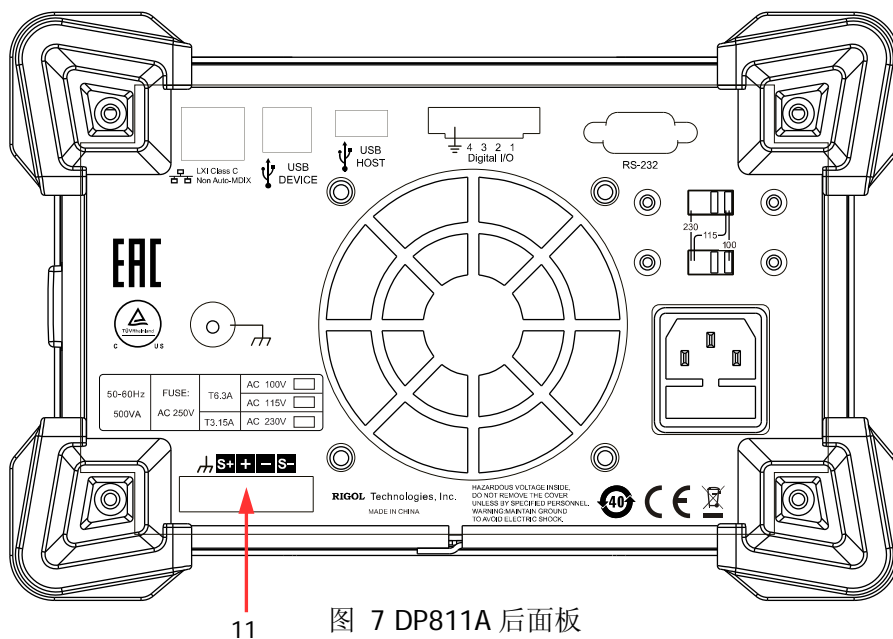
连接电源

1. 输入电源需求

DP800A 系列电源可输入频率为 50Hz–60Hz，电压为 100V、115V、230V 的 3 种规格交流电源。

2. 检查后面板电压选择器

连接电源前，请确保后面板电压选择器的设置电压与输入电压相匹配。

3. 检查保险丝

仪器出厂时，已安装合适的保险丝，请参考后面板“输入电源要求”的说明，检查保险丝与输入电压的对应关系是否正确。

4. 连接仪器电源线

请使用附件提供的电源线将仪器连接至交流电源。



警告

为避免电击，请确认仪器已经正确接地。

开机检查

按下前面板电源开关键，仪器启动并执行自检操作，若自检通过，屏幕会显示开机界面，否则，系统会提示相应的自检失败信息（包括模拟板 1、模拟板 2、风扇、温度）。

提示

关机后若再次开机，请保证与上次关机的时间间隔大于 5s。

更换保险丝

如需更换保险丝，可按如下步骤进行操作：

1. 关闭仪器，移除电源线。
2. 使用小一字螺丝刀插入电源插口处的凹槽，轻轻撬出保险丝座。

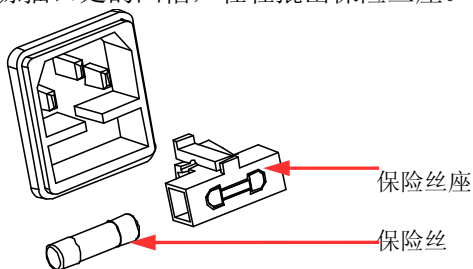

3. 手动调节电源电压选择器，选择正确的电压档位。
4. 取出保险丝，更换指定规格的保险丝（输入电压与保险丝规格的对应关系，请参考仪器后面板“输入电源要求”的说明）。



警告

为避免人身伤害，更换保险丝前，请先切断电源；为避免电击或火灾，连接电源之前，请选择合适的电源规格，并更换该规格下的保险丝。

用户界面

DP800A 系列电源提供三种显示模式：普通显示模式、波形显示模式和表盘显示模式。默认为普通显示模式，按 **Display** → **显示模式**，选择“波形”或“表盘”可切换为波形显示模式或表盘显示模式。本节以 DP831A 为例介绍普通显示模式下的用户界面的布局，如图 8 和表 2 所示。



图 8 DP831A 用户界面（普通显示模式）



图 9 DP821A 用户界面（普通显示模式）

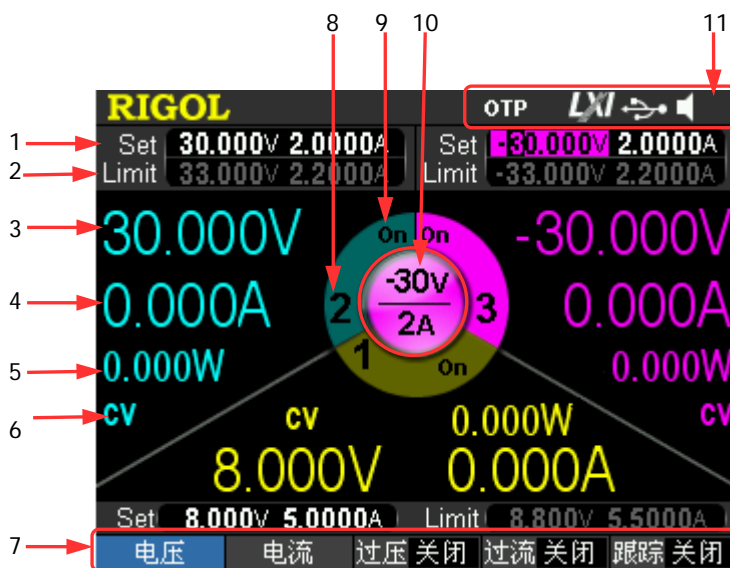

图 10 DP811A 用户界面（普通显示模式）

表 2 DP800A 用户界面说明

1	电压、电流设置值
2	过压、过流保护设置值
3	实际输出电压
4	实际输出电流
5	实际输出功率
6	通道输出模式
7	菜单栏
8	通道编号
9	通道输出状态
10	当前选中通道
11	<p>状态栏，显示系统状态标志。</p> <p>OTP：打开过温保护。</p> <p>：前面板已锁定。</p> <p>：网络已连接。</p> <p>：已识别 USB 设备。</p> <p>：打开蜂鸣器。</p> <p>：关闭蜂鸣器。</p> <p>：仪器工作在远程模式。</p>

使用内置帮助系统

内置帮助系统提供前面板任意按键（除参数输入区）及菜单键的帮助信息，方便用户快速获取功能按键或菜单的功能提示。

获得任一按键的帮助信息

按 **Help** 键将其点亮，按需要帮助的按键，即可获得相应的帮助信息，同时 **Help** 键背灯熄灭。按  退出帮助系统。

内置帮助界面

按 **Help** 键将其点亮，再次按 **Help** 键可打开如下图所示内置帮助界面。按上下方向键选择所需的帮助主题后，按 **查看** 可查看相应的帮助信息。



图 11 内置帮助系统

故障处理

本仪器在使用过程中可能出现如下故障，请首先按照下述方法处理，如果故障依然存在，请与**RIGOL**联系，同时请提供您仪器的设备信息（获取方法：**Utility** → **系统信息**）。

1. 仪器无法开机。

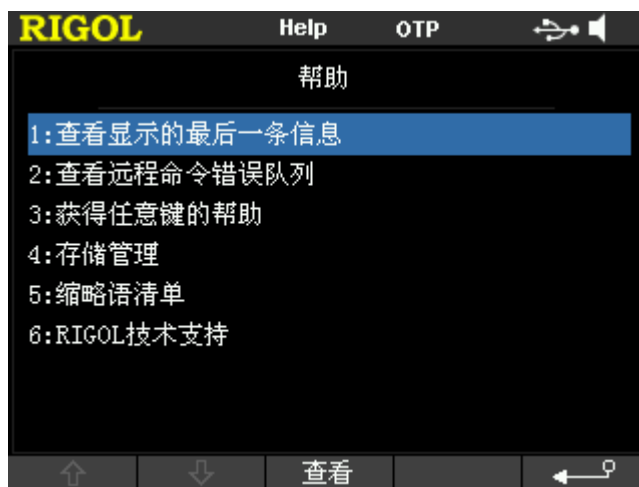
- (1) 检查电源线是否已正确连接。
- (2) 检查前面板电源开关键是否打开。
- (3) 拔掉电源线，检查电压选择器（Voltage Selector）是否处在正确的档位，保险丝的规格是否正确及是否完好无损。如需更换保险丝，请参考“**更换保险丝**”。
- (4) 如果故障仍然存在，请与**RIGOL**联系。

2. 恒压输出不正常。

- (1) 检查所选档位的最大输出功率是否满足负载要求。若满足，请进行下一步。
- (2) 连接负载与电源的线缆是否有短路现象，是否接触良好。
- (3) 查看负载是否出现问题。
- (4) 查看该档位的电流设置值是否合适，如果过低，可以适当加大电流设置值。
- (5) 若问题仍无法解决，请与**RIGOL**联系。

3. 恒流输出不正常。

- (1) 检查所选档位的最大输出功率是否满足负载要求。若满足，请进行下一步。
- (2) 连接负载与电源的线缆是否有断路现象，是否接触良好。
- (3) 查看负载是否出现问题。
- (4) 查看该档位的电压设置值是否合适，如果过低，可以适当加大电压设置值。
- (5) 若问题仍无法解决，请与**RIGOL**联系。

4. 无法正确识别U盘。

- (1) 检查U盘是否可以正常工作。
- (2) 确认使用的为闪存型U盘，本仪器不支持硬盘型U盘。
- (3) 重新启动仪器后，再插入U盘进行检查。
- (4) 如果仍然无法正常使用U盘，请与**RIGOL**联系。

RIGOL

Quick Guide

DP800A Series Programmable Linear DC Power Supply

**Aug. 2013
RIGOL Technologies, Inc.**

Guaranty and Declaration

Copyright

© 2012 RIGOL Technologies, Inc. All Rights Reserved.

Trademark Information

RIGOL is a registered trademark of RIGOL Technologies, Inc.

Publication Number

QGH03104-1110

Notices

- **RIGOL** products are protected by patent law in and outside of P.R.C.
- **RIGOL** reserves the right to modify or change parts of or all the specifications and pricing policies at company's sole decision.
- Information in this publication replaces all previously corresponding material.
- **RIGOL** shall not be liable for losses caused by either incidental or consequential in connection with the furnishing, use or performance of this manual as well as any information contained.
- Any part of this document is forbidden to be copied or photocopied or rearranged without prior written approval of **RIGOL**.

Product Certification

RIGOL guarantees this product conforms to the national and industrial standards in China as well as the ISO9001:2008 standard and the ISO14001:2004 standard. Other international standard conformance certification is in progress.

Contact Us

If you have any problem or requirement when using our products or this manual, please contact **RIGOL**.

E-mail: service@rigol.com

Website: www.rigol.com

Safety Requirement

General Safety Summary

Please review the following safety precautions carefully before putting the instrument into operation so as to avoid any personal injuries or damages to the instrument and any product connected to it. To prevent potential hazards, please use the instrument only specified by this manual.

Use Proper Power Cord.

Only the power cord designed for the instrument and authorized by local country could be used.

Ground The Instrument.

The instrument is grounded through the Protective Earth lead of the power cord. To avoid electric shock, it is essential to connect the earth terminal of power cord to the Protective Earth terminal before any inputs or outputs.

Observe All Terminal Ratings.

To avoid fire or shock hazard, observe all ratings and markers on the instrument and check your manual for more information about ratings before connecting.

Use Proper Overvoltage Protection.

Make sure that no overvoltage (such as that caused by a thunderstorm) can reach the product, or else the operator might expose to danger of electrical shock.

Do Not Operate Without Covers.

Do not operate the instrument with covers or panels removed.

Use Proper Fuse.

Please use the specified fuses.

Avoid Circuit or Wire Exposure.

Do not touch exposed junctions and components when the unit is powered.

Do Not Operate With Suspected Failures.

If you suspect damage occurs to the instrument, have it inspected by qualified service personnel before further operations. Any maintenance, adjustment or replacement especially to circuits or accessories must be performed by **RIGOL** authorized personnel.

Keep Well Ventilation.

Inadequate ventilation may cause increasing of temperature or damages to the device. So please keep well ventilated and inspect the intake and fan regularly.

Do Not Operate in Wet Conditions.

In order to avoid short circuiting to the interior of the device or electric shock, please do not operate in a humid environment.

Do Not Operate in an Explosive Atmosphere.

In order to avoid damages to the device or personal injuries, it is important to operate the device away from an explosive atmosphere.

Keep Product Surfaces Clean and Dry.

To avoid the influence of dust and/or moisture in air, please keep the surface of device clean and dry.

Electrostatic Prevention.

Operate in an electrostatic discharge protective area environment to avoid damages induced by static discharges. Always ground both the internal and external conductors of the cable to release static before connecting.

Handling Safety.

Please handle with care during transportation to avoid damages to buttons, knob interfaces and other parts on the panels.

Safety Terms and Symbols

Terms in this Manual. These terms may appear in this manual:



WARNING

Warning statements indicate the conditions or practices that could result in injury or loss of life.



CAUTION

Caution statements indicate the conditions or practices that could result in damage to this product or other property.

Terms on the Product. These terms may appear on the Product:

- DANGER** indicates an injury or hazard may immediately happen.
- WARNING** indicates an injury or hazard may be accessible potentially.
- CAUTION** indicates a potential damage to the instrument or other property might occur.

Symbols on the Product. These symbols may appear on the product:



Hazardous Voltage



Safety Warning



Protective Earth Terminal



Chassis Ground



Test Ground

General Care and Cleaning

General Care:

Do not store or leave the instrument in where the instrument will be exposed to direct sunlight for long periods of time.

Cleaning:

Clean the instrument regularly according to its operating conditions. To clean the exterior surface, perform the following steps:

1. Disconnect the instrument from all power sources.
2. Clean the loose dust on the outside of the instrument with a lint- free cloth (with a mild detergent or water). When cleaning the LCD, take care to avoid scarifying it.



CAUTION

To avoid damages to the instrument, do not expose them to liquids which have causticity.



WARNING

To avoid injury resulting from short circuit, make sure the instrument is completely dry before reconnecting to a power source.

Environmental Considerations

The following symbol indicates that this product complies with the applicable European Union requirements according to Directives 2002/96/EC on waste electrical and electronic equipment (WEEE) and batteries.



Product End-of-Life Handling

The equipment may contain substances that could be harmful to the environment or human health. In order to avoid release of such substances into the environment and harm to human health, we encourage you to recycle this product in an appropriate system that will ensure that most of the materials are reused or recycled appropriately. Please contact your local authorities for disposal or recycling information.

Document Overview

This manual is used to guide users to quickly understand the front panel, rear panel, user interface and basic operating methods of DP800A series programmable linear DC power supply. You can download the newest version of this manual from www.rigol.com.

Format Conventions in this Manual

1 Buttons

The function key at the front panel is denoted by the format of “Button Name (Bold) + Text Box” in the manual, for example, **Utility** denotes the “System Auxiliary Function Setting” key.

2 Menu

The menu item is denoted by the format of “Menu Word (Bold) + Character Shading” in the manual, for example, **Sys Info** denotes the “System Information” item under **Utility**.

3 Operation Steps

The next step of the operation is denoted by an arrow “→” in the manual. For example, **Utility** → **System** denotes pressing **Utility** at the front panel and then pressing **System**.

Content Conventions in this Manual

DP800A series programmable linear DC power supply includes the following models. In this manual, DP831A is taken as an example to illustrate the functions and operating methods of DP800A series.

Model	Channel	Channel Output Voltage/Current
DP831A	3	8V/5A, 30V/2A, -30V/2A
DP832A	3	30V/3A, 30V/3A, 5V/3A
DP821A	2	60V/1A, 8V/10A
DP811A	1	20V/10A (Range 1), 40V/5A (Range 2)

Contents

Guaranty and Declaration	I
Safety Requirement	II
General Safety Summary	II
Safety Terms and Symbols	IV
General Care and Cleaning	V
Environmental Considerations	V
Document Overview	VI
Quick Start	1
General Inspection	1
Appearance and Dimensions	2
Front Panel	3
Rear Panel	13
To Connect to Power	15
Power-on Inspection	15
To Replace the Fuse	16
User Interface	17
To Use the Built-in Help System	19
Troubleshooting	20

Quick Start

General Inspection

1. **Inspect the shipping container for damage**

Keep the damaged shipping container or cushioning material until the contents of the shipment have been checked for completeness and the instrument has passed both electrical and mechanical tests.

The consigner or carrier shall be liable for the damage to instrument resulting from shipment. **RIGOL** would not be responsible for free maintenance/rework or replacement of the unit.

2. **Inspect the instrument**

In case of any damage, or defect, or failure, notify your **RIGOL** sales representative.

3. **Check the accessories**

Please check the accessories according to the packing lists. If the accessories are incomplete or damaged, please contact your **RIGOL** sales representative.

Appearance and Dimensions

For DP800A series, the dimensions of all models are same. But the design of the front and rear panels are not exactly the same (about the differences, please refer to “**Front Panel**” and “**Rear Panel**”). In this section, DP831A is taken as an example to introduce the appearance and dimensions of DP800A series (as shown in Figure 1 and Figure 2).

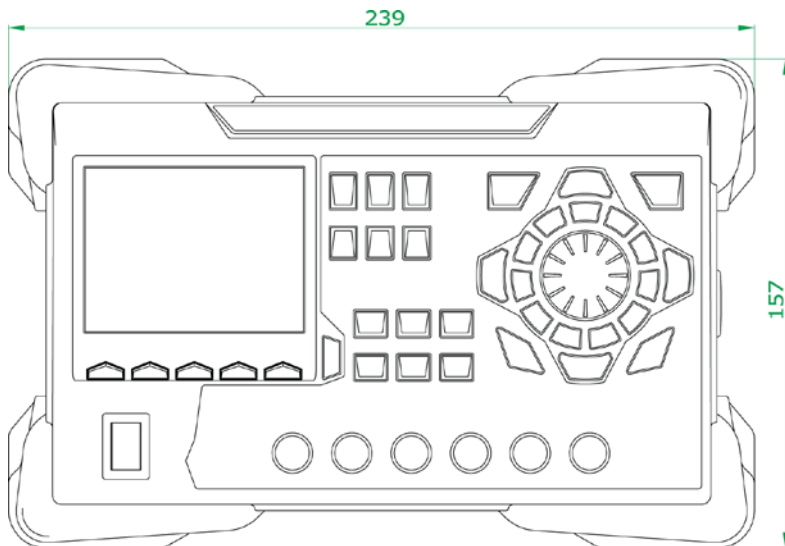

Unit: mm

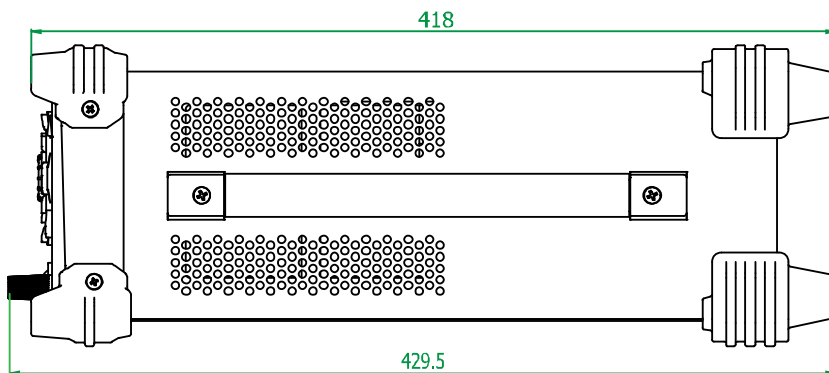

Unit: mm

Front Panel

The front panels of different models of DP800A series are shown in the figures below. In this section, DP831A (as shown in Figure 3) is taken as an example to introduce the front panels of DP800A series.

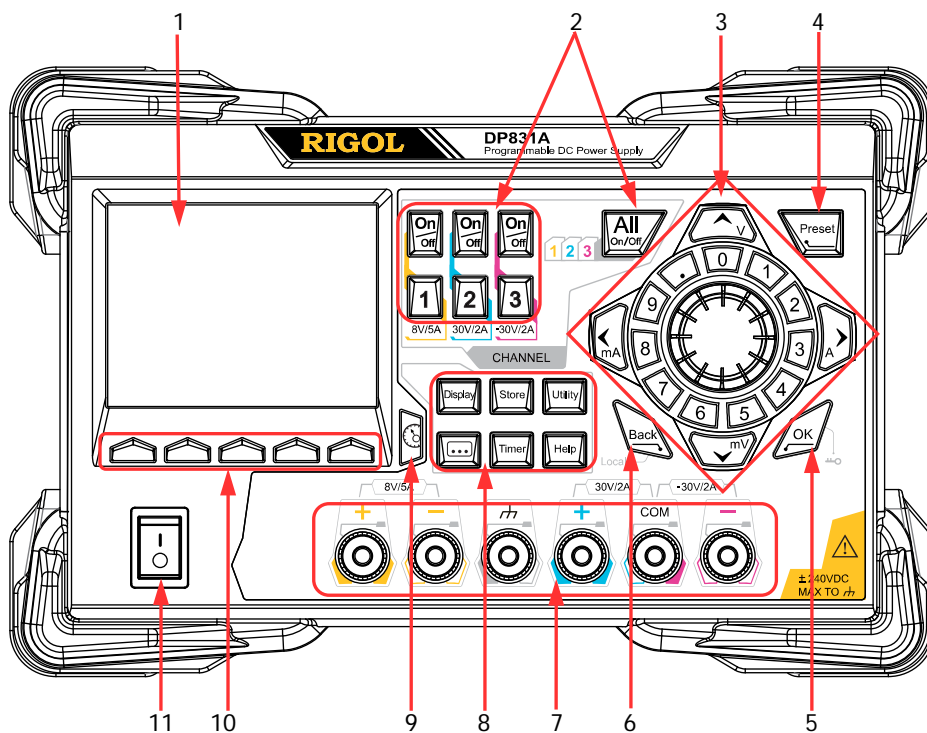

Figure 3 DP831A Front Panel

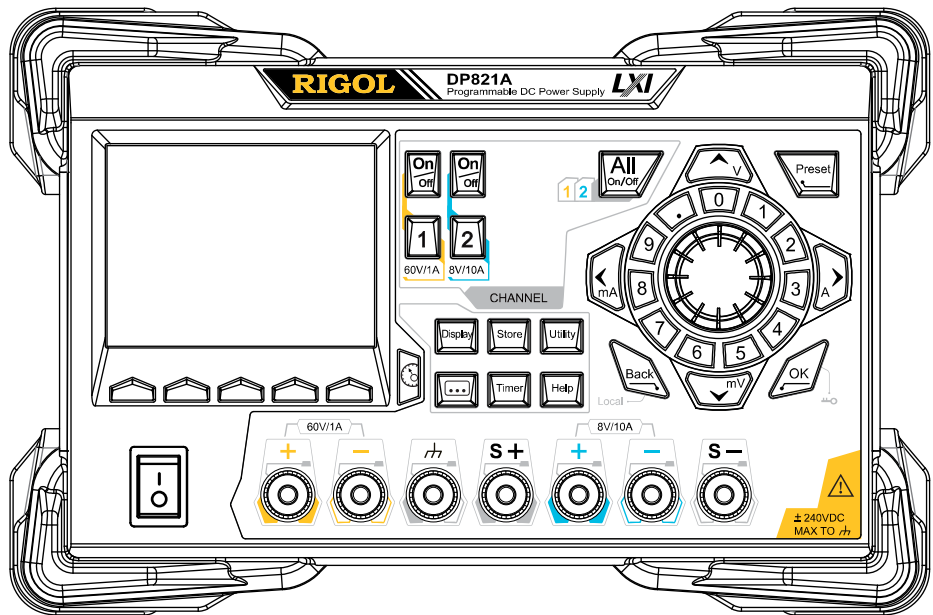

Figure 4 DP821A Front Panel

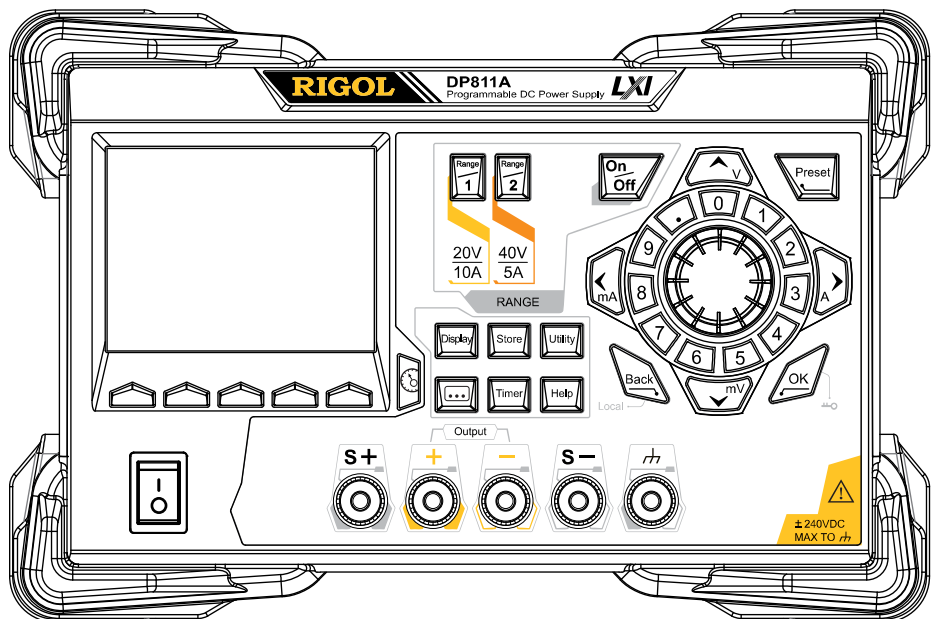

Figure 5 DP811A Front Panel

1. LCD

3.5 inches TFT display. It is used to display system parameter settings, system output state, menu options, prompt messages, etc.

2. Channel (Range) Selection and Output Switch

For the multi-channel model, the function of this part is channel selection and output switch. For the single channel model (DP811A), the function of this part is range selection and output switch.

Multi-channel Model (takes DP831A as the example):

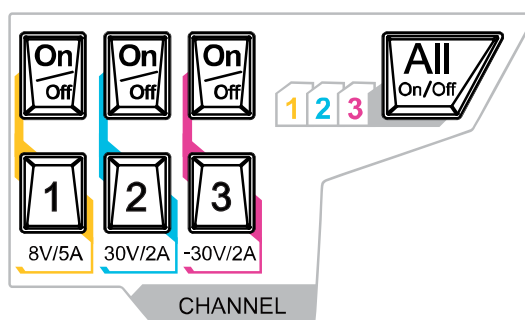

Press this key to select CH1 and set the parameters of this channel, such as voltage, current and overvoltage/overcurrent protection.



Press this key to select CH2 and set the parameters of this channel, such as voltage, current and overvoltage/overcurrent protection.



Press this key to select CH3 and set the parameters of this channel, such as voltage, current and overvoltage/overcurrent protection.



Press this key to enable or disable the output of the corresponding channel.



Press this key and the prompt message asking whether to enable the outputs of all the channels will be displayed. Press **OK** to enable the outputs of all the channels. Press this key again to disable the outputs of all the channels.

Single Channel Model (DP811A):

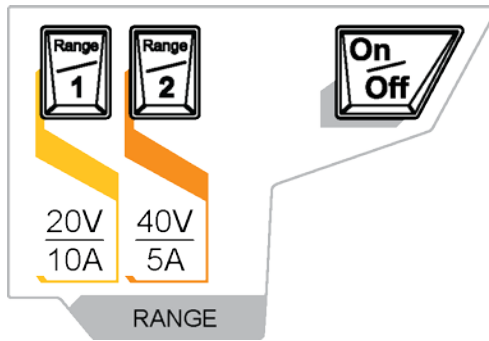

Press this key to select the 20V/10A range. Users can set the parameters of the channel, such as voltage, current and overvoltage/overcurrent protection.



Press this key to select the 40V/5A range. Users can set the parameters of the channel, such as voltage, current and overvoltage/overcurrent protection.



Press this key to enable or disable the output of the channel.

3. Parameter Input Area

The parameter input area is as shown in the figure below. This area includes the direction keys (unit selection keys), numeric keyboard and knob.

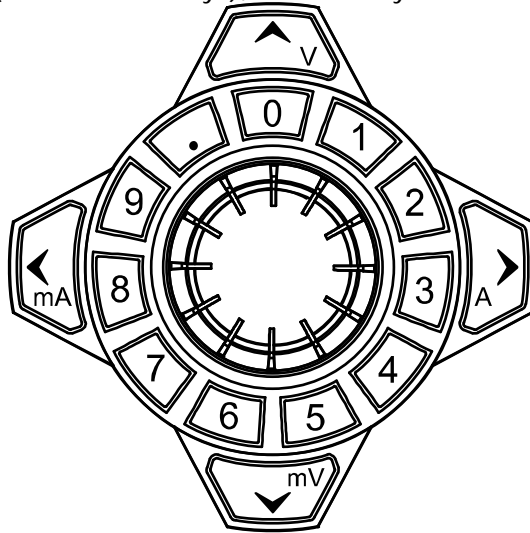

- (1) Direction keys and unit selection keys
Direction keys: move the cursor.
Unit selection keys: when using the numeric keyboard to input parameters, the keys are used to select the voltage units (V and mV) and the current units (A and mA).
- (2) Numeric Keyboard
Ring-type numeric keyboard: includes numbers 0-9 and the decimal point.
Press the corresponding key to input the number.
- (3) Knob
When setting parameters, rotate the knob to increase or decrease the value of the digit at the cursor.
When browsing the setting objects (timing parameters, delay parameters, filename input, etc.), rotate the knob to quickly move the cursor.

4. **Preset**



Restore all the settings of the instrument to default values or recall the user-defined channel voltage/current configurations.

5. **OK**



Confirm the parameter setting.
Press and hold this key to lock the front panel keys; at this point, the front panel keys (except the output on/off key  of each channel) are not available. Press and hold this key again to unlock the front panel keys. When the keyboard lock password is enabled, users need to input the correct password (2012) to unlock the front panel keys.

6. **Back**



Delete the character currently before the cursor.
When the instrument is in remote mode, press this key to return to local mode.

7. Output Terminals

For DP800A series, the output terminals of different models are not exactly the same.

DP831A:

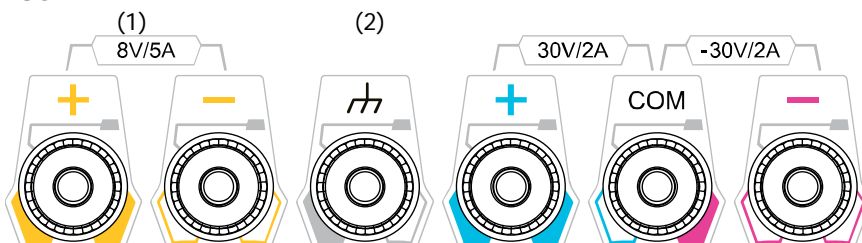

DP821A:

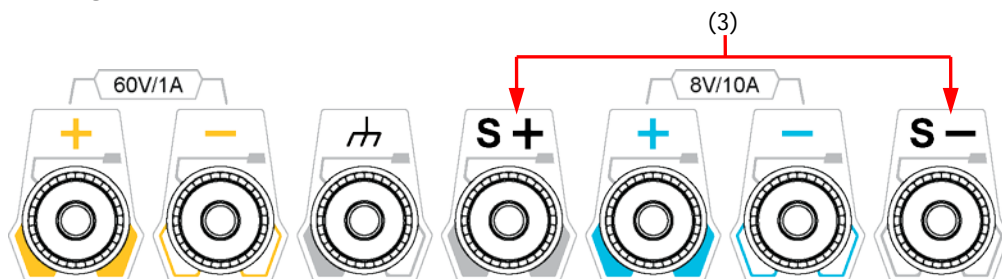

DP811A:

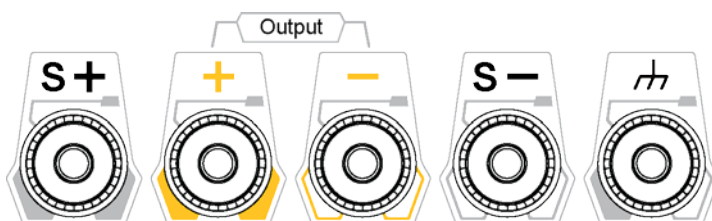

- (1) Used to output the voltage and current of the channel.
- (2) This terminal is connected to the instrument chassis and ground wire (power cord ground terminal) and is in grounded state.
- (3) Used to sense the actual voltage at the load to compensate the voltage drop caused by the leads between the power supply and the load.

Connection methods of the output terminal:

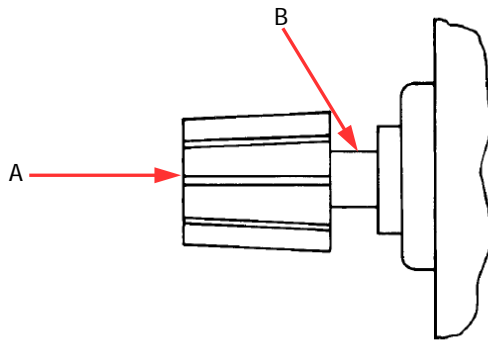

Method 1:

Connect the test lead to A of the output terminal.

Method 2:

Rotate the outer nut of the output terminal counterclockwise and connect the test lead to B of the output terminal; then, rotate the outer nut of the output terminal clockwise. This connection method can eliminate the error caused by the resistance of the output terminal.

Note: Connect the positive terminal of the test lead with the (+) terminal of the channel output and connect the negative terminal of the test lead with the (-) terminal of the channel output.

8. Function Menu Area

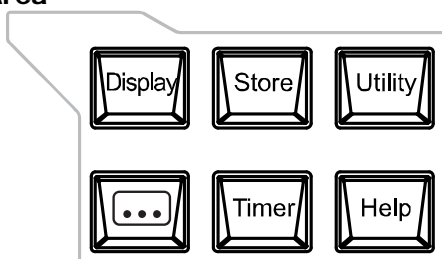

Press this key to enter the display parameter setting interface. Users can set the brightness, contrast, RGB luminosity and display mode.



Press this key to enter the file store and recall interface. You can save, read, delete, copy and paste files. The file types available for storage include state file, record file, timer file, delayer file and bitmap file. The instrument supports internal and external storage and recall. Wherein, external storage supports FAT32 file management system.



Press this key to enter the system auxiliary function setting interface. Users can set the remote interface parameters, system parameters and print parameters. Besides, users can also calibrate the instrument, view system information and define the recall configuration of **Preset**.



Press this key to enter the advanced function setting interface. Users can set the recorder, analyzer, monitor and trigger parameters.



Press this key to enter the timer and delayer setting interface. Users can set the timer and delayer parameters as well as turn on or off the timer and delayer.



Press this key to open the built-in help system and press the desired key to get the corresponding help information. For detailed introductions, refer to **"To Use the Built-in Help System"**.

9. Display Mode Switch/Return to the Main Interface



Switch between the current display (normal or waveform) mode and dial display mode. Besides, in various function interfaces, press this key to exit the current interface and return to the main interface.

10. Menu Keys



The menu keys correspond to the menus above them. Press any menu key to select the corresponding menu.

11. Power Switch Key



Turn on or off the instrument.

Rear Panel

The rear panels of the various models of DP800A series are as shown in the figures below. In this section, DP831A (as shown in Figure 6 and Table 1) is taken as an example to introduce the rear panels of DP800A series.

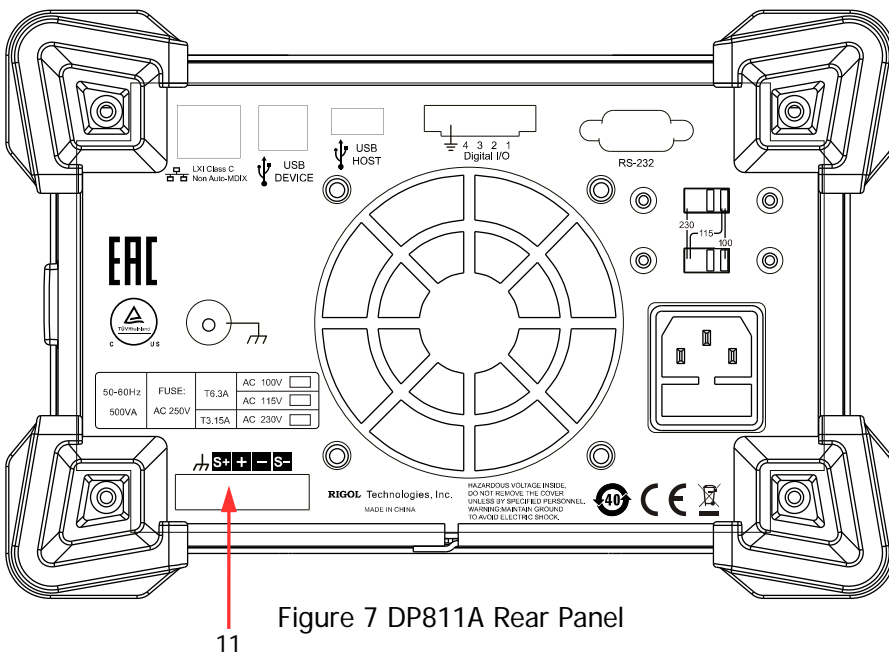
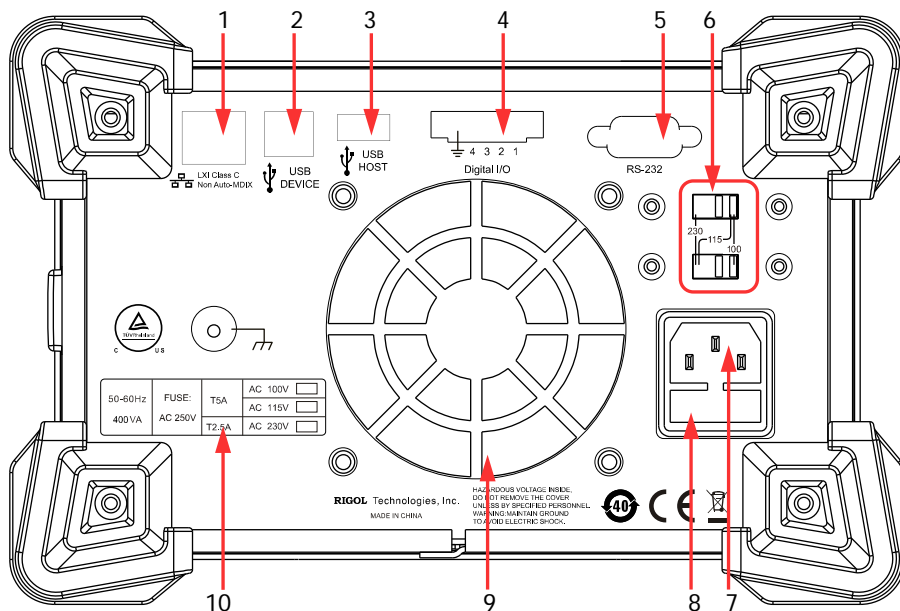

Table 1 DP800A Rear Panel Explanation

No.	Name	Explanation
1	LAN Interface	Connect to the local network via the RJ45 interface
2	USB DEVICE	Connect the instrument (as "slave" device) to external USB device (such as, PC)
3	USB HOST	Connect the instrument (as "host" device) to external USB device (such as, USB storage device)
4	Digital I/O	Digital I/O interface
5	RS232 Interface	Serial communication interface
6	Voltage Selector	Select the specification of the input voltage (100V, 115V, 230V)
7	Power Socket	AC power input interface
8	Fuse	For different models of instrument or when different input voltages are selected, the specifications of the fuses are different
9	Fan	
10	Input Power Requirement	Corresponding relations of the input power frequency, voltage and fuse
11	Output Interface	Only DP811A provides this interface which has the same function as that of the " Output Terminals " at the front panel

Note: The "Output Terminals" at the front panel and the "Output Interface" at the rear panel cannot output at the same time. Only one of the two can be selected to output at any one time (the "Output Terminals" at the front panel has higher accuracy).

To Connect to Power

1. Input power requirement

DP800A series power supply can accept three kinds of AC power supplies: 50Hz–60Hz frequency; 100V, 115V and 230V voltages.

2. Check the voltage selector at the rear panel

Before connecting to power, make sure that the setting voltage of the voltage selector at the rear panel matches the input voltage.

3. Check the fuse

When the instrument leaves factory, proper fuse is installed. Please check whether the fuse matches the input voltage according to the “Input Power Requirement” at the rear panel.

4. Connect the instrument power cord

Connect the instrument to AC power supply using the power cord provided in the accessories.



WARNING

To avoid electric shock, make sure that the instrument is correctly grounded.

Power-on Inspection

Press the power switch at the front panel and the instrument executes self-test. If the instrument passes the self-test, the welcome interface will be displayed; otherwise, the corresponding self-test failure information (including TopBoard, BottomBoard, Fan and Temperature) will be displayed.

Tip

When turn the instrument on again after turn it off, please make sure the time between the two operations are larger than 5s.

To Replace the Fuse

To replace the fuse, follow the steps below.

1. Turn off the instrument and remove the power cord.
2. Insert a small straight screwdriver into the slot at the power socket and prize out the fuse seat gently.

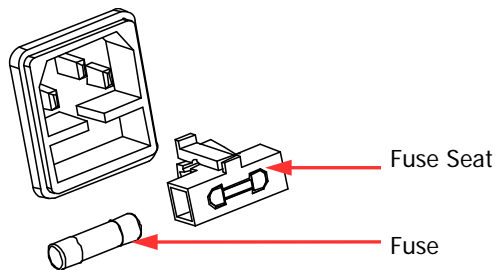

3. Adjust the power voltage selector manually to select the correct voltage scale.
4. Take out the fuse and replace it with a specified fuse (for the corresponding relations between the input voltage and fuse specification, refer to the "Input Power Requirement" at the rear panel).



WARNING

To avoid personal injuries, cut off the power supply before replacing the fuse; to avoid electric shock or fire, select the proper power supply specification and replace a fuse corresponding to this specification before connecting to power.

User Interface

DP800A series power supply provides three kinds of display modes (normal, waveform and dial). The default is normal and press **Display** → **Disp Mode** to set the display mode to “Waveform” or “Dial”. In this section, DP831A is taken as an example to introduce the interface layout under the normal display mode (as shown in Figure 8 and Table 2).

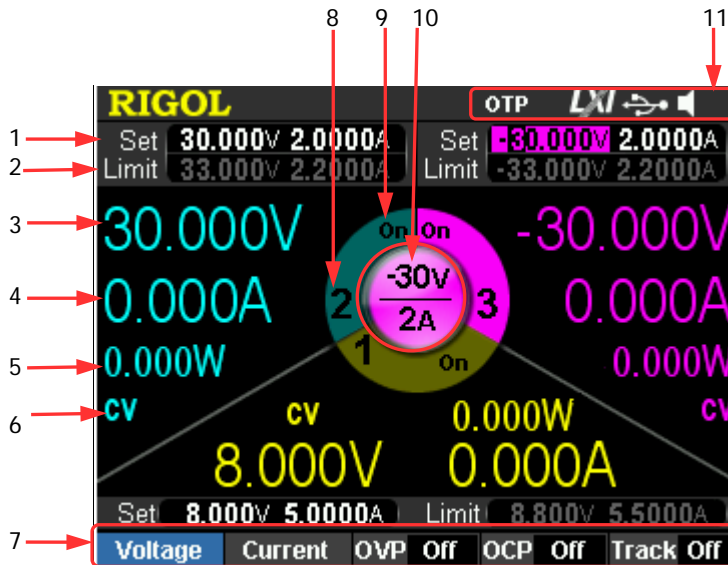

Figure 8 DP831A User Interface (Normal)

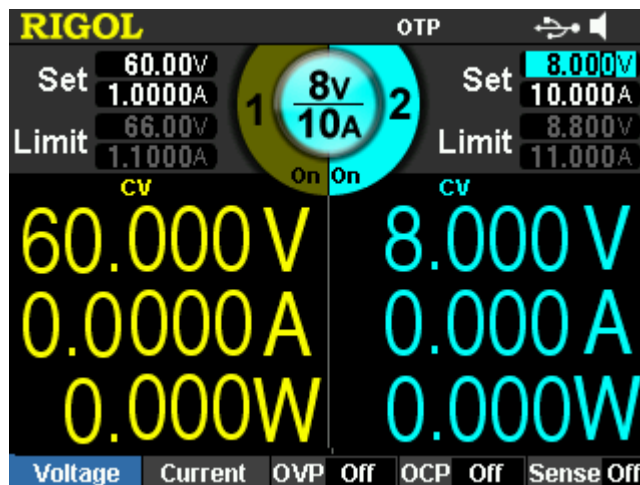







Figure 9 DP821A User Interface (Normal)



Figure 10 DP811A User Interface (Normal)

Table 2 DP800A User Interface Explanation

1	Voltage and current setting values
2	Overvoltage and overcurrent protection setting values
3	Actual output voltage
4	Actual output current
5	Actual output power
6	Channel output mode
7	Menu bar
8	Channel number
9	Channel output status
10	Channel currently selected
11	Status bar, display the system status indicators. OTP : over-temperature protection is enabled.  : the front panel is locked.  : LAN is connected successfully.  : USB device is recognized.  : system sound is enabled.  : system sound is disabled.  : remote control is connected

To Use the Built-in Help System

The built-in help system provides help information for any front panel key (except the parameter input area) and menu keys for users to quickly obtain the function prompts of the function keys or menus.

Obtain the help information of any key

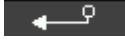
Press **Help** to illuminate it and press the desired key to get the corresponding help information; at the same time, the backlight of **Help** goes off. Press  to exit the help system.

Built-in help interface

Press **Help** to illuminate it and press **Help** again to open the built-in help interface as shown in the figure below. Press the up/down direction keys to select the desired help topic and press **View** to view the corresponding help information.

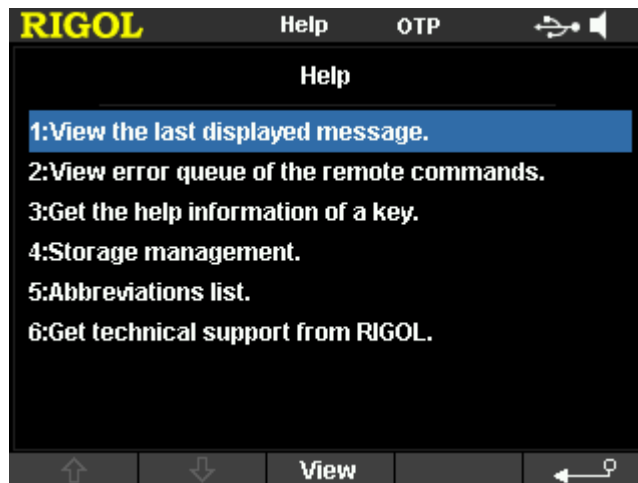

Figure 11 Built-in Help Interface

Troubleshooting

The commonly encountered failures and their solutions are listed below. When you encounter those problems, please solve them following the corresponding steps. If the problem remains still, please contact **RIGOL** and provide your device information (**Utility** → **Sys Info**).

1. The instrument can not start up.

- (1) Check whether the power is correctly connected.
- (2) Check whether the power switch at the front panel is really on.
- (3) Remove the power cord and check whether the voltage selector is at the proper scale, whether the specification of the fuse is correct and whether the fuse is intact. If the fuse needs to be changed, refer to “**To Replace the Fuse**”.
- (4) If the problem remains, please contact **RIGOL**.

2. The constant voltage output is abnormal.

- (1) Check whether the maximum output power of the scale currently selected fulfills the load requirement. If yes, go to the next step.
- (2) Check whether the cable connecting the load and power supply is short-circuited and in good contact.
- (3) Check whether the load is normal.
- (4) Check whether the current setting value of this scale is proper; if it is too low, increase it properly.
- (5) If the problem remains, please contact **RIGOL**.

3. The constant current output is abnormal.

- (1) Check whether the maximum output power of the scale currently selected fulfills the load requirement. If yes, go to the next step.
- (2) Check whether the cable connecting the load and power supply is short-circuited and in good contact.
- (3) Check whether the load is normal.
- (4) Check whether the voltage setting value of this scale is proper; if it is too low, increase it properly.
- (5) If the problem remains, please contact **RIGOL**.

4. The USB storage device can not be recognized.

- (1) Check whether the USB storage device can work normally.
- (2) Make sure that the USB storage device being used is flash storage type. This oscilloscope does not support hardware storage type.
- (3) Restart the instrument and then insert the USB storage device to check it.
- (4) If the USB storage device still can not be used normally, please contact **RIGOL**.