

# **RIGOL**

## **Quick Guide**

# **DS1000Z-E Series Digital Oscilloscope**

**Aug. 2019**

**RIGOL (SUZHOU) TECHNOLOGIES INC.**



---

# Guaranty and Declaration

## Copyright

© 2019 **RIGOL** (SUZHOU) TECHNOLOGIES INC. All Rights Reserved.

## Trademark Information

**RIGOL** is a registered trademark of **RIGOL** (SUZHOU) TECHNOLOGIES INC.

## Publication Number

QGA27100-1110

## Notices

- **RIGOL** products are covered by P.R.C. and foreign patents, issued and pending.
- **RIGOL** reserves the right to modify or change parts of or all the specifications and pricing policies at the company's sole decision.
- Information in this publication replaces all previously released materials.
- Information in this publication is subject to change without notice.
- **RIGOL** shall not be liable for either incidental or consequential losses in connection with the furnishing, use, or performance of this manual, as well as any information contained.
- Any part of this document is forbidden to be copied, photocopied, or rearranged without prior written approval of **RIGOL**.

## Product Certification

**RIGOL** guarantees that this product conforms to the national and industrial standards in China as well as the ISO9001:2015 standard and the ISO14001:2015 standard. Other international standard conformance certifications are in progress.

## Contact Us

If you have any problem or requirement when using our products or this manual, please contact **RIGOL**.

E-mail: [service@rigol.com](mailto:service@rigol.com)

Website: [www.rigol.com](http://www.rigol.com)

# Safety Requirement

## General Safety Summary

1. Only the exclusive power cord designed for the instrument and authorized for use within the local country could be used.
2. Ensure that the instrument is safely grounded.
3. Connect the probe correctly.
4. Observe all terminal ratings.
5. Use proper overvoltage protection.
6. Do not operate without covers.
7. Do not insert objects into the air outlet.
8. Use the proper fuse.
9. Avoid circuit or wire exposure.
10. Do not operate the instrument with suspected failures.
11. Provide adequate ventilation.
12. Do not operate in wet conditions.
13. Do not operate in an explosive atmosphere.
14. Keep instrument surfaces clean and dry.
15. Prevent electrostatic impact.
16. Handle with caution.

## Safety Notices and Symbols

### Safety Notices in this Manual:



#### **WARNING**

Indicates a potentially hazardous situation or practice which, if not avoided, will result in serious injury or death.



#### **CAUTION**

Indicates a potentially hazardous situation or practice which, if not avoided, could result in damage to the product or loss of important data.

### Safety Terms on the Product:

**DANGER** It calls attention to an operation, if not correctly performed, could result in injury or hazard immediately.

**WARNING** It calls attention to an operation, if not correctly performed, could result in potential injury or hazard.

**CAUTION** It calls attention to an operation, if not correctly performed, could result in damage to the product or other devices connected to the product.

### Safety Symbols on the Product:



Hazardous  
Voltage



Safety  
Warning



Protective  
Earth  
Terminal



Chassis  
Ground



Test  
Ground

## Measurement Category

### Measurement Category

DS1000Z-E series digital oscilloscopes can make measurements in Measurement Category I.



---

**WARNING**

This oscilloscope can only be used for measurements within its specified measurement categories.

---

### Measurement Category Definitions

Measurement category I is for measurements performed on circuits not directly connected to MAINS. Examples are measurements on circuits not derived from MAINS, and specially protected (internal) MAINS derived circuits. In the latter case, transient stresses are variable; for that reason, the transient withstand capability of the equipment is made known to the user.

Measurement category II is for measurements performed on circuits directly connected to the low voltage installation. Examples are measurements on household appliances, portable tools and similar equipment.

Measurement category III is for measurements performed in the building installation. Examples are measurements on distribution boards, circuit-breakers, wiring, including cables, bus-bars, junction boxes, switches, socket-outlets in the fixed installation, and equipment for industrial use and some other equipment, for example. Stationary motors with permanent connection to the fixed installation.

Measurement category IV is for measurements performed at the source of the low-voltage installation. Examples are electricity meters and measurements on primary overcurrent protection devices and ripple control units.

## Ventilation Requirement

This oscilloscope uses fan to force cooling. Please make sure that the air intake and exhaust areas are free from obstructions and have free air. When using the oscilloscope in a bench-top or rack setting, provide at least 10 cm clearance beside, above and behind the instrument for adequate ventilation.



---

**WARNING**

Inadequate ventilation may cause temperature increase which would damage the instrument. So please keep the instrument well ventilated during operation and inspect the intake and fan regularly.

---

## Working Environment

### Temperature

Operating: 0°C to +50°C

Non-operating: -40°C to +70°C

### Humidity

0°C to +30°C: ≤95% relative humidity

+30°C to +40°C: ≤75% relative humidity

+40°C to +50°C: ≤45% relative humidity



#### **WARNING**

To avoid short circuit inside the instrument or electric shock, please do not operate in humid environment.

---

### Altitude

Operating: below 3 km

Non-operating: below 15 km

### Installation (Overvoltage) Category

This product is powered by mains conforming to installation (overvoltage) category II.



#### **WARNING**

Make sure that no overvoltage (such as that caused by thunderbolt) can reach the product, or else the operator might expose to danger of electric shock.

---

### Installation (Overvoltage) Category Definitions

Installation (overvoltage) category I refers to signal level which is applicable to equipment measurement terminals connected to the source circuit. In these terminals, precautions are done to limit the transient voltage to the corresponding low level.

Installation (overvoltage) category II refers to the local power distribution level which is applicable to equipment connected to the AC line (AC power).

### Pollution Degree

Degree 2

### Pollution Degree Definitions

Pollution degree 1: No pollution or only dry, non-conductive pollution occurs. The pollution has no influence. For example: a clean room or air-conditioned office environment.

Pollution degree 2: Normally only dry, non-conductive pollution occurs. Occasionally a temporary conductivity caused by condensation may occur. For example: general indoor environment.

Pollution degree 3: Conductive pollution occurs, or dry, non-conductive pollution occurs which becomes conductive due to condensation which is expected. For example: Sheltered outdoor environment.

Pollution degree 4: Pollution that generates persistent conductivity through conductive dust, rain, or snow. For example: outdoor locations.

### **Safety Class**

Class 1 – Grounded Product

## **Care and Cleaning**

### **Care**

Do not store or leave the instrument where it may be exposed to direct sunlight for long periods of time.

### **Cleaning**

Clean the instrument regularly according to its operating conditions.

1. Disconnect the instrument from all power sources.
2. Clean the external surfaces of the instrument with a soft cloth dampened with mild detergent or water. Avoid having any water or other objects into the chassis via the heat dissipation hole. When cleaning the LCD, take care to avoid scarifying it.



### **CAUTION**

To avoid damage to the instrument, do not expose it to caustic liquids.



### **WARNING**

To avoid short-circuit resulting from moisture or personal injuries, ensure that the instrument is completely dry before connecting it to the power supply.

---

## Environmental Considerations

The following symbol indicates that this product complies with the WEEE Directive 2002/96/EC.



### Product End-of-Life Handling

The equipment may contain substances that could be harmful to the environment or human health. To avoid the release of such substances into the environment and avoid harm to human health, we recommend you to recycle this product appropriately to ensure that most materials are reused or recycled properly. Please contact your local authorities for disposal or recycling information.

## Document Overview

This manual is used to guide users to quickly get familiar with the front panel, rear panel, user interface and basic operation method of DS1000Z-E series digital oscilloscope. You can download the newest version of the manual from **RIGOL** official website ([www.rigol.com](http://www.rigol.com)).

### Format Conventions in this Manual:

#### 1. Key

The front panel keys are denoted by the format of "Key Name (Bold) + Text Box". For example, **Utility** denotes the "Utility" key.

#### 2. Menu





The menu softkeys are denoted by the format of "Menu Word (Bold) + Character Shading". For example, **System** denotes the "System" menu under **Utility**.

#### 3. Operation Step

The next step of operation is denoted by an arrow "→". For example, **Utility** → **System** denotes that first press **Utility** on the front panel and then press **System**.



#### 4. Knob

Label	Knob
<b>HORIZONTAL  SCALE</b>	Horizontal Scale Knob
<b>HORIZONTAL  POSITION</b>	Horizontal Position Knob
<b>VERTICAL  SCALE</b>	Vertical Scale Knob
<b>VERTICAL  POSITION</b>	Vertical Position Knob
<b>TRIGGER  LEVEL</b>	Trigger Level Knob

#### Content Conventions in this Manual:

DS1000Z-E series includes the following models. Unless otherwise noted, this manual takes DS1202Z-E as an example to illustrate the front panel, rear panel, user interface and basic operation methods of DS1000Z-E series.

Model	Analog Bandwidth	Number of Analog Channels
DS1202Z-E	200 MHz	2

# Contents

<b>Guaranty and Declaration .....</b>	<b>I</b>
<b>Safety Requirement .....</b>	<b>II</b>
General Safety Summary .....	II
Safety Notices and Symbols .....	II
Measurement Category .....	III
Ventilation Requirement .....	III
Working Environment .....	IV
Care and Cleaning .....	V
Environmental Considerations .....	VI
<b>Document Overview .....</b>	<b>VI</b>
<b>Quick Start .....</b>	<b>1</b>
General Inspection .....	1
Appearance and Dimensions .....	2
To Prepare for Operation .....	3
To Adjust the Supporting Legs .....	3
To Connect to AC Power Supply .....	3
Turn-on Checkout .....	4
To Connect the Probe .....	4
Function Inspection .....	5
Probe Compensation .....	6
Front Panel Overview .....	7
Rear Panel Overview .....	8
Front Panel Function Overview .....	10
VERTICAL .....	10
HORIZONTAL .....	11
TRIGGER .....	11
CLEAR .....	12
AUTO .....	12
RUN/STOP .....	12
SINGLE .....	12
Multifunction Knob .....	13
Function Menus .....	13
Print .....	14
User Interface .....	15
Parameter Setting Method .....	18
To Use the Security Lock .....	18
To Use the Built-in Help System .....	19
<b>Troubleshooting .....</b>	<b>20</b>

# Quick Start

## General Inspection

### 1. Inspect the packaging

If the packaging has been damaged, do not dispose the damaged packaging or cushioning materials until the shipment has been checked for completeness and has passed both electrical and mechanical tests.

The consigner or carrier shall be liable for the damage to the instrument resulting from shipment. **RIGOL** would not be responsible for free maintenance/rework or replacement of the instrument.

### 2. Inspect the instrument

In case of any mechanical damage, missing parts, or failure in passing the electrical and mechanical tests, contact your **RIGOL** sales representative.

### 3. Check the accessories

Please check the accessories according to the packing lists. If the accessories are damaged or incomplete, please contact your **RIGOL** sales representative.

# Appearance and Dimensions

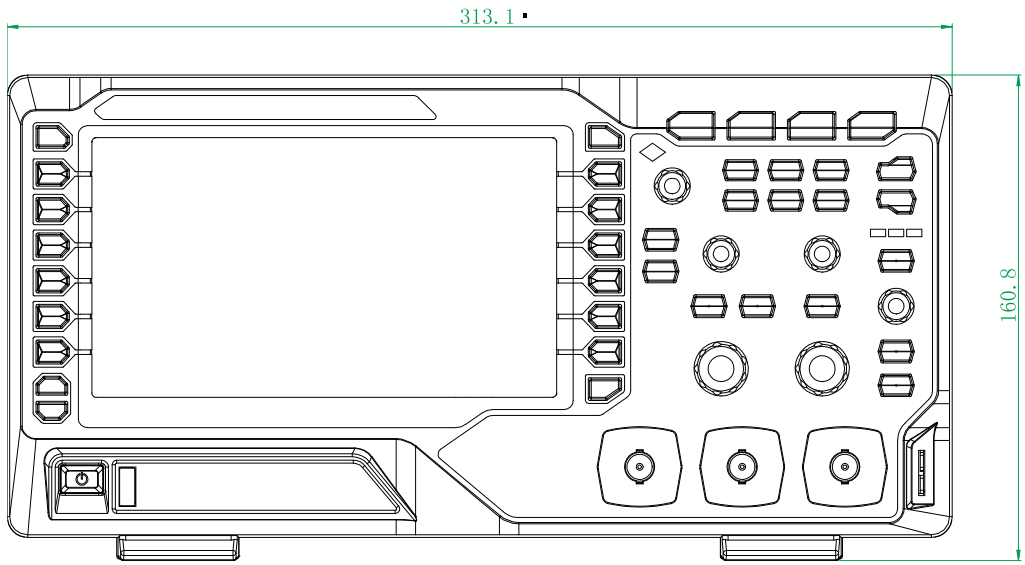

Figure 1 Front View

Unit: mm

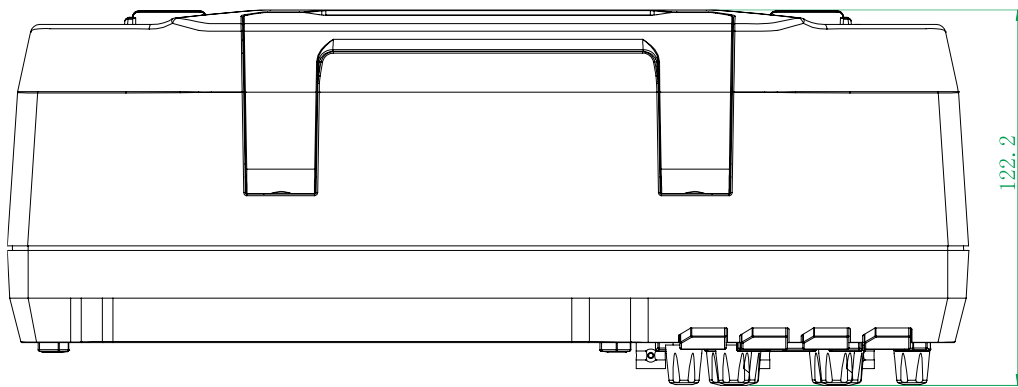

Figure 2 Top View

Unit: mm

## To Prepare for Operation

### To Adjust the Supporting Legs

Adjust the supporting legs properly to use them as stands to tilt the oscilloscope upwards for stable placement of the oscilloscope as well as better operation and observation.

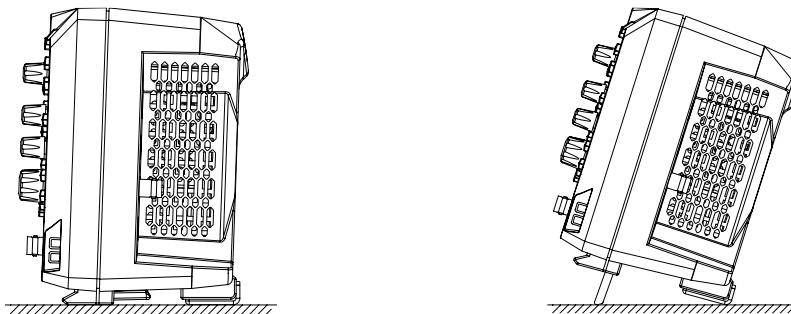

Figure 3 To Adjust the Supporting Legs

### To Connect to AC Power Supply

This oscilloscope can accept 100-240 V, 45-440 Hz AC power supply. Please use the power cord supplied with the accessories to connect the oscilloscope to the power source as shown in the figure below.

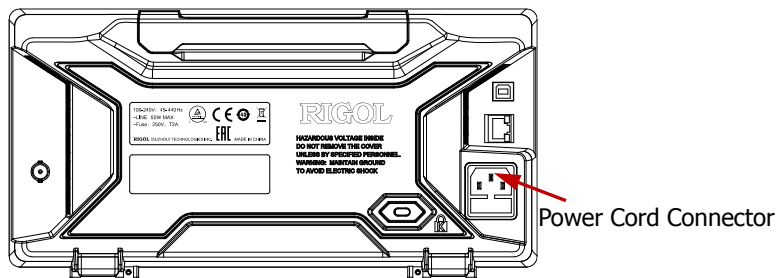



Figure 4 To Connect to AC Power Supply

## Turn-on Checkout

When the oscilloscope is connected to power, press the Power key  at the lower-left corner of the front panel to start the oscilloscope. During the start-up process, the oscilloscope performs a series of self-test items. After the self-test, the welcome screen is displayed. The instrument is installed with the trial versions of the options before leaving factory and the remaining time is about 2,000 minutes. The "Installed Options" dialog box will be displayed if your instrument has currently installed the trial versions of options. From this dialog box you can view the name, detail, version and remaining trial time of the option currently installed.

## To Connect the Probe

**RIGOL** provides passive probe for DS1000Z-E series. For the model of the probes, please refer to *DS1000Z-E Series Datasheet*. For detailed technical information of the probes, please refer to corresponding Probe User's Guide.

### Connect the Probe:

1. Connect the BNC terminal of the probe to an analog channel input of the oscilloscope on the front panel.
2. Connect the ground alligator clip of the probe to the circuit ground terminal and then connect the probe tip to the circuit point under test.

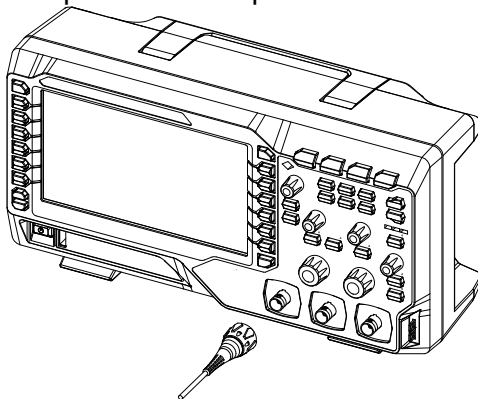

Figure 5 To Connect the Passive Probe

After you connect the passive probe, check the probe function and probe compensation adjustment before making measurements. For detailed procedures, refer to "**Function Inspection**" and "**Probe Compensation**" sections in this manual.

## Function Inspection

1. Press **Storage** → **Default** to restore the oscilloscope to its default configuration.
2. Connect the ground alligator clip of the probe to the "Ground Terminal" as shown in the figure below.
3. Use the probe to connect the input terminal of CH1 and the "Compensation Signal Output Terminal" of the oscilloscope.

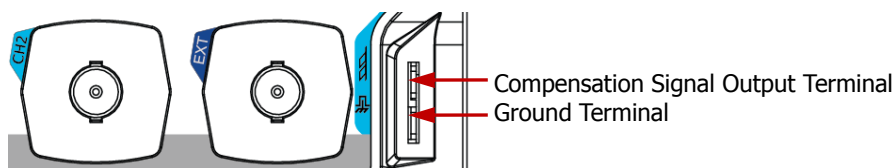

Figure 6 To Use the Compensation Signal

4. Set the attenuation on the probe to 10X. Then press **AUTO**.
5. Observe the waveform on the display. In normal condition, the display should be a square waveform as shown in the figure below:

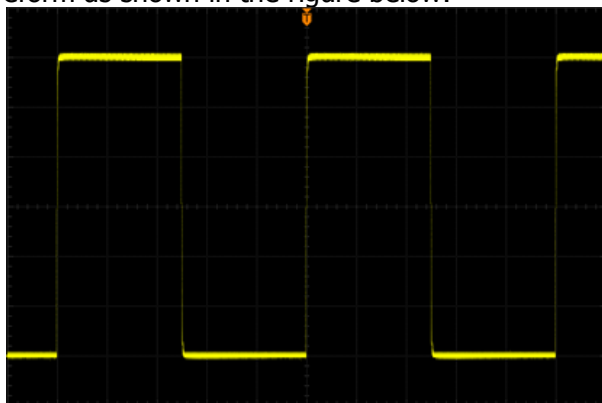

Figure 7 Square Waveform

6. Use the same method to test the other channels. If the square waveforms actually shown do not match that in the figure above, please perform "**Probe Compensation**".



### WARNING

To avoid electric shock during the use of probe, please make sure that the insulated wire of the probe is in good condition. Do not touch the metallic part of the probe when the probe is connected to high voltage source.

### Tip

The signal output from the probe compensation connector can only be used for probe compensation adjustment and cannot be used for calibration.

## Probe Compensation

When the probes are used for the first time, you should compensate the probes to match the input channels of the oscilloscope. Non-compensated or poorly compensated probes may cause measurement inaccuracy or errors. The probe compensation procedures are as follows:

1. Perform Step 1, 2, 3 and 4 specified in "**Function Inspection**".
2. Check the displayed waveforms and compare them with the waveforms in the following figure.

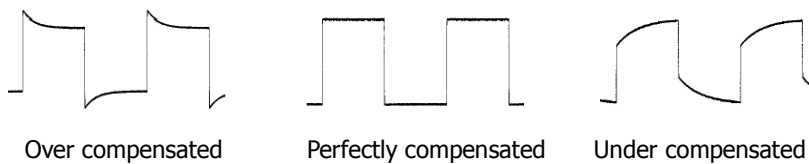

Figure 8 Probe Compensation

3. Use a nonmetallic driver to adjust the low-frequency compensation adjustment hole on the probe until the displayed waveform is displayed as "Perfectly compensated" in the figure above.



## Front Panel Overview

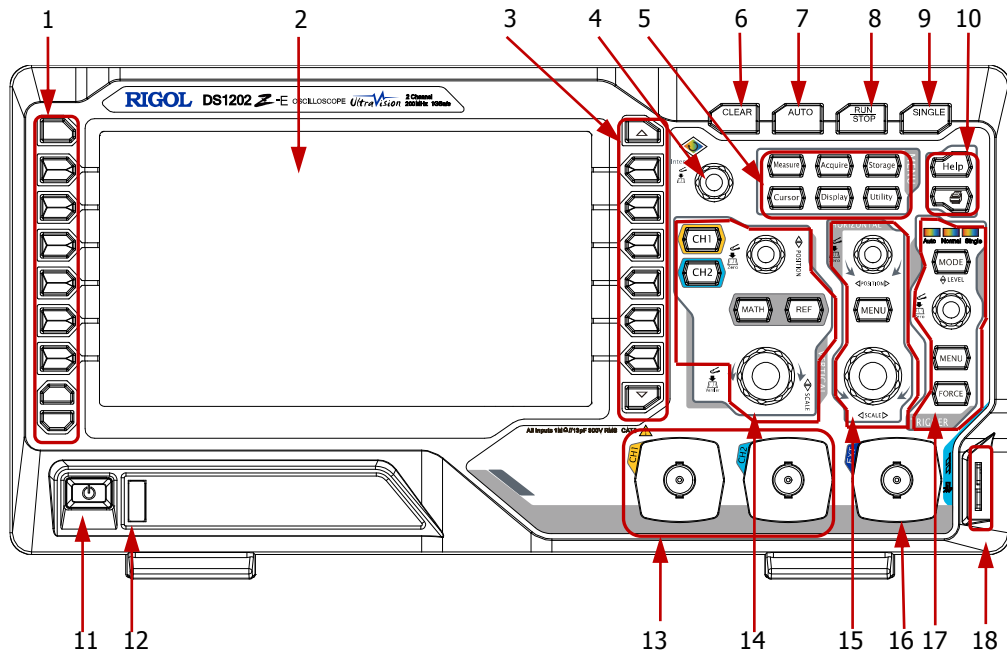

Figure 9 Front Panel Overview

Table 1 Front Panel Description

No.	Description	No.	Description
1	Measurement Menu Softkeys	10	Help/Print
2	LCD	11	Power Key
3	Function Menu Softkeys	12	USB Host Interface
4	Multifunction Knob	13	Analog Channel Input
5	Common Operation Keys	14	VERTICAL Control Area
6	CLEAR	15	HORIZONTAL Control Area
7	AUTO	16	External Trigger Input
8	RUN/STOP	17	TRIGGER Control Area
9	SINGLE	18	Probe Compensation Signal Output Terminal/Ground Terminal

## Rear Panel Overview

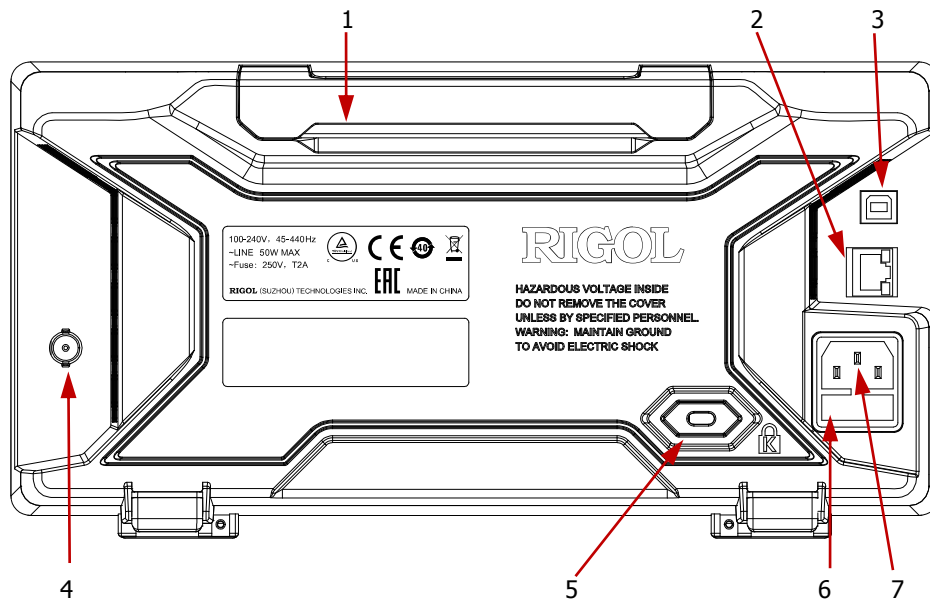

Figure 10 Rear Panel Overview

### 1. Handle

Pull up the handle vertically for easy carrying of the instrument. When you do not need the handle, press it down.

### 2. LAN

Connect the instrument to the network via this interface for remote control. This oscilloscope conforms to the LXI CORE 2011 DEVICE class instrument standards and can quickly build test system with other instruments.

### 3. USB DEVICE

You can connect the oscilloscope to a PictBridge printer or PC via this interface. When a PC is connected, users can send SCPI commands using the PC software or control the oscilloscope via user-defined programming. When a printer is connected, users can print the waveforms displayed on the screen using the printer.

### 4. Trigger Out and Pass/Fail

#### ● Trigger Out:

The oscilloscope can output a signal that can reflect the current capture rate of the oscilloscope at each trigger via this interface. Connect the signal to a waveform display device to measure the frequency of the signal. The measurement result is equal to the current capture rate.

- **Pass/Fail:**

The instrument will output a negative pulse via this connector when a failed waveform is detected during the pass/fail test. The instrument continuously outputs a low level via this connector when no failed waveform is detected.

## 5. Lock Hole

You can lock the instrument to a fixed location by using the security lock (please purchase it yourself) via the lock hole.

## 6. Fuse

If a new fuse is required, please use the specified fuse (250V, T2A). The operation method is as follows:

- a) Turn off the instrument, disconnect the power, and then remove the power cord.
- b) Insert a small straight screwdriver into the slot at the power cord connector and pry out the fuse holder gently.
- c) Take out the fuse and replace it with a specified fuse. Then, install the fuse holder.

## 7. AC Power Cord Connector

AC power input terminal. The power requirements of this oscilloscope are 100-240 V, 45-440 Hz. Use the power cord provided with the accessories to connect the instrument to AC power. Then, you can press the Power key on the front panel to start the instrument.

## Front Panel Function Overview

### VERTICAL

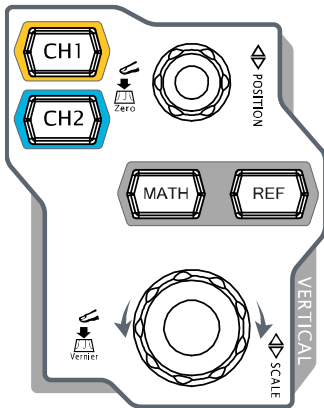

**CH1**, **CH2**: analog channel setting keys. The 2 channels are marked by different colors which are also used to mark both the corresponding waveforms on the screen and the channel input connectors. Press any key to open the corresponding channel menu and press again to turn off the channel.

**MATH**: press **MATH** → **Math**, you can open the math operation menu under which  $A+B$ ,  $A-B$ ,  $A \times B$ ,  $A/B$ , FFT,  $A \& B$ ,  $A || B$ ,  $A^B$ ,  $!A$ , Intg, Diff, Sqrt, Lg, Ln, Exp and Abs are provided. You can also press **MATH** to open the decoding menu and set the decoding options.

**REF**: press this key to enable the reference waveform function to compare the waveform actually measured with the reference waveform.

**Vertical** **POSITION**: modify the vertical position of the current channel waveform. Turn clockwise to increase the position and turn counterclockwise to decrease. During the modification, the waveform would move up and down and the position message (e.g. **POS: 216.0mV**) at the lower-left corner of the screen would change accordingly. Press down this knob to quickly reset the vertical position to zero.

**VERTICAL** **SCALE**: modify the vertical scale of the current channel. Turn clockwise to decrease the scale and turn counterclockwise to increase. During the modification, the amplitude of the waveform would enlarge or reduce and the scale information (e.g. **1 200mV**) at the lower side of the screen would change accordingly. Press down this knob to quickly switch the vertical scale adjustment modes between "Coarse" and "Fine".

#### Tip

#### How to set the vertical scale and vertical position of each channel?

The 2 channels of DS1000Z-E use the same **VERTICAL** **POSITION** and **VERTICAL** **SCALE** knobs. If you want to set the vertical scale and vertical position of a certain channel, please press **CH1** or **CH2** at first to select the desired channel. Then rotate the **VERTICAL** **POSITION** and **VERTICAL** **SCALE** knobs to set the values.

## HORIZONTAL

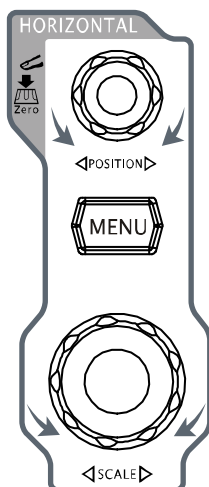

**HORIZONTAL** **POSITION**: modify the horizontal position. The trigger point would move left or right relative to the center of the screen when you rotate the knob. During the modification, waveforms of all the channels would move left or right and the horizontal position message (e.g. **D** -200.000000ns) at the upper-right corner of the screen would change accordingly. Press down this knob to quickly reset the horizontal position (or the delayed sweep position).

**MENU**: press this key to open the horizontal control menu where you can turn on or off the delayed sweep function and switch between different time base modes.

**HORIZONTAL** **SCALE**: modify the horizontal time base. Turn clockwise to reduce the time base and turn counterclockwise to increase the time base. During the modification, waveforms of all the channels will be displayed in expanded or compressed mode and the time base message (e.g. **H** 500ns) at the upper side of the screen would change accordingly. Press down this knob to quickly switch to delayed sweep state.

## TRIGGER

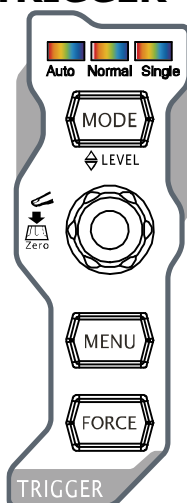

**MODE**: press this key to switch the trigger mode to **Auto**, **Normal** or **Single** and the corresponding state backlight of the current trigger mode would be illuminated.

**TRIGGER** **LEVEL**: modify the trigger level. Turn clockwise to increase the level and turn counterclockwise to reduce the level. During the modification, the trigger level line would move up and down and the value in the trigger level message box (e.g. **Trig Level : 428mV**) at the lower-left corner of the screen would change accordingly. Press down the knob to quickly reset the trigger level to zero point.

**MENU**: press this key to open the trigger operation menu. This oscilloscope provides various trigger types; for the details, please refer to the introduction in *DS1000Z-E User Guide*.

**FORCE**: press this key to generate a trigger signal forcibly.

## CLEAR



Press this key to clear all the waveforms on the screen. If the oscilloscope is in "RUN" state, new waveforms will still be displayed.

## AUTO

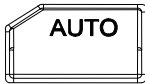

Press this key to enable the waveform auto setting function. The oscilloscope will automatically adjust the vertical scale, horizontal time base and trigger mode according to the input signal to realize optimum waveform display.

**Note:** Waveform auto setting function requires that the frequency of sine is no lower than 41 Hz; the duty cycle should be greater than 1% and the amplitude must be at least 20 mVpp for square. Otherwise, the Waveform auto setting function may be invalid and the quick parameter measurement function displayed in the menu will also be unavailable.

## RUN/STOP

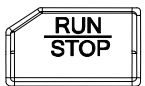

Press this key to "RUN" or "STOP" waveform sampling. In the "RUN" state, the key is illuminated in yellow. In the "STOP" state, the key is illuminated in red.

## SINGLE

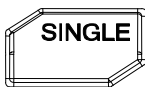

Press this key to set the trigger mode to "Single". In single trigger mode, press **FORCE** to generate a trigger signal immediately.

## Multifunction Knob



### Adjust waveform brightness:

In non-menu-operation mode, turn this knob to adjust the brightness of waveform display. The adjustable range is from 0% to 100%. Turn clockwise to increase the brightness and counterclockwise to reduce. Press down this knob to reset the brightness to 60%.

You can also press **Display** → **Intensity** and use the knob to adjust the waveform brightness.

### Multifunctional:

In menu operation, the backlight of the knob goes on. Press any menu softkey and rotate the knob to select the submenus under this menu and then press down the knob to select the current submenu. It can also be used to modify parameters (please refer to the introduction in "**Parameter Setting Method**") and input filename.

## Function Menus

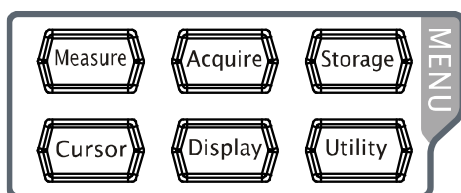

**Measure**: press this key to open the measurement setting menu. You can set the measurement source, turn on or off the frequency counter, all measure, statistic function and etc. Press **MENU** at the left of the screen to switch the measurement menus of 37 waveform parameters. Then, press down the corresponding menu softkey to quickly realize one-key measurement and the measurement result will be displayed at the bottom of the screen.

**Acquire**: press this key to enter the sample setting menu to set the acquisition mode,  $\text{Sin}(x)/x$  and memory depth of the oscilloscope.

**Storage**: press this key to enter file store and recall interface. The storable file types include picture, traces, waveforms, setups, CSV and parameters. Internal and external storage as well as disk management are also supported.

**Cursor**: press this key to enter the cursor measurement menu. The oscilloscope provides four cursor modes: manual, track, auto and XY. Note that XY cursor mode is only available when the horizontal time base is set to XY.

**Display**: press this key to enter display setting menu to set the display type, persistence time, wave intensity, grid type and grid brightness.

**Utility**: press this key to enter the system function setting menu to set the system-related functions or parameters, such as the I/O, sound and language. Besides, some advanced functions (such as the pass/fail test, waveform record, etc.) are also supported.

## Print

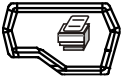

Press this key to print the screen or save the screen to a USB storage device.

- If a PictBridge printer is connected currently and the printer is in idle state, pressing this key will execute the print operation.
- If no printer is connected but a USB storage device is inserted, pressing this key can save the screen to the USB storage device in the specified format.
- If both a printer and a USB storage device are connected at the same time, the printer enjoys higher priority when pressing this key.



## User Interface

DS1000Z-E provides 7.0 inch WVGA (800\*480) TFT LCD.

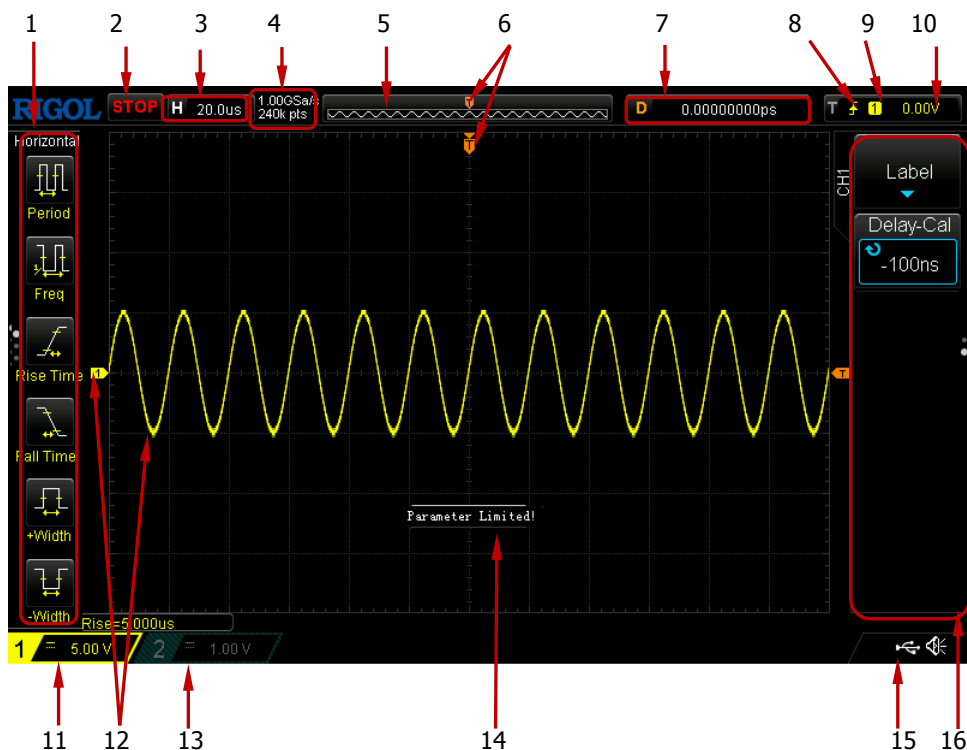

Figure 11 User Interface

### 1. Auto Measurement Items

Provide 20 horizontal (HORIZONTAL) and 17 vertical (VERTICAL) measurement parameters. Press the softkey at the left of the screen to activate the corresponding measurement item. Press **MENU** continuously to switch between the horizontal and vertical parameters.

### 2. Status

Available states include RUN, STOP, T'D (triggered), WAIT and AUTO.

### 3. Horizontal Time Base

- Represent the time per grid on the horizontal axis on the screen.
- Use **HORIZONTAL**  **SCALE** to modify this parameter. The range available is from 5 ns to 50 s.

### 4. Sample Rate/Memory Depth

- Display the current sample rate and memory depth of the oscilloscope.
- The sample rate and memory depth will change in accordance with the

horizontal time base.

## 5. Waveform Memory

Provide the schematic diagram of the memory position of the waveform currently on the screen.

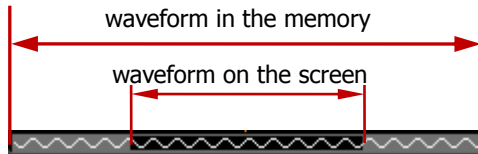

## 6. Trigger Position

Display the trigger position of the waveform in the waveform memory and on the screen.

## 7. Horizontal Position

Use **HORIZONTAL**  **POSITION** to modify this parameter. Press down the knob to automatically set the parameter to zero.

## 8. Trigger Type

Display the currently selected trigger type and trigger condition setting.

Different labels are displayed when different trigger types are selected.

For example:  represents triggering on the rising edge in "Edge" trigger.





## 9. Trigger Source

Display the trigger source currently selected (CH1, CH2, AC Line, or EXT).



Different labels are displayed when different trigger sources are selected and the color of the trigger parameter area will change accordingly.

For example:  denotes that CH1 is selected as the trigger source.

## 10. Trigger Level

- When the trigger source is set to analog channel, you need to set proper trigger level.
  -  at the right of the screen is the trigger level label and the trigger level value is displayed at the upper-right corner of the screen.
  - When using **TRIGGER**  **LEVEL** to modify the trigger level, the trigger level value will change with the up and down of .
- Note:** In slope trigger, runt trigger and windows trigger, there are two trigger level labels ( and .



## 11. CH1 Vertical Scale

- Display the voltage value per grid of CH1 waveform vertically.
- Use **VERTICAL**  **SCALE** to modify this parameter.
- The following labels will be displayed according to the current channel setting: channel coupling (e.g. ) and bandwidth limit (e.g. .

## 12. Analog Channel Label/Waveform

Different channels are marked with different colors and the colors of the channel label and waveform are the same.

## 13. CH2 Vertical Scale



- Display the voltage value per grid of CH2 waveform vertically.
- Use **VERTICAL**  **SCALE** to modify this parameter.
- The following labels will be displayed according to the current channel setting: channel coupling (e.g. ) and bandwidth limit (e.g. )

## 14. Message Box

Display prompt messages.

## 15. Notification Area













Display sound icon and USB disk icon.

- Sound Icon: Press **Utility** → **Sound** to enable or disable the sound. When the sound is enabled,  will be displayed; when the sound is disabled,  will be displayed.
- USB Disk Icon: when a USB disk is detected,  will be displayed.

## 16. Operation Menu

Press any softkey to activate the corresponding menu.



The following symbols might be displayed in the menu:

-  Denote that you can rotate the multifunction knob  to modify parameters. The backlight of  turns on during the parameter modification.
-  Denote that you can rotate  to select the desired item, the item currently selected is displayed in blue, press down the knob to enter the corresponding menu. The backlight of  is constant on after menus with this symbol are selected.
-  Denote that press  to input desired parameter values directly using the pop-up numeric keyboard. The backlight of  is constant on after menus with this symbol are selected.
-  Denote that the current menu has several options.
-  Denote that the current menu has a lower level menu.
-  Press this key to return to the previous menu.
-  The number of the dots denotes that the number of the pages the current menu has.



## Parameter Setting Method

This oscilloscope provides two methods to set the basic parameters.

Method 1:

When  is displayed on the menu, you can rotate  to set the desired value directly.

Method 2:

When  is displayed, press down  and the numeric keyboard is displayed, as shown below. Rotate the knob to select the desired value, and then press down the knob to input the value. After all the value input, rotate the knob to select the desired unit, press down the knob to finish your input.

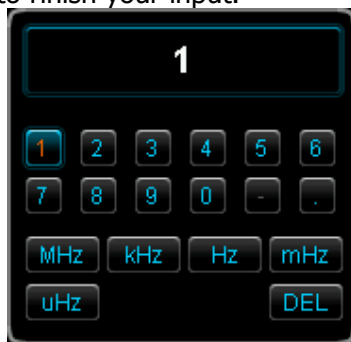

Figure 12 Numeric Keyboard

## To Use the Security Lock

If needed, you can use the security lock (please buy it yourself) to lock the oscilloscope to a fixed location. The method is as follows, align the lock with the lock hole and plug it into the lock hole vertically, turn the key clockwise to lock the oscilloscope and then pull the key out.

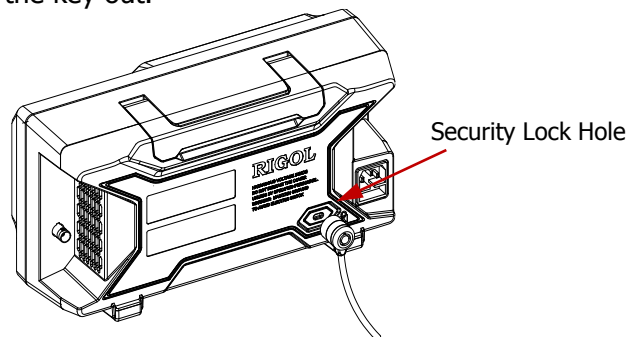

Figure 13 To Use the Security Lock

**Note:** Please do not insert other articles into the security lock hole to avoid damaging the instrument.

## To Use the Built-in Help System

The help system of this oscilloscope provides instructions for all the function keys (including menu keys) on the front panel. Press **Help** to open the help interface and press again to close the interface. The help interface mainly consists of two parts. The left is "Help Options" and the right is "Help Display Area".

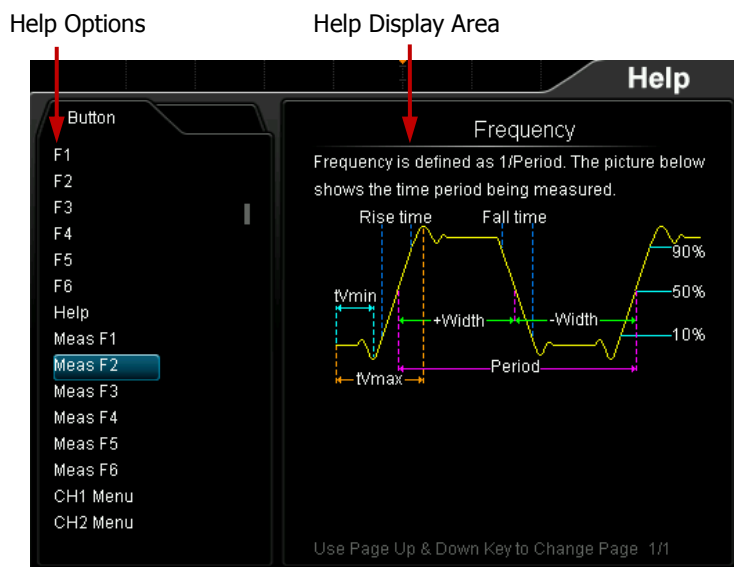





Figure 14 Help Information

You can press the button (except the Power key , the knob  and the menu Page Up/Down key ) on the front panel directly to get the corresponding help information in the "Help Display Area".

# Troubleshooting

The commonly encountered failures and their solutions are listed below. When you encounter those failures, please solve them following the corresponding steps. If the problem remains still, please contact **RIGOL** and provide your device information (acquisition method: **Utility** → **System** → **System Info**).

- 1. The screen is still dark (no display) after you powered on the instrument.**
  - (1) Check whether the power switch is really on.
  - (2) Check whether the power is correctly connected.
  - (3) Check whether the fuse is burned out. If the fuse needs to be changed, please use the specified fuse.
  - (4) Restart the instrument after finishing the above inspections.
  - (5) If it still persists, please contact **RIGOL**.
  
- 2. The signal is sampled but no waveform of the signal is displayed.**
  - (1) Check whether the probe is correctly connected to the item under test.
  - (2) Check whether signals are generated from the item under test (you can connect the probe compensation signal to the problematic channel to locate the problem).
  - (3) Resample the signal.
  
- 3. The voltage amplitude measured is greater or smaller than the actual value (note that this failure usually only occurs when probe is used).**

Check whether the probe ratio of the channel complies with the attenuation ratio of the probe.
  
- 4. Waveforms are found to be displayed but not stable.**
  - (1) Check the trigger signal source: press **MENU** (in the trigger control area (TRIGGER) on the front panel) → **Source** to check whether the trigger source selected complies with the signal channel actually used.
  - (2) Check the trigger type: general signals should use "Edge" trigger and video signal should use "Video" trigger. Only when the proper trigger type is used, can the waveform be displayed stably.
  - (3) Check the trigger level: adjust the trigger level to the middle of the signal.
  - (4) Change the trigger holdoff setting.
  
- 5. No display is found after pressing **RUN/STOP**.**

Check whether the trigger mode in the trigger control area (TRIGGER) on the front panel is "Normal" or "Single" and whether the trigger level exceeds the waveform range. If yes, set the trigger level to the middle or press **MODE** to set the trigger mode to "Auto".

**Note:** Pressing **AUTO** could automatically finish the above setting.

**6. The display of waveform is ladder-like.**

- (1) The horizontal time base might be too low. Increase the horizontal time base to increase the horizontal resolution and improve the display.
- (2) If the display type is "Vectors", the lines between the sample points may cause ladder-like display. Press **Display** → **Type** to set the display type to "Dots" to solve the problem.

**7. I Fail to connect PC or PictBridge printer through USB.**

- (1) Press **Utility** → **IO Setting** → **USB Device** to check whether the current setting matches the device currently connected.
- (2) Check whether the USB cable is correctly connected to the instrument and PC.
- (3) Check whether the USB cable is in good condition. If needed, restart the oscilloscope.

**8. The USB storage device cannot be recognized.**

- (1) Check whether the USB storage device can work normally.
- (2) Check whether the USB storage device being used is flash type. This oscilloscope does not support USB3.0 and hardware type USB storage device.
- (3) Check whether the capacity of the USB storage device is too large. It is recommended that the capacity of the USB storage device being used with this oscilloscope should not exceed 8 GBytes.
- (4) Restart the instrument and then insert the USB storage device to check it.
- (5) If the USB storage device still cannot be used normally, please contact **RIGOL**.

