

# **RIGOL**

## **User's Guide**

### **DSA1000 Series Spectrum Analyzer**

**Jan. 2010**

**RIGOL Technologies, Inc.**



## **Copyright**

© 2010 RIGOL Technologies, Inc. All Rights Reserved.

## **Trademark Information**

**RIGOL** is registered trademark of **RIGOL** Technologies, Inc.

## **Notices**

- **RIGOL** products are protected by patent law in and outside of P.R.C.
- **RIGOL** Technologies, Inc. reserves the right to modify or change parts of or all the specifications and pricing policies at company's sole decision.
- Information in this publication replaces all previously corresponding material.
- **RIGOL** shall not be liable for losses caused by either incidental or consequential in connection with the furnishing, use or performance of this manual as well as any information contained.
- Any part of this document is forbidden to copy or photocopy or rearrange without prior written approval of **RIGOL**.

## **Product Certification**

**RIGOL** guarantees this product conforms to the national and industrial standards in China. International standard conformance certification is in progress, e.g. ISO. At present the analyzer has passed CE, PictBridge, LXI and cTUVus certification.

## Safety Notice

Please review the following safety precautions carefully before putting the instrument into operation so as to avoid any personal injuries or damages to the instrument and any product connected to it. To prevent potential hazards, please use the instrument only specified by this manual.

### Use Proper Power Cord

Only the power cord designed for the instrument and authorized by local country could be used.

### Ground the Instrument

The instrument is grounded through the Protective Earth lead of the power cord. To avoid electric shock, it is essential to connect the earth terminal of power cord to the Protective Earth terminal before any inputs or outputs.

### Observe all Terminal Ratings

To avoid fire or shock hazard, observe all ratings and markers on the instrument and check your manual for more information about ratings before connecting.

### Use Proper Overvoltage Protection

Make sure that no overvoltage (such as that caused by a thunderstorm) can reach the product, or else the operator might expose to danger of electrical shock.

### Do Not Operate Without Covers

Do not operate the instrument with covers or panels removed.

### Use Proper Fuse

Please use the specified fuses.

### Avoid Circuit or Wire Exposure

Do not touch exposed junctions and components when the unit is powered.

### Do Not Operate With Suspected Failures

If you suspect damage occurs to the instrument, have it inspected by qualified service personnel before further operations. Any maintenance, adjustment or replacement especially to circuits or accessories must be performed by **RIGOL** authorized personnel.

### Keep Well Ventilated

Inadequate ventilation may cause an increase of temperature or damage to the device. So please keep well ventilated and inspect the intake and fan regularly.

### Do Not Operate in Wet Conditions

In order to avoid short circuiting to the interior of the device or electric shock, please do not operate in a humid environment.

### **Do Not Operate in an Explosive Atmosphere**

In order to avoid damages to the device or personal injuries, it is important to operate the device away from an explosive atmosphere.

### **Keep Product Surfaces Clean and Dry**

To avoid the influence of dust and/or moisture in air, please keep the surface of device clean and dry.

### **Electrostatic Prevention**

Operate in an electrostatic discharge protective area environment to avoid damages induced by static discharges. Always ground both the internal and external conductors of the cable to release static before connecting.

### **Protect the Input Terminals of Instrument**

Do not bend or hit the input terminals and the connected devices, (such as filter, attenuator, etc.) as such stress may cause damages to devices and the instrument. Do not mix the use of 50 $\Omega$  and 75 $\Omega$  connectors and/or cables.

### **Do Not Overload the Input**

To avoid damaging the instrument, the signals at input terminal must be less than 50V DC voltage components and 30 dBm (1 W) AC (RF) components.

### **Appropriate Use of Power Meter**

If you are not sure of the characteristics of signal under measure, follow these recommendations to ensure safe operations: if a RF power meter is available, use it to measure the power level of this signal first; or add a rated external attenuator between signal cable and input terminal of the instrument. Maximum attenuation, reference level and maximum span frequency should be selected, so as to make the signals displayed within the screen.

### **Know About the Specification Conditions of the Instrument**

For maximum performance of the instrument, use the analyzer under specified conditions.

### **Proper Use of Battery**

The battery must not be exposed to high temperature or in contact with fire. Keep it out of the reach of children. Improper change of battery (note: lithium battery) may cause explosion. Use **RIGOL** specified battery only.

### **Handling Safety**

Please handle with care during transportation to avoid damages to buttons, knob, interfaces and other parts on the panels.

## Safety Terms and Symbols

**Terms in this Manual.** These terms may appear in this manual:



---

**WARNING**

Warning statements indicate the conditions or practices that could result in injury or loss of life.

---



---

**CAUTION**

Caution statements indicate the conditions or practices that could result in damage to this product or other property.

---

**Terms on the Product.** These terms may appear on the product:

**DANGER** indicates an injury or hazard may immediately happen.

**WARNING** indicates an injury or hazard may be accessible potentially.

**CAUTION** indicates a potential damage to the instrument or other property might occur.

**Symbols on the Product.** These symbols may appear on the product:



**Hazardous Voltage**



**Refer to Instructions**



**Protective Earth Terminal**



**Chassis Ground**



**Test Ground**

---

## DSA1000 Series Overview

DSA1000 Series Spectrum Analyzer is designed with small volume, light weight, high cost performance, and having an easy-operated keyboard layout. Features include a high definition 8.5 inch TFT color LCD, easy to understand settings and messages on the display interface, standard or configurable USB, LAN and GPIB communication interfaces that enable users to display or control the instrument over virtual terminals and remote networks. It is widely used in education, science, corporate centers, industrial production and many other fields.

At present, the DSA1000 Series provide two models for users: DSA1030 and DSA1020.

### Main features:

- Frequency Range: 9 kHz to 2 GHz or 3 GHz
- Display Average Noise Level (DANL): -138 dBm
- Phase Noise: -88 dBc/Hz @ 10 kHz offset (Typical)
- Total Amplitude Accuracy: <1.5 dB
- Minimum Resolution Bandwidth: 100 Hz
- Standard with Preamplifier
- 3 GHz Tracking Generator (DSA1030 optional)
- Built-in lithium battery which can provide 3 hours continuous operation (optional)
- Plenty of measurement functions and auto settings for choosing
- 8.5 inches widescreen display, clear and vivid interface, easy-to-use design
- Various interfaces such as LAN, USB Host, USB Device, VGA or GPIB (optional)
- Compact design with only 13.7 lbs (without battery)

## Document Overview

- 1 Quick Start:** This chapter introduces the front/rear panel and user interface, as well as announcements during first use of the analyzer, and shows the usage through a measurement example demo.
  - 2 Front Panel Key Reference:** This chapter gives detailed function descriptions of the front panel keys with their associated menu keys.
  - 3 Measurement Examples:** This chapter introduces the main functions and operations of the analyzer.
  - 4 Remote Control:** This chapter shows how to control the analyzer in remote mode.
  - 5 Troubleshooting:** This chapter lists the troubleshooting information and messages that may appear during the use of the analyzer.
  - 6 Specification:** This chapter lists the general specifications of the analyzer.
  - 7 Menu Map:** This chapter provides a visual representation of the front panel keys and their associated menu keys.
  - 8 Appendix:** This chapter lists the options and accessories that can be ordered along with your analyzer as well as the service and support information.
- **Conventions for buttons and menu formats in this manual:**  
**Buttons:** button name+textbox, such as **FREQ** indicates the **FREQ** function key.  
**Menu keys:** menu word+character shading, such as **Center Freq** indicates the center frequency menu under the **FREQ** function.
  - **User manuals provided by our product:**  
User's Guide, Quick Guide, Programming Guide and Data sheet.

**Hint:**

This manual is mainly based on DSA1030, but also contains all the information about DSA1020.

For the newest version of this manual please download from this URL:

<http://www.rigolna.com/>



# Table of Contents

<b>Safety Notice .....</b>	<b>II</b>
<b>DSA1000 Series Overview .....</b>	<b>V</b>
<b>Document Overview.....</b>	<b>VI</b>
<b>Table of Contents.....</b>	<b>VII</b>
<b>List of Figures .....</b>	<b>XII</b>
<b>List of Tables.....</b>	<b>XV</b>
<b>1 Quick Start.....</b>	<b>1-1</b>
<b>1.1 Front Panel .....</b>	<b>1-2</b>
1.1.1 Front Panel Function Key.....	1-3
1.1.2 Front Panel Backlight Key .....	1-6
1.1.3 Front Panel Connector.....	1-8
<b>1.2 Rear Panel .....</b>	<b>1-10</b>
<b>1.3 Prepare for Use .....</b>	<b>1-13</b>
1.3.1 General Inspection.....	1-13
1.3.2 Disassemble the Front Panel Cover .....	1-14
1.3.3 Adjust the Supporting Legs .....	1-14
1.3.4 Power Supply.....	1-15
1.3.5 Power-On Check .....	1-17
1.3.6 Self Calibration .....	1-17
1.3.7 Use the Lock.....	1-17
1.3.8 Change the Fuse.....	1-18
1.3.9 Charge the Battery.....	1-19
<b>1.4 User Interface .....</b>	<b>1-20</b>
<b>1.5 Menu Operation .....</b>	<b>1-24</b>
<b>1.6 Parameter Input .....</b>	<b>1-26</b>
1.6.1 Numeric Keyboard .....	1-26
1.6.2 Knob .....	1-27
1.6.3 Direction key .....	1-28
<b>1.7 Basic Measurement .....</b>	<b>1-29</b>
<b>1.8 How to Use the Built-in Help .....</b>	<b>1-31</b>

**2 Front Panel Key Reference ..... 2-1**

**2.1 Basic Settings..... 2-2**

2.1.1 FREQ..... 2-2

2.1.2 SPAN..... 2-9

2.1.3 AMPT .....2-11

**2.2 Sweep Settings .....2-20**

2.2.1 BW.....2-20

2.2.2 Sweep.....2-22

2.2.3 Auto Tune.....2-25

2.2.4 Trig .....2-27

2.2.5 Single.....2-29

2.2.6 Continue.....2-30

**2.3 Function Settings.....2-31**

2.3.1 Detector .....2-31

2.3.2 Trace.....2-34

2.3.3 Demod (DSA1030 Option) .....2-37

2.3.4 Source (DSA1030 Option).....2-39

**2.4 Advanced Measurements (DSA1030 Option) .....2-44**

2.4.1 Meas .....2-44

2.4.2 Meas Setup .....2-47

**2.5 Marker Measurements.....2-72**

2.5.1 Marker .....2-72

2.5.2 Marker-> .....2-78

2.5.3 Marker Fctn .....2-80

2.5.4 Peak.....2-84

2.5.5 L-Peak.....2-87

2.5.6 R-Peak.....2-87

**2.6 System Functions.....2-88**

2.6.1 System .....2-88

2.6.2 Display .....2-96

2.6.3 Preset .....2-100

2.6.4 Storage .....2-106

2.6.5 Print Setup .....2-110

2.6.6 Print.....2-114

**2.7 Screen Control.....2-115**

2.7.1 Full Screen .....2-115

2.7.2 Next Window .....2-116

2.7.3 Zoom .....2-117

---

<b>3</b>	<b>Measurement Examples.....</b>	<b>3-1</b>
3.1	Measuring a Sine Signal .....	3-2
3.2	Using the Frequency Counter .....	3-4
3.3	Measuring an AM Signal (For DSA1030).....	3-6
3.4	Measuring the Phase Noise.....	3-9
3.5	Measuring the N dB Bandwidth .....	3-11
3.6	Measuring the Time-Domain Power (For DSA1030).....	3-13
3.7	Measuring the Adjacent Channel Power (For DSA1030).....	3-15
3.8	Measuring the Channel Power (For DSA1030).....	3-17
3.9	Measuring the Occupied Bandwidth (For DSA1030) .....	3-19
3.10	Measuring the Emission Bandwidth (For DSA1030).....	3-21
3.11	Measuring the Carrier-to-Noise Ratio (For DSA1030) .....	3-23
3.12	Measuring the Harmonic Distortion (For DSA1030).....	3-25
3.13	Measuring the TOI Distortion (For DSA1030).....	3-29
3.14	Pass/Fail Measurement (For DSA1030) .....	3-32
3.15	Amplitude Correction .....	3-34
3.16	Tracking Generator (For DSA1030) .....	3-36
<b>4</b>	<b>Remote Control.....</b>	<b>4-1</b>
4.1	Remote Control Via USB.....	4-2
4.2	Remote Control Via LAN.....	4-4
4.3	Remote Control Via GPIB.....	4-7
<b>5</b>	<b>Troubleshooting.....</b>	<b>5-1</b>
5.1	Troubleshooting.....	5-1
5.2	Messages .....	5-3
5.2.1	Information Message .....	5-5
5.2.2	Error Message .....	5-7
5.2.3	Status Message.....	5-19
<b>6</b>	<b>Specification .....</b>	<b>6-1</b>
6.1	Specification.....	6-2
6.1.1	Frequency .....	6-2
6.1.2	Amplitude.....	6-3
6.1.3	Sweep.....	6-7
6.1.4	Trigger .....	6-7
6.1.5	Tracking Generator (DSA1030 Option) .....	6-7
6.1.6	Input/Output.....	6-8

---

<b>6.2</b>	<b>General Specification</b> .....	6-9
<b>7</b>	<b>Menu Map</b> .....	<b>7-1</b>
7.1	AMPT .....	7-2
7.2	BW .....	7-3
7.3	Demod (For DSA1030) .....	7-4
7.4	Detector.....	7-5
7.5	Display .....	7-6
7.6	FREQ .....	7-7
7.7	Marker .....	7-8
7.8	Marker Fctn .....	7-9
7.9	Marker-> .....	7-10
7.10	Meas (For DSA1030) .....	7-11
7.11	Meas Setup (For DSA1030) .....	7-12
7.11.1	T-Power.....	7-12
7.11.2	ACP.....	7-13
7.11.3	Channel Power.....	7-13
7.11.4	OBW .....	7-14
7.11.5	EBW.....	7-14
7.11.6	C/N Ratio.....	7-15
7.11.7	Harmonics Dist .....	7-15
7.11.8	TOI .....	7-16
7.11.9	Pass/Fail.....	7-16
7.12	Peak.....	7-17
7.13	Print Setup .....	7-18
7.14	SPAN.....	7-19
7.15	Storage.....	7-20
7.16	Sweep.....	7-21
7.17	System.....	7-22
7.18	Source .....	7-26
7.19	Trace.....	7-27
7.20	Trig .....	7-28
<b>8</b>	<b>Appendix</b> .....	<b>8-1</b>
	Appendix A: Options and Accessories .....	8-1
	Appendix B: Warranty .....	8-2
	Appendix C: General Care and Cleaning .....	8-3
	Appendix D: Contact Us.....	8-4

**Index ..... 1**

# List of Figures

Figure 1-1 Front panel overview..... 1-2

Figure 1-2 Function key area ..... 1-3

Figure 1-3 Front Panel Connectors ..... 1-8

Figure 1-4 USB Host interface connections ..... 1-8

Figure 1-5 Tracking generator output connection ..... 1-9

Figure 1-6 RF input connection ..... 1-9

Figure 1-7 Rear panel overview.....1-10

Figure 1-8 TRIGGER IN connection .....1-11

Figure 1-9 10 MHz IN/OUT connection .....1-11

Figure 1-10 VGA port connection .....1-11

Figure 1-11 PictBridge printer connection .....1-12

Figure 1-12 USB remote control connection .....1-12

Figure 1-13 LAN connection .....1-12

Figure 1-14 Disassemble the front panel cover .....1-14

Figure 1-15 Adjust the supporting legs.....1-14

Figure 1-16 Power cord connection .....1-15

Figure 1-17 Install the battery .....1-16

Figure 1-18 Use the lock.....1-17

Figure 1-19 Change the fuse.....1-18

Figure 1-20 User interface .....1-20

Figure 1-21 The Numerical keyboard.....1-26

Figure 1-22 The knob .....1-27

Figure 1-23 Direction keys .....1-28

Figure 1-24 Measuring result .....1-30

Figure 1-25 Built-in help .....1-31

Figure 2-1 Process of signal tracking ..... 2-6

Figure 2-2 Before the Peak->CF..... 2-7

Figure 2-3 After the Before Peak->CF..... 2-7

Figure 2-4 Before the Auto Scale.....2-11

Figure 2-5 After the Auto Scale.....2-11

Figure 2-6 Before the Auto Range.....2-16

Figure 2-7 After the Auto Range .....2-16

Figure 2-8 Process of the Auto Range .....2-17

Figure 2-9 Before the Auto Tune .....2-25

---

Figure 2-10 After the Auto Tune.....	2-25
Figure 2-11 Process of a single sweep.....	2-29
Figure 2-12 Process of continue sweep .....	2-30
Figure 2-13 Working principle of the detector .....	2-31
Figure 2-14 Power sweep .....	2-40
Figure 2-15 Interface of T-Power measurement .....	2-47
Figure 2-16 Interface of ACP measurement .....	2-50
Figure 2-17 Interface of Chan Pwr measurement.....	2-53
Figure 2-18 Interface of OBW measurement.....	2-56
Figure 2-19 Interface of EBW measurement .....	2-59
Figure 2-20 Interface of C/N Ratio measurement.....	2-62
Figure 2-21 Interface of Harmo Dist measurement .....	2-65
Figure 2-22 Interface of TOI measurement.....	2-68
Figure 2-23 Interface of Pass/Fail measurement .....	2-70
Figure 2-24 Schematic of the marker .....	2-72
Figure 2-25 The marker schematic.....	2-77
Figure 2-26 N dB BW measurement .....	2-81
Figure 2-27 Frequency Count measurement .....	2-82
Figure 2-28 Peak Table.....	2-86
Figure 2-29 LAN parameter setting.....	2-90
Figure 2-30 Classic display.....	2-98
Figure 2-31 Modern display .....	2-99
Figure 2-32 File operation manager.....	2-106
Figure 2-33 PictBridge printer connection .....	2-110
Figure 2-34 Full screen display.....	2-115
Figure 2-35 Switch between windows.....	2-116
Figure 3-1 Measuring a Sine signal.....	3-3
Figure 3-2 Use the frequency counter to measure.....	3-5
Figure 3-3 Measure an AM signal .....	3-7
Figure 3-4 Phase noise measurement.....	3-10
Figure 3-5 N dB bandwidth measurement result .....	3-12
Figure 3-6 Time-domain power measurement.....	3-14
Figure 3-7 Adjacent channel power measurement result .....	3-16
Figure 3-8 Channel power measurement result.....	3-18
Figure 3-9 Occupied bandwidth measurement result.....	3-20
Figure 3-10 Emission bandwidth measurement result.....	3-22
Figure 3-11 C/N Ratio measurement result.....	3-24
Figure 3-12 Use marker to measure harmonics.....	3-26

Figure 3-13 Harmonic Distortion measurement result.....3-28

Figure 3-14 Use marker function to measure TOI distortion.....3-30

Figure 3-15 Use TOI function to measure TOI distortion.....3-31

Figure 3-16 Pass/Fail testing .....3-33

Figure 3-17 Amplitude correction .....3-35

Figure 3-18 The frequency response of a filter .....3-37

Figure 4-1 Search USB resources ..... 4-2

Figure 4-2 View the resource ..... 4-3

Figure 4-3 Write and read commands via USB ..... 4-3

Figure 4-4 Search LAN resources ..... 4-4

Figure 4-5 View the resource ..... 4-4

Figure 4-6 Write and read commands via LAN ..... 4-5

Figure 4-7 LXI webpage ..... 4-6

Figure 4-8 GPIB Setting ..... 4-7

Figure 4-9 View the GPIB resource..... 4-8

Figure 4-10 Write and read commands via GPIB ..... 4-8



## List of Tables

Table 1-1 Front Panel Description.....	1-2
Table 1-2 Function keys description.....	1-3
Table 1-3 User interface legends.....	1-20
Table 2-1 Center Frequency.....	2-3
Table 2-2 Start Frequency.....	2-3
Table 2-3 Stop frequency.....	2-4
Table 2-4 CF step.....	2-5
Table 2-5 Span.....	2-9
Table 2-6 Reference level.....	2-12
Table 2-7 Input attenuation.....	2-13
Table 2-8 Scale.....	2-13
Table 2-9 Reference level offset.....	2-15
Table 2-10 Edit menus of Amplitude correction.....	2-18
Table 2-11 Max mixing level.....	2-19
Table 2-12 RBW.....	2-20
Table 2-13 VBW.....	2-21
Table 2-14 V/R Ratio.....	2-21
Table 2-15 Sweep time.....	2-22
Table 2-16 Numbers.....	2-23
Table 2-17 Points.....	2-24
Table 2-18 Trigger level.....	2-28
Table 2-19 Average times.....	2-35
Table 2-20 Constant in math operation.....	2-36
Table 2-21 Volume.....	2-37
Table 2-22 Demod Time.....	2-38
Table 2-23 TG level.....	2-39
Table 2-24 TG Level Offset.....	2-40
Table 2-25 Power Range of TG.....	2-41
Table 2-26 Frequency Offset.....	2-41
Table 2-27 Reference level under normalization.....	2-42
Table 2-28 TG reference position.....	2-43
Table 2-29 Average number for T-Power measurement.....	2-48
Table 2-30 The Start Line under T-Power measurement.....	2-49
Table 2-31 The Stop Line under T-Power measurement.....	2-49

Table 2-32 Average number for ACP measurement .....	2-51
Table 2-33 The main channel bandwidth of ACP measurement .....	2-51
Table 2-34 The adjacent channel bandwidth of ACP measurement.....	2-52
Table 2-35 Spacing of the ACP measurement.....	2-52
Table 2-36 Average number for Chan Pwr measurement .....	2-54
Table 2-37 Integral bandwidth of Chan Pwr measurement.....	2-54
Table 2-38 The Channel span of Chan Pwr measurement .....	2-55
Table 2-39 Average number for OBW measurement .....	2-57
Table 2-40 The Span of OBW measurement.....	2-57
Table 2-41 The Power Ratio of OBW measurement .....	2-58
Table 2-42 Average number for EBW measurement.....	2-60
Table 2-43 The Span of EBW measurement .....	2-60
Table 2-44 X dB .....	2-61
Table 2-45 Average number for C/N Ratio measurement .....	2-63
Table 2-46 The Offset Freq of C/N Ratio measurement.....	2-63
Table 2-47 Noise BW of C/N Ratio measurement.....	2-64
Table 2-48 The Carrier BW of C/N Ratio measurement .....	2-64
Table 2-49 Average number for Harmo Dist measurement.....	2-66
Table 2-50 Number of harmonics for Harmo Dist measurement .....	2-66
Table 2-51 The Sweep Time of Harmo Dist measurement.....	2-67
Table 2-52 Average number for TOI measurement.....	2-69
Table 2-53 The Span of TOI measurement .....	2-69
Table 2-54 Pass/Fail menu .....	2-71
Table 2-55 Marker parameters .....	2-73
Table 2-56 N dB BW parameter settings .....	2-81
Table 2-57 The resolution of frequency counter .....	2-82
Table 2-58 GPIB address .....	2-91
Table 2-59 Display line .....	2-96
Table 2-60 Graticule .....	2-97
Table 2-61 Brightness setting.....	2-98
Table 2-62 Factory Default.....	2-100
Table 2-63 File icons.....	2-106
Table 2-64 File type.....	2-107
Table 2-65 The printing state icons .....	2-111

# 1 Quick Start

This chapter introduces the front/rear panel and the user interface, as well as announcements during first use of the analyzer, and shows the usage through a measurement example demo.

Subjects in this chapter:

- Front Panel
- Rear Panel
- Prepare for Use
- User Interface
- Menu Operation
- Parameter Input
- Basic Measurement
- How to Use the Built-in Help

# 1.1 Front Panel

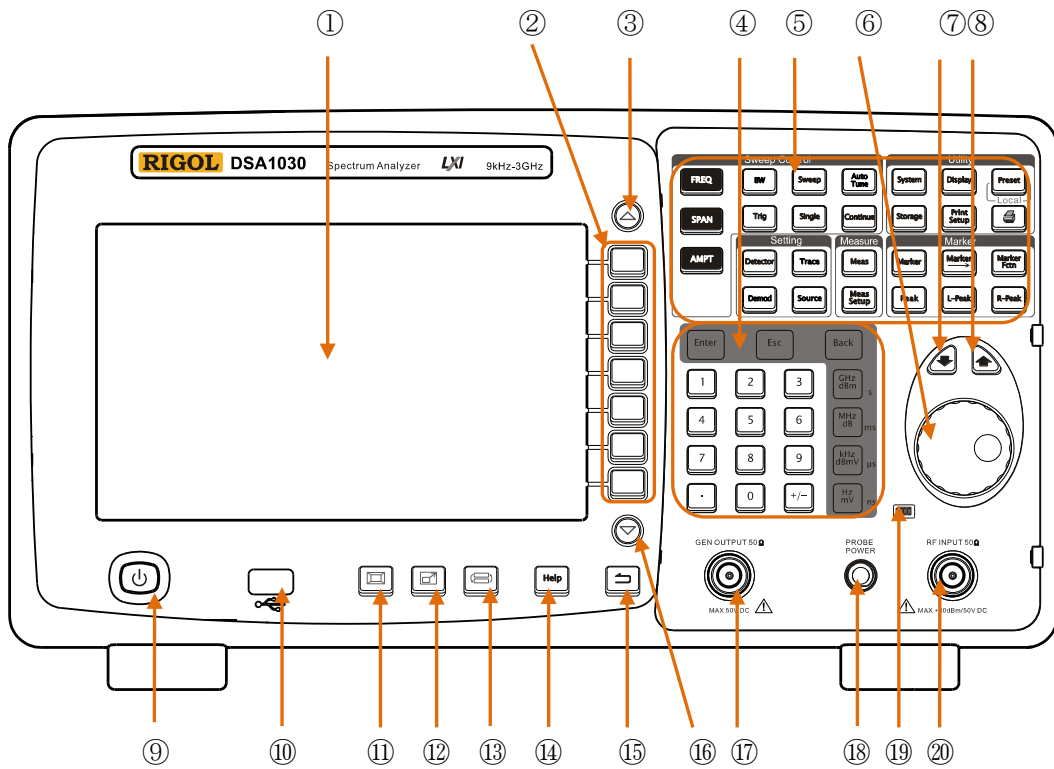

Figure 1-1 Front panel overview

Table 1-1 Front Panel Description

NO.	Description	NO.	Description
①	LCD	⑪	Full screen
②	Menu key	⑫	Zoom window
③	page up	⑬	Switch window
④	Numeric keyboard	⑭	One-button help
⑤	Function key area	⑮	Back
⑥	Knob	⑯	Page down
⑦	Down	⑰	Tracking generator output*
⑧	Up	⑱	Probe power output
⑨	Power key	⑲	Battery status indicator
⑩	USB Host interface	⑳	RF input

\*Note: For DSA1030 only.

## 1.1.1 Front Panel Function Key

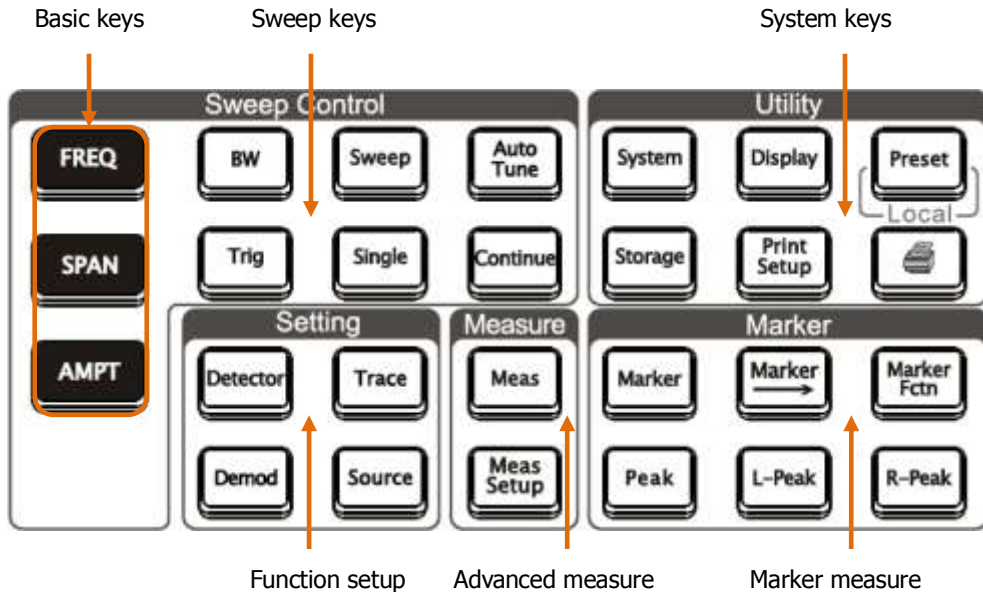

















Figure 1-2 Function key area

Table 1-2 Function keys description







Keys	Description
<b>Sweep keys</b>	
<b>FREQ</b>	Sets the center, start and stop frequency, as well as the signal tracking function.
<b>SPAN</b>	Sets the frequency sweep span.
<b>AMPT</b>	Sets the reference level, RF attenuator, scale and the unit of Y-axis, etc.
<b>BW</b>	Sets the Resolution Bandwidth and Video Bandwidth of the analyzer.
<b>Sweep</b>	Sets the sweep time, sweep mode, sweep numbers in single mode and the sweep points.
<b>Auto Tune</b>	Searches signals automatically within full frequency range.

## Function keys description (Continued)

Keys	Description
	Sets the trigger mode and corresponding parameters.
	Sets the sweep mode to Single.
	Sets the sweep mode to Continue.
<b>Function setup</b>	
	Sets the detection mode of the analyzer.
	Sets the parameters relate to sweep trace.
	Sets the demodulation*.
	Sets the tracking generator*.
<b>Advanced measure*</b>	
	Select a desired advanced measurement function.
	Sets the parameters for the selected measurement function.
<b>Marker measure</b>	
	Reads the amplitude, frequency and sweep time of a certain point on the trace.
	Sets other system parameters based on the current marker value.
	Special function such as noise marker, N dB bandwidth measure and frequency counting.
	Searches the peak and opens the Peak menu immediately.
	Measures the left peak directly.
	Measures the right peak directly.

\*Note: For DSA1030 only.

## Function keys description (Continued)

Keys	Description
<b>System keys</b>	
	Sets the system parameters.
	Sets the display parameters.
	Executes the selected preset function, resets the system into specified status, modifies all sweep parameters, measure settings as well as system parameters for following measure.
	Enter the storage interface.
	Sets the print parameters.
	Print or save current screen.

## 1.1.2 Front Panel Backlight Key

The backlight status of some keys at the front panel, off, bright or different color indicates different working mode.

### 1. AutoTune

When **Auto Tune** is pressed, the backlight turns on, which indicates that the instrument starts sweeping at full range, searching the signal of maximum amplitude, and moves it to the center of the screen. Then the backlight turns off.

### 2. Single, Continue

When backlights of **Single** or **Continue** are on, it indicates the current sweep mode is Single or Continue, respectively.

### 3. Meas\*

The backlight of **Meas** will be automatically turned on once any measurements are activate, and stay on until all measurement functions are disabled.

### 4. Source\*

When backlight of **Source** is on, it indicates that the tracking generator is enabled, and vice versa.

### 5. Power light

In AC supply:

- Flashes on and off alternatively: indicating the unit is in stand-by state.
- Constant on: indicating the normal operating condition.

In battery supply:

- Dark: indicating the unit is in stand-by condition.
- Constant on: indicating the unit is in normal operating condition.

### 6. Battery indicator

The indicator indicates whether the battery has been installed and its electrical power conditions.

- Green: electrical power >80%



- Orange: 20% < electrical power < 80%
- Red: electrical power < 20%
- All off: no battery is installed or the battery has zero power.

\*Note: For DSA1030 only.

### 1.1.3 Front Panel Connector

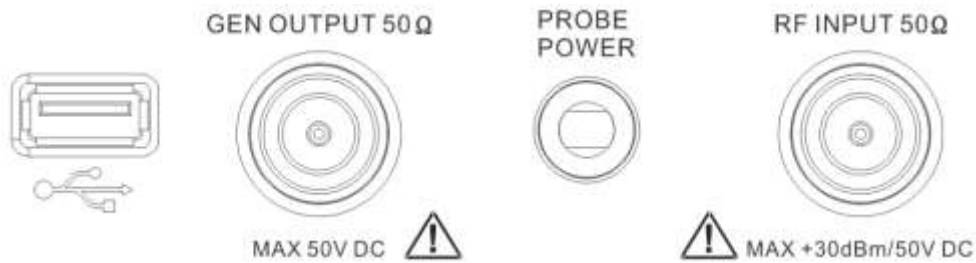
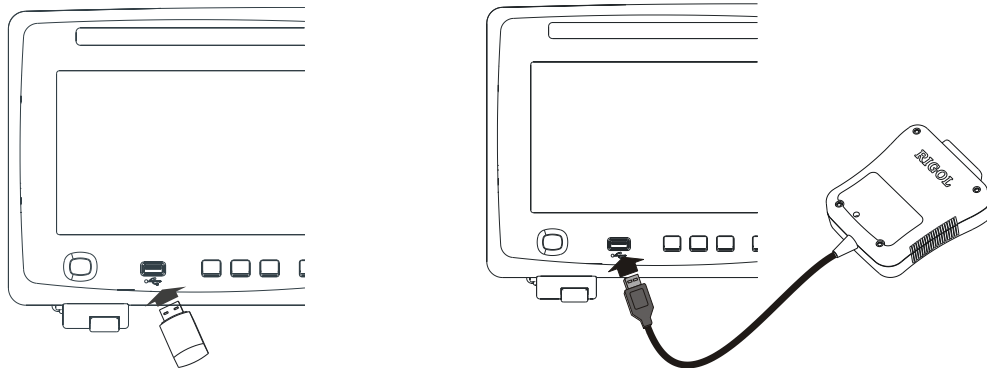

Figure 1-3 Front Panel Connectors

#### 1. USB Host

The analyzer may serve as a “host” device to connect to external USB devices. This interface is available for USB flash devices and the USB-GPIB module. See the following connections:



USB flash device connection

GPIB extended connection

Figure 1-4 USB Host interface connections

#### 2. GEN OUTPUT 50Ω

The output of the tracking generator can be connected to a receiver through an N male connector, see figure below. Note that the tracking generator is an option for DSA1030 (see **Appendix A: Options and Accessories**) you can order it when required.

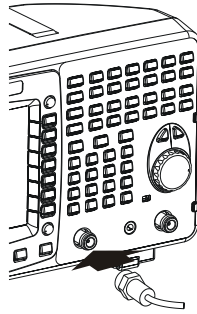

Figure 1-5 Tracking generator output connection

**CAUTION**

Reverse power or voltage mustn't be higher than 1 W or 50 V DC to avoid damages to the tracking generator.

**3. PROBE POWER**

This connector provides two lines of power supply to a RF probe: 15 V, 150 mA, and -12.6 V, 150 mA.

**4. RF INPUT 50Ω**

The RF input may be connected to a device under measure via an N male connector, see figure below.

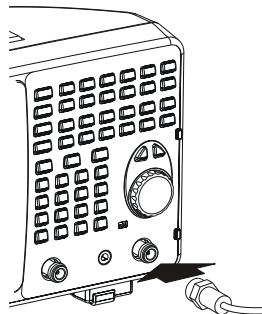

Figure 1-6 RF input connection

**CAUTION**

To avoid damages to the instrument, signals at the input terminal must be less than 50 V DC voltage components and 30 dBm (1 W) AC (RF) components.

## 1.2 Rear Panel

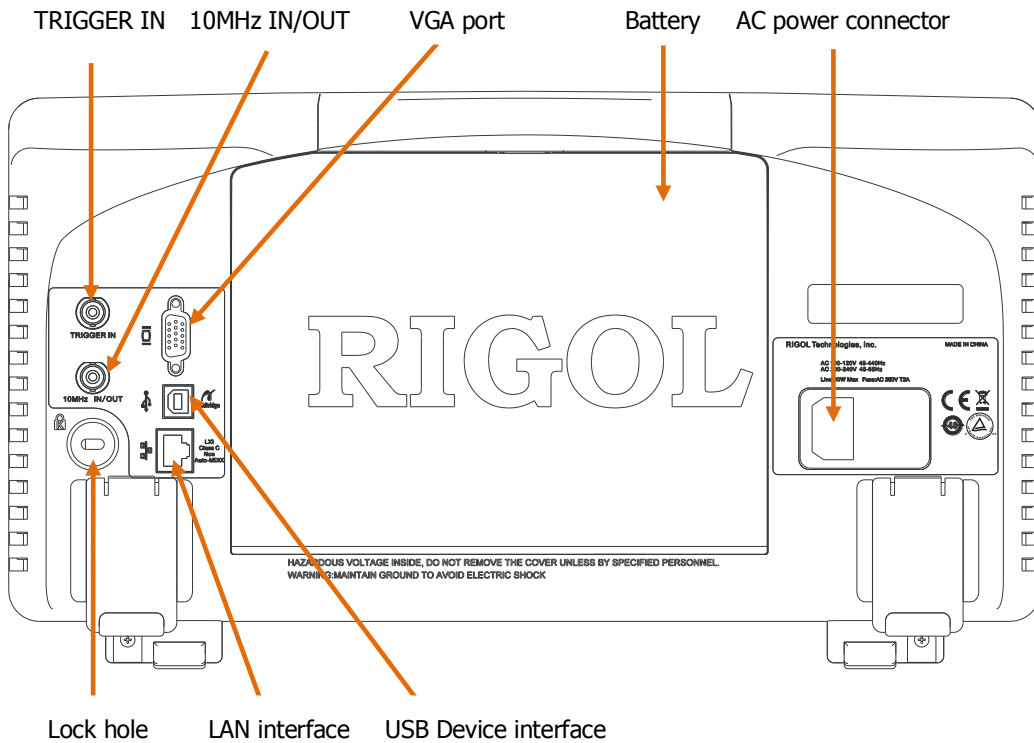

Figure 1-7 Rear panel overview

### 1. AC power connector

Available AC power supply types:

AC: 100 V - 120 V, 45 Hz - 60 Hz

AC: 200 V - 240 V, 45 Hz - 65 Hz

### 2. Rechargeable battery

An optional power source of 10 V - 18 V, a fully charged battery can provide 3 hours of continuous operation.

### 3. TRIGGER IN

A BNC external trigger signal input port, see figure below.

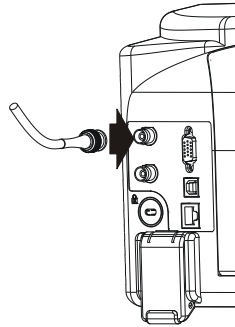

Figure 1-8 TRIGGER IN connection

#### 4. 10MHz IN/OUT

The BNC input or output of the 10 MHz reference clock, see figure below.

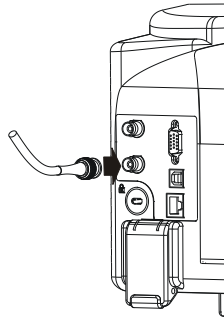

Figure 1-9 10 MHz IN/OUT connection

#### 5. VGA port

This port provides a VGA signal output which is used through a VGA cable, see figure below.

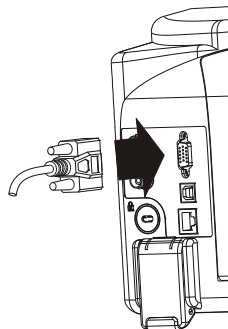

Figure 1-10 VGA port connection

## 6. USB Device interface

This configurable USB port permits external USB devices. It supports PictBridge printer and remote control connection.

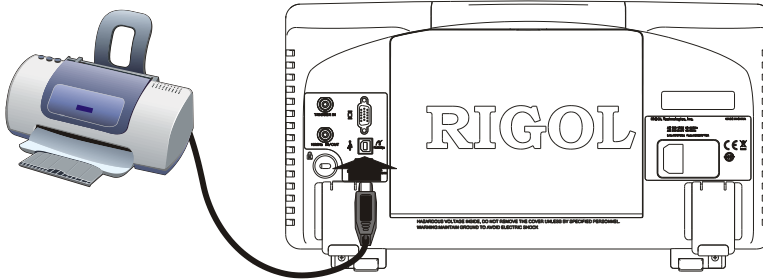

Figure 1-11 PictBridge printer connection

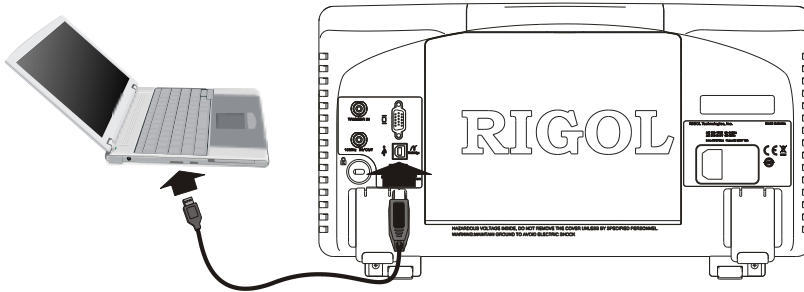

Figure 1-12 USB remote control connection

## 7. LAN interface

Through this interface, the analyzer can be connected to your local network for remote control. An integrated testing system may be built, as the analyzer conforms to the LXI-class C standard of LAN-based instrument control.

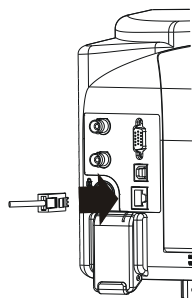

Figure 1-13 LAN connection

## 1.3 Prepare for Use

### 1.3.1 General Inspection

Please inspect your new analyzer according to the following steps:

**1. Inspect the shipping container for damage**

Keep the damaged shipping container or cushioning material until the contents of the shipment have been checked for completeness and the instrument has passed both electrical and mechanical tests.

The consigner or carrier shall be liable for the damage to instrument resulting from shipment. **RIGOL** would not be responsible for free maintenance/rework or replacement of the unit.

**2. Inspect the instrument**

In case of any damage, or defect, or failure, notify your **RIGOL** Sales Representative.

**3. Check the accessories**

The accessories supplied with the instrument are listed in "**Appendix A: Option and Accessories**". If your contents are incomplete or damaged, please notify your **RIGOL** Sales Representative.

### 1.3.2 Disassemble the Front Panel Cover

Before putting your analyzer into action, remove the front panel cover by releasing latches at both sides, and sliding in the direction of the arrows as shown in the figure below.

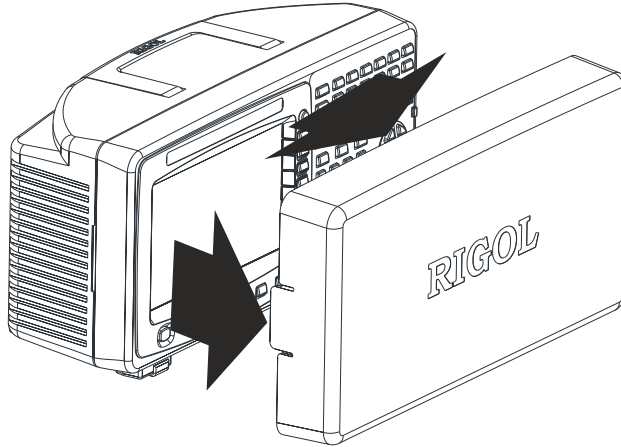

Figure 1-14 Disassemble the front panel cover

### 1.3.3 Adjust the Supporting Legs

If necessary, adjust the supporting legs of the analyzer to an appropriate position in the direction of the arrows as shown in the figure below.

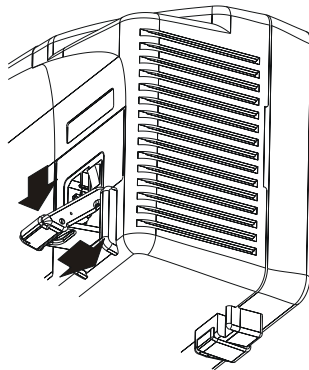

Figure 1-15 Adjust the supporting legs



## 1.3.4 Power Supply

The analyzer can be powered from AC power supply or rechargeable battery.

### 1.3.4.1 Connect AC Power Source

Please use the power cord provided for AC powering, see figure below. For the AC voltage and frequency requirements, refer to "**Rear Panel**".

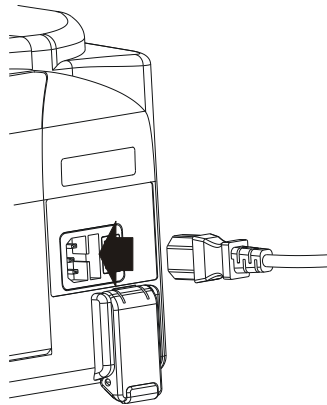

Figure 1-16 Power cord connection



---

**CAUTION**

Please ensure the instrument has been grounded correctly to avoid electrical shock.

---

### 1.3.4.2 Use the Battery

The analyzer provides an optional rechargeable battery. Please install it following the method below. An indicator  indicates whether the battery has been installed and its electrical power conditions.

- Green: electrical power >80%
- Orange: 20%< electrical power <80%
- Red: electrical power <20%
- All off: no battery is installed or the battery has zero power

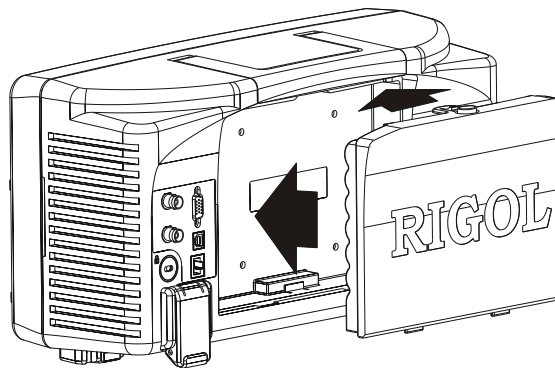

Figure 1-17 Install the battery

Note this battery is rechargeable, for the specific charging methods please refer to **“Charge the Battery”**.



---

**WARNING**

Please make sure the AC power to the analyzer has been cut off before installing the battery.

---

### 1.3.5 Power-On Check

Turn on the power switch at the rear panel, then press down the power button  on the front panel. You can monitor the initialization process according to the progress indicator during power-on. Upon completion of the initialization process, a sweep curve would be displayed.

### 1.3.6 Self Calibration

Press **System** → **Calibrate** → **Cal Now**, to use internal calibration resources to calibrate the system.

### 1.3.7 Use the Lock

If necessary, use a security lock to lock the analyzer in a desired location. See figure below, place the key into the lock hole in the direction of the arrow, turn it clockwise and then remove the key.

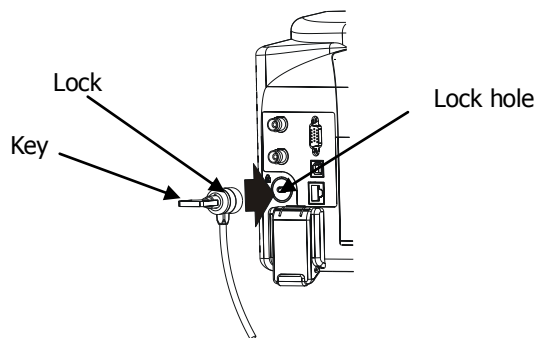

Figure 1-18 Use the lock

### 1.3.8 Change the Fuse

Please replace with specified fuse according to the following steps when needed:

1. Open the fuse lid at the power connector.
2. Dismount the fuse holder.
3. Replace with a new fuse.
4. Remount the fuse holder and close the lid.

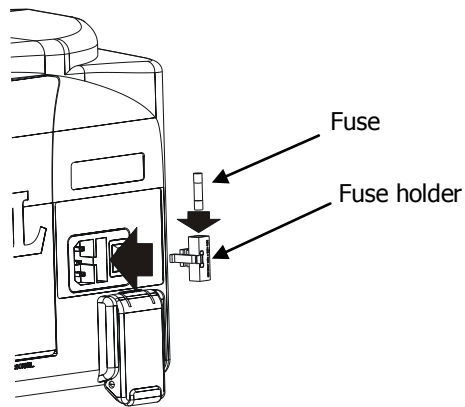

Figure 1-19 Change the fuse



---

**WARNING**

Please ensure that the instrument has been turned off and the power source has been cut off before replacing the fuse in order to avoid electrical shock.

---

### 1.3.9 Charge the Battery

Before charging, please install the battery in accordance with “**Use the Battery**”, then connect the AC power and turn on the power switch at the rear panel, the power button on the front can be in any state.

The indicator  on the front panel shows charging in progress. If the indicator is off, it indicates there is no electrical power at the moment; if the indicator is still dark after being charged for more than half an hour, remove the AC power and verify whether the battery has been installed properly or is faulty and damaged.

It would take about 10 hours to charge the battery fully regardless of whether the analyzer is working or in standby mode.

# 1.4 User Interface

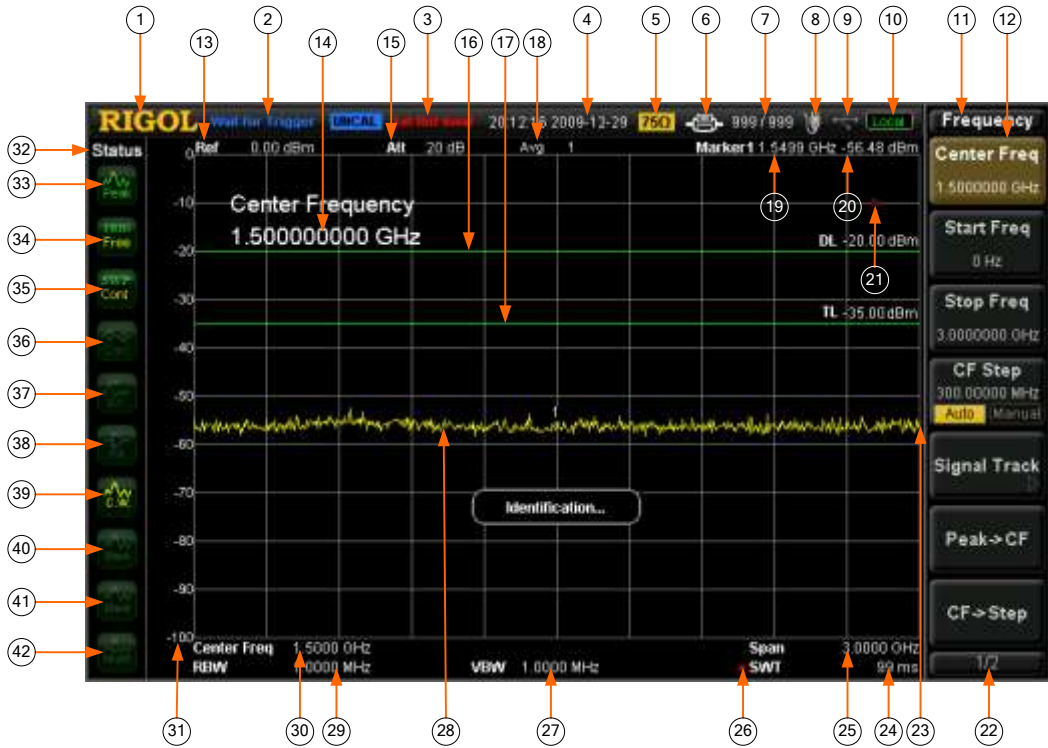











Figure 1-20 User interface

Table 1-3 User interface legends

NO.	Name	Description
1	LOGO	Logo of RIGOL company
2	System status (“UNCAL” and “Identification...” are in different locations)	Auto Tune Auto Range Wait for Trigger Calibrating UNCAL (Measurement Uncalibrated) Identification... (LXI Identification)
3	External reference	Ext Ref Ext Ref Invalid
4	Time	System time

## User interface legends (Continued)

NO.	Name	Description
5	Input impedance	Show "75Ω" if the current input impedance is 75Ω.
6	Printer status	  : Alternate display, denotes the printer now is connecting.  : Successful connection, print finish or idle.   : Alternate display, denotes printing.  : Denotes print has been paused.
7	Print process	Show current print copy and total print copies.
8	Power status	AC supply:  Battery supply: show electric quantity left 
9	USB flash device	Show if USB flash device is inserted; the mark  indicates successfully installed.
10	Operation status	Local or Rmt (Remote).
11	Menu title	Function of current menu belongs to.
12	Menu item	Menu item of current function.
13	Reference level	Reference level.
14	Active area	Current parameter and value.
15	Attenuator settings	Sets the Attenuator.
16	Display line	Reading reference and threshold condition for peak value.
17	Trigger level	Sets the trigger level in video trigger.
18	Average times	Average times of trace.
19	Cursor X	Current value of Cursor X. Note that X indicates different physical quantity in different functions.
20	Cursor Y	Current value of Cursor Y. Note that Y indicates different physical quantity in different functions.
21	Invalid data	Current measured data is invalid as a full sweep didn't complete after the system parameters have been modified.
22	Menu pages	Show total number of pages and current page number.
23	Sweep position	Current sweep position.
24	Sweep time	Sweep time.

## User interface legends (Continued)

NO.	Name	Description
25	Span or stop frequency	The frequency range of current sweep channel can be expressed by a combination of center frequency and span or a combination of start frequency and stop frequency.
26	Manual symbol	Parameters non-auto coupling.
27	VBW	Video resolution bandwidth.
28	Spectrum line area	For displaying spectrum line.
29	RBW	Resolution bandwidth of frequency.
30	Center or starting frequency	The frequency range of current sweep channel can be expressed by a combination of center frequency and span or a combination of starting frequency and stop frequency.
31	Y scale	Label of Y scale.
32	Parameter status	Icons on the left side of the screen indicate the status of system parameters.
33	Detection type	Pos peak, Neg peak, Sample, Normal, RMS Avg and Voltage Avg.
34	Trigger type	Free, video and external.
35	Sweep mode	Continuous or Single sweep (with current sweeping times showing)
36	Correction switch	Turn the Correction On or Off.
37	Signal tracking	Enable or disable signal tracking.
38	Preamplifier status*	Enable or disable the preamplifier.
39	Trace 1 types and status	Trace types: Clear Write, Max Hold, Min Hold, Video Avg and Power Avg. Trace status: yellow denotes On, and gray denotes Off.
40	Trace 2 types and status	Trace types: Clear Write, Max Hold, Min Hold, Video Avg and Power Avg. Trace status: purple denotes On, and gray denotes Off.

\*Note: For DSA1030 only.



## User interface legends (Continued)

<b>NO.</b>	<b>Name</b>	<b>Description</b>
41	Trace 3 types and status	Trace types: Clear Write, Max Hold, Min Hold, Video Avg and Power Avg. Trace status: light blue denotes On, and gray denotes Off.
42	MATH trace types and status	Trace types: A-B, A+C, A-C. Trace status: green denotes On, and gray denotes Off.

## 1.5 Menu Operation

There are 7 different menus with respect to different modes of operation:

### 1. Parameter Input

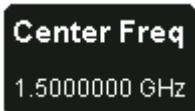

When selected, use the keyboard to modify the parameters directly.

For example: select **Center Freq**, input desired numbers and press **Enter** to change the value of center frequency.

### 2. State Switching



Press corresponding menu key to switch the sub option shown.

For example: press **Signal Track** → **On/Off** to turn on or off the tracking.

### 3. Enter Lower Menu (with parameter)

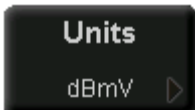

Press corresponding menu key to enter the lower menu and change its options.

For example: press **Units** to enter and select **dBmV**, the units for the Y-axis will be changed to dBmV after you return to the previous menu.

### 4. Enter Lower Menu (without parameter)

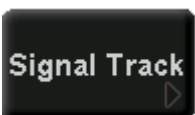

Press corresponding menu key to enter the lower menu.

For example: press **Signal Track** to enter directly.

## 5. Direct Execution



Execute the function after each press of the menu key.  
For example: press **Peak->CF** to execute a peak search and the center frequency of the analyzer will be set to the frequency of the current peak signal.

## 6. Function Switch + Parameter Input



Press corresponding menu key to switch between functions; change parameter directly from the keyboard.  
For example: press **CF Step** and switch between **Auto** and **Manual**; if select **Manual**, you can directly input desired numbers to change CF Step.

## 7. Selected State



Press corresponding menu key to modify parameter and return to the menu one level up.  
For example: press **Trig Type → Free Run**, which indicates the analyzer is in Free Run state at the present.

## 1.6 Parameter Input

In this part, you will learn how to enter desired parameter values from the numerical keyboard, the knob, and the directional keys.

### 1.6.1 Numeric Keyboard



Figure 1-21 The Numerical keyboard

The numerical keyboard consists of:

#### 1. Numerical keys

Numbers 0-9 are available to be used.

#### 2. Decimal point

A decimal point "." will be inserted at the cursor position when this key is pressed.

#### 3. Sign key

Sign key "+/-" is to toggle the sign of a parameter. When pressed the first time, a "-" will be inserted and changed into "+" following the second press.

#### 4. Unit keys

Unit keys include GHz/dBm/s, MHz/dB/ms, kHz/dBmV/μs and Hz/mV/ns. After entering the desired numbers, choose an appropriate unit to complete the parameter input. The specific meaning of unit is decided by the type of current input parameter ("frequency", "amplitude" or "time").

## 5. Enter

When pressed, the system will complete the input process and insert a default measuring unit for the parameter automatically.

## 6. Esc

- (1) During parameter editing process this key can clear the inputs in the active area and exit editing mode at the same time.
- (2) Turn off the display of active area.
- (3) Exit current test mode while in keyboard test.
- (4) Unlock the screen while it is locked.

## 7. Back

- (1) During the process of parameter editing, this key will delete the characters on the left side of the cursor.
- (2) While in the process of file name editing, pressing this key will delete characters that have been entered.

## 1.6.2 Knob



Figure 1-22 The knob

The knob has following functions:

1. During parameter editing, turn the knob clockwise to increase, or counterclockwise to decrease the parameter values at specified steps.
2. While editing a file name, the knob may select different characters from the soft keyboard.
3. Press **AMPT** → **Corrections** → **Edit**, and use the knob to select different reference points.

### 1.6.3 Direction key



Figure 1-23 Direction keys

The directional keys have following functions:

1. Increase or decrease the parameter value at specific steps while editing a parameter.
2. Move the cursor among root directory in **Storage** function.
3. Select the character in the upper or lower row of the soft keyboard while editing file name.
4. Select the adjacent reference points in **Edit** menu: **AMPT** → **Corrections** → **Edit**.

## 1.7 Basic Measurement

In this section, we introduce how to use the analyzer to do basic measurements. Considering a 50 MHz, 0dBm sine wave signal produced from a generator (such as RIGOL DG3101A).



### CAUTION

The signal amplitude must be less than 30 dBm (equal to 1 W), or else it will switch the input to a high power impedance state, and consequently the signal cannot be measured by the instrument.

### Procedures:

#### 1. Power on

#### 2. Reset to factory settings

Press **System** → **Reset** → **Preset Type** → **Factory**, and then **Preset**. The instrument will reset all the parameters to factory settings.

#### 3. Equipment Connection

Connect the signal output terminal of generator to the **RF INPUT 50Ω** terminal at the front panel of analyzer.

#### 4. Setup the Center Frequency

- (1) Press **FREQ**, a corresponding menu will appear on the right of the screen, and **Center Freq** is in high-bright state, meanwhile, the center frequency parameter is shown at the top left corner of the display grid, which indicates the **Center Frequency** is active.
- (2) Center frequency could be changed through the numerical keyboard, the knob, or the directional keys.
- (3) Input **50** and select **MHz** as its unit using the numerical keyboard, then the center frequency of the analyzer is set to **50 MHz**.

#### 5. Setup Span

- (1) Press **SPAN**, a corresponding menu will appear on the screen, and **Span** is in high-bright state, meanwhile, also the span parameter is shown at the top left corner of the display grid, which indicates **Span** is active.

- (2) Span value could be changed through the numerical keyboard, the knob, or the directional keys.
- (3) Input **20** and select **MHz** as its unit using the numerical keyboard, then the span of the analyzer is set to **20 MHz**.

## 6. Setup Amplitude

- (1) Press **AMPT**, **Ref Level** is in high-bright state, the reference level will be shown at the top left corner of the display grid, which indicates **Reference Level** is active.
- (2) Reference level could be changed through the numerical keyboard, the knob, or the directional keys.
- (3) If necessary, you can change the reference level using the knob so as to bring the signal peak value near the top of the grid based on the signal display.

When all the steps above are finished, a 50 MHz RF curve will be shown on the analyzer.

## 7. Read Result

The value of frequency and amplitude could be read from the Marker. Press **Marker** → **Select Mkr** → **1** to activate Marker 1 and set the marker frequency to "50MHz", then the frequency and amplitude of where the marker is located would be shown at the upper right of the display grid.

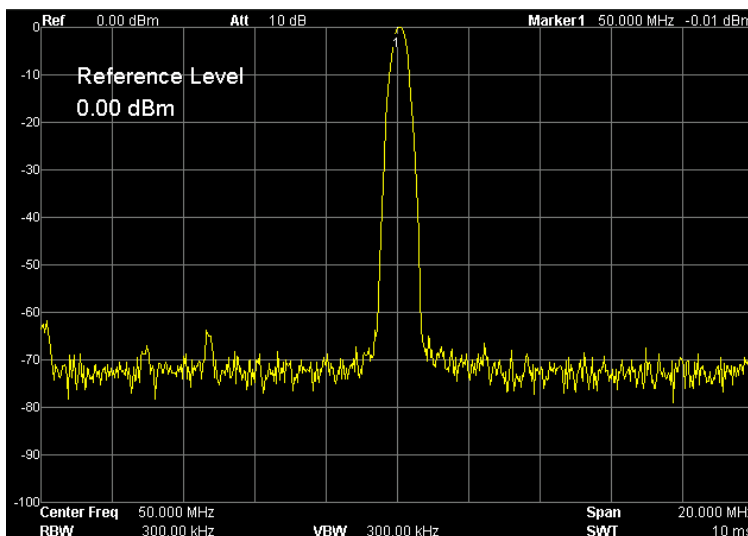

Figure 1-24 Measuring result



## 1.8 How to Use the Built-in Help

The built-in help provides information refers to every function key and menu key on the front panel. Users can view this help information if required.

### 1. How to acquire built-in help

Press **Help**; a prompt about how to obtain help information will be shown, then, repress the key related to the desired function, and the relevant information will be shown on the screen.

### 2. Page up and down

If there is more than one page of information, you can read the complete information by using the directional keys or the knob.

### 3. Close the current help information

Press any key on the front panel (except for up and down directional keys or the knob) to close the help.

### 4. Acquire the menu help

Press **Help**, a message about how to obtain help information will be shown, then, press the menu keys F1-F7 to get corresponding help.

### 5. Acquire the help information of any function key

Press **Help**, a message about how to obtain help information will be shown, then, press any function key to get corresponding help.

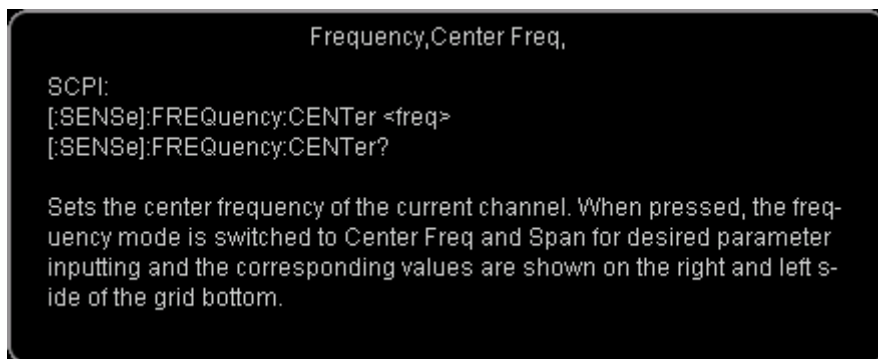

Figure 1-25 Built-in help



## 2 Front Panel Key Reference

This chapter describes in detail the function keys on the front panel and associated pull down menus. Note that a third class title such as **2.1.1 FREQ** always denotes a panel key of the analyzer, while a quaternary title such as **2.1.1.1 Center Freq** always denotes a menu softkey of a panel key.

Subjects in this chapter:

- Basic Settings
- Sweep Settings
- Function Settings
- Advanced Measurements (DSA1030 Option)
- Marker Measurements
- System Functions
- Screen Control

Note: The figure below shows the differences between DSA1030 and DSA1020. This chapter is mainly based on DSA1030.

NO.	Differentia	DSA1030	DSA1020
1	Max Span	3 GHz	2 GHz
2	Max Sweep Time	3000 s	2000 s
3	Tracking Generator Interface	Supported by option DSA1030-TG3	Hermetical
4	Tracking Generator	Supported by option DSA1030-TG3	Not supported
5	Preamplifier	Supported by option DSA1030-PA	Not supported
6	Advanced Measurements Demodulation Function	Supported by option DSA1000-AMK	Not supported

## 2.1 Basic Settings

### 2.1.1 FREQ

Sets the frequency parameters of the analyzer. The analyzer sweeps within a specified frequency range, and the sweep is restarted every time you change this parameter.

The frequency range of a channel can be expressed by either of two groups of parameters: Start Frequency and Stop Frequency; or Center Frequency and Span. If any such parameter is changed, the others would be adjusted automatically in order to ensure the coupling relationship between them.

$$f_{center} = (f_{stop} - f_{start}) / 2 \quad (\text{Equation 2-1})$$

$$f_{span} = f_{stop} - f_{start} \quad (\text{Equation 2-2})$$

$f_{center}$ ,  $f_{stop}$ ,  $f_{start}$  and  $f_{span}$  denotes the center frequency, the stop frequency, the start frequency and the span respectively.

#### 2.1.1.1 Center Freq

Sets the center frequency of the sweep. When pressed, the frequency mode is switched to Center Freq and Span in order to enter the desired parameter data. In this mode, parameters you specified are always shown at the lower right and the left side of the display grid.

#### Key Points:

- The start and stop frequencies vary with the center frequency when the span is constant.
- Changing the center frequency horizontally shifts the current sweep channel.
- In Zero Span mode, the start frequency, stop frequency and center frequency are always equal. If one is changed the others are updated to match.
- You can modify this parameter using the numeric keys, knob, or direction keys. Refer to "**Parameter Input**" for more details.

Table 2-1 Center Frequency

Parameter	Explanation
<b>Default</b>	1.5 GHz
<b>Range</b> *	0 Hz to 3 GHz
<b>Unit</b>	GHz, MHz, kHz, Hz
<b>Knob Step</b>	Span > 0, step = Span/200 Span = 0, step = RBW/100 Min = 1 Hz
<b>Direction Key Step</b>	CF step

Remark\*: The range is from 50 Hz to (3 GHz-50 Hz) in non-zero span.

### 2.1.1.2 Start Freq

Sets the start frequency of the sweep. When pressed, the frequency mode is switched to Start Freq and Stop Freq in order to enter the desired parameter data. In this mode, parameters you specified are always shown at the lower left and right side of the grid.

#### Key Points:

- The span and center frequency are changed automatically according to the start frequency. The change of the span would have influence on other system parameters. For more details, please refer to "Span".
- In Zero Span mode, the start frequency, stop frequency and center frequency are always equal. If one is changed the others are updated to match.
- You can modify this parameter using the numeric keys, knob, or direction keys. Refer to "**Parameter Input**" for more details.

Table 2-2 Start Frequency

Parameter	Explanation
<b>Default</b>	0 GHz
<b>Range</b> *	0 Hz to 3 GHz
<b>Unit</b>	GHz, MHz, kHz, Hz
<b>Knob Step</b>	Span > 0, step = Span/200 Span = 0, step = RBW/100 Min = 1 Hz
<b>Direction Key Step</b>	CF step

Remark\*: The range is from 0 Hz to (3 GHz-100 Hz) in non-zero span.

### 2.1.1.3 Stop Freq

Sets the stop frequency of the sweep. When pressed, the frequency mode is switched to Start Freq and Stop Freq in order to enter the desired parameter data. In this mode, parameters you specified are always shown at the lower left and the right side of the grid.

#### Key Points:

- Modifying the stop frequency changes the span and center frequency, and the change of span influences other system parameters, see "Span".
- You can modify this parameter using the numeric keys, knob, or direction keys. For more details, please refer to "**Parameter Input**".

Table 2-3 Stop frequency

Parameter	Explanation
Default	3 GHz
Range*	0 Hz to 3 GHz
Unit	GHz, MHz, kHz, Hz
Knob Step	Span > 0, step = Span/200 Span = 0, step = VBW/100 Min = 1 Hz
Direction Key Step	CF step

Remark\*: The range is from 100 Hz to 3 GHz in non-zero span.

### 2.1.1.4 CF Step

Sets the step magnitude of center frequency. Changing the center frequency in a fixed step continuously switches the channel to be measured.

#### Key Points:

- The CF step type could be "Manual" or "Auto". In Auto mode, the CF step is 1/10 of span if it is in Non-zero span mode or equals the RBW while in Zero span mode; in Manual mode, you can set the step using the numeric keys.
- After you set an appropriate CF step and select **Center Freq**, pressing the **Forward** or **Reverse** key from the **Channel** menu or using up and down direction keys to switch between measurement channels in a specified step in

order to sweep the adjacent channels manually.

- You can modify this parameter using the numeric keys, knob, or direction keys. For more details, please refer to "**Parameter Input**".

Table 2-4 CF step

Parameter	Explanation
<b>Default</b>	300 MHz
<b>Range</b>	1 Hz to 3 GHz
<b>Unit</b>	GHz, MHz, kHz, Hz
<b>Knob Step</b>	Span > 0, step = Span/200 Span = 0, step = 100 Hz Min = 1 Hz
<b>Direction Key Step</b>	in 1, 2, 5 sequence

#### Application

CF step lends itself to detect the harmonic waves and bandwidths that are beyond the current span.

For example, for each order of harmonic of a 100 MHz signal, we can set both the center frequency and CF step to 100 MHz, and press **Reverse** continuously to show the harmonics sequentially at the center of the frequency display.

### 2.1.1.5 Signal Track

Tracks signals with unstable frequency and less than 3 dB transient variation in amplitude by placing the Marker1 (see **Marker Measurements**) onto the measured signal to track the variation continuously.

The system tracks a signal according to the following steps:

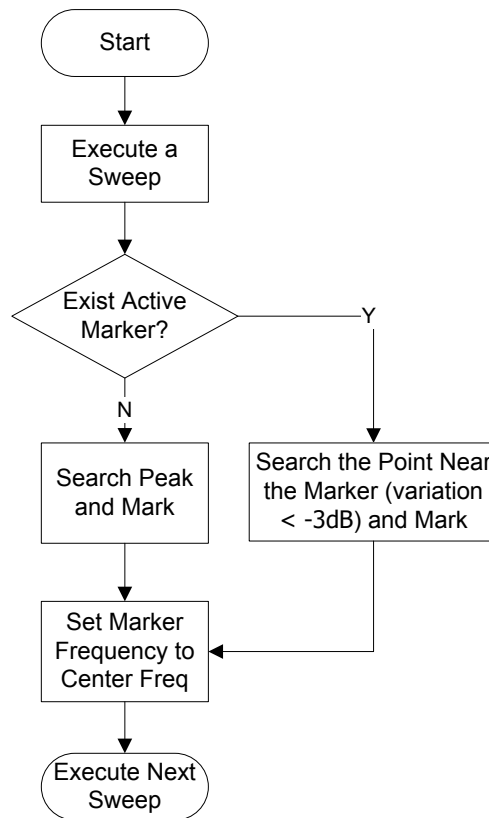



Figure 2-1 Process of signal tracking

### Key Points:

- When Signal Track is On, the system will execute peak search after every sweep, and set the frequency of current peak to center frequency, displaying signal at the center of screen all the time.
- When Signal Track is On, an icon  is shown at the left of screen. The signal will always stay at the screen center unless its amplitude changes by more than 3 dB between sweeps.
- If no marker is active, pressing this key will activate Marker 1 and execute a peak searching automatically; meanwhile the center frequency is used as the frequency of marker 1.
- In Continue sweep, the system tracks continuously; in Single sweep, only one track is done; in Zero Span, Signal Track is invalid.



### 2.1.1.6 Peak -> CF

Executes a peak search and uses the frequency of current peak as the center frequency of the analyzer. The function is invalid in Zero Span mode.

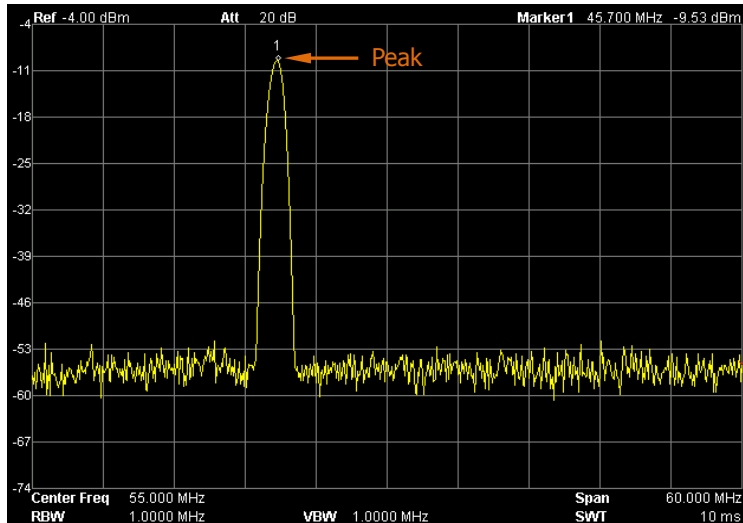

Figure 2-2 Before the Peak->CF

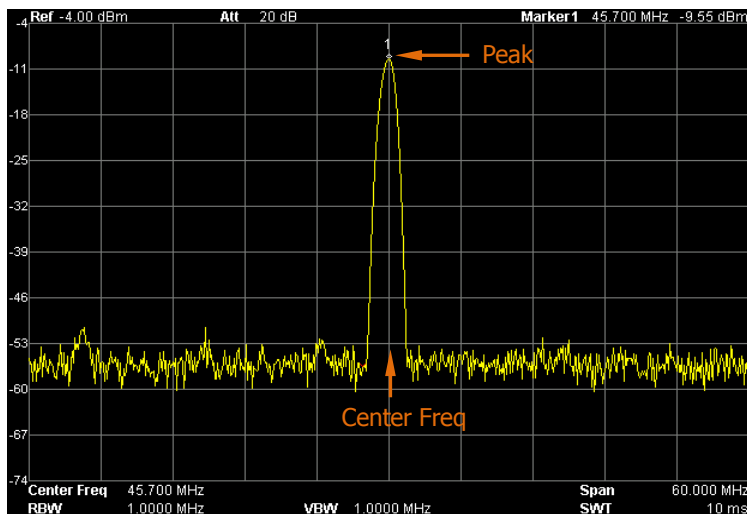

Figure 2-3 After the Before Peak->CF

### 2.1.1.7 CF -> Step

Sets the current center frequency as the CF step. This function is usually used with channel switching. Take harmonic waveform measurements for example: we can locate a signal at the center frequency of a channel, execute **CF-> Step** and then continuously press **Reverse** under the **Channel** menu to measure each harmonic in sequence.

### 2.1.1.8 Channel

Switches between channels according to the specified CF step.

#### 1. Forward

Selects the channel whose center frequency is CF step higher than the current center frequency setting. That is, increasing the center frequency by the specified CF step.

$$f'_{center} = f_{center} + f_{step} \quad (\text{Equation 2-3})$$

$f'_{center}$ ,  $f_{center}$  and  $f_{step}$  separately denotes the new center frequency, the current center frequency, and the CF step.

#### 2. Reverse

Selects the channel whose center frequency is CF step lower than the current center frequency setting. That is, decreasing the center frequency by the specified CF step.

$$f'_{center} = f_{center} - f_{step} \quad (\text{Equation 2-4})$$

## 2.1.2 SPAN

Sets the span value of the analyzer. The changing of this parameter will affect others parameters associated with the **FREQ** function, and restart the sweep.

### 2.1.2.1 Span

Sets the frequency range of the sweep. When pressed, the frequency mode is switched to Center Freq and Span in order to enter the desired parameter data. In this mode, parameters you specified are always shown at the lower left and the right side of the display grid.

#### Key Points:

- The start and stop frequency are changed with the span automatically.
- In manual span mode, the span can be set down to 100 Hz (the only way into the zero-span mode is to press the **Zero Span** menu option) and up to the full span described in the specification.
- Modifying the span in non-zero span mode may cause an automatic change in both CF step and RBW if they were in Auto mode, and the change of RBW may influence VBW (in Auto VBW mode).
- Any variation in the span, RBW and VBW may cause a change in sweep time.
- In non-zero span mode, neither "Video" trigger nor "1/ $\Delta$ time" readout function is valid.
- You can modify this parameter using the numeric keys, knob, or direction keys. For more details, please refer to "**Parameter Input**".

Table 2-5 Span

Parameter	Explanation
<b>Default</b>	3 GHz
<b>Range*</b>	0 Hz to 3 GHz
<b>Unit</b>	GHz, MHz, kHz, Hz
<b>Knob Step</b>	Span/200, Min = 1 Hz
<b>Direction Key Step</b>	in 1, 2, 5 sequence

Remark\*: 0 Hz is available only in zero span.

### 2.1.2.2 Full Span

Sets the span of the analyzer to the maximum.

### 2.1.2.3 Zero Span

Sets the span of the analyzer to 0 Hz. Both the start and stop frequency will equal the center frequency and the horizontal axis will denote time. The analyzer here is measuring the time domain characteristics of amplitude, located at the corresponding frequency point.

#### Key Points:

As opposed to the Non-zero span, the screen shows the time domain characteristics of the fixed frequency component, and following functions are invalid in Zero span mode:

- **FREQ**: Peak->CF, Signal Track and Channel setting;
- **SPAN**: Zoom In and Zoom Out;
- **Marker->**: Mkr->CF, Mkr->Step, Mkr->Start, Mkr->Stop, Mkr $\Delta$ ->CF and Mkr $\Delta$ ->Span;
- **Marker**: Readout  $\rightarrow$  Frequency, Period and  $1/\Delta$ Time (valid in Delta marker type)

### 2.1.2.4 Zoom In

Sets the span to the half of its current value (down to the minimum).

### 2.1.2.5 Zoom Out

Sets the span to twice the current value (up to the maximum).

### 2.1.2.6 Last Span

Changes the span to the previous span setting.

## 2.1.3 AMPT

Sets the amplitude parameters of the analyzer. Through these parameters, signals under measurement can be displayed at an optimal view with minimum error.

### 2.1.3.1 Auto Scale

This setting enables the readout resolution of the current Y-axis to be the maximum possible on condition that the whole signal is within the screen. When enabled, the system sets the reference level automatically in order to place the peak of signal within the topmost grip.

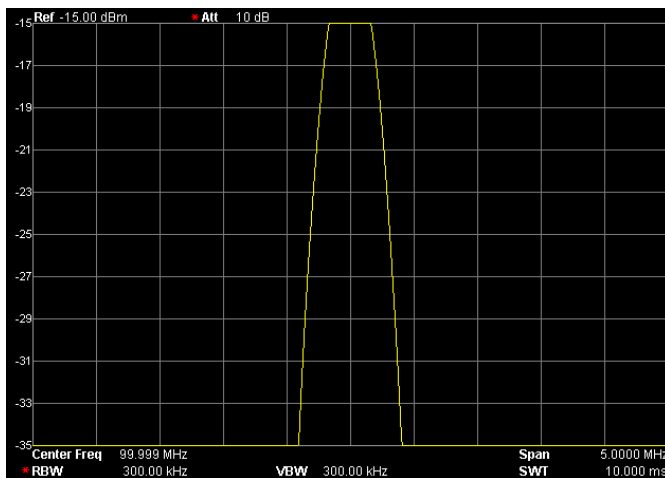

Figure 2-4 Before the Auto Scale

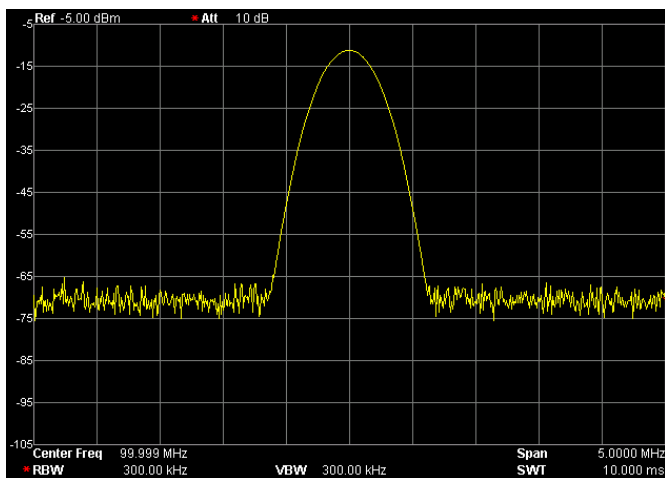

Figure 2-5 After the Auto Scale

### 2.1.3.2 Ref Level

Sets the maximum power or voltage to be displayed at the upper left of the display grid.

#### Key Points:

- This value is affected by a combination of maximum mixing level, input attenuation, and preamplifier. When you adjust it, the input attenuation is adjusted under a constant max mixing level, meeting:

$$L_{Ref} - a_{RF} + a_{PA} \leq L_{mix} \quad (\text{Inequality 2-5})$$

$L_{Ref}$ ,  $a_{RF}$ ,  $a_{PA}$  and  $L_{mix}$  denotes the reference level, the input attenuation, the preamplifier (For DSA1030), and the max mixing level, respectively.

- You can modify this parameter using the numeric keys, knob, or direction keys. For more details, please refer to "**Parameter Input**".

Table 2-6 Reference level

Parameter	Explanation
Default	0 dBm
Range	-100 dBm to 30 dBm
Unit	dBm, -dBm, mV, uV
Knob Step	in Log scale mode, step = Scale/10 in Lin scale mode, step = 0.1 dB
Direction Key Step	in Log scale mode, step = Scale in Lin scale mode, step = 1 dBm

### 2.1.3.3 Input Atten

Sets the front attenuator of the RF input in order to permit big signals (or small signals) to pass from the mixer with low distortion (or low noise).

#### Key Points:

- When the preamplifier is On, the input attenuation could be set up to 30 dB. You can adjust the reference level to ensure that the specified parameters meet the inequality in formula 2-5 (above).

- You can modify this parameter using the numeric keys, knob, or direction keys. For more details, please refer to "**Parameter Input**".

Table 2-7 Input attenuation

Parameter	Explanation
<b>Default</b>	10 dB
<b>Range</b>	0 dB to 50 dB
<b>Unit</b>	dB
<b>Knob Step</b>	5 dB
<b>Direction Key Step</b>	5 dB
<b>Keyboard Step</b>	1 dB

### 2.1.3.4 Scale/Div

Sets the logarithmic units per vertical grid division on the display.

#### Key Points:

- By changing the scale, the displayed amplitude range is adjusted.
- The maximum amplitude that can be displayed is equal to the reference level, and the minimum is the difference between the reference level and 10 times the current scale value.
- You can modify this parameter using the numeric keys, knob, or direction keys. For more details, please refer to "**Parameter Input**".

Table 2-8 Scale

Parameter	Explanation
<b>Default</b>	10 dB
<b>Range</b>	0.1 dB to 20 dB
<b>Unit</b>	dB
<b>Knob Step</b>	Scale $\geq 1$ , step = 1 dB Scale $< 1$ , step = 0.1 dB
<b>Direction Key Step</b>	in 1, 2, 5 sequence

### 2.1.3.5 Scale Type

Sets the Scale Type of Y-axis to Lin or Log, the default is Log.

#### Key Points:

- In Log scale type: the Y-axis denotes the logarithmic coordinates, the value shown at top of the grid is the reference level and the grid size is equal to the scale value. The unit of Y-axis will be automatically switched into the default "dBm" when the scale type is changed from Lin to Log.
- In Lin scale type: the Y-axis denotes the linear coordinates, the value shown at the top of the grid is the reference level and the bottom of the grid shows 0 V. The grid size is 10% of the Reference level and the Scale/Div is invalid. The unit of Y-axis will be automatically switched into the default "Volts" when the scale type is changed from Log to Lin.
- Other than as mentioned above, the unit of Y-axis is independent of the Scale Type.

### 2.1.3.6 Units

Sets the unit of the Y-axis to dBm, dBmV, dBuV, Volts or Watts. The units dBm, dBmV, and dBuV are for Log scaling; Volts and Watts are for Linear scaling. The default is dBm.

#### Key Points:

See relationships between each unit:

$$dBm = 10\log\left(\frac{Volts^2}{R} \times \frac{1}{0.001W}\right) \quad (\text{Equation 2-6})$$

$$dB\mu V = 20\log\left(\frac{Volts \times 10^6}{1\mu V}\right) \quad (\text{Equation 2-7})$$

$$dBmV = 20\log\left(\frac{Volts \times 10^3}{1mV}\right) \quad (\text{Equation 2-8})$$



$$Watts = \frac{Volts^2}{R} \quad \text{(Equation 2-9)}$$

Where, R denotes the reference resistance.

### 2.1.3.7 Ref Offset

Assigns an offset to the reference level to attempt to compensate for gains or losses generated between the device under measurement and the analyzer.

#### Key Points:

- The changing of this value changes both the readout of the reference level and the amplitude readout of the marker, but will not impact the position of the curve on the screen.
- You can modify this parameter using the numeric keys. For more details, please refer to "**Parameter Input**".

Table 2-9 Reference level offset

Parameter	Explanation
Default	0 dB
Range	-300 dB to 300 dB
Unit	dB
Knob Step	N/A
Direction Key Step	N/A

### 2.1.3.8 Auto Range

Adjusts the amplitude parameters within the specified span range automatically in order to display the whole signal optimally on the grid.

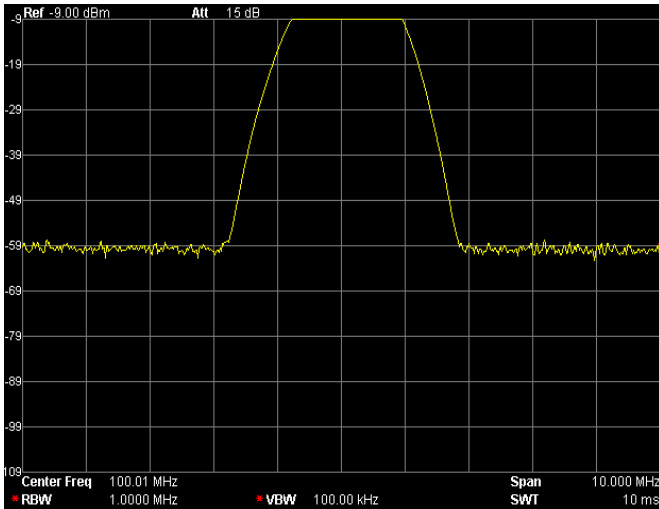

Figure 2-6 Before the Auto Range

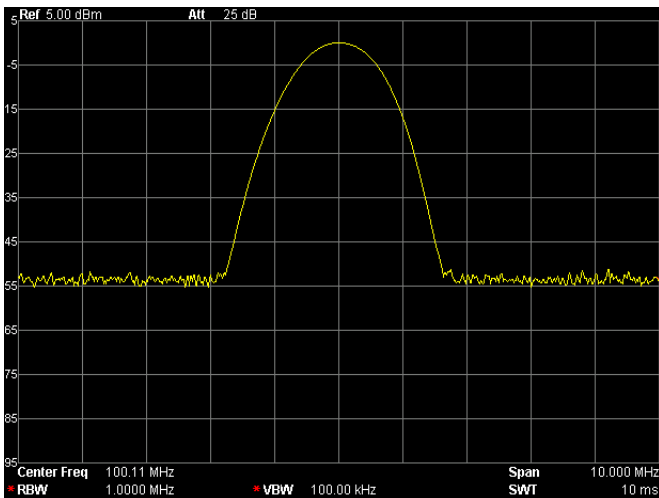

Figure 2-7 After the Auto Range

**Key Points:**

- Unlike Auto Scale, this function can solve the problem of an overrange measurement due to parameter settings and adjust the max mixing level based on the signal under measurement.
- Unlike Auto Tune, this function is focused on the signal within the current channel and will not make any changes to the channel frequency, while, Auto Tune will search for signals within the full band frequency and adjust the displayed frequency so the detected signals are at the center frequency.

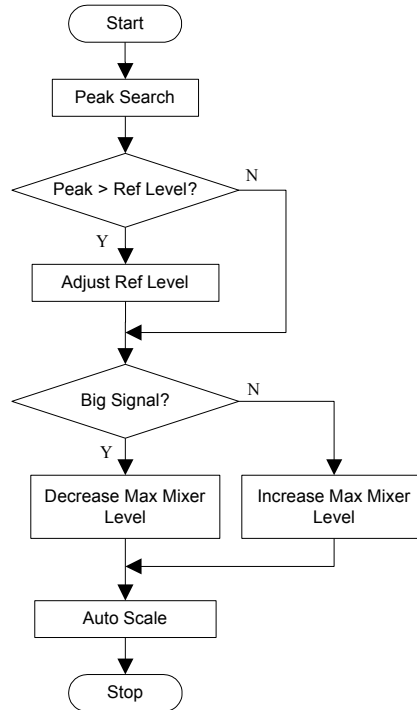



Figure 2-8 Process of the Auto Range

### 2.1.3.9 RF Preamp

Sets the status of preamplifier located at the front of the RF signal path. Turning on the preamplifier reduces the displayed average noise level in order to distinguish small signals from the noise when working with small signals.

#### Key Points:

- An icon  will be displayed on the left of screen when the preamplifier is **On**.
- The preamplifier will be disabled automatically when the input attenuation is set higher than 30 dB.

### 2.1.3.10 Correction

Corrects the amplitude in order to compensate for the gain or loss from peripheral equipment such as Antenna, Cable, and so on. When using this function, you can view

the correction parameters through a table and save or load the correction factors during editing. When Correction is On, both the trace and related measurement results will be corrected, and an icon  is shown on the left of screen.

### 1. Select

Chooses a correction factor from Antenna, Cable, Other or User for the current correction. All related frequency and amplitude corrections will be displayed to compensate for external gains or losses, the default is Off.

### 2. Correction

Enables or disables the amplitude correction, the default is Off. When you enable the Correction, the system starts correcting the amplitude with a specified factor. If more factors are added, all related data will be used for amplitude correction.

### 3. Edit

Sets or modifies the frequency and amplitude of correction factor. You can modify this parameter using the numeric keys, knob, or direction keys. See table below:

Table 2-10 Edit menus of Amplitude correction

Menu	Explanation
<b>Point</b>	Create or set desired data point for correction factor Range: 1 to 200
<b>Frequency</b>	Set the frequency of specified point
<b>Amplitude</b>	Set the amplitude of specified point Range: -120 dB to 100 dB
<b>Del Point</b>	Delete the specified point data: frequency and amplitude correction.

### 4. Freq Interp

Selects the correction type to Lin or Log. In type of Lin, the frequency and amplitude separately uses a Lin and Log unit to do interpolation; in type of Log, both of parameters use a Log unit.

### 5. Delete

Clears the frequency and amplitude correction data of the selected factor.

### 6. Corr Table

Turns on or off the edited correction table. At this moment, the screen is divided

into two parts, the upper shows the measurement curve and the lower shows the edited points, frequency, and amplitude.

## 7. Corr View

- All: view the data for all correction factors.
- Sel: view the data for selected correction factor.

### 2.1.3.11 MaxMixL

Sets the max input level of mixer according to the magnitude of signal.

#### Key Points:

- For a bigger input signal, choosing a smaller max mixing level can increase the input attenuation and reduce the distortion of the signal; for a smaller input signal, choosing a bigger max mixing level can reduce the input attenuation and noise.
- Parameters in Inequality 2-5 are always changing on the basis of the max mixing level.
- You can modify this parameter using the numeric keys, knob, or direction keys. For more details, please refer to "**Parameter Input**".

Table 2-11 Max mixing level

Parameter	Explanation
Default	-10 dBm
Range	-50 dBm to 0 dBm
Unit	dBm, -dBm, mV, uV
Knob Step	1 dBm
Direction Key Step	10 dBm

### 2.1.3.12 Input

Sets the input impedance for voltage-to-power conversions (see Equation 2-6). The default is 50Ω. To measure a 75Ω device, you should use a 75Ω to 50Ω adapter supplied by **RIGOL** to connect the analyzer with the system under test and then set this menu to 75 Ω. Note that a "75 Ω" sign will be shown in the status bar of the screen in this situation.

## 2.2 Sweep Settings

### 2.2.1 BW

Sets the RBW (Resolution Bandwidth) and VBW (Video Bandwidth) parameters of the analyzer.

#### 2.2.1.1 RBW

Sets the desired resolution bandwidth in order to distinguish between signals which are close in frequency.

##### Key Points:

- Reducing the value of RBW will increase the frequency resolution, but may also cause sweeps to take longer (Sweep Time is effected by a combination of RBW and VBW when it is in Auto mode).
- RBW decreases with the span (non-zero span) in Auto RBW mode.

Table 2-12 RBW

Parameter	Explanation
Default	1 MHz
Range	100 Hz to 1 MHz
Unit	GHz, MHz, kHz, Hz
Knob Step	in 1, 3, 10 sequence
Direction Key Step	in 1, 3, 10 sequence

#### 2.2.1.2 VBW

Sets the desired video bandwidth in order to remove the band noise.

##### Key Points:

- Reducing the VBW to smooth the spectrum line and differentiate small signals from the noise. However, this may cause a longer sweep time. (Sweep Time is effected by a combination of RBW and VBW when both of them are in Auto

mode).

- VBW varies with RBW when it is set to Auto.

Table 2-13 VBW

Parameter	Explanation
<b>Default</b>	1 MHz
<b>Range</b>	1 Hz to 3 MHz
<b>Unit</b>	GHz, MHz, kHz, Hz
<b>Knob Step</b>	in 1, 3, 10 sequence
<b>Direction Key Step</b>	in 1, 3, 10 sequence

### 2.2.1.3 V/R Ratio

Sets the ratio of VBW to RBW.

#### Key Points:

- This value is different while measuring different kinds of signals:
  - Sine signal: use 1 - 3 (for faster sweeps)
  - Pulse signal: use 10 (to reduce the influence of the amplitude of transient signals)
  - Noise signal: 0.1 is perfect (to obtain an average of noises)
- You can modify this parameter using the numeric keys, knob, or direction keys. For more details, please refer to "**Parameter Input**".

Table 2-14 V/R Ratio

Parameter	Explanation
<b>Default</b>	1
<b>Range</b>	0.0000010 to 300000.00
<b>Unit</b>	N/A
<b>Knob Step</b>	in 1, 3, 10 sequence
<b>Direction Key Step</b>	in 1, 3, 10 sequence

## 2.2.2 Sweep

Sets parameters about the Sweep function, including Time, Auto SWT, Mode, Numbers and Points.

### 2.2.2.1 Time

Sets the time interval for the analyzer to complete a sweep. Either Auto or Manual can be used, the default is Auto.

#### Key Points:

- In non-zero span, the analyzer uses the shortest sweep time on the basis of the current RBW and VBW settings if Auto is selected.
- Decreasing the sweep time may speed the measurement. However, an error may be caused if the specified time is less than the minimum duration in Auto coupling, and a character like "UNCAL" is shown at the status bar of the screen.
- You can modify this parameter using the numeric keys, knob, or direction keys. For more details, please refer to "**Parameter Input**".

Table 2-15 Sweep time

Parameter	Explanation
<b>Default</b>	100 ms
<b>Range*</b>	20 us to 3000 s
<b>Unit</b>	ks, s, ms, us, ns, ps
<b>Knob Step</b>	Sweep time/100, Min = 1 ms
<b>Direction Key Step</b>	in 1, 1.5, 2, 3, 5, 7.5 sequence

Remark\*: The minimum in non-zero span mode is 10 ms.

### 2.2.2.2 Auto SWT

Sets the auto type of the sweep time to Normal or Accy. The sweep will be faster if you select Normal; while in Accy type, higher measurement precision can be obtained.



### 2.2.2.3 Mode

Sets the sweep mode to Single or Continuous, the default is Continuous. If you select Single, the backlight of **Single** located on the front panel turns on, and so does the **Continue** when **Cont** is selected. The corresponding parameters and type icons are shown on the left side of screen.



**Continue:** the character **Cont** from the parameter icon is the abbreviation of the Continuous, which denotes the analyzer is sweeping continuously.

**Single:** the number **10** from the parameter icon denotes the current sweep number.

### 2.2.2.4 Numbers

Sets the number of times for a single sweep. In Single mode, the system executes specified sweeps. The number shown on the left status icon of the screen varies with the process of sweep.

Table 2-16 Numbers

Parameter	Explanation
Default	1
Range	1 - 9999
Unit	N/A
Knob Step	1
Direction Key Step	1

### 2.2.2.5 Points

Sets the desired points for every sweep. That is the number of points of the current trace.

#### Key Points:

- Changing the points may influence the sweep time which is limited by the sample rate of the ADC (Analog to Digital Converter). That is, the more points used, the longer the sweep will be.
- Changing the points may also influence other system parameters, which may restart the sweep and measurement cycle.
- You can modify this parameter using the numeric keys, knob or direction keys. For more details, please refer to "**Parameter Input**".

Table 2-17 Points

Parameter	Explanation
Default	601
Range	101 to 3001
Unit	N/A
Knob Step	1
Direction Key Step	100

**NOTE**

- With the increase (more than 601) of sweep points, the frequency resolution of marker points increases and the sweep speed decreases.
- In addition to the number of sweep points, other parameters such as span, resolution bandwidth, video bandwidth, average detection method, and center frequency can also influence the sweep speed.

## 2.2.3 Auto Tune

Searches for signals automatically throughout the full frequency range and adjusts the analyzer to the best frequency and amplitude for displaying these signals.

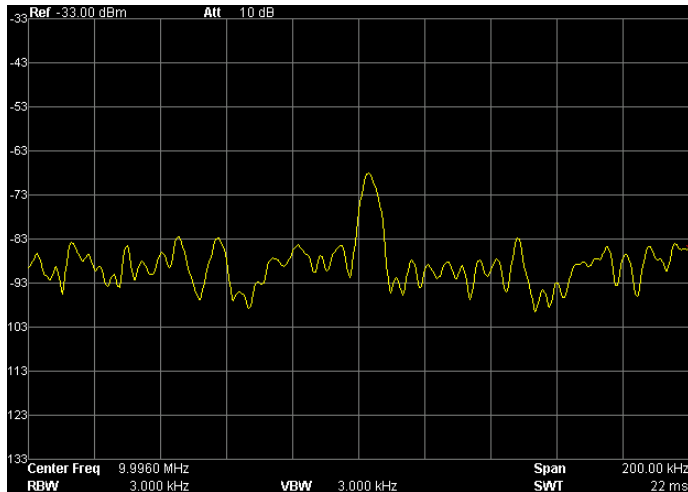

Figure 2-9 Before the Auto Tune

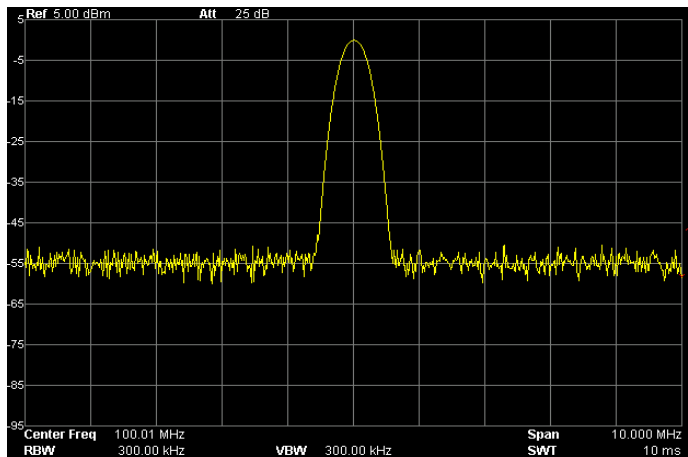

Figure 2-10 After the Auto Tune

### Key Points:

- In the process of searching, the backlight of **Auto Tune** turns on and a character like "Auto Tune" is shown on the status bar of the screen until the search is finished.
- In Auto mode, press **Auto Tune** to stop the search.

- The magnitude of some parameters such as reference level, scale, input attenuation, and max mixing level may be changed during the auto tune.

## 2.2.4 Trig

Sets the trigger type and other associated parameters.

### 2.2.4.1 Trig Type

The trig type can be Free Run, Video or External. In each type of Trig, there will be a related parameter icon shown on the left of screen such as:



#### 1. Free Run

This indicates all trigger conditions can be satisfied at any time and the analyzer generates trigger signals continuously.

#### 2. Video

This indicates a trigger signal will be generated when the system detects a video signal in which the voltage exceeds the specified video trigger level. This function is invalid in one of the three conditions which are non-zero span mode, RMS Avg detection and Voltage Avg detection.

#### 3. External

In this mode, an external signal (TTL signal) is input from the **TRIGGER IN** connector at the rear panel, of which the edge conditions should meet with the user settings to generate trigger signals.

### 2.2.4.2 Trig Setup

#### 1. Trigger Level

Sets the trigger level in Video mode. The screen will display corresponding line TL and the value of it after you finish the setting. The numeric keys, knob or direction keys is available for level modification, please refer to "**Parameter Input**" for more details.

Table 2-18 Trigger level

<b>Parameter</b>	<b>Explanation</b>
<b>Default</b>	0 dBm
<b>Range</b>	-300 dBm to 50 dBm
<b>Unit*</b>	dBm
<b>Knob Step</b>	1 dBm
<b>Direction Key Step</b>	10 dBm

Remark\*: This is in connection with the specified unit of Y-axis.

## 2. Edge

Sets the trigger edge to Positive or Negative.

## 2.2.5 Single

Sets the sweep mode to Single.

### Key Points:

- If it is in Continuous sweep mode and no measurement function is enabled, pressing this key will enter the Single sweep mode and execute specified sweeps on the condition that all trigger conditions are satisfied.
- If it is in Continuous sweep mode and a measurement function is on, pressing this key will enter the Single measure mode and execute specified measurements on the condition that all trigger conditions are satisfied.
- If the system is already in Single sweep mode, pressing this key will execute specified sweeps (or measurements) on the condition that all trigger conditions are satisfied.
- In Single sweep mode, trigger initialization (pressing **Single** or sending an INIT command through the remote interface) should be executed before you judge the trigger condition.

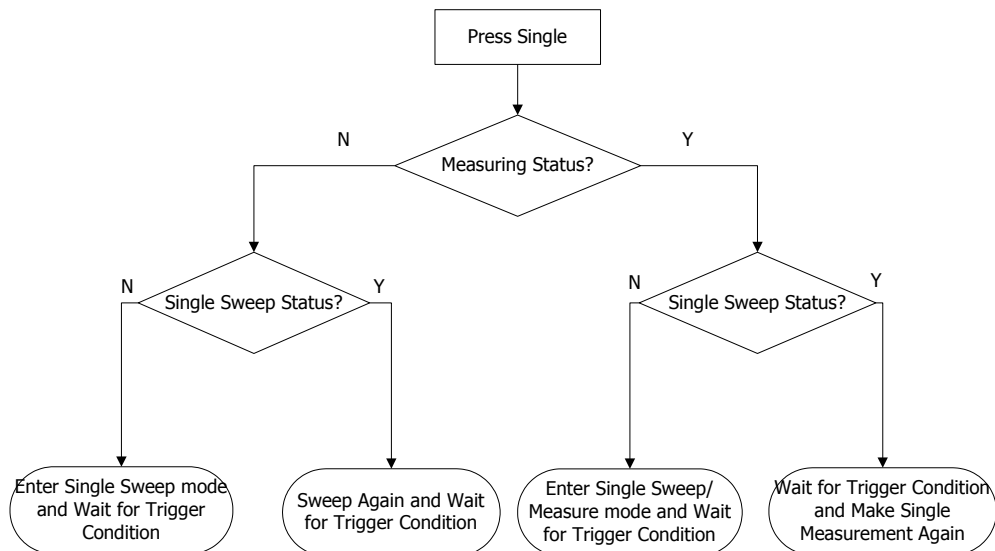

Figure 2-11 Process of a single sweep

## 2.2.6 Continue

Sets the sweep mode to Continuous.

### Key Points:

- If the instrument is in Single sweep mode and no measurement function is enabled, pressing this key will enter the Continuous mode and execute specified sweeps on the condition that all trigger conditions are satisfied.
- If the instrument is in Single sweep mode and a measurement function is on, pressing this key will enter the Continuous mode and execute specified measurements on the condition that all trigger conditions are satisfied.
- In Continuous mode, the system will send a trigger initialization signal automatically and enter the trigger judgment directly.

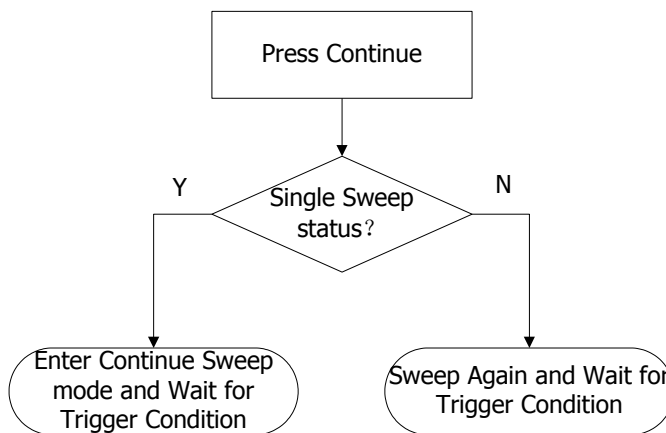

Figure 2-12 Process of continue sweep



## 2.3 Function Settings

### 2.3.1 Detector

While displaying a wider span, each pixel contains spectrum information associated with a larger subrange. That is, several samples may fall on one pixel. Which of the samples will be represented by the pixel depends on the selected detector type. See the working principle of the detector below:

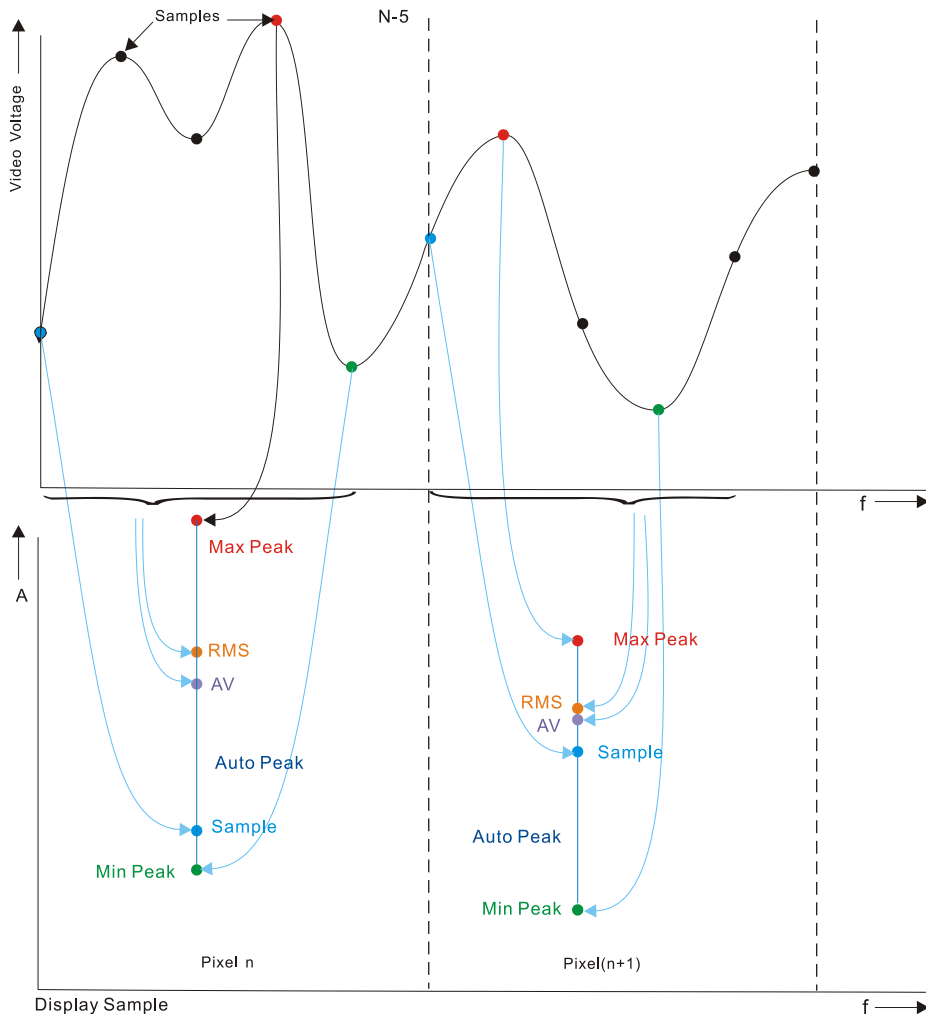

Figure 2-13 Working principle of the detector

**Key Points:**

- Select an appropriate type according to the application in order to ensure the accuracy of the measurement for your application.
- The available types are: Pos Peak, Neg Peak, Sample, Normal, RMS Avg and Voltage Avg, the default is Pos peak.
- Every selected type is shown with a parameter icon on the left status bar of screen, see below:

**2.3.1.1 Pos Peak**

Searches the maximum from the sampling data segment and displays it at the corresponding pixel.

**2.3.1.2 Neg Peak**

Searches the minimum from the sampling data segment and displays it at the corresponding pixel.

**2.3.1.3 Sample**

Chooses any point data from the sampling data segment and displays at the corresponding pixel.

**2.3.1.4 Normal**

Searches both the minimum and maximum from the sampling data segment and displays them at the corresponding pixel. In this type, you can observe the rangeability of a signal in real time.

### 2.3.1.5 RMS Avg

Calculates the data from the sampling data segment with mean square root operation (see equation below) and displays the result as a pixel. In this type, noise can be rejected and weak signals can be clearly observed.

$$V_{RMS} = \sqrt{\frac{1}{N} \times \sum_{i=1}^N v_i^2} \quad (\text{Equation 2-10})$$

Where  $V_{RMS}$  = RMS value of voltage, in V

$N$  = number of samples assigned for every pixel

$v_i$  = samples of the envelope, in V

The reference resistance  $R$  can be used for calculating the power:

$$P = \frac{V_{RMS}^2}{R}$$

### 2.3.1.6 Voltage Avg

Averages all the data from the sampling segment (see equation below) and displays the result as a pixel.

$$V_{AV} = \frac{1}{N} \times \sum_{i=1}^N v_i \quad (\text{Equation 2-11})$$

Where  $V_{AV}$  = average of voltage, in V

$N$  = number of samples assigned for every pixel

$v_i$  = samples of the envelope, in V

## 2.3.2 Trace

As the sweep signal is displayed as a trace on the screen, you can set parameters about the trace using this key. The analyzer allows for up to four traces to be displayed at one time, and each trace has its own color (Trace 1 - Yellow, Trace 2 - purple, Trace 3 – light blue and Trace 4 - green). All traces can be set freely except Trace 4 (a math operation trace that can only be obtained using the other three traces).

### 2.3.2.1 Select Trace

Selects Trace 1, Trace 2 or Trace 3 in order to set parameters associated with each. The default trace and type is Trace 1 and Clear Write.

### 2.3.2.2 Trace Type

Sets the type of the current trace or disables it. The system calculates the sample data using a specific operation according to the selected type and displays the result. Trace type contains Clear Write, Max Hold, Min Hold, Video Avg, Power Avg, Freeze and Blank. Every type has its own parameter icon that shown on the left of screen. Take Trace 1 as an example and see the following icons.



#### 1. Clear Write

The trace continuously displays the points during the sweep of the analyzer.

#### 2. Max Hold

Maintains the maximum for each point of the trace, and updates each trace point if a new maximum is generated in successive sweeps.

#### 3. Min Hold

Maintains the minimum for each point of the trace, and updates each trace point if a new minimum is generated in successive sweeps.

#### 4. Video Avg

Displays the trace after a logarithmic mean is calculated for each point of the trace in successive sweeps. Traces in this type will be smoother.

#### 5. Power Avg

Displays the trace after an averaging of each point of the trace in successive sweeps. Traces in this type are smoother than others.

#### 6. Freeze

Stops updating trace data in order to observe the trace and read the measurement data. This type is generally used by traces from the storage devices or remote interface as default.

#### 7. Blank

Disables the trace display and all measurements under this trace.

### 2.3.2.3 Average Times

Sets the number of times to average the selected trace.

#### Key Points:

- More averaging may reduce the noise and influence of other random signals, potentially displaying more stable signal characteristics. The larger the number of times to average, the smoother the trace will be.
- You can use the numeric keys to modify this parameter, please refer to "**Parameter Input**" for more details.

Table 2-19 Average times

Parameter	Explanation
Default	100
Range	1 to 1000
Unit	N/A
Knob Step	N/A
Direction Key Step	N/A

### 2.3.2.4 Trace Math

#### 1. Function

Sets the computational method of the math trace.

- A-B: subtracts Trace B from A
- A+Constant: adds a constant to Trace A
- A-Constant: subtracts a constant from Trace A

#### 2. A

Assigns a value to A from Trace1, Trace 2 or Trace 3, the default is Trace 1.

#### 3. B

Assigns a value to B from Trace 1, Trace 2 or Trace 3, the default is Trace 2.

#### 4. Constant

Sets the value of the constant.

You can use the numeric keys to modify this parameter, please refer to "**Parameter Input**" for more details.

Table 2-20 Constant in math operation

Parameter	Explanation
Default	0 dB
Range	-300 dB to 300 dB
Unit	dB

#### 5. Operate

Enables or disables the display of math trace, the default is Off.

### 2.3.2.5 Clear All

Clears all the traces displayed on the screen. This operation may stop the current advanced measurement as there is no available data source.

## 2.3.3 Demod (DSA1030 Option)

Sets the demodulation of the analyzer. Both AM and FM are available in this device.

### 2.3.3.1 Demod

Sets the demodulation type to AM, FM, or Off, the default is Off.

#### Key Points:

- The system will enable a marker automatically and place it at the center frequency for AM (or FM) demodulation after you open AM (or FM).
- You can activate the speaker to output the modulation signal through an audio frequency (AF). The frequency and intensity of the audio respectively denotes the frequency and intensity of the modulation signal.

### 2.3.3.2 Demod Setup

#### 1. Speaker

Sets the status of internal speaker. When it is On, you can hear the signal during demodulation, the default is Off.

#### 2. Volume

Sets the volume of the speaker.

Table 2-21 Volume

Parameter	Explanation
Default	100
Range	0 to 255
Unit	N/A
Knob Step	10
Direction Key Step	20

#### 3. Demod Time

Sets the time interval for the analyzer to complete a signal demodulation after each sweep. If the speaker is On, you will hear sound during the demodulation.

You can use the numeric keys, knob or direction keys to modify this parameter. For more details, please refer to "**Parameter Input**".

Table 2-22 Demod Time

<b>Parameter</b>	<b>Explanation</b>
<b>Default</b>	100 ms
<b>Range</b>	5 ms to 1000 s
<b>Unit</b>	ks, s, ms, us, ns, ps
<b>Knob Step</b>	0 to 100 ms, step = 1 ms 100 ms to 1 s, step = 10 ms 1 s to 10 s, step = 100 ms 10 s to 100 s, step = 1 s 100 s to 1000 s, step = 10 s
<b>Direction Key Step</b>	in 1, 2, 5 sequence



## 2.3.4 Source (DSA1030 Option)

### 2.3.4.1 Source

When the Source is On, a signal with the same frequency of the current sweep signal will be output from the **GEN OUTPUT 50Ω** terminal on the front panel. The Power of the signal could be set through the menu key. Two working modes are available in the source. They are Power Sweep output and Fixed Power output (when Power Sweep is Off).

The Source function is optional, to purchase, please contact **RIGOL** salesman or your local Distributor.

### 2.3.4.2 TG level

Sets the output power of the signal from the tracking generator (TG). In Power Sweep mode, this parameter indicates the start power of the sweep.

You can use the numeric keys, knob or direction keys to modify this parameter. For more details, please refer to "**Parameter Input**".

Table 2-23 TG level

Parameter	Explanation
<b>Default</b>	0 dBm
<b>Range</b>	-20 dBm to 0 dBm
<b>Unit</b>	dBm, -dBm, mV, uV
<b>Knob Step</b>	1 dBm
<b>Direction Key Step</b>	10 dBm

### 2.3.4.3 TG Level Offset

Sets the offset of the output power from the TG when gains or losses occur between the TG output and peripheral equipment, in order to display the actual power value.

#### Key Points:

- This parameter only changes the readout of the TG output power, rather than the actual value of it.
- The offset could be either a positive (gain) or a negative (loss).
- You can use the numeric keys, knob or direction keys to modify this parameter. For more details, please refer to **“Parameter Input”**.

Table 2-24 TG Level Offset

Parameter	Explanation
Default	0 dB
Range	-200 dB to 200 dB
Unit	dB
Knob Step	1 dB
Direction Key Step	10 dB

### 2.3.4.4 Power Sweep

Enables or disables the power sweep function. If enabled, the power from the TG varies with the sweep rate of the analyzer within the specified range, (from start to stop frequency) and increases gradually starting from the specified TG power (2.3.4.2 TG level) within specified power range (2.3.4.5 Power Range). If disabled, the TG output is fixed at the specified power (2.3.4.2 TG level).

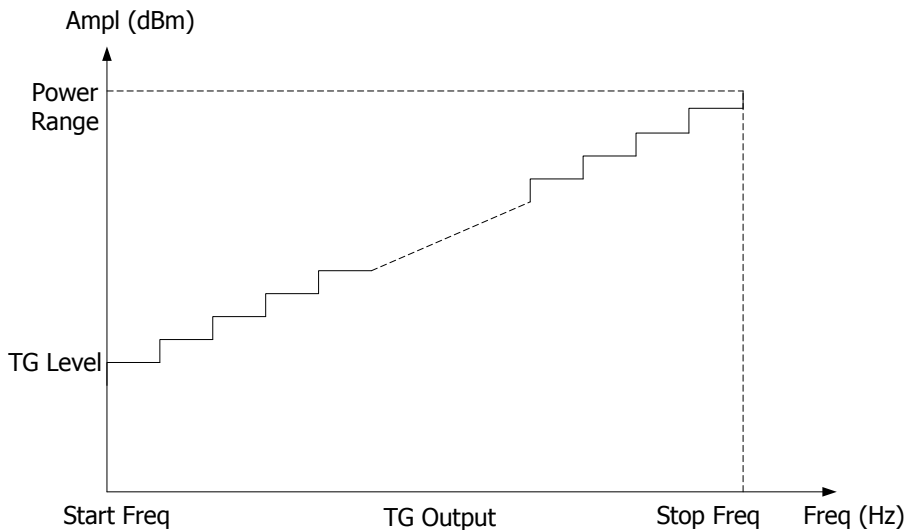

Figure 2-14 Power sweep

### 2.3.4.5 Power Range

Sets the power range that can be output from the TG while in power sweep mode, forming the boundary parameters under the Power Sweep mode together with the TG Level.

You can use the numeric keys, knob or direction keys to modify this parameter. For more details, please refer to "**Parameter Input**".

Table 2-25 Power Range of TG

Parameter	Explanation
Default	0 dB
Range	0 dB to 20 dB
Unit	dB
Knob Step	1 dB
Direction Key Step	10 dB

### 2.3.4.6 Freq Offset

Sets the offset between the TG signal frequency and the current sweep frequency of the analyzer.

#### Key Points:

- If a frequency offset is generated from the TG signal passing from the receiver, you can set this parameter to eliminate it in order to match the displayed frequency to the TG frequency.
- You can use the numeric keys to modify this parameter, please refer to "**Parameter Input**" for more details.

Table 2-26 Frequency Offset

Parameter	Explanation
Default	0 Hz
Range	-300 MHz to 300 MHz
Unit	GHz, MHz, kHz, Hz
Knob Step	N/A
Direction Key Step	N/A

### 2.3.4.7 Normalize

Eliminates the error from TG Level. Before using this function, connect the **GEN OUTPUT 50Ω** output of TG with the **RF INPUT 50Ω** input of the analyzer.

#### 1. Stor Ref

Saves the data of Trace 1 to Trace 3 as the reference value for normalization. This operation should be done before you enable the normalization.

#### 2. Normalize

Enables or disables the normalization. When enabled, the reference trace will be stored automatically for one time if no reference trace is stored before. The trace data subtracts the corresponding value of reference trace after every sweep.

#### 3. Reference level

Adjusts the vertical position of trace on the screen when normalization is On.

- Being different from the **Reference level** function upon the **AMPT** menu, this parameter has no influence on the reference level of the analyzer.
- You can use the numeric keys, knob or direction keys to modify this parameter. For more details, please refer to "**Parameter Input**".

Table 2-27 Reference level under normalization

Parameter	Explanation
<b>Default</b>	0 dBm
<b>Range</b>	-200 dBm to 200 dBm
<b>Unit</b>	dBm
<b>Knob Step</b>	1 dB
<b>Direction Key Step</b>	10 dB

#### 4. Norm Ref Pos

Adjusts this parameter to set the vertical position of the normalization reference level on the screen when normalization is On.

- The same as the function of Reference level above, when setting this parameter to 0%, the position of Reference level above will be at the bottom of screen grip, when setting to 100%, which will be at the top.
- You can use the numeric keys, knob or direction keys to modify this parameter. For more details, please refer to "**Parameter Input**".

Table 2-28 TG reference position

<b>Parameter</b>	<b>Explanation</b>
<b>Default</b>	100%
<b>Range</b>	0 to 100%
<b>Unit</b>	%
<b>Knob Step</b>	1%
<b>Direction Key Step</b>	10%

## 5. Ref Trace

Sets whether to display the reference trace or not. If View is selected, the Trace 3 with saved reference parameters will be shown in the trace type of Freeze.

## 2.4 Advanced Measurements (DSA1030 Option)

### 2.4.1 Meas

This key provides plenty of advanced measurement functions including T-Power, ACP (Adjacent Channel Power), Chan Pwr (Channel Power), OBW (Occupied Bandwidth), EBW (Emission Bandwidth), C/N Ratio, Harmo Dist (Harmonic Distortion), TOI (Third Order Intermodulation) and Pass/Fail. The measure mode can be Single or Continuous and you can control the measurement through options including **Restart**, **Pause**, or **Resume** at will.

#### 2.4.1.1 Meas Fctn

After you select a measurement function, the screen is divided into two windows, the upper window is the basic measurement displaying with a sweep trace, and the lower window holds the results. Through the key of **Screen Control** you can switch between different windows and zoom window modes.

##### 1. T-Power

Enables the Zero Span mode and starts calculating the power within time domain. The measurable power types are Peak, Average, and RMS.

Set the power type to **T-Power** and press **Meas Setup** to set corresponding parameters.

##### 2. ACP

Measures the power of the main channel and adjacent channels as well as the power difference between the main and each of the adjacent channels. When enabled, values of both the span and resolution bandwidth of the analyzer are adjusted to be smaller automatically.

Select the **ACP** measurement and press **Meas Setup** to set corresponding parameters.

##### 3. Channel Power

Measures the power and power density within a specified channel bandwidth. The span and resolution bandwidth in this measurement type are automatically set to smaller values.

Select the power type to **Channel Power** and press **Meas Setup** to set corresponding parameters.

#### 4. **OBW**

Calculates the power within the whole bandwidth by integral operation and works out the occupied bandwidth by this value based on the specified power ratio. The center frequency difference between the measured channel and the analyzer will also be given in the measurement result.

Select the power type to **OBW** and press **Meas Setup** to set corresponding parameters.

#### 5. **EBW**

Measures the bandwidth of the two points at both sides of the max signal when the amplitude of this max signal falls off X dB within the span range.

Select the power type to **EBW** and press **Meas Setup** to set corresponding parameters.

#### 6. **C/N Ratio**

Measures the power of both the carrier and noise within specified bandwidth as well as their power ratio.

Select the power type to **C/N Ratio** and press **Meas Setup** to set corresponding parameters.

#### 7. **Harmo Dist**

Measures each order harmonic power and THD of the carrier. The available range is up to 10 orders, and the fundamental wave amplitude must be higher than -50 dBm or else the measurement will be invalid.

Select the power type to **Harmo Dist** and press **Meas Setup** to set corresponding parameters.

#### 8. **TOI**

Measures the parameters of the production generated by two signals which have the same amplitude and similar frequency. The measured results include the Frequency and Amplitude of the Base Lower, Base Upper, 3rd Order Lower and 3rd Order Upper signal, as well as the Intercept of both the Base Lower and Base Upper.

Select the power type to **TOI** and press **Meas Setup** to set corresponding parameters.

## 9. Pass/Fail

Compares the measured curve with the pre-edited, if the related rules are met, the result will be "Pass", or else is "Fail".

Select the power type to **Pass/Fail** and press **Meas Setup** to set corresponding parameters.

### 2.4.1.2 Restart

Re-executes the active or suspended measurement.

### 2.4.1.3 Pause

Suspends the measurement after current measurement. However, the sweep is continuous when pressed, an icon  is shown on the results window, and the measurement data stops updating.

### 2.4.1.4 Resume

Restarts the suspended measurement. An icon  is shown at the result window, and the measurement data begins updating again.

### 2.4.1.5 Meas Mode

Sets the measurement mode to Single or Continuous. In single mode, the analyzer stops after a specified number of measurements. After this, every time you press **Single**, measurements will be executed a specified number of times and new data will be replaced. In Continuous mode, the analyzer measures continuously.



## 2.4.2 Meas Setup

Sets the parameters for the specified measurement under **Meas** function. This operation is invalid if no measurement is enabled.

### 2.4.2.1 T-Power

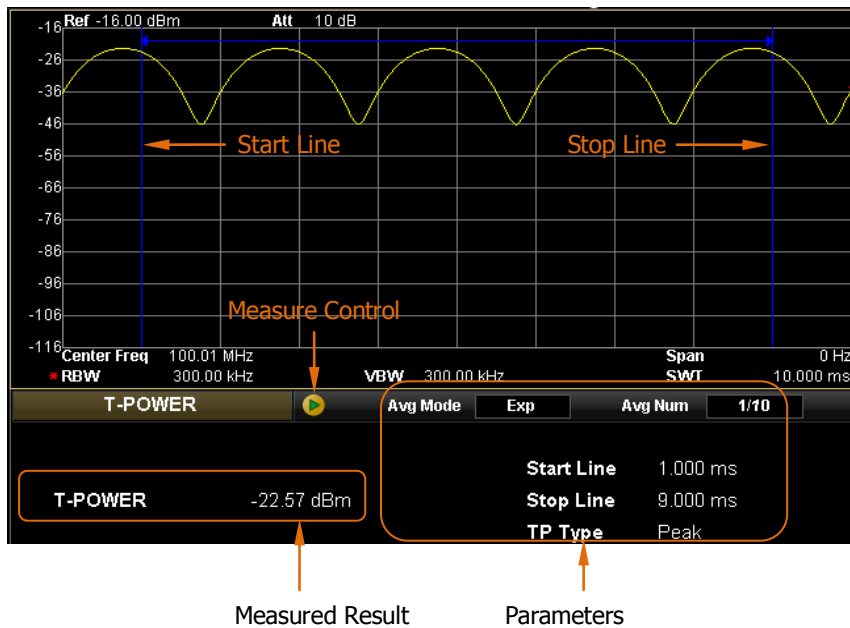

Figure 2-15 Interface of T-Power measurement

#### Result:

Magnitude of T-Power. That is the signal power value from the start to stop line.

#### Parameters:

In this mode, setting parameters are Avg Num, Avg Mode, TP Type, Start Line and Stop Line.

#### 1. Avg Num

Sets the average number for the measurement, the default is Off.

You can use the numeric keys, knob or direction keys to modify this parameter.

For more details, please refer to "**Parameter Input**".

Table 2-29 Average number for T-Power measurement

Parameter	Explanation
Default	10
Range	1 to 1000
Unit	N/A
Knob Step	1
Direction Key Step	1

## 2. Avg Mode

Sets the Average operation to Exp or Repeat, the default is Exp.

- In Exp mode, the result is from the weighted calculation of the N (specified by **Avg Num**) measurements and the previous averages.
- In Repeat mode, the result is the average of the N (specified by **Avg Num**) measurements.

## 3. TP Type

### ● Peak

Displays the power value of the maximum signal between the start and stop line. The detector in this type is changed to Pos Peak automatically.

### ● Average

Displays the average power of the signals between the start and stop line. The detector in this type is changed to "Voltage Avg" automatically.

### ● RMS

Displays the voltage which is the square root of the sum of squares of the signals between the start and stop line in power units. The detector in this type is changed to "RMS Avg" automatically.

## 4. Start Line

Sets the left margin when measuring the T-Power using the time units. The data calculated under this measurement is from the start to stop line.

You can use the numeric keys, knob or direction keys to modify this parameter. For more details, please refer to "**Parameter Input**".

Table 2-30 The Start Line under T-Power measurement

Parameter	Explanation
<b>Default</b>	0 us
<b>Range</b>	0 ms to Stop line
<b>Unit</b>	ks, s, ms, us, ns, ps
<b>Knob Step</b>	Sweep time/600
<b>Direction Key Step</b>	in 1, 1.5, 2, 3, 5, 7.5 sequence

## 5. Stop Line

Sets the right margin when measuring the T-Power using the time units. The data calculated under this measurement is from the start to stop line.

You can use the numeric keys, knob or direction keys to modify this parameter.

For more details, please refer to "**Parameter Input**".

Table 2-31 The Stop Line under T-Power measurement

Parameter	Explanation
<b>Default</b>	100 ms
<b>Range</b>	Start line to Sweep time
<b>Unit</b>	ks, s, ms, us, ns, ps
<b>Knob Step</b>	Sweep time/600
<b>Direction Key Step</b>	in 1, 1.5, 2, 3, 5, 7.5 sequence

### 2.4.2.2 ACP

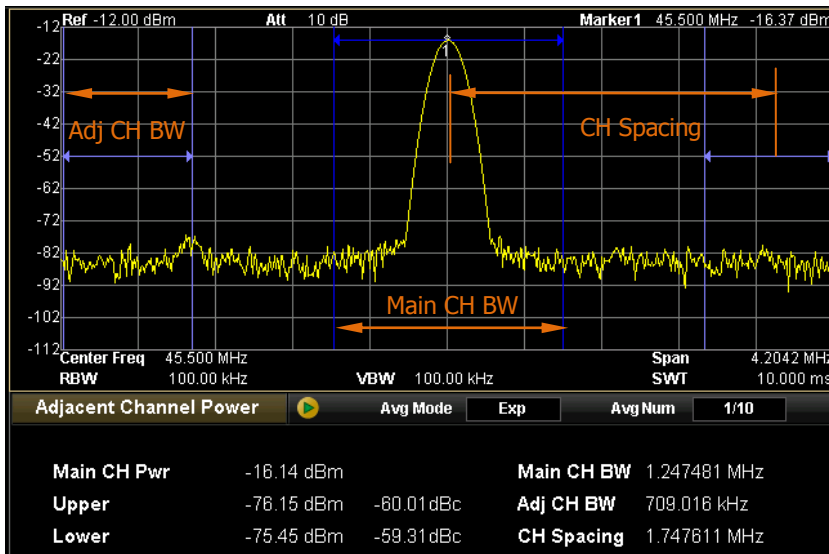

Figure 2-16 Interface of ACP measurement

**Result:**

The results under ACP measurement contain the power of Main CH Pwr, Upper and Lower.

- CH Pwr: displays the power value within the bandwidth of main channel.
- Upper: displays the power value of the next channel up in frequency and the difference with the main channel (Unit is dBc).
- Lower: displays the power value of the next channel down in frequency and the difference with the main channel (Unit is dBc).

**Parameters:**

In this mode, setting parameters are Avg Num, Avg Mode, Main CH BW, Adj CH BW, and CH Spacing.

**1. Avg Num**

Sets the average number for the measurement, the default is Off.

You can use the numeric keys, knob or direction keys to modify this parameter.

For more details, please refer to **"Parameter Input"**.

Table 2-32 Average number for ACP measurement

Parameter	Explanation
Default	10
Range	1 to 1000
Unit	N/A
Knob Step	1
Direction Key Step	1

## 2. Avg Mode

Sets the Averaging operation to Exp or Repeat, the default is Exp.

- In Exp mode, the result is from the weighted calculation of the N (specified by **Avg Num**) measurements and the previous averages.
- In Repeat mode, the result is the average of the N (specified by **Avg Num**) measurements.

## 3. Main CH BW

Sets the bandwidth of the main channel where the power is the integral within this bandwidth.

You can use the numeric keys, knob or direction keys to modify this parameter. For more details, please refer to "**Parameter Input**".

Table 2-33 The main channel bandwidth of ACP measurement

Parameter	Explanation
Default	2 MHz
Range	33 Hz to 1 GHz
Unit	GHz, MHz, kHz, Hz
Knob Step	Main CH BW/100, Min = 1Hz
Direction Key Step	in 1, 1.5, 2, 3, 5, 7.5 sequence

## 4. Adj CH BW

Sets the frequency bandwidth of the adjacent channels.

- The Adj CH BW is related to the Main CH BW, which can be set within Main CH BW/20 and Main CH BW × 20.
- You can use the numeric keys, knob or direction keys to modify this parameter. For more details, please refer to "**Parameter Input**".

Table 2-34 The adjacent channel bandwidth of ACP measurement

Parameter	Explanation
<b>Default</b>	2 MHz
<b>Range</b>	33 Hz to 1 GHz
<b>Unit</b>	GHz, MHz, kHz, Hz
<b>Knob Step</b>	Adj CH BW/100, Min = 1 Hz
<b>Direction Key Step</b>	1, 1.5, 2, 3, 5, 7.5 sequence

## 5. CH Spacing

Sets the spacing between the main and adjacent channels.

- Changing this parameter may adjust the channel distance from the main to the upper and lower.
- You can use the numeric keys, knob or direction keys to modify this parameter. For more details, please refer to "**Parameter Input**".

Table 2-35 Spacing of the ACP measurement

Parameter	Explanation
<b>Default</b>	2 MHz
<b>Range</b>	33 Hz to 1 GHz
<b>Unit</b>	GHz, MHz, kHz, Hz
<b>Knob Step</b>	CH Spacing/100, Min = 1 Hz
<b>Direction Key Step</b>	in 1, 1.5, 2, 3, 5, 7.5 sequence

### 2.4.2.3 Chan Pwr

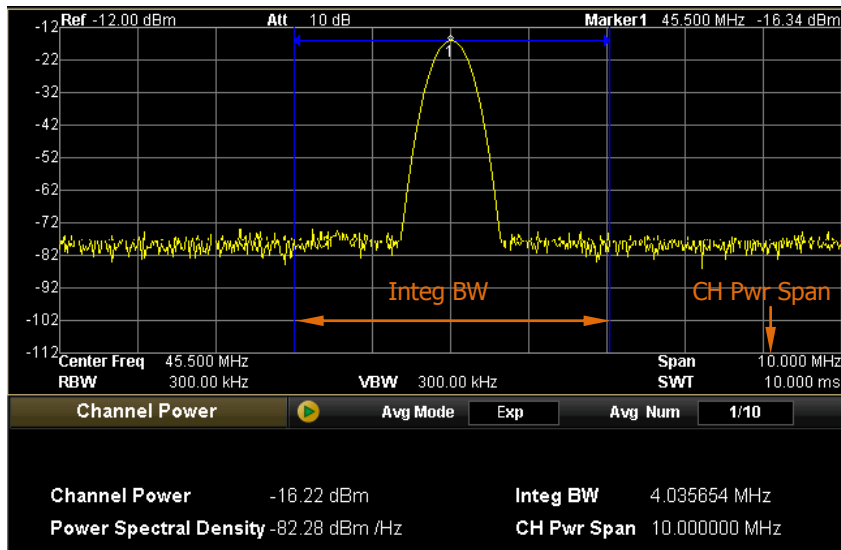

Figure 2-17 Interface of Chan Pwr measurement

#### Result:

The results under Chan Pwr measurement contain Channel Power and Power Spectral Density.

- Channel Power: the power within the integral bandwidth.
- Power Spectral Density: the power which is normalized to 1 Hz within the integral bandwidth (Unit is dBm/Hz).

#### Parameters:

In this mode, setting parameters are Avg Num, Avg Mode, Integ BW and Ch Pwr Span.

##### 1. Avg Num

Sets the average number for the measurement, the default is Off.

You can use the numeric keys, knob or direction keys to modify this parameter.

For more details, please refer to "**Parameter Input**".

Table 2-36 Average number for Chan Pwr measurement

Parameter	Explanation
Default	10
Range	1 to 1000
Unit	N/A
Knob Step	1
Direction Key Step	1

## 2. Avg Mode

Sets the Average operation to Exp or Repeat, the default is Exp.

- In Exp mode, the result is from the weighted calculation of the N (specified by **Avg Num**) measurements and the previous averages.
- In Repeat mode, the result is the average of the N (specified by **Avg Num**) measurements.

## 3. Integ BW

Sets the bandwidth of the channel under measure. The channel power is the integral within this bandwidth.

You can use the numeric keys, knob or direction keys to modify this parameter. For more details, please refer to "**Parameter Input**".

Table 2-37 Integral bandwidth of Chan Pwr measurement

Parameter	Explanation
Default	2 MHz
Range	33 Hz to 1 GHz
Unit	GHz, MHz, kHz, Hz
Knob Step	Integ BW/100, Min = 1 Hz
Direction Key Step	in 1, 1.5, 2, 3, 5, 7.5 sequence

## 4. Ch Pwr Span

Sets the channel frequency range, whose value is the same as the span of the analyzer, indicating the frequency range of sweep. Changing this parameter may alter the span of the analyzer.

- This value is related to the Integ BW, which can be set within the Integ BW and 20 times of it.
- You can use the numeric keys, knob or direction keys to modify this parameter. For more details, please refer to "**Parameter Input**".



Table 2-38 The Channel span of Chan Pwr measurement

<b>Parameter</b>	<b>Explanation</b>
<b>Default</b>	3 MHz
<b>Range</b>	100 Hz to 3 GHz
<b>Unit</b>	GHz, MHz, kHz, Hz
<b>Knob Step</b>	CH Pwr Span/100, Min = 1 Hz
<b>Direction Key Step</b>	in 1, 1.5, 2, 3, 5, 7.5 sequence

### 2.4.2.4 OBW

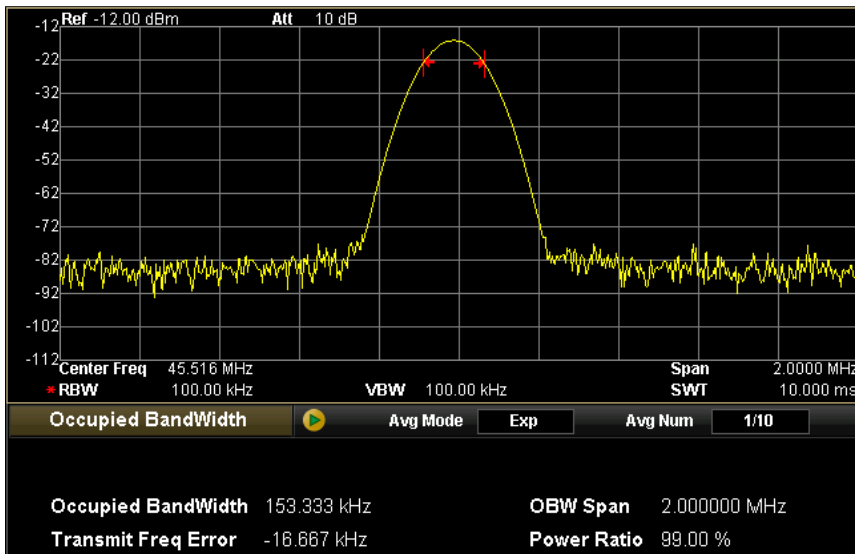

Figure 2-18 Interface of OBW measurement

#### Result:

The results under OBW measurement contain Occupied Bandwidth and Transmit Freq Error.

- Occupied Bandwidth: calculate the power within the whole span and then work out the occupied bandwidth of it according to the specified power ratio.
- Transmit Freq Error: the center frequency difference between the measured channel and the analyzer.

#### Parameters:

In this mode, setting parameters are Avg Num, Avg Mode, Max Hold, Span and Power Ratio.

#### 1. Avg Num

Sets the average number for the measurement, the default is Off.

You can use the numeric keys, knob or direction keys to modify this parameter.

For more details, please refer to "Parameter Input".

Table 2-39 Average number for OBW measurement

Parameter	Explanation
<b>Default</b>	10
<b>Range</b>	1 to 1000
<b>Unit</b>	N/A
<b>Knob Step</b>	1
<b>Direction Key Step</b>	1

## 2. Avg Mode

Sets the Average mode to Exp or Repeat, the default is Exp.

- In Exp mode, the result is from the weighted calculation of the N (specified by **Avg Num**) measurements and the previous averages.
- In Repeat mode, the result is the average of the N (specified by **Avg Num**) measurements.

## 3. Max Hold

Enables or disables the Max Hold function, the default is Off.

- Hold On: always displays the maximum measurement result.
- Hold Off: displays the current measurement result.
- This function and Avg Mode are mutually exclusive options, if you enable the Max Hold, the Avg Mode will be disabled automatically.

## 4. Span

Sets the frequency range of the integral operation. This value is equal to the span of the analyzer, indicating the frequency range of sweep. Changing this parameter may cause the span of the analyzer to change.

You can use the numeric keys, knob or direction keys to modify this parameter. For more details, please refer to "**Parameter Input**".

Table 2-40 The Span of OBW measurement

Parameter	Explanation
<b>Default</b>	2 MHz
<b>Range</b>	100 Hz to 3 GHz
<b>Unit</b>	GHz, MHz, kHz, Hz
<b>Knob Step</b>	Occupied BW Span /100, Min = 1Hz
<b>Direction Key Step</b>	in 1, 1.5, 2, 3, 5, 7.5 sequence

## 5. Power Ratio

Sets the power percentage of the signal that is within the integrating span.

You can use the numeric keys, knob or direction keys to modify this parameter.

For more details, please refer to "**Parameter Input**".

Table 2-41 The Power Ratio of OBW measurement

<b>Parameter</b>	<b>Explanation</b>
<b>Default</b>	99%
<b>Range</b>	1% to 99.99%
<b>Unit</b>	%
<b>Knob Step</b>	0.01%
<b>Direction Key Step</b>	1%

## 2.4.2.5 EBW

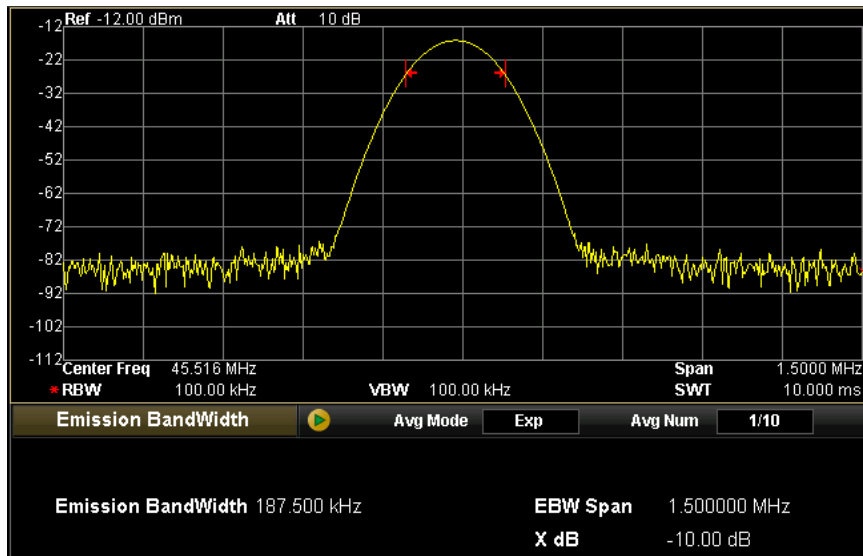

Figure 2-19 Interface of EBW measurement

### Result:

EBW is the bandwidth between the two points at both sides of the max signal where the amplitude falls off X dB within the span range. When the measurement starts, the analyzer first confirms frequency  $f_0$  as the max amplitude within the span range and then starts searching for the two points  $f_1$  and  $f_2$ . The EBW is equal to  $f_2 - f_1$ .

### Parameters:

In this mode, setting parameters are Avg Num, Avg Mode, Max Hold, Span and EBW X dB.

#### 1. Avg Num

Sets the average number for the measurement, the default is Off.

You can use the numeric keys, knob or direction keys to modify this parameter.

For more details, please refer to "**Parameter Input**".

Table 2-42 Average number for EBW measurement

Parameter	Explanation
Default	10
Range	1 to 1000
Unit	N/A
Knob Step	1
Direction Key Step	1

## 2. Avg Mode

Sets the Average operation to Exp or Repeat, the default is Exp.

- In Exp mode, the result is from the weighted calculation of the N (specified by **Avg Num**) measurements and the previous averages.
- In Repeat mode, the result is the average of the N (specified by **Avg Num**) measurements.

## 3. Max Hold

Enables or disables the Max Hold function, the default is Off.

- Hold On: always displays the maximum measurement result.
- Hold Off: displays the current measurement result.
- This function and Avg Mode are mutually exclusive options, if you enable the Max Hold, the Avg Mode will be disabled automatically.

## 4. Span

This value is equal to the span of the analyzer, indicating the frequency range of the sweep. Changing this parameter will cause a change in the span of the analyzer.

You can use the numeric keys, knob or direction keys to modify this parameter. For more details, please refer to "**Parameter Input**".

Table 2-43 The Span of EBW measurement

Parameter	Explanation
Default	2 MHz
Range	100 Hz to 3 GHz
Unit	GHz, MHz, kHz, Hz
Knob Step	Emission BW Span/100, Min = 1 Hz
Direction Key Step	in 1, 1.5, 2, 3, 5, 7.5 sequence

## 5. X dB

Sets the value of X dB to calculate the emission bandwidth.

You can use the numeric keys, knob or direction keys to modify this parameter.

For more details, please refer to "**Parameter Input**".

Table 2-44 X dB

Parameter	Explanation
Default	-10 dB
Range	-100 dB to -0.1 dB
Unit	dB
Knob Step	0.1 dB
Direction Key Step	1 dB

### 2.4.2.6 C/N Ratio

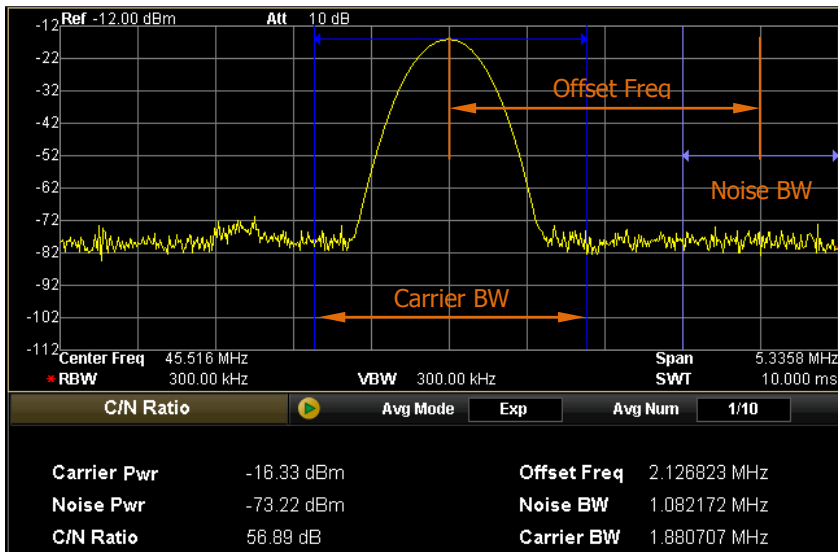

Figure 2-20 Interface of C/N Ratio measurement

#### Result:

The results under this mode contain the Carrier Pwr, Noise Pwr, and C/N Ratio.

- Carrier Pwr: the power within carrier bandwidth
- Noise Pwr: the power within noise bandwidth
- C/N Ratio: the ratio of the carrier’s power to the noise’s power

#### Parameters:

In this mode, setting parameters are Avg Num, Avg Mode, Offset Freq, Noise BW and Carrier bandwidth.

#### 1. Avg Num

Sets the average number for the measurement, the default is Off.

You can use the numeric keys, knob or direction keys to modify this parameter.

For more details, please refer to “Parameter Input”.



Table 2-45 Average number for C/N Ratio measurement

Parameter	Explanation
Default	10
Range	1 to 1000
Unit	N/A
Knob Step	1
Direction Key Step	1

## 2. Avg Mode

Sets the Average operation to Exp or Repeat, the default is Exp.

- In Exp mode, the result is from the weighted calculation of the N (specified by **Avg Num**) measurements and the previous averages.
- In Repeat mode, the result is from the average of the N (specified by **Avg Num**) measurements.

## 3. Offset Freq

Sets the center frequency difference between the carrier and the noise.

You can use the numeric keys, knob or direction keys to modify this parameter.

For more details, please refer to "**Parameter Input**".

Table 2-46 The Offset Freq of C/N Ratio measurement

Parameter	Explanation
Default	2 MHz
Range	33 Hz to 1 GHz
Unit	GHz, MHz, kHz, Hz
Knob Step	Offset Freq/100, Min = 1 Hz
Direction Key Step	in 1, 1.5, 2, 3, 5, 7.5 sequence

## 4. Noise BW

Sets the bandwidth of the noise for measurement.

You can use the numeric keys, knob or direction keys to modify this parameter.

For more details, please refer to "**Parameter Input**".

Table 2-47 Noise BW of C/N Ratio measurement

Parameter	Explanation
<b>Default</b>	2 MHz
<b>Range</b>	100 Hz to 3 GHz
<b>Unit</b>	GHz, MHz, kHz, Hz
<b>Knob Step</b>	Noise BW/100, Min = 1 Hz
<b>Direction Key Step</b>	in 1, 1.5, 2, 3, 5, 7.5 sequence

## 5. Carrier BW

Sets the bandwidth of the carrier for measurement.

- This value is related to the Noise BW, which can be set within Noise BW/20 and 20 times of it.
- You can use the numeric keys, knob or direction keys to modify this parameter. For more details, please refer to "**Parameter Input**".

Table 2-48 The Carrier BW of C/N Ratio measurement

Parameter	Explanation
<b>Default</b>	2 MHz
<b>Range</b>	100 Hz to 3 GHz
<b>Unit</b>	GHz, MHz, kHz, Hz
<b>Knob Step</b>	Carrier BW/100, Min = 1 Hz
<b>Direction Key Step</b>	in 1, 1.5, 2, 3, 5, 7.5 sequence

## 2.4.2.7 Harmo Dist

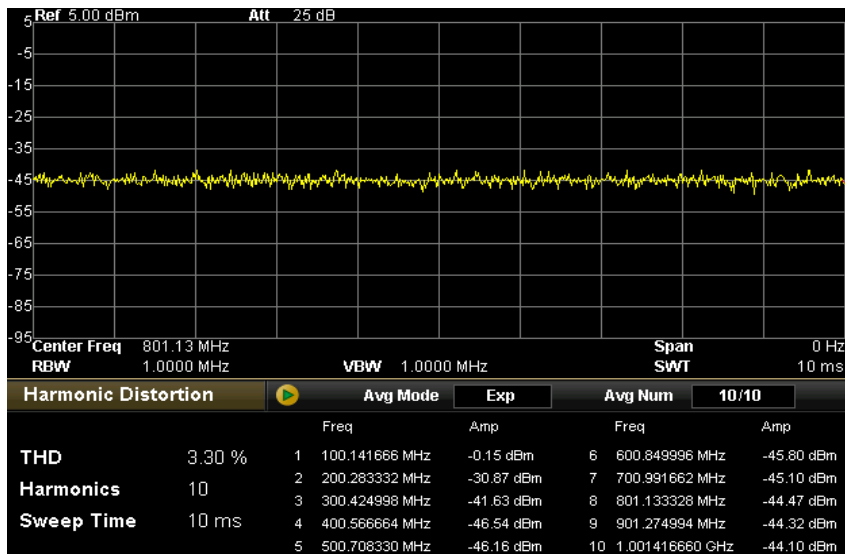

Figure 2-21 Interface of Harmo Dist measurement

### Result:

The results under this mode contain the amplitude of each harmonic and THD. Up to 10 times harmonics can be measured.

### Parameters:

In this mode, setting parameters are Avg Num, Avg Mode, NO.of Harmo and Harmonic ST (Sweep Time).

#### 1. Avg Num

Sets the average number for the measurement, the default is Off.

You can use the numeric keys, knob or direction keys to modify this parameter.

For more details, please refer to "**Parameter Input**".

Table 2-49 Average number for Harmo Dist measurement

Parameter	Explanation
Default	10
Range	1 to 1000
Unit	N/A
Knob Step	1
Direction Key Step	1

## 2. Avg Mode

Sets the Average operation to Exp or Repeat, the default is Exp.

- In Exp mode, the result is from the weighted calculation of the N (specified by **Avg Num**) measurements and the previous averages.
- In Repeat mode, the result is from the average of the N (specified by **Avg Num**) measurements.

## 3. NO.of Harmo

Sets the number of harmonics to be measured, which is used for calculating the total harmonics.

You can use the numeric keys, knob or direction keys to modify this parameter. For more details, please refer to "**Parameter Input**".

Table 2-50 Number of harmonics for Harmo Dist measurement

Parameter	Explanation
Default	10
Range	2 to 10
Unit	N/A
Knob Step	1
Direction Key Step	1

## 4. Harmonic ST

Sets the sweep time during the harmonic measurement, which is the sweep time of the analyzer.

You can use the numeric keys, knob or direction keys to modify this parameter. For more details, please refer to "**Parameter Input**".

Table 2-51 The Sweep Time of Harmo Dist measurement

<b>Parameter</b>	<b>Explanation</b>
<b>Default</b>	10 ms
<b>Range</b>	20 us to 3 ks
<b>Unit</b>	ks, s, ms, us, ns, ps
<b>Knob Step</b>	1 ms
<b>Direction Key Step</b>	In 1, 1.5, 2, 3, 5, 7.5 sequence

### 2.4.2.8 TOI

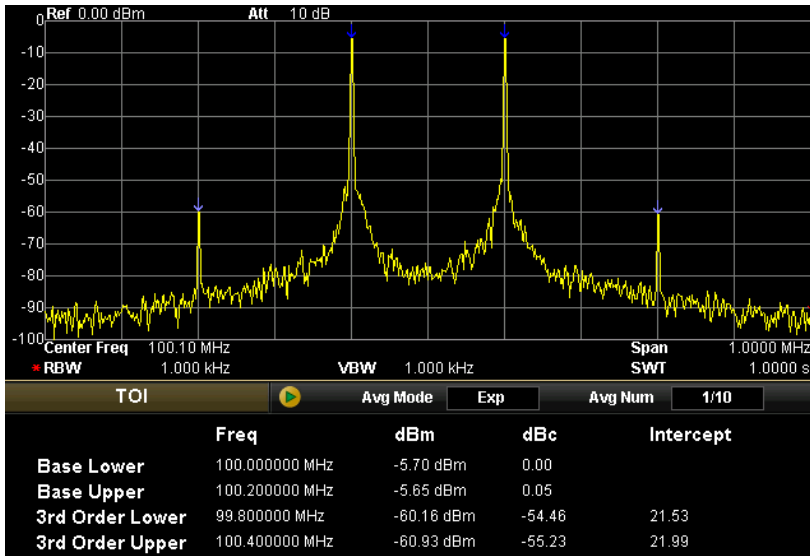

Figure 2-22 Interface of TOI measurement

#### Result:

The results under this mode contain the frequency and amplitude of the Base Lower, Base Upper, 3rd Order Lower and 3rd Order Upper signals, the amplitude difference of each signal with the Base Lower, as well as the Intercept of both the Base Lower and Base Upper.

#### Parameters:

In this mode, setting parameters are Avg Num, Avg Mode and Span.

#### 1. Avg Num

Sets the average number for the measurement, the default is Off.

You can use the numeric keys, knob or direction keys to modify this parameter.

For more details, please refer to **"Parameter Input"**.

Table 2-52 Average number for TOI measurement

Parameter	Explanation
Default	10
Range	1 to 1000
Unit	N/A
Knob Step	1
Direction Key Step	1

## 2. Avg Mode

Sets the Average operation to Exp or Repeat, the default is Exp.

- In Exp mode, the result is from the weighted calculation of the N (specified by **Avg Num**) measurements and the previous averages.
- In Repeat mode, the result is from the average of the N (specified by **Avg Num**) measurements.

## 3. Span

This value equals the span of the analyzer, indicating the frequency range of sweep. Changing this parameter changes the span of the analyzer.

You can use the numeric keys, knob or direction keys to modify this parameter.

For more details, please refer to "**Parameter Input**".

Table 2-53 The Span of TOI measurement

Parameter	Explanation
Default	2 MHz
Range	100 Hz to 3 GHz
Unit	GHz, MHz, kHz, Hz
Knob Step	TOI Span/100, Min = 1 Hz
Direction Key Step	in 1, 1.5, 2, 3, 5, 7.5 sequence

### 2.4.2.9 Pass/Fail



Figure 2-23 Interface of Pass/Fail measurement

#### Result:

The results under this mode contain the pass number and the Pass Ratio.

#### 1. Limit

Selects the desired limit lines including Upper and Lower, and then sets the condition according to the **Edit** menu. Note that T2 and T3 here are used for marking the Upper and Lower limit separately.

#### 2. Test

Enables or disables the test function. Each limit has its own switch, you can test both together, either one, or neither.

Note that the **Pass/Fail** menu under the **Meas** key is only used to control the status of the measurement, not the status of Test.

#### 3. Edit

Edits the properties of the limits.



Table 2-54 Pass/Fail menu

Parameter	Explanation
Limit	Quickly selects the limit line to be edited.
Point	Sets the numbers of point to be edited within 1 and 200.
X-axis	Enters the frequency or time of the point you are editing.
Amplitude	Enters the amplitude of the point you are editing within -120 dB and 100 dB.
Connected	Connect this point with the previous one or not.
Del Point	Deletes the point you are editing.

#### 4. X Axis

Sets the Frequency or Time unit as the X-axis's. Note that the switch of units may delete all the edited points upon the current limit line.

#### 5. Freq Interp

Sets the Freq Interp to Log or Lin. In Log mode, both the frequency and amplitude use Log to do interpolation operation; in Lin mode, the frequency uses a Lin unit and the amplitude uses a Log unit for interpolation operation.

#### 6. Del Limit

Deletes the limit line you are editing.

#### 7. Fail Stop

Selects whether to continue the next sweep if the test fails.

## 2.5 Marker Measurements

### 2.5.1 Marker

The marker appears as a rhombic sign (shown below) for identifying the point on the trace. We can easily readout the parameters of the marked point on the trace, such as the amplitude, frequency and sweep time.

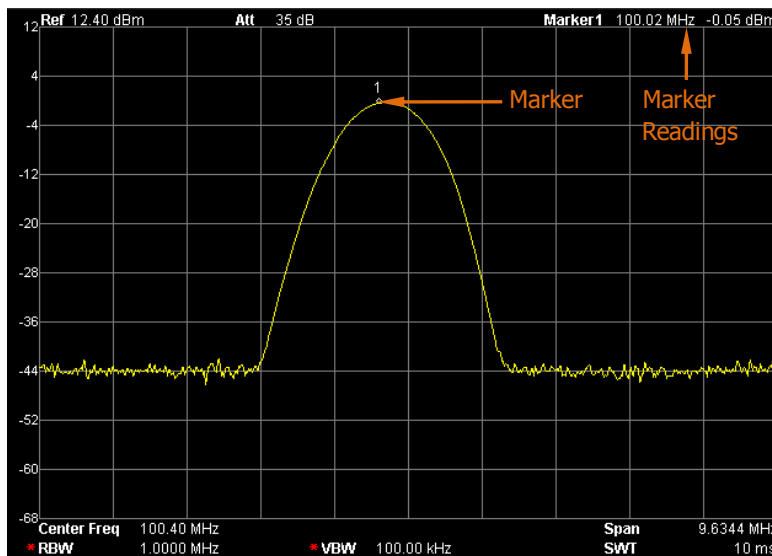

Figure 2-24 Schematic of the marker

#### Key Points:

- The analyzer allows for up to four groups of markers to be displayed at one time, but only one pair or one single marker is active every time.
- You can use the numeric keys, knob or direction keys to enter the desired frequency or time when any marker type menu is active, so as to view the readout of different points on the trace.

### 2.5.1.1 Select Mkr

Selects one marker from the four, the default is Marker1. When a selection is made, you can set its type, trace to be marked, readout type and other related parameters. The enabled marker will appear on the selected trace through the **Mkr Trace** option, and the readouts of this marker are also displayed on the active area and the upper right of screen.

Table 2-55 Marker parameters

Parameter	Explanation
<b>Default</b>	Center Frequency
<b>Range</b>	0 to 3 GHz
<b>Unit</b>	Readout = Frequency (or Period), Unit is GHz, MHz, kHz, Hz (or ks, s, ms, us, ns, ps); Readout = Time (or 1/ $\Delta$ time), Unit is ks, s, ms, us, ns, ps (or GHz, MHz, kHz, Hz)
<b>Knob Step</b>	Readout = Frequency (or Period), step = Span/( Sweep Points -1); Readout = Time (or 1/ $\Delta$ time), step = Sweep Time/( Sweep Points -1)
<b>Direction Key Step</b>	Readout = Frequency (or Period), step = Span/10; Readout = Time (or 1/ $\Delta$ time), step = Sweep Time/10

### 2.5.1.2 Normal

One of the marker types, which is used to measure the values of X (Frequency or Time) or Y (Amplitude) at certain point of the trace. When selected, a marker will appear with its own digital ID such as "1" on the trace.

#### Key Points:

- If no active marker existed currently, a one will be enabled automatically at the center frequency of current trace.
- You can use the knob, direction keys or numeric keys to move the marker. The readouts of the marker will be displayed on the upper right of the screen.
- The readout resolution of the X-axis corresponds to the span and sweep points. For higher resolution, adding sweep points or reducing the span.

### 2.5.1.3 Delta

One of the marker types, which is used to measure the delta values of X (Frequency or Time) and Y (Amplitude) between the Reference point and certain point on the trace. When selected, a pair of markers appears on the trace, which are the Reference Marker (marked as a combination of the marker number and letter "R", such as "1R") and the Delta Marker (marked as the marker number, such as "1").

#### Key Points:

- The Reference Marker will be activated at the position of current marker, or else both the reference marker and Delta Marker will be simultaneously activated at the center frequency location if no marker is active at the present.
- The location of the Reference Marker is always fixed (both in the X-axis and the Y-axis), while the Delta Marker is active. You can use the numeric keys, knob or direction keys to change the location of Delta Marker.
- The delta of both the frequency (or Time) and the amplitude between the two markers that displayed at the upper right of the screen.
- One way to enable a certain point as the reference is to open a "Normal" marker and locate it onto a point and then switch the marker type into "Delta", creating a new reference, then you can modify the location of the delta point to achieve the delta measurement; the other way is to open a Delta Marker and place it onto a point, then reselect the **Delta** menu to locate the marker you opened onto this point.
- If you activate the **Noise Mkr** function under the **Marker Fctn** key, the result of the noise measurement will be corrected automatically and normalized to 1 Hz.

#### The application of Delta marker

Measuring the signal-noise ratio of single spectrum signal, for example, separately place the Reference and Delta Marker onto the signal and noise, the amplitude shown in the measurement result is the signal-noise ratio.

### 2.5.1.4 Delta Pair

One of the marker types. When selected, a pair of markers will appear on the trace, which are the Reference Marker (marked as a combination of the marker number and letter "R", such as "1R") and the Delta Marker (marked as the marker number, such as "1").

#### Key Points:

- You can use the knob, direction keys or numeric keys to set the location of the Reference Marker (selecting Ref) and the Delta Marker (selecting Delta).
- This is different from the **Delta** type marker in that you can modify both the Reference and Delta Marker. Additionally, both the X and Y value of the Reference Marker are stable in "Delta" type during the sweep, but the Y value of the Reference Marker is updating along with the sweep in "Delta Pair" type.

### 2.5.1.5 Span Pair

One of the marker types. When selected, a pair of markers will appear on the trace, which are the Reference Marker (marked as a combination of the marker number and letter "R", such as "1R") and the Delta Marker (marked as the marker number, such as "1").

#### Key Points:

- You can use the knob, direction keys or numeric keys to set the location of both the Reference Marker and Delta Marker at the same time.
- If Span is selected, setting the Span Pair will keep the center position of the two markers and move them towards the two sides (value increasing) or the middle (value decreasing).
- If Center is selected, setting the Span Pair will keep the relative distance of the two markers and move their center position towards the left (value decreasing) or right (value increasing).
- This is different from the "Delta" type marker, in that you can modify both the Reference Marker and Delta Marker at the same time.

### 2.5.1.6 Off

Turns off the current selected marker. The marker information displayed on the screen and functions based on the marker will also be turned off.

### 2.5.1.7 Mkr Trace

Selects a trace to be used on the current marker from 1, 2, 3, Math or Auto. When Auto is selected, the system searches the desired trace in the order of Clear Write, Max Hold, Min Hold, Video Avg, Power Avg, Freeze, and then selects one of them in sequence of the trace number 1, 2 and 3 if more than two traces are found.

### 2.5.1.8 Readout

Selects a desired readout type of X-axis for the marker from Frequency, Period,  $\Delta$ Time and  $1/\Delta$ Time. Note this setting will cause a change in the type of readout but not in actual value. The type you select may also affect the marker readout shown on the active area and the upper right of screen.

#### 1. Frequency

In this type, a **Normal** marker shows the absolute frequency and a **Delta** marker shows the frequency difference between the Delta Marker and Reference Marker. The default readout in non-zero span mode is Frequency.

#### 2. Period

In this type, a **Normal** marker shows the reciprocal value of frequency and the other types show the reciprocal value of frequency difference. When the frequency difference is zero, the displayed value is infinite (with 10 Ts displaying). Note this type is invalid in Zero span mode.

#### 3. $\Delta$ Time

In this type, a **Normal** marker shows the time difference between where the marker is located and the start of the sweep, while a **Delta** marker shows the sweep time difference between the Delta Marker and Reference Marker. The default readout in Zero span mode is  $\Delta$ Time.

#### 4. 1/ $\Delta$ Time

In this type, the reciprocal value of sweep time difference between the Delta Marker and Reference Marker will be shown. When the time difference is zero, the displayed value is infinite (with 100THz displaying). Note this type is available only in Zero span mode when a **Delta** type marker is selected and suitable for the frequency measurement of a video signal.

### 2.5.1.9 Marker Table

Displays all the opened markers on the lower portion of the screen, including Marker number, Trace number, trace Type, X-axis, and Amplitude readout. Through this table you can view the measured value from multiple points. The table allows for up to eight markers to be displayed at one time. Pressing  to select the readout window and turning the knob to view the readouts of all the markers.

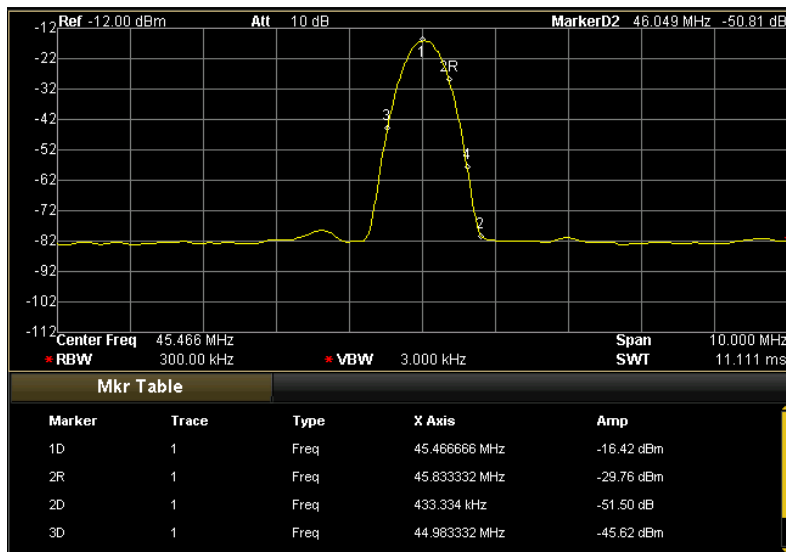

Figure 2-25 The marker schematic

### 2.5.1.10 All Off

Turns off all the opened markers and the related functions.

## 2.5.2 Marker->

Sets the other system parameters (such as Center frequency, Reference level) using the current marker readings. Press **Marker ->** to enable a marker if none of them are active at present.

### 2.5.2.1 Mkr->CF

Sets the center frequency of the analyzer based on the frequency of the current marker.

- If **Normal** is selected, the center frequency will be set to the frequency of the current marker.
- If **Delta**, **Delta Pair**, or **Span Pair** is selected, the center frequency will be set to the frequency at which the Delta Marker is located.
- The function is invalid in Zero span mode.

### 2.5.2.2 Mkr->Step

Sets the center frequency step of the analyzer based on the frequency of the current marker.

- If **Normal** is selected, the center frequency step will be set to the frequency of current marker.
- If **Delta**, **Delta Pair** or **Span Pair** is selected, the center frequency step will be set to the frequency at which the Delta Marker is located.
- The function is invalid in Zero span mode.

### 2.5.2.3 Mkr->Start

Sets the start frequency of the analyzer based on the frequency of the current marker.

- If **Normal** is selected, the start frequency will be set to the frequency of the current marker.
- If **Delta**, **Delta Pair** or **Span Pair** is selected, the start frequency will be set to the frequency at which the Delta Marker is located.



- The function is invalid in Zero span mode.

#### 2.5.2.4 Mkr->Stop

Sets the stop frequency of the analyzer based on the frequency of the current marker.

- If **Normal** is selected, the stop frequency will be set to the frequency of the current marker.
- If **Delta**, **Delta Pair** or **Span Pair** is selected, the stop frequency will be set to the frequency at which the Delta Marker is located.
- The function is invalid in Zero span mode.

#### 2.5.2.5 Mkr->Ref

Sets the reference level of the analyzer based on the amplitude of the current marker.

- If **Normal** is selected, the reference level will be set to the amplitude of the current marker.
- If **Delta**, **Delta Pair**, or **Span Pair** is selected, the reference level will be set to the amplitude at which the Delta Marker is located.

#### 2.5.2.6 Mkr $\Delta$ ->CF

Sets the center frequency of the analyzer to the frequency difference between the two markers in the marker type of **Delta**, **Delta Pair**, or **Span Pair**.

The function is invalid in Zero span mode.

#### 2.5.2.7 Mkr $\Delta$ ->Span

Sets the span of the analyzer to the frequency difference between the two markers in the marker type of **Delta**, **Delta Pair** or **Span Pair**.

The function is invalid in Zero span mode.

## 2.5.3 Marker Fctn

Executes specific marker functions such as Noise Mkr, N dB BW and Freq Count.

### 2.5.3.1 Select Mkr

Selects the marker to be used for the specified functions, the default is Marker 1.

### 2.5.3.2 Noise Mkr

Executes the Noise marker function for the selected marker and reads the **Power Spectral Density**.

#### Key Points:

- If the current marker selected here is Off in **Marker** menu, Pressing **Noise Mkr** will first enable the marker as a Normal type marker automatically, then start measuring the average noise level at the marked point and then normalize this value to 1 Hz bandwidth. During this process, certain compensation is always taken on the basis of different detection and trace types. The measurement will be more precise if using the detection type of RMS Avg or Sample.
- This function can be used for measuring the Noise ratio.

### 2.5.3.3 N dB BW

Enables the N dB BW measurement or sets the value of N. The N dB BW denotes the frequency difference between points that are located on both sides of the current marker while the amplitude falls off ( $N < 0$ ) or rises ( $N > 0$ ) N dB separately, see figure below:

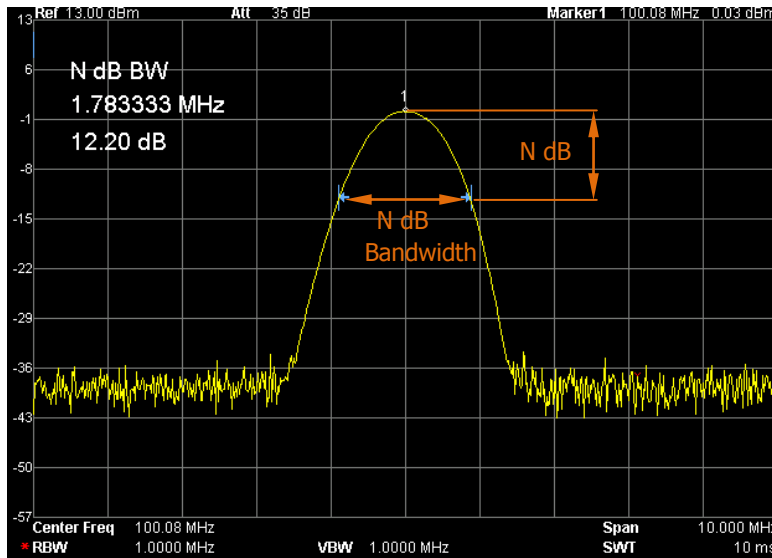

Figure 2-26 N dB BW measurement

**Key Points:**

- When the measurement starts, the analyzer will first search the two points between which the frequency difference is shown in the active area.
- You can use the numeric keys, knob or direction keys to modify the value of N, for more details please refer to “**Parameter Input**”.

Table 2-56 N dB BW parameter settings

Parameter	Explanation
Default	-3 dB
Range	-100 dB to 100 dB
Unit	dB
Knob Step	0.1 dB
Direction Key Step	1 dB

**2.5.3.4 Function Off**

Turns off the opened noise markers or N dB BW measurements, but not the markers themselves.

### 2.5.3.5 Freq Count

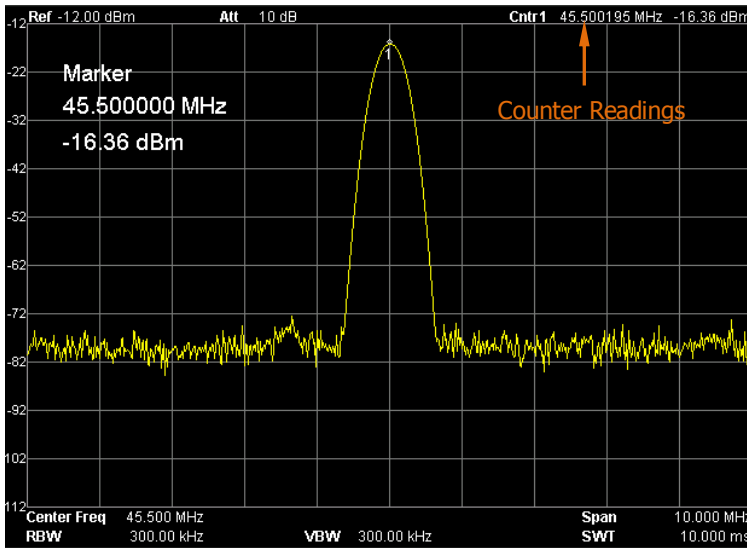

Figure 2-27 Frequency Count measurement

#### 1. State

Turns on or off the frequency counter.

#### Key Points:

- If no active marker currently exists, turning on the counter will open a **Normal** marker automatically.
- The frequency readout is more accurate when the counter is **On**.
- The counter measures the frequency near the Center frequency in Zero span mode.

#### 2. Resolution

Sets the resolution of frequency counter manually or automatically. The available resolutions are 1 Hz, 10 Hz, 100 Hz, 1 kHz, 10 kHz and 100 kHz.

Table 2-57 The resolution of frequency counter

Parameter	Explanation
Default	1 kHz
Range	1 Hz to 100 kHz
Unit	GHz, MHz, kHz, Hz

---

<b>Knob Step</b>	10 times
<b>Direction Key Step</b>	10 times

## 2.5.4 Peak

Executes peak searching immediately and opens the Peak setting menu.

### Key Points:

- If **Max** is selected from the **Peak Search** option, it will search and mark the maximum on the trace.
- If **Param** is selected from the **Peak Search** option, it will search and mark the peak that meets the condition of the parameter.
- The peak search of Next Peak, Peak Right or Peak Left must meet the specified parameter condition.
- The spurious signal at the zero frequency caused by LO feed through is ignored.
- When no peak that meets the specified parameter condition is found, the system will then prompt you with the message "**No peak found**".

### 2.5.4.1 Next Peak

Searches the peak whose amplitude is the closest to the current peak's and meets the searching condition. The peak is then identified with a marker.

### 2.5.4.2 Peak Right

Searches the nearest peak located to the right side of the current peak and meets the searching condition. The peak is then identified with a marker.

### 2.5.4.3 Peak Left

Searches the nearest peak located to the left side of the current peak and meets the searching condition. The peak is then identified with a marker.

#### 2.5.4.4 Min Search

Searches the peak with the minimum amplitude on the trace and identifies it with a marker.

#### 2.5.4.5 Peak Peak

Executes the peak search and minimum search and identifies the results by a pair of markers. Note that the result under peak search is identified with a Delta Marker and the other is identified with a Reference Marker.

#### 2.5.4.6 Cont Peak

Enables or disables the Cont peak search, the default is Off. When enabled, the system will always execute a peak search automatically after each sweep in order to track the signal under measurement.

#### **The difference between the Cont peak and the Signal Track**

The Cont peak focuses on the searching for the maximum in the current channel, while the Signal Track always searches for the signal that has the same amplitude as the one which was located at the current marker before the Signal Track was enabled, and uses the frequency of this signal as the center frequency.

#### 2.5.4.7 Search Para

Defines the conditions of peak search for various peak searching. A real peak should meet the value of both "PK Excursn" and "PK Thresh".

##### 1. PK Excursn

Sets the excursion between the peak and the minimum amplitude on both sides of it. A real peak should always be beyond the excursion you specified.

##### 2. PK Thresh

Assigns a minimum for the peak amplitude. A real peak should always be beyond the limit you specified.

### 3. Peak Search

Sets the peak search condition. The available options are Maximum and Para.

- If **Max** is selected, the system searches for the maximum on the trace.
- If **Para** is selected, the system searches for the peak that meets the parameter condition on the trace.
- This setting has meaning only for the peak search which will be executed when pressing the **Peak** key on the front panel, while other searches such as Next Peak, Peak Right, Peak Left and Min Search are all based on the **Para** you specified.

#### 2.5.4.8 Peak Table

Open the Peak Table, you will see a peak list that meets the parameter condition (with Frequency and Amplitude shown). The table allows up to 10 such peaks.

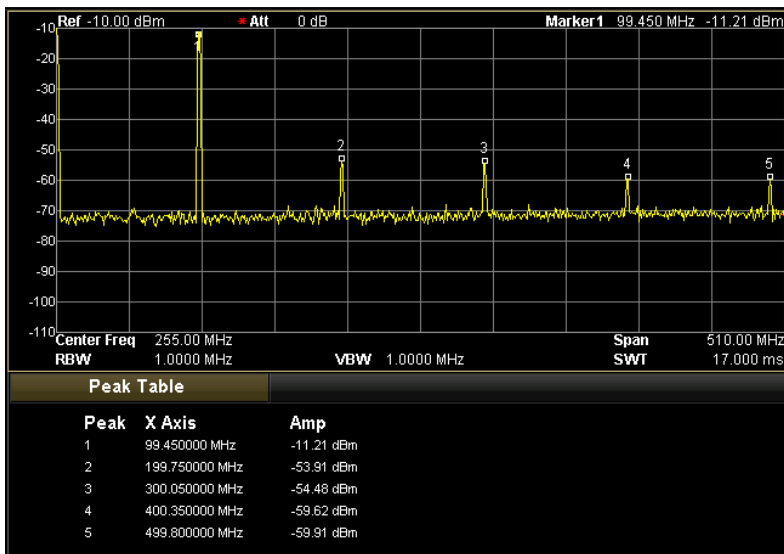

Figure 2-28 Peak Table

#### 1. State

Turn on or off the Peak Table, the default is Off.

#### 2. Peak Sort



Chooses a rule for peak sorting, the default is frequency ascending.

### 3. Pk Readout

Sets the peak display condition to Normal, >DL or <DL.

- Normal

Displaying the first ten qualified peaks in the table.

- >DL

Displaying the first ten peaks that not only meet the parameter conditions but also have an amplitude greater than the specified Display Line (from **Display** menu) in the table.

- <DL

Displaying the first ten peaks that not only meet the parameter conditions but also have an amplitude smaller than the specified Display Line (from **Display** menu) in the table.

## 2.5.5 L-Peak

The shortcut key of the Left peak measurement, which has the same function as the **L-Peak** menu under the **Peak** key: Searches the nearest peak located to the left side of the current peak and meets the searching condition, and identifies it with a marker.

## 2.5.6 R-Peak

The shortcut key of the Right peak measurement, which has the same function as the **R-Peak** menu under the **Peak** key: Searches the nearest peak located to the right side of the current peak and meets the searching condition, and identifies it with a marker.

## 2.6 System Functions

### 2.6.1 System

Under this menu, you can select the display Language; reset the analyzer; calibrate the analyzer; set I/O; select reference source; set the probe power, front switch and coupling parameters; view system information and status; set time and date as well as manage the option license.

#### 2.6.1.1 Language

Selects the desired display language.

#### 2.6.1.2 Reset

Selects the instrument settings to be recalled after the analyzer is powered on. The power on setting includes Last and Preset, and Preset has two types: Factory and User.

##### 1. Power On

Sets the power on setting to Last or Preset.

- When **Last** is selected, settings before the last power-off would be recalled automatically when power on.
- When **Preset** is selected, settings defined in the **Preset Type** would be recalled automatically when power on.

##### 2. Preset Type

Sets the preset type to factory (default) or User. The preset will be recalled after the following operations:

- Start-up the analyzer when **Power On** setting is "Preset".
- Press **Preset**

##### 3. Save Preset

Saves the current instrument settings as the user-defined setting into the internal non-volatile memory, and these settings will be recalled when the Preset Type is set to User.

### **2.6.1.3 Calibrate**

#### **1. Cal Now**

The analyzer will use the internal calibration source to perform a self-test as soon as the menu key is pressed.

#### **2. Self-Cal**

This function drives the analyzer to perform a regular self-calibration according to the environmental temperature so as to compensate for the system error.

### **2.6.1.4 I/O Settings**

This analyzer supports communications through the LAN, USB and GPIB interface. Both LAN and USB are standard interfaces, and GPIB should be configured by using a USB-GPIB module provided by RIGOL. To get the USB-GPIB module, please contact **RIGOL**.

#### **1. LAN**

Sets or resets the LAN parameters.

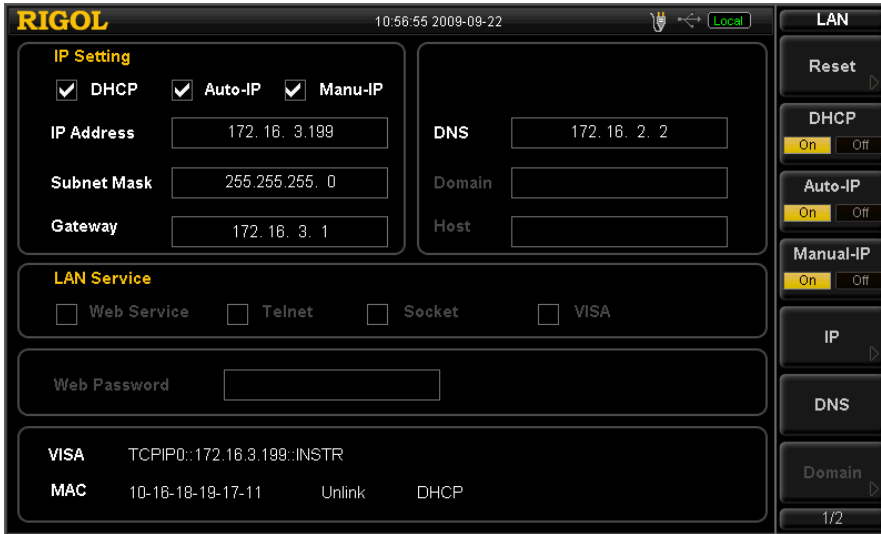

Figure 2-29 LAN parameter setting

The following items can be set through the front panel or remote interface.

- **Reset:** Turns on the DHCP and Auto-IP, close Manual-IP, and then clear the existing web password.
  - **DHCP:** one of the setting methods of IP address. The DHCP server assigns an IP address, subnet mask and gateway to the analyzer on the basis of the current network status.
  - **Auto-IP:** one of the setting methods of IP address. The analyzer obtains an IP address (from 169.254.0.1 to 169.254.255.254) and a fixed subnet mask 255.255.0.0 automatically.
  - **Manual-IP:** one of the setting methods of IP address. In this type users can define a desired IP address for the analyzer.
  - **IP:** Sets the IP address, subnet mask and gateway manually.
- NOTE: The analyzer will always try to get an IP address in the order of DHCP, Auto-IP and Manual-IP. Note that these three ways cannot be disabled at the same time.**
- **DNS:** Sets the IP address of the DNS server.
  - **Web password:** Sets the login password for the remote control. Note that this password is only available for the remote interface.

## 2. USB

Sets the class and address of the USB device. The device class includes Auto Configure (default), TMC and Printer. The address is read-only and cannot be edited.

- Auto Configure: the type depends on the USB host device.
- TMC: uses the analyzer as a Test & Measurement Class device.
- Printer: uses the analyzer as a Printer Class device.

### 3. GPIB

Sets the GPIB address.

You can modify this parameter using the numeric keys, knob or direction keys.

For more details, please refer to "**Parameter Input**".

Table 2-58 GPIB address

Parameter	Explanation
Default	18
Range	0 to 30
Unit	N/A
Knob Step	1
Direction Key Step	1

#### 2.6.1.5 Ref Source

Selects the internal or external reference source, the default is internal. The Reference source is used to synchronize all of the equipment clocks in this measurement system so as to decrease the frequency deviation.

##### 1. Internal Reference Source

When internal reference source is in use, a reference signal that enables synchronization to other devices will be outputted from the **10 MHz IN/OUT** terminal at the rear panel.

##### 2. External Reference Source

An external reference source at the **10 MHz IN/OUT** terminal at the rear panel can be used to synchronize the analyzer and other devices. In case of any loss, unconnected or over range issues in respect of the source, a message like "Ext Ref Invalid" will be shown in the status bar of the screen.

### 2.6.1.6 Probe Power

Turns on or off the probe power output at the terminal of **PROBE POWER**. This power is supplied with two lines: 15 V/150 mA and -12.6 V/150 mA.

### 2.6.1.7 Front Switch

Sets the status of the front switch, the default is On. If On is selected, you should press the power key at the front panel to start-up the analyzer after turning on the rear switch, otherwise the analyzer will start after you turn on the power switch at the rear panel.

### 2.6.1.8 Coupl Param

Sets all related parameters automatically according to the coupling relationship.

#### Definitions of the coupling parameters:

##### 1. CF Step

This parameter maintains a coupling relationship with the span (or RBW) in zero span (or non-zero span) mode. Refer to "2.1.1.4 CF Step" for more details.

##### 2. Reference level

This parameter maintains a coupling relationship on the maximum mixer level with either the input attenuator or the preamplifier. Refer to "2.1.3.2 Ref Level" for more details.

##### 3. Input Attenuation

This parameter maintains a coupling relationship on the maximum mixer level with either the reference level or the preamplifier. Refer to "2.1.3.2 Ref Level" for more details.

##### 4. RBW

This parameter maintains a coupling relationship on the span. Refer to "2.2.1.1 RBW" for more details.

**5. VBW**

This parameter maintains a coupling relationship with the RBW. Refer to "2.2.1.2 VBW" for more details.

**6. Sweep Time**

This parameter maintains a coupling relationship with the RBW, VBW and span. Refer to "2.2.2.1 Time" for more details.

**2.6.1.9 Information**

Views the system information or messages recently shown on the screen.

**1. System Information**

- Model
- Serial Number
- Version of Radio Frequency Board
- Version of Digital Board
- Version of Radio Frequency Board FPGA
- Version of Digital Board FPGA
- Version of Firmware

**2. System Message**

Views the system messages that have appeared recently (up to 71 items). For more information about the system message, refer to "5.2 Messages".

**2.6.1.10 Status****1. Analyzer**

Shows the basic setting information about the measurement, such as Frequency, Span, Amplitude, and Sweep Time.

**2. Power**

Shows the setting information related to the advanced measurement functions, such as T-Power, ACP, Chan Pwr, OBW, EBW, C/N Ratio, Harmo Dist, TOI and Pass/Fail.

**3. TG**

Shows the setting information related to the Tracking Generator.

**4. Demod**

Shows the setting information related to the Demod function.

**5. Corrections**

Shows the setting information related to the amplitude correction.

**2.6.1.11 Self-Test****1. Screen Test**

Tests if the screen has a dot defect by using five colors: White, Red, Green, Blue and Black.

**2. Key Test**

Tests if all the keys from the front panel work normally by pressing one by one. If the relative key shown from the interface of the analyzer lights when some panel-key is pressed, this indicates that the key you pressed is in normal service, or else an error may have occurred in this key. Note if the key at the front panel is transparent, its backlight will also light when you press it. To exit the testing, press **ESC** three times.

**2.6.1.12 Time/Date****1. Time/Date**

Enables or disables the Time/Date display.

**2. Set Time**

Sets the display time of the analyzer. The time format should be HHMMSS, for example, 231211 (denotes 23:12:11).

**3. Set Date**

Sets the display date of the analyzer. The date format should be YYYYMMDD, for example, 20091001 (denotes October 1st, 2009).



### 2.6.1.13 License

Enter the Options management interface and use the direction key to select an option and input correct license so as to install the option. Each option has a unique license and can only be used in the analyzer itself. For more information about the options, refer to "**Appendix A: Options and Accessories**".

#### 1. License Key

Inputs the license key of the selected option.

#### 2. Active

Activates the input license key.

#### 3. Del License

Deletes the input license key and closes the corresponding option function.

## 2.6.2 Display

Controls the screen display of the analyzer, such as setting the display line, active function, hold time of the menu, graticule, screen state, brightness, skin, and message switch.

### 2.6.2.1 Display Line

Turns on or off the display line, or changes its position. This line can be used as either the reference for you to read the measurement result, or the threshold value for the peaks displayed in the peak table.

#### Key Points:

- This line is a horizontal reference of which the amplitude is equal to the set value and the amplitude has the same unit with the selected unit from **Units**.
- You can modify this parameter using the numeric keys, knob or direction keys. For more details, please refer to "**Parameter Input**".

Table 2-59 Display line

Parameter	Explanation
<b>Default</b>	0 dBm
<b>Range</b>	Current display amplitude range
<b>Unit</b>	dBm, dBmV, dBuV, V, W
<b>Knob Step</b>	Step = Scale/10 (Log scale type) Step = 0.1 dB (Lin scale type)
<b>Direction Key Step</b>	Step = Scale (Log scale type) Step = 1 dB (Lin scale type)

### 2.6.2.2 Active Fct

Selects the position in which the active function displays for convenient observation of the measurement result. Selectable positions are Top (default), Center and Bottom. Pressing **ESC** key closes the display of the active function.

### 2.6.2.3 Menu Hold

Sets the holdtime of the menu to 3s, 5s, 10s, 20s, or Infinite. The screen enters the Full screen after the specified hold time.

### 2.6.2.4 Graticule

Sets the brightness of the grid. This parameter can be used to highlight the display of the trace.

You can modify this parameter using the numeric keys, knob or direction keys. For more details, please refer to "**Parameter Input**".

Table 2-60 Graticule

Parameter	Explanation
Default	5
Range	0 to 10
Unit	N/A
Knob Step	1
Direction Key Step	1

### 2.6.2.5 Scr Saver

Sets the latency before the screen enters the Screen Saver mode after the analyzer becomes idle. The latency can be 1 min, 15 mins, 30 mins or 1 hour. The pattern of the Screen Saver refreshes its display position per minute.

### 2.6.2.6 Scr State

Turns on or off the screen state, the default is On. If you select Off, a message like "The display was locked, please press Esc to unlock." will be given to prompt you that the screen has stopped refreshing to improve the measuring rate. In remote mode, the screen will always be locked.

### 2.6.2.7 Brightness

Sets the LCD brightness of the analyzer.

You can modify this parameter using the numeric keys, knob or direction keys. For more details, please refer to "**Parameter Input**".

Table 2-61 Brightness setting

Parameter	Explanation
Default	200
Range	0 to 255
Unit	N/A
Knob Step	10
Direction Key Step	20

### 2.6.2.8 Skin

Sets the skin to Classic or Modern.

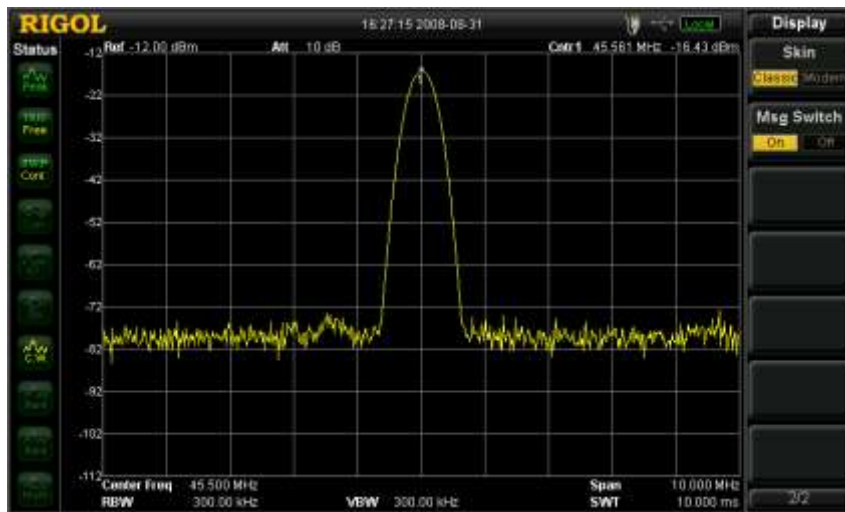

Figure 2-30 Classic display

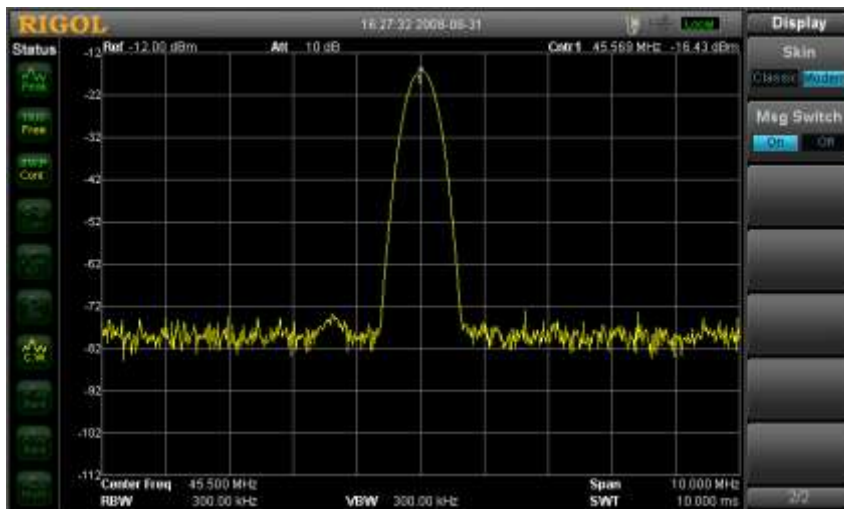

Figure 2-31 Modern display

### 2.6.2.9 Msg Switch

Enables or disables the display of messages. The types of messages in this analyzer include Information Message, Error Message and Status Message. Only Information Messages appear if the message switch is Off. For more details about messages, refer to "5.2 Messages".

## 2.6.3 Preset

Restores the analyzer to a specified status. This may change all parameters related to the sweep, the measurement function and the system.

### Key Points:

- Press **System** → **Reset** → **Preset Type** to select **Factory** or **User**.
- Press **Preset** to load Factory or User-defined settings.

For the factory settings, please see table below:

Table 2-62 Factory Default

Parameter	Default
<b>Frequency</b>	
Center Freq	1.5 GHz
Start Freq	0 Hz
Stop Freq	3 GHz
CF Step	Auto, 300 MHz
Signal Track	Off
<b>Span</b>	
Span	3 GHz
<b>Amplitude</b>	
Ref Level	0 dBm
Ref Offset	0 dB
Scale/Div	10 dB
Input Atten	Auto, 10 dB
Scale Type	Log
Units	dBm
RF Preamp*	Off
MaxMixL	-10 dBm
<b>Corr</b>	
Corrections	Off
<b>Detector</b>	
Detector Type	Pos Peak
<b>Demod*</b>	
Demod	Off

Speaker	Off
Volume	100
Demod Time	100 ms
<b>BW</b>	
RBW	Auto, 1 MHz
VBW	Auto, 1 MHz
V/R Ratio	1
<b>Sweep</b>	
Time	Auto, 100 ms
Auto SWT	Normal
Mode	Cont
Numbers	1
Points	601
<b>Source*</b>	
TG	Off
Power Sweep	Off
Ref Trace	Off
Freq Offset	0 Hz
TG Level	0 dBm
TG Lvl Offset	0 dB
Normalize	Off
Norm Ref Lvl	0 dB
Norm Ref Pos	100%
<b>Trig</b>	
Trig Type	Free Run
Trig Level	0 dBm
Edge	Positive
<b>Measure*</b>	
Meas Fctn	Off
Meas Mode	Cont
<b>Measure Setup*</b>	
<b>T-Power</b>	
Avg Num	Off, 10
Avg Mode	Exp
TP Type	Peak
Start Line	0 us

Stop Line	100 ms
<b>ACP</b>	
Avg Num	Off, 10
Avg Mode	Exp
Main CH BW	2 MHz
Adj CH BW	2 MHz
CH Spacing	2 MHz
<b>Chan Power</b>	
Avg Num	Off, 10
Avg Mode	Exp
Integ BW	2 MHz
CH Pwr Span	3 MHz
<b>OBW</b>	
Avg Num	Off, 10
Avg Mode	Exp
Max Hold	Off
OBW Span	2 MHz
Power Ratio	99%
<b>EBW</b>	
Avg Num	Off, 10
Avg Mode	Exp
Max Hold	Off
EBW Span	2 MHz
EBW X dB	-10 dB
<b>C/N Ratio</b>	
Avg Num	Off, 10
Avg Mode	Exp
Offset Freq	2 MHz
Noise BW	2 MHz
Carrier BW	2 MHz
<b>Harmo Dist</b>	
Avg Num	Off, 10
Avg Mode	Exp
NO.of Harmo	10
Harmonic ST	10 ms
<b>TOI</b>	



Avg Num	Off, 10
Avg Mode	Exp
TOI Span	2 MHz
<b>Pass/Fail</b>	
Limit	Upper
Test	Off
Point	1
X-axis	Freq
Connected	No
Freq Interp	Lin
Fail Stop	On
<b>Trace</b>	
Select Trace	1
Trace Type of Trace 1	Clear Write
Avg Times	100
Function	A-B
A	T1
B	T2
Const	0
Math Operate	Off
<b>Marker</b>	
Select Mkr	1
Mkr Type	Normal
Mkr Trace	Auto
Readout	Frequency
Mkr Table	Off
<b>Peak</b>	
Cont Peak	Off
Peak Search	Max
Pk Excursn	10 dB
Pk Thresh	-90 dBm
Peak Table	Off
Peak Sort	Freq
Pk Readout	Normal
<b>Mkr Fctn</b>	
Mkr Fctn	Off

N dB BW	-3 dB
State	Off
Resolution	Auto, 1 kHz
<b>System</b>	
I/O Setting	Off
DHCP	On
Auto-IP	On
Manual-IP	Off
USB Dev Class	TMC
GPIB Address	18
Ref Source	Int
Probe Power	Off
Front Swith	On
Information	System Info
Status	Analyzer
Time/Date	On
Self-Cal	On
<b>Storage</b>	
File Type	State
Format	BIN
File Source	T1
Browser	Dir
Input Style	English
Prefix Name	Off
<b>Display</b>	
Display Line	Off, 0 dBm
Active Fctn	Top
Graticule	5
Menu Hold	Infinite
Scr Saver	Off
Scr State	On
Brightness	200
Skin	Classic
Msg Switch	On
<b>Print</b>	
Orientation	Landsc

Page Size	Default
Inverted	Off
Palette	Gray
Copies	1
Date Prints	Off
Qualities	Default
File Type	Default

\*Note: For DSA1030 only.

## 2.6.4 Storage

Instrument settings and waveform data can be saved to or loaded from files in the internal memory of the analyzer or external USB flash devices. Press **Storage** to enter the file operation manager, see figure below.



Figure 2-32 File operation manager

Icons in the manager are:

Table 2-63 File icons

Icon	Explanation	Icon	Explanation
	Disk		CSV file
	A closed folder		Marker file
	An opening folder		Setting file
	Unknown file		Trace file
	Bitmap file		Status file
	Marker table file		Limit file

### 2.6.4.1 File Type

The analyzer can make files such as Setting file, Status file, Trace file, Amplitude correction file, Measurement data, Marker table file, Peak table file and Limit file, the default is Status file. For the details about each file, see table below.

Table 2-64 File type

File Type	Format	Extension
<b>Setting</b>	BIN	.set
<b>Status</b>	BIN	.sta
<b>Trace</b>	BIN	.trc
	CSV	.csv
<b>Amplitude correction</b>	BIN	.cbl
	CSV	.csv
<b>Measurement data</b>	CSV	.csv
<b>Marker table</b>	BIN	.mkr
	CSV	.csv
<b>Peak table</b>	CSV	.csv
<b>Limit</b>	BIN	.lim

### 2.6.4.2 Format

Sets the storage format of the measurement data to BIN (default) or CSV. BIN is a binary format while CSV is a character file that can be read by Excel. Note that this menu is available only in an external USB storage.

### 2.6.4.3 File Source

Sets the file source of the storage to T1, T2, T3, Math Trace or All. Note that this menu is available only when the **File Type** is set to Trace and the storage in current use is an external USB flash device.

#### **2.6.4.4 Browser**

Sets the browser to a directory or File. You can browse by using the direction keys or the knob.

#### **2.6.4.5 Save**

Saves a file into the external or internal memory.

#### **2.6.4.6 Expand Dir**

Expands the directories. Note that the **Browser** menu should be Dir.

#### **2.6.4.7 Coliapse Dir**

Collapses the directories. Note that the **Browser** menu should be Dir.

#### **2.6.4.8 Recall**

Reads the selected file and loads it into the system.

#### **2.6.4.9 Rename**

Renames a stored file.

#### **2.6.4.10 Delete**

Deletes the selected file.

### 2.6.4.11 Disc Mgr

#### 1. Format (D:)

Formats the local disk.

#### 2. Disk Info

View the disk information such as disk name, disk type, file system, the used space and the total space.

### 2.6.4.12 System Update

Updates the analyzer software after selecting the update file in the connected USB flash device.

### 2.6.4.13 Name Prefix

#### 1. Prefix Switch

Enables or disables the edited prefix name. The input box will automatically load the prefix name after you press **Save** when **Prefix Switch** is set to On.

#### 2. Edit

Edits the required prefix name by using the virtual keyboard. Up to 15 characters can be entered.

## 2.6.5 Print Setup

Sets the print parameters. The analyzer supports a PictBridge printer. To use the print function, connect this printer with the analyzer as shown in the figure below, and then press **System** → **I/O Setting** → **USB** → **Dev Class** → **Printer** to enable the analyzer to be a Printer Class device and set desired print parameters; then press **Print** to print out the measurement data that you want.

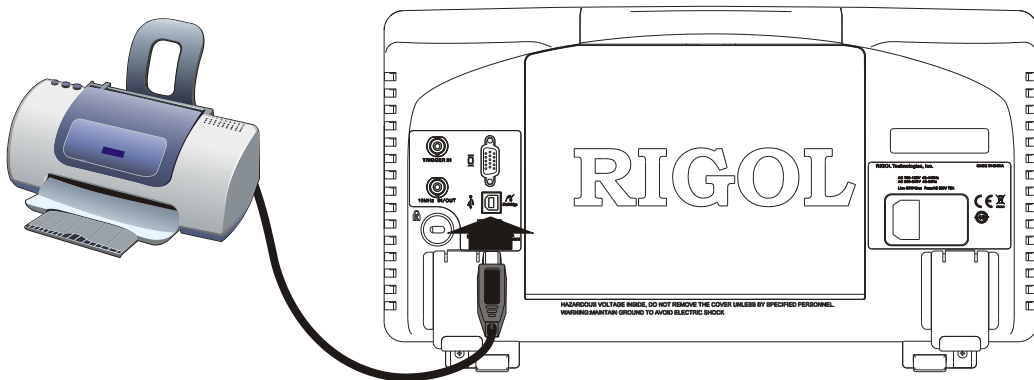





Figure 2-33 PictBridge printer connection

### Printing Procedures:

- (1) Turn on the PictBridge printer and wait for the initialization.
- (2) Use the USB cable provided in the accessories to connect the analyzer with the PictBridge printer.
- (3) Then a message like "PictBridge printer connected." is shown on the screen to prompt you that the instrument now is initializing the driver and the printer module.
- (4) When installation is finished, a message like "PictBridge printer installed successfully." will be displayed on the screen so that you can start the print job.
- (5) Before printing, the analyzer always changes the sweep mode to Single and stops sweeping in order to save the frozen measurement result.
- (6) The print state and process are shown on the status bar of the screen during printing.
- (7) You can pause and resume the printing if necessary.
- (8) The printer enters the idle state and waits for the next task after a successful print job.



Table 2-65 The printing state icons

Icon	Explanation
	The two icons display alternately, indicating that the printer now is connecting.
	Successful connection, print finished or idle.
	The two icons display alternately, indicating the print job is in progress.
	Print has been paused.

### 2.6.5.1 Print

Prints the measurement data according to current setting parameters when the printer has been successfully installed and is in idle state.

### 2.6.5.2 Resume

Resumes the print job that has been paused.

### 2.6.5.3 Cancel

Ends the current print job without completing it.

### 2.6.5.4 Orientation

Selects the print orientation to Landscape or Portrait, the default is Landscape.

### 2.6.5.5 Page Size

Selects a page size from A4, A5, A6, B5 or Default. The default size depends on the printer currently connected.

### **2.6.5.6 Inverted**

Turns on or off the inverted printing, the default is Off.

### **2.6.5.7 Palette**

Selects a print color from Gray and Color printing, the default is Gray.

### **2.6.5.8 Copies**

Sets the print copies, the default is 1. Note this instrument allows for up to 999 copies to be printed at one time.

### **2.6.5.9 Date Prints**

Turns on or off the date print, the default is Off.

### **2.6.5.10 Qualities**

Selects print quality to Normal, Draft, Fine or Default. The default quality depends on the printer currently in use.

**Hint**

"Fine" printing may consume more ink than other print quality settings.

### **2.6.5.11 File Type**

Sets the printing file type to Default or Exif/JPEG. The default type depends on the printer currently in use.

**Hint**

The analyzer can automatically identify the capabilities of the printer, such as Page size, print quality and file type.

## 2.6.6 Print

Presses  to save or print the current screen.

### Key Points:

- This operation prints out the current screen according to the print settings when a printer is connected.
- When no printer is connected but an USB flash device is detected, this operation saves the current screen as a default or specified file name to the root directory of USB flash device.
- If neither a printer nor a USB flash device is successfully connected, this operation will fail and be ignored.

## 2.7 Screen Control

Switches to the desired window and zoom it in or out in Multiwindow display.

### 2.7.1 Full Screen

Presses  to switch the screen into full screen mode. In this mode, neither the menus on the right side nor the parameter status on the left side of the screen would be displayed (see figure below) so that you can view the trace more clearly. To exit full mode, press this key again.

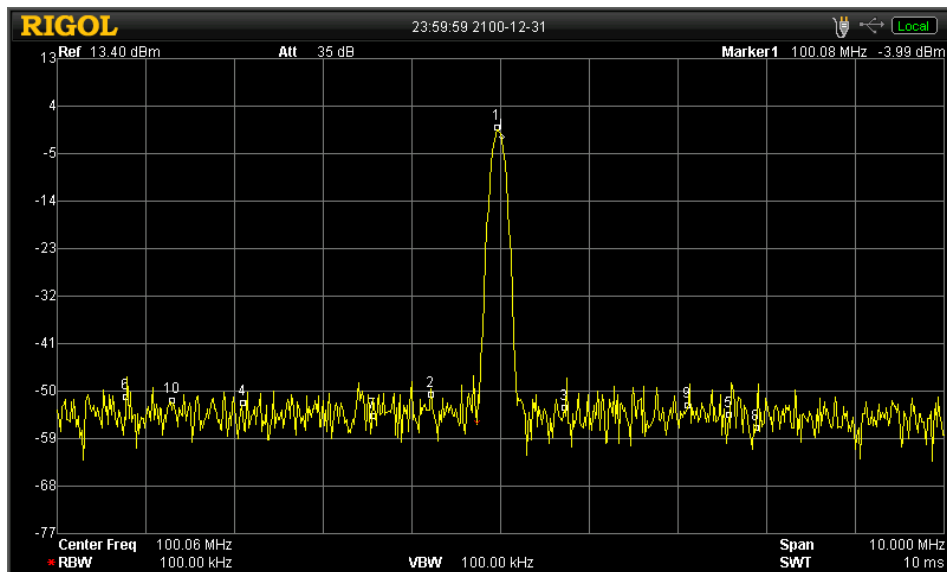



Figure 2-34 Full screen display

#### Key Points:

- Pressing any function key (except **Single**, **Continue**, **L-Peak** and **R-peak**), menu, or  again will exit full screen mode.
- Full screen state will remain unchanged when entering parameters so that you can observe how the measurement data changed according to the new parameter.
- The pixel count of the grid area is 751 in full screen and 601 in non-full screen mode.

## 2.7.2 Next Window

Press  continuously to select one of the two windows alternately. The selected window is highlighted, see figure below.

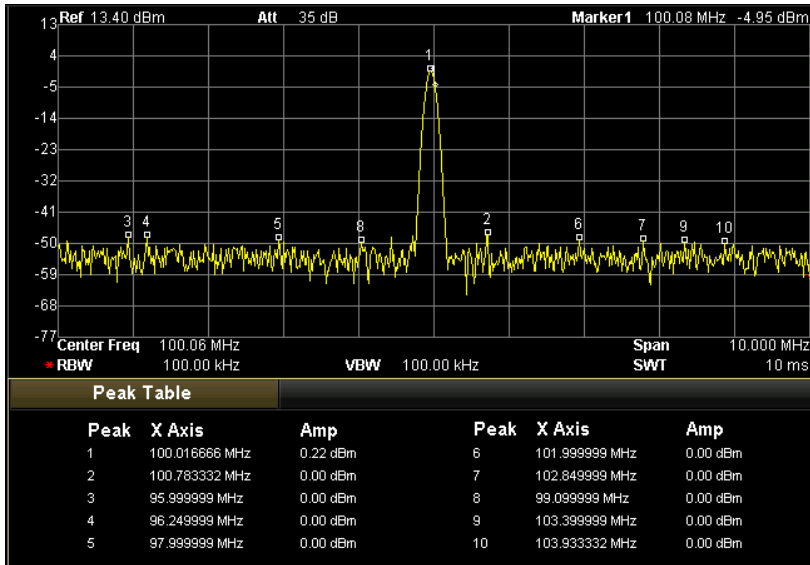





Figure 2-35 Switch between windows

### Key Points:

- Pressing  (described the following section) will zoom in on the selected window so that you can observe the trace or measurement data more clearly.
- If a window is zoomed in and the display has been in Multiwindow mode, continuously pressing  will display the two windows alternately.

## 2.7.3 Zoom

Zooms in the selected window by pressing .

The selected window will be zoomed in at the first press of this key. To exit this mode, presses this key again.

### Hint

The screen can be divided into two windows when one of the these functions is enabled: Marker table, Peak table, correction table or one of the advanced functions in **Meas**.





## 3 Measurement Examples

This chapter introduces the main functions and operations of the analyzer.

Subjects in this chapter:

- Measuring a Sine Signal
- Using the Frequency Counter
- Measuring an AM Signal (For DSA1030)
- Measuring the Phase Noise
- Measuring the N dB Bandwidth
- Measuring the Time-Domain Power (For DSA1030)
- Measuring the Adjacent Channel Power (For DSA1030)
- Measuring the Channel Power (For DSA1030)
- Measuring the Occupied Bandwidth (For DSA1030)
- Measuring the Emission Bandwidth (For DSA1030)
- Measuring the Carrier-to-Noise Ratio (For DSA1030)
- Measuring the Harmonic Distortion (For DSA1030)
- Measuring the TOI Distortion (For DSA1030)
- Pass/Fail Measurement (For DSA1030)
- Amplitude Correction
- Tracking Generator (For DSA1030)

## 3.1 Measuring a Sine Signal

The most basic task of an analyzer is measuring the frequency and amplitude of a signal. In the example below, we use a generator (such as RIGOL DG3101A) to output a sine signal at 100 MHz and -10 dBm and we will use this as the signal to measure.

### Procedures:

#### 1. Device attachment

Connect the output terminal of the generator to the **RF INPUT 50Ω** terminal on the front panel of the analyzer.

#### 2. Use Marker to measure

(1) Reset the analyzer

— Press **Preset**

(2) Set the parameters

— Press **FREQ**

— Press **Center Freq** and enter 100 MHz.

— Press **SPAN**

— Press **Span** and enter 10 MHz.

(3) User the marker

— Press **Marker**

A marker is activated.

— Press **Peak**

The peak is identified by a marker, and the frequency and amplitude of this signal are displayed at the top right of the grid.

#### 3. Measurement result

The frequency and amplitude of the signal under measure is 100 MHz and -10.05 dBm, see figure below.

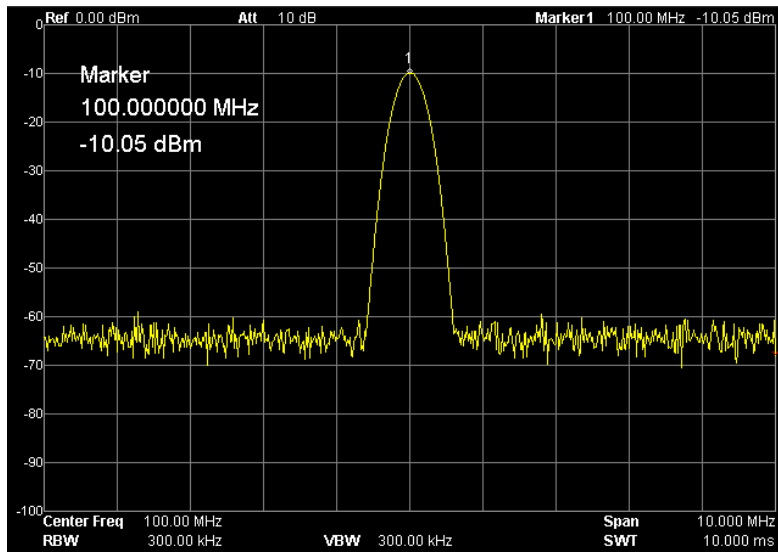

Figure 3-1 Measuring a Sine signal

## 3.2 Using the Frequency Counter

In order to get the precision frequency of the signal, the analyzer provides a frequency counter that is a much more precise frequency measurement than the Marker. In the example below, we use a generator (such as RIGOL DG3101A) to output a sine signal with 100 MHz and -10 dBm as the signal under measure.

### Procedures:

#### 1. Device attachment

Connect the output terminal of the generator to the **RF INPUT 50Ω** terminal on the front panel of the analyzer.

#### 2. Use the frequency counter to measure

(1) Reset the analyzer

– Press **Preset**

(2) Set the parameters

– Press **FREQ**

– Press **Center Freq** and enter 100 MHz.

– Press **SPAN**

– Press **Span** and enter 10 MHz.

(3) Open a marker

– Press **Marker**

A marker is activated.

– Press **Peak**

The peak is identified by a marker, and the frequency and amplitude of this signal are displayed at the top right of the grid.

(4) Use the frequency counter to measure

– Press **Marker Fctn**

– Press **Freq Count** and enter the lower menu.

– Press **State-On → On**, and the frequency will be shown in the active area and the top right corner of the grid.

(5) Set the measuring resolution of the Counter

– Press **Resolution** and enter 1 Hz.

#### 3. Measurement result

The result is 99.998459 MHz (with an accuracy of 1 Hz), see figure below.

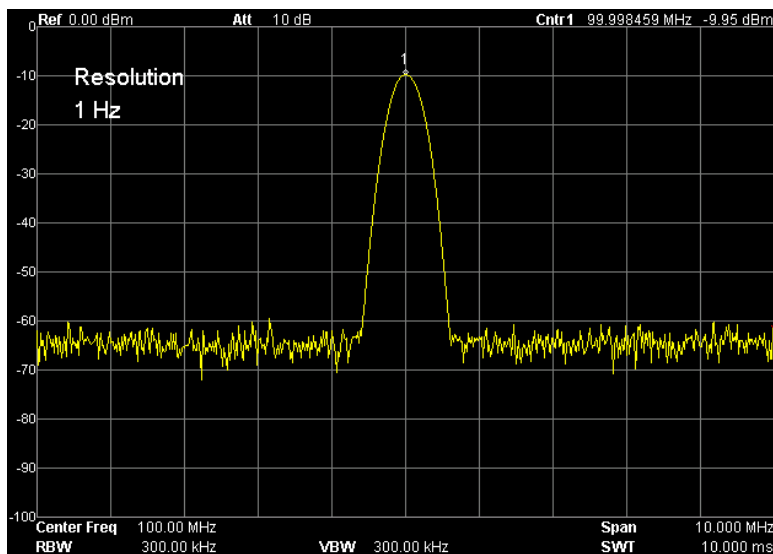

Figure 3-2 Use the frequency counter to measure

### 3.3 Measuring an AM Signal (For DSA1030)

Through the demodulation function, the AM modulating signal can be separated from the carrier and displayed on the screen. In the example below, we use a generator (such as RIGOL DG3101A) to output an AM modulating signal as the signal under measure: the carrier is a sine wave with 100 MHz and -10 dBm, the modulating frequency is 1 kHz, while the modulation depth is 100%.

#### Method 1: (in Zero Span)

##### Procedures:

#### 1. Device attachment

Connect the output terminal of the generator to the **RF INPUT 50Ω** terminal on the front panel of the analyzer.

#### 2. Measuring in zero span

(1) Reset the analyzer

— Press **Preset**

(2) Set the parameters

— Press **FREQ**

— Press **Center Freq** and enter 100 MHz.

— Press **SPAN**

— Press **Zero Span** and set the span of frequency as 0 Hz.

— Press **Sweep**

— Press **Time** and enter 10 ms in Manual mode.

(3) Use the marker to measure

— Press **Single**

— Press **Peak**

— Press **Marker**

— Press **Delta**

— Page down

— Press **Readout** and enter the lower menu.

— Press **1/Δ time**

— Press **R-Peak** or **L-Peak**

Also, you can press **Peak** → **Peak Right** or **Peak Left** to view the peaks at both sides.

— Read the frequency of the marker, that is the frequency of the modulating

signal.

### 3. Measurement result

The result is -1 kHz, see figure below.

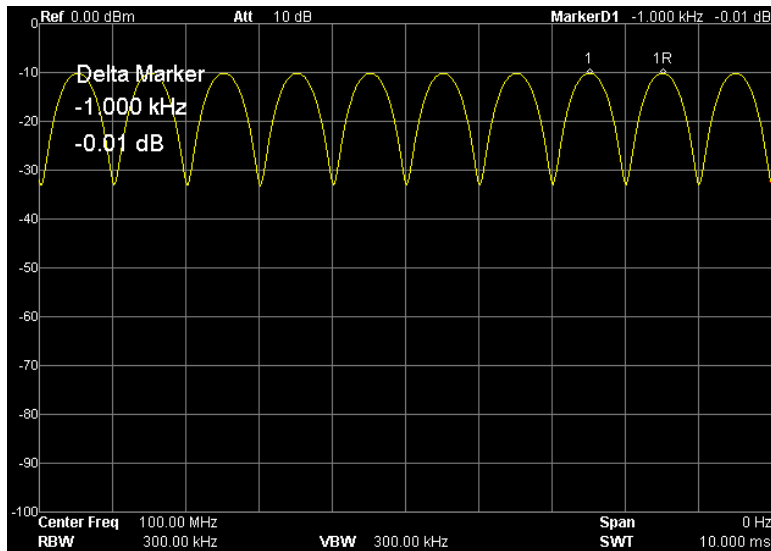



Figure 3-3 Measure an AM signal

## Method 2: (Use AM demodulation function)

### Procedures:

- (1) Reset the analyzer
  - Press **Preset**
- (2) Set the parameters
  - Press **FREQ**
  - Press **Center Freq** and enter 100 MHz.
  - Press **SPAN**
  - Press **Span** and enter 10 MHz.
- (3) Demodulate the signal
  - Press **Demod**
  - Press **Demod** and enter the lower menu.
  - Press **AM** to turn on AM demodulation function.

The frequency can be described by the acuity level of the speaker.
- (4) Set the parameters of AM demodulation function
  - Press 
  - Press **Demod Setup** and enter the lower menu.
  - Press **Speaker** to select whether or not to use the speaker under this function.
  - Press **Demod Time** and set the desired demodulating time.



## 3.4 Measuring the Phase Noise

The analyzer gives an easy way to measure the phase noise. In the example below, we use a generator (such as RIGOL DG3101A) to output a sine signal with 50 MHz and -10 dBm as the signal under measure.

### Procedures:

#### 1. Device attachment

Connect the output terminal of the generator to the **RF INPUT 50Ω** terminal on the front panel of the analyzer.

#### 2. User the noise marker to measure

(1) Reset the analyzer

– Press **Preset**

(2) Set the parameters

– Press **FREQ**

– Press **Center Freq** and enter 50 MHz.

– Press **SPAN**

– Press **Span** and enter 50 kHz.

– Press **BW**

– Press **RBW** and enter 1 kHz.

– Press **VBW** and enter 100 Hz.

(3) Measure the phase noise

– Press **Peak**

Execute the peak searching and activate a marker.

– Press **Marker**

– Press **Delta** and enter 10 kHz.

Measure the amplitude attenuation that deviates 10 kHz from the signal.

– Press **Marker Fctn**

– Press **Noise Mkr**

#### 3. Measurement result

The measured amplitude attenuation of the signal whose frequency deviates 10 kHz is -79.85 dB/Hz, see figure below.

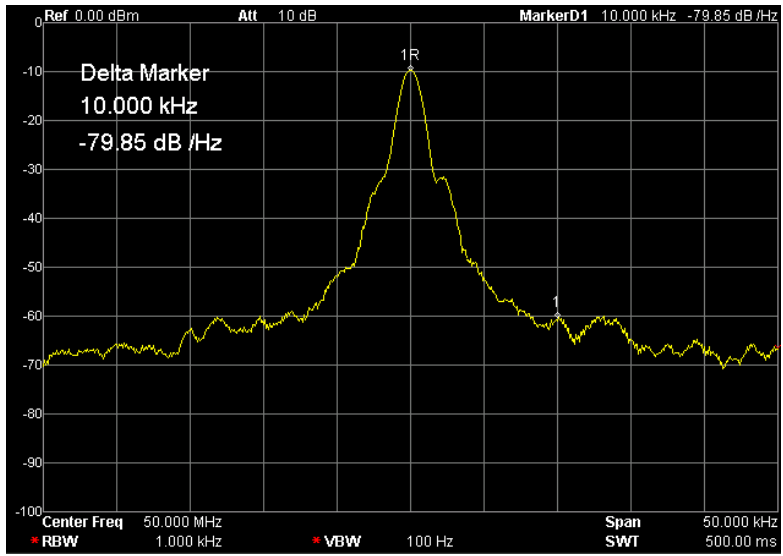

Figure 3-4 Phase noise measurement

## 3.5 Measuring the N dB Bandwidth

In the example below, we use a generator (such as RIGOL DG3101A) to output a sine signal with 100 MHz and -10 dBm as the signal under measure.

### Procedures:

#### 1. Device attachment

Connect the output terminal of the generator to the **RF INPUT 50Ω** terminal on the front panel of the analyzer.

#### 2. Use the N dB bandwidth measurement function

(1) Reset the analyzer

— Press **Preset**

(2) Set the parameters

— Press **FREQ**

— Press **Center Freq** and enter 100 MHz.

— Press **SPAN**

— Press **Span** and enter 2 MHz.

(3) Use the N dB bandwidth measurement function

— Press **Marker Fctn**

A marker will be activated if no Marker has been turned on before.

— Press **N dB BW** and enter 3 dB.

#### 3. Measurement result

From the active area shown below, we can see that the bandwidth of the two points where the signal degrades 3 dB from the current marker is 303.333 kHz.

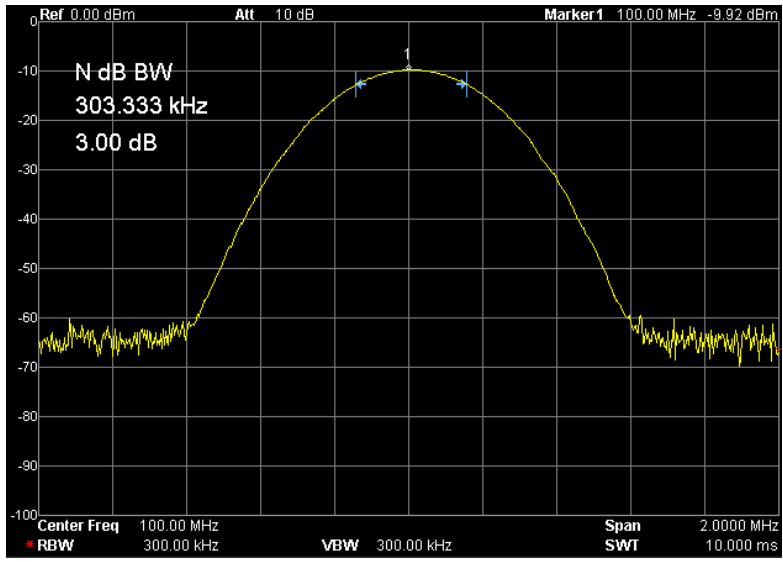

Figure 3-5 N dB bandwidth measurement result

## 3.6 Measuring the Time-Domain Power (For DSA1030)

The analyzer can measure the time-domain power such as the transmitted power in TDMA. In the example below, we use a generator (such as RIGOL DG3101A) to output a sine signal with 100 MHz and -10 dBm as the signal under measure.

### Procedures:

#### 1. Device attachment

Connect the output terminal of the generator to the **RF INPUT 50Ω** terminal on the front panel of the analyzer.

#### 2. Measure the time-domain power

(1) Reset the analyzer

– Press **Preset**

(2) Set the parameters

– Press **FREQ**

– Press **Center Freq** and enter 100 MHz.

– Press **Meas**

– Press **Meas Fctn** and enter the lower menu.

– Press **T-Power**

Read the measuring result from the measurement frame at the lower left corner.

(3) Modify the time power settings

– Press **Meas Setup**

– Press **Peak**

– Press **Start Line** and enter 1 ms.

– Press **Stop Line** and enter 9 ms.

#### 3. Measurement result

The measurement result shown in the lower window is -9.95 dBm, see figure below.

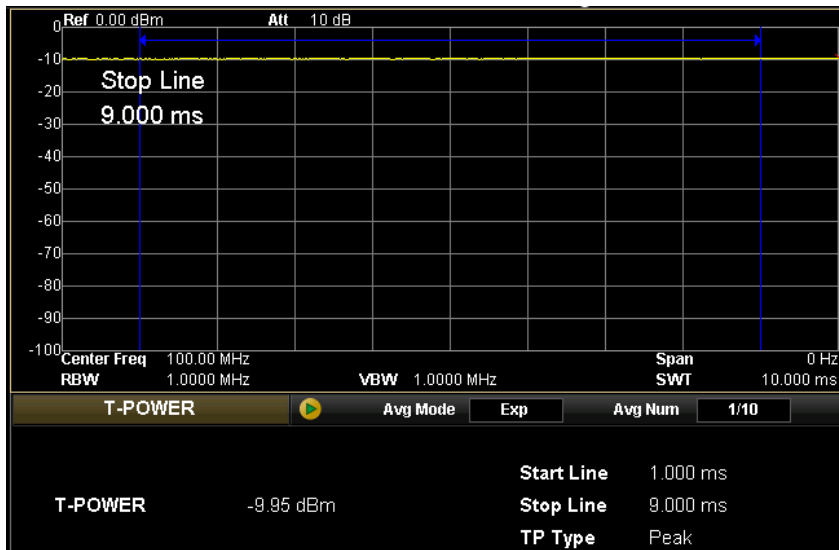

Figure 3-6 Time-domain power measurement

## 3.7 Measuring the Adjacent Channel Power (For DSA1030)

In the example below, we use a generator (such as RIGOL DG3101A) to output a sine signal with 100 MHz and -10 dBm as the signal under measure.

### Procedures:

#### 1. Device attachment

Connect the output terminal of the generator to the **RF INPUT 50Ω** terminal on the front panel of the analyzer.

#### 2. Measure the adjacent channel power

(1) Reset the analyzer

— Press **Preset**

(2) Set the parameters

— Press **FREQ**

— Press **Center Freq** and enter 100 MHz.

— Press **Meas**

— Press **Meas Fctn** and enter the lower menu.

— Press **Adj CH BW**

(3) Modify the adjacent channel power settings

— Press **Meas Setup**

— Press **Main CH BW** and enter 2 MHz.

— Press **Adj CH BW** and enter 2 MHz.

— Press **CH Spacing** and enter 2 MHz.

#### 3. Measurement result

The measurement results shown in the lower window are:

Main channel power: -9.55 dBm

Upper channel power: -57.85 dBm, difference with the main channel: -48.30 dBc

Lower channel power: -57.46 dBm, difference with the main channel: -47.91 dBc

See figure below.

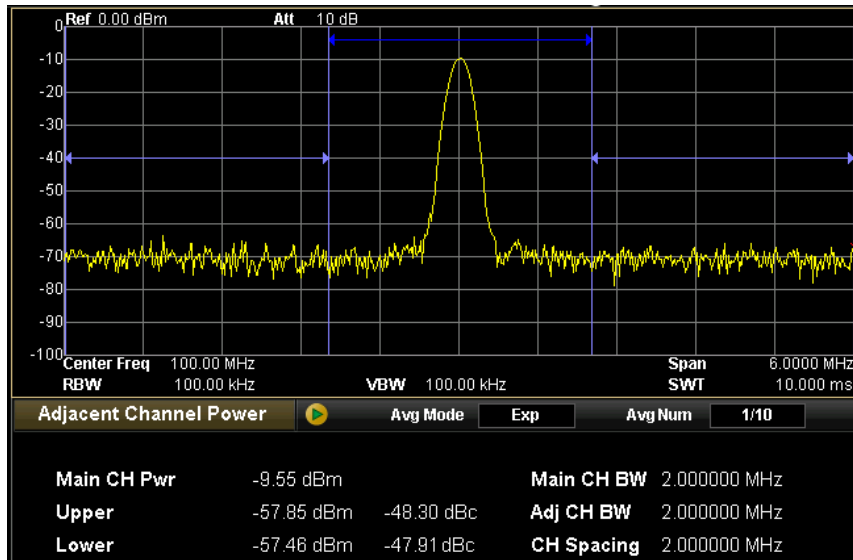

Figure 3-7 Adjacent channel power measurement result



## 3.8 Measuring the Channel Power (For DSA1030)

In the example below, we use a generator (such as RIGOL DG3101A) to output a sine signal with 100 MHz and -10 dBm as the signal under measure.

### Procedures:

#### 1. Device attachment

Connect the output terminal of the generator to the **RF INPUT 50Ω** terminal on the front panel of the analyzer.

#### 2. Measure the channel power

(1) Reset the analyzer

— Press **Preset**

(2) Set the parameters

— Press **FREQ**

— Press **Center Freq** and enter 100 MHz.

— Press **Meas**

— Press **Meas Fctn** and enter the lower menu.

— Press **Chan Pwr**

(3) Modify the channel power settings

— Press **Meas Setup**

— Press **Integ BW** and enter 1 MHz.

— Press **CH Pwr Span** and enter 2 MHz.

#### 3. Measurement result

The measurement results shown in the lower window are -9.61 dBm (channel power) and -69.61 dBm/Hz (power spectral density), see figure below.

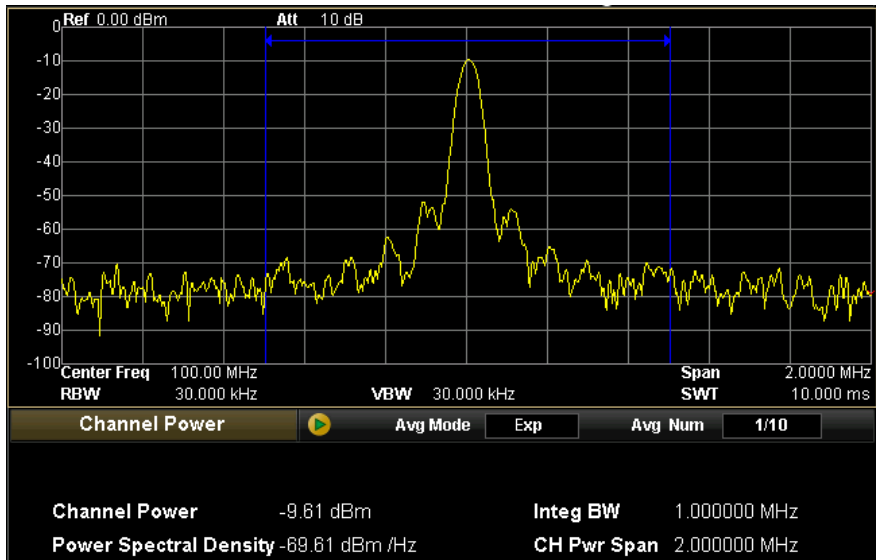

Figure 3-8 Channel power measurement result

## 3.9 Measuring the Occupied Bandwidth (For DSA1030)

In the example below, we use a generator (such as RIGOL DG3101A) to output a sine signal with 100 MHz and -10 dBm as the signal under measure.

### Procedures:

#### 1. Device attachment

Connect the output terminal of the generator to the **RF INPUT 50Ω** terminal on the front panel of the analyzer.

#### 2. Measure the power distribution

(1) Reset the analyzer

— Press **Preset**

(2) Set the parameters

— Press **FREQ**

— Press **Center Freq** and enter 100 MHz.

— Press **Meas**

— Press **Meas Fctn** and enter the lower menu.

— Press **OBW**

(3) Modify the occupied bandwidth settings

— Press **Meas Setup**

— Press **OBW Span** and enter 2 MHz.

— Press **Power Ratio** and enter 99%.

#### 3. Measurement result

The measurement results shown in the lower window are 53.333 kHz (Occupied bandwidth) and 0 Hz (Transmit frequency error), see figure below.

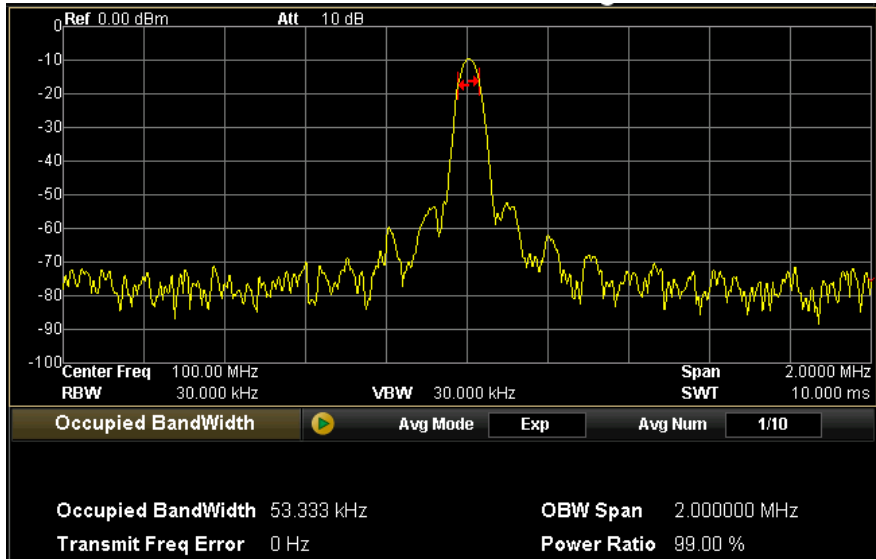

Figure 3-9 Occupied bandwidth measurement result

## 3.10 Measuring the Emission Bandwidth (For DSA1030)

In the example below, we use a generator (such as RIGOL DG3101A) to output a sine signal with 100 MHz and -10 dBm as the signal under measure.

### Procedures:

#### 1. Device attachment

Connect the output terminal of the generator to the **RF INPUT 50Ω** terminal on the front panel of the analyzer.

#### 2. Measure the emission bandwidth

(1) Reset the analyzer

— Press **Preset**

(2) Set the parameters

— Press **FREQ**

— Press **Center Freq** and enter 100 MHz.

— Press **Meas**

— Press **Meas Fctn** and enter the lower menu.

— Press **EBW**

(3) Modify the emission bandwidth settings

— Press **Meas Setup**

— Press **EBW Span** and enter 2 MHz.

— Press **EBW X dB** and enter -3 dB.

— Press **BW**

— Press **RBW** and enter 300 kHz.

#### 3. Measurement result

The measurement result shown in the lower window is 303.33 kHz, see figure below.

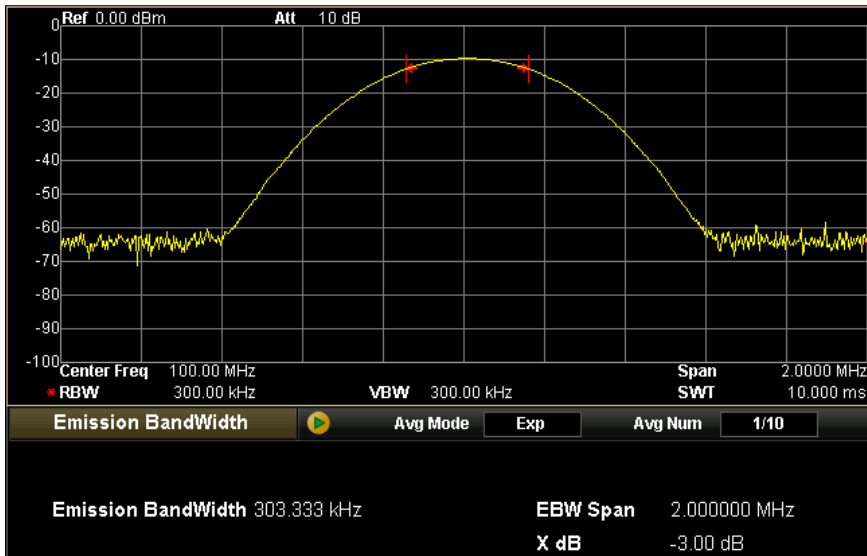

Figure 3-10 Emission bandwidth measurement result

## 3.11 Measuring the Carrier-to-Noise Ratio (For DSA1030)

In the example below, we use a generator (such as RIGOL DG3101A) to output a sine signal with 100 MHz and -10 dBm as the signal under measure.

### Procedures:

#### 1. Device attachment

Connect the output terminal of the generator to the **RF INPUT 50Ω** terminal on the front panel of the analyzer.

#### 2. Measure the signal over the C/N Ratio function

(1) Reset the analyzer

— Press **Preset**

(2) Set the parameters

— Press **FREQ**

— Press **Center Freq** and enter 100 MHz.

— Press **Meas**

— Press **Meas Fctn** and enter the lower menu.

— Press **C/N Ratio**

(3) Modify the C/N Ratio settings

— Press **Meas Setup**

— Press **Offset Freq** and enter 2 MHz.

— Press **Noise BW** and enter 2 MHz.

— Press **Carrier BW** and enter 2 MHz.

#### 3. Measurement result

The measurement results shown in the lower window are -9.55 dBm (carrier power), -57.92 dBm (noise power) and 48.37 dB (C/N Ratio), see figure below.

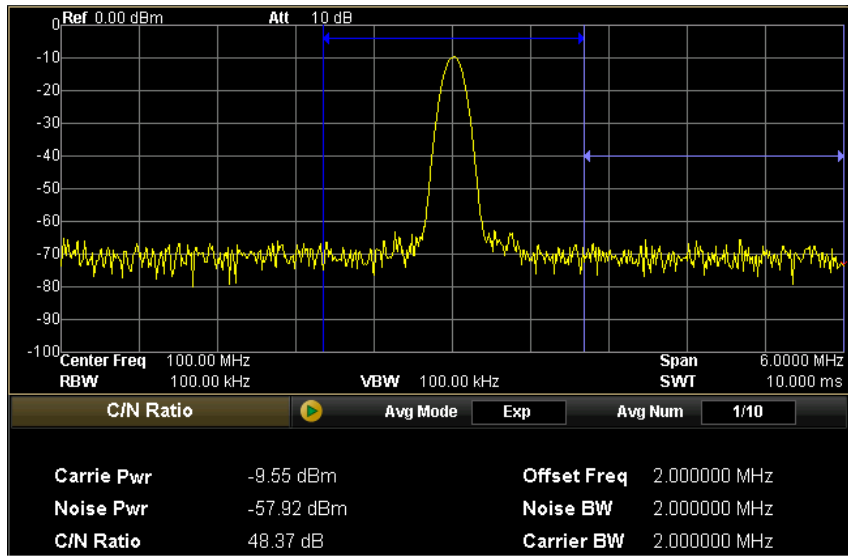

Figure 3-11 C/N Ratio measurement result



## 3.12 Measuring the Harmonic Distortion (For DSA1030)

In the example below, we use a generator (such as RIGOL DG3101A) to output a sine signal with 100 MHz and -10 dBm as the signal under measure.

### Method 1: (Use marker function to measure)

#### Procedures:

#### 1. Device attachment

Connect the output terminal of the generator to the **RF INPUT 50Ω** terminal on the front panel of the analyzer.

#### 2. Use marker to measure

(1) Reset the analyzer

— Press **Preset**

(2) Set the parameters

— Press **FREQ**

— Press **Center Freq** and enter 200 MHz.

— Press **Stop Freq** and enter 400 MHz.

— Press **BW**

— Press **RBW** and enter 100 kHz.

Now, you can see the fundamental wave, the second harmonic, and third harmonic of the signal.

(3) Use the **Peak** and **Marker** functions to measure

— Press **Peak**

Execute peak searching and activate a marker whose fundamental wave is marked with frequency of 100 MHz and amplitude of -10 dBm.

— Press **Marker**

— Press **Delta**

— Press **Peak**

— Press **Next Peak**

The "Ref" of the marker is then placed at the fundamental wave while the "Delta" is at the second harmonic. The measured value would be: the frequency offset is 100 MHz and the amplitude difference is -31.18 dB.

— Press **Next Peak**

The "Ref" of the marker is placed at the fundamental wave while the "Delta" is at the third harmonic. The measured value would be: the frequency offset is 200 MHz and the amplitude difference is -40.45 dB.

### 3. Measurement result

The fundamental wave and harmonics are shown in the figure below.

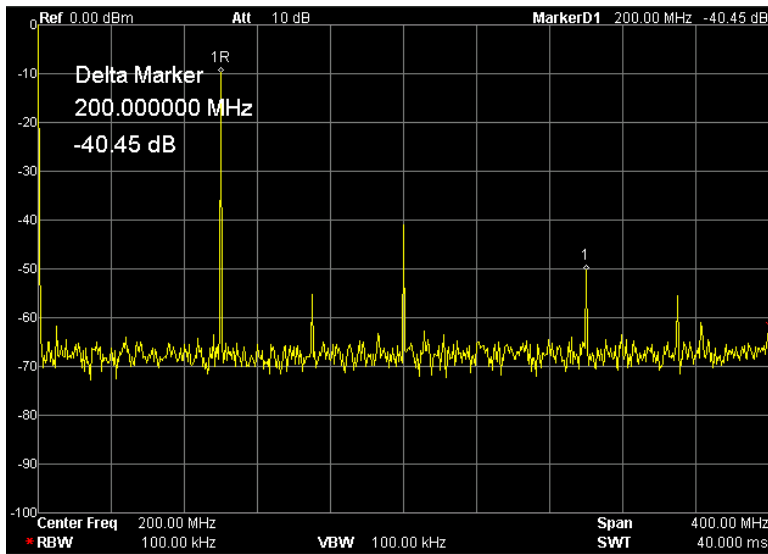

Figure 3-12 Use marker to measure harmonics

## Method 2: (Use Harmonic Distortion function to measure)

### Procedures:

#### 1. Device attachment

Connect the output terminal of the generator to the **RF INPUT 50Ω** terminal on the front panel of the analyzer.

#### 2. Use Harmonic Distortion function to measure

- (1) Reset the analyzer
  - Press **Preset**
- (2) Set the parameters
  - Press **FREQ**
  - Press **Center Freq** and enter 100 MHz.
  - Press **Meas**
  - Press **Meas Fctn** and enter the lower menu.
  - Page down
  - Press **Harmo Dist**
- (3) Modify the harmonic distortion settings
  - Press **Meas Setup**
  - Press **NO.of Harmo** and enter 3.

#### 3. Measurement result

The measurement results shown in the lower window are:

Fundamental wave: 100 MHz, -9.90 dBm

Second harmonic: 200 MHz, -41.76 dBm

Third harmonic: 300 MHz, -50.98 dBm

Total harmonic distortion (THD): 2.72%

See figure below.

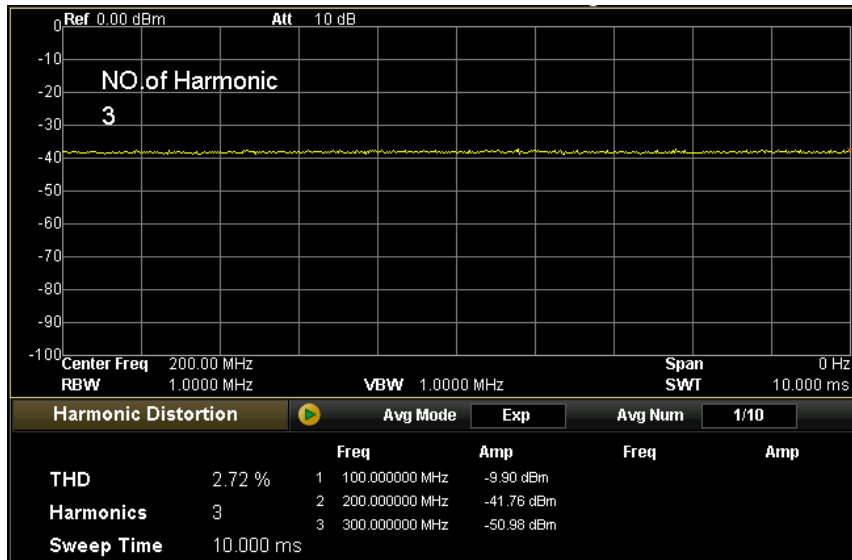

Figure 3-13 Harmonic Distortion measurement result

## 3.13 Measuring the TOI Distortion (For DSA1030)

In the example below, we use generator 1 (such as RIGOL DG3101A) to output a sine signal with 100 MHz and -10 dBm and generator 2 (such as RIGOL DG3121A) to output a sine signal with 100.2 MHz and -10 dBm as the signal under measure.

### Method 1: (Use marker function to measure)

#### Procedures:

##### 1. Device attachment

Connect the output terminals of generators 1 & 2 to the **RF INPUT 50Ω** terminal on the front panel of the analyzer through a power combiner.

##### 2. Measure frequency and amplitude

(1) Reset the analyzer

— Press **Preset**

(2) Set the parameters

— Press **FREQ**

— Press **Center Freq** and enter 100 MHz.

— Press **SPAN**

— Press **Span** and enter 1 MHz.

(3) **Use marker function to measure**

— Press **Peak**

Execute the peak searching and activate a marker.

— Press **Marker**

— Press **Delta**

— Press **Peak**

— Press **Next Peak**

Read the value measured by the marker.

##### 3. Measurement result

The result displays in the upper right corner of the screen, see figure below.

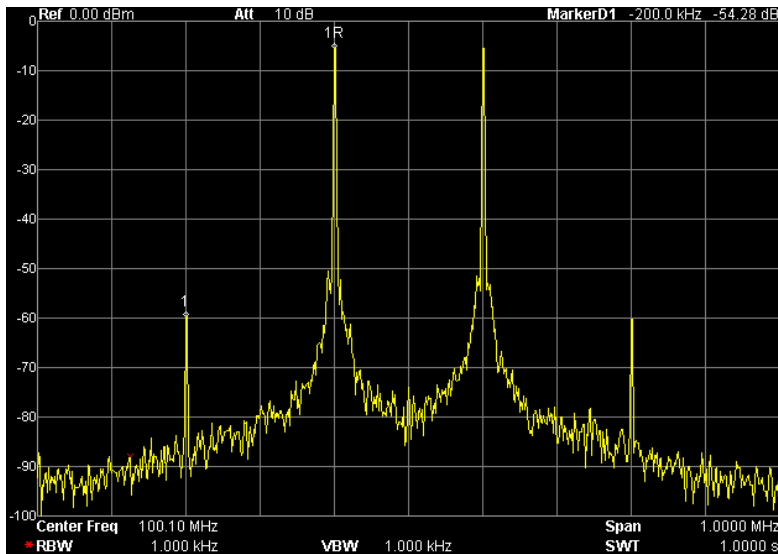

Figure 3-14 Use marker function to measure TOI distortion

## Method 2: (Use TOI function to measure)

### Procedures:

#### 1. Device attachment

Connect the output terminals of generators 1&2 to the **RF INPUT 50Ω** terminal on the front panel of the analyzer through a power combiner.

#### 2. TOI function to measure

- (1) Reset the analyzer
  - Press **Preset**
- (2) Set the parameters
  - Press **FREQ**
  - Press **Center Freq** and enter 100 MHz.
  - Press **SPAN**
  - Press **Span** and enter 1 MHz.
  - Press **Meas**
  - Press **Meas Fctn** and enter the lower menu.
  - Page down
  - Press **TOI**
- (3) Modify the TOI settings
  - Press **Meas Setup**

—Press **TOI Span** and enter 2 MHz.

### 3. Measurement result

The measurement results shown in the lower window are:

	<b>Freq</b>	<b>dBm</b>	<b>dBc</b>	<b>Intercept</b>
Base Lower	100 MHz	-5.7 dBm	0	---
Base Upper	100.2 MHz	-5.65 dBm	0.05	---
3rd Order Lower	99.8 MHz	-60.16 dBm	-54.46	21.53
3rd Order Upper	100.4 MHz	-60.93 dBm	-55.23	21.99

See figure below.

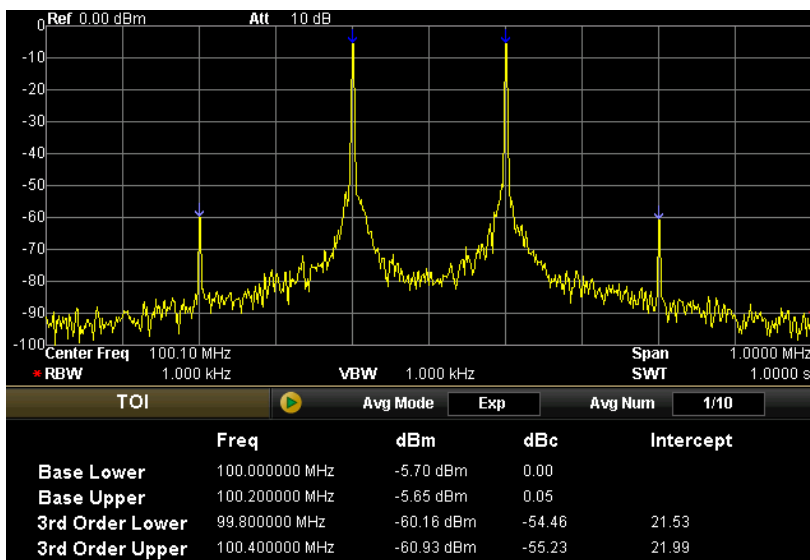

Figure 3-15 Use TOI function to measure TOI distortion

## 3.14 Pass/Fail Measurement (For DSA1030)

In the example below, we use a generator (such as RIGOL DG3101A) to output a sine signal with 100 MHz and -10 dBm as the signal under measure.

### Procedures:

#### 1. Device attachment

Connect the output terminal of the generator to the **RF INPUT 50Ω** terminal on the front panel of the analyzer.

#### 2. Measure the signal over the Pass/Fail function

(1) Reset the analyzer

– Press **Preset**

(2) Set the parameters

– Press **FREQ**

– Press **Center Freq** and enter 100 MHz.

– Press **SPAN**

– Press **Span** and enter 10 MHz.

– Press **Meas**

– Press **Meas Fctn** and enter the lower menu.

– Press **Pass/Fail**

(3) Edit the limit line

– Press **Meas Setup**

– Press **Edit**

– Press **Point** and enter 1.

– Press **X Axis** and enter 95 MHz.

– Press **Amplitude** and enter -55 dBm.

– Press **Connected** and select NO.

– Add the points listed in the table below.

No.	Upper	Ampl	Connected	No.	Lower	Ampl	Connected
1	95 MHz	-55 dBm	No	1	95 MHz	-75 dBm	No
2	99 MHz	-55 dBm	Yes	2	105 MHz	-75 dBm	Yes
3	99.5 MHz	-5 dBm	Yes				
4	100.5 MHz	-5 dBm	Yes				



5	101 MHz	-55 dBm	Yes				
6	105 MHz	-55 dBm	Yes				

(4) Turn on the test

- Press **Meas Setup**
- Press **Limit** and select Upper.
- Press **Test** and select On.
- Press **Limit** and select Lower.
- Press **Test** and select On.

### 3. Measurement result

The measurement results shown in the lower window are:

P: Pass

278: pass number

100%: P/F Ratio

See figure below.



Figure 3-16 Pass/Fail testing

## 3.15 Amplitude Correction

Edit an amplitude-frequency curve to correct the current measured curve.

### Procedures:

#### 1. Enter amplitude correction

- Press **AMPT**
- Page down
- Press **Corrections** and enter the lower menu.

#### 2. Select a curve

- Press **Select**
- Press **Antenna**
- Press 

#### 3. Open amplitude correction

- Press **Correction** to enable or disable the amplitude correction.
- Press **Corr Table** to turn on or off the correction table.

#### 4. Edit the correction points

- Press **Edit** and enter the lower menu.
- Press **Frequency** and enter 100 MHz.
- Press **Amplitude** and enter 10 dB.

A correction point with 100 MHz and 10 dB is added.

- Press **Point** and enter 2.
- Press **Frequency** and enter 200 MHz.
- Press **Amplitude** and enter 20 dB.

Another correction point with 200 MHz and 20 dB is added.

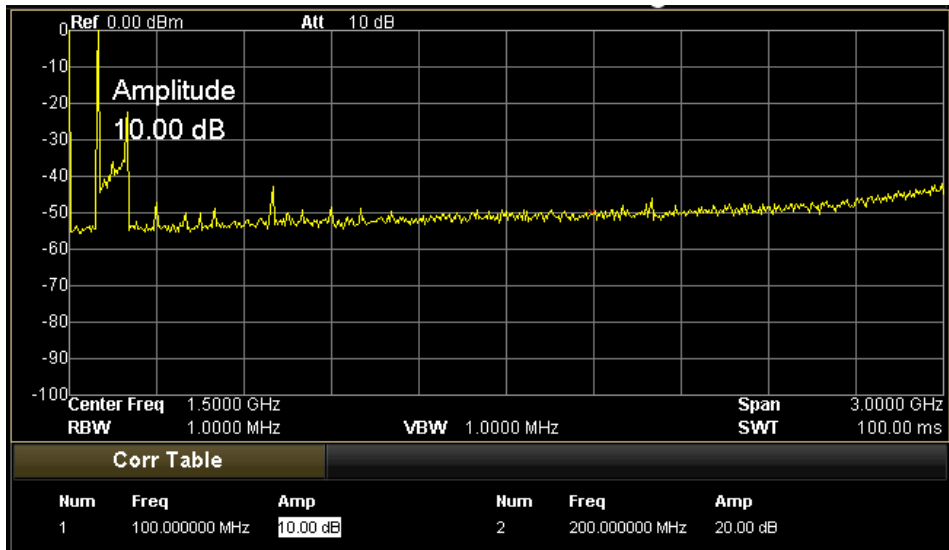

Figure 3-17 Amplitude correction

## 3.16 Tracking Generator (For DSA1030)

The frequency response of a filter can be measured by using the tracking generator of the analyzer. In the example below, we use a Low Pass Filter of 300 MHz as the filter under measure.

### Procedures:

#### 1. Device attachment

Connect the filter under measure to the **RF INPUT 50Ω** and **GEN OUTPUT 50Ω** terminal of the analyzer.

#### 2. Measure the frequency response of a filter

(1) Reset the analyzer

— Press **Preset**

(2) Set the parameters

— Press **FREQ**

— Press **Stop Freq** and enter 1GHz.

— Press **Source**

— Press **TG** and select On.

(3) Normalization

Connect the **RF INPUT 50Ω** terminal to the **GEN OUTPUT 50Ω** terminal.

— Press **Normalize** and enter the lower menu.

— Press **Stor Ref**

Save the reference curve and eliminate the influence of the frequency response from the analyzer itself.

Connect the filter under measure to the **RF INPUT 50Ω** and **GEN OUTPUT 50Ω** terminal of the analyzer.

— Press **Normalize** and turn on the normalization.

#### 3. Measurement result

The frequency response of the filter under measure is shown in the figure below.

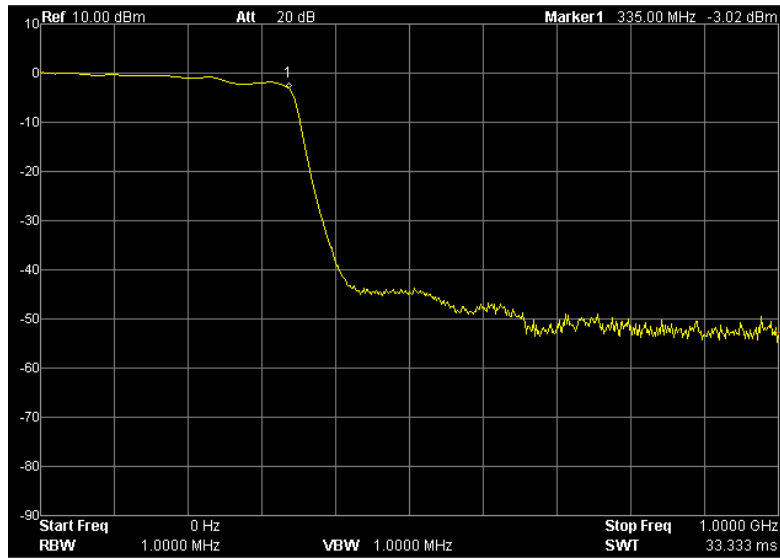

Figure 3-18 The frequency response of a filter



## 4 Remote Control

At least two means can be used to control the analyzer in Remote Mode:

### **User-defined programming**

Users can program and control the analyzer by using the SCPI (Standard Commands for Programmable Instruments) commands. For more information about the commands and programming, refer to the Programming Guide.

### **Use PC software provided by RIGOL or other manufacturers**

Users can also use the PC software **Ultra Sigma** (from RIGOL), **Measurement & Automation Explorer** (from National Instruments Corporation) or **Agilent IO Libraries Suite** (from Agilent Technologies, Inc.) to send commands and control the analyzer.

In this chapter, we will give the detailed description of how to use **Ultra Sigma** to control the analyzer via USB, LAN, or GPIB (expanded by the USB-GPIB module supplied by RIGOL). To get the Ultra Sigma software, please contact RIGOL.

Subjects in this chapter:

- Remote Control Via USB
- Remote Control Via LAN
- Remote Control Via GPIB

## 4.1 Remote Control Via USB

### 1. Connect the devices

Connect the analyzer with you PC following with the "Figure 1-12".

### 2. Install the USB drive

As the analyzer is a USBTMC device, the "USB Test and Measurement Device" driver should be installed on your PC after you connect the analyzer to the PC and turn both on.

### 3. Search device resource

Start-up Ultra Sigma, and the software then starts searching the analyzer resources that have been connected with PC via USB automatically, or click

**USB-TMC** to search manually. The status bar of Ultra Sigma at present is shown like the figure below:



Figure 4-1 Search USB resources

### 4. View the resource

The resources that have been searched successfully are shown in the "RIGOL Online Resource" catalog as well as the instrument model and USB information. See figure below.



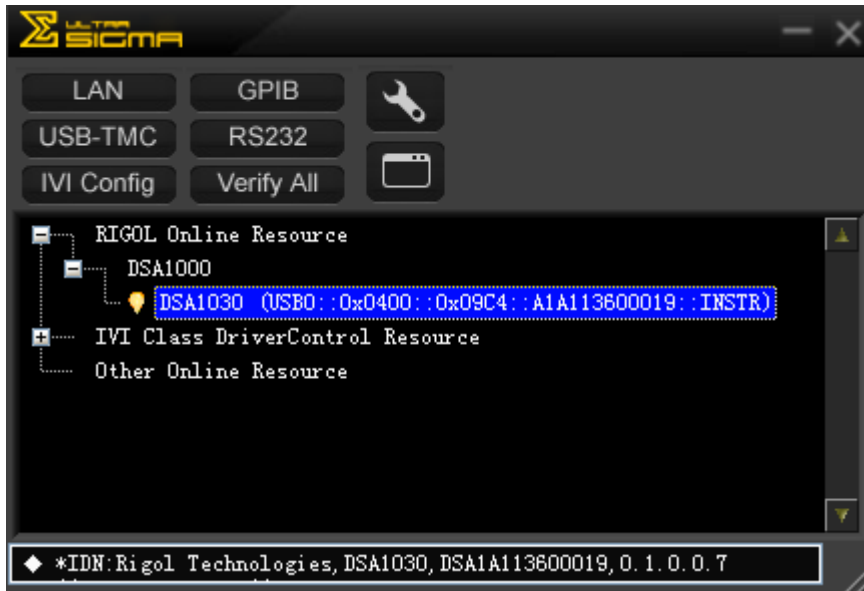

Figure 4-2 View the resource

## 5. Communication test

Right click the resource name such as **DSA1030 (USB0::0x0400::0x09C4::A1A113600019::INSTR)** and select **Instrument Common RIGOL SCPI ControlPanel V1** to open the interface below, from which you can write and read commands.



Figure 4-3 Write and read commands via USB

## 4.2 Remote Control Via LAN

### 1. Connect the devices

Connect the analyzer to LAN as shown in "Figure 1-13 LAN connection".

### 2. Configure LAN parameters

Select LAN interface according to the description in "2.6.1.4 I/O Settings → LAN".

### 3. Search device resource

Start-up Ultra Sigma and click **LAN**, then the software starts searching the analyzer resources that have been connected to LAN automatically. The status bar of Ultra Sigma at present is shown like the figure below:



Figure 4-4 Search LAN resources

### 4. View the resource

The resources that have been searched successfully are shown in the "RIGOL Online Resource" catalog. See figure below.

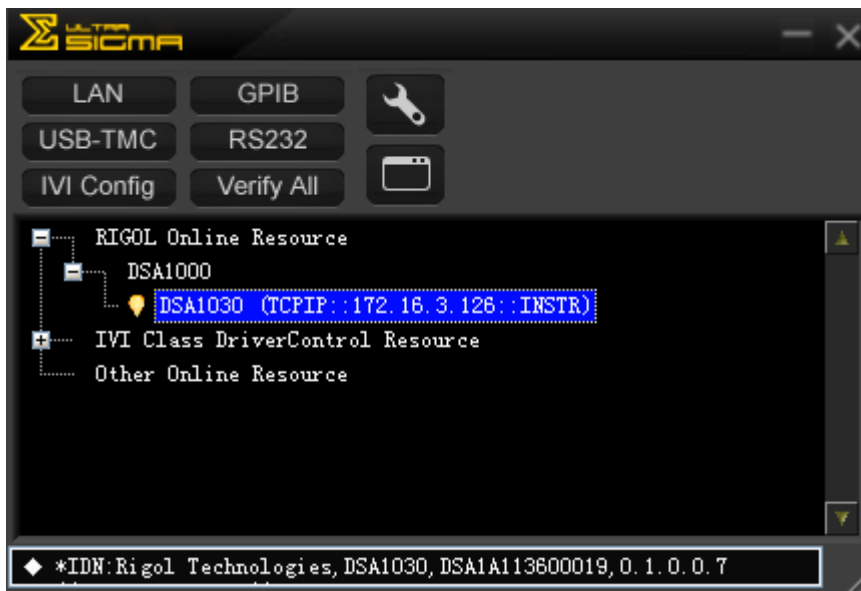

Figure 4-5 View the resource

## 5. Communication test

Right click the resource name such as **DSA1030 (TCPIP::172.16.3.126::INSTR)** and select Instrument Common **RIGOL SCPI ControlPanel V1** to open the interface below, from which you can write and read commands.

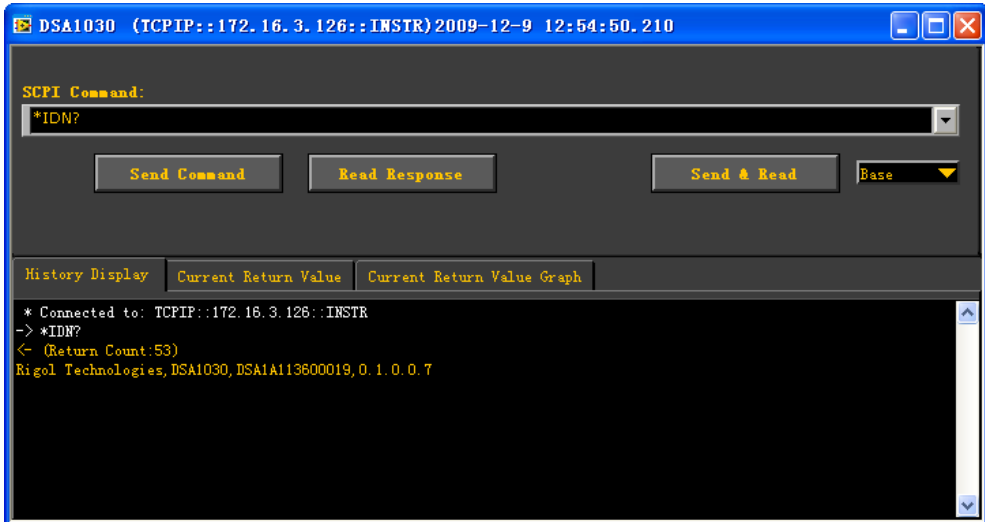

Figure 4-6 Write and read commands via LAN

## 6. Load LXI webpage

The analyzer conforms to LXI-Class standards. You can load LXI webpage conveniently by right-clicking the resource name and selecting "LXI-Web". From the webpage, you can see some important information about the analyzer such as the model, manufacturer, serial number, MAC address, IP address and other description, see figure below.

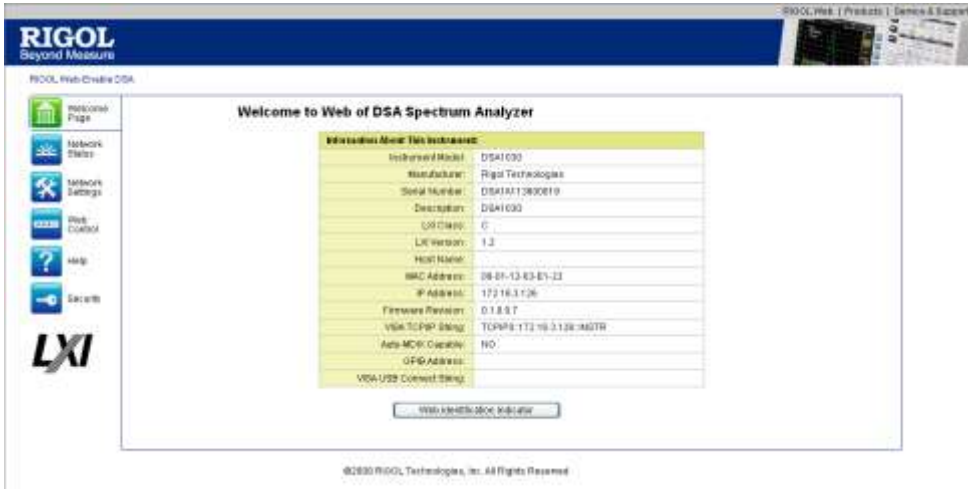

Figure 4-7 LXI webpage

## 4.3 Remote Control Via GPIB

### 1. Connect the devices

Connect the analyzer to the PC (configured with GPIB card) following "Figure 1-4 GPIB extended connection".

### 2. Install the device driver of the GPIB card

Install the driver of the GPIB card which has been connected to the PC.

### 3. Set the GPIB address

Set the GPIB address following with "2.6.1.4 I/O Settings → GPIB".

### 4. Search device resource

Start-up the Ultra Sigma and click  to enter the following interface.

Then, click Search and the software starts searching the analyzer resources that that have been connected to PC via GPIB automatically. When a GPIB resource is found, the name of which will be displayed on the right side of the panel.



Figure 4-8 GPIB Setting

#### If resources cannot be found automatically:

- Select the GPIB card address of the PC and analyzer from the comboBox of "GPIB::" and "INSTR::" separately.
- Click "Test" to see if the GPIB communication works normally, if not, please follow the prompt messages step by step.

## 5. View the resource

Click "OK" and back to the main interface of Ultra Sigma. The resources that have been searched successfully at present are shown in the "RIGOL Online Resource" catalog.

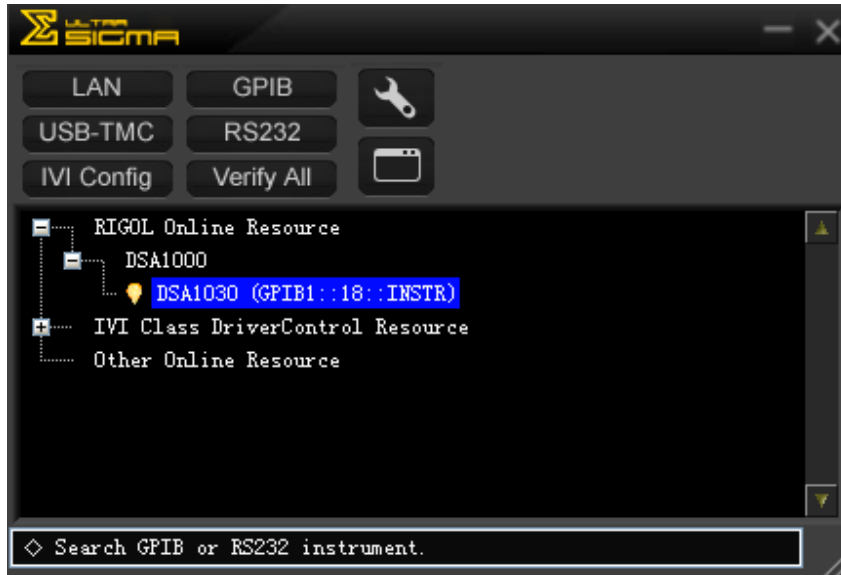

Figure 4-9 View the GPIB resource

## 6. Communication test

Right-click the resource name such as **DSA1030 (GPIB0::18::INSTR)** and select **RIGOL SCPI ControlPanel V1** to open the interface below, from which you can write and read commands.

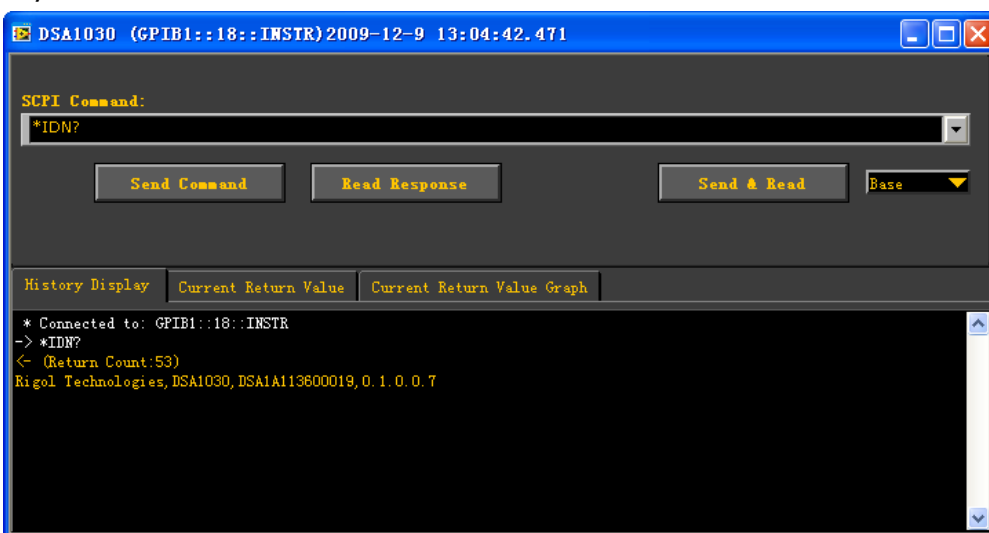



Figure 4-10 Write and read commands via GPIB

# 5 Troubleshooting

## 5.1 Troubleshooting

To help you solve commonly encountered problems we have listed some typical issues with their respective solutions. If the problems persist contact **RIGOL** and prepare your device information (**System** → **Information** → **System Info**).

### 1. The screen still dark (no display) after power on:

- (1) Check if the fan is running:
  - If running, the connection of the internal screen cable may be loose.
  - If not, the instrument has failed to power up, please refer to step (2) or (3).
- (2) If battery power is being used:
  - Make sure that the battery is in good condition and has been installed correctly.
  - Check if the battery indicator  on the front panel is bright, if not, no electrical power is present, please recharge the battery.
- (3) If AC power is being used:
  - Check if the power supply has been connected correctly and power switch has been turned on.
  - Check if the power fuse is burned. If a new fuse needs to be installed, please select one with these specifications: 250V AC, T2A; 5 mm×20 mm.

### 2. Unresponsive keys or wrong response

- (1) Press all the keys on the front panel to make sure that each of them is normal after power on.
- (2) Press **System** → **Self-Test** → **Key Test** to see if all keys are working properly.
- (3) If a key is not working, do not disassemble the instrument by yourself and contact **RIGOL**.

### 3. The spectrum lines on the screen do not update for long periods:

- (1) Check if the screen is locked, if so, press Esc to unlock.
- (2) Check if the instrument is in Remote control.
- (3) Verify if all the trigger conditions have been met and if there is a valid trigger

signal.

- (4) Check if the analyzer is in Single sweep.
- (5) Check if the current sweep time is too long.

#### 4. Wrong measurement results or poor precisions:

To verify the system errors and view the measurement accuracies and precision, refer to the tolerance specifications or characteristics from the *User's Guide*.

To get the characteristics listed in the *User's Guide*, please:

- (1) Check if all the peripheral equipment has been successfully connected and is working normally.
- (2) Review the signal under measure and set appropriate instrument parameters.
- (3) Make measurements under proper conditions, for example: warm-up the instrument appropriately and operate within the specified environment and temperature.
- (4) Calibrate the instrument regularly to reduce or avoid errors that can occur over time.
  - Press **System** → **Information** → **System Info** to get the last calibration time and decide if a new calibration is required. If you need a specific calibration after the stated calibration period, contact **RIGOL** for service options.
  - The analyzer provides a self-calibration function. If required, press **System** → **Calibrate** → **Self-Cal**, and the instrument will do a self-calibration once the operating temperature has changed.
  - Press **System** → **Calibrate** → **Cal Now** to do a self-calibration immediately.



#### 5. Prompt Message:

The instrument may give common prompts, error prompts, or state prompts according to the current status to assist in proper use of the analyzer or to show warnings that some fault might happen to the instrument.



## 5.2 Messages

Messages fall into three types on the basis of the tips purpose: Information Message, Error Message, and Status Message. To get accurate measurements and specific working status of the analyzer, you should be familiar with these messages.

1. Information Message: to give a clue that the current task has finished or the analyzer has entered a specified state. The messages are always marked with an  icon and displayed on the screen for several seconds and then hidden automatically, or you can press any key to clear the display of this message.  
Message number: 1 - 199.
2. Error Message: to warn you that the current operation cannot be executed and has been ignored or paused for some reason. These messages are always marked with an  icon and displayed on the screen for several seconds and then hidden automatically, or you can press any key to clear the display of this error message.

Error Messages based on the cause of the error are divided into Command Error, Execution Error, Device Specific Error, or Query Error. Each of the errors corresponds to a specific bit pattern in the Standard Event Status Register (see IEEE 488.2,11.5.1). When you find there is an error generated in the Standard Event Status Register, send command `SYSTEM:ERRor?` in Remote Mode to get the information on this error and find the cause of it.

- (1) Command Error: indicates a command error is detected by the Parser while in Remote control (see IEEE488.2,6.1.6), possible reasons are:
  - The Parser detects a syntax error; (see IEEE488.2,7.1.2.2)
  - An unrecognized header or a parameter that is of the wrong type for its associated header is received. (see IEEE488.2,10)Message number: -199 to -100.
- (2) Execution Error: indicates an execution error is detected by the Execution Control Block, possible reasons are:
  - A parameter following a header was evaluated by the device as outside of its legal input range or is otherwise inconsistent with the device's capabilities.
  - A valid program message could not be properly executed due to some

device condition.

Message number: -299 to -200.

- (3) Device Specific Error: indicates a device specific error is generated when the commands cannot be correctly executed due to current settings of the hardware and software of the device.

Message number: -399 to -300 (defined in SCPI standard) and 300 to 1000.

- (4) Query Error: indicates a query error is generated when the output queue controller (see IEEE488.2,6.5.7) fails to follow the Message Exchange Control Protocol under any of the conditions below: ( see IEEE488.2,6.1.10)

- When trying to read the output queue, the queue has no data or is being suspended.
- Data in the output queue has been lost.

Message number: -499 to -400.

- 3. Status Message:** to warn you that the analyzer is now in a certain condition and should be paid attention to. The messages are always marked with an 🚨 icon and displayed on the screen until the **ESC** key has been pressed or the **\*CLS** command is used. The messages are stored in corresponding status register, and can be queried by sending **Status:** or **SYSTEM:ERROR[:NEXT]?**.

Message number: 200 to 299.

## 5.2.1 Information Message

<b>Number</b>	<b>Error Description</b>
<b>1</b>	<b>PictBridge printer connected.</b> PictBridge printer has already been connected successfully and is waiting for initialization.
<b>2</b>	<b>PictBridge printer installed successfully.</b> PictBridge printer has already been installed successfully and is ready for printing.
<b>3</b>	<b>PictBridge printer disconnected.</b>
<b>4</b>	<b>Printing task finished.</b>
<b>5</b>	<b>Printing task paused.</b> Printing task has to be paused as an error, please solve the problem and select RESUME. For the source of error please refer to the Message List.
<b>6</b>	<b>Printing task stopped.</b> An error occurred when printing, please select "Cancel" to stop the print job.
<b>7</b>	<b>Printing task canceled.</b>
<b>8</b>	<b>Printing task resumed.</b>
<b>10</b>	<b>U Disk connected.</b> U Disk has already been connected and is waiting for initialization.
<b>11</b>	<b>U Disk installed successfully.</b>
<b>12</b>	<b>U Disk removed.</b>
<b>13</b>	<b>Start updating firmware.</b> Updating firmware, please wait and keep the connection between the USB flash device and the analyzer. For more information about updates, please refer to the Service Manual or report the error to your distributor or to your RIGOL technical support.
<b>14</b>	<b>Updating firmware completed.</b> Updating firmware is finished, the new firmware program will be executed automatically as soon as you restart the device.
<b>15</b>	<b>Saving file completed.</b>
<b>16</b>	<b>To Recover file existed.</b>
<b>17</b>	<b>Load data with old revision.</b> Loading data from the old edition to the current, which may cause a failure to work.

- 18        The last spell char is allowed to input.**
- 19        Please select the valid file type.**
- 30        LAN connected.**
- 31        LAN disconnected.**
- 41        Welcome to User Mode.**
- 50        Please Confirm, and press twice.**
- 51        The display was locked, please press Esc to unlock.**
- 52        Display unlocked.**
- 54        Please select the valid file.**
- 55        It is not allowed to delete folder.**
- 56        Fail to load file.**
- 57        Local Disk is being Formatted, please wait for a moment.**
- 58        Formatting is finished.**
- 60        Software version is not matched, file loading is failed.**
- 61        Invalid source.**
- 62        Select where to load, antenna, cable, user or others.**
- 63        Option is activated.**
- 64        Option is deleted.**
- 65        The edit frequency has been existed.**
- 80        Limit lines are cleaned because of change of X Axis type.**

## 5.2.2 Error Message

### 5.2.2.1 Command Error

<b>Number</b>	<b>Error Description</b>
<b>0</b>	<b>Everything is OK.</b>
<b>-100</b>	<b>Command error.</b> This is a generic syntax error for devices that cannot detect more specific errors. This code indicates only that a Command Error as defined in IEEE 488.2,11.5.1.1.4 has occurred.
<b>-101</b>	<b>Invalid character.</b> A syntactic element contains a character which is invalid for that type; for example, a header containing an ampersand, SETUP&. This error might be used in place of errors -114, -121, -141, and perhaps some others.
<b>-102</b>	<b>Syntax error.</b> An unrecognized command or data type was encountered; for example, a string was received when the device does not accept strings.
<b>-103</b>	<b>Invalid separator.</b> The parser was expecting a separator and encountered an illegal character; for example, the semicolon was omitted after a program message unit, *EMC 1:CH1:VOLTS 5.
<b>-104</b>	<b>Data type error.</b> The parser recognized a data element different than one allowed; for example, numeric or string data was expected but block data was encountered.
<b>-105</b>	<b>GET not allowed.</b> A Group Execute Trigger was received within a program message (see IEEE 488.2, 7.7).
<b>-108</b>	<b>Parameter not allowed.</b> More parameters were received than expected for the header; for example, the *EMC common command only accepts one parameter, so receiving *EMC 0, 1 is not allowed.
<b>-109</b>	<b>Missing parameter.</b> Fewer parameters were received than required for the header; for example, the *EMC common command requires one parameter, so receiving *EMC is not allowed.

- 110 Command header error.**  
An error was detected in the header. This error message should be used when the device cannot detect the more specific errors described for errors -111 through -119.
- 111 Header separator error.**  
A character which is not a legal header separator was encountered while parsing the header; for example, no white space followed the header, thus \*GMC"MACRO" is an error.
- 112 Program mnemonic too long.**  
The header contains more than twelve characters (see IEEE 488.2, 7.6.1.4.1).
- 113 Undefined header.**  
The header is syntactically correct, but it is undefined for this specific device; for example, \*XYZ is not defined for any device.
- 114 Header suffix out of range.**  
The value of a numeric suffix attached to a program mnemonic, see Syntax and Style section 6.2.5.2, making the header invalid.
- 115 Unexpected number of parameters.**  
The number of parameters received does not correspond to the number of parameters expected. This is typically due to an inconsistency with the number of instruments in the selected group (see section on INSTRUMENT:DEFINE:GROUP).
- 120 Numeric data error.**  
This error, as well as errors -121 through -129, are generated when parsing a data element which appears to be numeric, including the non-decimal numeric types. This particular error message should be used if the device cannot detect a more specific error.
- 121 Invalid character in number.**  
An invalid character for the data type being parsed was encountered; for example, an alpha in a decimal numeric or a "9" in octal data.
- 123 Exponent too large.**  
The magnitude of the exponent was larger than 32000 (see IEEE 488.2, 7.7.2.4.1).
- 124 Too many digits.**  
The mantissa of a decimal numeric data element contained more than 255 digits excluding leading zeros (see IEEE 488.2, 7.7.2.4.1).
- 128 Numeric data not allowed.**  
A legal numeric data element was received, but the device does not

accept one in this position for the header.

**-130**

**Suffix error.**

This error, as well as errors -131 through -139, are generated when parsing a suffix. This particular error message should be used if the device cannot detect a more specific error.

**-131**

**Invalid suffix.**

The suffix does not follow the syntax described in IEEE 488.2, 7.7.3.2, or the suffix is inappropriate for this device.

**-134**

**Suffix too long.**

The suffix contained more than 12 characters (see IEEE 488.2, 7.7.3.4).

**-138**

**Suffix not allowed.**

A suffix was encountered after a numeric element which does not allow suffixes.

**-140**

**Character data error.**

This error, as well as errors -141 through -149, are generated when parsing a character data element. This particular error message should be used if the device cannot detect a more specific error.

**-141**

**Invalid character data.**

Either the character data element contains an invalid character or the particular element received is not valid for the header.

**-144**

**Character data too long.**

The character data element contains more than twelve characters (see IEEE 488.2, 7.7.1.4).

**-148**

**Character data not allowed.**

A legal character data element was encountered where prohibited by the device.

**-150**

**String data error.**

This error, as well as errors -151 through -159, are generated when parsing a string data element. This particular error message should be used if the device cannot detect a more specific error.

**-151**

**Invalid string data.**

A string data element was expected, but was invalid for some reason (see IEEE 488.2, 7.7.5.2); for example, an END message was received before the terminal quote character.

**-158**

**String data not allowed.**

A string data element was encountered but was not allowed by the device at this point in parsing.

**-160**

**Block data error.**

This error, as well as errors -161 through -169, are generated when parsing a block data element. This particular error message should be used if the device cannot detect a more specific error.

**-161 Invalid block data.**

A block data element was expected, but was invalid for some reason (see IEEE 488.2, 7.7.6.2); for example, an END message was received before the length was satisfied.

**-168 Block data not allowed.**

A legal block data element was encountered but was not allowed by the device at this point in parsing.

**-170 Expression error.**

This error, as well as errors -171 through -179, are generated when parsing an expression data element. This particular error message should be used if the device cannot detect a more specific error.

**-171 Invalid expression.**

The expression data element was invalid (see IEEE 488.2, 7.7.7.2); for example, unmatched parentheses or an illegal character.

**-178 Expression data not allowed.**

A legal expression data was encountered but was not allowed by the device at this point in parsing.

**-180 Macro error.**

This error, as well as errors -181 through -189, are generated when defining a macro or executing a macro. This particular error message should be used if the device cannot detect a more specific error.

**-181 Invalid outside macro definition.**

Indicates that a macro parameter placeholder ( $\$<number>$ ) was encountered outside of a macro definition.

**-183 Invalid inside macro definition.**

Indicates that the program message unit sequence, sent with a \*DDT or \*DMC command, is syntactically invalid (see IEEE 488.2, 10.7.6.3).

**-184 Macro parameter error.**

Indicates that a command inside the macro definition had the wrong number or type of parameters.



### 5.2.2.2 Execution Error

<b>Number</b>	<b>Error Description</b>
---------------	--------------------------

<b>-200</b>	<b>Execution error.</b>
-------------	-------------------------

This is the generic syntax error for devices that cannot detect more specific errors. This code indicates only that an Execution Error as defined in IEEE 488.2, 11.5.1.1.5 has occurred.

<b>-201</b>	<b>Invalid while in local.</b>
-------------	--------------------------------

Indicates that a command is not executable while the device is in local due to a hard local control (see IEEE 488.2, 5.6.1.5);The system would be changed to remote mode by selecting the right communication I/O.

<b>-203</b>	<b>Command protected.</b>
-------------	---------------------------

Indicates that a legal password-protected program command or query could not be executed because the command was disabled.

<b>-220</b>	<b>Parameter error.</b>
-------------	-------------------------

Indicates that a program data element related error occurred. This error message should be used when the device cannot detect the more specific errors described for errors -221 through -229.

<b>-221</b>	<b>Settings conflict.</b>
-------------	---------------------------

Indicates that a legal program data element was parsed but could not be executed due to the current device state (see IEEE 488.2, 6.4.5.3 and 11.5.1.1.5.)

<b>-222</b>	<b>Data out of range.</b>
-------------	---------------------------

Indicates that a legal program data element was parsed but could not be executed because the interpreted value was outside the legal range as defined by the device (see IEEE 488.2, 11.5.1.1.5.)

<b>-223</b>	<b>Too much data.</b>
-------------	-----------------------

Indicates that a legal program data element of block, expression, or string type was received that contained more data than the device could handle due to memory or related device-specific requirements.

<b>-224</b>	<b>Illegal parameter value.</b>
-------------	---------------------------------

Used where exact value, from a list of possible, was expected.

<b>-225</b>	<b>Out of memory.</b>
-------------	-----------------------

The device has insufficient memory to perform the requested operation.

<b>-233</b>	<b>Invalid version.</b>
-------------	-------------------------

Indicates that a legal program data element was parsed but could not be executed because the version of the data is incorrect for the device.

This particular error should be used when file or block data formats are recognized by the instrument but cannot be executed for reasons of version incompatibility. For example, an unsupported file version, an unsupported instrument version.

- 240 Hardware error.**  
Indicates that a legal program command or query could not be executed because of a hardware problem in the device. This error message should be used when the device cannot detect the more specific errors described for errors -241.
- 241 Hardware missing.**  
Indicates that a legal program command or query could not be executed because the option was not installed.
- 250 Mass storage error.**  
Indicates that a mass storage error occurred. This error message should be used when the device cannot detect the more specific errors described for errors - 251 through -258.
- 251 Missing mass storage.**  
Indicates that a legal program command or query could not be executed because an option mass storage with enough density was not installed.
- 252 Missing media.**  
Indicates that a legal program command or query could not be executed because of no disk.
- 253 Corrupt media.**  
Indicates that a legal program command or query could not be executed because of a bad disk or wrong disk formatting.
- 254 Media full.**  
Indicates that a legal program command or query could not be executed because there is no room on the disk.
- 256 File name not found.**  
Indicates that a legal program command or query could not be executed because an attempt was made to read or copy a nonexistent file.
- 257 File name error.**  
Indicates that a legal program command or query could not be executed because an attempt was made to copy to a duplicate file name.
- 258 Media protected.**

Indicates that a legal program command or query could not be executed because the write-protect tab on USB disk was present.

### 5.2.2.3 Device Specific Error

Number	Error Description
--------	-------------------

<b>-300</b>	<b>Device-specific error.</b>
-------------	-------------------------------

This is the generic device-dependent error for devices that cannot detect more specific errors. This code indicates only that a Device-Dependent Error as defined in IEEE 488.2, 11.5.1.1.6 has occurred. Please report the error to your RIGOL sales or technical support team.

<b>-310</b>	<b>System error.</b>
-------------	----------------------

Indicates that some error, termed "system error" by the device, has occurred. Please report the error to your RIGOL sales or technical support team.

<b>-311</b>	<b>Memory error.</b>
-------------	----------------------

Indicates that local C disc is not formatted or an error occurred when self-checking. If restarting the device is still of no effect, please report the error to your RIGOL sales or technical support team.

<b>-313</b>	<b>Calibration memory lost.</b>
-------------	---------------------------------

Indicates that the data before delivery or last valid calibration data has been lost. Please report the error to your RIGOL sales or technical support team.

<b>-314</b>	<b>Save/recall memory lost.</b>
-------------	---------------------------------

Indicates that the nonvolatile data saved by the \*SAV? command has been lost.

<b>-315</b>	<b>Configuration memory lost.</b>
-------------	-----------------------------------

Indicates that nonvolatile configuration data saved by the device has been lost.

<b>-321</b>	<b>Out of memory.</b>
-------------	-----------------------

An internal operation needed more memory than was available. Please report the error to your RIGOL sales or technical support team.

<b>-330</b>	<b>Self-test failed.</b>
-------------	--------------------------

Failure to self-test, for more information please refer to the result of the Self-test.

<b>-340</b>	<b>Calibration failed.</b>
-------------	----------------------------

Failure to calibrate. Please report the error to your RIGOL sales or technical support team.

<b>-350</b>	<b>Queue overflow.</b>
-------------	------------------------

A specific code entered into the queue in lieu of the code that caused

the error. This code indicates that there is no room in the queue and an error occurred but was not recorded.

**-360      Communication error.**

**-365      Time out error.**

Time out when communicating with USB-GPIB Switching Module, please restart the module.

**300      Print paper error.**

Failure to print. Please check whether the printer paper is available and in the correct position.

**301      Print ink error.**

Indicates that an error occurred when printing. Please check the quantity of ink or confirm whether the ink is installed correctly.

**302      Print hardware error.**

Indicates that a hardware error has occurred. Please check it.

**303      Print file type error.**

Failure to print owing to wrong print file type.

**304      Unknown print error.**

**310      Updating error with wrong image file.**

An error occurred when updating firmware owing to a wrong format of the image file or the file has already been damaged.

**311      Updating error with wrong revision.**

An error occurred when updating firmware because of a revision incompatibility.

**312      Updating error with failing to write flash.**

An error occurred when updating firmware owing to a failure to write to the flash.

**320      Invalid file path.**

The file path received may not exist or an illegal path format was received.

**321      Invalid input string.**

An illegal string has been received.

**322      File name too long.**

The file name is too long to be accepted. The length should not exceed 255 characters.

**323      U-Disk failed to install.**

The USB flash device can not be correctly installed, please examine it for possible damage. Any question, please contact your distributor or RIGOL technical support.

- 324 File name existed.**  
The file name received already exists, please re-input.
- 325 Input empty.**  
The input is empty, please input a legal string before saving.
- 326 Fail to save file.**
- 327 Other language except English not supported.**  
Any other languages are disabled except for English.
- 328 File operation failed.**
- 329 No space to save file.**  
The document or file can not be created or saved owing to no space available.
- 330 Invalid option No.**  
The length of option No. must be less than 4 characters.
- 331 Invalid option serial number.**  
The length of option serial number must be less than 20 characters.
- 340 DHCP renew failed.**  
Failed to configure IP address with DHCP server. Please try manual IP.
- 341 IP conflict.**  
The IP address received is in conflict with another computer on the network. Please try another IP address.
- 342 Invalid IP.**  
The IP address received is invalid.
- 350 Can't auto-couple sweep time in zero span.**  
Sweep time can not be coupled automatically in zero span except for manually.
- 351 Zero span unavailable at power measurement mode.**
- 354 Pre-amplifier disable.**  
Please adjust the settings of reference level and attenuator as well as maximum mixing level.
- 355 Scale/div invalid in linear scale mode.**
- 356 Invalid function in zero span.**  
In zero span, the following operations cannot be executed: Signal Track On, Channel Forward, Channel Reverse, Span Zoom In, Span Zoom Out, Peak->CF, Mkr->CF, Mkr->Step, Mkr->Start, Mkr->Stop, Mkr Delta->CF, Mkr Delta->Span, setting the Mark readout as FREQ or PERIOD.
- 357 Invalid function in non-zero span.**  
Neither Video trigger nor the marker readout in  $1/\Delta$ Time is effective in

non-zero span.

**358 Invalid mark readout.**

When the marker is in Delta Pair mode, the marker readout in  $1/\Delta$  Time is of no effect; and when the marker is in normal mode,  $Mkr\Delta \rightarrow CF$  and  $Mkr\Delta \rightarrow Span$  are of no effect.

**359 Invalid function when trace is not enabled.**

To point a marker to a trace is not available when the correct trace function is not enabled.

**360 User preset failed.**

The User preset has failed because the edition of the saved status data is incorrect or has been damaged. In this situation, the system will execute Factory settings as the defaults.

**400 Input signal power out of range.**

Indicate that the input signal power is out of range, if this state continues for a long time, some damage may occur to the device. Please reduce the input power.

**401 1st LO unlock.**

The first LO unlock. Please report the error to your RIGOL sales or technical support.

**402 2nd LO unlock.**

The second LO unlock. Please report the error to your RIGOL sales or technical support.

**403 Track LO unlock.**

Track LO unlock. Please report the error to your RIGOL sales or technical support.

**410 Probe power short-circuit.**

Please check the Probe power short-circuit as well as its connection state.

**420 Option not installed.**

The desired operation cannot be performed because a required option is not installed. For example, pressing Source with no tracking generator installed.

**460 No peak found.**

No signal peak was found that meets the criteria under Peak Search.

**461 No fundamental wave found.**

Indicates that no fundamental wave greater than 50dBm is found.

**462 No two-tune signal found.**

**463 Invalid function as cursor is not enabled.**

The cursor can not be set to the reference level unless it is enabled.

#### 5.2.2.4 Query Error

<b>Number</b>	<b>Error Description</b>
---------------	--------------------------

<b>-400</b>	<b>Query error.</b>
-------------	---------------------

This is the generic query error for devices that cannot detect more specific errors. This code indicates only that a Query Error as defined in IEEE 488.2, 11.5.1.1.7 and 6.3 has occurred.

<b>-410</b>	<b>Query INTERRUPTED.</b>
-------------	---------------------------

Indicates that a condition causing an INTERRUPTED Query error occurred (see IEEE 488.2, 6.3.2.3); for example, a query followed by DAB or GET before a response was completely sent.

<b>-420</b>	<b>Query UNTERMINATED.</b>
-------------	----------------------------

Indicates that a condition causing an UNTERMINATED Query error occurred (see IEEE 488.2, 6.3.2.2); for example, the device was addressed to talk and an incomplete program message was received.

<b>-430</b>	<b>Query DEADLOCKED.</b>
-------------	--------------------------

Indicates that a condition causing a DEADLOCKED Query error occurred (see IEEE 488.2, 6.3.1.7); for example, both input buffer and output buffer are full and the device cannot continue.

<b>-440</b>	<b>Query UNTERMINATED after indefinite response.</b>
-------------	--

Indicates that a query was received in the same program message after a query requesting an indefinite response was executed (see IEEE 488.2, 6.5.7.5).



### 5.2.3 Status Message

<b>Number</b>	<b>Error Description</b>
---------------	--------------------------

<b>202</b>	<b>Auto range...</b>
------------	----------------------

<b>203</b>	<b>Auto tune...</b>
------------	---------------------

<b>204</b>	<b>Calibrating...</b>
------------	-----------------------

<b>205</b>	<b>Waiting for triggered...</b>
------------	---------------------------------

If it is not in freerun mode, the system will keep waiting until it receives the trigger signal.

<b>252</b>	<b>Auto range finished.</b>
------------	-----------------------------

<b>253</b>	<b>Auto tune finished.</b>
------------	----------------------------

<b>254</b>	<b>Self-calibration finished.</b>
------------	-----------------------------------

<b>255</b>	<b>Triggered.</b>
------------	-------------------



## 6 Specification

This chapter lists the specifications and general specifications of the analyzer. All the specifications are guaranteed when the following conditions are met unless otherwise noted.

- The instrument must have been warmed-up for 30 minutes.
- The instrument is in the calibration period and a self calibration has been performed.

## 6.1 Specification

### 6.1.1 Frequency

Frequency		
Frequency Range	DSA1020	9 kHz to 2 GHz
	DSA1030	9 kHz to 3 GHz
Frequency Resolution		1 Hz

Internal Frequency Reference		
Reference Frequency		10 MHz
Aging Rate		<3 ppm/year
Temperature Drift	20 °C to 30 °C	<3 ppm

Frequency Readout Accuracy		
Marker Resolution		span / (sweep points-1)
Marker Uncertainty		± (frequency indication × frequency reference uncertainty + 1% × span + 10% × resolution bandwidth + marker resolution)

Marker Frequency Counter		
Resolution		1 Hz, 10 Hz, 100 Hz, 1 kHz
Uncertainty		±(frequency indication × frequency reference uncertainty + counter resolution)

Note: Frequency Reference Uncertainty= (aging rate × period since adjustment + temperature drift).

Frequency Span		
Range	DSA1020	0 Hz, 100 Hz to 2 GHz
	DSA1030	0 Hz, 100 Hz to 3 GHz
Uncertainty		±span / (sweep points-1)

<b>SSB Phase Noise</b>		
Carrier Offset	10 kHz	<-80 dBc/Hz

<b>Bandwidths</b>		
Resolution Bandwidth (-3 dB)		100 Hz to 1 MHz, in 1-3-10 sequence
RBW Uncertainty		< 5%, nominal
Resolution Filter Shape Factor (60 dB: 3 dB)		<5, nominal
Video Bandwidth (-3 dB)		1 Hz to 3 MHz, in 1-3-10 sequence

## 6.1.2 Amplitude

<b>Measurement Range</b>		
Range		DANL to +30 dBm

<b>Maximum rated input level</b>		
DC Voltage		50 V
CW RF Power	RF attenuation $\geq$ 20dB	30 dBm (1 W)
Max. Damage Level		40 dBm (10 W)

Note: When input level >33 dBm, the protection switch will be on.

<b>1dB Gain Compression</b>		
Total Power at Input Mixer	$f_c \geq$ 50 MHz, preamplifier off	>0 dBm

Note: Mixer power level (dBm) = input power (dBm) – input attenuation (dB).

<b>Displayed Average Noise Level (DSA1020)</b>		
0 dB RF Attenuation, RBW=100 Hz, VBW=10 Hz, Sample Detector, Trace Average $\geq$ 50		
DANL	100 kHz to 10 MHz	<-75 dBm-3 x (f/1 MHz) dB, typ. -115 dBm
	10 MHz to 2 GHz	<-117 dBm+3 x (f/1 GHz) dB, typ. -120 dBm

<b>Displayed Average Noise Level (DSA1030)</b>		
0 dB RF Attenuation, RBW=100 Hz, VBW=10 Hz, Sample Detector, Trace Average $\geq$ 50		
DANL (Preamplifier Off)	100 kHz to 10 MHz	<-75 dBm-3 x (f/1 MHz) dB, typ. -115 dBm
	10 MHz to 2.5 GHz	<-117 dBm+3 x (f/1 GHz) dB. typ. -120 dBm
	2.5 GHz to 3 GHz	<-105 dBm
DANL (Preamplifier On)	100 kHz to 1 MHz	<-93 dBm
	1 MHz to 10 MHz	<-93 dBm-3 x (f/1 MHz) dB, typ. -133 dBm
	10 MHz to 2.5 GHz	<-135 dBm+3 x (f/1 GHz) dB, typ. -138 dBm
	2.5 GHz to 3 GHz	<-123 dBm

<b>Level Display Range</b>		
Log Scale		1 dB to 200 dB
Linear Scale		0 to Reference Level
Number of Display Points	Normal	601
	Full Screen	751
Number of Traces		3 + Math Trace
Trace Detectors		Normal, Positive-peak, Negative-peak, Sample, RMS, Voltage Average
Trace Functions		Clear Write, Max Hold, Min Hold, Average, View, Blank
Scale Units		dBm, dBmV, dB $\mu$ V, nV, $\mu$ V, mV, V, nW, $\mu$ W, mW, W

<b>Frequency Response (DSA1020)</b>		
10 dB RF Attenuation, Relative to 50 MHz, 20 °C to 30 °C		
Frequency Response	100 kHz to 2 GHz	<1.0 dB

<b>Frequency Response (DSA1030)</b>		
10 dB RF Attenuation, Relative to 50 MHz, 20 °C to 30 °C		

Frequency Response (Preamplifier Off)	100 kHz to 3 GHz	<1.0 dB
Frequency Response (Preamplifier On)	1 MHz to 3 GHz	<1.4 dB

#### Input Attenuation Switching Uncertainty

Setting Range		0 to 50 dB, in 1 dB step
Switching Uncertainty	fc=50 MHz, relative to 10 dB, 20 °C to 30 °C	< 0.8 dB

#### Absolute Amplitude Uncertainty

Uncertainty	fc=50 MHz, peak detector, preamplifier off, 10 dB RF attenuation, input signal=-10 dBm, 20 °C to 30 °C	±0.4 dB
-------------	--	---------

#### RBW Switching Uncertainty

Uncertainty	100 Hz to 1 MHz, relative to 1 kHz RBW	<0.1 dB
-------------	--	---------

#### Reference Level

Range		-100 dBm to +30 dBm, in 1 dB step
Resolution	Log Scale	0.01 dB
	Linear Scale	4 digits

#### Level Measurement Uncertainty

Overall Amplitude Measurement Uncertainty	95% confidence level, S/N>20 dB, RBW=VBW=1kHz, preamplifier off, 10 dB RF attenuation, -50 dBm<Reference level<0, 10 MHz<fc<2GHz (DSA1020) , 10 MHz<fc<3GHz	<1.5 dB, nominal
---	---	------------------

	(DSA1030), 20 °C to 30 °C	
--	------------------------------	--

**RF Input VSWR (DSA1020)**

10 dB RF Attenuation		
VSWR	100 kHz to 10 MHz	<1.8
	10 MHz to 2 GHz	<1.5

**RF Input VSWR (DSA1030)**

10 dB RF Attenuation		
VSWR	100 kHz to 10 MHz	<1.8
	10 MHz to 2.5 GHz	<1.5
	2.5 GHz to 3 GHz	<1.8

**Intermodulation**

Second Harmonic Intercept (SHI)		+35 dBm
Third-order Intermodulation (TOI)	fc >30 MHz	+7 dBm

**Spurious Responses**

Image Frequency		<-60 dBc
Intermediate Frequency		<-60 dBc
Spurious Response, Inherent		<-85 dBm, typ.
Spurious Response, Others	Referenced to local oscillators, referenced to A/D conversion, referenced to subharmonic of first LO, referenced to harmonic of first LO	<-60 dBc
Input Related Spurious	Mixer level: -30 dBm	<-60 dBc, typ.



### 6.1.3 Sweep

<b>Sweep (DSA1020)</b>		
Sweep Time Range	100 Hz ≤ Span ≤ 2 GHz	10 ms to 2000 s
	Span=0 Hz	20 μs to 2000 s
Sweep Time Uncertainty	100 Hz ≤ Span ≤ 2 GHz	5%, nominal
	Span=0 Hz	0.5%, nominal
Sweep Mode		Continuous, Single

<b>Sweep (DSA1030)</b>		
Sweep Time Range	100 Hz ≤ Span ≤ 3 GHz	10 ms to 3000 s
	Span=0 Hz	20 μs to 3000 s
Sweep Time Uncertainty	100 Hz ≤ Span ≤ 3 GHz	5%, nominal
	Span=0 Hz	0.5%, nominal
Sweep Mode		Continuous, Single

### 6.1.4 Trigger

<b>Trigger</b>		
Trigger Source		Free run, Video, External
External Trigger Level		5 V TTL level

### 6.1.5 Tracking Generator (DSA1030 Option)

<b>TG Output</b>		
Frequency Range		9 kHz to 3 GHz
Output Level		-20 dBm to 0 dBm, in 1 dB steps
Output Flatness	10 MHz to 3 GHz, referenced to 50 MHz	±3 dB

## 6.1.6 Input/Output

RF Input		
Impedance		50 $\Omega$
Connector		N-type, female

TG Out		
Impedance		50 $\Omega$
Connector		N-type, female

Probe Power		
Voltage/Current		+15 V, <10% at 150 mA -12.6 V <sub>t</sub> , <10% at 150 mA

10 MHz REF In / 10 MHz REF Out / External Trigger In		
Connector		BNC female
10 MHz REF Amplitude		0 dBm to 10 dBm
Trigger Voltage		5 V TTL level

USB		
	USB Host	
Connector		B plug
Protocol		Version 2.0
	USB Device	
Connector		A plug
Protocol		Version 2.0

VGA		
Connector		VGA compatible, 15-pin mini D-SUB
Resolution		800 * 600 @ 60 Hz

## 6.2 General Specification

<b>Display</b>		
Type		TFT LCD
Resolution		800 * 480
Size		8.5"
Colors		65536

<b>Printer Supported</b>		
Protocol		PictBridge

<b>Remote Control</b>		
USB		USB TMC
LAN Interface		10/100 Base-T, RJ-45
IEC/IEEE Bus(GPIB)	with option USB-GPIB	IEEE 488.2

<b>Mass Memory</b>		
Mass Memory		Flash Disk (internal) USB Disk (not supplied)
Data Storage Space	Flash Disk (internal)	1G Bytes

<b>Power Supply</b>		
Input Voltage Range, AC		100 V to 240 V, nominal
AC Supply Frequency		45 Hz to 440 Hz
Input Voltage Range, DC		10 V to 18 V, nominal
Power Consumption		Typ. 35 W, Max 60 W with all options.
Operation Time at DC Power Supply		About 3 hours

<b>Temperature</b>		
Operating Temperature Range		5 °C to 40 °C
Storage Temperature Range		-20 °C to 70 °C

<b>Dimensions</b>		
	(W x H x D)	399 mm x 223 mm x 159 mm (15.7 inches x 8.78 inches x 6.26 inches)

<b>Weight</b>		
	Without battery pack	6.2 kg (13.7 lbs)
	With battery pack	7.4 kg (16.3 lbs)

## 7 Menu Map

This chapter provides a visual representation of the front panel keys and associated menu keys. Refer to "Front Panel Key Reference" for key function descriptions.

Subjects in this chapter:

- AMPT
- BW
- Demod (For DSA1030)
- Detector
- Display
- FREQ
- Marker
- Marker Fctn
- Marker->
- Meas (For DSA1030)
- Meas Setup (For DSA1030)
- Peak
- Print Setup
- SPAN
- Storage
- Sweep
- System
- Source
- Trace
- Trig

# 7.1 AMPT

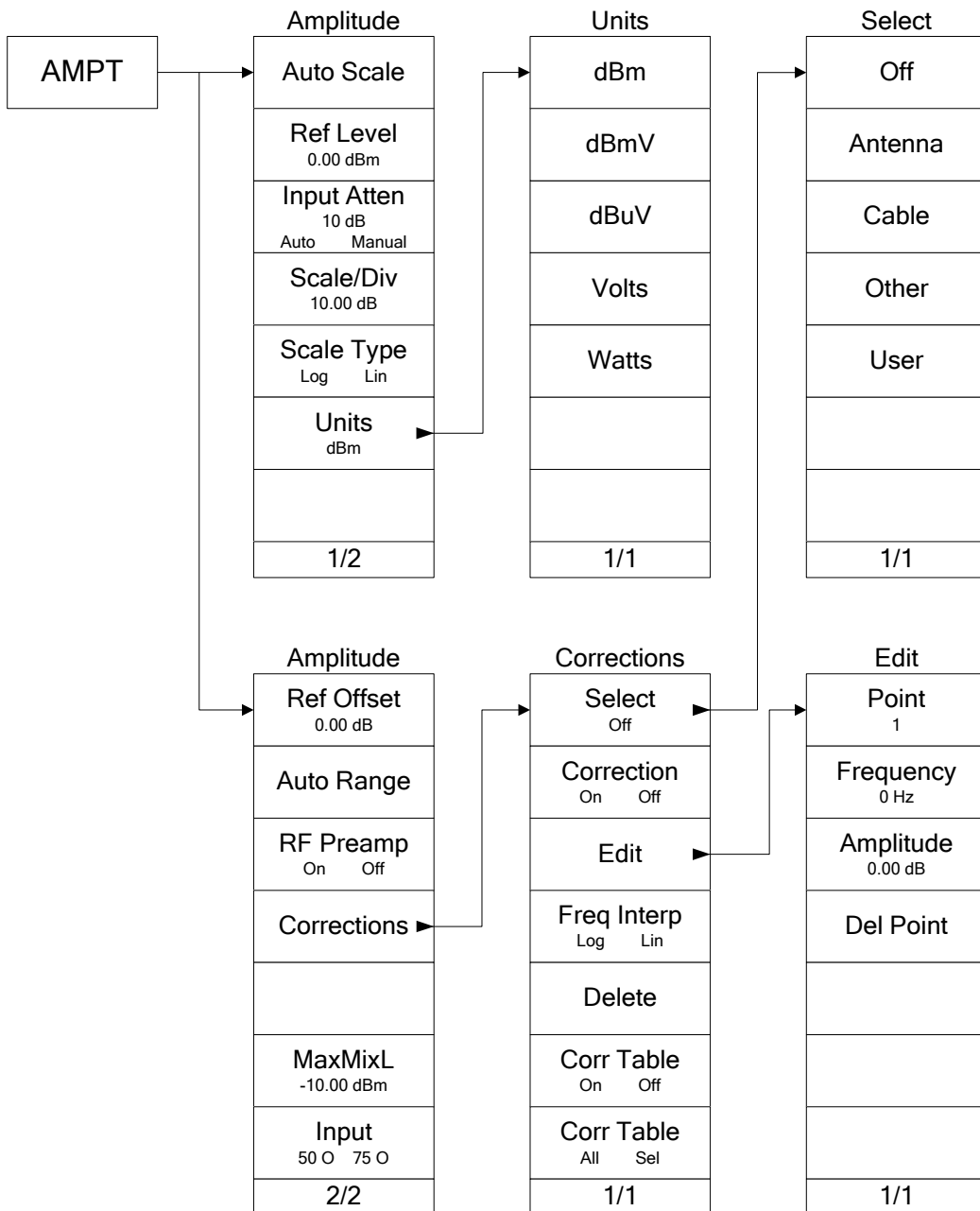

Note: The "RF Preamp" menu is available for DSA1030 only.

## 7.2 BW

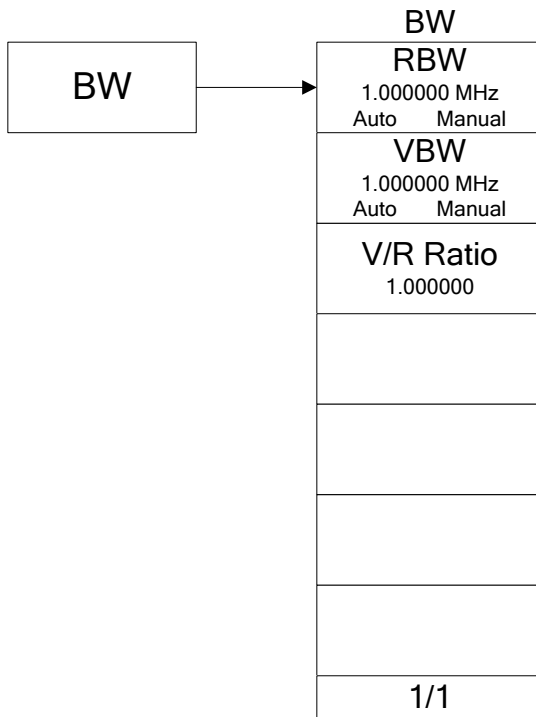

### 7.3 Demod (For DSA1030)

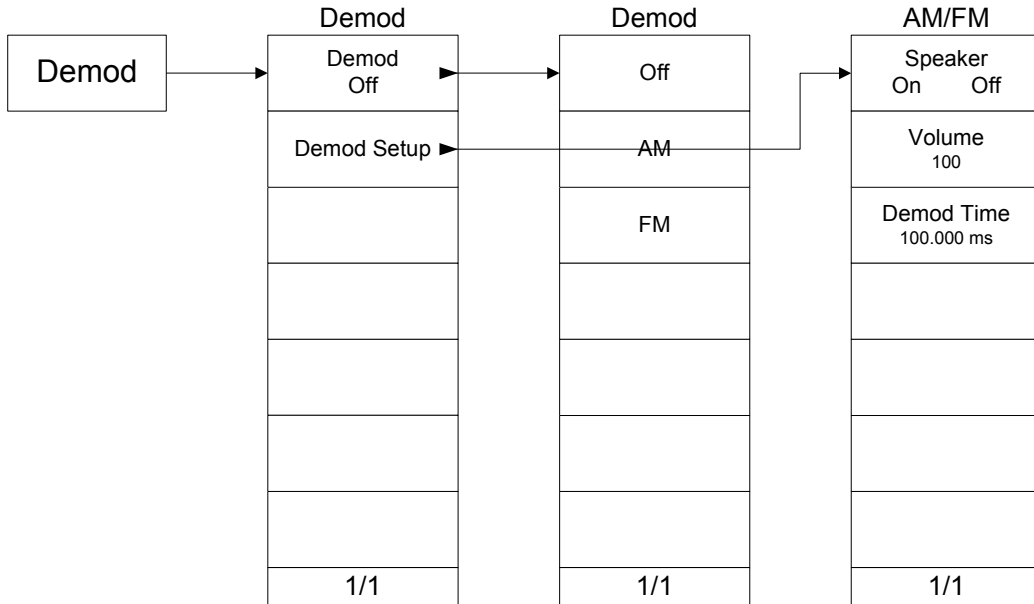



## 7.4 Detector

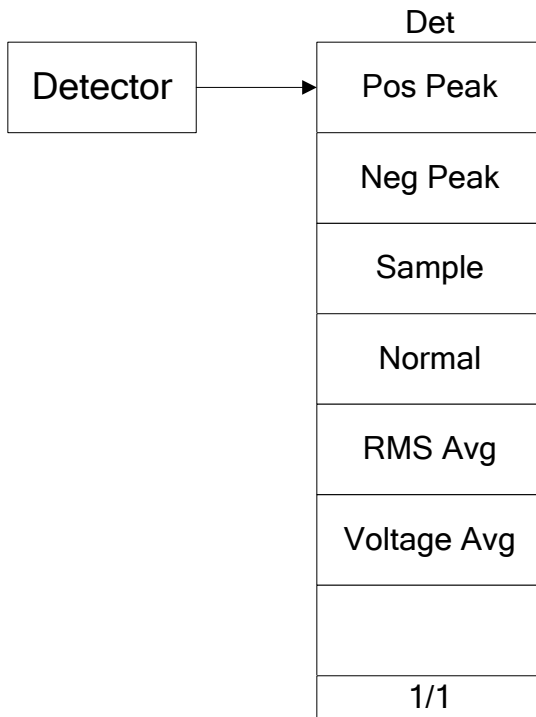

# 7.5 Display

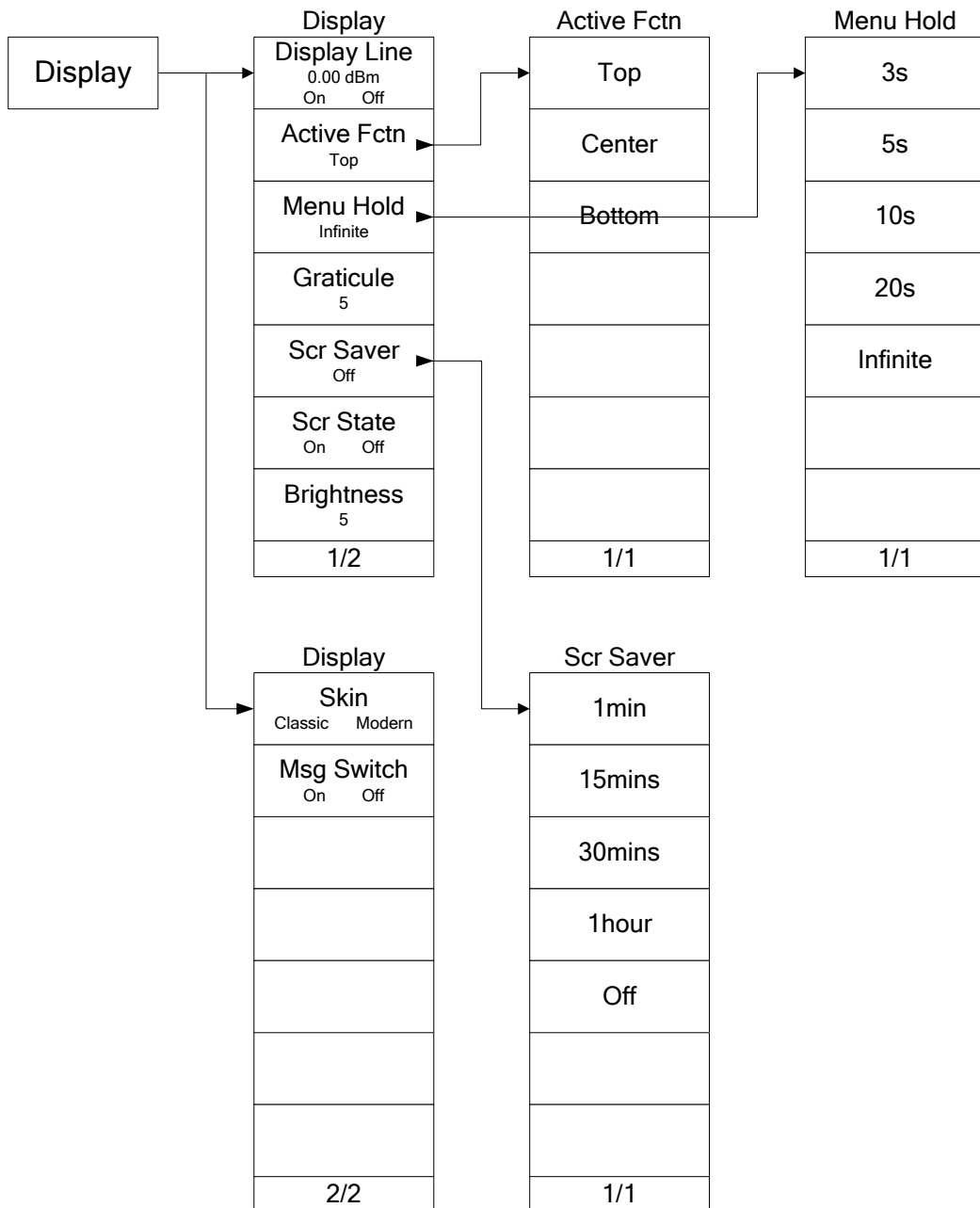

# 7.6 FREQ

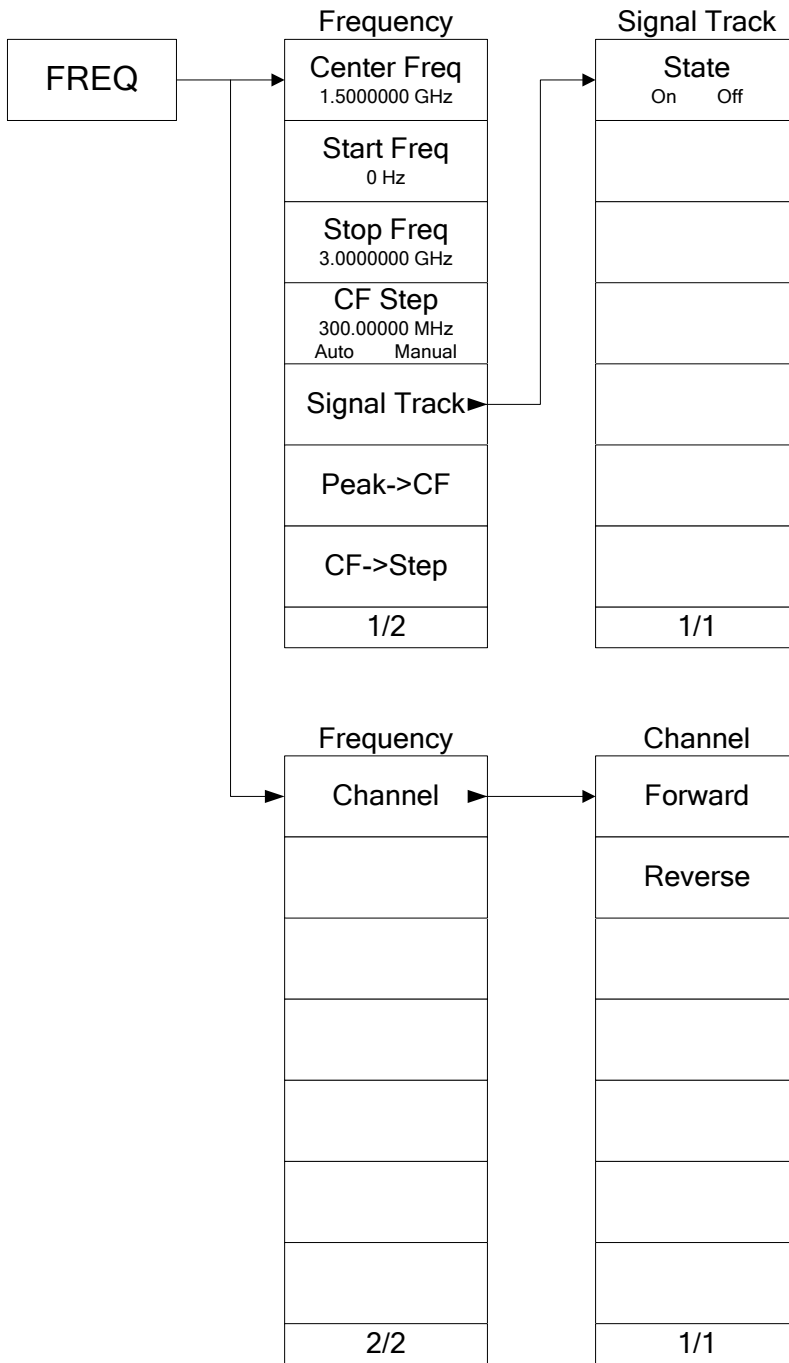

# 7.7 Marker

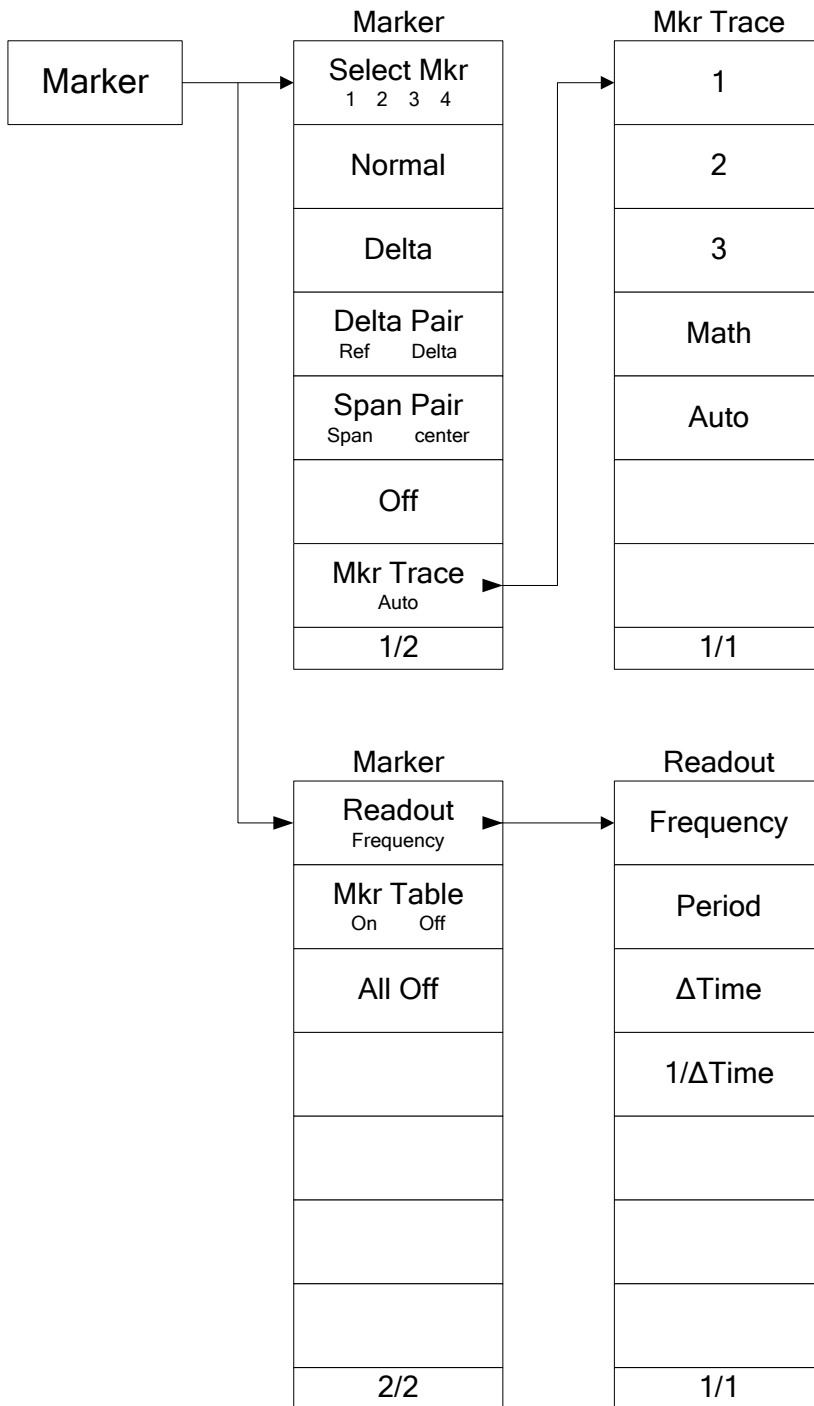

## 7.8 Marker Fctn

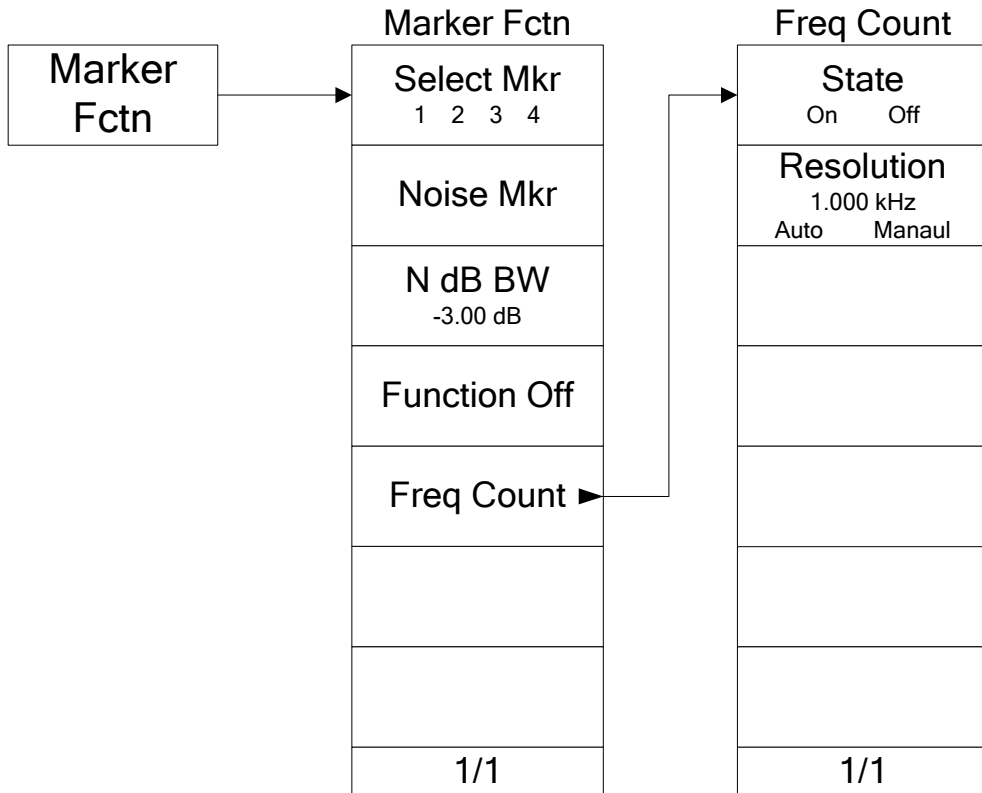

## 7.9 Marker->

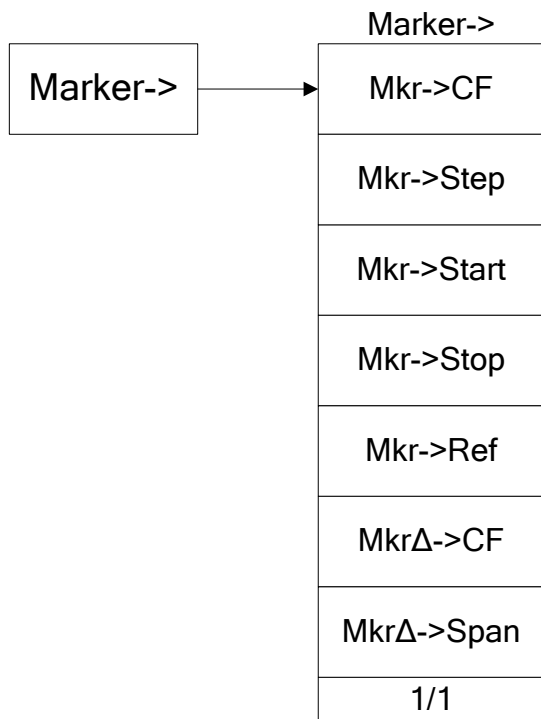

## 7.10 Meas (For DSA1030)

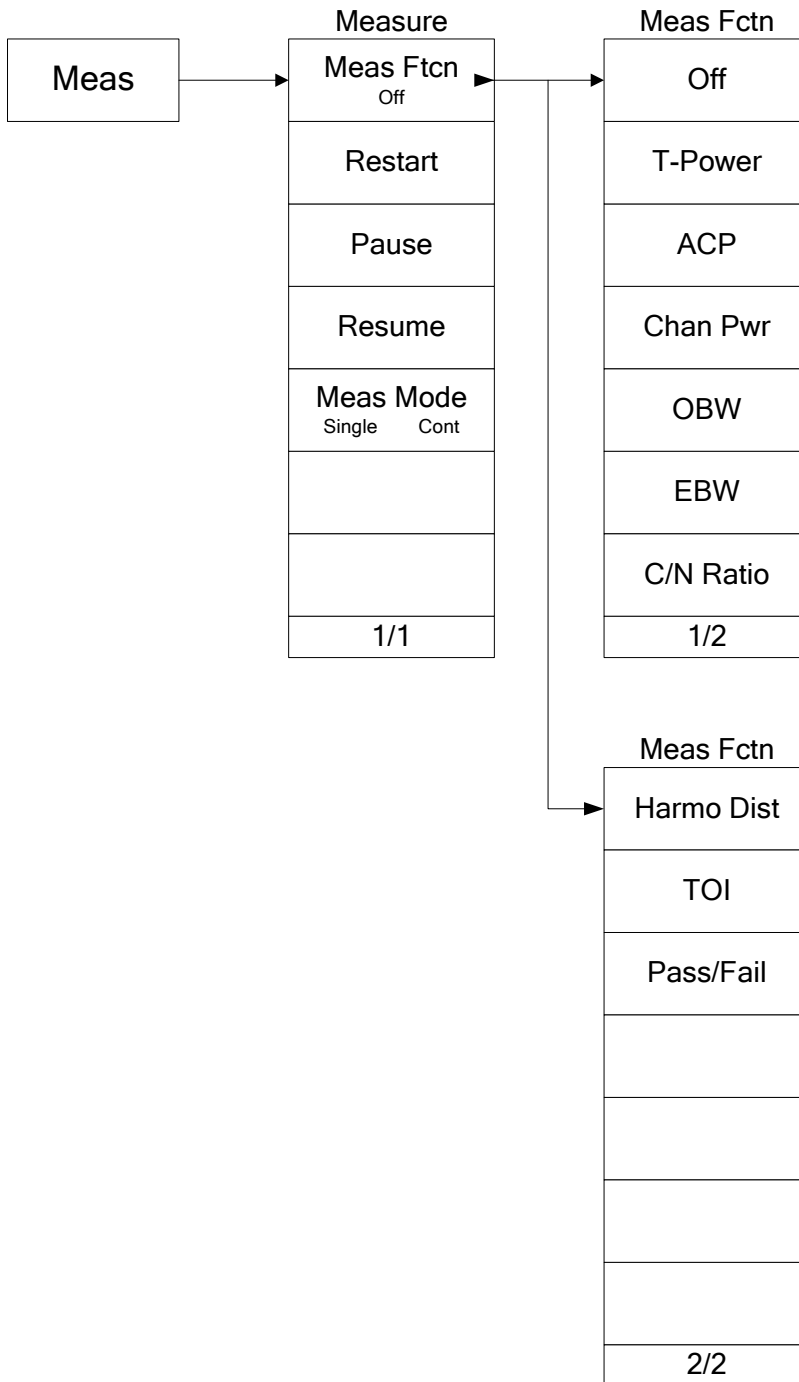

## 7.11 Meas Setup (For DSA1030)

### 7.11.1 T-Power

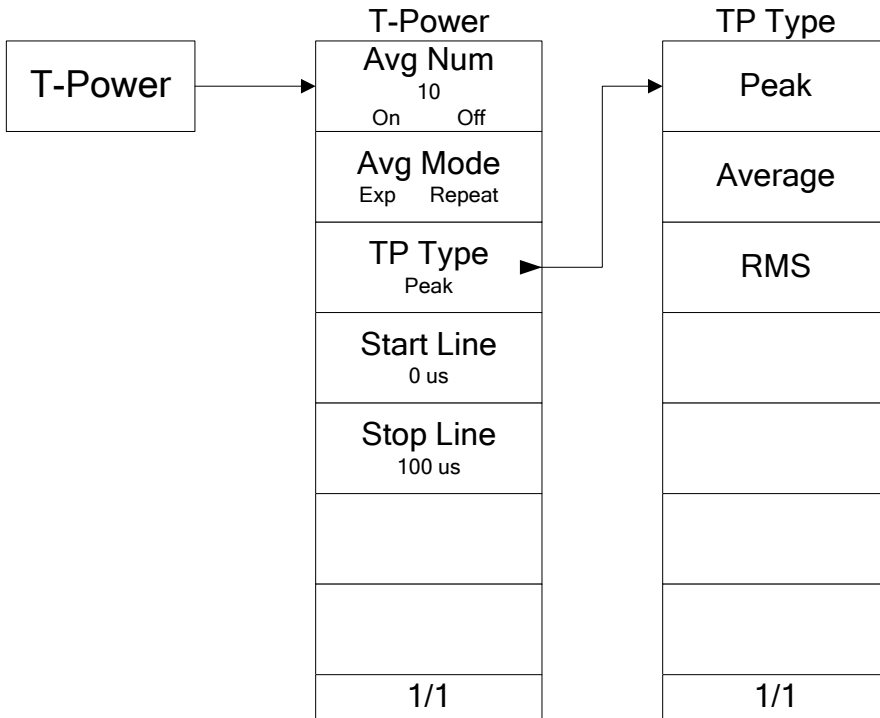



## 7.11.2 ACP

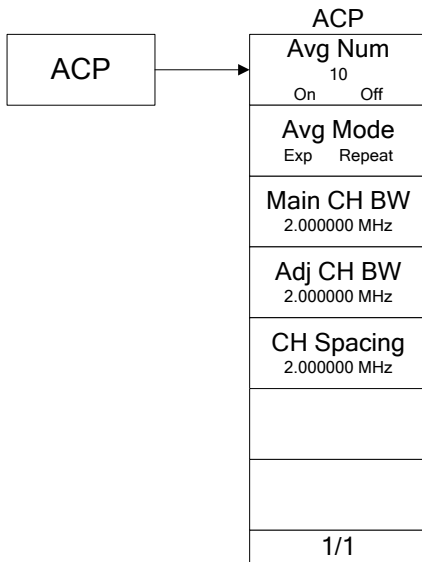

## 7.11.3 Channel Power

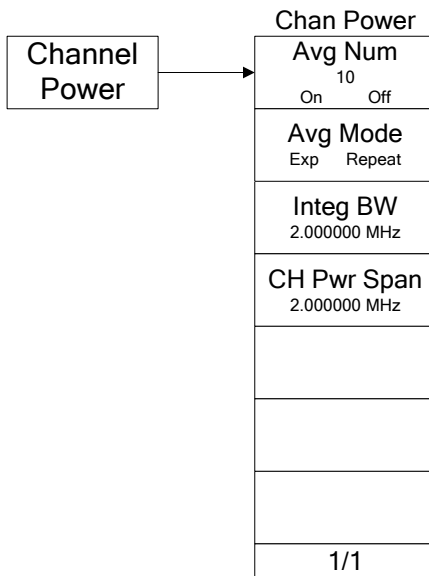

### 7.11.4 OBW

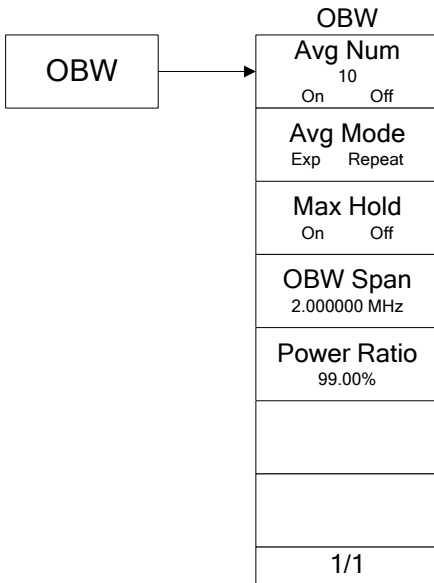

### 7.11.5 EBW

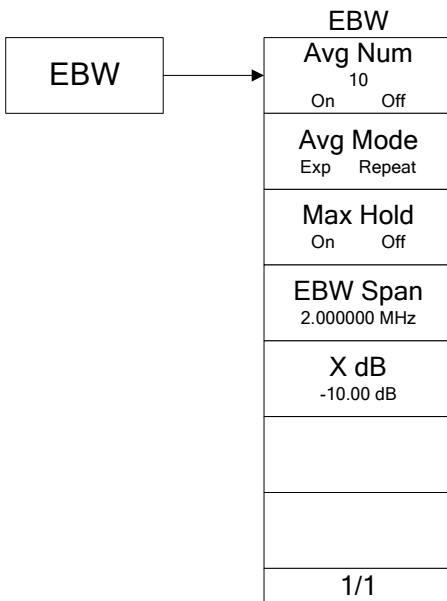

## 7.11.6 C/N Ratio

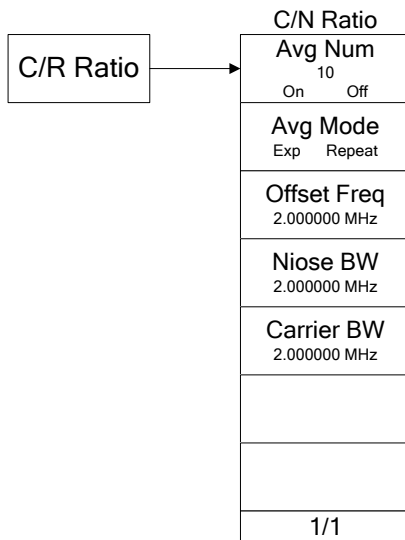

## 7.11.7 Harmonics Dist

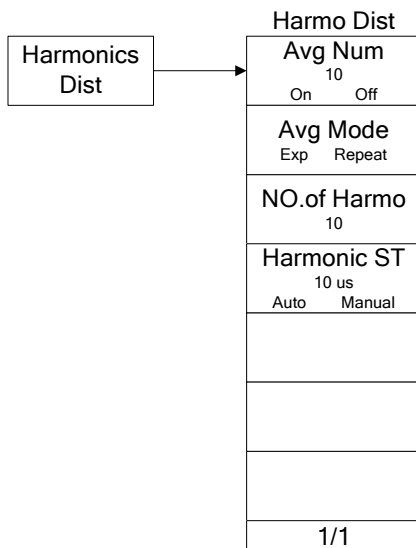

### 7.11.8 TOI

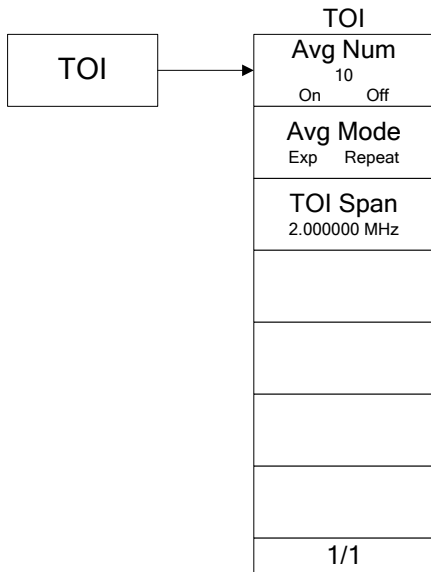

### 7.11.9 Pass/Fail

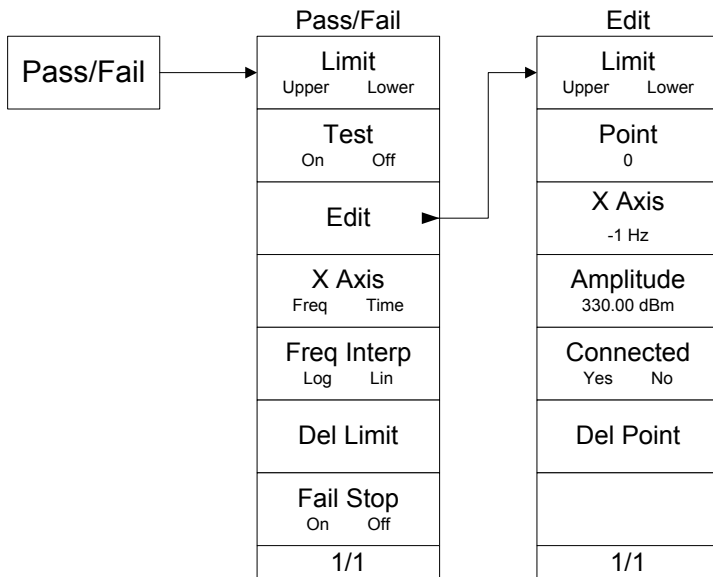

# 7.12 Peak

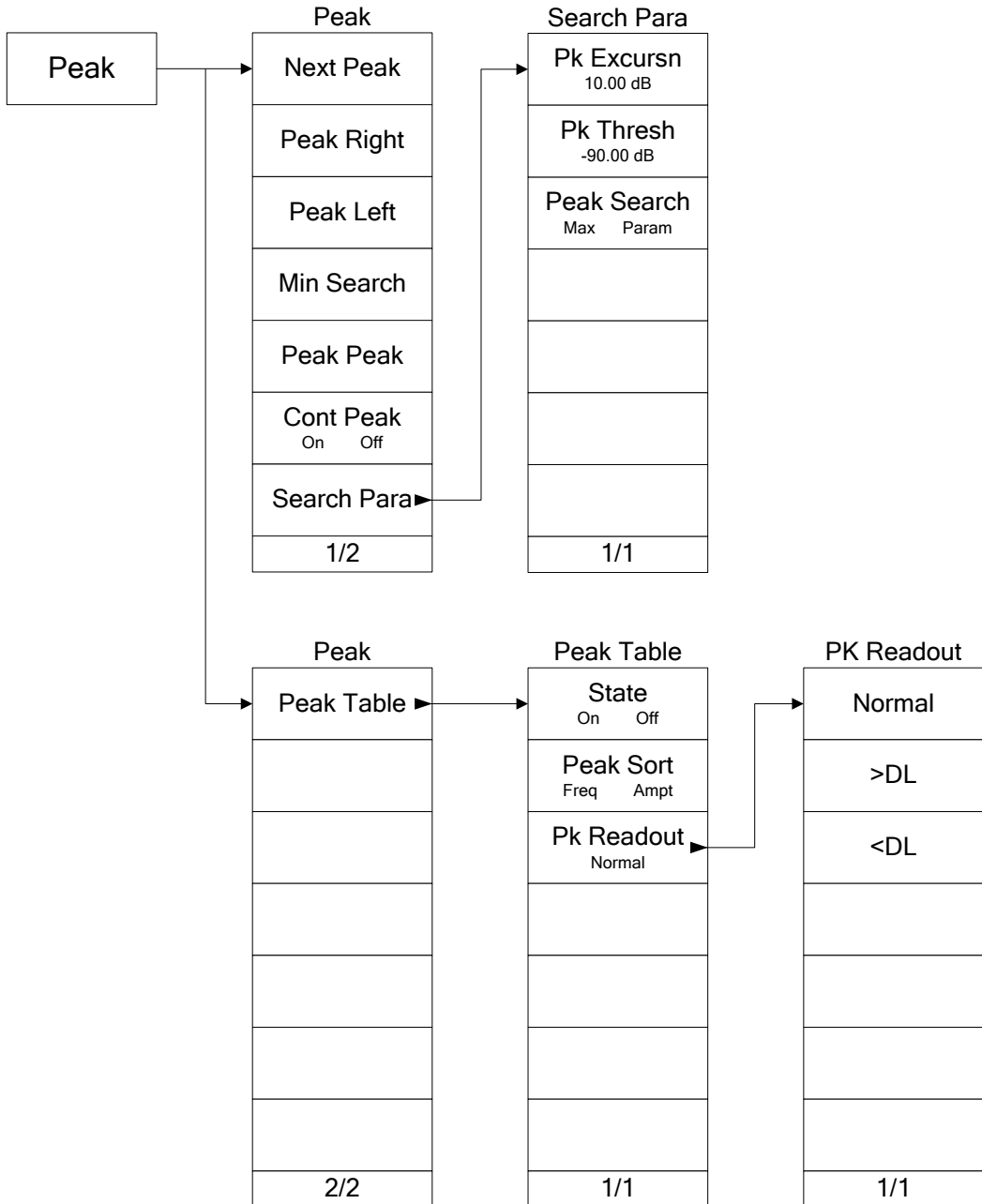

# 7.13 Print Setup

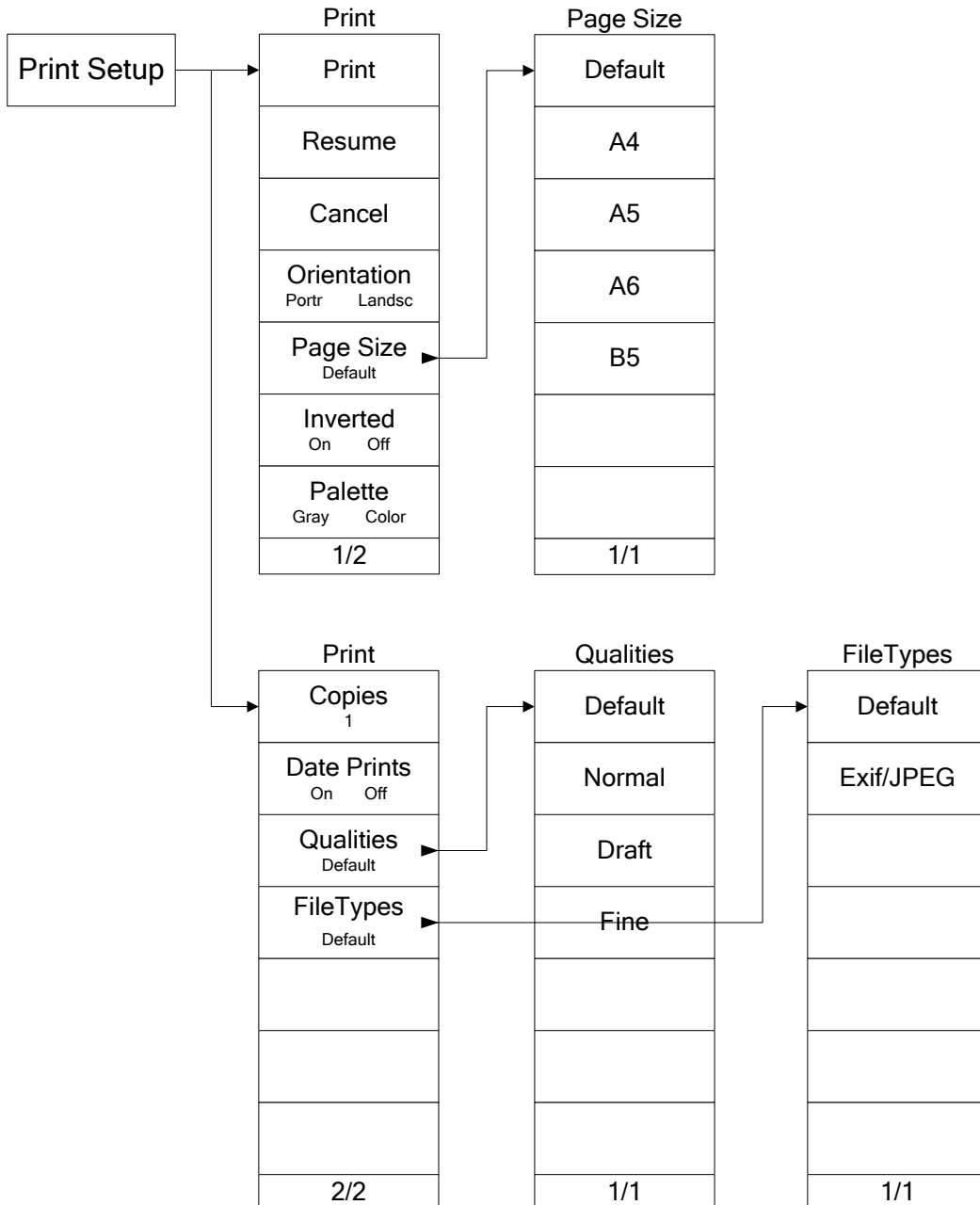

## 7.14 SPAN

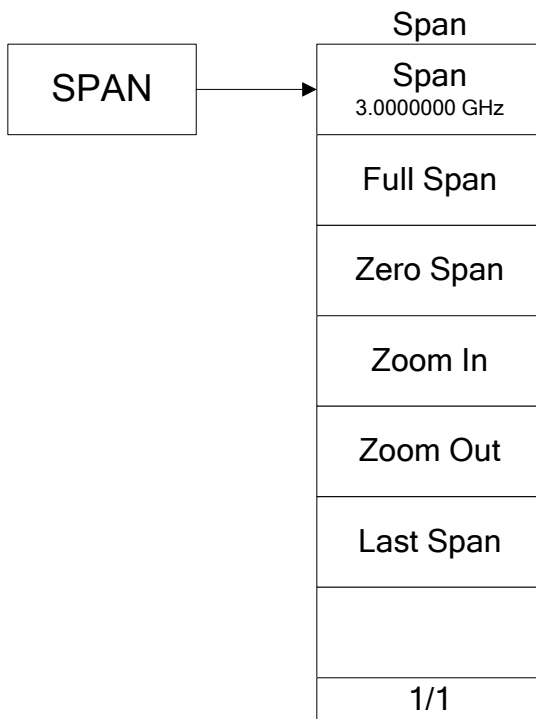

# 7.15 Storage

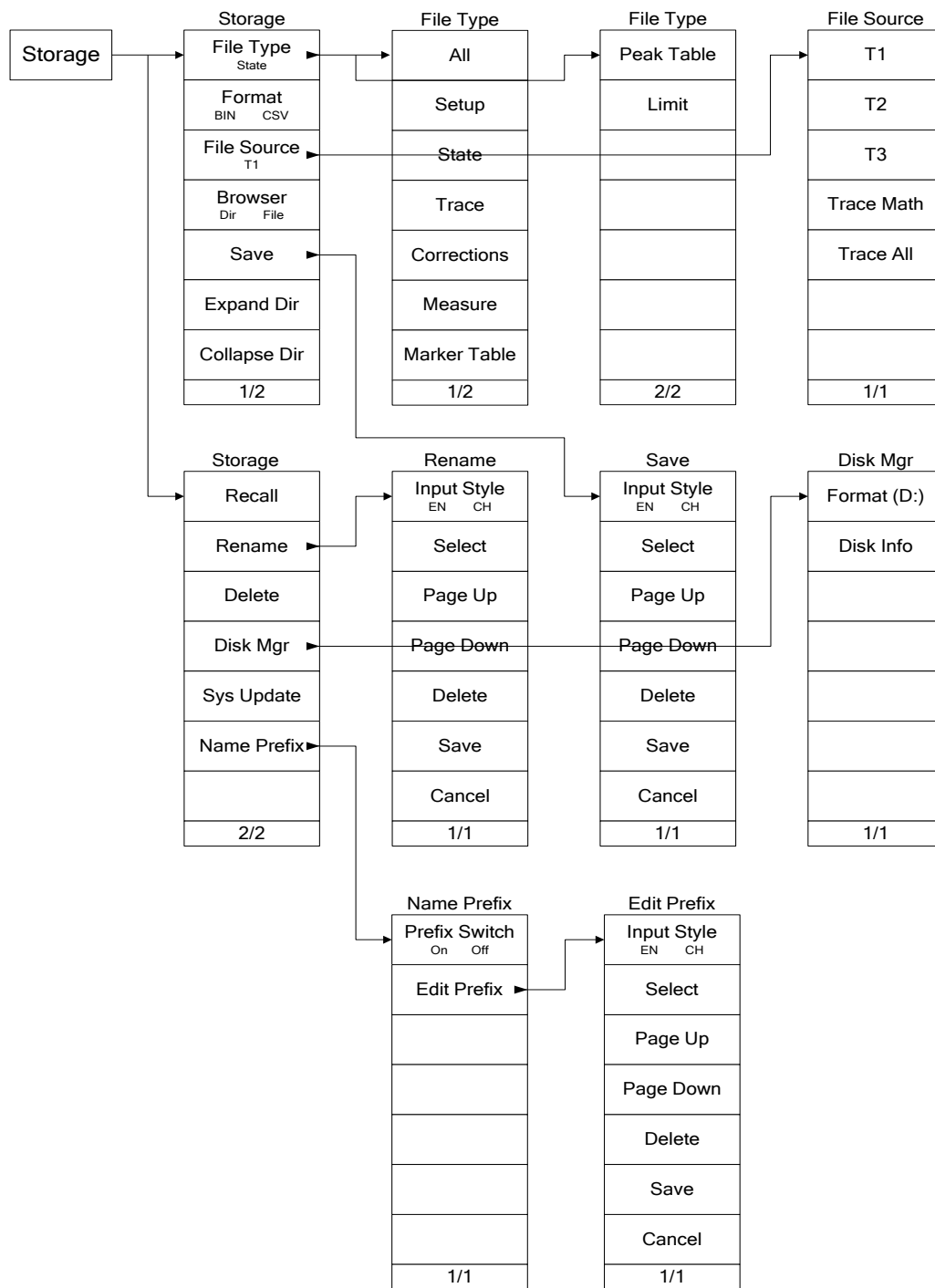



## 7.16 Sweep

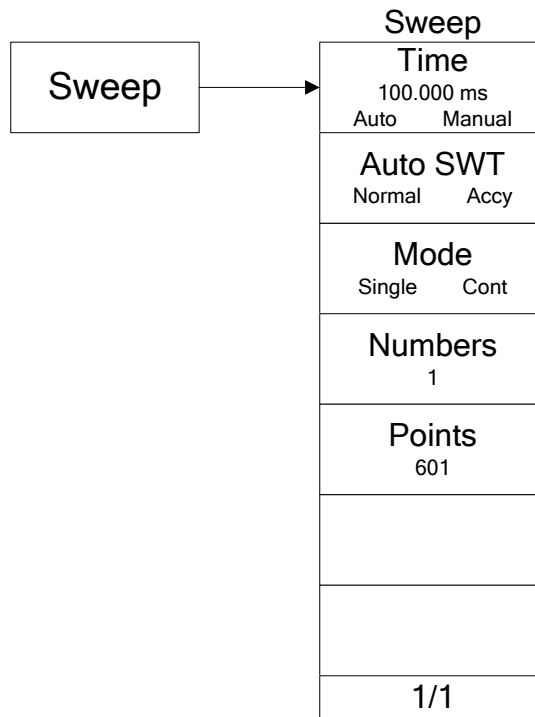

# 7.17 System

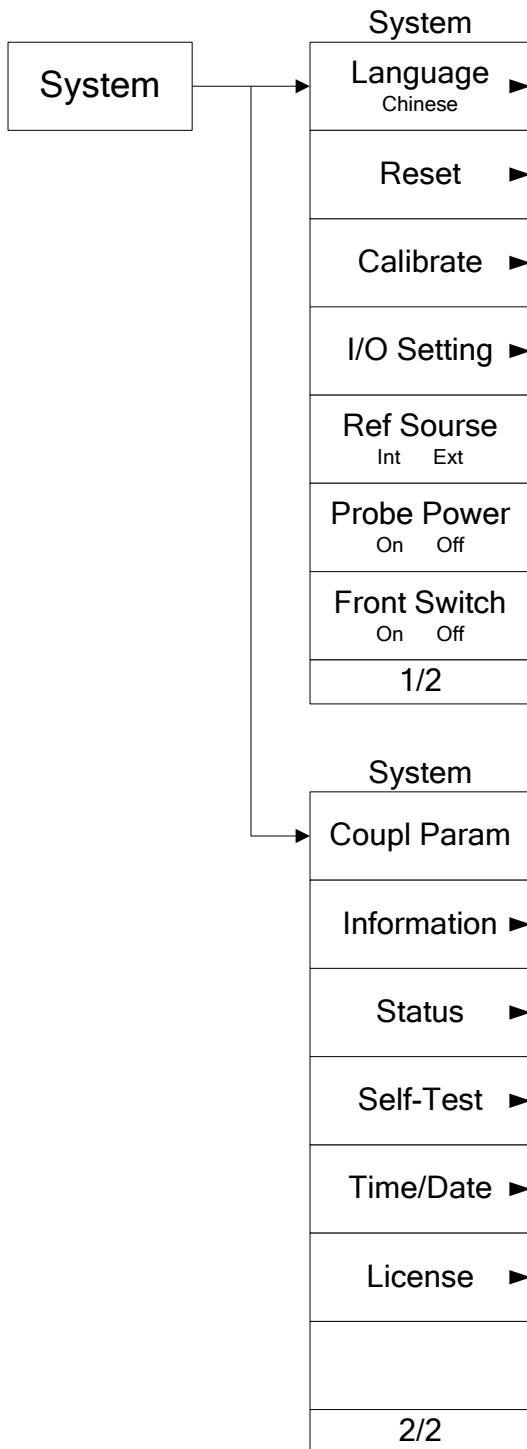

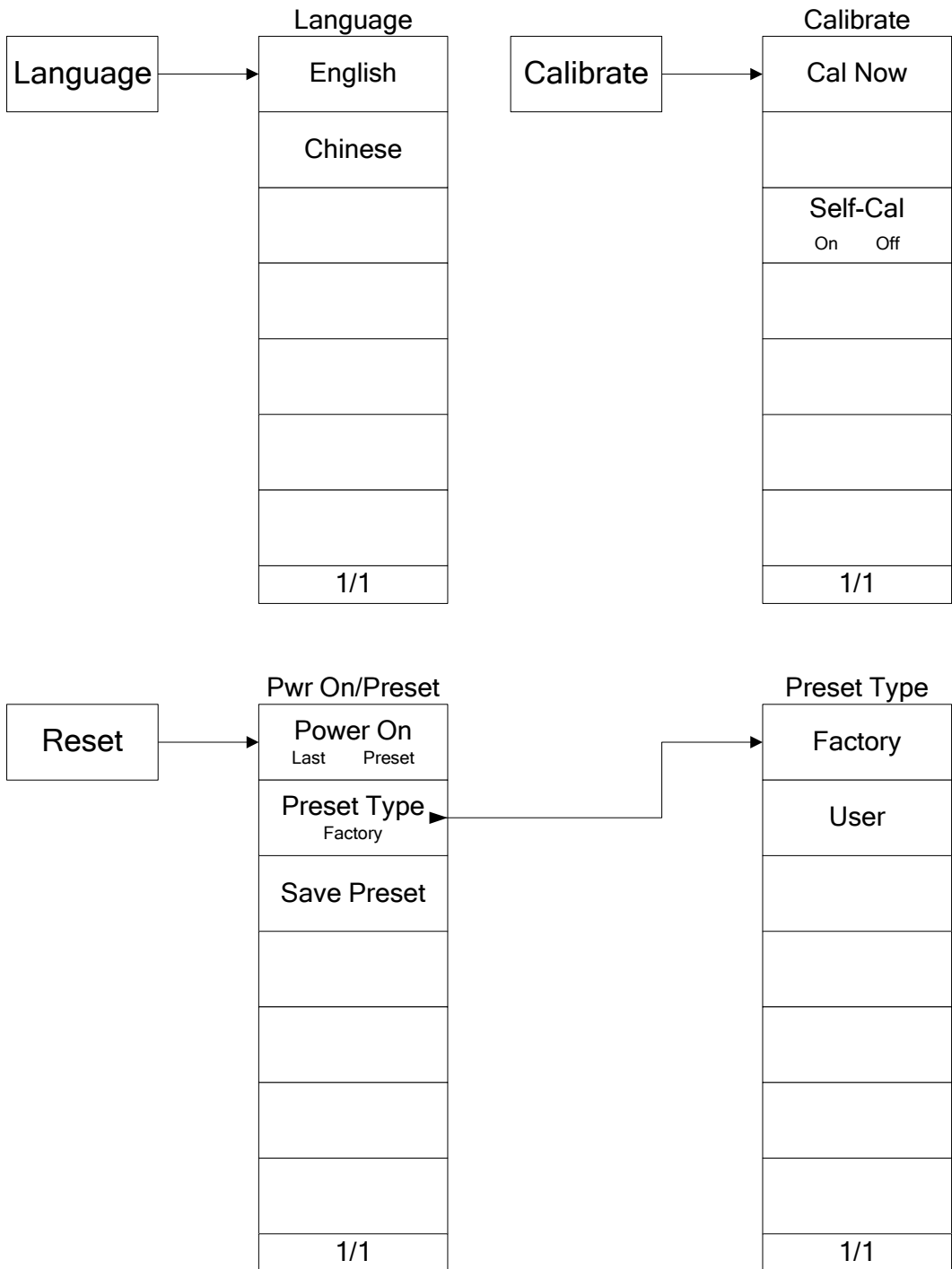

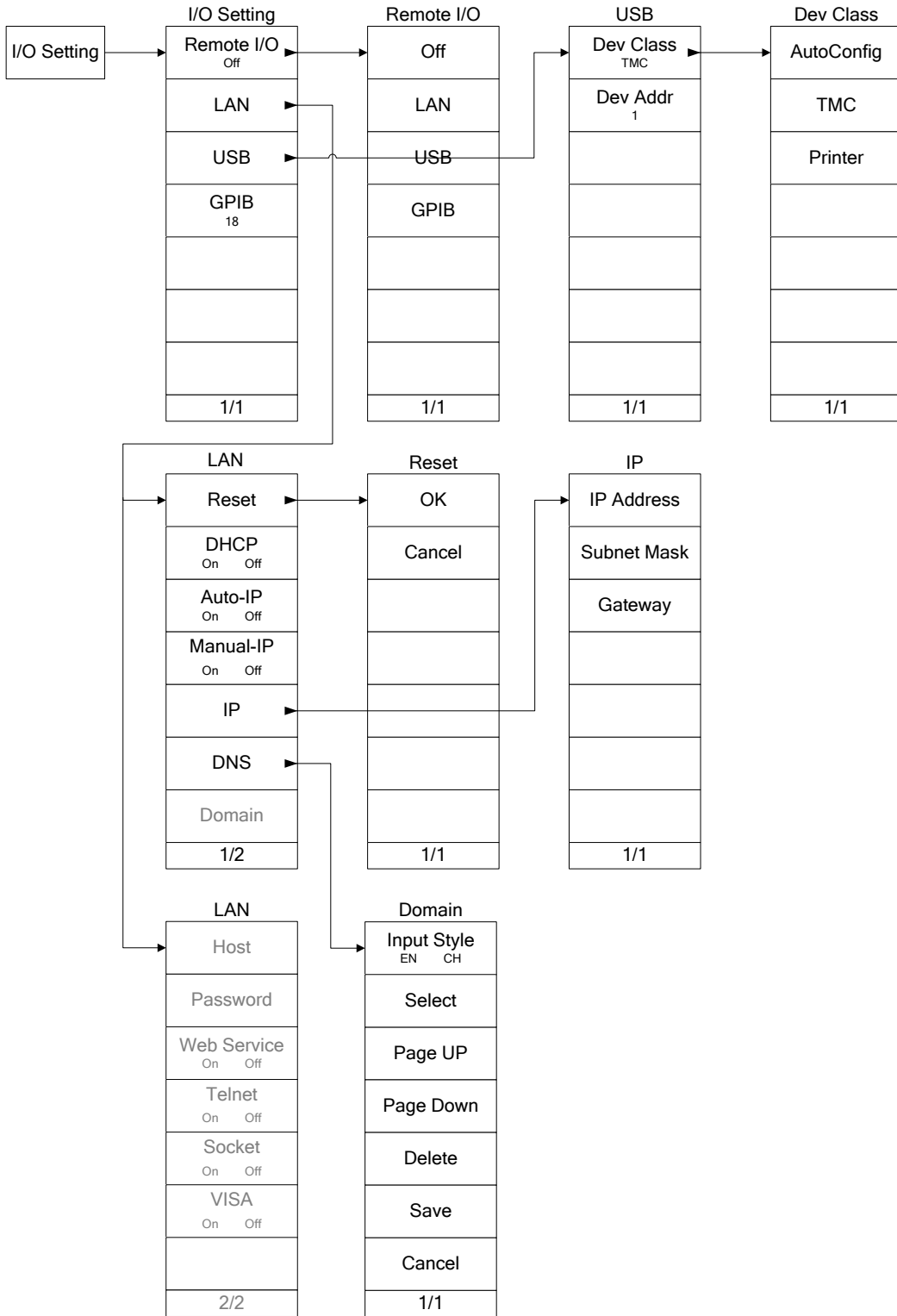

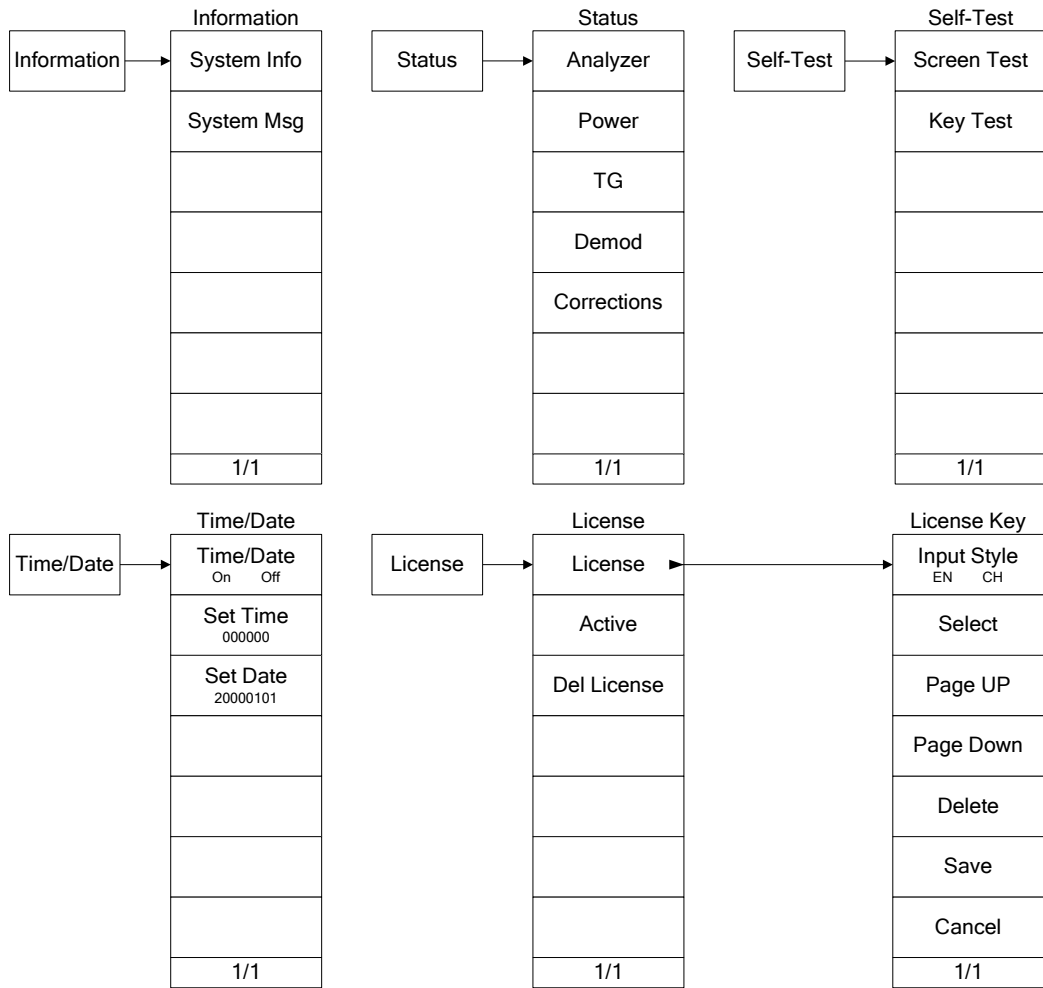

## 7.18 Source

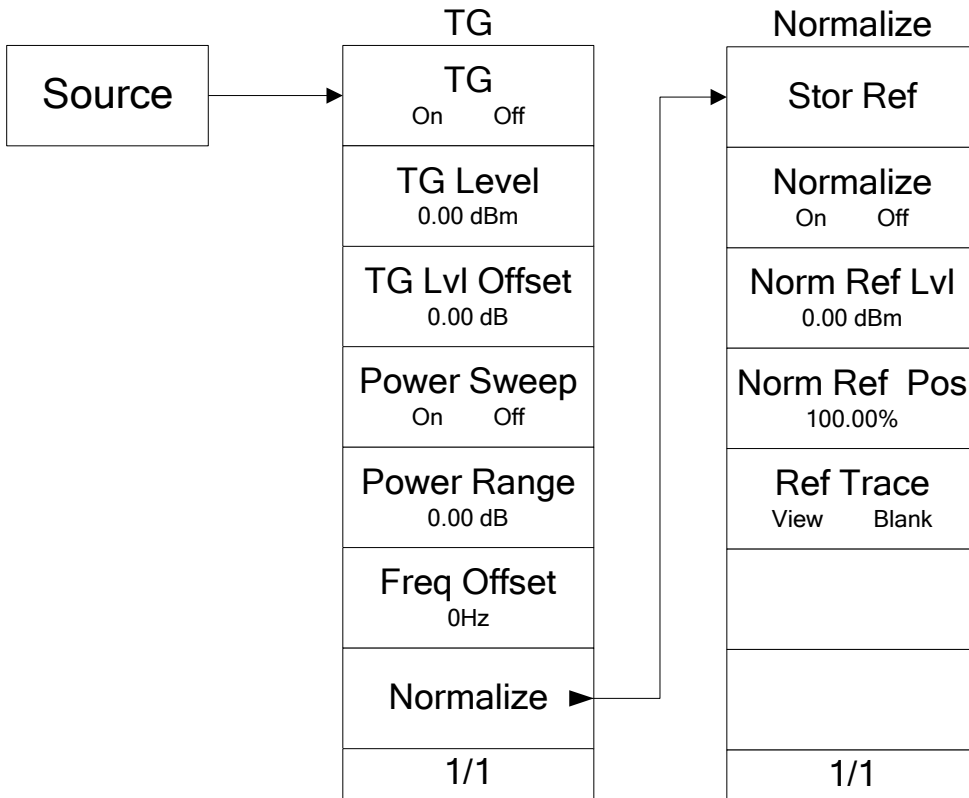

# 7.19 Trace

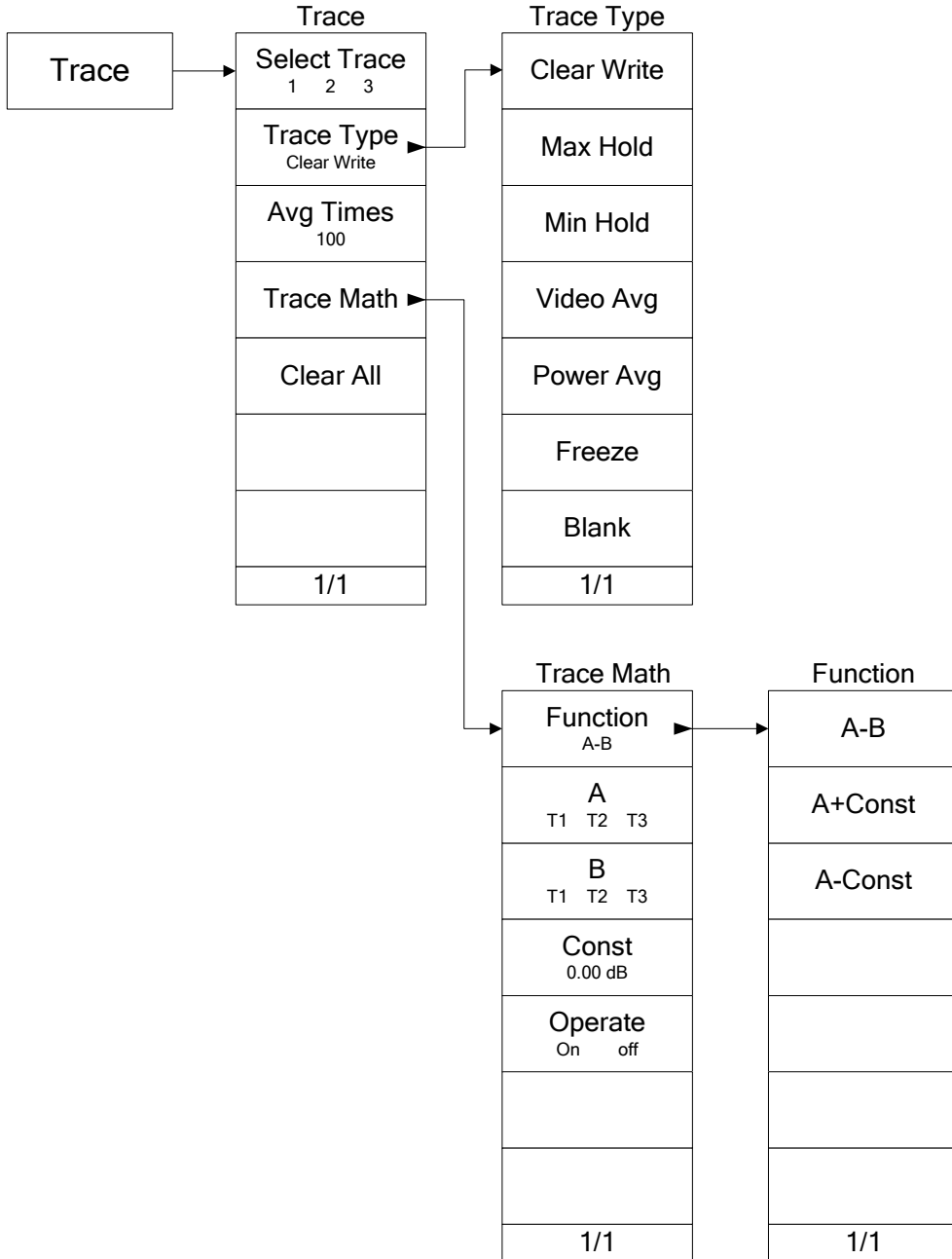

## 7.20 Trig

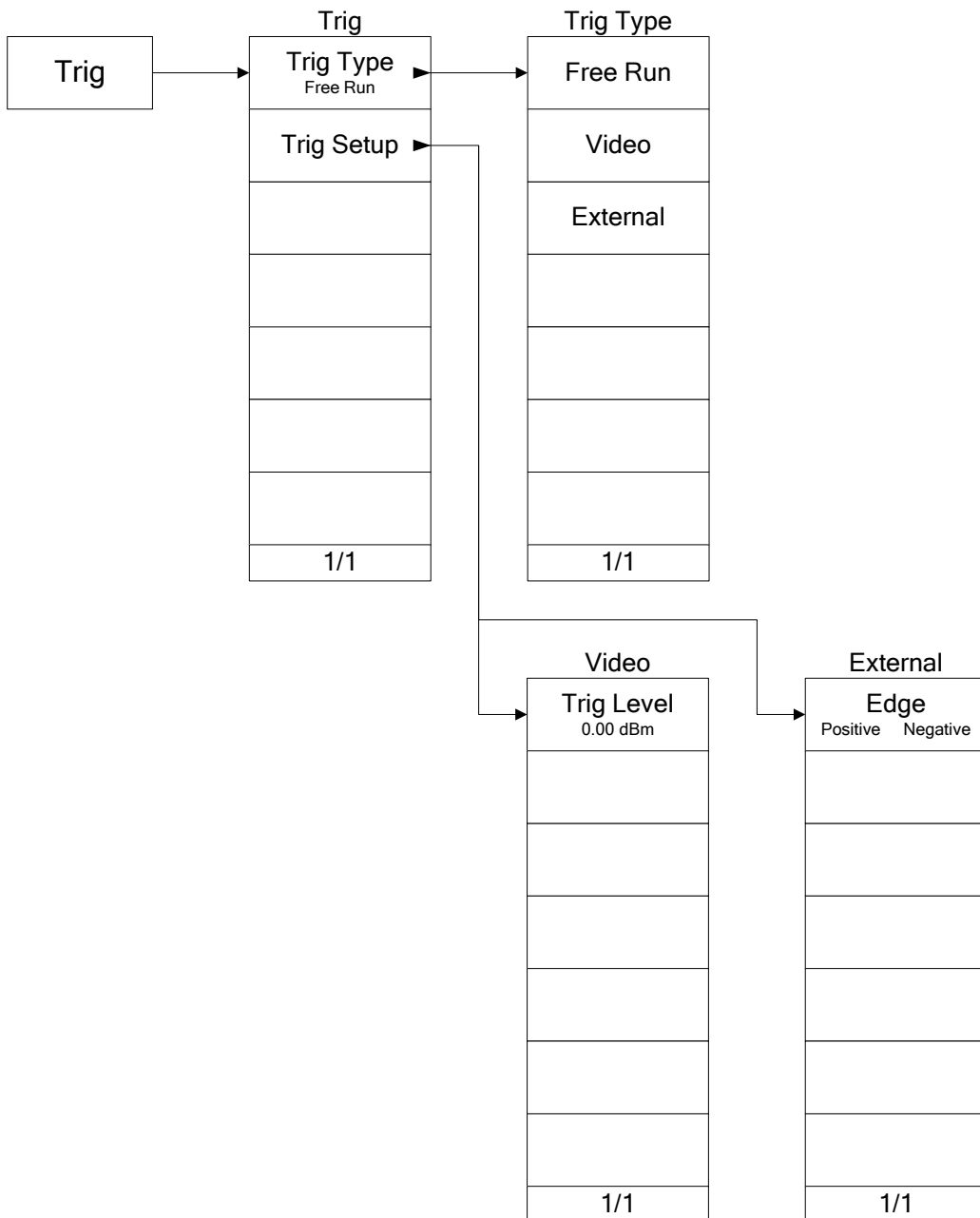



## 8 Appendix

### Appendix A: Options and Accessories

Name	Description
<b>Options</b>	
Preamplifier	DSA1030-PA (For DSA1030 only)
Advanced Measurement and Demodulation Module	DSA1000-AMK (For DSA1030 only)
3 GHz Tracking Generator	DSA1030-TG3 (For DSA1030 only)
Portable Carrying Case	DSA1000-SCBA
Rack Mounting Kit	DSA1000-RMSA
<b>Standard Accessories</b>	
Power Cord	1
USB Cable	1
Front Panel Cover	1
Quick Guide	1
CDROM	1 (User's Guide, Programming Guide)
<b>Optional Accessories</b>	
Arm	ARM
USB-GPIB Module	USB-GPIB
Lithium Batteries	BAT (11.1 V, 147 Wh)

**Note: For more options and accessories, please contact your local RIGOL office.**

## Appendix B: Warranty

**RIGOL** warrants that its products mainframe and accessories will be free from defects in materials and workmanship within the warranty period. If a product is proven to be defective within the respective period, **RIGOL** guarantees the free replacement or repair of products which are approved defective.

To get repair service, please contact with your nearest **RIGOL** sales and service office.

**RIGOL** does not provide any other warranty items except the one being provided by this summary and the warranty statement. The warranty items include but not being subjected to the hint guarantee items related to tradable characteristic and any particular purpose.

**RIGOL** will not take any responsibility in cases regarding to indirect, particular and ensuing damage.

## Appendix C: General Care and Cleaning

### General Care:

Do not store or leave the instrument in where the instrument will be exposed to direct sunlight for long periods of time.



#### **CAUTION**

To avoid damages to the instrument, do not expose them to liquids which have causticity.

---

### Cleaning:

Clean the instrument regularly according to its operating conditions. To clean the exterior surface, perform the following steps:

1. Disconnect the instrument from all power sources.
2. Clean the loose dust on the outside of the instrument with a lint- free cloth (with a mild detergent and water). When cleaning the LCD, take care to avoid scratching it.



#### **WARNING**

To avoid injury resulting from short circuit, make sure the instrument is completely dry before reconnecting it to a power source.

---

## Appendix D: Contact Us

If you have any problem or requirement when using our products, please contact **RIGOL** Technologies, Inc. or your local distributors.

Domestic: Please call

Tel: (86-10) 8070 6688

Fax: (86-10) 8070 5070

**Service & Support Hotline: 800 810 0002**

9:00 am - 5: 00 pm from Monday to Friday

Or by e-mail:

**service@rigol.com**

Or mail to:

**RIGOL** Technologies, Inc.

156# Cai He Village, Sha He Town, Chang Ping District, Beijing, China

Post Code: 102206

Overseas: Contact the local **RIGOL** distributors or sales office.

For the latest product information and service, visit our website:

<http://www.rigolna.com>

# Index

1/Δ Time .....	2-77	Corrections .....	2-94
ACP .....	2-44	Coupl Param .....	2-92
Active .....	2-95	DANL.....	V
Active Fct .....	2-96	Del Limit.....	2-71
Adj CH BW.....	2-51	Delta .....	2-74
Analyzer .....	2-93	Delta Pair.....	2-75
attenuator .....	1-3	Demod .....	2-37, 2-94
Auto Range.....	2-15	Demod Time.....	2-37
Auto Scale .....	2-11	Disc Mgr .....	2-109
Auto SWT .....	2-22	Disk Info.....	2-109
Average .....	2-48	Display Line .....	2-96
Average Times .....	2-35	EBW .....	2-45
Avg Mode .....	2-48	Edge.....	2-28
Avg Num .....	2-47	Edit .....	2-109
Brightness .....	2-98	Edit .....	2-70
C/N Ratio.....	2-45	Expand Dir.....	2-108
Cal Now.....	2-89	External Reference.....	2-91
Carrier BW.....	2-64	External Trigger .....	2-27
Carrier Pwr .....	2-62	Factory Default .....	2-100
Center Freq .....	2-2	Fail Stop .....	2-71
CF -> Step.....	2-8	File Source.....	2-107
CF Step .....	2-4	Format (D:) .....	2-109
CH Pwr .....	2-50	Forward.....	2-8
Ch Pwr Span.....	2-54	Free Run Trigger .....	2-27
CH Spacing.....	2-52	Freeze .....	2-35
Channel.....	2-8	Freq Count.....	2-82
Channel Power.....	2-44, 2-53	Freq Interp .....	2-18
Cleaning .....	8-3	Freq Interp .....	2-71
Clear Write .....	2-34	Freq Offset .....	2-41
Coliapse Dir .....	2-108	Frequency Range .....	V
Cont Peak.....	2-85	Front Switch .....	2-92
Corr Table.....	2-18	Full Span .....	2-10
Corr View .....	2-19	Function .....	2-36
Correction.....	2-17, 2-18	GPIB.....	2-91

Graticule.....	2-97	Offset Freq.....	2-63
Harmo Dist .....	2-45	Pass/Fail .....	2-45
Harmonics .....	2-66	Peak -> CF .....	2-7
Input.....	2-19	Peak Left .....	2-84
Input Atten .....	2-12	Peak Peak.....	2-85
Integ BW .....	2-54	Peak Right .....	2-84
Internal Reference .....	2-91	Peak Search .....	2-86
Key Test.....	2-94	Peak Sort.....	2-86
LAN .....	2-89	Peak Table .....	2-86
Last Span .....	2-10	Phase Noise .....	V
License Key.....	2-95	PK Excursn.....	2-85
Limit.....	2-70	Pk Readout .....	2-87
Main CH BW.....	2-51	PK Thresh.....	2-85
Marker Table.....	2-77	Pos Peak.....	2-32
Max Hold .....	2-34, 2-57, 2-60	Power .....	2-93
MaxMixL .....	2-19	Power Avg .....	2-35
Meas Mode .....	2-46	Power On.....	2-88
Menu Hold .....	2-97	Power Range.....	2-41
Min Hold.....	2-34	Power Ratio .....	2-58
Min Search.....	2-85	Power Spectral Density .....	2-53
Mkr Trace .....	2-76	Power Sweep .....	2-40
Mkr->CF .....	2-78	Prefix Switch.....	2-109
Mkr->Ref .....	2-79	Preset Type.....	2-88
Mkr->Start.....	2-78	Probe Power .....	2-92
Mkr->Step .....	2-78	RBW .....	2-20
Mkr->Stop .....	2-79	RBW .....	1-3
MkrΔ->CF .....	2-79	Ref Level .....	2-12
MkrΔ->Span .....	2-79	Ref Offset .....	2-15
Msg Switch .....	2-99	Ref Trace .....	2-43
N dB BW.....	2-80	reference level .....	1-3
Neg Peak .....	2-32	Reset.....	2-88
Next Peak .....	2-84	Reverse .....	2-8
Noise BW.....	2-63	RF Preamp.....	2-17
Noise Mkr .....	2-80	RMS .....	2-48
Norm Ref Pos.....	2-42	RMS Avg.....	2-33
Normal .....	2-32, 2-73	Sample .....	2-32
Normalize .....	2-42	Save Preset.....	2-88
OBW.....	2-45	Scale Type .....	2-14

---

Scale/Div .....	2-13	System Message .....	2-93
Scr Saver .....	2-97	Test .....	2-70
Scr State .....	2-97	TG .....	2-94
Screen Test .....	2-94	TG level .....	2-39
Search Para .....	2-85	TG Level Offset .....	2-39
Self-Cal .....	2-89	Time .....	2-22
Signal Track .....	2-5	Time/Date .....	2-94
Skin .....	2-98	TOI .....	2-45
Source .....	2-39	TP Type .....	2-48
span .....	1-3	T-Power .....	2-44
Span .....	2-57, 2-60, 2-69	Tracking Generator .....	V
Span .....	2-9	Trigger Level .....	2-27
Span Pair .....	2-75	Units .....	2-14
Speaker .....	2-37	USB .....	2-90
Start Freq .....	2-3	V/R Ratio .....	2-21
Start Line .....	2-48	VBW .....	2-20
Stop Freq .....	2-4	VBW .....	1-3
Stop Line .....	2-49	Video Avg .....	2-35
Stor Ref .....	2-42	Video Trigger .....	2-27
Sweep Mode .....	2-23	Voltage Avg .....	2-33
Sweep Numbers .....	2-23	Volume .....	2-37
Sweep Points .....	2-23	X Axis .....	2-71
Sweep Time .....	2-66	X dB .....	2-61
System Information .....	2-93	Zero Span .....	2-10