

RIGOL

Programming Guide

DSG3000 Series RF Signal Generator

May 2015
RIGOL Technologies, Inc.

Guaranty and Declaration

Copyright

© 2013 RIGOL Technologies, Inc. All Rights Reserved.

Trademark Information

RIGOL is a registered trademark of RIGOL Technologies, Inc.

Publication Number

PGG01104-1110

Software Version

00.01.03

Software upgrade might change or add product features. Please acquire the latest version of the manual from **RIGOL** website or contact **RIGOL** to upgrade the software.

Notices

- **RIGOL** products are covered by P.R.C. and foreign patents, issued and pending.
- **RIGOL** reserves the right to modify or change parts of or all the specifications and pricing policies at company's sole decision.
- Information in this publication replaces all previously corresponding material.
- Information in this publication is subject to change without notice.
- **RIGOL** shall not be liable for either incidental or consequential losses in connection with the furnishing, use or performance of this manual as well as any information contained.
- Any part of this document is forbidden to be copied, photocopied or rearranged without prior written approval of **RIGOL**.

Product Certification

RIGOL guarantees this product conforms to the national and industrial standards in China as well as the ISO9001:2008 standard and the ISO14001:2004 standard. Other international standard conformance certification is in progress.

Contact Us

If you have any problem or requirement when using our products or this manual, please contact **RIGOL**.

E-mail: service@rigol.com

Websites: www.rigol.com

Safety Requirement

General Safety Summary

Please review the following safety precautions carefully before putting the instrument into operation so as to avoid any personal injury or damage to the instrument and any product connected to it. To prevent potential hazards, please use the instrument only specified by this manual.

Use Proper Power Cord.

Only the power cord designed for the instrument and authorized for use within the local country could be used.

Ground the Instrument.

The instrument is grounded through the Protective Earth lead of the power cord. To avoid electric shock, it is essential to connect the earth terminal of the power cord to the Protective Earth terminal before connecting any inputs or outputs.

Connect the Probe Correctly.

If a probe is used, do not connect the ground lead to high voltage since it has isobaric electric potential as the ground.

Observe All Terminal Ratings.

To avoid fire or shock hazard, observe all ratings and markers on the instrument and check your manual for more information about ratings before connecting the instrument.

Use Proper Overvoltage Protection.

Make sure that no overvoltage (such as that caused by a thunderstorm) can reach the product, or else the operator might be exposed to the danger of electrical shock.

Do Not Operate Without Covers.

Do not operate the instrument with covers or panels removed.

Do Not Insert Anything Into the Holes of Fan.

Do not insert anything into the holes of the fan to avoid damaging the instrument.

Use Proper Fuse.

Please use the specified fuses.

Avoid Circuit or Wire Exposure.

Do not touch exposed junctions and components when the unit is powered.

Do Not Operate With Suspected Failures.

If you suspect damage occurs to the instrument, have it inspected by **RIGOL** authorized personnel before further operations. Any maintenance, adjustment or replacement especially to circuits or accessories must be performed by **RIGOL** authorized personnel.

Keep Well Ventilation.

Inadequate ventilation may cause an increase of instrument temperature which would cause damage to the instrument. So please keep the instrument well ventilated and inspect the intake and fan regularly.

Do Not Operate in Wet Conditions.

In order to avoid short circuiting to the interior of the device or electric shock, please do not operate the instrument in a humid environment.

Do Not Operate in an Explosive Atmosphere.

In order to avoid damage to the device or personal injuries, it is important to operate the device away from an explosive atmosphere.

Keep Product Surfaces Clean and Dry.

To avoid the influence of dust and/or moisture in the air, please keep the surface of the device clean and dry.

Electrostatic Prevention.

Operate the instrument in an electrostatic discharge protective environment to avoid damage induced by static discharges. Always ground both the internal and external conductors of cables to release static before making connections.

Proper Use of Battery.

If a battery is supplied, it must not be exposed to high temperature or in contact with fire. Keep it out of the reach of children. Improper change of battery (note: lithium battery) may cause explosion. Use **RIGOL** specified battery only.

Do Not Overload the Output.

In order to avoid damage to the instrument, the reverse DC voltage on the RF output connector cannot exceed 50 V; the reverse power must be less than +40 dBm (10 W) in the frequency range from 1 MHz to 6 GHz.

Handling Safety.

Please handle with care during transportation to avoid damage to keys, knob interfaces and other parts on the panels.

Safety Terms and Symbols

Terms Used in this Manual. These terms may appear in this manual:

**WARNING**

Warning statements indicate conditions or practices that could result in injury or loss of life.

**CAUTION**

Caution statements indicate conditions or practices that could result in damage to this product or other property.

Terms Used on the Product. These terms may appear on the product:

DANGER It calls attention to an operation, if not correctly performed, could result in injury or hazard immediately.

WARNING It calls attention to an operation, if not correctly performed, could result in potential injury or hazard.

CAUTION It calls attention to an operation, if not correctly performed, could result in damage to the product or other devices connected to the product.

Symbols Used on the Product. These symbols may appear on the product:



**Hazardous
Voltage**



**Safety
Warning**



**Protective
Earth
Terminal**



**Chassis
Ground**



**Test
Ground**

Allgemeine Sicherheits Informationen

Überprüfen Sie die folgenden Sicherheitshinweise sorgfältig um Personenschäden oder Schäden am Gerät und an damit verbundenen weiteren Geräten zu vermeiden. Zur Vermeidung von Gefahren, nutzen Sie bitte das Gerät nur so, wie in diesem Handbuch angegeben.

Um Feuer oder Verletzungen zu vermeiden, verwenden Sie ein ordnungsgemäßes Netzkabel.

Verwenden Sie für dieses Gerät nur das für ihr Land zugelassene und genehmigte Netzkabel.

Erden des Gerätes.

Das Gerät ist durch den Schutzleiter im Netzkabel geerdet. Um Gefahren durch elektrischen Schlag zu vermeiden, ist es unerlässlich, die Erdung durchzuführen. Erst dann dürfen weitere Ein- oder Ausgänge verbunden werden.

Anschluss eines Tastkopfes.

Die Erdungsklemmen der Sonden sind auf dem gleichen Spannungspegel des Instruments geerdet. Schließen Sie die Erdungsklemmen an keine hohe Spannung an.

Beachten Sie alle Anschlüsse.

Zur Vermeidung von Feuer oder Stromschlag, beachten Sie alle Bemerkungen und Markierungen auf dem Instrument. Befolgen Sie die Bedienungsanleitung für weitere Informationen, bevor Sie weitere Anschlüsse an das Instrument legen.

Verwenden Sie einen geeigneten Überspannungsschutz.

Stellen Sie sicher, daß keinerlei Überspannung (wie z.B. durch Gewitter verursacht) das Gerät erreichen kann. Andernfalls besteht für den Anwender die Gefahr eines Stromschlages.

Nicht ohne Abdeckung einschalten.

Betreiben Sie das Gerät nicht mit entfernten Gehäuse-Abdeckungen.

Betreiben Sie das Gerät nicht geöffnet.

Der Betrieb mit offenen oder entfernten Gehäuseteilen ist nicht zulässig. Nichts in entsprechende Öffnungen stecken (Lüfter z.B.)

Passende Sicherung verwenden.

Setzen Sie nur die spezifikationsgemäßen Sicherungen ein.

Vermeiden Sie ungeschützte Verbindungen.

Berühren Sie keine unisolierten Verbindungen oder Baugruppen, während das Gerät in Betrieb ist.

Betreiben Sie das Gerät nicht im Fehlerfall.

Wenn Sie am Gerät einen Defekt vermuten, sorgen Sie dafür, bevor Sie das Gerät wieder betreiben, dass eine Untersuchung durch **RIGOL** autorisiertem Personal durchgeführt wird. Jedwede Wartung, Einstellarbeiten oder Austausch von Teilen am Gerät, sowie am Zubehör dürfen nur von **RIGOL** autorisiertem Personal durchgeführt werden.

Belüftung sicherstellen.

Unzureichende Belüftung kann zu Temperaturanstiegen und somit zu thermischen Schäden am Gerät führen. Stellen Sie deswegen die Belüftung sicher und kontrollieren regelmäßig Lüfter und Belüftungsöffnungen.

Nicht in feuchter Umgebung betreiben.

Zur Vermeidung von Kurzschluß im Geräteinneren und Stromschlag betreiben Sie das Gerät bitte niemals in feuchter Umgebung.

Nicht in explosiver Atmosphäre betreiben.

Zur Vermeidung von Personen- und Sachschäden ist es unumgänglich, das Gerät ausschließlich fernab

jedweder explosiven Atmosphäre zu betreiben.

Geräteoberflächen sauber und trocken halten.

Um den Einfluß von Staub und Feuchtigkeit aus der Luft auszuschließen, halten Sie bitte die Geräteoberflächen sauber und trocken.

Schutz gegen elektrostatische Entladung (ESD).

Sorgen Sie für eine elektrostatisch geschützte Umgebung, um somit Schäden und Funktionsstörungen durch ESD zu vermeiden. Erden Sie vor dem Anschluß immer Innen- und Außenleiter der Verbindungsleitung, um statische Aufladung zu entladen.

Die richtige Verwendung des Akkus.

Wenn eine Batterie verwendet wird, vermeiden Sie hohe Temperaturen bzw. Feuer ausgesetzt werden. Bewahren Sie es außerhalb der Reichweite von Kindern auf. Unsachgemäße Änderung der Batterie (Anmerkung: Lithium-Batterie) kann zu einer Explosion führen. Verwenden Sie nur von **RIGOL** angegebenen Akkus.

Sicherer Transport.

Transportieren Sie das Gerät sorgfältig (Verpackung!), um Schäden an Bedienelementen, Anschlüssen und anderen Teilen zu vermeiden.

Sicherheits Begriffe und Symbole

Begriffe in diesem Guide. Diese Begriffe können in diesem Handbuch auftauchen:



WARNING

Die Kennzeichnung WARNING beschreibt Gefahrenquellen die leibliche Schäden oder den Tod von Personen zur Folge haben können.



CAUTION

Die Kennzeichnung Caution (Vorsicht) beschreibt Gefahrenquellen die Schäden am Gerät hervorrufen können.

Begriffe auf dem Produkt. Diese Bedingungen können auf dem Produkt erscheinen:

DANGER

weist auf eine Verletzung oder Gefährdung hin, die sofort geschehen kann.

WARNING

weist auf eine Verletzung oder Gefährdung hin, die möglicherweise nicht sofort geschehen.

CAUTION

weist auf eine Verletzung oder Gefährdung hin und bedeutet, dass eine mögliche Beschädigung des Instruments oder anderer Gegenstände auftreten kann.

Symbole auf dem Produkt. Diese Symbole können auf dem Produkt erscheinen:



**Gefährliche
Spannung**



**Sicherheits-
Hinweis**



Schutz-erde



Gehäusemasse



Erde

Document Overview

This manual introduces how to program the RF signal generator over remote interfaces in details.

Main Topics in this Manual:

Chapter 1 Programming Overview

This chapter outlines how to build the remote communication between the RF signal generator and PC and how to control the RF signal generator remotely. Besides, it also provides a brief introduction of the SCPI commands.

Chapter 2 Command System

This chapter introduces the syntax, function, parameter and using instruction of each DSG3000 command in alphabetical order (from A to Z).

Chapter 3 Application Examples

This chapter provides the application examples of the main function of the RF signal generator. In the application examples, a series of commands are combined to realize the basic functions of the RF signal generator.

Chapter 4 Programming Demos

This chapter introduces how to program and control the DSG3000 in the development environments of Visual C++, Visual Basic and LabVIEW.

Chapter 5 Appendix

This chapter provides various information, such as the command list and factory setting list.

Tip

The latest version of this manual can be downloaded from www.rigol.com.

Format Conventions in this Manual:

1. Key:

The key at the front panel is denoted by the following format: "Text Box + Key Name (Bold)" in the manual, for example, **FREQ** denotes the **FREQ** key.

2. Menu:

The menu is denoted by the following format: "Character Shading + Menu Word (Bold)" in the manual, for example, **Frequency** denotes the frequency item under **FREQ**.

3. Operation Steps:

The next step of the operation is denoted by an arrow "→" in the manual. For example, **FREQ** → **Frequency** denotes pressing **FREQ** on the front panel and then pressing **Frequency**.

Content Conventions in this Manual:

The DSG3000 series RF signal generator includes DSG3030 and DSG3060. The introductions of the DSG3000 series commands in this manual are based on DSG3060, unless otherwise noted.

Contents

Guaranty and Declaration	I
Safety Requirement.....	II
General Safety Summary	II
Safety Terms and Symbols	IV
Allgemeine Sicherheits Informationen	V
Sicherheits Begriffe und Symbole.....	VII
Document Overview	VIII
Chapter 1 Programming Overview.....	1-1
To Build Remote Communication	1-2
Remote Control Methods	1-3
SCPI Command Overview	1-4
Syntax.....	1-4
Symbol Description	1-4
Parameter Type.....	1-5
Command Abbreviation	1-5
Chapter 2 Command System.....	2-1
IEEE488.2 Common Commands.....	2-2
*CLS	2-2
*ESE	2-2
*ESR?	2-3
*IDN?	2-3
*OPT?	2-3
*PSC	2-3
*RST	2-4
*SRE	2-4
*STB?	2-4
*TRG	2-4
*WAI.....	2-5
:MMEMory Commands	2-6
:MMEMory:CATalog	2-6
:MMEMory:CATalog:LENGth	2-7
:MMEMory:COPI	2-7
:MMEMory:DATA:IQ	2-8
:MMEMory:DATA:IQ:LIST	2-8
:MMEMory:DELeTe.....	2-9
:MMEMory:DISK:FORMat	2-9
:MMEMory:DISK:INFormation	2-9
:MMEMory:FILEtype	2-10
:MMEMory:LDISK:SPACe.....	2-10
:MMEMory:LOAD.....	2-10
:MMEMory:MDIRectory	2-11
:MMEMory:MOVE	2-11
:MMEMory:PNAME:EDIT	2-12
:MMEMory:PNAME:STATe.....	2-12
:MMEMory:SAVe.....	2-13
:OUTPut Command.....	2-14
:OUTPut[:STATe].....	2-14
:SOURce Commands	2-15
[:SOURce]:AM Command Subsystem.....	2-15
[:SOURce]:CORRection Command Subsystem.....	2-19
[:SOURce]:FM Command Subsystem	2-21
[:SOURce]:FMPM:TYPE.....	2-25

[:SOURce]:FREQuency Command Subsystem	2-25
[:SOURce]:INPut:TRIGger:SLOPe	2-29
[:SOURce]:IQ Command Subsystem	2-30
[:SOURce]:LEVel Command Subsystem	2-39
[:SOURce]:LFOutput Command Subsystem	2-48
[:SOURce]:MODulation:STATe	2-58
[:SOURce]:PHASe Command Subsystem	2-58
[:SOURce]:PM Command Subsystem	2-60
[:SOURce]:PULM Command Subsystem	2-65
[:SOURce]:SWEep Command Subsystem	2-82
:STATus Commands	2-100
:STATus:OPERation:CONDition	2-103
:STATus:OPERation:ENABLE	2-103
:STATus:OPERation[:EVENT]	2-103
:STATus:QUEStionable:CALibration:CONDition	2-104
:STATus:QUEStionable:CALibration:ENABLE	2-105
:STATus:QUEStionable:CALibration[:EVENT]	2-105
:STATus:QUEStionable:CONDition	2-105
:STATus:QUEStionable:CONNect:CONDition	2-106
:STATus:QUEStionable:CONNect:ENABLE	2-107
:STATus:QUEStionable:CONNect[:EVENT]	2-107
:STATus:QUEStionable:ENABLE	2-107
:STATus:QUEStionable[:EVENT]	2-108
:STATus:QUEStionable:FREQuency:CONDition	2-109
:STATus:QUEStionable:FREQuency:ENABLE	2-110
:STATus:QUEStionable:FREQuency[:EVENT]	2-110
:STATus:QUEStionable:MODulation:CONDition	2-111
:STATus:QUEStionable:MODulation:ENABLE	2-112
:STATus:QUEStionable:MODulation[:EVENT]	2-112
:STATus:QUEStionable:POWER:CONDition	2-113
:STATus:QUEStionable:POWER:ENABLE	2-114
:STATus:QUEStionable:POWER[:EVENT]	2-114
:STATus:QUEStionable:SELFtest:CONDition	2-115
:STATus:QUEStionable:SELFtest:ENABLE	2-116
:STATus:QUEStionable:SELFtest[:EVENT]	2-116
:STATus:QUEStionable:TEMP:CONDition	2-117
:STATus:QUEStionable:TEMP:ENABLE	2-118
:STATus:QUEStionable:TEMP[:EVENT]	2-118
:SYSTem Commands	2-119
:SYSTem:BRIGHtness	2-120
:SYSTem:CLear	2-120
:SYSTem:COMMunication:GPIB[:SELF]:ADDResS	2-120
:SYSTem:COMMunication:INTerface	2-121
:SYSTem:COMMunication:LAN:DHCP	2-121
:SYSTem:COMMunication:LAN:IP:ADDResS	2-122
:SYSTem:COMMunication:LAN:IP:AUTO	2-122
:SYSTem:COMMunication:LAN:IP:GATeway	2-123
:SYSTem:COMMunication:LAN:IP:MANual	2-123
:SYSTem:COMMunication:LAN:IP:SET	2-124
:SYSTem:COMMunication:LAN:IP:SUBnet:MASK	2-124
:SYSTem:COMMunication:LAN:RESet	2-124
:SYSTem:COMMunication:LAN[:SELF]:PREFerred	2-125
:SYSTem:DATE	2-125
:SYSTem:DISPlay:UPDate[:STATe]	2-126
:SYSTem:FSWitch:STATe	2-126
:SYSTem:LANGuage	2-127
:SYSTem:LKEY	2-127
:SYSTem:POWER:ON:TYPE	2-127

:SYSTem:PRESet	2-128
:SYSTem:PRESet:TYPE	2-128
:SYSTem:PRESet:SAVE	2-129
:SYSTem:TIME	2-129
:TRIGger Commands	2-130
:TRIGger:IQ[:IMMEDIATE]	2-130
:TRIGger:LFOUput[:IMMEDIATE]	2-130
:TRIGger:PULSe[:IMMEDIATE].....	2-130
:TRIGger[:SWEep][:IMMEDIATE]	2-131
:UNIT Command.....	2-132
:UNIT:POWer	2-132
Chapter 3 Application Examples	3-1
To Output RF signal	3-2
To Output RF Sweep Signal	3-2
To Output RF Modulated Signal.....	3-3
To Output Pulse Train.....	3-4
Chapter 4 Programming Demos.....	4-1
Programming Preparations	4-2
Excel Programming Demo	4-3
Matlab Programming Demo	4-7
LabVIEW Programming Demo.....	4-8
Visual Basic Programming Demo.....	4-12
Visual C++ Programming Demo	4-15
Chapter 5 Appendix	5-1
Appendix A: Command List	5-1
Appendix B: Factory Setting	5-8
Appendix C: Warranty	5-11

Chapter 1 Programming Overview

This chapter introduces how to build the remote communication between the instrument and PC and provides an overview of the syntax, abbreviation rules and status system of the SCPI commands.

Main topics of this chapter:

- ◆ [To Build Remote Communication](#)
- ◆ [Remote Control Methods](#)
- ◆ [SCPI Command Overview](#)

To Build Remote Communication

You can build the remote communication between DSG3000 and PC over USB, LAN or GPIB interface.

Operating Steps:

1. Install the Ultra Sigma common PC software

Acquire the Ultra Sigma software form www.rigol.com or the resource CD in the standard accessories and then install it according to the instructions.

2. Connect the instrument and PC and configure the interface parameters of the instrument

DSG3000 supports USB, LAN and GPIB communication interfaces, as shown in the figure below.

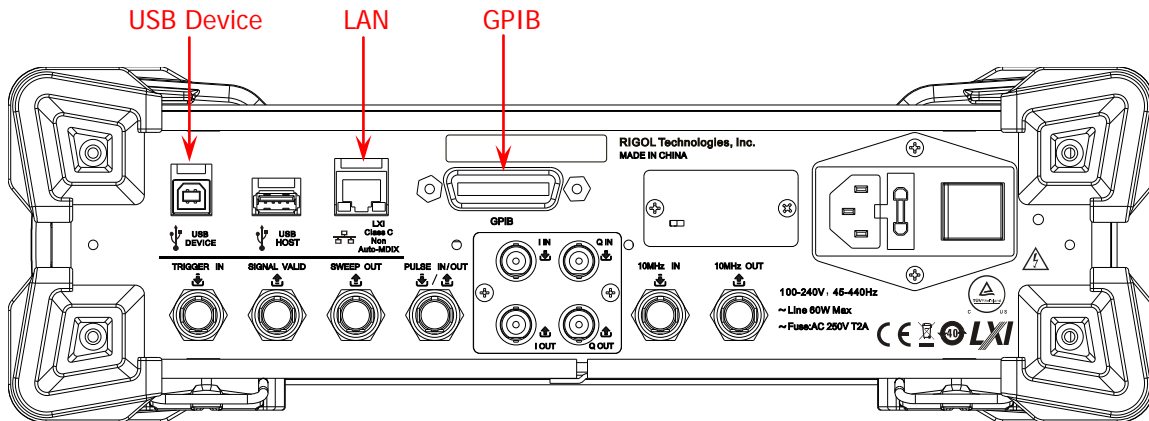

Figure 1-1 DSG3000 Communication Interfaces

(1) Use the USB interface:

Connect the USB Device interface at the rear panel of DSG3000 and the USB Host interface of the PC using USB cable.

(2) Use the LAN interface:

- Make sure that your PC is connected to the local network.
- Check whether your local network supports DHCP or auto IP mode. If not, you need to acquire the network interface parameters available, including the IP address, subnet mask, gateway and DNS.
- Connect DSG3000 to the local network using network cable.
- Press **System** → **I/O Config** → **LAN** to configure the IP address, subnet mask, gateway and DNS of the instrument.

(3) Use the GPIB interface:

- Connect the RF signal generator to the PC using GPIB cable.
- Press **System** → **I/O Config** → **GPIB** to set the GPIB address of the instrument.

3. Check whether the connection is successful

Start-up Ultra Sigma, search for the RF signal generator resource, right-click the resource name and then select "SCPI Panel Control" from the pop-up menu. Enter the correct command in the pop-up SCPI control panel and click **Send Command**, **Read Response** or **Send&Read** to check whether the connection is successful, as shown in the figure below (take the USB interface as an example).

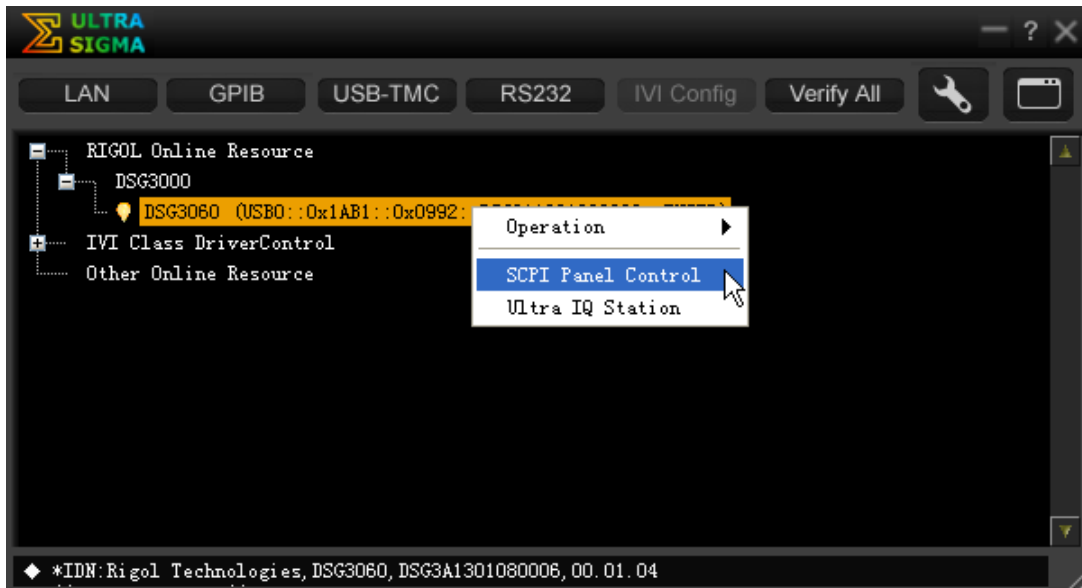

Remote Control Methods

1. User-defined programming

You can program and control DSG3000 using the SCPI (Standard Commands for Programmable Instruments) commands listed in chapter 2 [Command System](#) in various development environments (such as Visual C++, Visual Basic and LabVIEW). For details, refer to the introductions in chapter 4 [Programming Demos](#).

2. Send SCPI commands via PC software

You can use the PC software Ultra Sigma (from **RIGOL**) to send SCPI commands to control DSG3000 remotely.

SCPI Command Overview

SCPI (Standard Commands for Programmable Instruments) is standardized instrument programming language that is based on the standard IEEE488.1 and IEEE488.2 and conforms to various standards (such as the floating point operation rule in IEEE754 standard, ISO646 7-bit coded character for information interchange (equivalent to ASCII programming)). This chapter describes the syntax, symbol, parameter and abbreviation rules of the SCPI commands.

Syntax

SCPI commands present a hierarchical tree structure and have multiple sub-systems, each of which contains a root keyword and one or more sub-keywords. The command string usually begins with ":"; the keywords are separated by ":" and are followed by the parameter settings available; "?" is added at the end of the command string to indicate query; space is used to separate the command and parameter.

For example,

```
:SYSTem:COMMunication:LAN:IP:ADDRESS <value>
:SYSTem:COMMunication:LAN:IP:ADDRESS?
```

SYSTem is the root keyword of the command above. COMMunication, LAN, IP and ADDRESS are the second-level, third-level, forth-level and fifth-level keywords separately. The command string begins with ":" which is also used to separate the multi-level keywords. <value> denotes the parameter available for setting. "?" denotes query and DSG3000 returns the response information (the output value or internal setting value of the instrument) when receiving a query command. The command :SYSTem:COMMunication:LAN:IP:ADDRESS and parameter <value> are separated by a space.

"," is generally used for separating different parameters contained in the same command, for example, [:SOURce]:SWEep:LIST:ADDList <Freq>,<Ampt>,<Time>

Symbol Description

The following four symbols are not the content of SCPI commands but are usually used to describe the parameters in the commands.

1. Braces { }

Multiple optional parameters are enclosed in the braces and one of the parameters must be selected when sending the command.

2. Vertical Bar |

The vertical bar is used to separate multiple parameters. When you send a command, one of the parameters should be selected. For example, :SYSTem:LANGuage CHINese|ENGLish.

3. Square Brackets []

The content (such as keywords) enclosed in the square brackets could be omitted. If the content is omitted, the instrument would set it to the default. For example, [:SOURce]:PHASe:STEP[:INCRement]? Sending any of the four commands below can generate the same effect.

```
:PHASe:STEP?
:PHASe:STEP:INCRement?
:SOURce:PHASe:STEP?
:SOURce:PHASe:STEP:INCRement?
```

4. Triangle Brackets < >

The parameter enclosed in the triangle brackets must be replaced by an effective value. For example, send the [:SOURce]:FREQuency <value> command in :FREQuency 4MHz form.

Parameter Type

The parameters of the commands introduced in this manual contains 5 types: bool, integer, real number, discrete and ASCII string.

1. Bool

The parameter could be OFF, ON, 0 or 1. For example, [:SOURce]:AM:STATe ON|OFF|1|0

2. Integer

Unless otherwise noted, the parameter can be any integer within the effective value range. Note that do not set the parameter to a decimal; otherwise, errors will occur. For example, in the :SYSTem:BRIGHtness <value> command, <value> can be any integer from 0 to 7.

3. Real Number

Unless otherwise noted, the parameter can be any real number within the effective value range. For example, the range of <value> in the [:SOURce]:AM:FREQuency <value> command is from 100mHz to 1MHz.

4. Discrete

The parameter could only be one of the specified values or characters. For example, in the [:SOURce]:AM:WAVEform SINE|SQUA command, the parameter can be SINE or SQUA.

5. ASCII String

The parameter should be the combinations of ASCII characters. For example, in the :MMEMory:SAVe <file_name> command, <file_name> is the filename of the file to be saved and can include Chinese characters (a Chinese character occupies two bytes), English characters and numbers. The filename cannot exceed 28 bytes.

Command Abbreviation

All the commands are case-insensitive and you can use any of them. If abbreviation is used, all the capital letters in the command must be written completely. For example, the :MMEMory:DISK:FORMat command can be abbreviated to :MMEM:DISK:FORM.

Chapter 2 Command System

This chapter introduces the syntax, function, parameter and using instruction of each DSG3000 command in A-Z order.

Main topics of this chapter:

- ◆ [IEEE488.2 Common Commands](#)
- ◆ [:MMEMory Commands](#)
- ◆ [:OUTPut Command](#)
- ◆ [:SOURce Commands](#)
- ◆ [:STATus Commands](#)
- ◆ [:SYSTem Commands](#)
- ◆ [:TRIGger Commands](#)
- ◆ [:UNIT Command](#)

IEEE488.2 Common Commands

The IEEE488.2 common commands are used to query the basic information about the instrument or execute common operations. These commands usually begin with "*", contain a 3-character keyword and relate to the status register.

Command List^[1]:

- ◆ [*CLS](#)
- ◆ [*ESE](#)
- ◆ [*ESR?](#)
- ◆ [*IDN?](#)
- ◆ [*OPT?](#)
- ◆ [*PSC](#)
- ◆ [*RST](#)
- ◆ [*SRE](#)
- ◆ [*STB?](#)
- ◆ [*TRG](#)
- ◆ [*WAI](#)

*CLS

Syntax *CLS

Description Clear all the event registers and the error queue.

*ESE

Syntax *ESE <value>

*ESE?

Description Set the enable register for the standard event status register.

Query the enable register for the standard event status register.

Parameter

Name	Type	Range	Default
<value>	Integer	0 to 255	0

Explanation The bit 1 and bit 6 of the standard event status register are not used and are always treated as 0, therefore, the range of <value> are the decimal numbers corresponding to the binary numbers ranging from 00000000 (0 in decimal) to 11111111 (255 in decimal) and of which the bit 1 and bit 6 are 0.

Return Format The query returns an integer which equals the sum of the weights of all the bits that have already been set in the register.

Example *ESE 16 /*Enable the bit 4 (16 in decimal) of the standard event status register*/
*ESE? /*The query returns 16*/

Note^[1]: In the "Command List" in this manual, the parameters in the setting commands and the query commands are not included and you can refer to the complete introductions of the commands in the text according to the keyword.

ESR?*Syntax** *ESR?**Description** Query and clear the event register for the standard event status register.**Explanation** The bit 1 and bit 6 of the standard event status register are not used and are always treated as 0. The range of the return value are the decimal numbers corresponding to the binary numbers ranging from 00000000 (0 in decimal) to 11111111 (255 in decimal) and of which the bit 1 and bit 6 are 0.**Return Format** The query returns an integer which equals the sum of the weights of all the bits that have already been set in the register.***IDN?****Syntax** *IDN?**Description** Query the ID string of the instrument.**Return Format** The query returns the ID string of the instrument, for example, Rigol Technologies,DSG3060,DSG3A1301080006,00.01.01.***OPT?****Syntax** *OPT?**Description** Query the option information of the instrument.**Explanation** The maximum length of the returned string is 255 characters.**Return Format** The query returns the option list: the option strings are separated by ",". For example, PUG,PMC,
The query returns 0: no option is installed.***PSC****Syntax** *PSC <value>

*PSC?

Description Retain or reset the settings of the status register

Query the "power-on-status-clear" flag of the status register.

Parameter

Name	Type	Range	Default
<value>	Bool	0 1	NULL

Explanation

- If <value> is 0, the instrument retains the settings of the status register.
- If <value> is 1, the instrument resets the settings of the status register.

Return Format The query returns 1 or 0.

RST*Syntax** *RST**Description** Restore the RF signal generator to the preset state (factory or user).**Related Command** [:SYSTem:PRESet](#)***SRE****Syntax** *SRE <value>

*SRE?

Description Set the enable register for the status byte register.

Query the enable register for the status byte register.

Parameter

Name	Type	Range	Default
<value>	Integer	0 to 255	0

Explanation The bit 0 and bit 1 of the status byte register are not used and are always treated as 0, therefore, the range of <value> are the decimal numbers corresponding to the binary numbers ranging from 00000000 (0 in decimal) to 11111111 (255 in decimal) and of which the bit 0 and bit 1 are 0.**Return Format** The query returns an integer which equals the sum of the weights of all the bits that have already been set in the register.**Example** *SRE 16 /*Enable the bit 4 (16 in decimal) of the status byte register */
*SRE? /*The query returns 16*/***STB?****Syntax** *STB?**Description** Query the event register for the status byte register. The value of the status byte register is set to 0 after this command is executed.**Explanation** The bit 0 and bit 1 of the status byte register are not used and are always treated as 0. The query returns the decimal numbers corresponding to the binary numbers ranging from 00000000 (0 in decimal) to 11111111 (255 in decimal) and of which the bit 0 and bit 1 are 0.**Return Format** The query returns an integer which equals the sum of the weights of all the bits that have already been set in the register.***TRG****Syntax** *TRG**Description** Trigger a pulse modulation, RF sweep or LF sweep-sine immediately.**Related Commands** [:TRIGger:LFOutput\[:IMMediate\]](#)
[:TRIGger:PULSe\[:IMMediate\]](#)
[:TRIGger\[:SWEep\]\[:IMMediate\]](#)

***WAI**

Syntax *WAI

Description Wait for the operation to finish.

Explanation The subsequent command can only be carried out after the current command has been executed.

:MMEMory Commands

The :MMEMory commands are used to store the file to the internal or external memory of the instrument, read or delete the specified file as well as query the disk information.

Command List:

- ◆ [:MMEMory:CATalog](#)
- ◆ [:MMEMory:CATalog:LENGth](#)
- ◆ [:MMEMory:COPI](#)
- ◆ [:MMEMory:DATA:IQ](#)
- ◆ [:MMEMory:DATA:IQ:LIST](#)
- ◆ [:MMEMory:DELeTe](#)
- ◆ [:MMEMory:DISK:FORMat](#)
- ◆ [:MMEMory:DISK:INFormation](#)
- ◆ [:MMEMory:FILEtype](#)
- ◆ [:MMEMory:LDISK:SPACe](#)
- ◆ [:MMEMory:LOAD](#)
- ◆ [:MMEMory:MDIRectory](#)
- ◆ [:MMEMory:MOVE](#)
- ◆ [:MMEMory:PNAME:EDIT](#)
- ◆ [:MMEMory:PNAME:STATe](#)
- ◆ [:MMEMory:SAVe](#)

:MMEMory:CATalog

Syntax :MMEMory:CATalog? <path>

Description Query all the files and folders under the specified path.

Parameter

Name	Type	Range	Default
<path>	ASCII string	Valid path	NULL

- Explanation**
- <path>: the local memory (D disk) or external memory (E disk) when USB storage device is detected by the USB Host interface at the rear panel, or the subdirectory under the D or E disk.
 - The query returns a list of all the files and folders in the directory specified by <path>.

Return Format NO.1 File Name: 1
NO.2 File Name: 4.STA

Example :MMEM:CAT? D:

:MMEMory:CATalog:LENGth

Syntax :MMEMory:CATalog:LENGth? <path>

Description Query the number of files and folders under the specified path.

Parameter	Name	Type	Range	Default
	<path>	ASCII string	Valid path	NULL

Explanation The parameter <path> can be the local memory (D disk) or external memory (E disk) when USB storage device is detected by the USB Host interface at the rear panel, or the subdirectory under the D or E disk.

Return Format The query returns an integer, for example, 2.

Example :MMEM:CAT:LENG? D: /*Query and return the number of files and folders in the D disk*/

:MMEMory:COpy

Syntax :MMEMory:COpy <file_source>,<file_destination>

Description Copy the file or folder specified by <file_source> to the destination path specified by <file_destination>.

Parameter	Name	Type	Range	Default
	<file_source>	ASCII string	The file or folder name to be copied	NULL
	<file_destination>	ASCII string	Valid destination path	NULL

Explanation

- The parameter <file_source> denotes the file or folder to be copied. The file or folder name must contain the path. The parameter <file_destination> indicates the destination path and does not include the filename.
- If the file or folder specified by <file_source> does not exist, the operation fails.
- If the destination path specified by <file_destination> does not exist, the copy operation fails.

Example :MMEM:COpy D:\1.sta, D:\

:MMEMory:DATA:IQ

Syntax :MMEMory:DATA:IQ <file_name>,<flag>,<num>{,<i0>,<q0>…<in>,<qn>}

Description Save and download the IQ waveform data to the instrument

Parameter

Name	Type	Explanation
<file_name>	ASCII string	The name of the wave table file downloaded into the instrument.
<flag>	Discrete	When the IQ data file exceeds 64kB, you should separately download the file package. 0—download the first data package; 1—download the subsequent packets; 2—download the last package and output IQ waveform.
<num>	Integer	The number of IQ data pairs.
{,<i0>,<q0>…<in>,<qn>}	Decimal number	IQ data pairs. The maximum of each data (e.g. i0) is two bytes.

Explanation When sending the command, you should add the data block starting with #9 flag to represent the total length of the IQ data before <i0>,<q0>…<in>,<qn>. For example, #9000000011 indicates the total length of the IQ data is 11 bytes. The value is calculated by the formula (the bytes of IQ data pairs + the number of bytes occupied by comma).

Example :MMEM:DATA:IQ test1,0,2,#9000000011 1,10,11,20

```
/*Save the current two pairs of IQ data with the test1 filename (the total length of
"1,10,11,20" is 11 bytes and expressed by #9000000011) and downloaded to
DSG3000*/
```

:MMEMory:DATA:IQ:LIST

Syntax :MMEMory:DATA:IQ:LIST?

Description Query the wave table file stored in the current root directory (D: disk) of the instrument.

Return Format Return wave table file list. The format is "wave table filename (*.arb),file size". For example,

```
16QAM.arb,16444,wave2.arb,16438,wave3.arb,16438,newwave.arb,16444,out3.arb
,4124,.
```

:MMEMory:DELeTe

Syntax :MMEMory:DELeTe <file_name>

Description Delete the specified file or folder under the specified operation path.

Parameter	Name	Type	Range	Default
	<file_name>	ASCII string	The name of the file or folder to be deleted	NULL

- Explanation**
- This command is valid only when the specified file or folder exists under the current operation path or the specified path.
 - The parameter <file_name> can be a file or folder name under the current operation path or the file or folder name containing the specified path, for example, :MMEM:DEL D:\NEW\3.sta.

Example :MMEM:DEL 8.sta /*Delete the file named 8.sta under the current operation path*/

:MMEMory:DISK:FORMat

Syntax :MMEMory:DISK:FORMat

Description Format the local disk (D disk).

:MMEMory:DISK:INFormation

Syntax :MMEMory:DISK:INFormation? <Disk>

Description Query the disk information.

Parameter	Name	Type	Range	Default
	<Disk>	ASCII string	D:	D:

Return Format The query returns the disk information including Disk Name, File System, Total Space, Used Space and Free Space, for example,

Disk:D:

File Sys:FAT32

Total:1.0 GB

Used:512 KB

Free:0.99 GB

Example :MMEM:DISK:INF? D: /*Query the D disk information*/

:MMEMory:FILEtype

Syntax :MMEMory:FILEtype
 ALL|TRNList|FLATness|SWPList|STATE|FLACsv|SWPCsv|REcorder|AMPCaList|TRN
 Csv|ARB
 :MMEMory:FILEtype?

Description Select the file type.

Query the current file type.

Parameter

Name	Type	Range	Default
ALL TRNList FLATness SWPList STATE FLACsv SWPCsv REcorder AMPCaList TRNCsv ARB	Discrete	ALL TRNList FLATness SWPList STATE FLACsv SWPCsv REcorder AMPCaList TRNCsv ARB	ALL

Explanation

- The file types available are all, train list, flatness, sweep list, state, flatness csv, sweep csv, record csv, amplitude calibration, train csv and Arb.
- After selecting the appropriate file type, you can view all files or save a new file of this file type.

Return Format The query returns ALL, TRNLIST, FLATNESS, SWPLIST, STATE, FLACSV, SWPCSV, RECORDER, AMPCALLIST, TRNCV or ARB.

Example :MMEM:FILE TRNList /*Set the file type to "train list"*/
 :MMEM:FILE? /*Query the current file type and the query returns
 TRNLIST*/

:MMEMory:LDISK:SPACE

Syntax :MMEMory:LDISK:SPACE?

Description Query the space information of the local disk (D disk).

Return Format The query returns the D disk space information including "Used space" and "Free space", for example, Used:512 k,Free:1048064 k.

:MMEMory:LOAD

Syntax :MMEMory:LOAD <file_name>

Description Read the specified file in the specified operation path.

Parameter

Name	Type	Range	Default
<file_name>	ASCII string	The name of the file to be read	NULL

Explanation

- This command is valid only when the specified file exists under the current operation path or the specified path.
- The parameter <file_name> can be a file name under the current operation path and the file name containing the specified path, for example, :MMEM:LOAD D:\NEW\1.trn.

Example :MMEM:LOAD 1.trn /*Read the file named 1.trn under the current operation
 path*/

:MMEMory:MDIRectory

Syntax :MMEMory:MDIRectory <directory_name>

Description Create a new folder under the specified operation path.

Parameter	Name	Type	Range	Default
	<directory_name>	ASCII string	The name of the folder to be created	NULL

- Explanation**
- The folder name can include Chinese characters (a Chinese character occupies two bytes), English characters or numbers. The folder name cannot exceed 28 bytes.
 - If the name of the folder to be created already exists, this operation is invalid. At this point, "The filename already exists" is displayed in the user interface.
 - The parameter <directory_name> can be a new folder name that not contains the path which denotes creating a folder under the current operation path, or a folder name containing the specified path that denotes creating a new folder under the specified path, for example, :MMEM:MDIR D:\1\NEW.

Example :MMEM:MDIR NEW /*Create a folder named NEW under the current operation path */

:MMEMory:MOVE

Syntax :MMEMory:MOVE <file_source>,<file_destination>

Description Rename the file or folder specified by <file_source> to the destination file or folder name specified by <file_destination>.

Parameter	Name	Type	Range	Default
	<file_source>	ASCII string	Valid file or folder name	NULL
	<file_destination>			

- Explanation**
- The file or folder name specified by <file_source> and <file_destination> must contain the path.
 - If the file or folder specified by <file_source> does not exist, the rename operation fails.
 - If the destination file or folder name specified by <file_destination> already exists under the current path, the rename operation fails.

Example :MMEM:MOVE D:\1.sta, D:\2.sta

:MMEMory:PNAME:EDIT

Syntax :MMEMory:PNAME:EDIT <pre_name>
:MMEMory:PNAME:EDIT?

Description Edit and save the filename prefix.

Query the filename prefix saved.

Parameter	Name	Type	Range	Default
	<pre_name>	ASCII string	The filename prefix to be edited	NULL

Explanation You can edit any prefix name.

Return Format The query returns the filename prefix, for example, N.

Example :MMEM:PNAME:EDIT N /*Set the filename prefix to N*/
:MMEM:PNAME:EDIT? /*The query returns N*/

Related Command [:MMEMory:PNAME:STATE](#)

:MMEMory:PNAME:STATE

Syntax :MMEMory:PNAME:STATE ON|OFF|1|0
:MMEMory:PNAME:STATE?

Description Enable or disable the filename prefix.

Query the current on/off state of the filename prefix.

Parameter	Name	Type	Range	Default
	ON OFF 1 0	Bool	ON OFF 1 0	OFF

Explanation

- You can select "On" or "Off" to enable or disable the prefix edited.
- When "On" is selected, the edited prefix will be added to the filename input box automatically when saving file.

Return Format The query returns 0 or 1.

Example :MMEM:PNAME:STATE ON
:MMEM:PNAME:STATE?

Related Command [:MMEMory:PNAME:EDIT](#)

:MMEMory:SAVe

Syntax :MMEMory:SAVe <File_name>

Description Save the file with the specified filename under the current operation path.

Parameter	Name	Type	Range	Default
	<file_name>	ASCII string	The name of the file to be saved	NULL

- Explanation**
- The filename can include Chinese characters (a Chinese character occupies two bytes), English characters or numbers. The filename cannot exceed 28 bytes.
 - When the current path already contains a file with the same name, this command will directly overwrite the original file.

Example :MMEM:SAV SET.sta /*Save the current instrument state with the SET.sta filename under the current operation path*/

:OUTPut Command

Command List:

◆ [:OUTPut](#)

:OUTPut[:STATe]

Syntax :OUTPut[:STATe] ON|OFF|1|0
:OUTPut[:STATe]?

Description Turn on or off the RF output.

Query the on/off state of the RF output.

Parameter

Name	Type	Range	Default
ON OFF 1 0	Bool	ON OFF 1 0	OFF

- Explanation**
- ON: turn on the RF output. At this point, the backlight of **RF** output control key goes on.
 - OFF: turn off the RF output. At this point, the backlight of **RF** output control key goes out.

Return Format Return 1 or 0.

Example :OUTP ON /*Turn on the RF output*/
:OUTP? /*The query returns 1*/

:SOURce Commands

The :SOURce commands are used to set the related parameters of the main functions of the RF signal generator including the frequency, level, phase, flatness, AM, FM/ØM, Pulse, SWEEP, LF output and so on.

Command List:

- ◆ [\[:SOURce\]:AM Command Subsystem](#)
- ◆ [\[:SOURce\]:CORRection Command Subsystem](#)
- ◆ [\[:SOURce\]:FM Command Subsystem](#)
- ◆ [\[:SOURce\]:FMPM:TYPE](#)
- ◆ [\[:SOURce\]:FREQuency Command Subsystem](#)
- ◆ [\[:SOURce\]:INPut:TRIGger:SLOPe](#)
- ◆ [\[:SOURce\]:IQ Command Subsystem](#)
- ◆ [\[:SOURce\]:LEVel Command Subsystem](#)
- ◆ [\[:SOURce\]:LFOutput Command Subsystem](#)
- ◆ [\[:SOURce\]:MODulation:STATe](#)
- ◆ [\[:SOURce\]:PHASe Command Subsystem](#)
- ◆ [\[:SOURce\]:PM Command Subsystem](#)
- ◆ [\[:SOURce\]:PULM Command Subsystem](#)
- ◆ [\[:SOURce\]:SWEep Command Subsystem](#)

[:SOURce]:AM Command Subsystem

Command List:

- ◆ [\[:SOURce\]:AM:DEPTH](#)
- ◆ [\[:SOURce\]:AM:DEPTH:STEP\[:INCRement\]](#)
- ◆ [\[:SOURce\]:AM:FREQuency](#)
- ◆ [\[:SOURce\]:AM:FREQuency:STEP\[:INCRement\]](#)
- ◆ [\[:SOURce\]:AM:SOURce](#)
- ◆ [\[:SOURce\]:AM:STATe](#)
- ◆ [\[:SOURce\]:AM:WAVEform](#)

[[:SOURce]:AM:DEPT

Syntax [[:SOURce]:AM:DEPT <value>

[[:SOURce]:AM:DEPT?

Description Set the AM modulation depth.

Query the AM modulation depth.

Parameter	Name	Type	Range	Default
	<value>	Integer	0 to 100	50

- Explanation**
- When selecting "Int" modulation source, the AM modulation depth (m_a) and amplitude difference (ΔP_{sb}) between the carrier and sidebands satisfy the following relation: $\Delta P_{sb} = 6 - 20 \lg m_a$.
 - <value> can also be expressed as percentage, for example, 80%.
 - After the modulation depth is set, you can use the up/down direction keys or knob to modify the modulation depth at the current step. You can query or set the current step using the [\[:SOURce\]:AM:DEPT:STEP\[:INCRement\]](#) command.

Return Format The query returns the modulation depth, for example, 80.00.

Example :AM:DEPT 80

:AM:DEPT?

Related Command [\[:SOURce\]:AM:DEPT:STEP\[:INCRement\]](#)

[[:SOURce]:AM:DEPT:STEP[:INCRement]

Syntax [[:SOURce]:AM:DEPT:STEP[:INCRement] <value>

[[:SOURce]:AM:DEPT:STEP[:INCRement]?

Description Set the AM modulation depth step.

Query the AM modulation depth step.

Parameter	Name	Type	Range	Default
	<value>	Integer	0.1 to 50	10

- Explanation**
- <value> can also be expressed as percentage, for example, 0.15%.
 - After the modulation depth step is set, you can use the up/down direction keys or knob to modify the modulation depth at the current step. At this point, you can query or set the modulation depth using the [\[:SOURce\]:AM:DEPT](#) command.

Return Format The query returns the modulation depth step, for example, 0.15.

Example AM:DEPT:STEP:INCR 0.15

AM:DEPT:STEP:INCR?

Related Command [\[:SOURce\]:AM:DEPT](#)

[[:SOURce]:AM:FREQuency]

Syntax [[:SOURce]:AM:FREQuency <value>

[[:SOURce]:AM:FREQuency?

Description Set the AM modulation frequency.

Query the AM modulation frequency.

Parameter	Name	Type	Range	Default
	<value>	Integer	100mHz to 1MHz (Sine)/ 100mHz to 20kHz (Square)	10kHz

- Explanation**
- When <value> is set in "Number" form, the default unit is Hz, for example, 20000. In addition, <value> can also be set in "Number + Unit" form, for example, 20kHz.
 - The default unit of the return value is Hz.
 - After the modulation frequency is set, you can use the up/down direction keys or knob to modify the modulation frequency at the current step. You can query or set the current step using the [\[\[:SOURce\]:AM:FREQuency:STEP\[:INCRement\]\]](#) command.
 - When "Ext" modulation source is selected, this operation is invalid.

Return Format The query returns the AM modulation frequency, for example, 20000.

Example :AM:FREQ 20kHz

:AM:FREQ?

Related Commands [\[\[:SOURce\]:AM:FREQuency:STEP\[:INCRement\]\]](#)
[\[\[:SOURce\]:AM:SOURce\]](#)

[[:SOURce]:AM:FREQuency:STEP[:INCRement]]

Syntax [[:SOURce]:AM:FREQuency:STEP[:INCRement] <value>

[[:SOURce]:AM:FREQuency:STEP[:INCRement]?

Description Set the AM modulation frequency step.

Query the AM modulation frequency step.

Parameter	Name	Type	Range	Default
	<value>	Integer	100mHz to 500kHz	1kHz

- Explanation**
- When <value> is set in "Number" form, the default unit is Hz. In addition, <value> can also be set in "Number + Unit" form, for example, 3.55kHz.
 - The default unit of the return value is Hz.
 - After the modulation frequency step is set, you can use the up/down direction keys or knob to modify the modulation frequency at the current step. At this point, you can query or set the modulation frequency using the [\[\[:SOURce\]:AM:FREQuency\]](#) command.

Return Format The query returns the AM modulation frequency step, for example, 3550.

Example :AM:FREQ:STEP 3.55kHz

:AM:FREQ:STEP?

Related Command [\[\[:SOURce\]:AM:FREQuency\]](#)

[[:SOURce]:AM:SOURce

Syntax [[:SOURce]:AM:SOURce EXTernal|INTernal|INTernal,EXTernal

[[:SOURce]:AM:SOURce?

Description Select the AM modulation source.

Query the AM modulation source.

Parameter

Name	Type	Range	Default
EXTernal INTernal INTernal,EXTernal	Discrete	EXTernal INTernal INTernal,EXTernal	INTernal

Explanation

- EXTernal: select "Ext" modulation source. At this point, the external modulating signal is input from the **[EXT MOD INPUT]** connector.
- INTernal: select "Int" modulation source. At this point, the instrument provides the modulating signal and you can set the modulation frequency and modulation waveform of the modulating signal. In addition, when the AM and **[MOD]** switches are both enabled, you can set the amplitude of the modulating signal via the [\[:SOURce\]:LFOutput:LEVel](#) command.
- INTernal,EXTernal: select the "Int + Ext" modulation source. At this point, you can operate both the internal and external modulating sources. For example, perform dual-tone AM signal modulation.

Return Format The query returns the type of the AM modulation source. For example, EXT.

Example :AM:SOUR EXT

:AM:SOUR?

Related Commands [\[:SOURce\]:AM:FREQuency](#)
[\[:SOURce\]:AM:WAVEform](#)
[\[:SOURce\]:LFOutput:LEVel](#)

[[:SOURce]:AM:STATe

Syntax [[:SOURce]:AM:STATe ON|OFF|1|0

[[:SOURce]:AM:STATe?

Description Set the AM switch state.

Query the AM switch state.

Parameter

Name	Type	Range	Default
ON OFF 1 0	Bool	ON OFF 1 0	OFF

Explanation

- ON: turn on the AM switch and enable the AM function.
- OFF: turn off the AM switch and disable the AM function.

Return Format Return 1 or 0.

Example :AM:STAT ON /*Turn on the AM switch*/

:AM:STAT? /*The query returns 1*/

[[:SOURce]:AM:WAVEform

Syntax [[:SOURce]:AM:WAVEform SINE|SQUA
[:SOURce]:AM:WAVEform?

Description Select the AM modulation waveform.
Query the AM modulation waveform.

Parameter	Name	Type	Range	Default
	SINE SQUA	Discrete	SINE SQUA	SINE

Explanation ➤ The parameter "SINE|SQUA" can set the AM modulation waveform to "Sine" or "Square".
➤ When "Ext" modulation source is selected, this command is invalid.

Return Format The query returns SINE or SQUA.

Example :AM:WAVE SQUA
:AM:WAVE?

Related Command [\[:SOURce\]:AM:SOURce](#)

[[:SOURce]:CORRection Command Subsystem**Command List:**

- ◆ [\[:SOURce\]:CORRection:FLATness:COUNT](#)
- ◆ [\[:SOURce\]:CORRection:FLATness:DELeTe](#)
- ◆ [\[:SOURce\]:CORRection:FLATness:LIST](#)
- ◆ [\[:SOURce\]:CORRection:FLATness:PAIR](#)
- ◆ [\[:SOURce\]:CORRection:FLATness\[:STATe\]](#)

[[:SOURce]:CORRection:FLATness:COUNT

Syntax [[:SOURce]:CORRection:FLATness:COUNT?

Description Query the number of points of the current flatness correction table.

Explanation You can use the [\[:SOURce\]:CORRection:FLATness:DELeTe](#) command to reduce the number of points in the table or the [\[:SOURce\]:CORRection:FLATness:PAIR](#) command to increase the number of points in the table.

Return Format The query returns the number of points in the flatness table in integer. For example, 5.

Related Commands [\[:SOURce\]:CORRection:FLATness:DELeTe](#)
[\[:SOURce\]:CORRection:FLATness:PAIR](#)

[[:SOURce]:CORRection:FLATness:DELeTe

Syntax [[:SOURce]:CORRection:FLATness:DELeTe <Row>

Description Delete a correction point in the flatness table.

Parameter	Name	Type	Range	Default
	<Row>	Integer	1 to the total number of rows in the current table	NULL

- Explanation**
- <Row> represents the row number of the flatness table. The total number of rows is the total number of correction points in the flatness table.
 - Each correction point corresponds to a frequency and amplitude.
 - You can use this command to reduce the number of rows or use the [\[\[:SOURce\]:CORRection:FLATness:PAIR](#) command to increase the number of points in the table.

Example :CORR:FLAT:DEL 2 /*Delete the 2nd row of the flatness correction table*/

Related Commands [\[\[:SOURce\]:CORRection:FLATness:COUNT](#)
[\[\[:SOURce\]:CORRection:FLATness:PAIR](#)

[[:SOURce]:CORRection:FLATness:LIST

Syntax [[:SOURce]:CORRection:FLATness:LIST? <Start>,<Count>

Description Query the flatness correction table data within the specified range.

Parameter	Name	Type	Range	Default
	<Start>	Integer	1 to the total number of rows in the current table	NULL
	<Count>	Integer	1 to the total number of rows in the current table	NULL

- Explanation**
- <Start>: the number of the start row of the data to be acquired.
 - <Count>: the total number of rows of the data to be acquired.

Return Format The query returns the flatness table data acquired, for example,

NO.1:2000000.000000 , 9.000000

NO.2:2500000.000000 , 10.000000

Example :CORR:FLAT:LIST? 2,2 /*Query two rows of correction data starting from the 2nd row of the flatness table and the query returns 2 rows of correction data*/

Related Command [\[\[:SOURce\]:CORRection:FLATness:COUNT](#)

[[:SOURce]:CORRection:FLATness:PAIR

Syntax [[:SOURce]:CORRection:FLATness:PAIR <Freq>,<Ampt>

Description Set the correction point pair in the flatness table.

Parameter	Name	Type	Range	Default
	<Freq>	Real	9kHz to 6GHz	6GHz
	<Ampt>	Real	-100dB to 100dB	NULL

- Explanation**
- You can use this command to edit the frequency and amplitude of the row currently selected in the flatness table.
 - <Freq>: set the frequency of the correction point.
 - <Ampt>: set the amplitude corresponding to the frequency point.

Example :CORR:FLAT:PAIR 2.5M,10 /*Set the frequency of the row currently selected to 2.5MHz and the amplitude to 10dB*/

[[:SOURce]:CORRection:FLATness[:STATe]

Syntax [[:SOURce]:CORRection:FLATness[:STATe] ON|OFF|1|0
[:SOURce]:CORRection:FLATness[:STATe]?

Description Turn on or off the flatness correction switch.

Query the state of the flatness correction switch.

Parameter	Name	Type	Range	Default
	ON OFF 1 0	Bool	ON OFF 1 0	OFF

Return Format The query returns 1 or 0.

Example :CORR:FLAT ON /*Turn on the flatness correction function*/
:CORR:FLAT? /*The query returns 1*/

[[:SOURce]:FM Command Subsystem**Command List:**

- ◆ [\[:SOURce\]:FM:DEVIation](#)
- ◆ [\[:SOURce\]:FM:DEVIation:STEP\[:INCRement\]](#)
- ◆ [\[:SOURce\]:FM:FREQuency](#)
- ◆ [\[:SOURce\]:FM:FREQuency:STEP\[:INCRement\]](#)
- ◆ [\[:SOURce\]:FM:SOURce](#)
- ◆ [\[:SOURce\]:FM:STATe](#)
- ◆ [\[:SOURce\]:FM:WAVEform](#)

[[:SOURce]:FM:DEVIation]

Syntax [[:SOURce]:FM:DEVIation <value>

[[:SOURce]:FM:DEVIation?

Description Set the FM frequency deviation.

Query the FM frequency deviation.

Parameter

Name	Type	Range	Default
<value>	Real	100mHz to 4MHz	10kHz

- Explanation**
- When <value> is set in "Number" form, the default unit is Hz, for example, 20000. In addition, <value> can also be set in "Number + Unit" form, for example, 20kHz.
 - The default unit of the return value is Hz.
 - After the frequency deviation is set, you can use the up/down direction keys or knob to modify the deviation at the current step. You can query or set the current step using the [\[\[:SOURce\]:FM:DEVIation:STEP\[:INCRement\]\]](#) command.

Return Format The query returns the FM frequency deviation, for example, 20000.

Example :FM:DEV 20kHz

:FM:DEV?

Related Command [\[\[:SOURce\]:FM:DEVIation:STEP\[:INCRement\]\]](#)

[[:SOURce]:FM:DEVIation:STEP[:INCRement]]

Syntax [[:SOURce]:FM:DEVIation:STEP[:INCRement] <value>

[[:SOURce]:FM:DEVIation:STEP[:INCRement]?

Description Set the FM frequency deviation step.

Query the FM frequency deviation step.

Parameter

Name	Type	Range	Default
<value>	Real	10mHz to 2MHz	10kHz

- Explanation**
- When <value> is set in "Number" form, the default unit is Hz, for example, 5000. In addition, <value> can also be set in "Number + Unit" form, for example, 5kHz.
 - The default unit of the return value is Hz.
 - After the frequency deviation step is set, you can use the up/down direction keys or knob to modify the deviation at the current step. At this point, You can query or set the current frequency deviation using the [\[\[:SOURce\]:FM:DEVIation\]](#) command.

Return Format The query returns the FM frequency deviation step, for example, 5000.

Example :FM:STEP:INCR 5kHz

:FM:STEP:INCR?

Related Command [\[\[:SOURce\]:FM:DEVIation\]](#)

[[:SOURce]:FM:FREQuency]

Syntax [:SOURce]:FM:FREQuency <value>

[:SOURce]:FM:FREQuency?

Description Set the FM modulation frequency.

Query the FM modulation frequency.

Parameter	Name	Type	Range	Default
	<value>	Real	100mHz to 1MHz (Sine)/ 100mHz to 20kHz (Square)	10kHz

- Explanation**
- When <value> is set in "Number" form, the default unit is Hz, for example, 20000. In addition, <value> can also be set in "Number + Unit" form, for example, 20kHz.
 - The default unit of the return value is Hz.
 - After the modulation frequency is set, you can use the up/down direction keys or knob to modify the modulation frequency at the current step. You can query or set the current step using the [\[:SOURce\]:FM:FREQuency:STEP\[:INCRement\]](#) command.
 - When selecting "Ext" modulation source, this operation is invalid.

Return Format The query returns the FM modulation frequency, for example, 20000.

Example :FM:FREQ 20kHz

:FM:FREQ?

Related Commands [\[:SOURce\]:FM:FREQuency:STEP\[:INCRement\]](#)
[\[:SOURce\]:FM:SOURce](#)

[[:SOURce]:FM:FREQuency:STEP[:INCRement]]

Syntax [:SOURce]:FM:FREQuency:STEP[:INCRement] <value>

[:SOURce]:FM:FREQuency:STEP[:INCRement]?

Description Set the FM modulation frequency step.

Query the FM modulation frequency step.

Parameter	Name	Type	Range	Default
	<value>	Real	100mHz to 500kHz	1kHz

- Explanation**
- When <value> is set in "Number" form, the default unit is Hz, for example, 5000. In addition, <value> can also be set in "Number + Unit" form, for example, 5kHz.
 - The default unit of the return value is Hz.
 - After the modulation frequency step is set, you can use the up/down direction keys or knob to modify the modulation frequency at the current step. At this point, you can query or set the modulation frequency using the [\[:SOURce\]:FM:FREQuency](#) command.

Return Format The query returns the FM modulation frequency step, for example, 5000.

Example :FM:FREQ:STEP 5kHz

:FM:FREQ:STEP?

Related Command [\[:SOURce\]:FM:FREQuency](#)

[[:SOURce]:FM:SOURce

Syntax [:SOURce]:FM:SOURce EXTernal|INTernal|INTernal,EXTernal
[:SOURce]:FM:SOURce?

Description Select the FM modulation source.

Query the FM modulation source.

Parameter	Name	Type	Range	Default
	EXTernal INTernal INTernal,EXTernal	Discrete	EXTernal INTernal INTernal,EXTernal	INTernal

- Explanation**
- EXTernal: select "Ext" modulation source. At this point, the external modulating signal is input from the **[EXT MOD INPUT]** connector.
 - INTernal: select "Int" modulation source. At this point, the instrument provides the modulating signal and you can set the modulation frequency and modulation waveform of the modulating signal. In addition, when the FM and **[MOD]** switches are both enabled, you can set the amplitude of the modulating signal via the [\[:SOURce\]:LFOutput:LEVel](#) command.
 - INTernal,EXTernal: select "Int + Ext" modulation source. At this point, you can operate both the internal and external modulating sources.

Return Format The query returns the type of FM modulation source. For example, INT.

Example :FM:SOUR INT
:FM:SOUR?

Related Commands [\[:SOURce\]:FM:FREQuency](#)
[\[:SOURce\]:FM:WAVEform](#)
[\[:SOURce\]:LFOutput:LEVel](#)

[[:SOURce]:FM:STATe

Syntax [:SOURce]:FM:STATe ON|OFF|1|0
[:SOURce]:FM:STATe?

Description Set the FM switch state.

Query the FM switch state.

Parameter	Name	Type	Range	Default
	ON OFF 1 0	Bool	ON OFF 1 0	OFF

- Explanation**
- ON: turn on the FM switch and enable the FM function.
 - OFF: turn off the FM switch and disable the FM function.

Return Format The query returns 1 or 0.

Example :FM:STAT ON /* Turn on the FM switch */
:FM:STAT? /*The query returns 1*/

[[:SOURce]:FM:WAVEform

Syntax [:SOURce]:FM:WAVEform SINE|SQUA
[:SOURce]:FM:WAVEform?

Description Select the FM modulation waveform.
Query the FM modulation waveform.

Parameter	Name	Type	Range	Default
	SINE SQUA	Discrete	SINE SQUA	SINE

Explanation ➤ The parameter "SINE|SQUA" can set the FM modulation waveform to "Sine" or "Square".
➤ When "Ext" modulation source is selected, this command is invalid.

Return Format The query returns SINE or SQUA.

Example :FM:WAVE SQUA
:FM:WAVE?

Related Command [\[:SOURce\]:FM:SOURce](#)

[[:SOURce]:FM:TYPE

Syntax [:SOURce]:FM:TYPE FM|PM
[:SOURce]:FM:TYPE?

Description Select the current modulation type of **FM/øM**.
Query the current modulation type of **FM/øM**.

Parameter	Name	Type	Range	Default
	FM PM	Discrete	FM PM	PM

Explanation The parameter "FM|PM" can set the modulation type of the current operation to "FM" or "PM".

Return Format The query returns FM or PM.

Example :FM:TYPE FM
:FM:TYPE?

[[:SOURce]:FREQuency Command Subsystem**Command List:**

- ◆ [\[:SOURce\]:FREQuency](#)
- ◆ [\[:SOURce\]:FREQuency:OFFSet](#)
- ◆ [\[:SOURce\]:FREQuency:OFFSet:STEP](#)
- ◆ [\[:SOURce\]:FREQuency:STEP](#)

[[:SOURce]:FREQUENCY

Syntax [[:SOURce]:FREQUENCY <value>

[[:SOURce]:FREQUENCY?

Description Set the RF output frequency.

Query the RF output frequency.

Parameter

Name	Type	Range	Default
<value>	Real	9kHz to 6GHz	6GHz

- Explanation**
- When <value> is set in "Number" form, the default unit is Hz, for example, 4000000. In addition, <value> can also be set in "Number + Unit" form, for example, 4MHz.
 - The default unit of the return value is Hz.
 - After the RF frequency is set, you can use the up/down direction keys or knob to modify the frequency at the current step. You can query or set the current step using the [\[:SOURce\]:FREQUENCY:STEP](#) command.
 - When the frequency offset is 0 Hz, the frequency displayed in the interface (namely the setting frequency) is equal to the actual output frequency.
 - When the frequency offset is not 0 Hz, the output frequency is determined by the setting frequency and frequency offset. The three parameters satisfy the equation: setting frequency (display frequency) = output frequency + frequency offset. You can use the [\[:SOURce\]:FREQUENCY:OFFSet](#) command to query and set the RF frequency offset.

Return Format The query returns the RF frequency, for example, 4000000.

Example :FREQ 4MHz

:FREQ?

Related [\[:SOURce\]:FREQUENCY:STEP](#)

Commands [\[:SOURce\]:FREQUENCY:OFFSet](#)

[[:SOURce]:FREQuency:OFFSet

Syntax [[:SOURce]:FREQuency:OFFSet <value>

[[:SOURce]:FREQuency:OFFSet?

Description Set the RF frequency offset.

Query the RF frequency offset.

Parameter

Name	Type	Range	Default
<value>	Real	-20GHz to 20GHz	0Hz

Explanation

- When <value> is set in "Number" form, the default unit is Hz, for example, 20000. In addition, <value> can also be set in "Number + Unit" form, for example, 20kHz.
- The default unit of the return value is Hz.
- After the RF frequency offset is set, you can use the up/down direction keys or knob to modify the offset at the current step. You can query or set the current step using the [\[:SOURce\]:FREQuency:OFFSet:STEP](#) command.
- When the frequency offset is 0 Hz, the frequency displayed in the interface (namely the setting frequency) is equal to the actual output frequency.
- When the frequency offset is not 0 Hz, the output frequency is determined by the setting frequency and frequency offset. The three parameters satisfy the equation: setting frequency (display frequency) = output frequency + frequency offset. You can use the [\[:SOURce\]:FREQuency](#) command to query and set the RF frequency.

Return Format The query returns the RF frequency offset, for example, 20000.

Example :FREQ:OFFS 20kHz

:FREQ:OFFS?

Related Commands [\[:SOURce\]:FREQuency:OFFSet:STEP](#)
[\[:SOURce\]:FREQuency](#)

[[:SOURce]:FREQuency:OFFSet:STEP

Syntax [[:SOURce]:FREQuency:OFFSet:STEP <value>

[[:SOURce]:FREQuency:OFFSet:STEP?

Description Set the RF frequency offset step.

Query the RF frequency offset step.

Parameter	Name	Type	Range	Default
	<value>	Real	10mHz to 10GHz	100MHz

- Explanation**
- When <value> is set in "Number" form, the default unit is Hz, for example, 5000. In addition, <value> can also be set in "Number + Unit" form, for example, 5kHz.
 - The default unit of the return value is Hz.
 - After the frequency offset step is set, you can use the up/down direction keys or knob to modify the frequency offset at the current step. At this point, you can query or set the frequency offset using the [\[:SOURce\]:FREQuency:OFFSet](#) command.

Return Format The query returns the RF frequency offset step, for example, 5000.

Example :FREQ:OFFS:STEP 5kHz

:FREQ:OFFS:STEP?

Related Command [\[:SOURce\]:FREQuency:OFFSet](#)

[[:SOURce]:FREQuency:STEP

Syntax [[:SOURce]:FREQuency:STEP <value>

[[:SOURce]:FREQuency:STEP?

Description Set the RF output frequency step.

Query the RF output frequency step.

Parameter	Name	Type	Range	Default
	<value>	Real	10mHz to 1GHz	100MHz

- Explanation**
- When <value> is set in "Number" form, the default unit is Hz, for example, 3000. In addition, <value> can also be set in "Number + Unit" form, for example, 3kHz.
 - The default unit of the return value is Hz.
 - After the RF frequency step is set, you can use the up/down direction keys or knob to modify the frequency at the current step. At this point, you can query or set the frequency using the [\[:SOURce\]:FREQuency](#) command.

Return Format The query returns the RF frequency step, for example, 3000.

Example :FREQ:STEP 3kHz

:FREQ:STEP?

Related Command [\[:SOURce\]:FREQuency](#)

[:SOURce]:INPut:TRIGger:SLOPe

Syntax [:SOURce]:INPut:TRIGger:SLOPe POSitive|NEGative
[:SOURce]:INPut:TRIGger:SLOPe?

Description Set the polarity of the external trigger signal.

Query the polarity of the external trigger signal.

Parameter

Name	Type	Range	Default
POSitive NEGative	Discrete	POSitive NEGative	POSitive

- Explanation**
- This command is valid only when the trigger mode of **SWEEP** or "Swp-Sine" of LF output is "Ext".
 - The external trigger signal is input from the **[TRIGGER IN]** connector at the rear panel.

Return Format The query returns POS or NEG.

Example :INP:TRIG:SLOP POS
:INP:TRIG:SLOP?

[:SOURce]:IQ Command Subsystem

Command List^[2]:

- ◆ [\[:SOURce\]:IQ:BASEout:LEVel](#)
- ◆ [\[:SOURce\]:IQ:BASEout:LEVel:STEP](#)
- ◆ [\[:SOURce\]:IQ:BASEout:STATe](#)
- ◆ [\[:SOURce\]:IQ:MODE](#)
- ◆ [\[:SOURce\]:IQ:MODE:STATe](#)
- ◆ [\[:SOURce\]:IQ:SAMPlE](#)
- ◆ [\[:SOURce\]:IQ:SAMPlE:STEP](#)
- ◆ [\[:SOURce\]:IQ:TRIGger:ARB](#)
- ◆ [\[:SOURce\]:IQ:TRIGger:DELay](#)
- ◆ [\[:SOURce\]:IQ:TRIGger:DELay:STEP](#)
- ◆ [\[:SOURce\]:IQ:TRIGger:DURation](#)
- ◆ [\[:SOURce\]:IQ:TRIGger:DURation:STEP](#)
- ◆ [\[:SOURce\]:IQ:TRIGger:INHibit](#)
- ◆ [\[:SOURce\]:IQ:TRIGger:INHibit:STEP](#)
- ◆ [\[:SOURce\]:IQ:TRIGger:MODE](#)
- ◆ [\[:SOURce\]:IQ:TRIGger:OPTMode](#)

Note^[2]: If you want to use IQ-related commands, please order the RF signal generator with the IQ-DSG3000 option. Otherwise, the command setting is invalid.

[[:SOURce]:IQ:BASeout:LEVel

Syntax [[:SOURce]:IQ:BASeout:LEVel <value>

[[:SOURce]:IQ:BASeout:LEVel?

Description Set the baseband output amplitude.

Query the baseband output amplitude.

Parameter

Name	Type	Range	Default
<value>	Real	0V to 1.5V	1V

Explanation

- When <value> is set in "Number" form, the default unit is V. Besides, <value> can also be set in "Number + Unit" form, for example, 1.1V.
- The default unit of the return value is V.
- After the baseband output amplitude is set, you can use the up/down direction keys or knob to modify the amplitude at the current step. You can query or set the current step using the [\[:SOURce\]:IQ:BASeout:LEVel:STEP](#) command.

Return Format The query returns the amplitude of the baseband output signal, for example, 1.100000.

Example :IQ:BAS:LEV 1.1

:IQ:BAS:LEV?

Related Command

[\[:SOURce\]:IQ:BASeout:LEVel:STEP](#)

[[:SOURce]:IQ:BASeout:LEVel:STEP

Syntax [[:SOURce]:IQ:BASeout:LEVel:STEP <value>

[[:SOURce]:IQ:BASeout:LEVel:STEP?

Description Set the baseband output amplitude step.

Query the baseband output amplitude step.

Parameter

Name	Type	Range	Default
<value>	Real	0.1V to 0.5V	0.1V

Explanation

- When <value> is set in "Number" form, the default unit is V. Besides, <value> can also be set in "Number + Unit" form, for example, 0.2V.
- The default unit of the return value is V.
- After setting the baseband output amplitude step, you can use the up/down direction keys or knob to modify the output amplitude at the current step. At this point, you can query or reset the output amplitude using the [\[:SOURce\]:IQ:BASeout:LEVel](#) command.

Return Format The query returns the baseband output amplitude step, for example, 0.200000.

Example :IQ:BAS:LEV:STEP 0.2

:IQ:BAS:LEV:STEP?

Related Command

[\[:SOURce\]:IQ:BASeout:LEVel](#)

[[:SOURce]:IQ:BASeout:STATe

Syntax [:SOURce]:IQ:BASeout:STATe ON|OFF|1|0

[:SOURce]:IQ:BASeout:STATe?

Description Set the switch state of the baseband output.

Query the switch state of the baseband output.

Parameter

Name	Type	Range	Default
ON OFF 1 0	Bool	ON OFF 1 0	OFF

- Explanation**
- ON: turn on the baseband output switch.
 - OFF: turn off the baseband output switch.

Return Format The query returns 1 or 0.

Example :IQ:BASeout:STAT ON /* Turn on the baseband output switch*/
 :IQ:BASeout:STAT? /*The query returns 1*/

[[:SOURce]:IQ:MODE

Syntax [:SOURce]:IQ:MODE INtErnal|EXtErnal

[:SOURce]:IQ:MODE?

Description Select the IQ modulation source.

Query the IQ modulation source.

Parameter

Name	Type	Range	Default
INtErnal EXtErnal	Discrete	INtErnal EXtErnal	INtErnal

- Explanation**
- EXtErnal: select "Ext" modulation source. At this point, the RF signal generator receives the In-Phase baseband signal and Quadrature Phase modulating signal of IQ modulation inputted from the **[I IN]** and **[Q IN]** connectors at the rear panel. When external baseband signal is inputted and the baseband output switch is turned on, the RF signal generator can output the I (In-Phase) and Q (Quadrature Phase) components of the IQ modulation baseband signal generated by the built-in baseband generator (wavetable) respectively from the **[I OUT]** and **[Q OUT]** connectors at the rear panel.
 - INtErnal: select "Int" modulation source. At this point, the built-in baseband generator (wavetable) of the instrument provides the modulating signal. If the IQ modulation switch is already turned on, the baseband output switch will be turned on automatically. The RF signal generator can output the In-Phase and Quadrature Phase components of the IQ modulation baseband signal respectively from the **[I OUT]** and **[Q OUT]** connectors at the rear panel.

Return Format The query returns the type of IQ modulation source. For example, INT.

Example :IQ:MOD INT
 :IQ:MOD?

Related Command [\[:SOURce\]:IQ:BASeout:STATe](#)

[[:SOURce]:IQ:MODE:STATe

Syntax [[:SOURce]:IQ:MODE:STATe ON|OFF|1|0

[[:SOURce]:IQ:MODE:STATe?

Description Set the IQ modulation switch state.

Query the IQ modulation switch state.

Parameter	Name	Type	Range	Default
	ON OFF 1 0	Bool	ON OFF 1 0	OFF

- Explanation**
- ON: enable the IQ modulation function.
 - OFF: disable the IQ modulation function.

Return Format The query returns 1 or 0.

Example :IQ:MOD:STAT ON /*Enable the IQ modulation function*/
 :IQ:MOD:STAT? /*The query returns 1*/

[[:SOURce]:IQ:SAMPle

Syntax [[:SOURce]:IQ:SAMPle <value>

[[:SOURce]:IQ:SAMPle?

Description Set the sampling rate of the IQ wave table output.

Query the sampling rate of the IQ wave table output.

Parameter	Name	Type	Range	Default
	<value>	Real	1kHz to 100MHz	1MHz

- Explanation**
- When <value> is set in "Number" form, the default unit is Hz, for example, 3000. In addition, <value> can also be set in "Number + Unit" form, for example, 3kHz.
 - The default unit of the return value is Hz.
 - After the sampling rate is set, you can use the up/down direction keys or knob to modify the sampling rate at the current step. You can query or set the current step using the [\[:SOURce\]:IQ:SAMPle:STEP](#) command.

Return Format The query returns the sampling rate of the IQ wave table output, for example, 3000.

Example :IQ:SAMP 3kHz
 :IQ:SAMP?

Related Command [\[:SOURce\]:IQ:SAMPle:STEP](#)

[[:SOURce]:IQ:SAMPlE:STEP

Syntax [[:SOURce]:IQ:SAMPlE:STEP <value>

[[:SOURce]:IQ:SAMPlE:STEP?

Description Set the sampling rate step of the IQ wave table output.

Query the sampling rate step of the IQ wave table output.

Parameter

Name	Type	Range	Default
<value>	Real	1Hz to 10MHz	1MHz

- Explanation**
- When <value> is set in "Number" form, the default unit is Hz, for example, 3000. In addition, <value> can also be set in "Number + Unit" form, for example, 3kHz.
 - The default unit of the return value is Hz.
 - After the sampling rate step is set, you can use the up/down direction keys or knob to modify the sampling rate at the current step. You can query or reset the sampling rate using the [\[:SOURce\]:IQ:SAMPlE](#) command.

Return Format The query returns the sampling rate step of the IQ wave table output, for example, 3000.

Example :IQ:SAMP:STEP 3kHz

:IQ:SAMP:STEP?

Related Command [\[:SOURce\]:IQ:SAMPlE](#)

[[:SOURce]:IQ:TRIGger:ARB

Syntax [[:SOURce]:IQ:TRIGger:ARB

Description Manually stop outputting the waveform.

Explanation When selecting "Armed Auto" or "Armed Retrig" operation mode, you can use this command to stop outputting the waveform and wait for the next trigger.

Related Command [\[:SOURce\]:IQ:TRIGger:OPTMode](#)

[[:SOURce]:IQ:TRIGger:DELay

Syntax [[:SOURce]:IQ:TRIGger:DELay <value>

[[:SOURce]:IQ:TRIGger:DELay?

Description Set the external trigger delay of IQ wave table.

Query the external trigger delay of IQ wave table.

Parameter	Name	Type	Range	Default
	<value>	Integer	0 to 65535	0

- Explanation**
- The external delay that is the delay of the response to a trigger when the external trigger signal arrives.
 - This command is valid only when selecting "Ext" trigger mode. <value> describes the number of points (N_d). The actual time (T_d) can be obtained according to the current sample rate (S_a): $T_d = N_d / S_a$.
 - After the external delay is set, you can use the up/down direction keys or knob to modify the delay at the current step. You can query or set the current step using the [\[:SOURce\]:IQ:TRIGger:DELay:STEP](#) command.

Return Format The query returns the external trigger delay, for example, 300.

Example :IQ:TRIG:DEL 300

:IQ:TRIG:DEL?

Related Commands [\[:SOURce\]:IQ:TRIGger:DELay:STEP](#)
[\[:SOURce\]:IQ:TRIGger:MODE](#)

[[:SOURce]:IQ:TRIGger:DELay:STEP

Syntax [[:SOURce]:IQ:TRIGger:DELay:STEP <value>

[[:SOURce]:IQ:TRIGger:DELay:STEP?

Description Set the external trigger delay step of IQ wave table.

Query the external trigger delay step of IQ wave table.

Parameter	Name	Type	Range	Default
	<value>	Integer	1 to 10000	1

- Explanation** After setting the external delay step, you can use the up/down direction keys or knob to modify the external delay at the current step. At this point, you can query or reset the external delay using the [\[:SOURce\]:IQ:TRIGger:DELay](#) command.

Return Format The query returns the external trigger delay step, for example, 20.

Example :IQ:TRIG:DEL:STEP 20

:IQ:TRIG:DEL:STEP?

Related Command [\[:SOURce\]:IQ:TRIGger:DELay](#)

[[:SOURce]:IQ:TRIGger:DURation]

Syntax [[:SOURce]:IQ:TRIGger:DURation <value>

[[:SOURce]:IQ:TRIGger:DURation?

Description Set the duration of the single trigger signal.

Query the duration of the single trigger signal.

Parameter	Name	Type	Range	Default
	<value>	Integer	1 to 65535	1

- Explanation**
- This command is valid only when selecting "Single" operation mode. <value> describes the number of points (N_r). The actual time (T_r) can be obtained according to the current sample rate (S_a): $T_r = N_r / S_a$.
 - After the duration is set, you can use the up/down direction keys or knob to modify the duration at the current step. You can query or set the current step using the [\[\[:SOURce\]:IQ:TRIGger:DURation:STEP\]](#) command.

Return Format The query returns the duration of the single output signal, for example, 4000.

Example :IQ:TRIG:DUR 4000

:IQ:TRIG:DUR?

Related Commands [\[\[:SOURce\]:IQ:TRIGger:DURation:STEP\]](#)
[\[\[:SOURce\]:IQ:TRIGger:OPTMode\]](#)

[[:SOURce]:IQ:TRIGger:DURation:STEP]

Syntax [[:SOURce]:IQ:TRIGger:DURation:STEP <value>

[[:SOURce]:IQ:TRIGger:DURation:STEP?

Description Set the duration step.

Query the duration step.

Parameter	Name	Type	Range	Default
	<value>	Integer	1 to 10000	1

- Explanation** After setting the duration step, you can use the up/down direction keys or knob to modify the duration at the current step. At this point, you can query or reset the duration using the [\[\[:SOURce\]:IQ:TRIGger:DURation\]](#) command.

Return Format The query returns the duration step, for example, 500.

Example :IQ:TRIG:DUR:STEP 500

:IQ:TRIG:DUR:STEP?

Related Command [\[\[:SOURce\]:IQ:TRIGger:DURation\]](#)

[[:SOURce]:IQ:TRIGger:INHibit

Syntax [[:SOURce]:IQ:TRIGger:INHibit <value>

[[:SOURce]:IQ:TRIGger:INHibit?

Description Set the external inhibit of IQ wave table.

Query the external inhibit of IQ wave table.

Parameter	Name	Type	Range	Default
	<value>	Integer	0 to 65535	0

- Explanation**
- After a trigger event occurs, the trigger signal is no longer received during the external inhibit time.
 - This command is valid only when selecting "Ext" trigger mode. <value> describes the number of points (N_i). The actual time (T_i) can be obtained according to the current sample rate (S_a): $T_i = N_i / S_a$.
 - After the external inhibit is set, you can use the up/down direction keys or knob to modify the inhibit at the current step. You can query or set the current step using the [\[:SOURce\]:IQ:TRIGger:INHibit:STEP](#) command.

Return Format The query returns the external inhibit, for example, 5000.

Example :IQ:TRIG:INH 5000

:IQ:TRIG:INH?

Related Commands [\[:SOURce\]:IQ:TRIGger:INHibit:STEP](#)
[\[:SOURce\]:IQ:TRIGger:MODE](#)

[[:SOURce]:IQ:TRIGger:INHibit:STEP

Syntax [[:SOURce]:IQ:TRIGger:INHibit:STEP <value>

[[:SOURce]:IQ:TRIGger:INHibit:STEP?

Description Set the external inhibit step.

Query the external inhibit step.

Parameter	Name	Type	Range	Default
	<value>	Integer	1 to 10000	1

- Explanation** After setting the external inhibit step, you can use the up/down direction keys or knob to modify the external inhibit at the current step. At this point, you can query or reset the external inhibit using the [\[:SOURce\]:IQ:TRIGger:INHibit](#) command.

Return Format The query returns the external inhibit step, for example, 555.

Example :IQ:TRIG:INH:STEP 555

:IQ:TRIG:INH:STEP?

Related Command [\[:SOURce\]:IQ:TRIGger:INHibit](#)

[[:SOURce]:IQ:TRIGger:MODE

Syntax [[:SOURce]:IQ:TRIGger:MODE AUTO|KEY|BUS|EXT

[[:SOURce]:IQ:TRIGger:MODE?

Description Set the trigger mode of IQ wave table.

Query the trigger mode of IQ wave table.

Parameter

Name	Type	Range	Default
AUTO KEY BUS EXT	Discrete	AUTO KEY BUS EXT	AUTO

- Explanation**
- AUTO: select "Auto" trigger mode. The RF signal generator fulfills the trigger condition at any time and it will output continuously the IQ baseband signal.
 - KEY: select "Key" trigger mode. The instrument will output the baseband signal each time **Trigger** at the front panel is pressed.
 - BUS: select "Bus" trigger mode. The instrument will output the baseband signal each time the [*TRG](#) or [:TRIGger:IQ\[:IMMEDIATE\]](#) command is sent.
 - EXT: select "Ext" trigger mode. The RF signal generator accepts the trigger signal input from the **[TRIGGER IN]** connector at the rear panel. The instrument will output the baseband signal each time a TTL pulse signal with the specified polarity is received.
 - When selecting "Ext" trigger, you can also set the "Ext Delay" and "Ext Inhibit".

Return Format The query returns the trigger mode of IQ wave table, for example, KEY.

Example :IQ:TRIG:MOD KEY

:IQ:TRIG:MOD?

Related Commands [\[:SOURce\]:IQ:TRIGger:DELay](#)
[\[:SOURce\]:IQ:TRIGger:INHibit](#)
[*TRG](#)
[:TRIGger:IQ\[:IMMEDIATE\]](#)

[[:SOURce]:IQ:TRIGger:OPTMode

Syntax [[:SOURce]:IQ:TRIGger:OPTMode RETRig|AMDAuto|AMDRe trig|SINGle
[:SOURce]:IQ:TRIGger:OPTMode?

Description Set the operation mode of IQ wave table.

Query the operation mode of IQ wave table.

Parameter	Name	Type	Range	Default
	RETRig AMDAuto AMDRe trig SINGle	Discrete	RETRig AMDAuto AMDRe trig SINGle	RETRig

- Explanation**
- RETRig: select "Retrig" mode. At this point, the baseband signal is generated continuously and each trigger event causes a restart.
 - AMDAuto: select "Arm Auto" mode. The instrument starts outputting the signal continuously only when each trigger event occurs until press "Arm ARB" and wait for the next trigger.
 - AMDRe trig: select "Arm Retrig" mode. The instrument starts outputting the signal continuously when each trigger event occurs. After each subsequent trigger event occurs, the instrument restarts outputting the signal until press "Arm ARB" and wait for the next trigger.
 - SINGle: select "Single" mode. The instrument outputs the signal which length specified at the "Duration" and then stops to wait for the next trigger when each trigger event occurs.

Return Format The query returns the operation mode of IQ wave table, for example, RETRIG.

Example :IQ:TRIG:OPTM RETR
:IQ:TRIG:OPTM?

Related Commands [\[:SOURce\]:IQ:TRIGger:ARB](#)
[\[:SOURce\]:IQ:TRIGger:DURation](#)

[[:SOURce]:LEVel Command Subsystem**Command List:**

- ◆ [\[:SOURce\]:LEVel](#)
- ◆ [\[:SOURce\]:LEVel:ALC:MODE](#)
- ◆ [\[:SOURce\]:LEVel:ATTenuation](#)
- ◆ [\[:SOURce\]:LEVel:ATTenuation:MODE](#)
- ◆ [\[:SOURce\]:LEVel:ATTenuation:STEP](#)
- ◆ [\[:SOURce\]:LEVel:LIMit](#)
- ◆ [\[:SOURce\]:LEVel:LIMit:STEP](#)
- ◆ [\[:SOURce\]:LEVel:OFFSet](#)
- ◆ [\[:SOURce\]:LEVel:OFFSet:STEP](#)
- ◆ [\[:SOURce\]:LEVel:SH:ACTIve](#)
- ◆ [\[:SOURce\]:LEVel:SH:MODE](#)
- ◆ [\[:SOURce\]:LEVel:STEP](#)

[[:SOURce]:LEVel]

Syntax [[:SOURce]:LEVel <value>

[[:SOURce]:LEVel?

Description Set the RF output amplitude.

Query the RF output amplitude.

Parameter

Name	Type	Range	Default
<value>	Real	-140dBm to 20dBm	-140dBm

- Explanation**
- When <value> is set in "Number" form, the default unit is dBm, for example, 2. In addition, <value> can also be set in "Number + Unit" form, for example, 2dBm. At this point, the amplitude displayed in the interface is related to the setting of **Level Unit**:
 - When the level unit is "dBm", 2.00dBm is displayed;
 - When the level unit is "dBmV", 48.99dBmV is displayed;
 - When the level unit is "dBuV", 108.99dBuV is displayed;
 - When the level unit is "Volts", 281.50mV is displayed;
 - When the level unit is "Watts", 1.58mW is displayed.
 - The default unit of the return value is dBm.
 - After the RF amplitude is set, you can use the up/down direction keys or knob to modify the amplitude at the current step. You can query or set the current step using the [\[:SOURce\]:LEVel:STEP](#) command.
 - When the amplitude offset is 0 dB, the amplitude displayed in the interface (namely the setting amplitude) is equal to the actual output amplitude.
 - When the amplitude offset is not 0 dB, the output amplitude is determined by the setting amplitude and amplitude offset. The three parameters satisfy the equation: setting amplitude (display amplitude) = output amplitude + amplitude offset. You can use the [\[:SOURce\]:LEVel:OFFSet](#) command to query and set the RF amplitude offset.

Return Format The query returns the RF amplitude, for example, 2.00.

Example :LEV 2dBm /*Set the RF amplitude to 2dBm*/
 :LEV? /*Query the RF amplitude and the query returns 2.00*/

Related Commands [\[:SOURce\]:LEVel:STEP](#)
[\[:SOURce\]:LEVel:OFFSet](#)

[[:SOURce]:LEVel:ALC:MODE

Syntax [:SOURce]:LEVel:ALC:MODE OFF|ON|AUTO
[:SOURce]:LEVel:ALC:MODE?

Description Set the working state of the ALC function.
Query the working state of the ALC function.

Parameter	Name	Type	Range	Default
	OFF ON AUTO	Discrete	OFF ON AUTO	AUTO

Explanation

- OFF: turn off the ALC function. At this point, the instrument switches to "Sample & Hold" state.
- ON: turn on the ALC function.
- AUTO: the current working state of the ALC function is automatic.

Return Format The query returns OFF, ON or AUTO.

Example :LEV:ALC:MODE OFF /*Turn off the ALC function*/
:LEV:ALC:MODE? /*The query returns OFF*/

Related Commands [\[:SOURce\]:LEVel:SH:ACTIve](#)
[\[:SOURce\]:LEVel:SH:MODE](#)

[[:SOURce]:LEVel:ATTenuation

Syntax [:SOURce]:LEVel:ATTenuation <value>
[:SOURce]:LEVel:ATTenuation?

Description Set the attenuation of the RF output amplitude.
Query the attenuation of the RF output amplitude.

Parameter	Name	Type	Range	Default
	<value>	Integer	0dB to 125dB	125dB

Explanation

- When <value> is set in "Number" form, the default unit is dB. In addition, <value> can also be set in "Number + Unit" form, for example, 20dB.
- The attenuation can only be set to multiples of 5.
- The default unit of the return value is dB.
- After the amplitude attenuation is set, you can use the up/down direction keys or knob to modify the attenuation at the current step. You can query or set the current step using the [\[:SOURce\]:LEVel:ATTenuation:STEP](#) command.
- You can set the attenuation only when the "FIXed" attenuation mode is selected by the [\[:SOURce\]:LEVel:ATTenuation:MODE](#) command. In "AUTO" mode, this command is invalid.

Return Format The query returns the RF amplitude attenuation, for example, 20.00.

Example :LEV:ATT 20dB
:LEV:ATT?

Related Commands [\[:SOURce\]:LEVel:ATTenuation:STEP](#)
[\[:SOURce\]:LEVel:ATTenuation:MODE](#)

[[:SOURce]:LEVel:ATTenuation:MODE

Syntax [[:SOURce]:LEVel:ATTenuation:MODE AUTO|FIXed

[[:SOURce]:LEVel:ATTenuation:MODE?

Description Set the attenuation mode of the RF output amplitude.

Query the attenuation mode of the RF output amplitude.

Parameter

Name	Type	Range	Default
AUTO FIXed	Discrete	AUTO FIXed	AUTO

Explanation

- AUTO: select "Auto" attenuation mode.
- FIXed: select "Fixed" attenuation mode. At this point, you can set the attenuation of the RF output amplitude using the [\[:SOURce\]:LEVel:ATTenuation](#) command.

Return Format The query returns AUTO or FIX.

Example :LEV:ATT:MODE FIX

:LEV:ATT:MODE?

Related Command [\[:SOURce\]:LEVel:ATTenuation](#)

[[:SOURce]:LEVel:ATTenuation:STEP

Syntax [[:SOURce]:LEVel:ATTenuation:STEP <value>

[[:SOURce]:LEVel:ATTenuation:STEP?

Description Set the RF amplitude attenuation step.

Query the RF amplitude attenuation step.

Parameter

Name	Type	Range	Default
<value>	Integer	5dB to 100dB	5dB

Explanation

- When <value> is set in "Number" form, the default unit is dB. Besides, <value> can also be set in "Number+ Unit" mode, for example, 15dB.
- The attenuation step can only be multiples of 5.
- The default unit of the return value is dB.
- After the amplitude attenuation step is set, you can use the up/down direction keys or knob to modify the attenuation at the current step. At this point, you can query or set the amplitude attenuation using the [\[:SOURce\]:LEVel:ATTenuation](#) command.

Return Format The query returns the RF amplitude attenuation step, for example, 15.00.

Example :LEV:ATT:STEP 15

:LEV:ATT:STEP?

Related Command [\[:SOURce\]:LEVel:ATTenuation](#)

[[:SOURce]:LEVel:LIMit

Syntax [[:SOURce]:LEVel:LIMit <value>

[[:SOURce]:LEVel:LIMit?

Description Set the limit of the RF output amplitude.

Query the limit of the RF output amplitude.

Parameter

Name	Type	Range	Default
<value>	Real	-140dBm to 25dBm	25dBm

- Explanation**
- When <value> is set in "Number" form (for example, 2), the default unit is dBm. When it is set in "Number + Unit" form (for example, 2dBm), the limit displayed in the RF signal generator interface is related to the setting of **Level Unit**.
 - When the level unit is "dBm", it is displayed as 2.00dBm;
 - When the level unit is "dBmV", it is displayed as 48.99dBmV;
 - When the level unit is "dBuV", it is displayed as 108.99dBuV;
 - When the level unit is "Volts", it is displayed as 281.50mV;
 - When the level unit is "Watts", it is displayed as 1.58mW.
 - The default unit of all the return values is dBm.
 - After setting the amplitude limit, you can use the up/down direction keys or knob to modify the limit at the current step. At this point, you can query or set the current step using the [\[:SOURce\]:LEVel:LIMit:STEP](#) command.

Return Format The query returns the limit of the RF output amplitude, for example, 5.60.

Example :LEV:LIM 5.6

:LEV:LIM?

Related Command [\[:SOURce\]:LEVel:LIMit:STEP](#)

[[:SOURce]:LEVel:LIMit:STEP

Syntax [[:SOURce]:LEVel:LIMit:STEP <value>

[[:SOURce]:LEVel:LIMit:STEP?

Description Set the step of the RF output amplitude limit.

Query the step of the RF output amplitude limit.

Parameter

Name	Type	Range	Default
<value>	Real	0.01dB to 100dB	10dB

- Explanation**
- When <value> is set in "Number" form, the default unit is dB. Besides, <value> can also be set in "Number + Unit" form, for example, 4.5dB.
 - The default unit of the return value is dB.
 - After setting the step of the amplitude limit, you can use the up/down direction keys or knob to modify the limit at the current step. At this point, you can query or set the amplitude limit using the [\[:SOURce\]:LEVel:LIMit](#) command.

Return Format The query returns the step of the RF output amplitude limit, for example, 4.50.

Example :LEV:LIM:STEP 4.5

:LEV:LIM:STEP?

Related Command [\[:SOURce\]:LEVel:LIMit](#)

[[:SOURce]:LEVel:OFFSet

Syntax [[:SOURce]:LEVel:OFFSet <value>

[[:SOURce]:LEVel:OFFSet?

Description Set the amplitude offset of the RF output amplitude.

Query the amplitude offset of the RF output amplitude.

Parameter

Name	Type	Range	Default
<value>	Real	-200dB to 200dB	0dB

Explanation

- When <value> is set in "Number" form, the default unit is dB. Besides, <value> can also be set in "Number + Unit" form, for example, 10dB.
- The default unit of the return value is dB.
- After setting the amplitude offset, you can use the up/down direction keys or knob to modify the amplitude offset at the current step. At this point, you can query or set the current step using the [\[:SOURce\]:LEVel:OFFSet:STEP](#) command.
- When the amplitude offset is 0 dB, the display amplitude (namely the setting amplitude) is equal to the actual output amplitude.
- When the amplitude offset is not 0 dB, the output amplitude is determined by the setting amplitude and amplitude offset. The three parameters satisfy the equation: setting amplitude (display amplitude) = output amplitude + amplitude offset. You can query or set the RF amplitude using the [\[:SOURce\]:LEVel](#) command.

Return Format The query returns the offset of the RF output amplitude, for example, 10.00.

Example :LEV:OFFS 10

:LEV:OFFS?

Related Commands

[\[:SOURce\]:LEVel:OFFSet:STEP](#)

[\[:SOURce\]:LEVel](#)

[[:SOURce]:LEVel:OFFSet:STEP

Syntax [[:SOURce]:LEVel:OFFSet:STEP <value>

[[:SOURce]:LEVel:OFFSet:STEP?

Description Set the step of the RF amplitude offset.

Query the step of the RF amplitude offset.

Parameter

Name	Type	Range	Default
<value>	Real	0.01dB to 200dB	10dB

- Explanation**
- When <value> is set in "Number" form, the default unit is dB. Besides, <value> can also be set in "Number + Unit" form, for example, 20dB.
 - The default unit of the return value is dB.
 - After setting the step of the amplitude offset, you can use the up/down direction keys or knob to modify the amplitude offset at the current step. At this point, you can query or set the amplitude offset using the [\[\[:SOURce\]:LEVel:OFFSet](#) command.

Return Format The query returns the step of the RF amplitude offset, for example, 20.00.

Example :LEV:OFFS:STEP 20

:LEV:OFFS:STEP?

Related Command [\[\[:SOURce\]:LEVel:OFFSet](#)

[[:SOURce]:LEVel:SH:ACTIve

Syntax [[:SOURce]:LEVel:SH:ACTIve

Description Execute a sample hold operation immediately.

Explanation This command is valid when the ALC function is disabled.

Related Command [\[\[:SOURce\]:LEVel:ALC:MODE](#)

[[:SOURce]:LEVel:SH:MODE

Syntax [:SOURce]:LEVel:SH:MODE AUTO|MANUal
[:SOURce]:LEVel:SH:MODE?

Description Set the current sample hold mode.

Query the current sample hold mode.

Parameter	Name	Type	Range	Default
	AUTO MANUal	Discrete	AUTO MANUal	AUTO

- Explanation**
- A sample hold operation is performed automatically each time the RF amplitude is set.
 - This command is valid when the ALC function is disabled.

Return Format The query returns AUTO or MANUAL.

Example :LEV:SH:MODE MANU
:LEV:SH:MODE?

Related Commands [\[:SOURce\]:LEVel:ALC:MODE](#)
[\[:SOURce\]:LEVel:SH:ACTIve](#)

[[:SOURce]:LEVel:STEP

Syntax [:SOURce]:LEVel:STEP <value>
[:SOURce]:LEVel:STEP?

Description Set the RF output amplitude step.

Query the RF output amplitude step.

Parameter	Name	Type	Range	Default
	<value>	Real	0.01dB to 100dB	10dB

- Explanation**
- When <value> is set in "Number" form, the default unit is dB. Besides, <value> can also be set in "Number + Unit" form, for example, 20dB.
 - The default unit of the return value is dB.
 - After setting the output amplitude step, you can use the up/down direction keys or knob to modify the output amplitude at the current step. At this point, you can query or set the output amplitude using the [\[:SOURce\]:LEVel](#) command.

Return Format The query returns the RF output amplitude step, for example, 20.00.

Example :LEV:STEP 20
:LEV:STEP?

Related Command [\[:SOURce\]:LEVel](#)

[:SOURce]:LFOutput Command Subsystem

Command List:

- ◆ [\[:SOURce\]:LFOutput:FREQuency](#)
- ◆ [\[:SOURce\]:LFOutput:LEVel](#)
- ◆ [\[:SOURce\]:LFOutput:SHAPE](#)
- ◆ [\[:SOURce\]:LFOutput\[:STATe\]](#)
- ◆ [\[:SOURce\]:LFOutput:SWEPTsine:DWELI](#)
- ◆ [\[:SOURce\]:LFOutput:SWEPTsine:DWELI:STEP](#)
- ◆ [\[:SOURce\]:LFOutput:SWEPTsine:FREQuency:START](#)
- ◆ [\[:SOURce\]:LFOutput:SWEPTsine:FREQuency:START:STEP](#)
- ◆ [\[:SOURce\]:LFOutput:SWEPTsine:FREQuency:STOP](#)
- ◆ [\[:SOURce\]:LFOutput:SWEPTsine:FREQuency:STOP:STEP](#)
- ◆ [\[:SOURce\]:LFOutput:SWEPTsine:LEVel](#)
- ◆ [\[:SOURce\]:LFOutput:SWEPTsine:LEVel:STEP](#)
- ◆ [\[:SOURce\]:LFOutput:SWEPTsine:MODE](#)
- ◆ [\[:SOURce\]:LFOutput:SWEPTsine:SHAPE](#)
- ◆ [\[:SOURce\]:LFOutput:SWEPTsine:SINGLE](#)
- ◆ [\[:SOURce\]:LFOutput:SWEPTsine:TRIGger](#)
- ◆ [\[:SOURce\]:LFOutput:SWEPTsine:XPOLar](#)

[[:SOURce]:LFOutput:FREQuency]

Syntax [:SOURce]:LFOutput:FREQuency <value>

[:SOURce]:LFOutput:FREQuency?

Description Set the frequency of the LF output signal.

Query the frequency of the LF output signal.

Parameter

Name	Type	Range	Default
<value>	Real	The frequency ranges available for different LF signals are different	10kHz

Explanation

- The waveforms of LF output signal include "Sine", "Square", "Triangle", "Ramp" and "Swp-Sine". The frequency range of sine and sweep-sine is from 100mHz to 1MHz; the frequency range of square is from 100mHz to 20kHz; the frequency range of triangle and ramp waveforms is from 100mHz to 100kHz.
- When the AM or FM/ØM function is enabled (the **MOD** switch is also turned on) and internal modulation source is selected, you can set the frequency of the **[LF OUTPUT]** output signal using the [\[:SOURce\]:AM:FREQuency](#), [\[:SOURce\]:FM:FREQuency](#) or [\[:SOURce\]:PM:FREQuency](#) command.
- When <value> is set in "Number" form, the default unit is Hz. Besides, <value> can also be set in "Number + Unit" form, for example, 2kHz.
- The default unit of the return value is Hz.

Return Format The query returns the frequency of the LF output signal, for example, 2000.

Example :LFO:FREQ 2kHz

:LFO:FREQ?

Related Commands

[\[:SOURce\]:AM:FREQuency](#)

[\[:SOURce\]:FM:FREQuency](#)

[\[:SOURce\]:PM:FREQuency](#)

[[:SOURce]:LFOOutput:LEVel

Syntax [[:SOURce]:LFOOutput:LEVel <value>

[[:SOURce]:LFOOutput:LEVel?

Description Set the amplitude of the LF output signal.

Query the amplitude of the LF output signal.

Parameter	Name	Type	Range	Default
	<value>	Real	1mV to 3V	1V

- Explanation**
- When the AM or FM/ØM function is enabled, the **MOD** switch is turned on and internal modulation source is selected, you can use this command to set the amplitude of the internal modulating signal.
 - When <value> is set in "Number" form, the default unit is V. Besides, <value> can also be set in "Number + Unit" form, for example, 2V.
 - The default unit of the return value is V.

Return Format The query returns the amplitude of the LF output signal, for example, 2.00.

Example :LFO:LEV 2

:LFO:LEV?

[[:SOURce]:LFOOutput:SHAPE

Syntax [[:SOURce]:LFOOutput:SHAPE SINE|SWEPTSine|TRIangle|SQUare|RAMP

[[:SOURce]:LFOOutput:SHAPE?

Description Select the waveform of the LF output signal.

Query the waveform of the LF output signal.

Parameter	Name	Type	Range	Default
	SINE SWEPTSine TRIangle SQUare RAMP	Discrete	SINE SWEPTSine TRIangle SQUare RAMP	SINE

- Explanation**
- The parameter SINE|SWEPTSine|TRIangle|SQUare|RAMP can set the waveform of the LF output signal to "Sine", "Swp-Sine", "Triangle", "Square" or "Ramp".
 - When the AM or FM/ØM function is enabled (the **MOD** switch is also turned on) and internal modulation source is selected, you can set the waveform of the LF output signal to sine or square using the [\[:SOURce\]:AM:WAVEform](#), [\[:SOURce\]:FM:WAVEform](#) or [\[:SOURce\]:PM:WAVEform](#) command.

Return Format The query returns SINE|SWEP|TRI|SQU|RAMP.

Example :LFO:SHAP TRI

:LFO:SHAP?

Related Commands [\[:SOURce\]:AM:WAVEform](#)
[\[:SOURce\]:FM:WAVEform](#)
[\[:SOURce\]:PM:WAVEform](#)

[[:SOURce]:LFOutput[:STATe]]

Syntax [:SOURce]:LFOutput[:STATe] ON|OFF|1|0
[:SOURce]:LFOutput[:STATe]?

Description Turn on or off the LF output.

Query the state of the LF output.

Parameter	Name	Type	Range	Default
	ON OFF 1 0	Bool	ON OFF 1 0	OFF

- Explanation**
- ON: turn on the LF output and the backlight of the **LF** output control key turns on.
 - OFF: turn off the LF output and the backlight of the **LF** output control key turns off.

Return Format The query returns 1 or 0.

Example :LFO:STAT ON /*Turn on the LF output*/
:LFO:STAT? /*The query returns 1*/

[[:SOURce]:LFOutput:SWEPTsine:DWELI]

Syntax [:SOURce]:LFOutput:SWEPTsine:DWELI <value>
[:SOURce]:LFOutput:SWEPTsine:DWELI?

Description Set the sweep time of sweep-sine.

Query the sweep time of sweep-sine.

Parameter	Name	Type	Range	Default
	<value>	Real	1ms to 1ks	1s

- Explanation**
- When <value> is set in "Number" form, the default unit is s. Besides, <value> can also be set in "Number + Unit" form, for example, 1ks.
 - The default unit of the return value is s.
 - After setting the sweep time, you can use the up/down direction keys or knob to modify the sweep time at the current step. You can query or set the current step using the [\[:SOURce\]:LFOutput:SWEPTsine:DWELI:STEP](#) command.

Return Format The query returns the sweep time of sweep-sine, for example, 1000.

Example :LFO:SWEP:DWEL 1ks
:LFO:SWEP:DWEL?

Related Command [\[:SOURce\]:LFOutput:SWEPTsine:DWELI:STEP](#)

[[:SOURce]:LFOOutput:SWEPTsine:DWELI:STEP

Syntax [[:SOURce]:LFOOutput:SWEPTsine:DWELI:STEP <value>
[[:SOURce]:LFOOutput:SWEPTsine:DWELI:STEP?

Description Set the sweep time step of sweep-sine.

Query the sweep time step of sweep-sine.

Parameter	Name	Type	Range	Default
	<value>	Real	1ms to 100s	1ms

- Explanation**
- When <value> is set in "Number" form, the default unit is s. Besides, <value> can also be set in "Number + Unit" form, for example, 1000ms.
 - The default unit of the return value is s.
 - After setting the sweep time step, you can use the up/down direction keys or knob to modify the sweep time at the current step. At this point, you can query or set the sweep time using the [\[\[:SOURce\]:LFOOutput:SWEPTsine:DWELI](#) command.

Return Format The query returns the sweep time step of sweep-sine, for example, 1.

Example :LFO:SWEP:DWEL:STEP 1000ms
:LFO:SWEP:DWEL:STEP?

Related Command [\[\[:SOURce\]:LFOOutput:SWEPTsine:DWELI](#)

[[:SOURce]:LFOOutput:SWEPTsine:FREQuency:STARt

Syntax [[:SOURce]:LFOOutput:SWEPTsine:FREQuency:STARt <value>
[[:SOURce]:LFOOutput:SWEPTsine:FREQuency:STARt?

Description Set the start frequency of sweep-sine.

Query the start frequency of sweep-sine.

Parameter	Name	Type	Range	Default
	<value>	Real	100mHz to 1MHz	10kHz

- Explanation**
- When <value> is set in "Number" form, the default unit is Hz, for example, 3000. Besides, <value> can also be set in "Number + Unit" form, for example, 3kHz.
 - The default unit of the return value is Hz.
 - After setting the start frequency, you can use the up/down direction keys or knob to modify the frequency at the current step. At this point, you can query or set the current step using the [\[\[:SOURce\]:LFOOutput:SWEPTsine:FREQuency:STARt:STEP](#) command.

Return Format The query returns the start frequency of sweep-sine, for example, 3000.

Example :LFO:SWEP:FREQ:STAR 3kHz
:LFO:SWEP:FREQ:STAR?

Related Command [\[\[:SOURce\]:LFOOutput:SWEPTsine:FREQuency:STARt:STEP](#)

[[:SOURce]:LFOOutput:SWEPTsine:FREQuency:STARt:STEP

Syntax [:SOURce]:LFOOutput:SWEPTsine:FREQuency:STARt:STEP <value>
[:SOURce]:LFOOutput:SWEPTsine:FREQuency:STARt:STEP?

Description Set the start frequency of sweep-sine.

Query the start frequency step of sweep-sine.

Parameter	Name	Type	Range	Default
	<value>	Real	100mHz to 500kHz	1kHz

- Explanation**
- When <value> is set in "Number" form, the default unit is Hz, for example, 3000. Besides, <value> can also be set in "Number + Unit" form, for example, 3kHz.
 - The default unit of the return value is Hz.
 - After setting the start frequency step, you can use the up/down direction keys or knob to modify the start frequency at the current step. At this point, you can query or set the start frequency using the [\[:SOURce\]:LFOOutput:SWEPTsine:FREQuency:STARt](#) command.

Return Format The query returns the start frequency step of sweep-sine, for example, 3000.

Example :LFO:SWEP:FREQ:STAR:STEP 3kHz
:LFO:SWEP:FREQ:STAR:STEP?

Related Command [\[:SOURce\]:LFOOutput:SWEPTsine:FREQuency:STARt](#)

[[:SOURce]:LFOOutput:SWEPTsine:FREQuency:STOP

Syntax [:SOURce]:LFOOutput:SWEPTsine:FREQuency:STOP <value>
[:SOURce]:LFOOutput:SWEPTsine:FREQuency:STOP?

Description Set the stop frequency of sweep-sine.

Query the stop frequency of sweep-sine.

Parameter	Name	Type	Range	Default
	<value>	Real	100mHz to 1MHz	100kHz

- Explanation**
- When <value> is set in "Number" form, the default unit is Hz, for example, 5000. Besides, <value> can also be set in "Number + Unit" form, for example, 5kHz.
 - The default unit of the return value is Hz.
 - After setting the stop frequency, you can use the up/down direction keys or knob to modify the frequency at the current step. At this point, you can query or set the current step using the [\[:SOURce\]:LFOOutput:SWEPTsine:FREQuency:STOP:STEP](#) command.

Return Format The query returns the stop frequency of sweep-sine, for example, 5000.

Example :LFO:SWEP:FREQ:STOP 5kHz
:LFO:SWEP:FREQ:STOP?

Related Command [\[:SOURce\]:LFOOutput:SWEPTsine:FREQuency:STOP:STEP](#)

[[:SOURce]:LFOOutput:SWEPTsine:FREQuency:STOP:STEP

Syntax [[:SOURce]:LFOOutput:SWEPTsine:FREQuency:STOP:STEP <value>

[[:SOURce]:LFOOutput:SWEPTsine:FREQuency:STOP:STEP?

Description Set the stop frequency step of sweep-sine.

Query the stop frequency step of sweep-sine.

Parameter	Name	Type	Range	Default
	<value>	Real	100mHz to 500kHz	10kHz

- Explanation**
- When <value> is set in "Number" form, the default unit is Hz, for example, 3000. Besides, <value> can also be set in "Number + Unit" form, for example, 3kHz.
 - The default unit of the return value is Hz.
 - After setting the stop frequency step, you can use the up/down direction keys or knob to modify the stop frequency at the current step. At this point, you can query or set the stop frequency using the [\[\[:SOURce\]:LFOOutput:SWEPTsine:FREQuency:STOP](#) command.

Return Format The query returns the stop frequency step of sweep-sine, for example, 3000.

Example :LFO:SWEP:FREQ:STOP:STEP 3kHz

:LFO:SWEP:FREQ:STOP:STEP?

Related Command [\[\[:SOURce\]:LFOOutput:SWEPTsine:FREQuency:STOP](#)

[[:SOURce]:LFOOutput:SWEPTsine:LEVel

Syntax [[:SOURce]:LFOOutput:SWEPTsine:LEVel <value>

[[:SOURce]:LFOOutput:SWEPTsine:LEVel?

Description Set the amplitude of sweep-sine.

Query the amplitude of sweep-sine.

Parameter	Name	Type	Range	Default
	<value>	Real	1mV to 3V	1V

- Explanation**
- When <value> is set in "Number" form, the default unit is V. Besides, <value> can also be set in "Number + Unit" form, for example, 2V.
 - The default unit of the return value is V.
 - After setting the amplitude of sweep-sine, you can use the up/down direction keys or knob to modify the amplitude at the current step. At this point, you can query or set the current step using the [\[\[:SOURce\]:LFOOutput:SWEPTsine:LEVel:STEP](#) command.

Return Format The query returns the amplitude of sweep-sine, for example, 2.00.

Example :LFO:SWEP:LEV 2

:LFO:SWEP:LEV?

Related Command [\[\[:SOURce\]:LFOOutput:SWEPTsine:LEVel:STEP](#)

[[:SOURce]:LFOutput:SWEPtsine:LEVel:STEP

Syntax [:SOURce]:LFOutput:SWEPtsine:LEVel:STEP <value>
[:SOURce]:LFOutput:SWEPtsine:LEVel:STEP?

Description Set the amplitude step of sweep-sine.

Query the amplitude step of sweep-sine.

Parameter

Name	Type	Range	Default
<value>	Real	1mV to 1V	0.5V

- Explanation**
- When <value> is set in "Number" form, the default unit is V. Besides, <value> can also be set in "Number + Unit" form, for example, 1000mV.
 - The default unit of the return value is V.
 - After setting the amplitude step of sweep-sine, you can use the up/down direction keys or knob to modify the amplitude at the current step. At this point, you can query or set the amplitude of sweep-sine using the [\[:SOURce\]:LFOutput:SWEPtsine:LEVel](#) command.

Return Format The query returns the amplitude step of sweep-sine, for example, 1.00.

Example :LFO:SWEP:LEV:STEP 1000mV
:LFO:SWEP:LEV:STEP?

Related Command [\[:SOURce\]:LFOutput:SWEPtsine:LEVel](#)

[[:SOURce]:LFOutput:SWEPtsine:MODE

Syntax [:SOURce]:LFOutput:SWEPtsine:MODE CONTinue|SINGLE
[:SOURce]:LFOutput:SWEPtsine:MODE?

Description Set the mode of sweep-sine.

Query the mode of sweep-sine.

Parameter

Name	Type	Range	Default
CONTinue SINGLE	Discrete	CONTinue SINGLE	CONTinue

- Explanation**
- CONTinue: select "Cont" mode. When the trigger condition is met, the instrument sweeps continuously at the current setting.
 - SINGLE: select "Single" mode. Send the [\[:SOURce\]:LFOutput:SWEPtsine:SINGLE](#) command and the instrument performs a sweep according to the current setting and then stops when the trigger condition is met.

Return Format The query returns CONT or SING.

Example :LFO:SWEP:MODE CONT
:LFO:SWEP:MODE?

Related Command [\[:SOURce\]:LFOutput:SWEPtsine:SINGLE](#)

[[:SOURce]:LFOOutput:SWEPtsine:SHAPE

Syntax [[:SOURce]:LFOOutput:SWEPtsine:SHAPE RAMP|TRIangle

[[:SOURce]:LFOOutput:SWEPtsine:SHAPE?

Description Set the shape of the sweep-sine waveform.

Query the shape of the sweep-sine waveform.

Parameter	Name	Type	Range	Default
	RAMP TRIangle	Discrete	RAMP TRIangle	TRIangle

- Explanation**
- The sweep shape decides the cycle mode of multiple sweeps.
 - TRIangle: select "Triangle" waveform. The sweep period always starts from the start frequency to the stop frequency and then returns back to the start frequency.
 - RAMP: select "Ramp" waveform. The sweep period always starts from the start frequency to the stop frequency.

Return Format The query returns RAMP or TRI.

Example :LFO:SWEP:SHAP TRI

:LFO:SWEP:SHAP?

[[:SOURce]:LFOOutput:SWEPtsine:SINGLE

Syntax [[:SOURce]:LFOOutput:SWEPtsine:SINGLE

Description Execute a single sweep.

- Explanation**
- If the current sweep mode is "Cont", sending this command will change the sweep mode to "Single". A sweep will be performed if the trigger condition is currently met.
 - If the current sweep mode is "Single", sending this command will enable a sweep if the trigger condition is currently met.

Related Command [\[\[:SOURce\]:SWEep:MODE](#)

[[:SOURce]:LFOutput:SWEPTsine:TRIGger

Syntax [:SOURce]:LFOutput:SWEPTsine:TRIGger AUTO|KEY|BUS|EXT
[:SOURce]:LFOutput:SWEPTsine:TRIGger?

Description Set the trigger mode of sweep-sine.

Query the trigger mode of sweep-sine.

Parameter

Name	Type	Range	Default
AUTO KEY BUS EXT	Discrete	AUTO KEY BUS EXT	AUTO

- Explanation**
- AUTO: select "Auto" trigger mode. The RF signal generator fulfills the trigger condition at any time and it will sweep according to the current setting once "Swp-Sine" is selected.
 - KEY: select "Key" trigger mode. If the sweep mode is set to "Cont", the instrument performs a sweep each time **Trigger** at the front panel is pressed. If the sweep mode is set to "Single", the instrument will perform a sweep and then stop each time **Trigger** at the front panel is pressed after the [\[:SOURce\]:LFOutput:SWEPTsine:SINGLE](#) command is sent and when the single sweep condition is met.
 - BUS: select "Bus" trigger mode. If the sweep mode is set to "Cont", the instrument performs a sweep each time the [*TRG](#) or [:TRIGger:LFOutput\[:IMMediate\]](#) command is sent. If the sweep mode is set to "Single", the instrument performs a sweep and then stops each time the [*TRG](#) command is sent after the [\[:SOURce\]:LFOutput:SWEPTsine:SINGLE](#) command is sent and when the single sweep condition is met.
 - EXT: select "Ext" trigger mode. The RF signal generator accepts the trigger signal input from the **[TRIGGER IN]** connector at the rear panel. If the sweep mode is set to "Cont", the instrument performs a sweep each time a TTL pulse signal with the specified polarity is received. If the sweep mode is set to "Single", the instrument performs a sweep and then stops each time a TTL pulse signal with the specified polarity is received after the [\[:SOURce\]:LFOutput:SWEPTsine:SINGLE](#) command is sent and when the single sweep condition is met.

Return Format The query returns the trigger mode of sweep-sine, for example, KEY.

Example :LFO:SWEP:TRIG KEY
:LFO:SWEP:TRIG?

Related Commands [\[:SOURce\]:LFOutput:SHAPE](#)
[\[:SOURce\]:LFOutput:SWEPTsine:SINGLE](#)
[\[:SOURce\]:SWEep:MODE](#)
[*TRG](#)
[:TRIGger:LFOutput\[:IMMediate\]](#)

[[:SOURce]:LFOOutput:SWEPTsine:XPOLar

Syntax [:SOURce]:LFOOutput:SWEPTsine:XPOLar NEG|POS

[:SOURce]:LFOOutput:SWEPTsine:XPOLar?

Description Set the external trigger polarity of sweep-sine.

Query the external trigger polarity of sweep-sine.

Parameter

Name	Type	Range	Default
NEG POS	Discrete	NEG POS	POS

- Explanation**
- The parameter NEG|POS can set the polarity of the external trigger signal of sweep-sine to "Neg" or "Pos".
 - This command is only valid when the trigger mode of sweep-sine is currently set to "Ext".

Return Format The query returns NEG or POS.

Example :LFO:SWEP:XPOL NEG

:LFO:SWEP:XPOL?

Related Command [\[:SOURce\]:LFOOutput:SWEPTsine:TRIGger](#)

[[:SOURce]:MODulation:STATe

Syntax [:SOURce]:MODulation:STATe ON|OFF|1|0

[:SOURce]:MODulation:STATe?

Description Turn on or off all the modulation outputs.

Query the on/off state of all the modulation outputs.

Parameter

Name	Type	Range	Default
ON OFF 1 0	Bool	ON OFF 1 0	OFF

- Explanation**
- ON: turn on all the modulation outputs. The backlight of the **MOD** output control key turns on.
 - OFF: turn off all the modulation outputs. The backlight of the **MOD** output control key turns off.

Return Format The query returns 1 or 0.

Example :MOD:STAT ON /*Turn on all the modulation outputs*/

:MOD:STAT? /*The query returns 1*/

[[:SOURce]:PHASe Command Subsystem

Command List:

- ◆ [\[:SOURce\]:PHASe](#)
- ◆ [\[:SOURce\]:PHASe:RESet](#)
- ◆ [\[:SOURce\]:PHASe:STEP\[:INCRement\]](#)

[[:SOURce]:PHASe]**Syntax** [[:SOURce]:PHASe <value>

[[:SOURce]:PHASe?

Description Set the phase offset of RF output.

Query the phase offset of RF output.

Parameter

Name	Type	Range	Default
<value>	Real	-720deg to 720deg	0deg

- Explanation**
- When <value> is set in "Number" form, the default unit is deg. Besides, <value> can also be set in "Number + Unit" form, for example, 35deg.
 - The default unit of the return value is deg.
 - After setting the RF phase offset, you can use the up/down direction keys or knob to modify the phase offset at the current step. At this point, you can query or set the current step using the [\[\[:SOURce\]:PHASe:STEP\[:INCRement\]\]](#) command.

Return Format The query returns the phase offset of RF output, for example, 35.000000.**Example** :PHAS 35

:PHAS?

Related Command [\[\[:SOURce\]:PHASe:STEP\[:INCRement\]\]](#)**[[:SOURce]:PHASe:RESet]****Syntax** [[:SOURce]:PHASe:RESet**Description** Reset the current phase offset to 0deg.**Related Command** [\[\[:SOURce\]:PHASe\]](#)

[[:SOURce]:PHASe:STEP[:INCRement]]

Syntax [[:SOURce]:PHASe:STEP[:INCRement] <value>
[[:SOURce]:PHASe:STEP[:INCRement]]?

Description Set the phase offset step of RF output.

Query the phase offset step of RF output.

Parameter

Name	Type	Range	Default
<value>	Real	0.01deg to 180deg	1deg

- Explanation**
- When <value> is set in "Number" form, the default unit is deg. Besides, <value> can also be set in "Number + Unit" form, for example, 5deg.
 - The default unit of the return value is deg.
 - After setting the phase offset step, you can use the up/down direction keys or knob to modify the phase offset at the current step. At this point, you can query or set the phase offset using the [\[\[:SOURce\]:PHASe\]](#) command.

Return Format The query returns the phase offset step, for example, 5.000000.

Example :PHAS:STEP 5
:PHAS:STEP?

Related Command [\[\[:SOURce\]:PHASe\]](#)

[[:SOURce]:PM Command Subsystem**Command List:**

- ◆ [\[\[:SOURce\]:PM:DEVIation\]](#)
- ◆ [\[\[:SOURce\]:PM:DEVIation:STEP\[:INCRement\]\]](#)
- ◆ [\[\[:SOURce\]:PM:FREQuency\]](#)
- ◆ [\[\[:SOURce\]:PM:FREQuency:STEP\[:INCRement\]\]](#)
- ◆ [\[\[:SOURce\]:PM:SOURce\]](#)
- ◆ [\[\[:SOURce\]:PM:STATe\]](#)
- ◆ [\[\[:SOURce\]:PM:WAVEform\]](#)

[[:SOURce]:PM:DEVIation]

Syntax [:SOURce]:PM:DEVIation <value>
[:SOURce]:PM:DEVIation?

Description Set the phase deviation of ØM.

Query the phase deviation of ØM.

Parameter	Name	Type	Range	Default
	<value>	Real	0rad to 20rad	6.28rad

- Explanation**
- When <value> is set in "Number" form, the default unit is rad. Besides, <value> can also be set in "Number + Unit" form, for example, 2rad.
 - The default unit of the return value is rad.
 - After setting the phase deviation, you can use the up/down direction keys or knob to modify the phase deviation at the current step. At this point, you can query or set the current step using the [\[:SOURce\]:PM:DEVIation:STEP\[:INCRement\]](#) command.

Return Format The query returns the phase deviation of ØM, for example, 2.000000.

Example :PM:DEV 2
:PM:DEV?

Related Command [\[:SOURce\]:PM:DEVIation:STEP\[:INCRement\]](#)

[[:SOURce]:PM:DEVIation:STEP[:INCRement]]

Syntax [:SOURce]:PM:DEVIation:STEP[:INCRement] <value>
[:SOURce]:PM:DEVIation:STEP[:INCRement]?

Description Set the ØM phase deviation step.

Query the ØM phase deviation step.

Parameter	Name	Type	Range	Default
	<value>	Real	0.01rad to 10rad	1rad

- Explanation**
- When <value> is set in "Number" form, the default unit is rad. Besides, <value> can also be set in "Number + Unit" form, for example, 3rad.
 - The default unit of the return value is rad.
 - After setting the phase deviation step, you can use the up/down direction keys or knob to modify the phase deviation at the current step. At this point, you can query or set the phase deviation using the [\[:SOURce\]:PM:DEVIation](#) command.

Return Format The query returns the phase deviation step (3.000000).

Example :PM:DEV:STEP 3
:PM:DEV:STEP?

Related Command [\[:SOURce\]:PM:DEVIation](#)

[[:SOURce]:PM:FREQuency]

Syntax [[:SOURce]:PM:FREQuency <value>

[[:SOURce]:PM:FREQuency?

Description Set the modulation frequency of $\emptyset M$.

Query the modulation frequency of $\emptyset M$.

Parameter

Name	Type	Range	Default
<value>	Real	100mHz to 1MHz (Sine) 100mHz to 20kHz (Square)	10kHz

- Explanation**
- When <value> is set in "Number" form, the default unit is Hz. Besides, <value> can also be set in "Number + Unit" form, for example, 20kHz.
 - The default unit of the return value is Hz.
 - After setting the modulation frequency, you can use the up/down direction keys or knob to modify the modulation frequency at the current step. At this point, you can query or set the current step using the [\[:SOURce\]:PM:FREQuency:STEP\[:INCRement\]](#) command.
 - This command is invalid when the $\emptyset M$ modulation source is set to "Ext".

Return Format The query returns the $\emptyset M$ modulation frequency, for example, 20000.

Example :PM:FREQ 20kHz

:PM:FREQ?

Related Commands [\[:SOURce\]:PM:FREQuency:STEP\[:INCRement\]](#)
[\[:SOURce\]:PM:SOURce](#)

[[:SOURce]:PM:FREQuency:STEP[:INCRement]]

Syntax [[:SOURce]:PM:FREQuency:STEP[:INCRement] <value>

[[:SOURce]:PM:FREQuency:STEP[:INCRement]?

Description Set the modulation frequency step of $\emptyset M$.

Query the modulation frequency step of $\emptyset M$.

Parameter

Name	Type	Range	Default
<value>	Real	100mHz to 500kHz	1kHz

- Explanation**
- When <value> is set in "Number" form, the default unit is Hz. Besides, <value> can also be set in "Number + Unit" form, for example, 5kHz.
 - The default unit of the return value is Hz.
 - After setting the modulation frequency step, you can use the up/down direction keys or knob to modify the modulation frequency at the current step. At this point, you can query or set the modulation frequency using the [\[:SOURce\]:PM:FREQuency](#) command.

Return Format The query returns the modulation frequency step of $\emptyset M$, for example, 5000.

Example :PM:FREQ:STEP 5kHz

:PM:FREQ:STEP?

Related Command [\[:SOURce\]:PM:FREQuency](#)

[[:SOURce]:PM:SOURce

Syntax [:SOURce]:PM:SOURce EXTernal|INTernal|INTernal,EXTernal
[:SOURce]:PM:SOURce?

Description Set the ØM modulation source.

Query the ØM modulation source.

Parameter	Name	Type	Range	Default
	EXTernal INTernal INTernal,EXTernal	Discrete	EXTernal INTernal INTernal,EXTernal	INTernal

- Explanation**
- EXTernal: select "Ext" modulation source. At this point, the external modulating signal is input from the **[EXT MOD INPUT]** connector.
 - INTernal: select "Int" modulation source. At this point, the modulating signal is provided inside the instrument and you can set the modulation frequency and modulation waveform of the modulating signal. Besides, when ØM and **[MOD]** are enabled at the same time, you can also use the [\[:SOURce\]:LFOutput:LEVel](#) command to set the amplitude of the modulating signal.
 - INTernal,EXTernal: select "Int & Ext" modulation source. At this point, you can operate internal and external modulation sources at the same time.

Return Format The query returns the ØM modulation source, for example, INT.

Example :PM:SOUR INT
:PM:SOUR?

Related Commands [\[:SOURce\]:PM:FREQuency](#)
[\[:SOURce\]:PM:WAVEform](#)
[\[:SOURce\]:LFOutput:LEVel](#)

[[:SOURce]:PM:STATe

Syntax [:SOURce]:PM:STATe ON|OFF|1|0
[:SOURce]:PM:STATe?

Description Turn on or off the ØM switch.

Query the state of the ØM switch.

Parameter	Name	Type	Range	Default
	ON OFF 1 0	Bool	ON OFF 1 0	OFF

- Explanation**
- ON: turn on the ØM switch and enable the ØM function.
 - OFF: turn off the ØM switch and disable the ØM function.

Return Format The query returns 1 or 0.

Example :PM:STAT ON /*Turn on the ØM switch*/
:PM:STAT? /*The query returns 1*/

[[:SOURce]:PM:WAVEform

Syntax [:SOURce]:PM:WAVEform SINE|SQUA
[:SOURce]:PM:WAVEform?

Description Set the modulation waveform of ØM.

Query the modulation waveform of ØM.

Parameter

Name	Type	Range	Default
SINE SQUA	Discrete	SINE SQUA	SINE

- Explanation**
- The parameter SINE|SQUA can set the modulation waveform of ØM to "Sine" or "Square".
 - This command is invalid when the ØM modulation source is set to "Ext".

Return Format The query returns SINE or SQUA.

Example :PM:WAVE SQUA
:PM:WAVE?

Related Command [\[:SOURce\]:PM:SOURce](#)

[[:SOURce]:PULM Command Subsystem

Command List^[3]:

- ◆ [\[:SOURce\]:PULM:DElay](#)
- ◆ [\[:SOURce\]:PULM:DElay:STEP](#)
- ◆ [\[:SOURce\]:PULM:DWIDth](#)
- ◆ [\[:SOURce\]:PULM:DWIDth:STEP](#)
- ◆ [\[:SOURce\]:PULM:MODE](#)
- ◆ [\[:SOURce\]:PULM:OUT:STATe](#)
- ◆ [\[:SOURce\]:PULM:PERiod](#)
- ◆ [\[:SOURce\]:PULM:PERiod:STEP](#)
- ◆ [\[:SOURce\]:PULM:POLarity](#)
- ◆ [\[:SOURce\]:PULM:SOURce](#)
- ◆ [\[:SOURce\]:PULM:STATe](#)
- ◆ [\[:SOURce\]:PULM:TRAIIn:LIST:COUNT](#)
- ◆ [\[:SOURce\]:PULM:TRAIIn:LIST:DElete](#)
- ◆ [\[:SOURce\]:PULM:TRAIIn:LIST:GET](#)
- ◆ [\[:SOURce\]:PULM:TRAIIn:LIST:INSErt](#)
- ◆ [\[:SOURce\]:PULM:TRAIIn:LIST:RUN](#)
- ◆ [\[:SOURce\]:PULM:TRIGger:DElay](#)
- ◆ [\[:SOURce\]:PULM:TRIGger:DElay:STEP](#)
- ◆ [\[:SOURce\]:PULM:TRIGger:EXTernal:GATE:POLarity](#)
- ◆ [\[:SOURce\]:PULM:TRIGger:EXTernal:SLOPe](#)
- ◆ [\[:SOURce\]:PULM:TRIGger:MODE](#)
- ◆ [\[:SOURce\]:PULM:WIDTh](#)
- ◆ [\[:SOURce\]:PULM:WIDTh:STEP](#)

Note^[3]: In this manual, you have to install the pulse train generator to use the commands related to "Pulse". Otherwise, the error message "No right to operate the system parameters." will be displayed in the text display area. For the detailed installation method of the pulse train generator, please refer to DSG3000 Hardware and Option Installation Instruction.

[[:SOURce]:PULM:DELay

Syntax [[:SOURce]:PULM:DELay <value>

[[:SOURce]:PULM:DELay?

Description Set the delay between the start of #1 pulse and the start of #2 pulse of the double pulse modulating signal.

Query the delay between the start of #1 pulse and the start of #2 pulse of the double pulse modulating signal.

Parameter

Name	Type	Range	Default
<value>	Real	20ns to 170s-20ns	600us

- Explanation**
- You can use this command to set the pulse delay when the modulation source is set to "Int" and the pulse mode is set to "Double". Otherwise, this command is invalid.
 - When <value> is set in "Number" form, the default unit is s. Besides, <value> can also be set in "Number + Unit" form, for example, 2000ms.
 - The default unit of the return value is s.
 - After setting the pulse delay, you can use the up/down direction keys or knob to modify the delay at the current step. At this point, you can query or set the current step using the [\[\[:SOURce\]:PULM:DELay:STEP](#) command.

Return Format The query returns the pulse delay of the double pulse modulating signal, for example, 2.

Example :PULM:DEL 2000ms

:PULM:DEL?

Related Commands [\[\[:SOURce\]:PULM:DELay:STEP](#)
[\[\[:SOURce\]:PULM:MODE](#)
[\[\[:SOURce\]:PULM:SOURce](#)

[[:SOURce]:PULM:DELay:STEP

Syntax [[:SOURce]:PULM:DELay:STEP <value>

[[:SOURce]:PULM:DELay:STEP?

Description Set the pulse delay step of the double pulse modulating signal.

Query the pulse delay step of the double pulse modulating signal.

Parameter

Name	Type	Range	Default
<value>	Real	10ns to 10s	100us

- Explanation**
- When <value> is set in "Number" form, the default unit is s. Besides, <value> can also be set in "Number + Unit" form, for example, 2000ms.
 - The default unit of the return value is s.
 - After setting the pulse delay step, you can use the up/down direction keys or knob to modify the delay at the current step. At this point, you can query or set the pulse delay using the [\[\[:SOURce\]:PULM:DELay](#) command.

Return Format The query returns the pulse delay step of the double pulse modulating signal, for example, 2.

Example :PULM:DEL:STEP 2000ms

:PULM:DEL:STEP?

Related Command [\[\[:SOURce\]:PULM:DELay](#)

[[:SOURce]:PULM:DWIDth

Syntax [:SOURce]:PULM:DWIDth <value>

[:SOURce]:PULM:DWIDth?

Description Set the width of #2 pulse of the double pulse modulating signal.

Query the width of #2 pulse of the double pulse modulating signal.

Parameter	Name	Type	Range	Default
	<value>	Real	10ns to 170s-10ns	200us

- Explanation**
- When the modulation source is set to "Int" and the pulse mode is set to "Double", you can use this command to set the width of #2 pulse. Otherwise, this command is invalid.
 - When <value> is set in "Number" form, the default unit is s. Besides, <value> can also be set in "Number + Unit" form, for example, 5000ms.
 - The default unit of the return value is s.
 - After setting the width of #2 pulse, you can use the up/down direction keys or knob to modify the width at the current step. At this point, you can query or set the current step using the [\[:SOURce\]:PULM:DWIDth:STEP](#) command.
 - The width of #2 pulse is limited by the minimum pulse width, pulse period and delay and the three fulfill the following relations.
 - #2 pulse width ≥ #2 minimum pulse width
 - #2 pulse width ≤ pulse period – delay – 10ns

Return Format The query returns the width of #2 pulse of the double pulse modulating signal, for example, 5.

Example :PULM:DWID 5000ms

:PULM:DWID?

Related Commands [\[:SOURce\]:PULM](#)
[\[:SOURce\]:PULM:DWIDth:STEP](#)
[\[:SOURce\]:PULM:PERiod](#)
[\[:SOURce\]:PULM:SOURce](#)
[\[:SOURce\]:PULM:MODE](#)

[[:SOURce]:PULM:DWIDth:STEP

Syntax [:SOURce]:PULM:DWIDth:STEP <value>

[:SOURce]:PULM:DWIDth:STEP?

Description Set the #2 pulse width step of the double pulse modulating signal.

Query the #2 pulse width step of the double pulse modulating signal.

Parameter

Name	Type	Range	Default
<value>	Real	10ns to 10s	100us

- Explanation**
- When <value> is set in "Number" form, the default unit is s. Besides, <value> can also be set in "Number + Unit" form, for example, 3000ms.
 - The default unit of the return value is s.
 - After setting the #2 pulse width step, you can use the up/down direction keys or knob to modify the width at the current step. At this point, you can query or set the #2 pulse width using the [\[:SOURce\]:PULM:DWIDth](#) command.

Return Format The query returns the #2 pulse width step of the double pulse modulating signal, for example, 3.

Example :PULM:DWID:STEP 3000ms

:PULM:DWID:STEP?

Related Command [\[:SOURce\]:PULM:DWIDth](#)

[[:SOURce]:PULM:MODE

Syntax [:SOURce]:PULM:MODE DOUBle|SINGle|TRAIIn

[:SOURce]:PULM:MODE?

Description Set the mode of pulse modulation.

Query the mode of pulse modulation.

Parameter

Name	Type	Range	Default
DOUBle SINGle TRAIIn	Discrete	DOUBle SINGle TRAIIn	SINGle

- Explanation**
- DOUBle: set the pulse mode to "Double" to enable the double pulse modulation mode.
 - SINGle: set the pulse mode to "Single" to enable the single pulse modulation mode.
 - TRAIIn: set the pulse mode to "Train" to enable the train modulation mode. At this point, you can use the [\[:SOURce\]:PULM:TRAIIn:LIST:INSERt](#) command to define the desired pulse train.
 - This command is invalid when "Ext" modulation source is selected.

Return Format The query returns SINGLE, DOUBLE or TRAIN.

Example :PULM:MODE DOUB

:PULM:MODE?

Related Commands [\[:SOURce\]:PULM:SOURce](#)
[\[:SOURce\]:PULM:TRAIIn:LIST:INSERt](#)

[[:SOURce]:PULM:OUT:STATe

Syntax [:SOURce]:PULM:OUT:STATe ON|OFF|0|1
[:SOURce]:PULM:OUT:STATe?

Description Turn on or off the pulse output switch.

Query the state of the pulse output switch.

Parameter	Name	Type	Range	Default
	ON OFF 0 1	Bool	ON OFF 0 1	OFF

- Explanation**
- ON|1: turn on the pulse output switch. At this point, the RF signal generator can output the pulse signal generated by the internal pulse generator via the **[PULSE IN/OUT]** connector at the rear panel. Note that this output signal is related to the "Mode" setting.
 - OFF|0: turn off the pulse output switch.
 - This command is invalid when "Ext" modulation source is selected.

Return Format The query returns 1 or 0.

Example :PULM:OUT:STAT ON /*Turn on the pulse output switch*/
:PULM:OUT:STAT? /*The query returns 1*/

Related Commands [\[:SOURce\]:PULM:MODE](#)
[\[:SOURce\]:PULM:SOURce](#)

[[:SOURce]:PULM:PERiod

Syntax [:SOURce]:PULM:PERiod <value>

[:SOURce]:PULM:PERiod?

Description Set the period of pulse modulation.

Query the period of pulse modulation.

Parameter	Name	Type	Range	Default
	<value>	Real	40ns to 170s	500us

- Explanation**
- When <value> is set in "Number" form, the default unit is s. Besides, <value> can also be set in "Number + Unit" form, for example, 1000ms.
 - The default unit of the return value is s.
 - The single pulse or double pulse modulation period is related to the current "Mode" setting.
 - After setting the pulse period, you can use the up/down direction keys or knob to modify the period at the current step. At this point, you can query or set the current step using the [\[:SOURce\]:PULM:PERiod:STEP](#) command.
 - This command is invalid when "Ext" modulation source is selected or "Train" pulse mode is selected.

Return Format The query returns the period of pulse modulation, for example, 1.

Example :PULM:PER 1000ms

:PULM:PER?

Related Commands [\[:SOURce\]:PULM:PERiod:STEP](#)
[\[:SOURce\]:PULM:SOURce](#)
[\[:SOURce\]:PULM:MODE](#)

[[:SOURce]:PULM:PERiod:STEP

Syntax [[:SOURce]:PULM:PERiod:STEP <value>

[[:SOURce]:PULM:PERiod:STEP?

Description Set the step of the pulse modulation period.

Query the step of the pulse modulation period.

Parameter

Name	Type	Range	Default
<value>	Real	10ns to 10s	100us

- Explanation**
- When <value> is set in "Number" form, the default unit is s. Besides, <value> can also be set in "Number + Unit" form, for example, 5000ms.
 - The default unit of the return value is s.
 - After setting the step of the pulse period, you can use the up/down direction keys or knob to modify the period at the current step. At this point, you can query or set the pulse period using the [\[:SOURce\]:PULM:PERiod](#) command.

Return Format The query returns the step of the pulse modulation period, for example, 5.

Example :PULM:PER:STEP 5000ms

:PULM:PER:STEP?

Related Command [\[:SOURce\]:PULM:PERiod](#)

[[:SOURce]:PULM:POLarity

Syntax [[:SOURce]:PULM:POLarity NORMal|INVerse

[[:SOURce]:PULM:POLarity?

Description Set the polarity of the pulse modulation.

Query the polarity of the pulse modulation.

Parameter

Name	Type	Range	Default
NORMal INVerse	Discrete	NORMal INVerse	NORMal

Explanation The parameter NORMal|INVerse can set the polarity of the current pulse modulating signal to "Normal" or "Inverse".

Return Format The query returns NORMAL or INVERSE.

Example :PULM:POL INV

:PULM:POL?

[[:SOURce]:PULM:SOURce

Syntax [:SOURce]:PULM:SOURce INTernal|EXTernal
[:SOURce]:PULM:SOURce?

Description Set the pulse modulation source.

Query the pulse modulation source.

Parameter

Name	Type	Range	Default
INTernal EXTernal	Discrete	INTernal EXTernal	INTernal

- Explanation**
- INTernal: select "Int" modulation source. At this point, the modulating signal is provided by the internal pulse generator. When the "Pulse Out" is turned on, the pulse signal generated by the internal pulse generator can be output via the **[PULSE IN/OUT]** connector at the rear panel.
 - EXTernal: select "Ext" modulation source. At this point, the RF signal generator receives the external pulse modulating signal input from the **[PULSE IN/OUT]** connector at the rear panel.

Return Format The query returns the pulse modulation source (INT or EXT).

Example :PULM:SOUR EXT
:PULM:SOUR?

Related Command [\[:SOURce\]:PULM:OUT:STATe](#)

[[:SOURce]:PULM:STATe

Syntax [:SOURce]:PULM:STATe ON|OFF|1|0
[:SOURce]:PULM:STATe?

Description Set the state of the pulse modulation.

Query the state of the pulse modulation.

Parameter

Name	Type	Range	Default
ON OFF 1 0	Bool	ON OFF 1 0	OFF

- Explanation**
- ON: turn on the pulse modulation switch to enable the pulse modulation function.
 - OFF: turn off the pulse modulation switch to disable the pulse modulation function.

Return Format The query returns 1 or 0.

Example :PULM:STAT ON /*Turn on the pulse modulation switch*/
:PULM:STAT? /*Query the state of the pulse modulation and the query returns 1*/

[[:SOURce]:PULM:TRAI:LIST:COUNT

Syntax [[:SOURce]:PULM:TRAI:LIST:COUNT?

Description Acquire the total number of rows of the current pulse list.

Explanation You can use the [\[:SOURce\]:PULM:TRAI:LIST:DELeTe](#) command to reduce the number of rows of the list or use the [\[:SOURce\]:PULM:TRAI:LIST:INSERt](#) command to increase the number of rows of the list.

Return Format The query returns an integer, for example, 2.

Related Commands [\[:SOURce\]:PULM:TRAI:LIST:DELeTe](#)
[\[:SOURce\]:PULM:TRAI:LIST:INSERt](#)

[[:SOURce]:PULM:TRAI:LIST:DELeTe

Syntax [[:SOURce]:PULM:TRAI:LIST:DELeTe <Index>

Description Delete the pulse value of the specified row in the current pulse list.

Parameter	Name	Type	Range	Default
	<Index>	Integer	1 to the total number of rows of the current pulse list	NULL

Explanation

- <Index> denotes the row number of the pulse list.
- You can reduce a row of pulse value using this command. You can add a row of pulse value using the [\[:SOURce\]:PULM:TRAI:LIST:INSERt](#) command.

Example :PULM:TRA:LIST:DEL 2 /*Delete the pulse value of the second row in the current pulse list */

Related Commands [\[:SOURce\]:PULM:TRAI:LIST:COUNT](#)
[\[:SOURce\]:PULM:TRAI:LIST:INSERt](#)

[[:SOURce]:PULM:TRAI:LIST:GET

Syntax [[:SOURce]:PULM:TRAI:LIST:GET <Start>,<Count>

Description Acquire the pulse list data within the specified range.

Parameter	Name	Type	Range	Default
	<Start>	Integer	1 to the total number of rows in the current pulse list	NULL
	<Count>	Integer	1 to the total number of rows in the current pulse list	NULL

Explanation

- <Start>: the number of the start row of the train list data to be acquired.
- <Count>: the total number of rows of the train list data to be acquired.

Return Format The query returns the pulse list data acquired, for example,

NO.2:200.00 us , 30.00 ms, 1, 30.20 ms

NO.3:300.00 us , 40.00 ms, 1, 40.30 ms

Example :PULM:TRA:LIST:GET 2,2 /*Acquire 2 rows of pulse data in the pulse list starting from the second row*/

Related Command [\[:SOURce\]:PULM:TRAI:LIST:COUNT](#)

[[:SOURce]:PULM:TRAI:n:LIST:INSERt

Syntax [[:SOURce]:PULM:TRAI:n:LIST:INSERt <OnTime>,<OffTime>,<Repeat>

Description Insert a row of pulse list data.

Parameter

Name	Type	Range	Default
<OnTime>	Real	20ns to 170s-20ns	500us
<OffTime>	Real	20ns to 170s-20ns	500us
<Repeat>	Integer	1 to 256	1

- Explanation**
- <OnTime>: set the duration of the positive pulse.
 - <OffTime>: set the duration of the negative pulse.
 - <Repeat>: set the repetition times of this pulse.

Example :PULM:TRA:LIST:INSE 5.5s,2.5s,2 /*Insert a row of pulse value before the row currently selected: positive delay 5.5s, negative delay 2.5s and repetition times 2*/

[[:SOURce]:PULM:TRAI:n:LIST:RUN

Syntax [[:SOURce]:PULM:TRAI:n:LIST:RUN

Description Execute the pulse list currently edited.

Explanation You can update the internal modulating signal as the current pulse list data using this command.

[[:SOURce]:PULM:TRIGger:DELay

Syntax [[:SOURce]:PULM:TRIGger:DELay <value>

[[:SOURce]:PULM:TRIGger:DELay?

Description Set the pulse trigger delay.

Query the pulse trigger delay.

Parameter

Name	Type	Range	Default
<value>	Real	10ns to 170s	100us

- Explanation**
- You can use this command to set the delay between the start of the external modulating signal and the start of #1 pulse of the pulse modulating signal when "Int" modulation source is selected and "Ext Trig" mode is selected.
 - When <value> is set in "Number" form, the default unit is s. Besides, <value> can also be set in "Number + Unit" form, for example, 30ns.
 - The default unit of the return value is s.
 - After setting the trigger delay, you can use the up/down direction keys or knob to modify the trigger delay at the current step. At this point, you can query or set the current step using the [\[\[:SOURce\]:PULM:TRIGger:DELay:STEP](#) command.

Return Format The query returns the trigger delay, for example, 3.

Example :PULM:TRIG:DEL 3 /*Set the trigger delay to 3s*/

:PULM:TRIG:DEL?

Related Commands [\[\[:SOURce\]:PULM:SOURce](#)
[\[\[:SOURce\]:PULM:TRIGger:DELay:STEP](#)
[\[\[:SOURce\]:PULM:TRIGger:MODE](#)

[[:SOURce]:PULM:TRIGger:DELay:STEP

Syntax [:SOURce]:PULM:TRIGger:DELay:STEP <value>

[:SOURce]:PULM:TRIGger:DELay:STEP?

Description Set the pulse trigger delay step.

Query the pulse trigger delay step.

Parameter	Name	Type	Range	Default
	<value>	Real	10ns to 10s	100us

- Explanation**
- When <value> is set in "Number" form, the default unit is s. Besides, <value> can also be set in "Number + Unit" form, for example, 50ms.
 - The default unit of the return value is s.
 - After setting the trigger delay step, you can use the up/down direction keys or knob to modify the trigger delay at the current step. At this point, you can query or set the trigger delay using the [\[:SOURce\]:PULM:TRIGger:DELay](#) command.

Return Format The query returns the trigger delay step, for example, 5.

Example :PULM:TRIG:DEL:STEP 5 /*Set the trigger delay step to 5s*/

:PULM:TRIG:DEL:STEP?

Related Command [\[:SOURce\]:PULM:TRIGger:DELay](#)

[[:SOURce]:PULM:TRIGger:EXTernal:GATE:POLarity

Syntax [:SOURce]:PULM:TRIGger:EXTernal:GATE:POLarity NORMal|INVerse

[:SOURce]:PULM:TRIGger:EXTernal:GATE:POLarity?

Description Set the polarity of the external gated signal.

Query the polarity of the external gated signal.

Parameter	Name	Type	Range	Default
	NORMal INVerse	Discrete	NORMal INVerse	NORMal

- Explanation**
- When the trigger mode of pulse modulation is set to "Ext Gate", the RF signal generator receives the external gated signal input from the **[PULSE IN/OUT]** connector at the rear panel. At this point, you can use this command to set the polarity of the external gated signal.
 - The parameter NORMal|INVerse can set the polarity of the external gated signal to "Normal" or "Inverse".
 - This command is invalid when "Ext" modulation source is selected.

Return Format The query returns NORMAL or INVERSE.

Example :PULM:TRIG:EXT:GATE:POL INV

:PULM:TRIG:EXT:GATE:POL?

Related Commands [\[:SOURce\]:PULM:TRIGger:MODE](#)
[\[:SOURce\]:PULM:SOURce](#)

[[:SOURce]:PULM:TRIGger:EXTernal:SLOPe

Syntax [:SOURce]:PULM:TRIGger:EXTernal:SLOPe POSitive|NEGative
[:SOURce]:PULM:TRIGger:EXTernal:SLOPe?

Description Set the slope of the valid edge of the external trigger pulse.

Query the slope of the valid edge of the external trigger pulse.

Parameter	Name	Type	Range	Default
	POSitive NEGative	Discrete	POSitive NEGative	POSitive

- Explanation**
- When the trigger mode of pulse modulation is set to "Ext Trig", the RF signal generator receives the external trigger signal input from the **[PULSE IN/OUT]** connector at the rear panel. At this point, you can use this command to set the trigger edge of the external trigger signal.
 - The parameter POSitive|NEGative can set the slope of the valid edge of the external trigger pulse to "Pos" or "Neg".
 - This command is invalid when "Ext" modulation source is selected.

Return Format The query returns POSITIVE or NEGATIVE.

Example :PULM:TRIG:EXT:SLOP NEG
:PULM:TRIG:EXT:SLOP?

Related Commands [\[:SOURce\]:PULM:TRIGger:MODE](#)
[\[:SOURce\]:PULM:SOURce](#)

[[:SOURce]:PULM:TRIGger:MODE

Syntax [:SOURce]:PULM:TRIGger:MODE AUTO|EXTernal|EGATe|KEY|BUS
[:SOURce]:PULM:TRIGger:MODE?

Description Set the trigger mode of pulse modulation.

Query the trigger mode of pulse modulation.

Parameter

Name	Type	Range	Default
AUTO EXTernal EGATe KEY BUS	Discrete	AUTO EXTernal EGATe KEY BUS	AUTO

- Explanation**
- AUTO: select "Auto" trigger mode. At this point, the RF signal generator meets the trigger condition at any time and can perform pulse modulation continuously.
 - EXTernal: select "Ext Trig" mode. At this point, the RF signal generator receives the external trigger signal input from the **[PULSE IN/OUT]** connector at the rear panel. The instrument starts a pulse modulation each time a TTL pulse with the specified polarity is received. To specify the slope of the TTL pulse, use the [\[:SOURce\]:PULM:TRIGger:EXTernal:SLOPe](#) command to select the "Pos" or "Neg".
 - EGATe: select "Ext Gate" mode. At this point, the RF signal generator receives the external gated signal input from the **[PULSE IN/OUT]** connector at the rear panel. The instrument starts a pulse modulation within its valid level each time a gated signal with the specified polarity is received. To specify the polarity of the external gated signal, use the [\[:SOURce\]:PULM:TRIGger:EXTernal:GATE:POLarity](#) command to select "Normal" or "Inverse".
 - KEY: select "Key" trigger mode. At this point, the instrument starts a pulse modulation each time **Trigger** at the front panel is pressed.
 - BUS: select "Bus" trigger mode. At this point, the instrument starts a pulse modulation each time the [*TRG](#) or [:TRIGger:PULSe\[:IMMEDIATE\]](#) command is sent.
 - This command is invalid when "Ext" modulation source is selected.

Return Format The query returns the trigger mode of pulse modulation, for example, EGAT.

Example :PULM:TRIG:MODE EGAT
:PULM:TRIG:MODE?

Related Commands

[\[:SOURce\]:PULM:TRIGger:EXTernal:GATE:POLarity](#)
[\[:SOURce\]:PULM:TRIGger:EXTernal:SLOPe](#)
[\[:SOURce\]:PULM:SOURce](#)
[*TRG](#)
[:TRIGger:PULSe\[:IMMEDIATE\]](#)

[[:SOURce]:PULM:WIDTH

Syntax [:SOURce]:PULM:WIDTH <value>

[:SOURce]:PULM:WIDTH?

Description Set the width of the pulse modulating signal.

Query the width of the pulse modulating signal.

Parameter

Name	Type	Range	Default
<value>	Real	10ns to 170s-10ns	500us

- Explanation**
- When <value> is set in "Number" form, the default unit is s. Besides, <value> can also be set in "Number + Unit" form, for example, 2000ms.
 - The default unit of the return value is s.
 - When the modulation source is set to "Int", you can use this command to set the width of single pulse if the pulse type is set to "Single" and you can use this command to set the width of #1 pulse if the pulse type is set to "Double". Otherwise, this command is invalid.
 - After setting the pulse width, you can use the up/down direction keys or knob to modify the pulse width at the current step. At this point, you can query or set the current step using the [\[:SOURce\]:PULM:WIDTH:STEP](#) command.
 - The single pulse width is limited by the minimum pulse width and pulse period and the three fulfill the following relations.
Pulse Width \geq Minimum Pulse Width
Pulse Width \leq Pulse Period – 10ns
 - The width of #1 pulse of double pulse is limited by the minimum pulse width and delay.
Pulse Width \geq Minimum Pulse Width
Pulse Width \leq Delay – 10 ns

Return Format The query returns the width of the pulse modulating signal, for example, 2.

Example :PULM:WIDT 2

:PULM:WIDT?

Related Commands

[\[:SOURce\]:PULM](#)

[\[:SOURce\]:PULM:MODE](#)

[\[:SOURce\]:PULM:PERiod](#)

[\[:SOURce\]:PULM:SOURce](#)

[\[:SOURce\]:PULM:WIDTH:STEP](#)

[[:SOURce]:PULM:WIDTH:STEP

Syntax [[:SOURce]:PULM:WIDTH:STEP <value>

[[:SOURce]:PULM:WIDTH:STEP?

Description Set the width step of the pulse modulating signal.

Query the width step of the pulse modulating signal.

Parameter	Name	Type	Range	Default
	<value>	Real	10ns to 10s	100us

- Explanation**
- When <value> is set in "Number" form, the default unit is s. Besides, <value> can also be set in "Number + Unit" form, for example, 3000ms.
 - The default unit of the return value is s.
 - After setting the pulse width step, you can use the up/down direction keys or knob to modify the pulse width at the current step. At this point, you can query or set the pulse width using the [\[\[:SOURce\]:PULM:WIDTH](#) command.

Return Format The query returns the width step of the pulse modulating signal, for example, 3.

Example :PULM:WIDT:STEP 3

:PULM:WIDT:STEP?

Related Command [\[\[:SOURce\]:PULM:WIDTH](#)

[[:SOURce]:SWEep Command Subsystem

Command List:

- ◆ [\[:SOURce\]:SWEep:DIRection](#)
- ◆ [\[:SOURce\]:SWEep:EXECute](#)
- ◆ [\[:SOURce\]:SWEep:LIST:ADDList](#)
- ◆ [\[:SOURce\]:SWEep:LIST:CPOint](#)
- ◆ [\[:SOURce\]:SWEep:LIST:DELeTe](#)
- ◆ [\[:SOURce\]:SWEep:LIST:INITialize:FSep](#)
- ◆ [\[:SOURce\]:SWEep:LIST:INITialize:PRESet](#)
- ◆ [\[:SOURce\]:SWEep:LIST:LIST](#)
- ◆ [\[:SOURce\]:SWEep:MODE](#)
- ◆ [\[:SOURce\]:SWEep:POINT:TRIGger:TYPE](#)
- ◆ [\[:SOURce\]:SWEep:RESet\[:ALL\]](#)
- ◆ [\[:SOURce\]:SWEep:STATe](#)
- ◆ [\[:SOURce\]:SWEep:STEP:DWELl](#)
- ◆ [\[:SOURce\]:SWEep:STEP:DWELl:STEP](#)
- ◆ [\[:SOURce\]:SWEep:STEP:POINTs](#)
- ◆ [\[:SOURce\]:SWEep:STEP:POINTs:STEP](#)
- ◆ [\[:SOURce\]:SWEep:STEP:SHAPE](#)
- ◆ [\[:SOURce\]:SWEep:STEP:SPACing](#)
- ◆ [\[:SOURce\]:SWEep:STEP:START:FREQuency](#)
- ◆ [\[:SOURce\]:SWEep:STEP:START:FREQuency:STEP](#)
- ◆ [\[:SOURce\]:SWEep:STEP:START:LEVel](#)
- ◆ [\[:SOURce\]:SWEep:STEP:START:LEVel:STEP](#)
- ◆ [\[:SOURce\]:SWEep:STEP:STOP:FREQuency](#)
- ◆ [\[:SOURce\]:SWEep:STEP:STOP:FREQuency:STEP](#)
- ◆ [\[:SOURce\]:SWEep:STEP:STOP:LEVel](#)
- ◆ [\[:SOURce\]:SWEep:STEP:STOP:LEVel:STEP](#)
- ◆ [\[:SOURce\]:SWEep:SWEep:TRIGger:TYPE](#)
- ◆ [\[:SOURce\]:SWEep:TYPE](#)

[[:SOURce]:SWEep:DIRection

Syntax [:SOURce]:SWEep:DIRection FWD|REV

[:SOURce]:SWEep:DIRection?

Description Set the sweep direction.

Query the sweep direction.

Parameter

Name	Type	Range	Default
FWD REV	Discrete	FWD REV	FWD

- Explanation**
- FWD: select "Fwd" sweep direction. At this point, the RF signal generator sweeps from the start frequency or start level to the stop frequency or stop level.
 - REV: select "Down" sweep direction. At this point, the RF signal generator sweeps from the stop frequency or stop level to the start frequency or stop level.

Return Format The query returns FWD or REV.

Example :SWE:DIR FWD /*Set the sweep direction to "Fwd"*/

:SWE:DIR? /*The query returns FWD*/

[[:SOURce]:SWEep:EXECute

Syntax [:SOURce]:SWEep:EXECute

Description Execute a sweep.

- Explanation**
- If the current sweep mode is "cont", sending this command will change the sweep mode to "Single". The instrument starts a sweep if the trigger condition is currently met.
 - If the current sweep mode is "Single", the instrument starts a sweep if the trigger condition is met after sending this command.

Related Command [\[:SOURce\]:SWEep:MODE](#)

[[:SOURce]:SWEep:LIST:ADDList

Syntax [[:SOURce]:SWEep:LIST:ADDList <Freq>,<Ampt>,<Time>

Description Add a row of sweep values.

Parameter

Name	Type	Range	Default
<Freq>	Real	9kHz to 6GHz	6GHz
<Ampt>	Real	-140dBm to 25dBm	-140dBm
<Time>	Real	20ms to 100s	500ms

- Explanation**
- When editing the sweep list, you can use this command to add a row of sweep values. At this point, the total number of rows of the sweep list increases by one.
 - <Freq>: set the frequency of the sweep point.
 - <Ampt>: set the amplitude corresponding to the frequency point.
 - <Time>: set the duration of a sweep step.

Example :SWEep:LIST:ADDList 1M,10,1s /*Add a row of sweep values: frequency 1MHz, amplitude 10dBm, dwell time 1s*/

[[:SOURce]:SWEep:LIST:CPOint

Syntax [[:SOURce]:SWEep:LIST:CPOint?

Description Query the total number of points in the current sweep list.

Explanation You can use the [\[:SOURce\]:SWEep:LIST:DELeTe](#) command to delete a row of sweep values or use the [\[:SOURce\]:SWEep:LIST:ADDList](#) command to add a row of sweep values.

Return Format The query returns the total number of sweep points in the sweep list, for example, 5.

Related Commands [\[:SOURce\]:SWEep:LIST:DELeTe](#)
[\[:SOURce\]:SWEep:LIST:ADDList](#)

[[:SOURce]:SWEep:LIST:DELeTe

Syntax [[:SOURce]:SWEep:LIST:DELeTe <ListNum>

Description Delete a row of sweep values.

Parameter

Name	Type	Range	Default
<ListNum>	Integer	1 to the total number of rows in the current list	NULL

- Explanation**
- <ListNum> denotes the row number (namely the number of sweep points) in the sweep list. The number of sweep points in the sweep list can not exceed 6001.
 - You can use this command to reduce the number of rows in the list and you can use the [\[:SOURce\]:SWEep:LIST:ADDList](#) command to increase the number of rows in the list.

Example :SWE:LIST:DEL 2 /*Delete the sweep values of the second row in the sweep list*/

Related Commands [\[:SOURce\]:SWEep:LIST:ADDList](#)
[\[:SOURce\]:SWEep:LIST:CPOint](#)

[[:SOURce]:SWEep:LIST:INITialize:FSTep

Syntax [[:SOURce]:SWEep:LIST:INITialize:FSTep

Description Recalculate the data point set in the current step sweep to generate a new sweep list.

- Explanation**
- In the new sweep list, "ListNum" depends on the "Points" of the step sweep.
 - "Frequency" depends on the "Start Frequency" and "Stop Frequency" of the step sweep.
 - "Amplitude" depends on the "start Level" and "Stop Level" of the step sweep.
 - "Time" depends on the "Dwell Time" of the step sweep.

Related Commands

- [\[:SOURce\]:SWEep:STEP:DWELl](#)
- [\[:SOURce\]:SWEep:STEP:POINTs](#)
- [\[:SOURce\]:SWEep:STEP:START:FREQuency](#)
- [\[:SOURce\]:SWEep:STEP:START:LEVel](#)
- [\[:SOURce\]:SWEep:STEP:STOP:FREQuency](#)
- [\[:SOURce\]:SWEep:STEP:STOP:LEVel](#)

[[:SOURce]:SWEep:LIST:INITialize:PRESet

Syntax [[:SOURce]:SWEep:LIST:INITialize:PRESet

Description Reset the sweep list to factory setting.

- Explanation**
- After resetting the sweep list using this command, the sweep list only contains one frequency point (6GHz) and level point (-140dBm).
 - You can use the [\[:SOURce\]:SWEep:LIST:ADDList](#) and [\[:SOURce\]:SWEep:LIST:DELeTe](#) commands to re-edit the current sweep list.

Related Commands

- [\[:SOURce\]:SWEep:LIST:ADDList](#)
- [\[:SOURce\]:SWEep:LIST:DELeTe](#)

[[:SOURce]:SWEep:LIST:LIST

Syntax [[:SOURce]:SWEep:LIST:LIST? <Start>,<Count>

Description Acquire the sweep values within the specified range of the sweep list.

Parameter	Name	Type	Range	Default
	<Start>	Integer	1 to total number of rows in the current list	NULL
	<Count>	Integer	1 to total number of rows in the current list	NULL

- Explanation**
- <Start>: denote the number of the start row of the sweep data to be acquired.
 - <Count>: denote the total number of rows of the sweep data to be acquired.

Return Format The query returns the sweep values acquired, for example,

NO.1:2000000 , 11.000000, 1

NO.2:3000000 , 12.000000, 1

NO.3:4000000 , 13.000000, 1

Example :SWEep:LIST:LIST? 2,3 /*Acquire 3 rows of sweep values starting from the second row in the sweep list */

[[:SOURce]:SWEep:MODE

Syntax [[:SOURce]:SWEep:MODE CONTInue|SINGle

[[:SOURce]:SWEep:MODE?

Description Set the sweep mode.

Query the sweep mode.

Parameter	Name	Type	Range	Default
	CONTInue SINGle	Discrete	CONTInue SINGle	CONTInue

- Explanation**
- CONTInue: select "Cont" mode. The instrument sweeps continuously according to the current setting when the trigger condition is met.
 - SINGle: select "Single" mode. The instrument performs a sweep according to the current setting and then stops when the trigger condition is met.

Return Format The query returns the sweep mode (CONT or SING).

Example :SWE:MODE CONT

:SWE:MODE?

[[:SOURce]:SWEep:POINt:TRIGger:TYPE

Syntax [:SOURce]:SWEep:POINt:TRIGger:TYPE AUTO|KEY|BUS|EXT
[:SOURce]:SWEep:POINt:TRIGger:TYPE?

Description Set the point trigger type of the sweep.

Query the point trigger type of the sweep.

Parameter

Name	Type	Range	Default
AUTO KEY BUS EXT	Discrete	AUTO KEY BUS EXT	AUTO

Explanation

- AUTO: select "Auto" trigger mode. If the sweep mode is set to "cont", the instrument sweeps each sweep point continuously within a sweep period when a sweep type is selected. If the sweep mode is set to "Single", the instrument performs a sweep and then stops after the [\[:SOURce\]:SWEep:EXECute](#) command is sent and when the single sweep condition is met.
- KEY: select "Key" trigger mode. If the sweep mode is set to "Cont", the instrument starts to sweep a sweep point each time **Trigger** at the front panel is pressed. If the sweep mode is set to "Single", the instrument sweeps a point each time **Trigger** at the front panel is pressed and stops after a sweep period after the [\[:SOURce\]:SWEep:EXECute](#) command is sent and when the single sweep condition is met.
- BUS: select "Bus" trigger mode. If the sweep mode is set to "Cont", the instrument starts to sweep a point each time the [*TRG](#) or [:TRIGger\[:SWEep\]\[:IMMEDIATE\]](#) command is sent. If the sweep mode is set to "Single", the instrument sweeps a point each time the [*TRG](#) or [:TRIGger\[:SWEep\]\[:IMMEDIATE\]](#) command is sent and stops after a sweep period after the [\[:SOURce\]:SWEep:EXECute](#) command is sent and when the single sweep condition is met.
- EXT: select "Ext" trigger mode. The RF signal generator receives the trigger signal input from the **[TRIGGER IN]** connector at the rear panel. If the sweep mode is set to "Cont", the instrument starts to sweep a point each time a TTL pulse signal with the specified polarity is received. If the sweep mode is set to "Single", the instrument sweeps a point each time a TTL pulse signal with the specified polarity is received and stops after a sweep period after the [\[:SOURce\]:SWEep:EXECute](#) command is sent and when the single sweep condition is met.

Note: The above explanations are only valid when the trigger mode of the corresponding sweep period is met.

- When executing the sweep operation, the priority of the required conditions is: single sweep → trigger mode → point trigger mode.

Return Format The query returns the point trigger type, for example, AUTO.

Example :SWE:POIN:TRIG:TYPE AUTO
:SWE:POIN:TRIG:TYPE?

Related Commands

[\[:SOURce\]:SWEep:EXECute](#)
[\[:SOURce\]:SWEep:MODE](#)
[\[:SOURce\]:SWEep:SWEEP:TRIGger:TYPE](#)
[*TRG](#)
[:TRIGger\[:SWEep\]\[:IMMEDIATE\]](#)

[[:SOURce]:SWEep:RESet[:ALL]]

Syntax [[:SOURce]:SWEep:RESet[:ALL]]

Description Reset all the sweeps to the start point.

- Explanation**
- If the current sweep direction is "Fwd", the instrument will stop the current sweep and sweep from the start frequency or start level after sending this command.
 - If the current sweep direction is "Down", the instrument will stop the current sweep and sweep from the stop frequency or stop level after sending this command.

Related Command [\[:SOURce\]:SWEep:DIRection](#)

[[:SOURce]:SWEep:STATe

Syntax [[:SOURce]:SWEep:STATe OFF|FREQuency|LEVel[,FREQuency]

[[:SOURce]:SWEep:STATe?

Description Set the sweep state.

Query the sweep state.

Parameter

Name	Type	Range	Default
OFF FREQuency LEVel[,FREQuency]	Discrete	OFF FREQuency LEVel LEVel,FREQuency	OFF

- Explanation**
- OFF: turn off the sweep function.
 - FREQuency: enable the frequency sweep function.
 - LEVel: enable the amplitude sweep function.
 - LEVel,FREQuency: enable the frequency and amplitude sweep functions at the same time.

Return Format The query returns the sweep state, for example, FREQ.

Example :SWE:STAT FREQ

:SWE:STAT?

[[:SOURce]:SWEep:STEP:DWELI

Syntax [[:SOURce]:SWEep:STEP:DWELI <value>

[[:SOURce]:SWEep:STEP:DWELI?

Description Set the dwell time of step sweep.

Query the dwell time of step sweep.

Parameter	Name	Type	Range	Default
	<value>	Real	20ms to 100s	500ms

- Explanation**
- When <value> is set in "Number" form, the default unit is s. Besides, <value> can also be set in "Number + Unit" form, for example, 3000ms.
 - The default unit of the return value is s.
 - After setting the dwell time, you can use the up/down direction keys or knob to modify the dwell time at the current step. At this point, you can query or set the current step using the [\[:SOURce\]:SWEep:STEP:DWELI:STEP](#) command.

Return Format The query returns the dwell time of step sweep, for example, 3.

Example :SWE:STEP:DWEL 3 /*Set the dwell time of step sweep to 3s*/

:SWE:STEP:DWEL? /*The query returns 3*/

Related Command [\[:SOURce\]:SWEep:STEP:DWELI:STEP](#)

[[:SOURce]:SWEep:STEP:DWELI:STEP

Syntax [[:SOURce]:SWEep:STEP:DWELI:STEP <value>

[[:SOURce]:SWEep:STEP:DWELI:STEP?

Description Set the dwell time step.

Query the dwell time step.

Parameter	Name	Type	Range	Default
	<value>	Real	10ms to 10s	10ms

- Explanation**
- When <value> is set in "Number" form, the default unit is s. Besides, <value> can also be set in "Number + Unit" form, for example, 3000ms.
 - The default unit of the return value is s.
 - After setting the dwell time step, you can use the up/down direction keys or knob to modify the dwell time at the current step. At this point, you can query or set the dwell time using the [\[:SOURce\]:SWEep:STEP:DWELI](#) command.

Return Format The query returns the dwell time step, for example, 3.

Example :SWE:STEP:DWEL:STEP 3 /*Set the dwell time step to 3s*/

:SWE:STEP:DWEL:STEP? /*The query returns 3*/

Related Command [\[:SOURce\]:SWEep:STEP:DWELI](#)

[[:SOURce]:SWEep:STEP:POINTs]**Syntax** [[:SOURce]:SWEep:STEP:POINTs <value>

[[:SOURce]:SWEep:STEP:POINTs?

Description Set the number of points of step sweep.

Query the number of points of step sweep.

Parameter

Name	Type	Range	Default
<value>	Integer	2 to 65535	11

- Explanation**
- The number of sweep points decides the time interval between two neighbouring sweep points.
 - After setting the number of sweep points, you can use the up/down direction keys or knob to modify the number of sweep points at the current step. At this point, you can query or set the current step using the [\[\[:SOURce\]:SWEep:STEP:POINTs:STEP\]](#) command.

Return Format The query returns the number of sweep points, for example, 5.**Example** :SWEep:STEP:POINTs 5

:SWEep:STEP:POINTs?

Related Command [\[\[:SOURce\]:SWEep:STEP:POINTs:STEP\]](#)**[[:SOURce]:SWEep:STEP:POINTs:STEP]****Syntax** [[:SOURce]:SWEep:STEP:POINTs:STEP <value>

[[:SOURce]:SWEep:STEP:POINTs:STEP?

Description Set the step of the number of sweep points.

Query the step of the number of sweep points.

Parameter

Name	Type	Range	Default
<value>	Integer	1 to 10000	1

- Explanation**
- After setting the step of the number of sweep points, you can use the up/down direction keys or knob to modify the number of sweep points at the current step. At this point, you can query or set the number of sweep points using the [\[\[:SOURce\]:SWEep:STEP:POINTs\]](#) command.

Return Format The query returns the step of the number of sweep points, for example, 2.**Example** :SWE:STEP:POINT:STEP 2

:SWE:STEP:POINT:STEP?

Related Command [\[\[:SOURce\]:SWEep:STEP:POINTs\]](#)

[[:SOURce]:SWEep:STEP:SHAPE

Syntax [:SOURce]:SWEep:STEP:SHAPE TRlangle|RAMP
[:SOURce]:SWEep:STEP:SHAPE?

Description Set the step sweep shape.

Query the step sweep shape.

Parameter

Name	Type	Range	Default
TRlangle RAMP	Discrete	TRlangle RAMP	TRlangle

- Explanation**
- The sweep shape decides the cycle mode of multiple sweeps.
 - TRlangle: select "Triangle" waveform. The sweep period always starts from the start frequency or start level to the stop frequency or stop level and then returns back to the start frequency or start level (when the sweep direction is "Fwd").
 - RAMP: select "Ramp" waveform. The sweep period always starts from the start frequency or start level to the stop frequency or stop level (when the sweep direction is "Fwd").

Return Format The query returns TRI or RAMP.

Example :SWE:STEP:SHAP TRI
:SWE:STEP:SHAP?

Related Command [\[:SOURce\]:SWEep](#)

[[:SOURce]:SWEep:STEP:SPACING

Syntax [:SOURce]:SWEep:STEP:SPACing LINear|LOGarithmic
[:SOURce]:SWEep:STEP:SPACing?

Description Set the step sweep spacing.

Query the step sweep spacing.

Parameter

Name	Type	Range	Default
LINear LOGarithmic	Discrete	LINear LOGarithmic	LINear

- Explanation**
- The sweep spacing refers to the variation mode from one frequency or amplitude to another frequency or amplitude within a step.
 - LINear: set the sweep spacing to "Lin".
 - LOGarithmic: set the sweep spacing to "Log".

Return Format The query returns LIN or LOG.

Example :SWE:STEP:SPAC LIN
:SWE:STEP:SPAC?

[[:SOURce]:SWEep:STEP:START:FREQuency]

Syntax [:SOURce]:SWEep:STEP:START:FREQuency <value>
[:SOURce]:SWEep:STEP:START:FREQuency?

Description Set the start frequency of the sweep.

Query the start frequency of the sweep.

Parameter	Name	Type	Range	Default
	<value>	Real	9kHz to 6GHz	1GHz

- Explanation**
- When <value> is set in "Number" form, the default unit is Hz. Besides, <value> can also be set in "Number + Unit" form, for example, 4MHz.
 - The default unit of the return value is Hz.
 - After setting the start frequency, you can use the up/down direction keys or knob to modify the start frequency at the current step. At this point, you can query or set the current step using the [\[:SOURce\]:SWEep:STEP:START:FREQuency:STEP](#) command.

Return Format The query returns the start frequency of the sweep, for example, 4000000.

Example :SWE:STEP:STAR:FREQ 4MHz
:SWE:STEP:STAR:FREQ?

Related Command [\[:SOURce\]:SWEep:STEP:START:FREQuency:STEP](#)

[[:SOURce]:SWEep:STEP:START:FREQuency:STEP]

Syntax [:SOURce]:SWEep:STEP:START:FREQuency:STEP <value>
[:SOURce]:SWEep:STEP:START:FREQuency:STEP?

Description Set the start frequency step of the sweep.

Query the start frequency step of the sweep.

Parameter	Name	Type	Range	Default
	<value>	Real	10mHz to 1GHz	1GHz

- Explanation**
- When <value> is set in "Number" form, the default unit is Hz. Besides, <value> can also be set in "Number + Unit" form, for example, 3kHz.
 - The default unit of the return value is Hz.
 - After setting the start frequency step, you can use the up/down direction keys or knob to modify the start frequency at the current step. At this point, you can query or set the start frequency using the [\[:SOURce\]:SWEep:STEP:START:FREQuency](#) command.

Return Format The query returns the start frequency step of the sweep, for example, 3000.

Example :SWE:STEP:STAR:FREQ:STEP 3kHz
:SWE:STEP:STAR:FREQ:STEP?

Related Command [\[:SOURce\]:SWEep:STEP:START:FREQuency](#)

[[:SOURce]:SWEep:STEP:START:LEVel

Syntax [:SOURce]:SWEep:STEP:START:LEVel <value>

[:SOURce]:SWEep:STEP:START:LEVel?

Description Set the start level of the sweep.

Query the start level of the sweep.

Parameter

Name	Type	Range	Default
<value>	Real	-140dBm to 25dBm	-10dBm

Explanation

- When <value> is set in "Number" form (for example, 2), the default unit is dBm. When <value> is set in "Number + Unit" form (for example, 2dBm), the start level displayed in the interface of the RF signal generator is related to the setting of **Level Unit**.
 - When the level unit is "dBm", 2.00dBm is displayed.
 - When the level unit is "dBmV", 48.99dBmV is displayed.
 - When the level unit is "dBuV", 108.99dBuV is displayed.
 - When the level unit is "Volts", 281.50mV is displayed.
 - When the level unit is "Watts", 1.58mW is displayed.
- The default unit of the return value is dBm.
- After setting the start level, you can use the up/down direction keys or knob to modify the start level at the current step. At this point, you can query or set the current step using the [\[:SOURce\]:SWEep:STEP:START:LEVel:STEP](#) command.

Return Format The query returns the start level, for example, 2.00.

Example :SWE:STEP:STAR:LEV 2dBm

:SWE:STEP:STAR:LEV?

Related Command [\[:SOURce\]:SWEep:STEP:START:LEVel:STEP](#)

[[:SOURce]:SWEep:STEP:STARt:LEVEl:STEP

Syntax [:SOURce]:SWEep:STEP:STARt:LEVEl:STEP <value>
[:SOURce]:SWEep:STEP:STARt:LEVEl:STEP?

Description Set the start level step of the sweep.

Query the start level step of the sweep.

Parameter	Name	Type	Range	Default
	<value>	Real	0.01dB to 100dB	1dB

- Explanation**
- When <value> is set in "Number" form, the default unit is dB. Besides, <value> can also be set in "Number + Unit" form, for example, 20dB.
 - The default unit of the return value is dB.
 - After setting the start level step, you can use the up/down direction keys or knob to modify the start level at the current step. At this point, you can query or set the start level using the [\[:SOURce\]:SWEep:STEP:STARt:LEVEl](#) command.

Return Format The query returns the start level step of the sweep, for example, 20.00.

Example :SWE:STEP:STAR:LEV:STEP 20
:SWE:STEP:STAR:LEV:STEP?

Related Command [\[:SOURce\]:SWEep:STEP:STARt:LEVEl](#)

[[:SOURce]:SWEep:STEP:STOP:FREQuency

Syntax [:SOURce]:SWEep:STEP:STOP:FREQuency <value>
[:SOURce]:SWEep:STEP:STOP:FREQuency?

Description Set the stop frequency of the sweep.

Query the stop frequency of the sweep.

Parameter	Name	Type	Range	Default
	<value>	Real	9kHz to 6GHz	2GHz

- Explanation**
- When <value> is set in "Number" form, the default unit is Hz. Besides, <value> can also be set in "Number + Unit" form, for example, 4MHz.
 - The default unit of the return value is Hz.
 - After setting the stop frequency, you can use the up/down direction keys or knob to modify the stop frequency at the current step. At this point, you can query or set the current step using the [\[:SOURce\]:SWEep:STEP:STOP:FREQuency:STEP](#) command.

Return Format The query returns the stop frequency of the sweep, for example, 4000000.

Example :SWE:STEP:STOP:FREQ 4MHz
:SWE:STEP:STOP:FREQ?

Related Command [\[:SOURce\]:SWEep:STEP:STOP:FREQuency:STEP](#)

[[:SOURce]:SWEep:STEP:STOP:FREQuency:STEP

Syntax [:SOURce]:SWEep:STEP:STOP:FREQuency:STEP <value>
[:SOURce]:SWEep:STEP:STOP:FREQuency:STEP?

Description Set the stop frequency step of the sweep.

Query the stop frequency step of the sweep.

Parameter

Name	Type	Range	Default
<value>	Real	10mHz to 1GHz	100MHz

- Explanation**
- When <value> is set in "Number" form, the default unit is Hz. Besides, <value> can also be set in "Number + Unit" form, for example, 3kHz.
 - The default unit of the return value is Hz.
 - After setting the stop frequency step, you can use the up/down direction keys or knob to modify the stop frequency at the current step. At this point, you can query or set the stop frequency using the [\[:SOURce\]:SWEep:STEP:STOP:FREQuency](#) command.

Return Format The query returns the stop frequency step of the sweep, for example, 3000.

Example :SWE:STEP:STOP:FREQ:STEP 3kHz
:SWE:STEP:STOP:FREQ:STEP?

Related Command [\[:SOURce\]:SWEep:STEP:STOP:FREQuency](#)

[[:SOURce]:SWEep:STEP:STOP:LEVel]

Syntax [[:SOURce]:SWEep:STEP:STOP:LEVel <value>

[[:SOURce]:SWEep:STEP:STOP:LEVel?

Description Set the stop level of the sweep.

Query the stop level of the sweep.

Parameter

Name	Type	Range	Default
<value>	Real	-140dBm to 25dBm	-20dBm

- Explanation**
- When <value> is set in "Number" form (for example, 2), the default unit is dBm. When <value> is set in "Number + Unit" form (for example, 2dBm), the start level displayed in the interface of the RF signal generator is related to the setting of **Level Unit**.
 - When the level unit is "dBm", 2.00dBm is displayed.
 - When the level unit is "dBmV", 48.99dBmV is displayed.
 - When the level unit is "dBuV", 108.99dBuV is displayed.
 - When the level unit is "Volts", 281.50mV is displayed.
 - When the level unit is "Watts", 1.58mW is displayed.
 - The default unit of the return value is dBm.
 - After setting the stop level, you can use the up/down direction keys or knob to modify the stop level at the current step. At this point, you can query or set the current step using the [\[:SOURce\]:SWEep:STEP:STOP:LEVel:STEP](#) command.

Return Format The query returns the stop level of the sweep, for example, 2.000000.

Example :SWE:STEP:STOP:LEV 2dBm

:SWE:STEP:STOP:LEV?

Related Command [\[:SOURce\]:SWEep:STEP:STOP:LEVel:STEP](#)

[[:SOURce]:SWEep:STEP:STOP:LEVel:STEP

Syntax [:SOURce]:SWEep:STEP:STOP:LEVel:STEP <value>
[:SOURce]:SWEep:STEP:STOP:LEVel:STEP?

Description Set the stop level step of the sweep.

Query the stop level step of the sweep.

Parameter

Name	Type	Range	Default
<value>	Real	0.01dB to 100dB	1dB

- Explanation**
- When <value> is set in "Number" form, the default unit is dB. Besides, <value> can also be set in "Number + Unit" form, for example, 20dB.
 - The default unit of the return value is dBm.
 - After setting the stop level step, you can use the up/down direction keys or knob to modify the stop level at the current step. At this point, you can query or set the stop level using the [\[:SOURce\]:SWEep:STEP:STOP:LEVel](#) command.

Return Format The query returns the stop level step of the sweep, for example, 20.000000.

Example :SWE:STEP:STOP:LEV:STEP 20
:SWE:STEP:STOP:LEV:STEP?

Related Command [\[:SOURce\]:SWEep:STEP:STOP:LEVel](#)

[:SOURce]:SWEep:SWEep:TRIGger:TYPE

Syntax [:SOURce]:SWEep:SWEep:TRIGger:TYPE AUTO|KEY|BUS|EXT

[:SOURce]:SWEep:SWEep:TRIGger:TYPE?

Description Set the trigger mode of the sweep period.

Query the trigger mode of the sweep period.

Parameter

Name	Type	Range	Default
AUTO KEY BUS EXT	Discrete	AUTO KEY BUS EXT	AUTO

- Explanation**
- AUTO: select "Auto" trigger mode. If the sweep mode is set to "Cont", the instrument will start sweeping when a sweep type is selected. If the sweep mode is set to "Single", the instrument will start a sweep and then stop after the [:SOURce]:SWEep:EXECute command is sent and when the single sweep condition is met.
 - KEY: select "Key" trigger mode. If the sweep mode is set to "Cont", the instrument starts a sweep each time **Trigger** at the front panel is pressed. If the sweep mode is set to "Single", the instrument starts a sweep and then stops each time **Trigger** at the front panel is pressed after the [:SOURce]:SWEep:EXECute command is sent and when the single sweep condition is met.
 - BUS: select "Bus" trigger mode. If the sweep mode is set to "Cont", the instrument starts a sweep each time the *TRG or :TRIGger[:SWEep][:IMMEDIATE] command is sent. If the sweep mode is set to "Single", the instrument starts a sweep and then stops each time the *TRG or :TRIGger[:SWEep][:IMMEDIATE] command is sent after the [:SOURce]:SWEep:EXECute command is sent and when the single sweep condition is met.
 - EXT: select "Ext" trigger mode. The RF signal generator receives the trigger signal input from the **[TRIGGER IN]** connector at the rear panel. If the sweep mode is "Cont", the instrument starts a sweep each time a TTL pulse signal with the specified polarity is received. If the sweep mode is set to "Single", the instrument starts a sweep and then stops each time a TTL pulse signal with the specified polarity is received after the [:SOURce]:SWEep:EXECute command is sent and when the single sweep condition is met.
- Note:** The above explanations are only valid when the trigger mode of each sweep point within the sweep period is met.
- When executing the sweep operation, the priority of the required conditions is: single sweep → trigger mode → point trigger mode.

Return Format The query returns the trigger mode of the sweep, for example, AUTO.

Example :SWE:SWE:TRIG:TYPE AUTO

:SWE:SWE:TRIG:TYPE?

Related Commands

[\[:SOURce\]:SWEep:EXECute](#)

[\[:SOURce\]:SWEep:MODE](#)

[\[:SOURce\]:SWEep:POINT:TRIGger:TYPE](#)

[*TRG](#)

[:TRIGger\[:SWEep\]\[:IMMEDIATE\]](#)

[[:SOURce]:SWEep:TYPE

Syntax [:SOURce]:SWEep:TYPE LIST|STEP

[:SOURce]:SWEep:TYPE?

Description Set the sweep type.

Query the sweep type.

Parameter

Name	Type	Range	Default
LIST STEP	Discrete	LIST STEP	STEP

- Explanation**
- LIST: select "List" sweep type. At this point, the RF signal generator sweeps according to the current sweep list.
 - STEP: select "Step" sweep type. At this point, the RF signal generator performs step sweep at the current setting.

Return Format The query returns the sweep type (LIST or STEP).

Example :SWE:TYPE STEP

:SWE:TYPE?

:STATus Commands

The :STATus commands and IEEE488.2 common commands are mainly used to operate or query the status register. The structure of the status register is as shown in the figure below. It includes the questionable status register, operation status register, standard event status register, status byte register and error queue. The STATus commands are used to set and query the questionable status register and operation status register; the IEEE488.2 common commands are used to perform operations relating the standard event status register and status byte register.

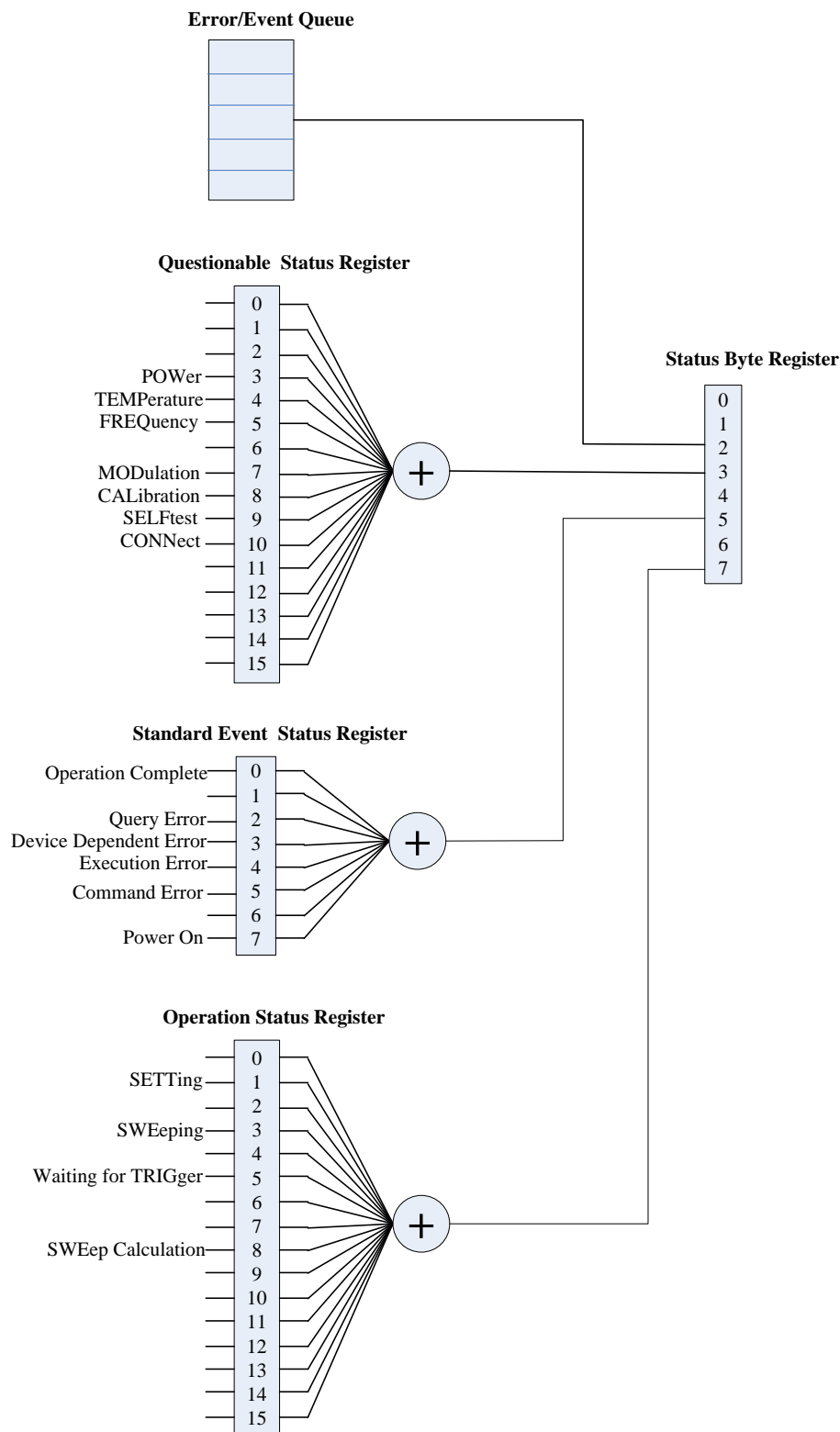

The definitions of the questionable status register are as shown in the table below. Wherein, bit 0 to bit 2, bit 6 and bit 11 to bit 15 are not used and will be always treated as 0.

Bit	Value	Definition
0	0	Not Used
1	0	Not Used
2	0	Not Used
3	8	Power
4	16	Temperature
5	32	Frequency
6	0	Not Used
7	128	Modulation
8	256	Calibration
9	512	Selftest
10	1024	Connect
11	0	Not Used
12	0	Not Used
13	0	Not Used
14	0	Not Used
15	0	Not Used

The definitions of the operation status register are as shown in the table below. Wherein, bit 0, bit 2, bit 4, bit 6, bit 7 and bit 9 to bit 15 are not used and will always be treated as 0.

Bit	Value	Definition
0	0	Not Used
1	2	Setting
2	0	Not Used
3	8	Sweeping
4	0	Not Used
5	32	Waiting for Trigger
6	0	Not Used
7	0	Not Used
8	256	Sweep Calculation
9	0	Not Used
10	0	Not Used
11	0	Not Used
12	0	Not Used
13	0	Not Used
14	0	Not Used
15	0	Not Used

Command List:

- ◆ [:STATus:OPERation:CONDition](#)
- ◆ [:STATus:OPERation:ENABle](#)
- ◆ [:STATus:OPERation\[:EVENT\]](#)
- ◆ [:STATus:QUEStionable:CALibration:CONDition](#)
- ◆ [:STATus:QUEStionable:CALibration:ENABle](#)
- ◆ [:STATus:QUEStionable:CALibration\[:EVENT\]](#)
- ◆ [:STATus:QUEStionable:CONDition](#)
- ◆ [:STATus:QUEStionable:CONNect:CONDition](#)
- ◆ [:STATus:QUEStionable:CONNect:ENABle](#)
- ◆ [:STATus:QUEStionable:CONNect\[:EVENT\]](#)
- ◆ [:STATus:QUEStionable:ENABle](#)
- ◆ [:STATus:QUEStionable\[:EVENT\]](#)
- ◆ [:STATus:QUEStionable:FREQuency:CONDition](#)
- ◆ [:STATus:QUEStionable:FREQuency:ENABle](#)
- ◆ [:STATus:QUEStionable:FREQuency\[:EVENT\]](#)
- ◆ [:STATus:QUEStionable:MODulation:CONDition](#)
- ◆ [:STATus:QUEStionable:MODulation:ENABle](#)
- ◆ [:STATus:QUEStionable:MODulation\[:EVENT\]](#)
- ◆ [:STATus:QUEStionable:POWer:CONDition](#)
- ◆ [:STATus:QUEStionable:POWer:ENABle](#)
- ◆ [:STATus:QUEStionable:POWer\[:EVENT\]](#)
- ◆ [:STATus:QUEStionable:SELFtest:CONDition](#)
- ◆ [:STATus:QUEStionable:SELFtest:ENABle](#)
- ◆ [:STATus:QUEStionable:SELFtest\[:EVENT\]](#)
- ◆ [:STATus:QUEStionable:TEMP:CONDition](#)
- ◆ [:STATus:QUEStionable:TEMP:ENABle](#)
- ◆ [:STATus:QUEStionable:TEMP\[:EVENT\]](#)

:STATus:OPERation:CONDition

Syntax :STATus:OPERation:CONDition?

Description Query the value of the condition register for the operation status register.

Explanation The bit 0, bit 2, bit 4, bit 6, bit 7 and bit 9 to bit 15 of the operation status register are not used and will always be treated as 0, therefore, the range of the return value are the decimal numbers corresponding to the binary numbers ranging from 0000000000000000 (0 in decimal) to 1111111111111111 (32767 in decimal) and of which the bit 0, bit 2, bit 4, bit 6, bit 7 and bit 9 to bit 15 are 0.

Return Format The query returns the value of the condition register in integer. For example, 32.

:STATus:OPERation:ENABLE

Syntax :STATus:OPERation:ENABLE <value>

:STATus:OPERation:ENABLE?

Description Set the value of the enable register for the operation status register.
Query the value of the enable register for the operation status register.

Parameter	Name	Type	Range	Default
	<value>	Integer	Refer to "Explanation"	0

Explanation The range of <value> are the decimal numbers corresponding to the binary numbers ranging from 0000000000000000 (0 in decimal) to 1111111111111111 (32767 in decimal).

Return Format The query returns the value of the enable register of the operation status register in integer.

Example :STAT:OPER:ENAB 100

:STAT:OPER:ENAB?

:STATus:OPERation[:EVENT]

Syntax :STATus:OPERation[:EVENT]?

Description Query the value of the event register for the operation status register.

Explanation The bit 0, bit 2, bit 4, bit 6, bit 7 and bit 9 to bit 15 of the operation status register are not used and are always treated as 0, therefore, the range of the return value are the decimal numbers corresponding to the binary numbers ranging from 0000000000000000 (0 in decimal) to 1111111111111111 (32767 in decimal) and of which the bit 0, bit 2, bit 4, bit 6, bit 7 and bit 9 to bit 15 are 0.

Return Format The query returns the value of the event register in integer. For example, 32.

:STATus:QUEStionable:CALibration:CONDition

Syntax :STATus:QUEStionable:CALibration:CONDition?

Description Query the value of the condition register for the questionable calibration status register.

Explanation ➤ The relation between the calibration status register and questionable status register is as shown in the figure below.

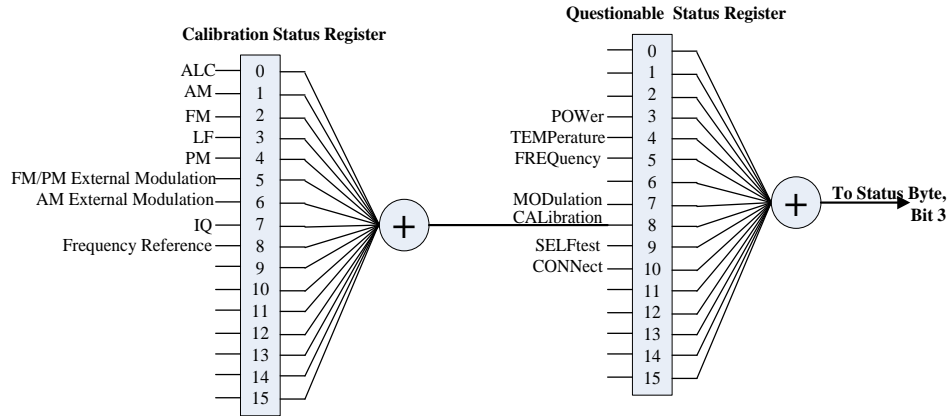

➤ The definitions of the questionable calibration status register are as shown in the table below. Wherein, bit 9 to bit 15 are not used and will be always treated as 0. The range of the return value are the decimal numbers corresponding to the binary numbers ranging from 0000000000000000 (0 in decimal) to 1111111111111111 (32767 in decimal) and of which the bit 9 to bit 15 are 0 (bit 2 and bit 4 can not be 1 at the same time).

Bit	Value	Definition
0	1	ALC
1	2	AM
2	4	FM
3	8	LF
4	16	PM
5	32	FM/PM External Modulation
6	64	AM External Modulation
7	128	IQ
8	256	Frequency Reference
9	0	Not Used
10	0	Not Used
11	0	Not Used
12	0	Not Used
13	0	Not Used
14	0	Not Used
15	0	Not Used

Return Format The query returns the value of the condition register of the questionable calibration status register in integer. For example, 24.

:STATus:QUEStionable:CALibration:ENABle

Syntax :STATus:QUEStionable:CALibration:ENABle <value>
:STATus:QUEStionable:CALibration:ENABle?

Description Set the value of the enable register for the questionable calibration status register.

Query the value of the enable register for the questionable calibration status register.

Parameter	Name	Type	Range	Default
	<value>	Integer	Refer to "Explanation"	0

Explanation In the questionable calibration status register, the range of <value> are the decimal numbers corresponding to the binary numbers ranging from 0000000000000000 (0 in decimal) to 1111111111111111 (32767 in decimal).

Return Format The query returns the value of the enable register of the questionable calibration status register in integer.

Example :STAT:QUES:CAL:ENAB 100
:STAT:QUES:CAL:ENAB?

:STATus:QUEStionable:CALibration[:EVENT]

Syntax :STATus:QUEStionable:CALibration[:EVENT]?

Description Query the value of the event register for the questionable calibration status register.

Explanation The bit 9 to bit 15 of the questionable calibration status register are not used and will be always treated as 0. The range of the return value are the decimal numbers corresponding to the binary numbers ranging from 0000000000000000 (0 in decimal) to 1111111111111111 (32767 in decimal) and of which the bit 9 to bit 15 are 0 (bit 2 and bit 4 can not be 1 at the same time).

Return Format The query returns the value of the event register of the questionable calibration status register in integer. For example, 24.

:STATus:QUEStionable:CONDition

Syntax :STATus:QUEStionable:CONDition?

Description Query the value of the condition register for the questionable status register.

Explanation The bit 0 to bit 2, bit 6 and bit 11 to bit 15 of the questionable status register are not used and are always treated as 0, therefore, the range of the return value are the decimal numbers corresponding to the binary numbers ranging from 0000000000000000 (0 in decimal) to 1111111111111111 (32767 in decimal) and of which the bit 0 to bit 2, bit 6 and bit 11 to bit 15 are 0.

Return Format The query returns the value of the condition register of the questionable status register in integer. For example, 0.

:STATus:QUEStionable:CONNect:CONDition

Syntax :STATus:QUEStionable:CONNect:CONDition?

Description Query the value of the condition register for the questionable connect status register.

Explanation ➤ The relation between the connect status register and questionable status register is as shown in the figure below.

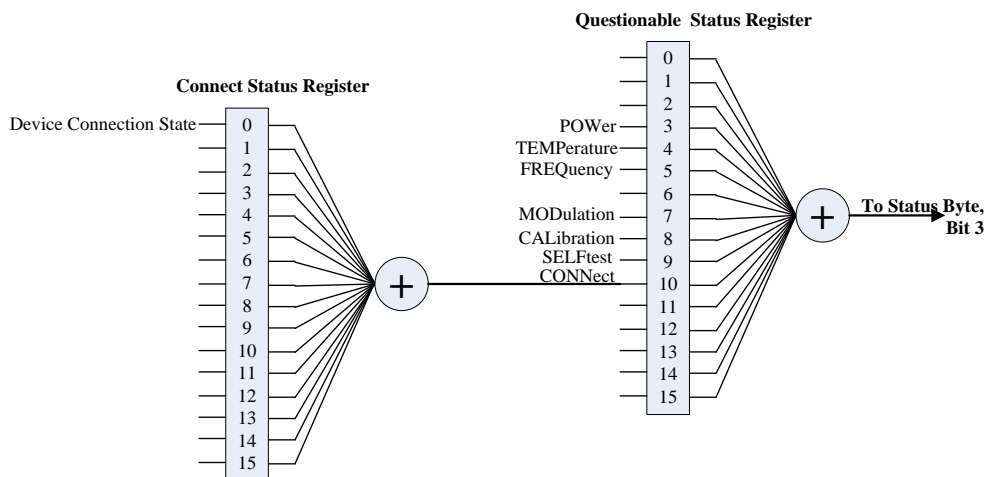

➤ The definitions of the questionable connect status register are as shown in the table below. Wherein, bit 1 to bit 15 are not used and will be always treated as 0. The range of the return value are the decimal numbers corresponding to the binary numbers ranging from 0000000000000000 (0 in decimal) to 0000000000000001 (1 in decimal).

Bit	Value	Definition
0	1	Device Connection State
1	0	Not Used
2	0	Not Used
3	0	Not Used
4	0	Not Used
5	0	Not Used
6	0	Not Used
7	0	Not Used
8	0	Not Used
9	0	Not Used
10	0	Not Used
11	0	Not Used
12	0	Not Used
13	0	Not Used
14	0	Not Used
15	0	Not Used

Return Format The query returns the value of the condition register of the questionable connect status register in integer. For example, 0.

:STATus:QUESTionable:CONNect:ENABle

Syntax :STATus:QUESTionable:CONNect:ENABle <value>

:STATus:QUESTionable:CONNect:ENABle?

Description Set the value of the enable register for the questionable connect status register.

Query the value of the enable register for the questionable connect status register.

Parameter	Name	Type	Range	Default
	<value>	Integer	Refer to "Explanation"	0

Explanation In the questionable connect status register, the range of <value> are the decimal numbers corresponding to the binary numbers ranging from 0000000000000000 (0 in decimal) to 1111111111111111 (32767 in decimal).

Return Format The query returns the value of the enable register of the questionable connect status register in integer.

Example :STAT:QUES:CONN:ENAB 1

:STAT:QUES:CONN:ENAB?

:STATus:QUESTionable:CONNect[:EVENT]

Syntax :STATus:QUESTionable:CONNect[:EVENT]?

Description Query the value of the event register for the questionable connect status register.

Explanation The bit 1 to bit 15 of the questionable connect status register are not used and will be always treated as 0. The range of the return value are the decimal numbers corresponding to the binary numbers ranging from 0000000000000000 (0 in decimal) to 0000000000000001 (1 in decimal).

Return Format The query returns the value of the event register of the questionable connect status register in integer.

:STATus:QUESTionable:ENABle

Syntax :STATus:QUESTionable:ENABle <value>

:STATus:QUESTionable:ENABle?

Description Set the value of the enable register for the questionable status register.

Query the value of the enable register for the questionable status register.

Parameter	Name	Type	Range	Default
	<value>	Integer	Refer to "Explanation"	0

Explanation The range of <value> are the decimal numbers corresponding to the binary numbers ranging from 0000000000000000 (0 in decimal) to 1111111111111111 (32767 in decimal).

Return Format The query returns the value of the enable register of the questionable status register in integer.

Example :STAT:QUES:ENAB 100

:STAT:QUES:ENAB?

:STATus:QUEStionable[:EVENT]

Syntax :STATus:QUEStionable[:EVENT]?

Description Query the value of the event register for the questionable status register.

Explanation The bit 0 to bit 2, bit 6 and bit 11 to bit 15 of the questionable status register are not used and are always treated as 0, therefore, the range of the return value are the decimal numbers corresponding to the binary numbers ranging from 0000000000000000 (0 in decimal) to 1111111111111111 (32767 in decimal) and of which the bit 0 to bit 2, bit 6 and bit 11 to bit 15 are 0.

Return Format The query returns the value of the event register of the questionable status register in integer. For example, 0.

:STATus:QUEStionable:FREQuency:CONDition

Syntax :STATus:QUEStionable:FREQuency:CONDition?

Description Query the value of the condition register for the questionable frequency status register.

Explanation ➤ The relation between the frequency status register and questionable status register is as shown in the figure below.

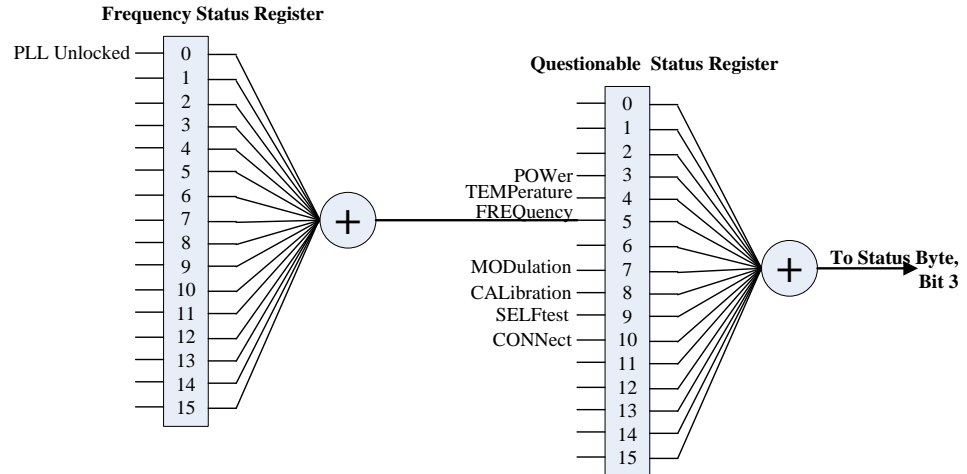

➤ The definitions of the questionable frequency status register are as shown in the table below. Wherein, bit 1 to bit 15 are not used and will be always treated as 0. The range of the return value are the decimal numbers corresponding to the binary numbers ranging from 0000000000000000 (0 in decimal) to 0000000000000001 (1 in decimal).

Bit	Value	Definition
0	1	PLL Unlocked
1	0	Not Used
2	0	Not Used
3	0	Not Used
4	0	Not Used
5	0	Not Used
6	0	Not Used
7	0	Not Used
8	0	Not Used
9	0	Not Used
10	0	Not Used
11	0	Not Used
12	0	Not Used
13	0	Not Used
14	0	Not Used
15	0	Not Used

Return Format The query returns the value of the condition register of the questionable frequency status register in integer.

:STATus:QUEStionable:FREQuency:ENABle

Syntax :STATus:QUEStionable:FREQuency:ENABle <value>

:STATus:QUEStionable:FREQuency:ENABle?

Description Set the value of the enable register for the questionable frequency status register.

Query the value of the enable register for the questionable frequency status register.

Parameter

Name	Type	Range	Default
<value>	Integer	Refer to "Explanation"	0

Explanation In the questionable frequency status register, the range of <value> are the decimal numbers corresponding to the binary numbers ranging from 0000000000000000 (0 in decimal) to 1111111111111111 (32767 in decimal).

Return Format The query returns the value of the enable register of the questionable frequency status register in integer.

Example :STAT:QUES:FREQ:ENAB 1

:STAT:QUES:FREQ:ENAB?

:STATus:QUEStionable:FREQuency[:EVENT]

Syntax :STATus:QUEStionable:FREQuency[:EVENT]?

Description Query the value of the event register for the questionable frequency status register.

Explanation The bit 1 to bit 15 of the questionable frequency status register are not used and will be always treated as 0. The range of the return value are the decimal numbers corresponding to the binary numbers ranging from 0000000000000000 (0 in decimal) to 0000000000000001 (1 in decimal).

Return Format The query returns the value of the event register of the questionable frequency status register in integer.

:STATus:QUEStionable:MODulation:CONDition

Syntax :STATus:QUEStionable:MODulation:CONDition?

Description Query the value of the condition register for the questionable modulation status register.

Explanation ➤ The relation between the modulation status register and questionable status register is as shown in the figure below.

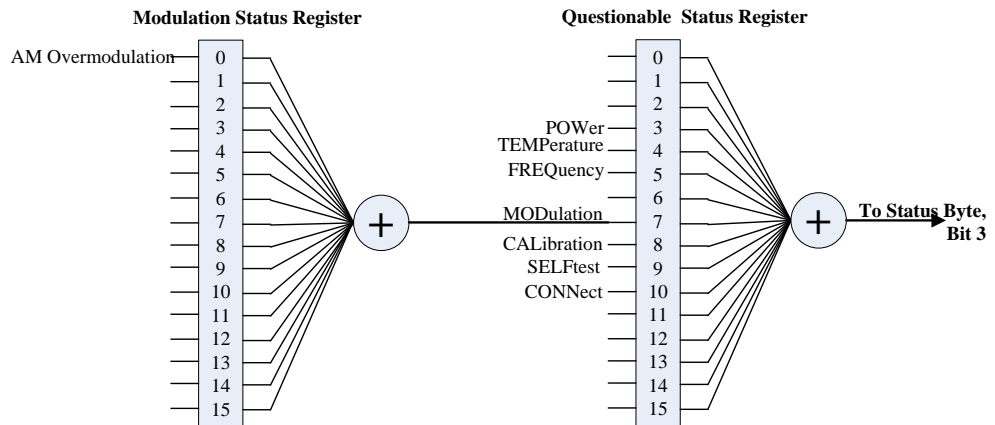

➤ The definitions of the questionable modulation status register are as shown in the table below. Wherein, bit 1 to bit 15 are not used and will be always treated as 0. The range of the return value are the decimal numbers corresponding to the binary numbers ranging from 0000000000000000 (0 in decimal) to 0000000000000001 (1 in decimal).

Bit	Value	Definition
0	1	AM Overmodulation
1	0	Not Used
2	0	Not Used
3	0	Not Used
4	0	Not Used
5	0	Not Used
6	0	Not Used
7	0	Not Used
8	0	Not Used
9	0	Not Used
10	0	Not Used
11	0	Not Used
12	0	Not Used
13	0	Not Used
14	0	Not Used
15	0	Not Used

Return Format The query returns the value of the condition register of the questionable modulation status register in integer.

:STATus:QUEStionable:MODulation:ENABle

Syntax :STATus:QUEStionable:MODulation:ENABle <value>

:STATus:QUEStionable:MODulation:ENABle?

Description Set the value of the enable register for the questionable modulation status register.

Query the value of the enable register for the questionable modulation status register.

Parameter	Name	Type	Range	Default
	<value>	Integer	Refer to "Explanation"	0

Explanation In the questionable modulation status register, the range of <value> are the decimal numbers corresponding to the binary numbers ranging from 0000000000000000 (0 in decimal) to 1111111111111111 (32767 in decimal).

Return Format The query returns the value of the enable register of the questionable modulation status register in integer.

Example :STAT:QUES:MOD:ENAB 1

:STAT:QUES:MOD:ENAB?

:STATus:QUEStionable:MODulation[:EVENT]

Syntax :STATus:QUEStionable:MODulation[:EVENT]?

Description Query the value of the event register for the questionable modulation status register.

Explanation The bit 1 to bit 15 of the questionable modulation status register are not used and will be always treated as 0. The range of the return value are the decimal numbers corresponding to the binary numbers ranging from 0000000000000000 (0 in decimal) to 0000000000000001 (1 in decimal).

Return Format The query returns the value of the event register of the questionable modulation status register in integer.

:STATus:QUESTionable:POWer:CONDition

Syntax :STATus:QUESTionable:POWer:CONDition?

Description Query the value of the condition register for the questionable power status register.

Explanation ➤ The relation between the power status register and questionable status register is as shown in the figure below.

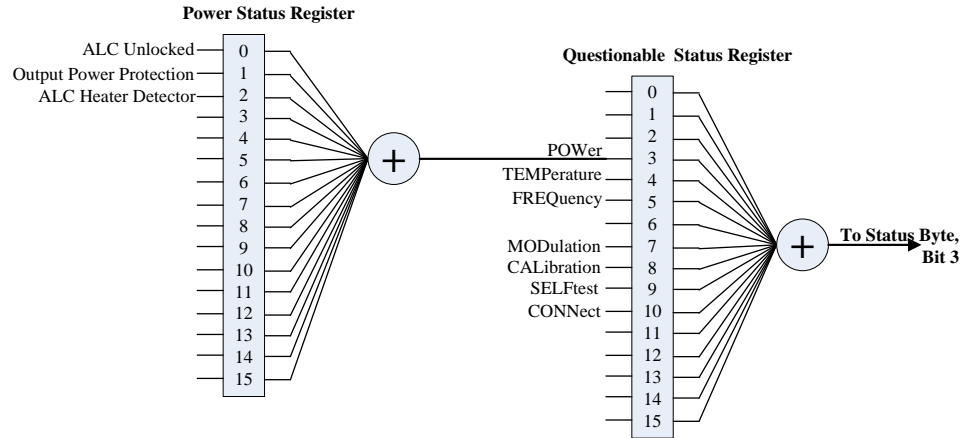

➤ The definitions of the questionable power status register are as shown in the table below. Wherein, bit 3 to bit 15 are not used and will be always treated as 0. The range of the return value are the decimal numbers corresponding to the binary numbers ranging from 0000000000000000 (0 in decimal) to 1111111111111111 (32767 in decimal) and of which the bit 3 to bit 15 are 0.

Bit	Value	Definition
0	1	ALC Unlocked
1	2	Output Power Protection
2	4	ALC Heater Detector, 30 min
3	0	Not Used
4	0	Not Used
5	0	Not Used
6	0	Not Used
7	0	Not Used
8	0	Not Used
9	0	Not Used
10	0	Not Used
11	0	Not Used
12	0	Not Used
13	0	Not Used
14	0	Not Used
15	0	Not Used

Return Format The query returns the value of the condition register of the questionable power status register in integer.

:STATus:QUEStionable:POWer:ENABle

Syntax :STATus:QUEStionable:POWer:ENABle <value>
:STATus:QUEStionable:POWer:ENABle?

Description Set the value of the enable register for the questionable power status register.

Query the value of the enable register for the questionable power status register.

Parameter

Name	Type	Range	Default
<value>	Integer	Refer to "Explanation"	0

Explanation In the questionable power status register, the range of <value> are the decimal numbers corresponding to the binary numbers ranging from 0000000000000000 (0 in decimal) to 1111111111111111 (32767 in decimal).

Return Format The query returns the value of the enable register of the questionable power status register in integer.

Example :STAT:QUES:POW:ENAB 6
:STAT:QUES:POW:ENAB?

:STATus:QUEStionable:POWer[:EVENT]

Syntax :STATus:QUEStionable:POWer[:EVENT]?

Description Query the value of the event register for the questionable power status register.

Explanation The bit 3 to bit 15 of the questionable power status register are not used and will be always treated as 0. The range of the return value are the decimal numbers corresponding to the binary numbers ranging from 0000000000000000 (0 in decimal) to 1111111111111111 (32767 in decimal) and of which the bit 3 to bit 15 are 0.

Return Format The query returns the value of the event register of the questionable power status register in integer.

:STATus:QUEStionable:SELFtest:CONDition

Syntax :STATus:QUEStionable:SELFtest:CONDition?

Description Query the value of the condition register for the questionable selftest status register.

Explanation ➤ The relation between the selftest status register and questionable status register is as shown in the figure below.

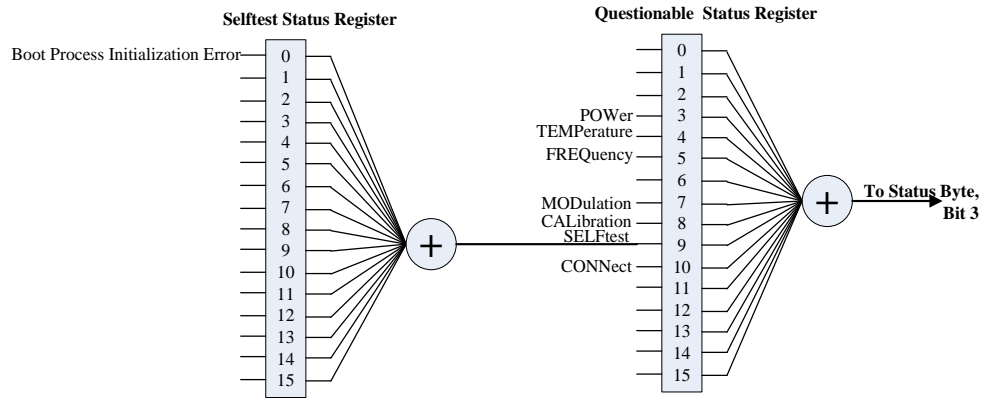

➤ The definitions of the questionable selftest status register are as shown in the table below. Wherein, bit 1 to bit 15 are not used and will be always treated as 0. The range of the return value are the decimal numbers corresponding to the binary numbers ranging from 0000000000000000 (0 in decimal) to 0000000000000001 (1 in decimal).

Bit	Value	Definition
0	1	Boot Process Initialization Error
1	0	Not Used
2	0	Not Used
3	0	Not Used
4	0	Not Used
5	0	Not Used
6	0	Not Used
7	0	Not Used
8	0	Not Used
9	0	Not Used
10	0	Not Used
11	0	Not Used
12	0	Not Used
13	0	Not Used
14	0	Not Used
15	0	Not Used

Return Format The query returns the value of the condition register of the questionable selftest status register in integer.

:STATus:QUEStionable:SELFtest:ENABLE

Syntax :STATus:QUEStionable:SELFtest:ENABLE <value>

:STATus:QUEStionable:SELFtest:ENABLE?

Description Set the value of the enable register for the questionable selftest status register.

Query the value of the enable register for the questionable selftest status register.

Parameter

Name	Type	Range	Default
<value>	Integer	Refer to "Explanation"	0

Explanation In the questionable selftest status register, the range of <value> are the decimal numbers corresponding to the binary numbers ranging from 0000000000000000 (0 in decimal) to 1111111111111111 (32767 in decimal).

Return Format The query returns the value of the enable register of the questionable selftest status register in integer.

Example :STAT:QUES:SELF:ENAB 1

:STAT:QUES:SELF:ENAB?

:STATus:QUEStionable:SELFtest[:EVENT]

Syntax :STATus:QUEStionable:SELFtest[:EVENT]?

Description Query the value of the event register for the questionable selftest status register.

Explanation The bit 1 to bit 15 of the questionable connect status register are not used and will be always treated as 0. The range of the return value are the decimal numbers corresponding to the binary numbers ranging from 0000000000000000 (0 in decimal) to 0000000000000001 (1 in decimal).

Return Format The query returns the value of the event register of the questionable selftest status register in integer.

:STATus:QUESTionable:TEMP:CONDition

Syntax :STATus:QUESTionable:TEMP:CONDition?

Description Query the value of the condition register for the questionable temperature status register.

Explanation ➤ The relation between the temperature status register and questionable status register is as shown in the figure below.

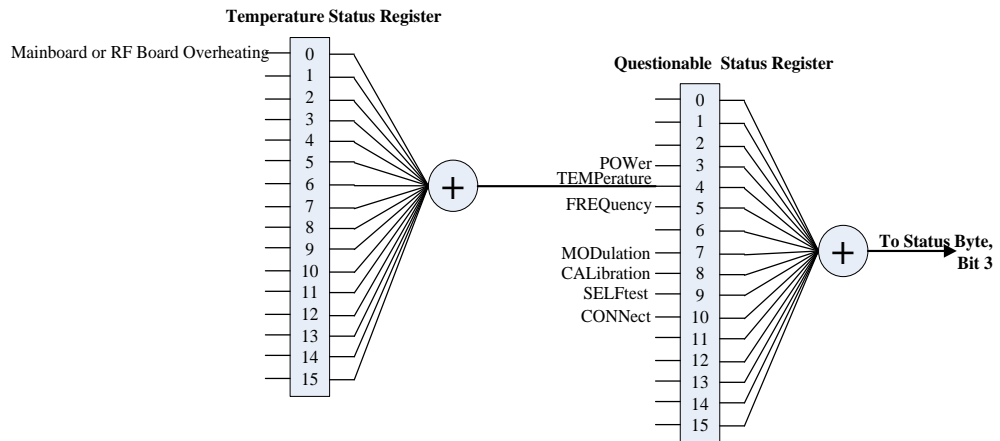

➤ The definitions of the questionable temperature status register are as shown in the table below. Wherein, bit 1 to bit 15 are not used and will be always treated as 0. The range of the return value are the decimal numbers corresponding to the binary numbers ranging from 0000000000000000 (0 in decimal) to 0000000000000001 (1 in decimal).

Bit	Value	Definition
0	1	Mainboard or RF Board Overheating
1	0	Not Used
2	0	Not Used
3	0	Not Used
4	0	Not Used
5	0	Not Used
6	0	Not Used
7	0	Not Used
8	0	Not Used
9	0	Not Used
10	0	Not Used
11	0	Not Used
12	0	Not Used
13	0	Not Used
14	0	Not Used
15	0	Not Used

Return Format The query returns the value of the condition register of the questionable temperature status register in integer.

:STATus:QUEStionable:TEMP:ENABLE

Syntax :STATus:QUEStionable:TEMP:ENABLE <value>

:STATus:QUEStionable:TEMP:ENABLE?

Description Set the value of the enable register for the questionable temperature status register.

Query the value of the enable register for the questionable temperature status register.

Parameter	Name	Type	Range	Default
	<value>	Integer	Refer to "Explanation"	0

Explanation In the questionable temperature status register, the range of <value> are the decimal numbers corresponding to the binary numbers ranging from 0000000000000000 (0 in decimal) to 1111111111111111 (32767 in decimal).

Return Format The query returns the value of the enable register of the questionable temperature status register in integer.

Example :STAT:QUES:TEMP:ENAB 1

:STAT:QUES:TEMP:ENAB?

:STATus:QUEStionable:TEMP[:EVENT]

Syntax :STATus:QUEStionable:TEMP[:EVENT]?

Description Query the value of the event register for the questionable temperature status register.

Explanation The bit 1 to bit 15 of the questionable temperature status register are not used and will be always treated as 0. The range of the return value are the decimal numbers corresponding to the binary numbers ranging from 0000000000000000 (0 in decimal) to 0000000000000001 (1 in decimal).

Return Format The query returns the value of the event register of the questionable temperature status register in integer.

:SYSTem Commands

The :SYSTem commands are used to set a series of parameters relating to the system and the settings of these parameters do not affect the output signal of the RF signal generator.

Command List:

- ◆ [:SYSTem:BRIGhtness](#)
- ◆ [:SYSTem:CLear](#)
- ◆ [:SYSTem:COMMunication:GPIB\[:SELF\]:ADDRess](#)
- ◆ [:SYSTem:COMMunication:INTerface](#)
- ◆ [:SYSTem:COMMunication:LAN:DHCP](#)
- ◆ [:SYSTem:COMMunication:LAN:IP:ADDRESS](#)
- ◆ [:SYSTem:COMMunication:LAN:IP:AUTO](#)
- ◆ [:SYSTem:COMMunication:LAN:IP:GATeway](#)
- ◆ [:SYSTem:COMMunication:LAN:IP:MANual](#)
- ◆ [:SYSTem:COMMunication:LAN:IP:SET](#)
- ◆ [:SYSTem:COMMunication:LAN:IP:SUBnet:MASK](#)
- ◆ [:SYSTem:COMMunication:LAN:RESet](#)
- ◆ [:SYSTem:COMMunication:LAN\[:SELF\]:PREFerred](#)
- ◆ [:SYSTem:DATE](#)
- ◆ [:SYSTem:DISPlay:UPDate\[:STATe\]](#)
- ◆ [:SYSTem:FSWitch:STATe](#)
- ◆ [:SYSTem:LANGuage](#)
- ◆ [:SYSTem:LKEY](#)
- ◆ [:SYSTem:POWer:ON:TYPE](#)
- ◆ [:SYSTem:PRESet](#)
- ◆ [:SYSTem:PRESet:TYPE](#)
- ◆ [:SYSTem:PRESet:SAVE](#)
- ◆ [:SYSTem:TIME](#)

:SYSTem:BRIGhtness

Syntax :SYSTem:BRIGhtness <value>

:SYSTem:BRIGhtness?

Description Set the brightness of the LCD.

Query the brightness of the LCD.

Parameter

Name	Type	Range	Default
<value>	Integer	0 to 7	NULL

Explanation The "Brightness" setting will not be affected by factory reset.

Return Format The query returns an integer, for example, 3.

Example :SYST:BRIG 3

:SYST:BRIG?

:SYSTem:CLEAr

Syntax :SYSTem:CLEAr

Description Clear all the user-defined data.

Explanation The instrument will be reset to factory setting after the data is cleared.

- Format the NAND FLASH;
- Reset the user data saved in NVRAM and NorFlash to factory setting;
- Reset the HOST NAME, IP address and password in LXI to factory setting.

:SYSTem:COMMunication:GPIB[:SELF]:ADDRESS

Syntax :SYSTem:COMMunication:GPIB[:SELF]:ADDRESS <value>

:SYSTem:COMMunication:GPIB[:SELF]:ADDRESS?

Description Set the GPIB address.

Query the current GPIB address.

Parameter

Name	Type	Range	Default
<value>	Integer	0 to 30	NULL

Return Format The query returns an integer, for example, 8.

Example :SYST:COMM:GPIB:ADDR 8

:SYST:COMM:GPIB:ADDR?

:SYSTem:COMMunication:INTerface

Syntax :SYSTem:COMMunication:INTerface OFF|USB|LAN|GPIB|AUTO
:SYSTem:COMMunication:INTerface?

Description Set the type of the communication interface.

Query the type of the communication interface.

Parameter

Name	Type	Range	Default
OFF USB LAN GPIB AUTO	Discrete	OFF USB LAN GPIB AUTO	OFF

- Explanation**
- The parameter USB|LAN|GPIB|AUTO can set the communication interface to "USB", "LAN", "GPIB" and "Auto" respectively. When "OFF" is selected, all the communication interfaces are turned off.
 - If you are currently using a communication interface (for example, the USB interface), at this point, the query will always return the communication interface currently used no matter which type of communication interface you select.

Return Format The query returns the type of the current communication interface, for example, USB.

Example :SYST:COMM:INT USB
:SYST:COMM:INT?

:SYSTem:COMMunication:LAN:DHCP

Syntax :SYSTem:COMMunication:LAN:DHCP ON|OFF|1|0
:SYSTem:COMMunication:LAN:DHCP?

Description Turn on or off the DHCP mode.

Query the state of the DHCP mode.

Parameter

Name	Type	Range	Default
ON OFF 1 0	Bool	ON OFF 1 0	ON

- Explanation**
- In DHCP mode, the DHCP server in the current network distributes network parameters (such as the IP address) for the instrument.
 - When all the three IP configuration modes are "On", the priority of parameter configuration is "DHCP", "Auto-IP" and "Manual-IP".
 - The three IP configuration modes can not be all set to "Off" at the same time.

Return Format The query returns 1 or 0.

Example :SYST:COMM:LAN:DHCP ON
:SYST:COMM:LAN:DHCP?

Related Commands [:SYSTem:COMMunication:LAN:IP:AUTO](#)
[:SYSTem:COMMunication:LAN:IP:MANual](#)

:SYSTem:COMMunication:LAN:IP:ADDRESS

Syntax :SYSTem:COMMunication:LAN:IP:ADDRESS <value>
:SYSTem:COMMunication:LAN:IP:ADDRESS?

Description Set the IP address.

Query the current IP address.

Parameter	Name	Type	Range	Default
	<value>	ASCII string	The format is nnn.nnn.nnn.nnn, wherein, the range of the first nnn is from 1 to 223 (except 127) and the ranges of the other three nnn are from 0 to 255	NULL

- Explanation**
- This command is only valid when Manual-IP configuration mode is turned on.
 - You are recommended to ask your network administrator for an address available.

Return Format The query returns the IP address, for example, 172.16.3.199.

Example :SYST:COMM:LAN:IP:ADD 172.16.3.199
:SYST:COMM:LAN:IP:ADD?

Related Command [:SYSTem:COMMunication:LAN:IP:MANual](#)

:SYSTem:COMMunication:LAN:IP:AUTO

Syntax :SYSTem:COMMunication:LAN:IP:AUTO ON|OFF|1|0
:SYSTem:COMMunication:LAN:IP:AUTO?

Description Turn on or off the Auto-IP configuration mode.

Query the state of the Auto-IP configuration mode.

Parameter	Name	Type	Range	Default
	ON OFF 1 0	Bool	ON OFF 1 0	ON

- Explanation**
- In Auto-IP mode, the instrument acquires IP address within 169.254.0.1 and 169.254.255.254 and subnet mask 255.255.0.0 automatically based on the current network configuration.
 - When all the three IP configuration modes are "On", the priority of parameter configuration is "DHCP", "Auto-IP" and "Manual-IP".
 - The three IP configuration modes can not be all set to "Off" at the same time.

Return Format The query returns 1 or 0.

Example :SYST:COMM:LAN:IP:AUTO ON
:SYST:COMM:LAN:IP:AUTO?

Related Commands [:SYSTem:COMMunication:LAN:DHCP](#)
[:SYSTem:COMMunication:LAN:IP:MANual](#)

:SYSTem:COMMunication:LAN:IP:GATeway

Syntax :SYSTem:COMMunication:LAN:IP:GATeway <string>
:SYSTem:COMMunication:LAN:IP:GATeway?

Description Set the default gateway.

Query the current default gateway.

Parameter	Name	Type	Range	Default
	<string>	ASCII string	The format is nnn.nnn.nnn.nnn, wherein, the range of the first nnn is from 1 to 223 (except 127) and the ranges of the other three nnn are from 0 to 255	NULL

- Explanation**
- This command is only valid when Manual-IP configuration mode is turned on.
 - You are recommended to ask your network administrator for an address available.

Return Format The query returns the default gateway, for example, 172.16.3.1.

Example :SYST:COMM:LAN:IP:GAT 172.16.3.1
:SYST:COMM:LAN:IP:GAT?

Related Command [:SYSTem:COMMunication:LAN:IP:MANual](#)

:SYSTem:COMMunication:LAN:IP:MANual

Syntax :SYSTem:COMMunication:LAN:IP:MANual ON|OFF|1|0
:SYSTem:COMMunication:LAN:IP:MANual?

Description Enable or disable the Manual-IP configuration mode.

Query the status of the Manual-IP configuration mode.

Parameter	Name	Type	Range	Default
	ON OFF 1 0	Bool	ON OFF 1 0	OFF

- Explanation**
- In Manual-IP mode, the network parameters (such as the IP address) are defined by users.
 - When all the three IP configuration modes are "On", the priority of parameter configuration is "DHCP", "Auto-IP" and "Manual-IP".
 - The three IP configuration modes can not be all set to "Off" at the same time.

Return Format The query returns 1 or 0.

Example :SYST:COMM:LAN:IP:MAN ON
:SYST:COMM:LAN:IP:MAN?

Related Commands [:SYSTem:COMMunication:LAN:DHCP](#)
[:SYSTem:COMMunication:LAN:IP:AUTO](#)

:SYSTem:COMMunication:LAN:IP:SET

Syntax :SYSTem:COMMunication:LAN:IP:SET

Description Apply the current network parameter settings.

Explanation After setting the LAN parameters, you have to execute this command to apply the parameters. Otherwise, the settings are invalid.

:SYSTem:COMMunication:LAN:IP:SUBnet:MASK

Syntax :SYSTem:COMMunication:LAN:IP:SUBnet:MASK <value>

:SYSTem:COMMunication:LAN:IP:SUBnet:MASK?

Description Set the subnet mask.
Query the current subnet mask.

Parameter	Name	Type	Range	Default
	<value>	ASCII string	The format is nnn.nnn.nnn.nnn and the range of the nnn is from 0 to 255.	NULL

Explanation

- This command is only valid when Manual-IP configuration mode is turned on.
- You are recommended to ask your network administrator for a subnet mask available.

Return Format The query returns the current subnet mask, for example, 255.255.255.0.

Example :SYST:COMM:LAN:IP:SUB:MASK 255.255.255.0

:SYST:COMM:LAN:IP:SUB:MASK?

Related Command [:SYSTem:COMMunication:LAN:IP:MANual](#)

:SYSTem:COMMunication:LAN:RESet

Syntax :SYSTem:COMMunication:LAN:RESet

Description Reset the current network parameters.

Explanation After resetting the current parameters, DHCP and Auto-IP are turned on and Manual-IP is turned off.

:SYSTem:COMMunication:LAN[:SELF]:PREFferred

Syntax :SYSTem:COMMunication:LAN[:SELF]:PREFferred <value>
:SYSTem:COMMunication:LAN[:SELF]:PREFferred?

Description Set the DNS (Domain Name Service).

Query the current DNS.

Parameter	Name	Type	Range	Default
	<value>	ASCII string	The format is nnn.nnn.nnn.nnn, wherein, the range of the first nnn is from 1 to 223 (except 127) and the ranges of the other three nnn are from 0 to 255	NULL

Explanation You are recommended to ask your network administrator for an address available.

Return Format The query returns the DNS address, for example, 172.16.2.3.

Example :SYST:COMM:LAN:PREF 172.16.2.3
:SYST:COMM:LAN:PREF?

:SYSTem:DATE

Syntax :SYSTem:DATE <year>,<month>,<day>
:SYSTem:DATE?

Description Set the date displayed on the instrument.

Query the date displayed on the instrument.

Parameter	Name	Type	Range	Default
	<year>	ASCII string	2000 to 2099	--
	<month>	ASCII string	01 to 12	--
	<day>	ASCII string	01 to 31	--

Return Format The query returns the current date in "YYYY,MM,DD" format.

Example :SYST:DATE 2015,04,10
:SYST:DATE?

:SYSTem:DISPlay:UPDate[:STATe]

Syntax :SYSTem:DISPlay:UPDate[:STATe] ON|OFF|1|0
:SYSTem:DISPlay:UPDate[:STATe]?

Description Set the on/off state of the screen.
Query the on/off state of the screen.

Parameter	Name	Type	Range	Default
	ON OFF 1 0	Bool	ON OFF 1 0	ON

Explanation When the screen is turned off, the screen stops updating and is locked. At this point, the measurement speed is improved. Pressing **Esc** can unlock the screen. Screen lock is mainly used in remote operation mode.

Return Format The query returns 1 or 0.

Example :SYST:DISP:UPD OFF
:SYST:DISP:UPD?

:SYSTem:FSWitch:STATe

Syntax :SYSTem:FSWitch:STATe OPEN|DEFAult
:SYSTem:FSWitch:STATe?

Description Set the power status of the RF signal generator after power-on.
Query the power status of the RF signal generator after power-on.

Parameter	Name	Type	Range	Default
	OPEN DEFAult	Discrete	OPEN DEFAult	NULL

Explanation

- OPEN: select "Open" state. The RF signal generator starts directly after power-on.
- DEFAult: select "Default" state. You have to press the power key at the front panel to start the RF signal generator after power-on.

Return Format The query returns Open or Default.

Example :SYST:FSW:STAT OPEN
:SYST:FSW:STAT?

:SYSTem:LANGUage

Syntax :SYSTem:LANGUage CHINese|ENGLish
:SYSTem:LANGUage?

Description Set the system language.

Query the system language.

Parameter

Name	Type	Range	Default
CHINese ENGLish	Discrete	CHINese ENGLish	NULL

Return Format The query returns CHINESE or ENGLISH.

Example :SYST:LANG CHIN
:SYST:LANG?

:SYSTem:LKEY

Syntax :SYSTem:LKEY <license key>

Description Install and activate the option of the instrument.

Parameter

Name	Type	Range	Default
<license key>	String	Serial number of the option you bought	NULL

Explanation The serial number for each option is unique and can only be used by one instrument (the serial number of the option corresponds to the serial number of the instrument you bought).

Example :SYST:LKEY QA7ZCZEH6AC54SFNKA853MS5CB3A

:SYSTem:POWer:ON:TYPE

Syntax :SYSTem:POWer:ON:TYPE LAST|PRESet
:SYSTem:POWer:ON:TYPE?

Description Select the instrument configuration to be used at start-up.

Query the instrument configuration to be used at start-up.

Parameter

Name	Type	Range	Default
LAST PRESet	Discrete	LAST PRESet	NULL

Explanation

- LAST: the instrument loads the system configuration used before the last power-off automatically at start-up.
- PRESet: the instrument loads the settings defined by the [:SYSTem:PRESet:TYPE](#) command automatically at start-up.

Return Format The query returns LAST or PRESET.

Example :SYST:POW:ON:TYPE LAST
:SYST:POW:ON:TYPE?

Related Command [:SYSTem:PRESet:TYPE](#)

:SYSTem:PRESet

Syntax :SYSTem:PRESet

Description Reset the instrument to the preset state (the settings defined by the [:SYSTem:PRESet:TYPE](#) command: FACTory or USER).

Explanation Sending this command equals to pressing **Preset** at the front panel, namely recalling the default values or user-preset values related to this key.

Related Commands [*RST](#)
[:SYSTem:POWer:ON:TYPE](#)
[:SYSTem:PRESet:TYPE](#)

:SYSTem:PRESet:TYPE

Syntax :SYSTem:PRESet:TYPE FACTory|USER
:SYSTem:PRESet:TYPE?

Description Select the preset type of the system.

Query the preset type of the system.

Parameter

Name	Type	Range	Default
FACTory USER	Discrete	FACTory USER	NULL

Explanation

- When the power-on setting is set to "Preset", the instrument loads the specified preset type ("Factory" or "User") after start-up.
- Pressing **Preset** at the front panel will recall the specified preset type.
- When the preset type is set to "User", you can use the [:SYSTem:PRESet:SAVE](#) command to save the current system configuration.

Return Format The query returns FACTORY or USER.

Example :SYST:PRESet:TYPE USER
:SYST:PRESet:TYPE?

Related Commands [:SYSTem:POWer:ON:TYPE](#)
[:SYSTem:PRESet:SAVE](#)

:SYSTem:PRESet:SAVE

Syntax :SYSTem:PRESet:SAVE

Description Save the user setting.

- Explanation**
- Using this command can save the current system configuration as user-defined setting in the internal non-volatile memory.
 - When **Preset Type** is set to "User" (use the [:SYSTem:PRESet:TYPE](#) command), this configuration will be loaded when recalling "Preset" (use the [:SYSTem:POWer:ON:TYPE](#) command).
 - When **Preset Type** is set to "Factory", this command is invalid.

Related Commands [:SYSTem:POWer:ON:TYPE](#)
[:SYSTem:PRESet:TYPE](#)

:SYSTem:TIME

Syntax :SYSTem:TIME <hour>,<minute>,<second>
:SYSTem:TIME?

Description Set the time displayed on the instrument.

Query the time displayed on the instrument.

Parameter

Name	Type	Range	Default
<hour>	ASCII string	00 to 23	--
<minute>	ASCII string	00 to 59	--
<second>	ASCII string	00 to 59	--

Return Format The query returns the current time in "HH,MM,SS" format.

Example :SYST:TIME 15,10,30
:SYST:TIME?

:TRIGger Commands

Command List:

- ◆ [:TRIGger:IQ\[:IMMEDIATE\]](#)
- ◆ [:TRIGger:LFOutput\[:IMMEDIATE\]](#)
- ◆ [:TRIGger:PULSe\[:IMMEDIATE\]](#)
- ◆ [:TRIGger\[:SWEep\]\[:IMMEDIATE\]](#)

:TRIGger:IQ[:IMMEDIATE]

Syntax :TRIGger:IQ[:IMMEDIATE]

Description Trigger an IQ wave table output immediately.

Explanation When the trigger mode of IQ wave table is set to "Bus", the instrument starts outputting an IQ baseband signal each time this command is sent.

Example :TRIG:IQ

Related Command [*TRG](#)

:TRIGger:LFOutput[:IMMEDIATE]

Syntax :TRIGger:LFOutput[:IMMEDIATE]

Description Trigger a LF sweep-sine immediately.

Explanation When the trigger mode of LF sweep-sine is set to "Bus" and the trigger condition is met, the instrument starts a sweep each time this command is sent.

Example :TRIG:LFO

Related Command [*TRG](#)

:TRIGger:PULSe[:IMMEDIATE]

Syntax :TRIGger:PULSe[:IMMEDIATE]

Description Trigger a pulse modulation immediately.

Explanation When the "Trig Mode" of PULSE is set to "Bus", the instrument starts a pulse modulation each time this command is sent.

Example :TRIG:PULS

Related Command [*TRG](#)

:TRIGger[:SWEep][:IMMEDIATE]

Syntax :TRIGger[:SWEep][:IMMEDIATE]

Description Trigger a RF sweep immediately.

Explanation When the "Trig Mode" or "Point Trig" mode of SWEEP is set to "Bus" and the trigger conditions are met, the instrument starts a RF sweep within the sweep period or sweeps a point and then stops each time this command is sent.

Example :TRIG:SWE

Related Command [*TRG](#)

:UNIT Command

Command List:

◆ [:UNIT:POWer](#)

:UNIT:POWer

Syntax :UNIT:POWer DBM|DBMV|DBUV|V|W
:UNIT:POWer?

Description Set the output and display unit of the amplitude.

Query the output and display unit of the amplitude.

Parameter

Name	Type	Range	Default
DBM DBMV DBUV V W	Discrete	DBM DBMV DBUV V W	dBm

Return Format The query returns DBM, DBMV, DBUV, V or W.

Example :UNIT:POW V
:UNIT:POW?

Chapter 3 Application Examples

This chapter provides some application examples of the SCPI commands. A series of SCPI commands are combined to realize the main functions of the RF signal generator.

Note:

1. The examples in this chapter are based on DSG3060. For other models, the ranges of some parameters might be different. When using the commands, please make proper adjustment according to the model of your instrument.
2. Before using the examples in this chapter, please select the desired communication interface (USB, LAN, or GPIB) and make correct connections (refer to the introductions in [To Build Remote Communication](#)). Besides, you have to install Ultra Sigma or other PC software for sending commands on your PC.
3. The content enclosed in "/*" and "*/" after each command is annotation for easier understanding and is not a part of the command.

Main topics of this chapter:

- ◆ [To Output RF signal](#)
- ◆ [To Output RF Sweep Signal](#)
- ◆ [To Output RF Modulated Signal](#)
- ◆ [To Output Pulse Train](#)

To Output RF signal

Requirement

Use the SCPI commands to realize the following functions:

Output a RF signal with 1 GHz frequency and -40 dBm amplitude from the **[RF OUTPUT 50Ω]** connector.

Method

- | | | |
|----|---------------------|--|
| 1. | *IDN? | /*Query the ID string of the RF signal generator to check whether the remote communication is normal*/ |
| 2. | :SYST:PRES:TYPE FAC | /*Set the preset type to "Factory"*/ |
| 3. | :SYST:PRES | /*Restore the instrument to the factory setting*/ |
| 4. | :FREQ 1GHz | /*Set the RF signal frequency to 1 GHz*/ |
| 5. | :LEV -40 | /* Set the RF signal amplitude to -40 dBm*/ |
| 6. | :OUTP ON | /*Enable the RF output*/ |

To Output RF Sweep Signal

Requirement

Use the SCPI commands to realize the following functions:

Output a RF sweep signal from the **[RF OUTPUT 50Ω]** connector by configuring continuous linear step sweep. Set the frequency range to 1 GHz to 2 GHz, the amplitude range to -20 dBm to 0 dBm, the number of sweep points to 10 and the dwell time to 500 ms.

Method

- | | | |
|-----|--------------------------|--|
| 1. | *IDN? | /*Query the ID string of the RF signal generator to check whether the remote communication is normal*/ |
| 2. | :SYST:PRES:TYPE FAC | /*Set the preset type to "Factory"*/ |
| 3. | :SYST:PRES | /*Restore the instrument to the factory setting (by default, the sweep mode is continuous, the sweep type is step and the sweep spacing is linear)*/ |
| 4. | :SWE:STEP:STAR:FREQ 1GHz | /*Set the start frequency of step sweep to 1 GHz*/ |
| 5. | :SWE:STEP:STOP:FREQ 2GHz | /*Set the stop frequency of step sweep to 2 GHz*/ |
| 6. | :SWE:STEP:STAR:LEV -20 | /*Set the start level of step sweep to 20 dBm*/ |
| 7. | :SWE:STEP:STOP:LEV 0 | /*Set the stop level of step sweep to 0 dBm*/ |
| 8. | :SWE:STEP:POIN 10 | /*Set the number of step sweep points to 10*/ |
| 9. | :SWE:STEP:DWEL 500ms | /*Set the dwell time of step sweep to 500ms*/ |
| 10. | :SWE:STAT LEV,FREQ | /*Enable the frequency and amplitude sweep functions at the same*/ |
| 11. | :OUTP ON | /*Enable the RF output*/ |

To Output RF Modulated Signal

Requirement

Use the SCPI commands to realize the following functions:

Output an AM modulated signal. Set the carrier frequency to 800 MHz, the carrier amplitude to -20 dBm, the AM modulation depth to 60% and the modulation frequency to 20 kHz.

Method

- | | | |
|-----|---------------------|---|
| 1. | *IDN? | /*Query the ID string of the RF signal generator to check whether the remote communication is normal*/ |
| 2. | :SYST:PRES:TYPE FAC | /*Set the preset type to "Factory"*/ |
| 3. | :SYST:PRES | /*Restore the instrument to the factory setting (by default, the modulation source is internal and the modulation waveform is sine)*/ |
| 4. | :FREQ 800MHz | /*Set the RF carrier frequency to 800 MHz*/ |
| 5. | :LEV -20 | /*Set the RF carrier amplitude to -20 dBm*/ |
| 6. | :AM:DEPT 60 | /*Set the AM modulation depth is 60%*/ |
| 7. | :AM:FREQ 20kHz | /*Set the AM modulation frequency to 20 kHz*/ |
| 8. | :AM:STAT ON | /*Enable the AM function*/ |
| 9. | :MOD:STAT ON | /*Enable the RF modulation output*/ |
| 10. | :OUTP ON | /*Enable the RF output*/ |

Note: The **RF** and **MOD** switches must be turned on.

To Output Pulse Train

Requirement

Use the SCPI commands to realize the following functions:

Output a user-defined pulse train from the **[PULSE IN/OUT]** connector at the rear panel of the RF signal generator. The specific parameters to be set in the pulse list are as shown in the table below.

SN	On Time	Off Time	Repeat
1	10ms	30ms	2
2	20ms	40ms	1

Method

1. *IDN? /*Query the ID string of the RF signal generator to check whether the remote communication is normal*/
2. :SYST:PRES:TYPE FAC /*Set the preset type to "Factory"*/
3. :SYST:PRES /*Restore the instrument to the factory setting*/
4. :SYST:LKEY QA7ZCZEH6AC54SFNKA853MS5CB3A /*Install the pulse train generator option^[4]*/
5. :PULM:TRA:LIST:COUN? /*Query the total number of rows of the current pulse list*/
6. :PULM:TRA:LIST:INSE 20ms,40ms,1 /*Insert a row of pulse values above the current row. (On Time is 20ms, Off Time is 40ms and Repeat is 1*/
7. :PULM:TRA:LIST:INSE 10ms,30ms,2 /*Insert a row pulse value above the current row. (On Time is 10ms, Off Time is 30ms and Repeat is 2*/
8. :PULM:TRA:LIST:DEL 3 /*Take the total number of rows in the list is 1 as an example. Delete the redundant pulse values of the third row*/
9. :PULM:TRA:LIST:RUN /*Run the pulse list and set the internal modulating signal to the current pulse values*/
10. :PULM:SOUR INT /*Select internal modulation source (internal pulse generator)*/
11. :PULM:MODE TRA /*Set the pulse mode to "Train"*/
12. :PULM:OUT:STAT ON /*Enable the pulse output*/

Note^[4]: The serial number of each option is unique and is only used by one instrument (the serial number of the option corresponds to the serial number of the instrument bought) .

Chapter 4 Programming Demos

This chapter provides the demos for programming and controlling the RF signal generator using SCPI commands under Excel, Matlab, LabVIEW, Visual Basic and Visual C++ environment on the basis of NI-VISA.

NI-VISA (National Instrument-Virtual Instrument Software Architecture) is an advanced application programming interface developed by NI (National Instrument) for communicating with various instrument buses. It can communicate with the instrument in the same method regardless of the type of the instrument interface (GPIB, USB or LAN/Ethernet).

The instrument communicating with NI-VISA via various interfaces is called "resource". The VISA descriptor (namely the resource name) is used to describe the accurate name and location of the VISA resource. If LAN interface is currently used for communicating with the instrument, the VISA descriptor is :TCPIP0::172.16.3.199::INSTR. Before programming, please acquire the correct VISA descriptor.

Main topics of this chapter:

- ◆ [Programming Preparations](#)
- ◆ [Excel Programming Demo](#)
- ◆ [Matlab Programming Demo](#)
- ◆ [LabVIEW Programming Demo](#)
- ◆ [Visual Basic Programming Demo](#)
- ◆ [Visual C++ Programming Demo](#)

Programming Preparations

Before programming, you need to make the following preparations:

- 1 Make sure that your PC has installed the NI-VISA library (can be downloaded from the NI website: <http://www.ni.com/visa>). Here, the default installation path is C:\Program Files\IVI Foundation\VISA.
- 2 Here, the USB interface of the RF signal generator is used to communicate with the PC and please use USB cable to connect the USB DEVICE interface at the rear panel of the RF signal generator to the PC.
- 3 Turn on the instrument after connecting the RF signal generator and PC.
4. At this point, the "**Found New Hardware Wizard**" dialog box appears on the PC. Please follow the instructions to install the "USB Test and Measurement Device (IVI)".

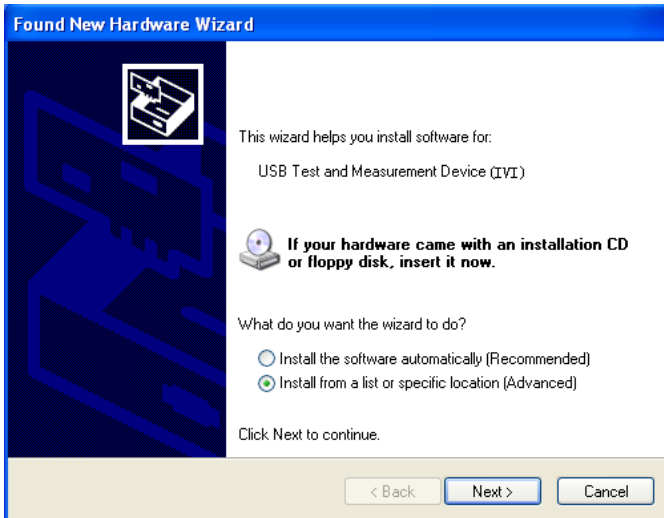

5. Acquire the USB VISA descriptor of the RF signal generator: run Ultra Sigma and search for the RF signal generator currently connected to the PC. The VISA descriptor searched is displayed under the "RIGOL Online Resource" directory, including the instrument model and the USB interface information (namely the VISA descriptor) as shown in the figure below. Here, the VISA descriptor of the RF signal generator is USB0::0x1AB1::0x0992::DSG3A1301080006::INSTR.

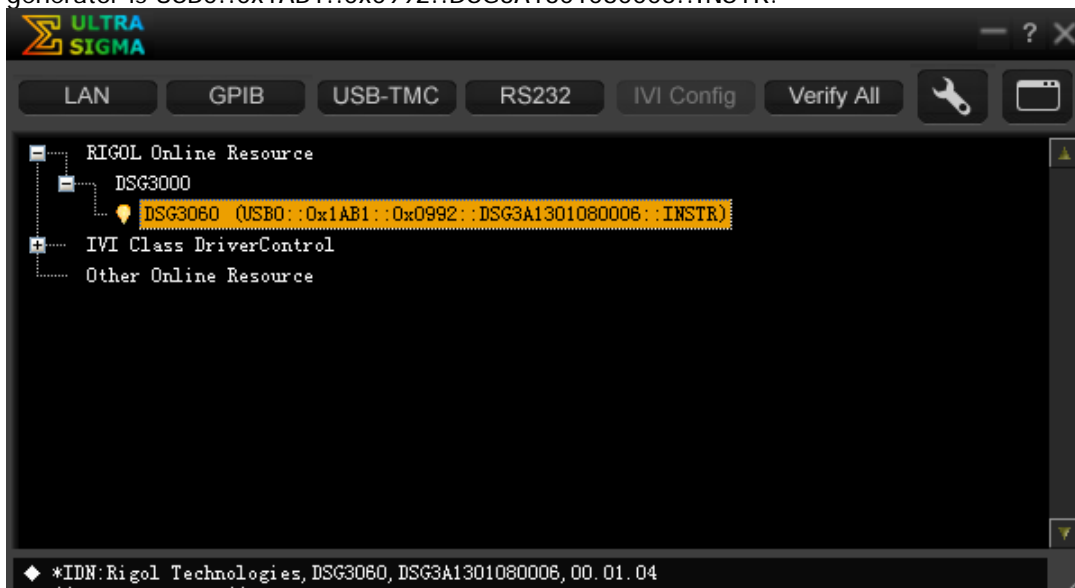

By now, the programming preparations are finished.

Excel Programming Demo

The program used in this demo: Microsoft Excel 2010

The functions realized in this demo: send the *IDN? Command to read the device information.

1. Create a new Excel file that enables the Macro. In this example, the file is named as DSG3000_Demo_Excel.xlsx.
2. Run DSG3000_Demo_Excel.xlsx. Click **File** → **Options** at the upper-left corner of the Excel file to open the interface as shown in the figure below. Click **Customize Ribbon** at the left, check **Developer** and click **OK**. At this point, the Excel menu bar displays the **Developer** menu.

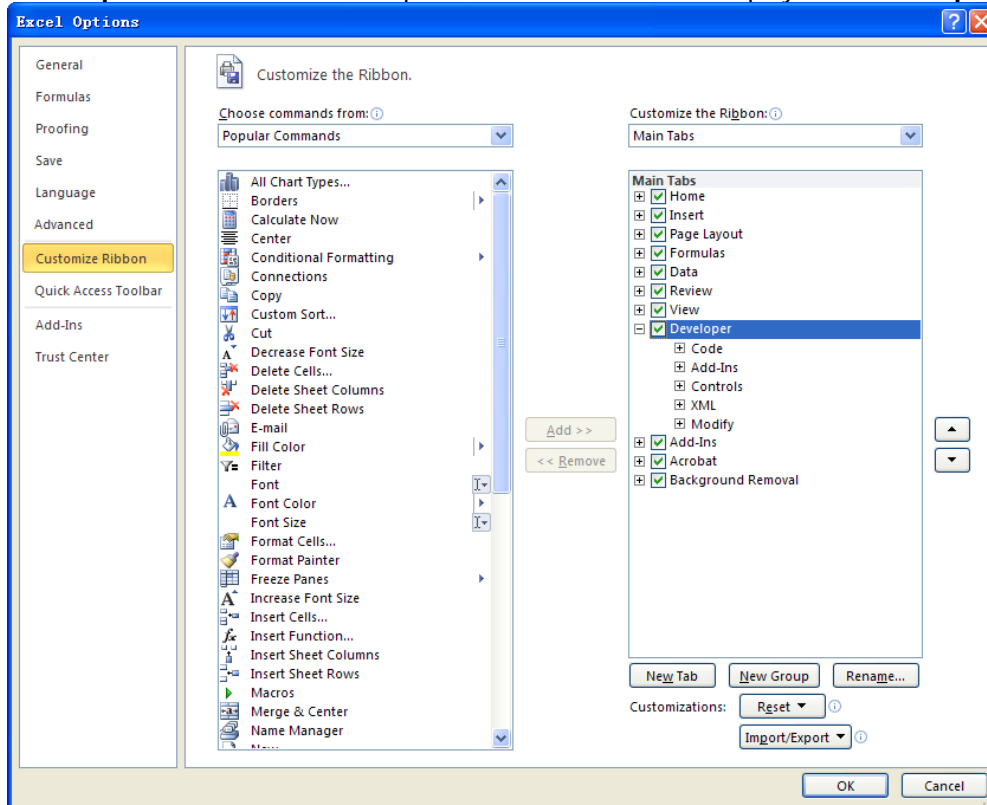

3. Input the VISA descriptor into a cell of the file as shown in the figure below. Click the **Developer** menu and select the **Visual Basic** option to open the Microsoft Visual Basic.

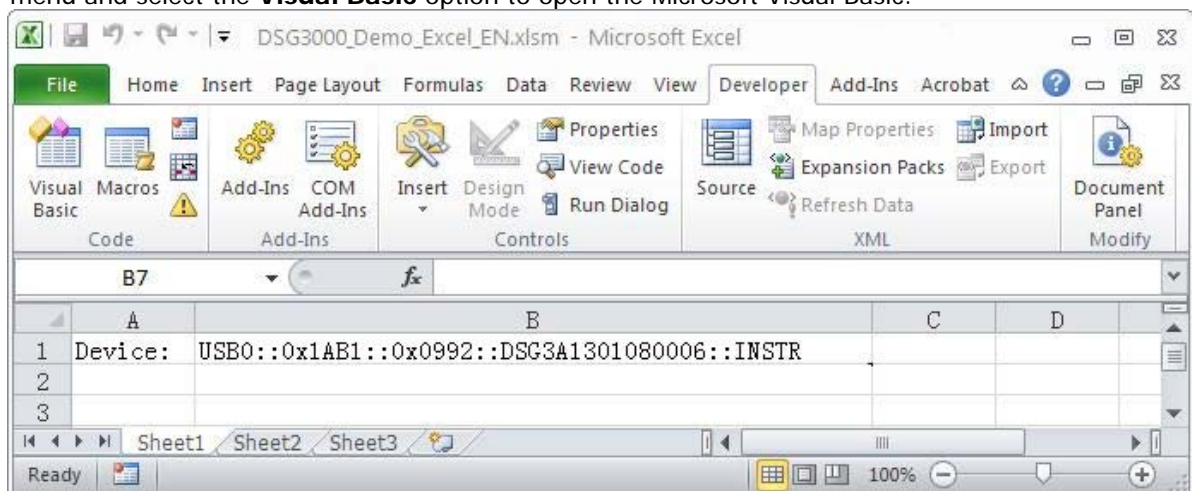

- 4. Select **Tools** in the Microsoft Visual Basic menu bar and click **References**.

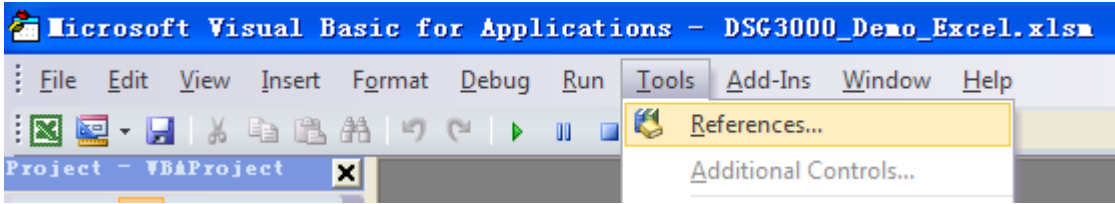

Select **VISA Library** in the pop-up dialog box and click **OK** to refer to the VISA Library.

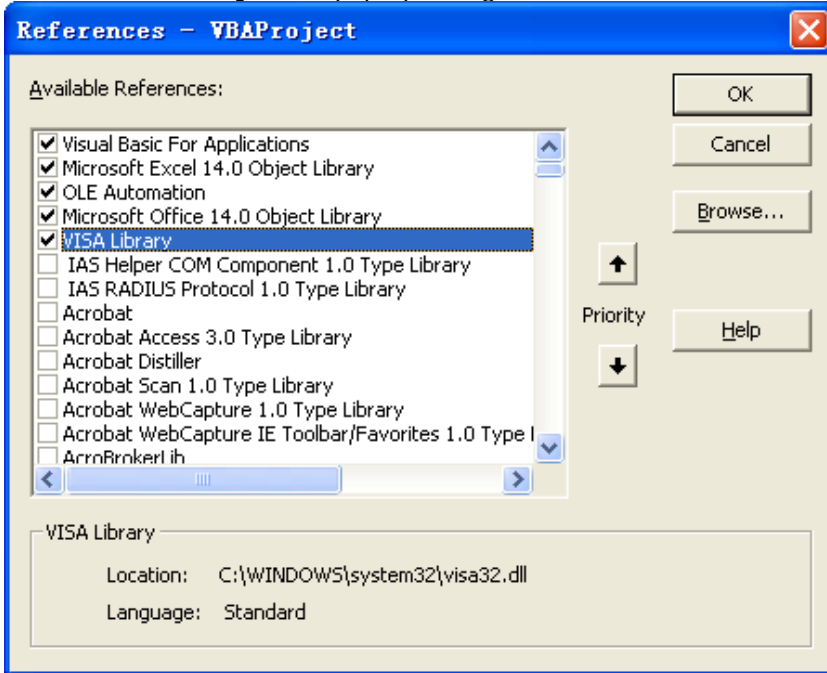

Explanation:

If you cannot find the VISA Library in the left list in the figure above, please try to find it using the following method.

- (1) Make sure that you have installed the NI-VISA library on your PC.
- (2) Click **Browse...** at the right and set the search range to **C:\WINDOWS\system32** and the filename to **visa32.dll**, as shown in the figure below.

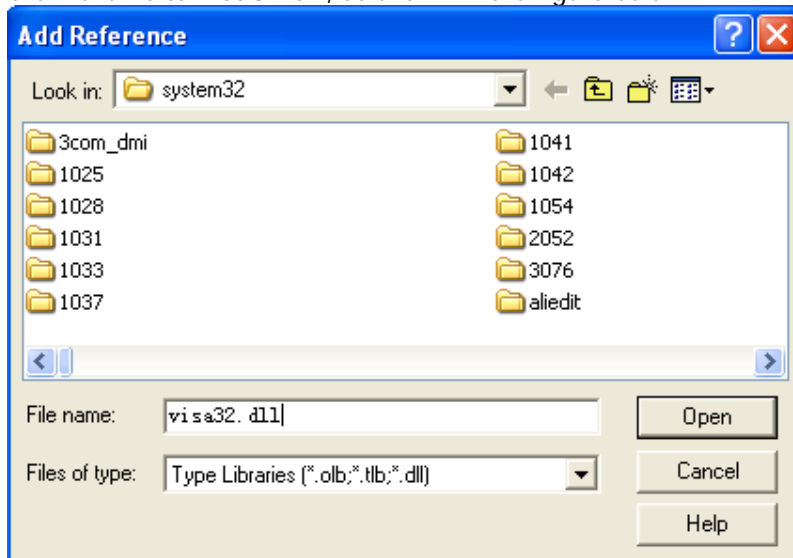

- Click **View Code** in the **Developer** menu to enter the Microsoft Visual Basic interface. Add the following codes and save the file.

Note: If the Excel file created at step 2 does not enable the Macros, at this point, the prompt message "The following features cannot be saved in macro-free workbooks" will be displayed. In this situation, please save the Excel file as a file using the Macros.

Sub QueryIdn()

```
Dim viDefRm As Long
Dim viDevice As Long
Dim viErr As Long
Dim cmdStr As String
Dim idnStr As String * 128
Dim ret As Long
```

'Turn on the device. The device descriptor is in CELLS(1,2) of SHEET1'

```
viErr = visa.viOpenDefaultRM(viDefRm)
viErr = visa.viOpen(viDefRm, Sheet1.Cells(1, 2), 0, 5000, viDevice)
```

'Send request to read data. The return value is in CELLS(2,2) of SHEET1'

```
cmdStr = "*IDN?"
viErr = visa.viWrite(viDevice, cmdStr, Len(cmdStr), ret)
viErr = visa.viRead(viDevice, idnStr, 128, ret)
Sheet1.Cells(2, 2) = idnStr
```

'Turn off the device'

```
visa.viClose (viDevice)
visa.viClose (viDefRm)
```

End Sub

- Add button control: click **Insert** in the **Developer** menu, select the desired button in **Form Controls** and put it into the cell of the Excel. At this point, the **Assign Macro** interface is displayed, select "Sheet1.QueryIdn" and click **OK**.

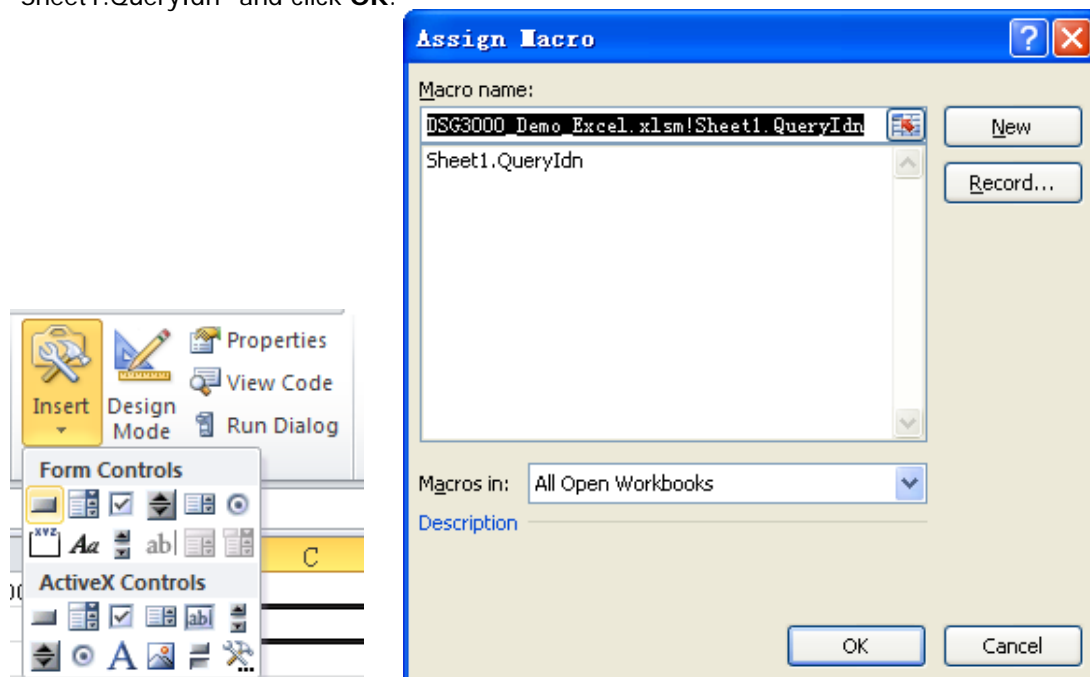

By default, the button name is "Button 1". Right-click the button and select **Edit Text** in the pop-up menu to change the button name to "*IDN?".

7. Click the "*IDN?" button to run the program. The device information of the RF signal generator is as shown in the figure below.

A	B	C
Device:	USB0::0x1AB1::0x0992::DSG3A1301080006::INSTR Rigol Technologies, DSG3060, DSG3A1301080006, 00.01.01	*IDN?

Matlab Programming Demo

The program used in this demo: MATLAB R2009a

The functions realized in this demo: read the current frequency and amplitude of the RF signal generator.

1. Run Matlab and modify the current directory (namely modify the **Current Directory** at the top of the software). In this example, the current directory is changed to D:\DSG3000_Demo.

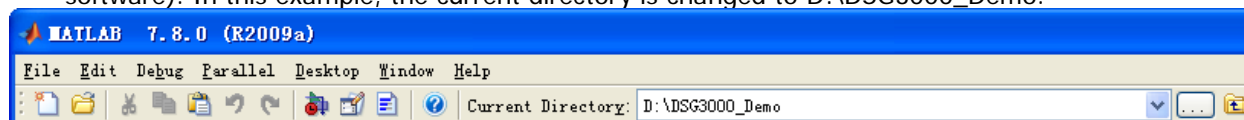

2. Click **File** → **New** → **Blank M-File** in the Matlab interface to create a blank M file.
3. Add the following codes in the M file.

```
dsg3000 = visa('ni','USB0::0x1AB1::0x0992::DSG3A1301080006::INSTR'); %Create Visa object
fopen(dsg3000); %Open the visa object created
fprintf(dsg3000, ':FREQ?'); %Send request to query the frequency
meas_RF_FREQ = fscanf(dsg3000); %Read the frequency data
fprintf(dsg3000, ':LEV?'); %Send request to query the amplitude
meas_RF_LEV = fscanf(dsg3000); %Read the amplitude data
fclose(dsg3000); %Close the visa object
display(meas_RF_FREQ); %Display the frequency read
display(meas_RF_LEV) %Display the amplitude read
```

4. Save the M file in the current directory. In this example, the M file is named as DSG3000_Demo_MATLAB.m.
5. Run the M file and the command window displays the following results.

```
meas_RF_FREQ =
500000000

meas_RF_LEV =
-140.00
```

The results above denotes that the current frequency of the RF signal generator is 500 MHz and the amplitude is -140 dBm.

LabVIEW Programming Demo

The program used in this demo: LabVIEW 2009

The functions realized in this demo: search for instrument address, connect the instrument, send command and read the return value.

1. Run LabVIEW 2009. Create a new VI file and name it as DSG3000_Demo_LABVIEW.
2. Add controls in the front panel interface, including the address bar, command bar and return bar as well as the Connect, Write, Read and Exit buttons.

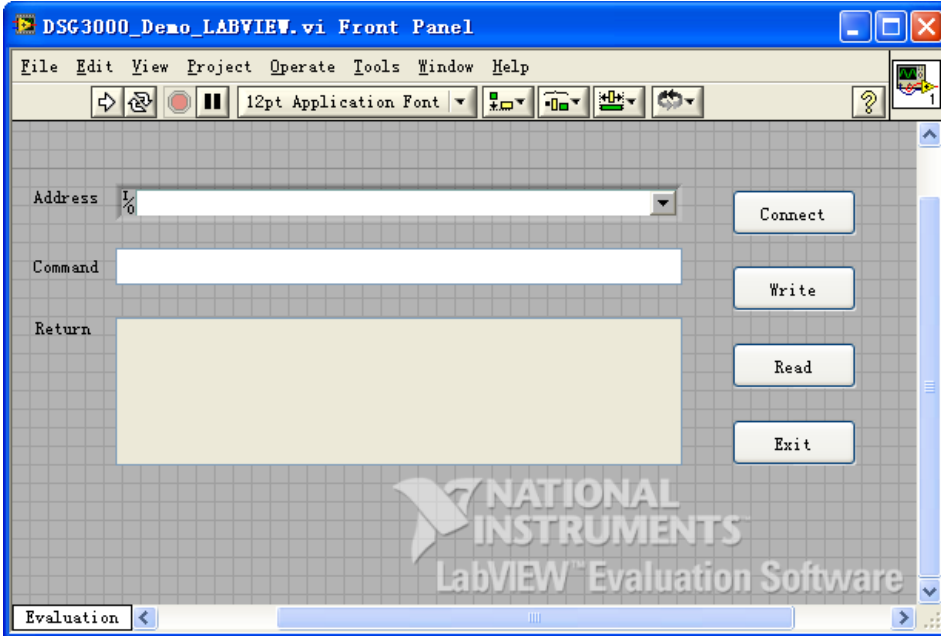

3. Click **Show Block Diagram** in the Window menu to create the event structure.

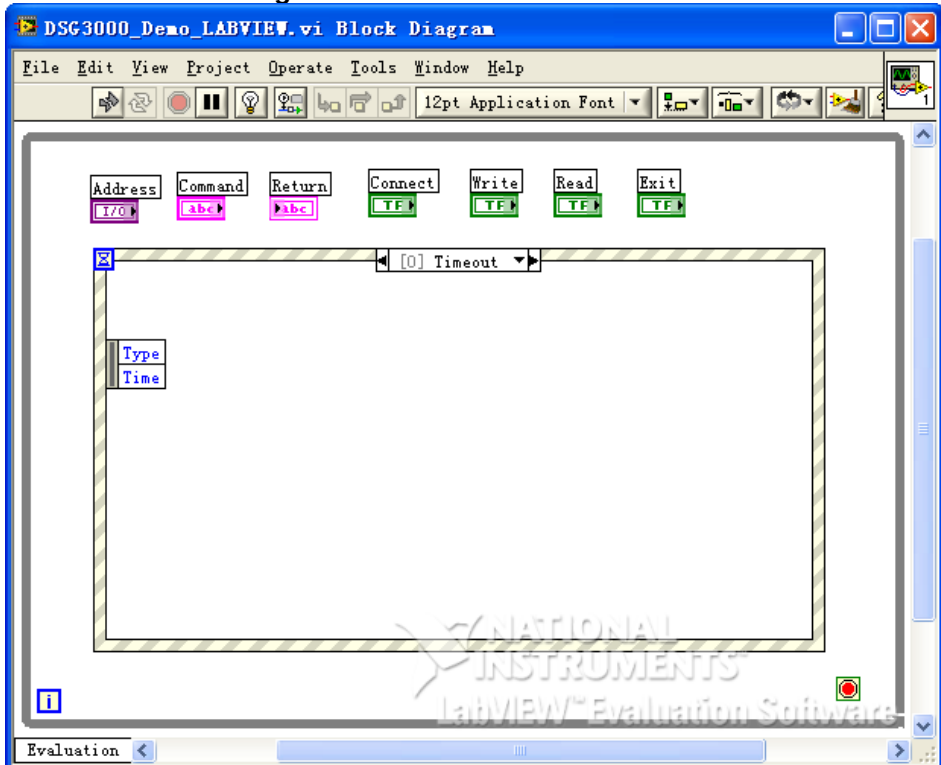

4. Add events, including connect the instrument, write operation, read operation and exit.
 (1) Connect the instrument (include error processing):

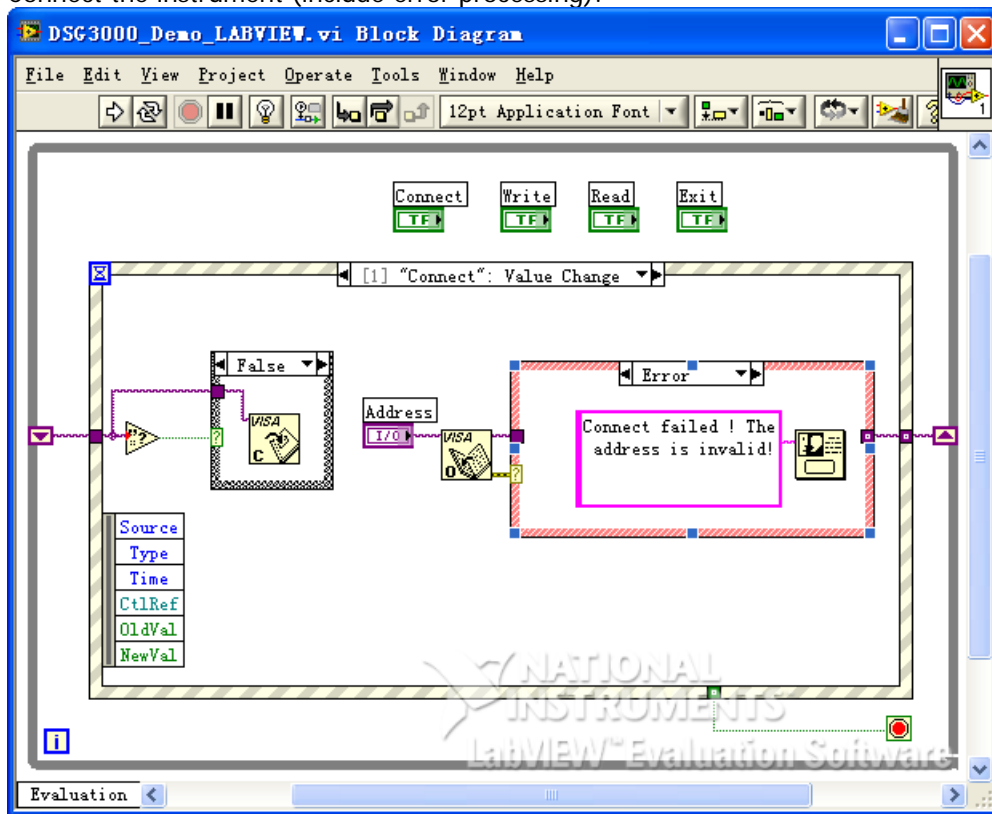

- (2) Write operation (include error judgment):

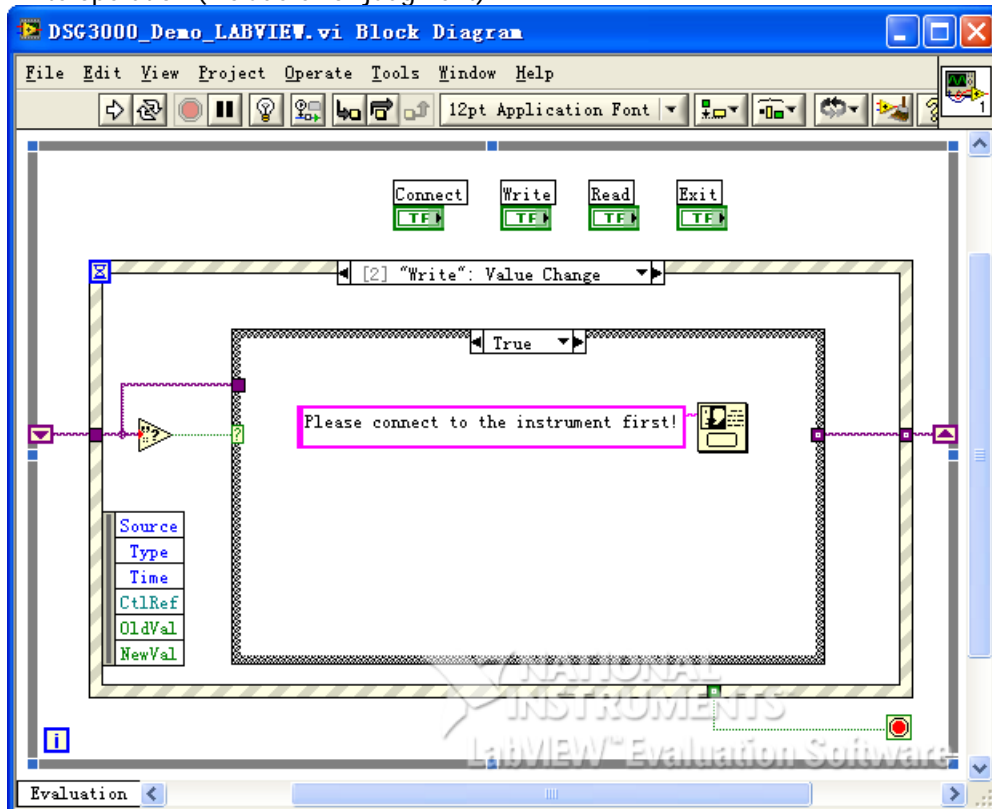

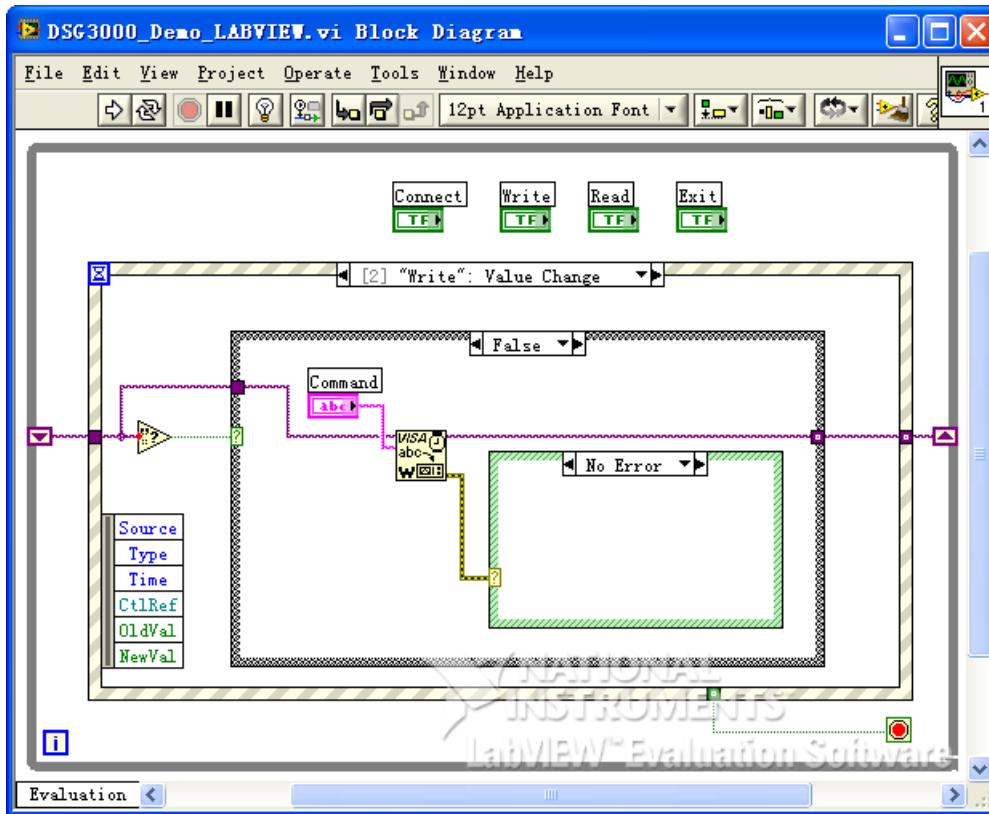

(3) Read operation (include error processing):

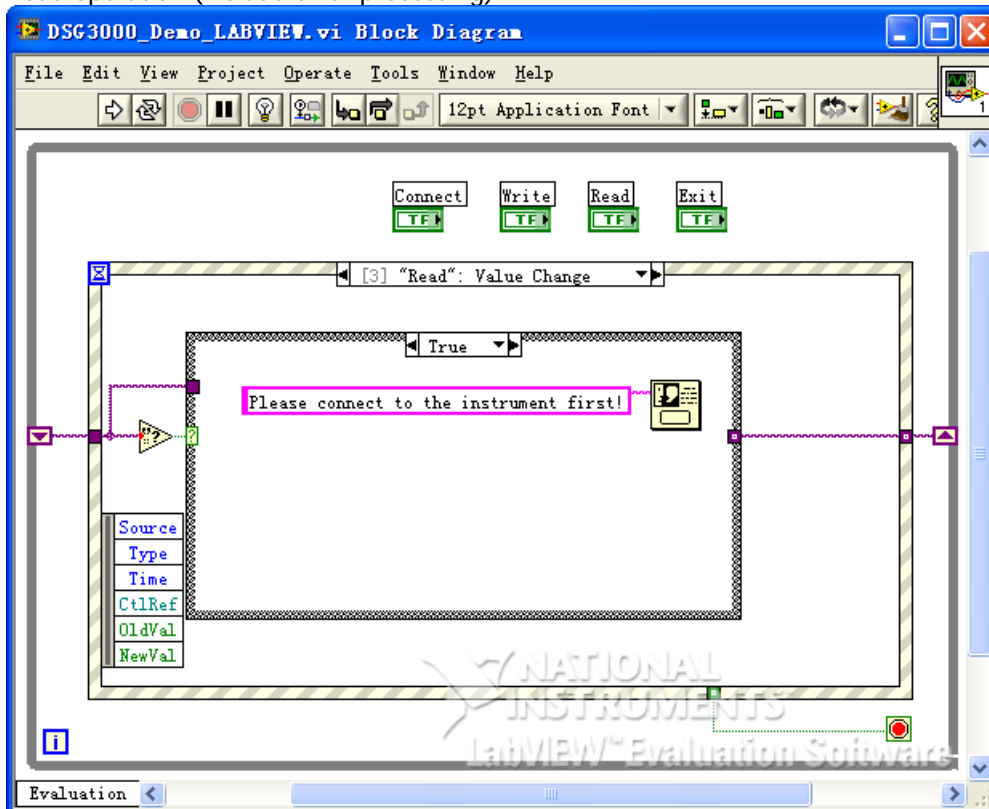

(4) Exit:

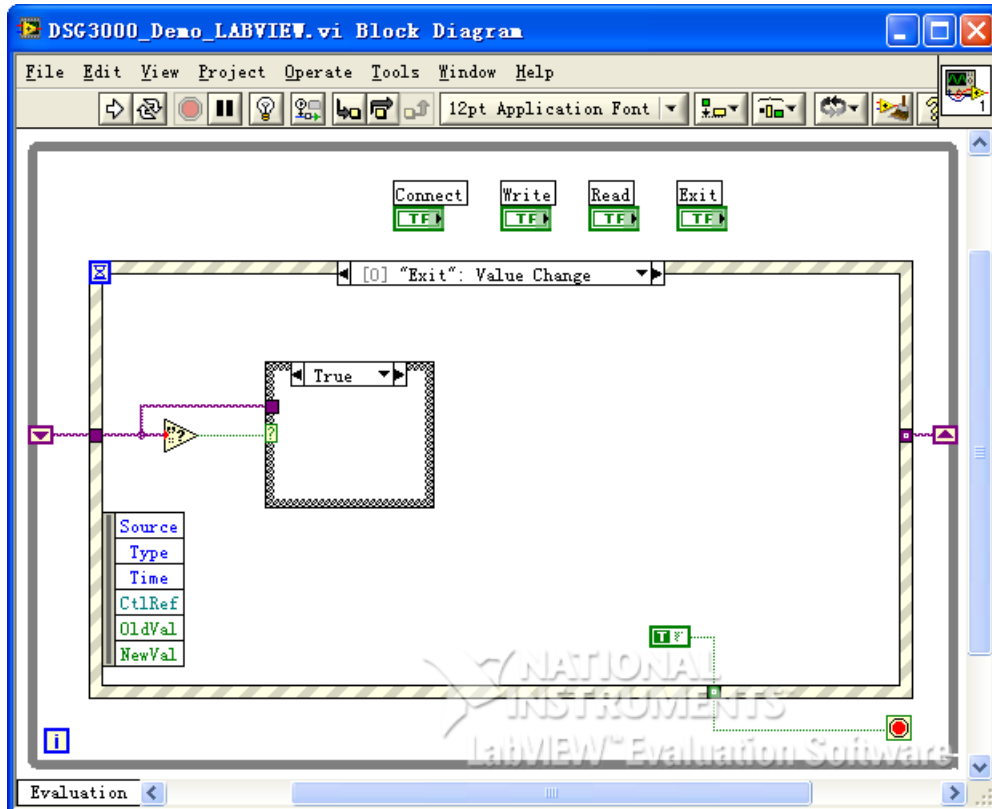

5. Run the program and the interface as shown below is displayed. Click the **Address** dropdown box and select the VISA resource name. Click **Connect** to connect the instrument, input the command in the **Command** text box and click **Write** to write the command into the instrument. If the command is a query command (for example, :FREQ?), you need to first click **Write** to write the command into the instrument and then click **Read**. The return value 1000000000 (denote that the current frequency of the RF signal generator is 1 GHz) is displayed in the **Return** text box. Click **Exit** to exit the program.

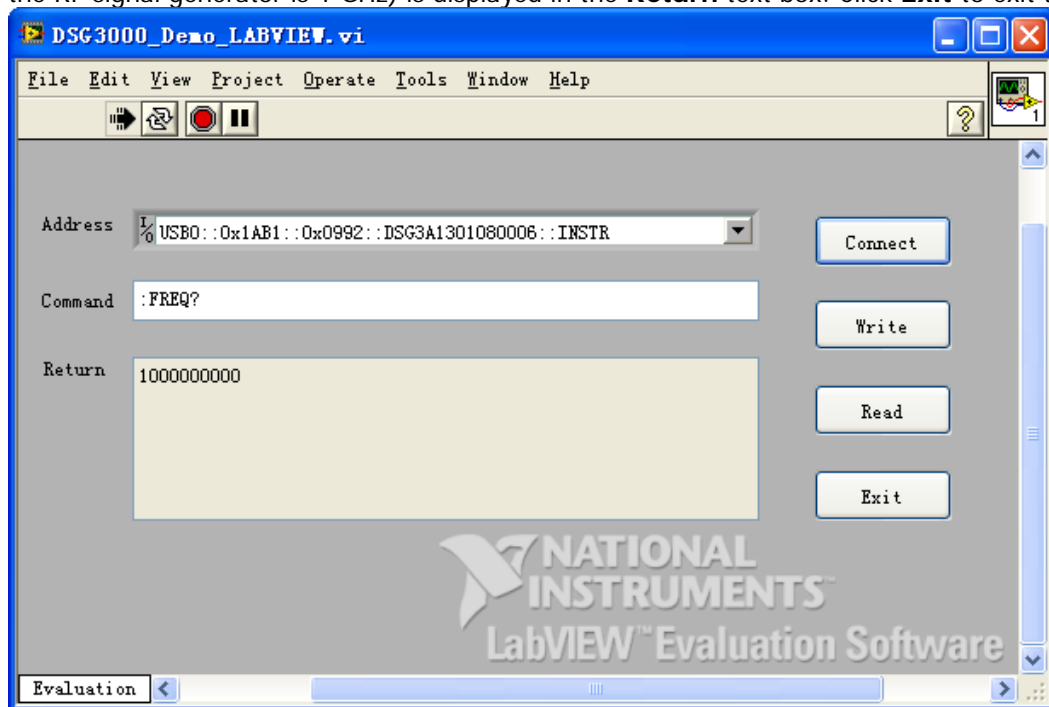

Visual Basic Programming Demo

The program used in this demo: Visual Basic 6.0

The functions realized in this demo: turn on the LF, MOD and RF output switches respectively and use yellow label to indicate that the output is turned on.

1. Build a standard application program project (Standard EXE) and name it as DSG3000_Demo_VB.
2. Click the **Existing** tab under **Project** → **Add Module**. Find the visa32.bas file under the **include** folder in the installation directory of NI-VISA and add the file.

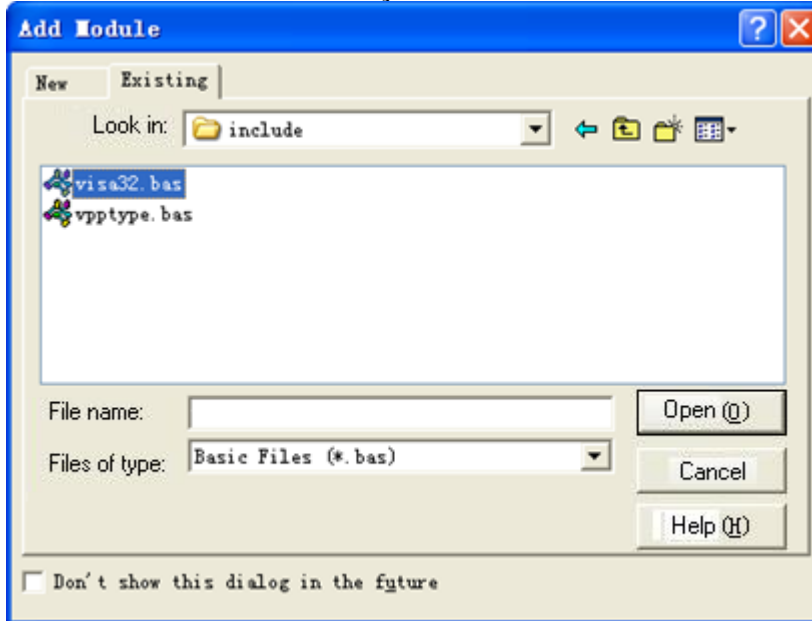

3. Add three CommandButton controls to represent LF, MOD and RF respectively. Add three Label controls (Label1(0), Label1(1) and Label1(2)) to denote the status of the three switches respectively (the controls are gray by default and are yellow when the output switches are turned on). The layout is as shown in the figure below.

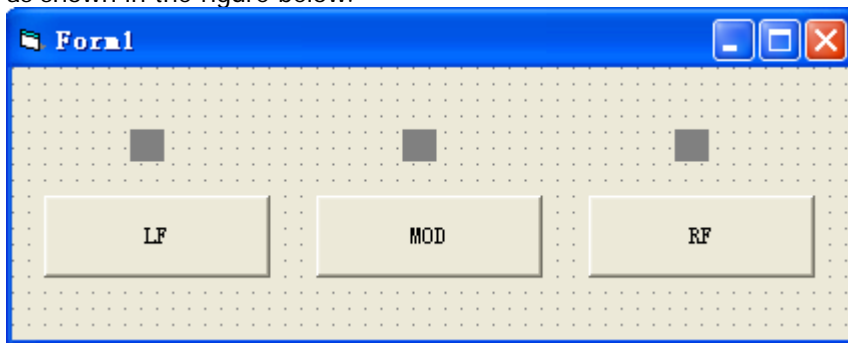

4. Open the **General** tab under **Project** → **Project1 Properties** and select **Form1** from the **Startup Object** dropdown box.
5. Double-click the LF button to enter the programming environment and add the following codes to realize the control of LF, MOD and RF. The codes of LF are as shown below. The codes of MOD and RF are similar.

```
Dim defrm As Long
Dim vi As Long
Dim strRes As String * 20
```



```

Dim list As Long
Dim nmatches As Long
Dim matches As String * 200 'Keep the device number acquired

' Acquire the usb resource of visa
Call viOpenDefaultRM(defrm)
Call viFindRsrc(defrm, "USB?* ", list, nmatches, matches)

' Turn on the device
Call viOpen(defrm, matches, 0, 0, vi)

' Send command to query the status of the LF switch
Call viVPrintf(vi, ":LFO?" + Chr$(10), 0)

' Acquire the status of LF
Call viVScanf(vi, "%t", strRes)

If strRes = 1 Then

' Send the setting command
Call viVPrintf(vi, ":LFO OFF" + Chr$(10), 0)
Label1(0).ForeColor = &H808080 'Gray

Else

Call viVPrintf(vi, ":LFO ON" + Chr$(10), 0)
Label1(0).ForeColor = &HFFFF& 'Yellow

End If

' Turn off the resource
Call viClose(vi)
Call viClose(defrm)

```

6. Execution Results

- 1) Click "LF" to turn on the LF output. The control above the **LF** button turns yellow (as shown in the figure below). At this point, the RF signal generator can output LF signal via the **[LF OUTPUT]** connector according to the current configuration. Click "LF" again to turn off the LF output and the control above the **LF** button turns gray.

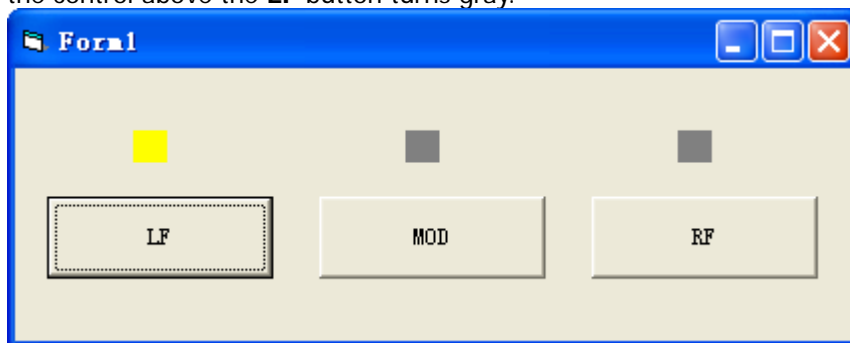

- 2) Click "MOD" to turn on the modulation output and the control above the **MOD** button turns yellow (as shown in the figure below). At this point, the **[RF OUTPUT 50Ω]** connector outputs the modulated RF signal (the RF output must be turned on) according to the current configuration. Click "MOD" again to turn off the modulation and the control above the **MOD** button turns gray.

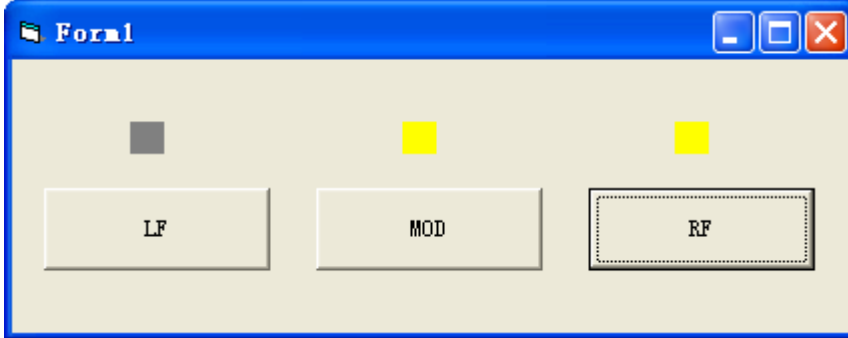

- 3) Click "RF" to turn on the RF output and the control above the **RF** button turns yellow (as shown in the figure below). At this point, the RF signal generator can output RF signal via the **[RF OUTPUT 50Ω]** connector according to the current configuration. Click "RF" again to turn off the RF output and the control above the **RF** button turns gray.

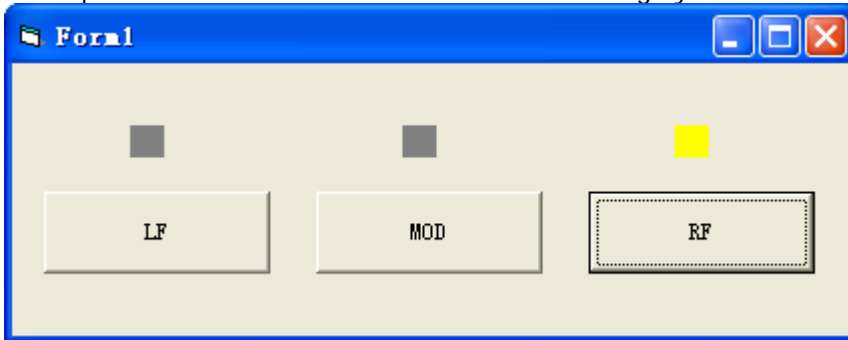

Visual C++ Programming Demo

The program used in this demo: Microsoft Visual C++ 6.0

The functions realized in this demo: search for instrument address, connect the instrument, send command and read the return value.

1. Run Microsoft Visual C++ 6.0. Create a new MFC project based on dialog box and name it as DSG3000_DEMO_VC.
2. Click **Project** → **Settings** and add **visa32.lib** under the **Link** tab in the pop-up interface manually.

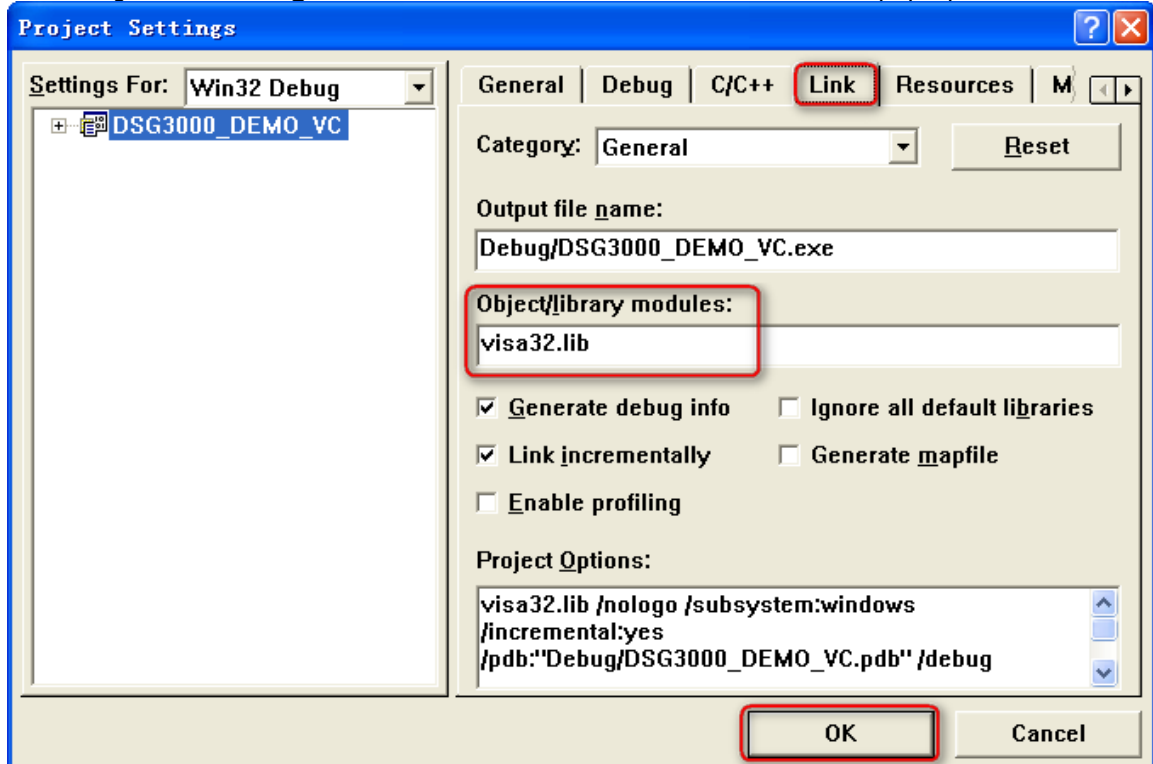

3. Click **Tools** → **Options** and add the **Include** and **Lib** directories under the **Directories** tab in the pop-up interface.

Select **Include files** in **Show directories for** and double-click at the blank in **Directories** to add the path of **Include**: C:\Program Files\IVI Foundation\VISA\WinNT\include.

Select **Library files** in **Show directories for** and double-click at the blank in **Directories** to add the path of **Lib**: C:\Program Files\IVI Foundation\VISA\WinNT\lib\msc.

Note:

The two directories are related to the installation directory of NI-VISA on your PC. Here, NI-VISA is installed under C:\Program Files\IVI Foundation\VISA by default.

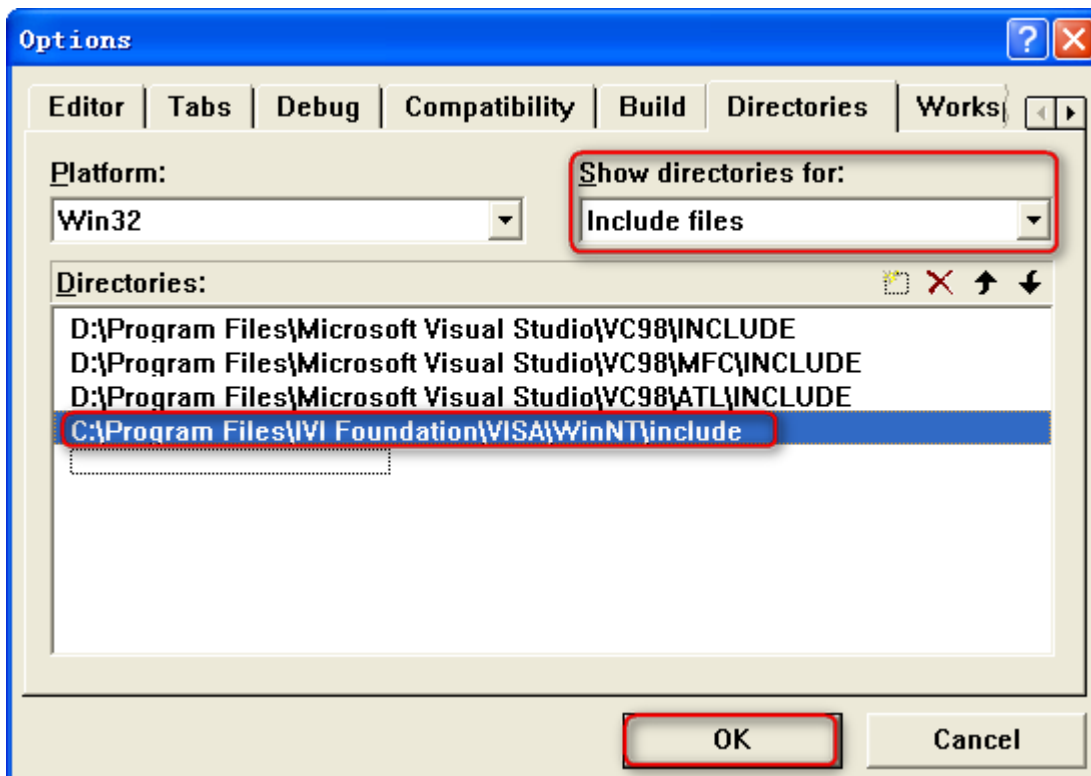

4. Add the **Text**, **Edit** and **Button** controls as shown in the figure below.

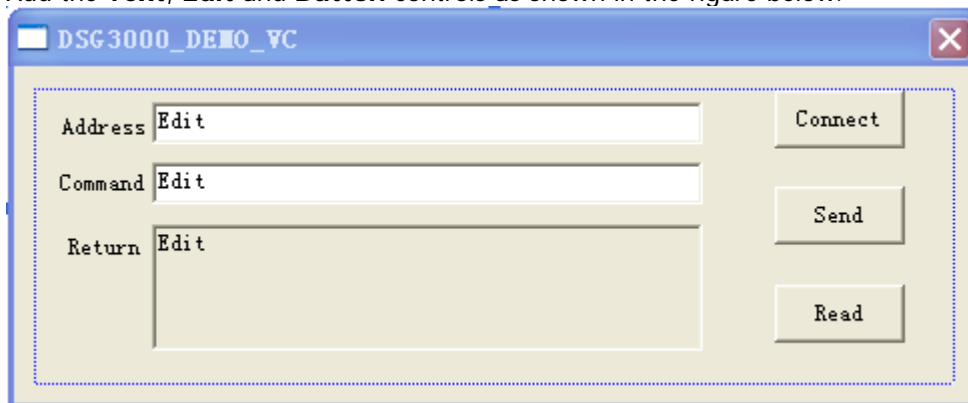

5. Click **View** → **ClassWizard** and add the control variables under the **Member Variables** tab in the pop-up interface.
 Instrument Address: CString m_strInstrAddr
 Command: CString m_strCommand
 Return Value: CString m_strResult

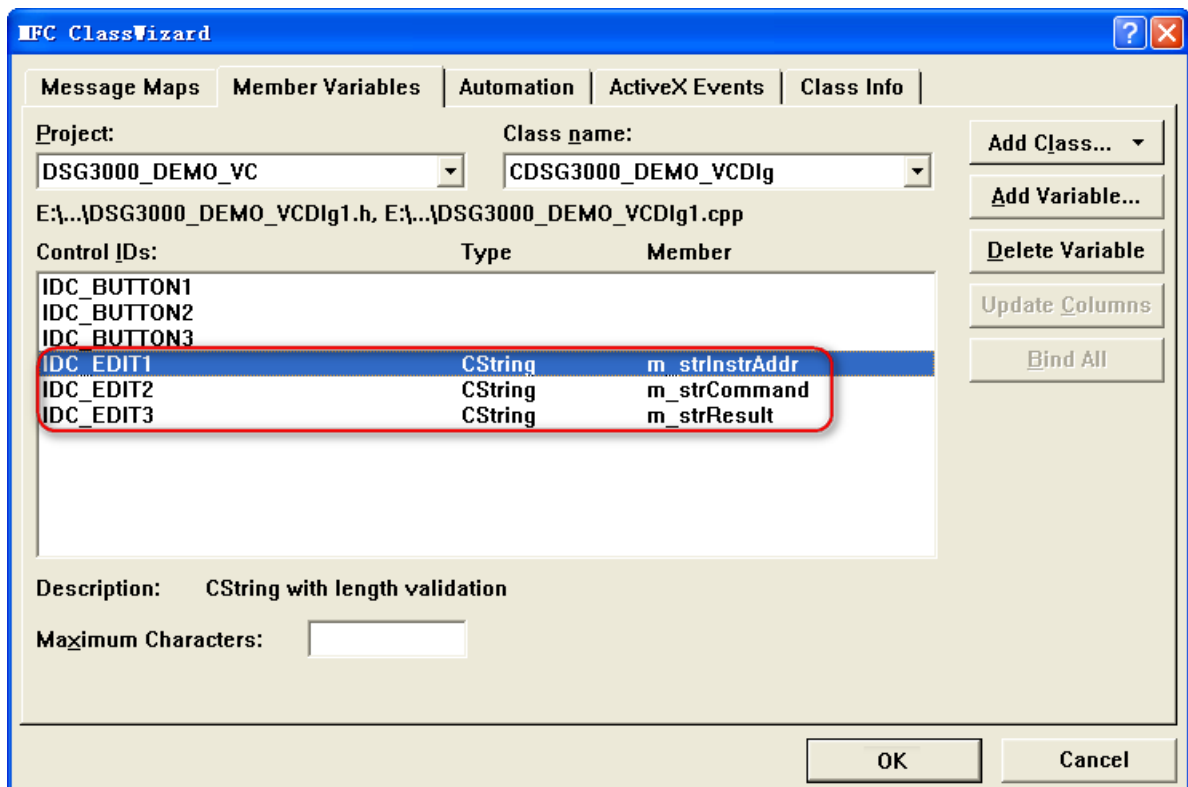

6. Encapsulate the read and write operations of VISA.

1) Encapsulate the write operation of VISA for easier operation.

```
bool CDSG3000_DEMO_VCDlg::InstrWrite(CString strAddr, CString strContent) //write function
```

```
{
```

```
    ViSession defaultRM,instr;
    ViStatus status;
    ViUInt32 retCount;
    char * SendBuf = NULL;
    char * SendAddr = NULL;
    bool bWriteOK = false;
    CString str;
```

```
    //Change the address's data style from CString to char*
```

```
    SendAddr = strAddr.GetBuffer(strAddr.GetLength());
    strcpy(SendAddr,strAddr);
    strAddr.ReleaseBuffer();
```

```
    //Change the command's data style from CString to char*
```

```
    SendBuf = strContent.GetBuffer(strContent.GetLength());
    strcpy(SendBuf,strContent);
    strContent.ReleaseBuffer();
```

```
    //open the VISA instrument
```

```
    status = viOpenDefaultRM(&defaultRM);
    if (status < VI_SUCCESS)
    {
        AfxMessageBox("No VISA instrument was opened !");
        return false;
    }
}
```

```
status = viOpen(defaultRM, SendAddr, VI_NULL, VI_NULL, &instr);
//write command to the instrument
```

```
status = viWrite(instr, (unsigned char *)SendBuf, strlen(SendBuf), &retCount);
```

```
//close the instrument
```

```
status = viClose(instr);
```

```
status = viClose(defaultRM);
```

```
return bWriteOK;
```

```
}
```

- 2) Encapsulate the read operation of VISA for easier operation.

```
bool CDSG3000_DEMO_VCDlg::InstrRead(CString strAddr, CString *pstrResult)
```

```
//Read from the instrument
```

```
{
```

```
ViSession defaultRM,instr;
```

```
ViStatus status;
```

```
ViUInt32 retCount;
```

```
char * SendAddr = NULL;
```

```
unsigned char RecBuf[MAX_REC_SIZE];
```

```
bool bReadOK = false;
```

```
CString str;
```

```
//Change the address's data style from CString to char*
```

```
SendAddr = strAddr.GetBuffer(strAddr.GetLength());
```

```
strcpy(SendAddr,strAddr);
```

```
strAddr.ReleaseBuffer();
```

```
memset(RecBuf,0,MAX_REC_SIZE);
```

```
//open the VISA instrument
```

```
status = viOpenDefaultRM(&defaultRM);
```

```
if (status < VI_SUCCESS)
```

```
{
```

```
    // Error Initializing VISA...exiting
```

```
    AfxMessageBox("No VISA instrument was opened !");
```

```
    return false;
```

```
}
```

```
//open the instrument
```

```
status = viOpen(defaultRM, SendAddr, VI_NULL, VI_NULL, &instr);
```

```
//read from the instrument
```

```
status = viRead(instr, RecBuf, MAX_REC_SIZE, &retCount);
```

```
//close the instrument
```

```
status = viClose(instr);
```

```
status = viClose(defaultRM);
```

```
(*pstrResult).Format("%s",RecBuf);
```

```
return bReadOK;
```

```
}
```

7. Add the control message response codes.

- 1) Connect the instrument

```
void CDSG3000_DEMO_VCDlg::OnConnect()
```

```
{
```

```
    // TODO: Add your control notification handler code here
```

```
    ViStatus status;
```

```

ViSession defaultRM;
ViString expr = "?*";
ViPFindList findList = new unsigned long;
ViPUInt32 retcnt = new unsigned long;
ViChar instrDesc[1000];
CString strSrc = "";
CString strInstr = "";
unsigned long i = 0;
bool bFindDSG = false;

status = viOpenDefaultRM(&defaultRM);
if (status < VI_SUCCESS)
{
    // Error Initializing VISA...exiting
    MessageBox("No VISA instrument was opened ! ");
    return ;
}

memset(instrDesc,0,1000);

// Find resource
status = viFindRsrc(defaultRM,expr,findList, retcnt, instrDesc);

for (i = 0;i < (*retcnt);i++)
{
    // Get instrument name
    strSrc.Format("%s",instrDesc);
    InstrWrite(strSrc,"*IDN?");
    ::Sleep(200);
    InstrRead(strSrc,&strInstr);

    // If the instrument(resource) belongs to the DSG series then jump out from the loop
    strInstr.MakeUpper();
    if (strInstr.Find("DSG") >= 0)
    {
        bFindDSG = true;
        m_strInstrAddr = strSrc;
        break;
    }

    //Find next instrument
    status = viFindNext(*findList,instrDesc);
}

if (bFindDSG == false)
{
    MessageBox("Didn't find any DSG!");
}
UpdateData(false);
}

2) Write Operation
void CDSG3000_DEMO_VCDlg::OnSend()
{
    // TODO: Add your control notification handler code here
    UpdateData(true);
    if (m_strInstrAddr.IsEmpty())
    {

```

```
        MessageBox("Please connect to the instrument first!");
    }
    InstrWrite(m_strInstrAddr,m_strCommand);
    m_strResult.Empty();
    UpdateData(false);
}
```

3) Read Operation

```
void CDSG3000_DEMO_VCDlg::OnRead()
{
    // TODO: Add your control notification handler code here
    UpdateData(true);
    InstrRead(m_strInstrAddr,&m_strResult);
    UpdateData(false);
}
```

8. Execution Result

- 1) Click "Connect" to find and connect the RF signal generator. If the instrument is successfully connected, the corresponding USB VISA descriptor will be displayed in the address bar.
- 2) Input command in the "Command" edit box, for example, :SWE:DIR?.
- 3) Click "Send" to send the command;
- 4) Click "Read" to read the return value.

The execution result is as shown in the figure below.

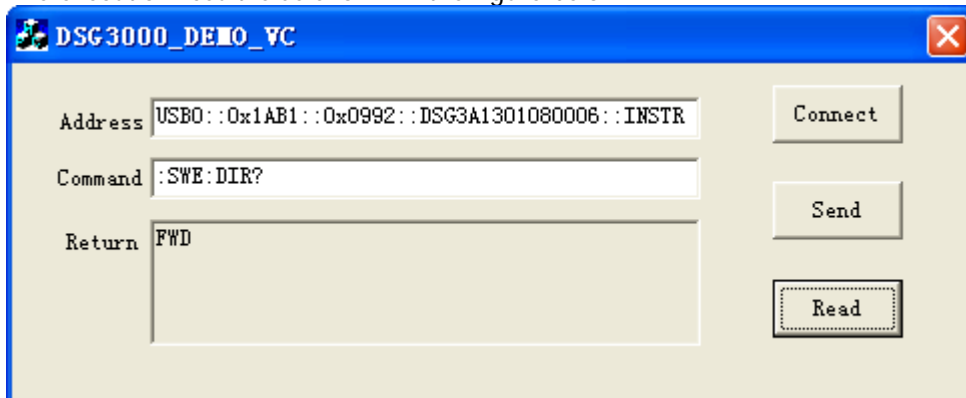

Chapter 5 Appendix

Appendix A: Command List

◆ [IEEE488.2 Common Commands](#)

[*CLS](#)

[*ESE](#)

[*ESR?](#)

[*IDN?](#)

[*OPT?](#)

[*PSC](#)

[*RST](#)

[*SRE](#)

[*STB?](#)

[*TRG](#)

[*WAI](#)

◆ [:MMEMory Commands](#)

[:MMEMory:CATalog](#)

[:MMEMory:CATalog:LENGth](#)

[:MMEMory:COPI](#)

[:MMEMory:DATA:IO](#)

[:MMEMory:DATA:IO:LIST](#)

[:MMEMory:DELeTe](#)

[:MMEMory:DISK:FORMat](#)

[:MMEMory:DISK:INFormation](#)

[:MMEMory:FILEtype](#)

[:MMEMory:LDISK:SPACe](#)

[:MMEMory:LOAD](#)

[:MMEMory:MDIRectory](#)

[:MMEMory:MOVE](#)

[:MMEMory:PNAME:EDIT](#)

[:MMEMory:PNAME:STATe](#)

[:MMEMory:SAVe](#)

◆ [:OUTPut Command](#)

[:OUTPut\[:STATe\]](#)

◆ [:SOURce Commands](#)

[\[:SOURce\]:AM Command Subsystem](#)

[\[:SOURce\]:AM:DEPTH](#)

[\[:SOURce\]:AM:DEPTH:STEP\[:INCRement\]](#)

[\[:SOURce\]:AM:FREQuency](#)
[\[:SOURce\]:AM:FREQuency:STEP\[:INCRement\]](#)
[\[:SOURce\]:AM:SOURce](#)
[\[:SOURce\]:AM:STATe](#)
[\[:SOURce\]:AM:WAVEform](#)

[\[:SOURce\]:CORRection Command Subsystem](#)
[\[:SOURce\]:CORRection:FLATness:COUNT](#)
[\[:SOURce\]:CORRection:FLATness:DELeTe](#)
[\[:SOURce\]:CORRection:FLATness:LIST](#)
[\[:SOURce\]:CORRection:FLATness:PAIR](#)
[\[:SOURce\]:CORRection:FLATness\[:STATe\]](#)

[\[:SOURce\]:FM Command Subsystem](#)
[\[:SOURce\]:FM:DEVIation](#)
[\[:SOURce\]:FM:DEVIation:STEP\[:INCRement\]](#)
[\[:SOURce\]:FM:FREQuency](#)
[\[:SOURce\]:FM:FREQuency:STEP\[:INCRement\]](#)
[\[:SOURce\]:FM:SOURce](#)
[\[:SOURce\]:FM:STATe](#)
[\[:SOURce\]:FM:WAVEform](#)

[\[:SOURce\]:FM:TYPE](#)

[\[:SOURce\]:FREQuency Command Subsystem](#)
[\[:SOURce\]:FREQuency](#)
[\[:SOURce\]:FREQuency:OFFSet](#)
[\[:SOURce\]:FREQuency:OFFSet:STEP](#)
[\[:SOURce\]:FREQuency:STEP](#)

[\[:SOURce\]:INPut:TRIGger:SLOPe](#)

[\[:SOURce\]:IQ Command Subsystem](#)
[\[:SOURce\]:IQ:BASEout:LEVel](#)
[\[:SOURce\]:IQ:BASEout:LEVel:STEP](#)
[\[:SOURce\]:IQ:BASEout:STATe](#)
[\[:SOURce\]:IQ:MODE](#)
[\[:SOURce\]:IQ:MODE:STATe](#)
[\[:SOURce\]:IQ:SAMPlE](#)
[\[:SOURce\]:IQ:SAMPlE:STEP](#)
[\[:SOURce\]:IQ:TRIGger:ARB](#)
[\[:SOURce\]:IQ:TRIGger:DELay](#)
[\[:SOURce\]:IQ:TRIGger:DELay:STEP](#)
[\[:SOURce\]:IQ:TRIGger:DURation](#)
[\[:SOURce\]:IQ:TRIGger:DURation:STEP](#)

[\[:SOURce\]:IQ:TRIGger:INHibit](#)
[\[:SOURce\]:IQ:TRIGger:INHibit:STEP](#)
[\[:SOURce\]:IQ:TRIGger:MODE](#)
[\[:SOURce\]:IQ:TRIGger:OPTMode](#)
[\[:SOURce\]:LEVel Command Subsystem](#)
[\[:SOURce\]:LEVel](#)
[\[:SOURce\]:LEVel:ALC:MODE](#)
[\[:SOURce\]:LEVel:ATTenuation](#)
[\[:SOURce\]:LEVel:ATTenuation:MODE](#)
[\[:SOURce\]:LEVel:ATTenuation:STEP](#)
[\[:SOURce\]:LEVel:LIMit](#)
[\[:SOURce\]:LEVel:LIMit:STEP](#)
[\[:SOURce\]:LEVel:OFFSet](#)
[\[:SOURce\]:LEVel:OFFSet:STEP](#)
[\[:SOURce\]:LEVel:SH:ACTIve](#)
[\[:SOURce\]:LEVel:SH:MODE](#)
[\[:SOURce\]:LEVel:STEP](#)
[\[:SOURce\]:LFOutput Command Subsystem](#)
[\[:SOURce\]:LFOutput:FREQuency](#)
[\[:SOURce\]:LFOutput:LEVel](#)
[\[:SOURce\]:LFOutput:SHAPE](#)
[\[:SOURce\]:LFOutput\[:STATe\]](#)
[\[:SOURce\]:LFOutput:SWEPtsine:DWELL](#)
[\[:SOURce\]:LFOutput:SWEPtsine:DWELL:STEP](#)
[\[:SOURce\]:LFOutput:SWEPtsine:FREQuency:STARt](#)
[\[:SOURce\]:LFOutput:SWEPtsine:FREQuency:STARt:STEP](#)
[\[:SOURce\]:LFOutput:SWEPtsine:FREQuency:STOP](#)
[\[:SOURce\]:LFOutput:SWEPtsine:FREQuency:STOP:STEP](#)
[\[:SOURce\]:LFOutput:SWEPtsine:LEVel](#)
[\[:SOURce\]:LFOutput:SWEPtsine:LEVel:STEP](#)
[\[:SOURce\]:LFOutput:SWEPtsine:MODE](#)
[\[:SOURce\]:LFOutput:SWEPtsine:SHAPE](#)
[\[:SOURce\]:LFOutput:SWEPtsine:SINGLE](#)
[\[:SOURce\]:LFOutput:SWEPtsine:TRIGger](#)
[\[:SOURce\]:LFOutput:SWEPtsine:XPOLar](#)
[\[:SOURce\]:MODulation:STATe](#)
[\[:SOURce\]:PHASe Command Subsystem](#)
[\[:SOURce\]:PHASe](#)
[\[:SOURce\]:PHASe:RESet](#)

[\[:SOURce\]:PHASe:STEP\[:INCRement\]](#)

[\[:SOURce\]:PM Command Subsystem](#)

- [\[:SOURce\]:PM:DEViation](#)
- [\[:SOURce\]:PM:DEViation:STEP\[:INCRement\]](#)
- [\[:SOURce\]:PM:FREQuency](#)
- [\[:SOURce\]:PM:FREQuency:STEP\[:INCRement\]](#)
- [\[:SOURce\]:PM:SOURce\[:SOURce\]:PM:STATe](#)
- [\[:SOURce\]:PM:WAVEform](#)

[\[:SOURce\]:PULM Command Subsystem](#)

- [\[:SOURce\]:PULM:DELay](#)
- [\[:SOURce\]:PULM:DELay:STEP](#)
- [\[:SOURce\]:PULM:DWIDth](#)
- [\[:SOURce\]:PULM:DWIDth:STEP](#)
- [\[:SOURce\]:PULM:MODE](#)
- [\[:SOURce\]:PULM:OUT:STATe](#)
- [\[:SOURce\]:PULM:PERiod](#)
- [\[:SOURce\]:PULM:PERiod:STEP](#)
- [\[:SOURce\]:PULM:POLarity](#)
- [\[:SOURce\]:PULM:SOURce](#)
- [\[:SOURce\]:PULM:STATe](#)
- [\[:SOURce\]:PULM:TRAI:n:LIST:COUNT](#)
- [\[:SOURce\]:PULM:TRAI:n:LIST:DELete](#)
- [\[:SOURce\]:PULM:TRAI:n:LIST:GET](#)
- [\[:SOURce\]:PULM:TRAI:n:LIST:INSERt](#)
- [\[:SOURce\]:PULM:TRAI:n:LIST:RUN](#)
- [\[:SOURce\]:PULM:TRIGger:DELay](#)
- [\[:SOURce\]:PULM:TRIGger:DELay:STEP](#)
- [\[:SOURce\]:PULM:TRIGger:EXTernal:GATE:POLarity](#)
- [\[:SOURce\]:PULM:TRIGger:EXTernal:SLOPe](#)
- [\[:SOURce\]:PULM:TRIGger:MODE](#)
- [\[:SOURce\]:PULM:WIDTh](#)
- [\[:SOURce\]:PULM:WIDTh:STEP](#)

[\[:SOURce\]:SWEep Command Subsystem](#)

- [\[:SOURce\]:SWEep:DIRection](#)
- [\[:SOURce\]:SWEep:EXECute](#)
- [\[:SOURce\]:SWEep:LIST:ADDList](#)
- [\[:SOURce\]:SWEep:LIST:CPOint](#)
- [\[:SOURce\]:SWEep:LIST:DELete](#)
- [\[:SOURce\]:SWEep:LIST:INITialize:FSep](#)

[\[:SOURce\]:SWEep:LIST:INITialize:PRESet](#)
[\[:SOURce\]:SWEep:LIST:LIST](#)
[\[:SOURce\]:SWEep:MODE](#)
[\[:SOURce\]:SWEep:POINt:TRIGger:TYPE](#)
[\[:SOURce\]:SWEep:RESet\[:ALL\]](#)
[\[:SOURce\]:SWEep:STATe](#)
[\[:SOURce\]:SWEep:STEP:DWELl](#)
[\[:SOURce\]:SWEep:STEP:DWELl:STEP](#)
[\[:SOURce\]:SWEep:STEP:POINts](#)
[\[:SOURce\]:SWEep:STEP:POINts:STEP](#)
[\[:SOURce\]:SWEep:STEP:SHAPE](#)
[\[:SOURce\]:SWEep:STEP:SPACing](#)
[\[:SOURce\]:SWEep:STEP:STARt:FREQuency](#)
[\[:SOURce\]:SWEep:STEP:STARt:FREQuency:STEP](#)
[\[:SOURce\]:SWEep:STEP:STARt:LEVel](#)
[\[:SOURce\]:SWEep:STEP:STARt:LEVel:STEP](#)
[\[:SOURce\]:SWEep:STEP:STOP:FREQuency](#)
[\[:SOURce\]:SWEep:STEP:STOP:FREQuency:STEP](#)
[\[:SOURce\]:SWEep:STEP:STOP:LEVel](#)
[\[:SOURce\]:SWEep:STEP:STOP:LEVel:STEP](#)
[\[:SOURce\]:SWEep:SWEep:TRIGger:TYPE](#)
[\[:SOURce\]:SWEep:TYPE](#)

◆ [:STATus Commands](#)

[:STATus:OPERation:CONDition](#)
[:STATus:OPERation:ENABle](#)
[:STATus:OPERation\[:EVENT\]](#)
[:STATus:QUEStionable:CALibration:CONDition](#)
[:STATus:QUEStionable:CALibration:ENABle](#)
[:STATus:QUEStionable:CALibration\[:EVENT\]](#)
[:STATus:QUEStionable:CONDition](#)
[:STATus:QUEStionable:CONNect:CONDition](#)
[:STATus:QUEStionable:CONNect:ENABle](#)
[:STATus:QUEStionable:CONNect\[:EVENT\]](#)
[:STATus:QUEStionable:ENABle](#)
[:STATus:QUEStionable\[:EVENT\]](#)
[:STATus:QUEStionable:FREQuency:CONDition](#)
[:STATus:QUEStionable:FREQuency:ENABle](#)
[:STATus:QUEStionable:FREQuency\[:EVENT\]](#)
[:STATus:QUEStionable:MODulation:CONDition](#)

[:STATus:QUEStionable:MODulation:ENABle](#)
[:STATus:QUEStionable:MODulation\[:EVENT\]](#)
[:STATus:QUEStionable:POWer:CONDition](#)
[:STATus:QUEStionable:POWer:ENABle](#)
[:STATus:QUEStionable:POWer\[:EVENT\]](#)
[:STATus:QUEStionable:SELFtest:CONDition](#)
[:STATus:QUEStionable:SELFtest:ENABle](#)
[:STATus:QUEStionable:SELFtest\[:EVENT\]](#)
[:STATus:QUEStionable:TEMP:CONDition](#)
[:STATus:QUEStionable:TEMP:ENABle](#)
[:STATus:QUEStionable:TEMP\[:EVENT\]](#)

◆ [:SYSTem Commands](#)

[:SYSTem:BRIGHtness](#)
[:SYSTem:CLEAr](#)
[:SYSTem:COMMunication:GPIB\[:SELF\]:ADDRes](#)
[:SYSTem:COMMunication:INTerface](#)
[:SYSTem:COMMunication:LAN:DHCP](#)
[:SYSTem:COMMunication:LAN:IP:ADDRes](#)
[:SYSTem:COMMunication:LAN:IP:AUTO](#)
[:SYSTem:COMMunication:LAN:IP:GATeway](#)
[:SYSTem:COMMunication:LAN:IP:MANual](#)
[:SYSTem:COMMunication:LAN:IP:SET](#)
[:SYSTem:COMMunication:LAN:IP:SUBnet:MASK](#)
[:SYSTem:COMMunication:LAN:RESet](#)
[:SYSTem:COMMunication:LAN\[:SELF\]:PREFerred](#)
[:SYSTem:DATE](#)
[:SYSTem:DISPlay:UPDate\[:STATe\]](#)
[:SYSTem:FSWitch:STATe](#)
[:SYSTem:LANGuage](#)
[:SYSTem:LKEY](#)
[:SYSTem:POWer:ON:TYPE](#)
[:SYSTem:PRESet](#)
[:SYSTem:PRESet:TYPE](#)
[:SYSTem:PRESet:SAVE](#)
[:SYSTem:TIME](#)

◆ [:TRIGger Commands](#)

[:TRIGger:IO\[:IMMEDIATE\]](#)
[:TRIGger:LFOutput\[:IMMEDIATE\]](#)
[:TRIGger:PULSe\[:IMMEDIATE\]](#)

- [:TRIGger\[:SWEep\]\[:IMMediate\]](#)
- ◆ [:UNIT Command](#)
 - [:UNIT:POWer](#)

Appendix B: Factory Setting

Parameter	Factory Setting	
FREQ		
	DSG3060	DSG3030
Frequency	6GHz	3GHz
Frequency Offset	0Hz	
Phase Offset	0deg	
LEVEL		
Amplitude	-140dBm	
Amplitude Limit	25dBm	
Amplitude Offset	0dB	
Attenuation Mode	Auto	
Attenuation	125dB	
ALC Status	Auto	
Current Frequency in the Flatness List	6GHz	3GHz
Current Amplitude in the Flatness List	0dBm	
Current Row in the Flatness List	1	
Level Unit	dBm	
SWEEP		
Sweep	Off	
Sweep Type	Step	
Sweep Mode	Cont	
Start Frequency of Step Sweep	1GHz	
Stop Frequency of Step Sweep	2GHz	
Start Level of Step Sweep	-10dBm	
Stop Level of Step Sweep	-20dBm	
Sweep Points	11	
Dwell Time	500ms	
Sweep Spacing	Lin	
Sweep Shape	Triangle	
Current Frequency in the Sweep List	6GHz	3GHz
Current Amplitude in the Sweep List	-140dBm	
Current Time in the Sweep List	500ms	
Current Row in the Sweep List	1	
Trigger Mode of the Sweep Period	Auto	
Trigger Mode of Each Sweep Point	Auto	
External Trigger Slope	Pos	
Sweep Direction	Fwd	
AM		
Switch	Off	
Modulation Source	Int	
Modulation Depth	50%	
Modulation Frequency	10kHz	
Modulation Waveform	Sine	
FM/ΦM		
Modulation Type	ΦM	
FM		
Switch	Off	
Modulation Source	Int	
Frequency Deviation	10kHz	
Modulation Rate	10kHz	

Modulation Waveform	Sine
ΦM	
Switch	Off
Modulation Source	Int
Phase Offset	6.28rad
Modulation Rate	10kHz
Modulation Waveform	Sine
Pulse Mod.	
Switch	Off
Modulation Source	Int
Pulse Mode	Single
Period	1ms
Pulse Width	500us
Delay	600us
#2 Pulse Width	200us
Trigger Mode	Auto
Pulse Output	Off
Trigger Delay	100us
Modulation Polarity	Normal
External Gated Polarity	Normal
External Trigger Slope	Pos
Current On Time in the Pulse List	500us
Current in Off Time in the Pulse List	500us
Current Repetition Times in the Pulse List	1
Current Row in the Pulse List	1
IQ Mod.	
Switch	Off
Source	Int
Baseband Switch	Off
Baseband Level	1 V
Sample Rate	1 MHz
Trigger Mode	Auto
Operation Mode	Retrig
Duration	1
External Delay	0
External Inhibit	0
LF	
Output Waveform	Sine
Output Level	1V
Output Frequency	10kHz
Start Frequency of Sweep-Sine	10kHz
Stop Frequency of Sweep-Sine	100kHz
Level of Sweep-Sine	1V
Sweep Time	1s
Sweep Mode	Cont
Sweep Shape	Triangle
Trigger Mode	Auto
External Trigger Slope	Pos
Output Level of Square	1V
Output Frequency of Square	10kHz
Output Level of Triangle Waveform	1V
Output Frequency of Triangle waveform	10kHz
Output Level of Ramp Waveform	1V
Output Frequency of Ramp Waveform	10kHz

Output Control	
RF Switch	Off
MOD Switch	Off
LF Switch	Off
System^[5]	
Language	English
Power-on Setting	Preset
Preset Type	Factory
Remote Interface	Off
DHCP	On
Auto IP	On
Manual IP	Off
GPIB Address	7
Screen Switch	On
Brightness	3
Power Status	Open
Storage^[6]	
File Type	All
Input Method	Number
Prefix State	Off

Note^[5,6]: Not affected by the preset setting.

Appendix C: Warranty

RIGOL warrants that its products mainframe and accessories will be free from defects in materials and workmanship within the warranty period.

If a product is proven to be defective within the respective period, **RIGOL** guarantees the free replacement or repair of products which are approved defective. To get repair service, please contact with your nearest **RIGOL** sales or service office.

RIGOL does not provide other warranty items except the one being provided by this warranty statement. The warranty items include but not being subjected to the hint guarantee items related to tradable characteristic and any particular purpose. **RIGOL** will not take any responsibility in cases regarding to indirect, particular and ensuing damage.