

RIGOL

Quick Guide

**DSG3000 Series RF Signal
Generator**

**May 2015
RIGOL Technologies, Inc.**

Guaranty and Declaration

Copyright

© 2013 RIGOL Technologies, Inc. All Rights Reserved.

Trademark Information

RIGOL is a registered trademark of RIGOL Technologies, Inc.

Publication Number

QGG01104-1110

Notices

- **RIGOL** products are covered by P.R.C. and foreign patents, issued and pending.
- **RIGOL** reserves the right to modify or change parts of or all the specifications and pricing policies at company's sole decision.
- Information in this publication replaces all previously corresponding material.
- Information in this publication is subject to change without notice.
- **RIGOL** shall not be liable for either incidental or consequential losses in connection with the furnishing, use or performance of this manual as well as any information contained.
- Any part of this document is forbidden to be copied, photocopied or rearranged without prior written approval of **RIGOL**.

Product Certification

RIGOL guarantees this product conforms to the national and industrial standards in China as well as the ISO9001:2008 standard and the ISO14001:2004 standard. Other international standard conformance certification is in progress.

Contact Us

If you have any problem or requirement when using our products or this manual, please contact **RIGOL**.

E-mail: service@rigol.com

Website: www.rigol.com

Safety Requirement

General Safety Summary

Please review the following safety precautions carefully before putting the instrument into operation so as to avoid any personal injury or damage to the instrument and any product connected to it. To prevent potential hazards, please use the instrument only specified by this manual.

Use Proper Power Cord.

Only the power cord designed for the instrument and authorized for use within the local country could be used.

Ground the Instrument.

The instrument is grounded through the Protective Earth lead of the power cord. To avoid electric shock, it is essential to connect the earth terminal of the power cord to the Protective Earth terminal before connecting any inputs or outputs.

Connect the Probe Correctly.

If a probe is used, do not connect the ground lead to high voltage since it has isobaric electric potential as the ground.

Observe All Terminal Ratings.

To avoid fire or shock hazard, observe all ratings and markers on the instrument and check your manual for more information about ratings before connecting the instrument.

Use Proper Overvoltage Protection.

Make sure that no overvoltage (such as that caused by a thunderstorm) can reach the product, or else the operator might be exposed to the danger of electrical shock.

Do Not Operate Without Covers.

Do not operate the instrument with covers or panels removed.

Do Not Insert Anything Into the Holes of Fan.

Do not insert anything into the holes of the fan to avoid damaging the instrument.

Use Proper Fuse.

Please use the specified fuses.

Avoid Circuit or Wire Exposure.

Do not touch exposed junctions and components when the unit is powered.

Do Not Operate With Suspected Failures.

If you suspect damage occurs to the instrument, have it inspected by **RIGOL** authorized personnel before further operations. Any maintenance, adjustment or replacement especially to circuits or accessories must be performed by **RIGOL** authorized personnel.

Keep Well Ventilation.

Inadequate ventilation may cause an increase of instrument temperature which would cause damage to the instrument. So please keep the instrument well ventilated and inspect the intake and fan regularly.

Do Not Operate in Wet Conditions.

In order to avoid short circuiting to the interior of the device or electric shock, please do not operate the instrument in a humid environment.

Do Not Operate in an Explosive Atmosphere.

In order to avoid damage to the device or personal injuries, it is important to operate the device away from an explosive atmosphere.

Keep Product Surfaces Clean and Dry.

To avoid the influence of dust and/or moisture in the air, please keep the surface of the device clean and dry.

Electrostatic Prevention.

Operate the instrument in an electrostatic discharge protective environment to avoid damage induced by static discharges. Always ground both the internal and external conductors of cables to release static before making connections.

Proper Use of Battery.

If a battery is supplied, it must not be exposed to high temperature or in contact with fire. Keep it out of the reach of children. Improper change of battery (note: lithium battery) may cause explosion. Use **RIGOL** specified battery only.

Handling Safety.

Please handle with care during transportation to avoid damage to keys, knob interfaces and other parts on the panels.

Safety Terms and Symbols

Terms Used in this Manual. These terms may appear in this manual:



WARNING

Warning statements indicate conditions or practices that could result in injury or loss of life.



CAUTION

Caution statements indicate conditions or practices that could result in damage to this product or other property.

Terms Used on the Product. These terms may appear on the product:

DANGER It calls attention to an operation, if not correctly performed, could result in injury or hazard immediately.

WARNING It calls attention to an operation, if not correctly performed, could result in potential injury or hazard.

CAUTION It calls attention to an operation, if not correctly performed, could result in damage to the product or other devices connected to the product.

Symbols Used on the Product. These symbols may appear on the product:



Hazardous Voltage



Safety Warning



Protective Earth Terminal



Chassis Ground



Test Ground

Allgemeine Sicherheits Informationen

Überprüfen Sie die folgenden Sicherheitshinweise sorgfältig um Personenschäden oder Schäden am Gerät und an damit verbundenen weiteren Geräten zu vermeiden. Zur Vermeidung von Gefahren, nutzen Sie bitte das Gerät nur so, wie in diesem Handbuch angegeben.

Um Feuer oder Verletzungen zu vermeiden, verwenden Sie ein ordnungsgemäßes Netzkabel.

Verwenden Sie für dieses Gerät nur das für ihr Land zugelassene und genehmigte Netzkabel.

Erden des Gerätes.

Das Gerät ist durch den Schutzleiter im Netzkabel geerdet. Um Gefahren durch elektrischen Schlag zu vermeiden, ist es unerlässlich, die Erdung durchzuführen. Erst dann dürfen weitere Ein- oder Ausgänge verbunden werden.

Anschluss eines Tastkopfes.

Die Erdungsklemmen der Sonden sind auf dem gleichen Spannungspegel des Instruments geerdet. Schließen Sie die Erdungsklemmen an keine hohe Spannung an.

Beachten Sie alle Anschlüsse.

Zur Vermeidung von Feuer oder Stromschlag, beachten Sie alle Bemerkungen und Markierungen auf dem Instrument. Befolgen Sie die Bedienungsanleitung für weitere Informationen, bevor Sie weitere Anschlüsse an das Instrument legen.

Verwenden Sie einen geeigneten Überspannungsschutz.

Stellen Sie sicher, daß keinerlei Überspannung (wie z.B. durch Gewitter verursacht) das Gerät erreichen kann. Andernfalls besteht für den Anwender die Gefahr eines Stromschlages.

Nicht ohne Abdeckung einschalten.

Betreiben Sie das Gerät nicht mit entfernten Gehäuse-Abdeckungen.

Betreiben Sie das Gerät nicht geöffnet.

Der Betrieb mit offenen oder entfernten Gehäuseteilen ist nicht zulässig. Nichts in entsprechende Öffnungen stecken (Lüfter z.B.)

Passende Sicherung verwenden.

Setzen Sie nur die spezifikationsgemäßen Sicherungen ein.

Vermeiden Sie ungeschützte Verbindungen.

Berühren Sie keine unisolierten Verbindungen oder Baugruppen, während das Gerät in Betrieb ist.

Betreiben Sie das Gerät nicht im Fehlerfall.

Wenn Sie am Gerät einen Defekt vermuten, sorgen Sie dafür, bevor Sie das Gerät wieder betreiben, dass eine Untersuchung durch **RIGOL** autorisiertem Personal durchgeführt wird. Jedwede Wartung, Einstellarbeiten oder Austausch von Teilen am Gerät, sowie am Zubehör dürfen nur von **RIGOL** autorisiertem Personal durchgeführt werden.

Belüftung sicherstellen.

Unzureichende Belüftung kann zu Temperaturanstiegen und somit zu thermischen Schäden am Gerät führen. Stellen Sie deswegen die Belüftung sicher und kontrollieren regelmäßig Lüfter und Belüftungsöffnungen.

Nicht in feuchter Umgebung betreiben.

Zur Vermeidung von Kurzschluß im Geräteinneren und Stromschlag betreiben Sie das Gerät bitte niemals in feuchter Umgebung.

Nicht in explosiver Atmosphäre betreiben.

Zur Vermeidung von Personen- und Sachschäden ist es unumgänglich, das Gerät ausschließlich fernab jedweder explosiven Atmosphäre zu betreiben.

Geräteoberflächen sauber und trocken halten.

Um den Einfluß von Staub und Feuchtigkeit aus der Luft auszuschließen, halten Sie bitte die Geräteoberflächen sauber und trocken.

Schutz gegen elektrostatische Entladung (ESD).

Sorgen Sie für eine elektrostatisch geschützte Umgebung, um somit Schäden und Funktionsstörungen durch ESD zu vermeiden. Erden Sie vor dem Anschluß immer Innen- und Außenleiter der Verbindungsleitung, um statische Aufladung zu entladen.

Die richtige Verwendung des Akku.

Wenn eine Batterie verwendet wird, vermeiden Sie hohe Temperaturen bzw. Feuer ausgesetzt werden. Bewahren Sie es außerhalb der Reichweite von Kindern auf. Unsachgemäße Änderung der Batterie (Anmerkung: Lithium-Batterie) kann zu einer Explosion führen. Verwenden Sie nur von **RIGOL** angegebene Akkus.

Sicherer Transport.

Transportieren Sie das Gerät sorgfältig (Verpackung!), um Schäden an Bedienelementen, Anschlüssen und anderen Teilen zu vermeiden.

Sicherheits Begriffe und Symbole

Begriffe in diesem Guide. Diese Begriffe können in diesem Handbuch auftauchen:



WARNING

Die Kennzeichnung WARNING beschreibt Gefahrenquellen die leibliche Schäden oder den Tod von Personen zur Folge haben können.



CAUTION

Die Kennzeichnung Caution (Vorsicht) beschreibt Gefahrenquellen die Schäden am Gerät hervorrufen können.

Begriffe auf dem Produkt. Diese Bedingungen können auf dem Produkt erscheinen:

- DANGER** weist auf eine Verletzung oder Gefährdung hin, die sofort geschehen kann.
- WARNING** weist auf eine Verletzung oder Gefährdung hin, die möglicherweise nicht sofort geschehen.
- CAUTION** weist auf eine Verletzung oder Gefährdung hin und bedeutet, dass eine mögliche Beschädigung des Instruments oder anderer Gegenstände auftreten kann.

Symbole auf dem Produkt. Diese Symbole können auf dem Produkt erscheinen:



Gefährliche
Spannung



Sicherheits-
Hinweis



Schutz-erde



Gehäusemasse



Erde

General Care and Cleaning

General Care

Do not store or leave the instrument where it may be exposed to direct sunlight for long periods of time.

Cleaning

Clean the instrument regularly according to its operating conditions. To clean the exterior surface, perform the following steps:

1. Disconnect the instrument from all power sources.
2. Clean the loose dust on the outside of the instrument with a lint-free cloth (with a mild detergent or water). When cleaning the LCD, take care to avoid scarifying it.



CAUTION

To avoid damage to the instrument, do not expose it to caustic liquids.



WARNING

To avoid short-circuit and personal injury resulting from moisture, make sure the instrument is completely dry before reconnecting it to power supply.

Environmental Considerations

The following symbol indicates that this product complies with the WEEE Directive 2002/96/EC.



Product End-of-Life Handling

The equipment may contain substances that could be harmful to the environment or human health. In order to avoid release of such substances into the environment and harm to human health, we encourage you to recycle this product in an appropriate system that will ensure that most of the materials are reused or recycled appropriately. Please contact your local authorities for disposal or recycling information.

Document Overview

Format Conventions in this Manual

1. Key:

The key at the front panel is denoted by the format of "Text Box + Key Name (Bold)" in the manual, for example, **FREQ** denotes the **FREQ** key.

2. Menu:

The menu is denoted by the format of "Character Shading + Menu Word (Bold)" in the manual, for example, **Frequency** denotes the frequency item under **FREQ**.

3. Connector:

The connector at the front or rear panel is denoted by the format of "Square Brackets + Connector Name (Bold)" in the manual, for example, **[RF OUTPUT 50Ω]**.

4. Operation Steps:

The next step of the operation is denoted by an arrow "→" in the manual. For example, **FREQ** → **Frequency** denotes pressing **FREQ** at the front panel and then pressing **Frequency**.

Content Conventions in this Manual

DSG3000 series RF signal generator includes DSG3030 and DSG3060. In this manual, DSG3060 is taken as an example to illustrate the basic operations of the signal generator. For more details, please refer to *DSG3000 Series RF Signal Generator User's Guide*.

Manuals of this Product

The manuals of this product mainly include the quick guide, user's guide, programming guide and data sheet. For the newest version of the desired manual, download it from www.rigol.com.

Contents

Guaranty and Declaration	I
Safety Requirement	II
General Safety Summary	II
Safety Terms and Symbols	IV
Allgemeine Sicherheits Informationen	V
Sicherheits Begriffe und Symbole	VII
General Care and Cleaning.....	VIII
Environmental Considerations	VIII
Document Overview	IX
Quick Start	1
General Inspection.....	1
Front Panel Overview	2
Rear Panel Overview	9
To Use DSG3000 for the First Time	13
To Connect to Power.....	13
Power-on Inspection.....	14
To Set the System Language	14
To Replace the Fuse.....	15
User Interface	16
Normal Display Mode.....	16
Parameter Zoom-in Mode.....	19
To Use the Built-in Help System.....	19
Basic Operations	21
To Output RF Signal	21
To Output RF Sweep Signal.....	22
To Output RF Modulated Signal	24
Remote Control	26
Troubleshooting	28

Quick Start

General Inspection

1. **Inspect the shipping container for damage**

Keep the damaged shipping container or cushioning material until the contents of the shipment have been checked for completeness and the instrument has passed both electrical and mechanical tests.

The consigner or carrier shall be liable for the damage to instrument resulting from shipment. **RIGOL** would not be responsible for free maintenance/rework or replacement of the unit.

2. **Inspect the instrument**

In case of any damage, or defect, or failure, notify your **RIGOL** sales representative.

3. **Check the accessories**

Please check the accessories according to the packing lists. If the accessories are incomplete or damaged, please contact your **RIGOL** sales representative.

Front Panel Overview

The front panel of DSG3000 series RF signal generator is as shown in the figure below.

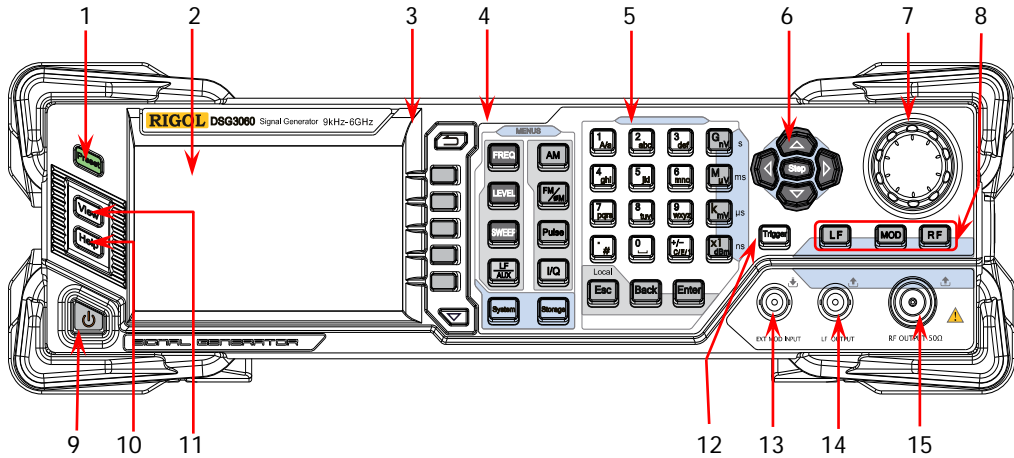

Figure 1 Front Panel

1. Restore to Preset Key



Restore the instrument to the preset state (factory state or user-stored state).

2. LCD

4.3 inch TFT high-resolution (480×272) color LCD. The current settings and state of the instrument can be clearly displayed. For the detailed information, refer to “**User Interface**”.

3. Menu Control Keys



Quit the current menu and return to the previous menu.



Menu softkeys. Correspond to the menus at the left and pressing the softkey will activate the corresponding menu.



Menu page up/down key.

4. Function Keys



Set the frequency, frequency offset and phase of the RF output signal.



Set the amplitude and attenuation of the RF output signal and provide the flatness calibration function.



Set the sweep type, sweep manner and sweep mode.



Set the parameters relating to amplitude modulation (AM).



Set the parameters relating to frequency modulation (FM) and phase modulation (PM).



Set the parameters relating to pulse modulation.



Set the parameters relating to I/Q modulation.



Set the parameters relating to LF output, the instrument options and other extended functions.



Store and recall the instrument state, flatness calibration data, sweep list and so on.



Set the system-related parameters.

5. Numeric Keyboard

The numeric keyboard supports Chinese characters, English uppercase/lowercase characters, numbers and commonly used symbols (include the decimal point, #, space and positive/negative sign +/-). It is mainly used to edit the file or folder name or set parameters.

The multiplexing key of number and letter is used to directly input the desired number or letter.



Used to switch among Chinese, English and number input modes.

When setting parameters, the input mode is fixed at number and this key is used to input the sign ("+" or "-") of the value.



In number input mode, press this key to input 1.

In English input mode, press this key to switch between uppercase and lowercase letter inputs.



The multiplexing key of 0 and space.

In number input mode, press this key to input 0.

In Chinese or English input mode, press this key to input a space.



In number input mode, press this key to insert a decimal point at the current cursor.

In English input mode, press this key to input "#".

In Chinese input mode, this key is invalid.

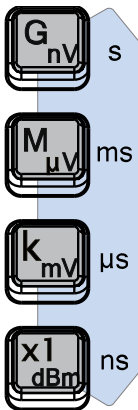

Used to set the unit of the parameter.

When setting a parameter, after inputting the numbers using the numeric keyboard, press any of the keys to select the corresponding unit. The unit selected is related to the type of the parameter to be set.

Parameter	G_{nV}	M_{μV}	K_{mV}	X1_{dBm}
Frequency	GHz	MHz	kHz	Hz
Amplitude	nV	μV	mV	dBm
Period	s	ms	μs	ns

Local



When setting parameters, use this key to clear the number in the active function area and exit the parameter input state.

When editing filenames, use this key to clear the characters in the input bar.

During keyboard test, use this key to exit the current test state.

When the instrument is in remote mode, use this key to return to local mode.



When setting parameters, use this key to delete the number at the left of the cursor.

When editing filenames, use this key to delete the character at the left of the cursor.

For the storage function, it is used to fold the directory currently selected.



When setting parameters, use this key to finish the parameter input and add the default unit for the parameter.

When editing filenames, use this key to input the character currently selected by the cursor.

For the storage function, it is used to unfold the directory currently selected.

6. Direction Keys/Step Key



When setting parameters, **Step** is used to set the step of the parameter currently selected.

The left/right direction key is used to enter the parameter editing state and move the cursor to the specified digit.

The up/down direction key is used to modify the value at the cursor or modify the parameter value at the current step.

For the storage function, the left/right direction key is used to fold or unfold the directory currently selected.

The up/down direction key is used to select the current directory or file.

When editing filenames, they are used to select the desired character.

7. Knob

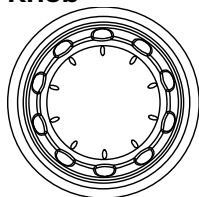

When setting parameters, it is used to modify the value at the cursor or modify the parameter value at the current step.

When editing filenames, it is used to select the desired character.

For the storage function, it is used to select the current directory or file.

8. Output Control Keys



Used to turn on or off the LF output.

- Press this key, the backlight goes on and the LF label is displayed in the status bar in the user interface. The LF output is turned on. At this point, the **[LF OUTPUT]** connector outputs LF signal according to the current configuration.
- Press this key again, the backlight goes out and the LF output is turned off.



Used to turn on or off the RF output.

- Press this key, the backlight goes on and the RF label is displayed in the status bar in the user interface. The RF output is turned on. At this point, the **[RF OUTPUT 50Ω]** connector outputs RF signal according to the current configuration.
- Press this key again, the backlight goes out and the RF output is turned off.



Used to turn on or off the RF modulation output.

- Press this key, the backlight goes on and the MOD label is displayed in the status bar in the user interface. The RF modulation output is turned on. At this point, the **[RF OUTPUT 50Ω]** connector outputs modulated RF signal according to the current configuration (the backlight of **[RF]** must go on).
- Press this key again, the backlight goes out and the RF modulation output is turned off.

9. Power Key

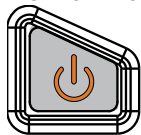

Turn on or off the signal generator. When this key is turned off, the signal generator is in standby state and it will be powered off only when the power switch at the rear panel is turned off and the power cord is removed.

Press **System** → **Power Status** to select "Open" or "Default". When "Default" is selected, after the instrument is powered on and the power switch at the rear panel is turned on, you need to press this key to start the instrument. When "Open" is selected, the instrument will start automatically after it is powered on and the power switch at the rear panel is turned on.

10. Built-in Help System



To get the help information of any front panel key or menu softkey, press this key and then press the desired key.

11. View Switch Key



It is used to switch the interface display mode to normal mode or parameter zoom-in mode.

12. Trigger Control Key



When the trigger type of **Sweep** is "Key", press this key once to trigger a sweep.

When the trigger mode of **Pulse** is "Key", press this key once to enable a pulse modulation.

13. External Modulation Input Connector

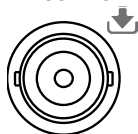

When the modulation source of AM, FM and ϕ M is external, this connector is used to input the external modulating signal.

EXT MOD INPUT

14. LF Output Connector

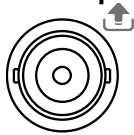

LF OUTPUT

When the backlight of **LF** goes on, this connector is used to output LF signal.

15. RF Output Connector

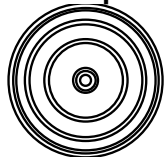

RF OUTPUT 50Ω



When the backlight of **RF** goes on, this connector is used to output RF signal and RF sweep signal.

When the backlights of **RF** and **MOD** go on, this connector is used to output RF modulated signal.



CAUTION

To avoid damage to the instrument, the reverse DC voltage on the RF output connector cannot exceed 50 V, the reverse power must be less than +10 dBm in 9 kHz~1 MHz frequency range and +30 dBm in 1 MHz~6 GHz frequency range.

Rear Panel Overview

The rear panel of DSG3000 series RF signal generator is as shown in the figure below.

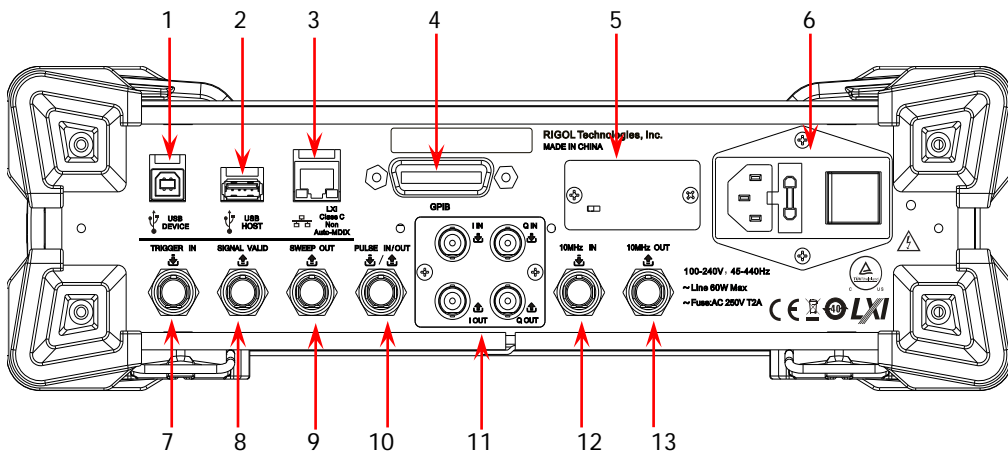
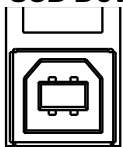

Figure 2 Rear Panel

1. USB Device



It is used to connect the PC to realize remote control.

2. USB Host



It is used to connect the USB storage device to update the system or store system state and sweep list. You can also connect the USB power sensor or RX1000.

3. LAN

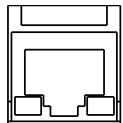

It is used to connect the PC or network to realize remote control.

4. GPIB



It is used to connect the PC to realize remote control.

5. OCXO (option)

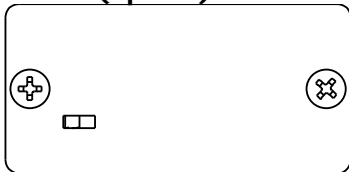

OCXO is oven controlled crystal oscillator and can provide frequency reference source with higher temperature stability.

Note: Forty minutes of warm-up is required for the OCXO to reach its rated frequency.

About the ordering information of the option, please refer to the data sheet.

6. Power Input Connector, Fuse and Switch

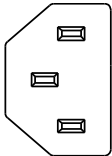

Power input connector.

The AC power supplies supported by this signal generator are 100-240 V, 45-440 Hz. The maximum input power of the instrument cannot exceed 60 W. When the signal generator is connected to AC power supply via this connector, the instrument selects the correct voltage range automatically and users do not need to select the voltage range manually.

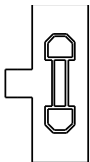

Fuse.

The fuse specification of this signal generator is AC 250 V, T2A. If the fuse needs to be replaced, please refer to **"To Replace the Fuse"**.

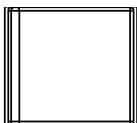

Power Switch

It is used to turn on or off the signal generator.

7. External Trigger Input Connector

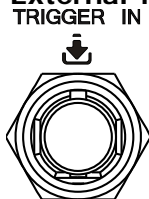

When the trigger mode of **Sweep** or "Swp-Sine" of LF output is "Ext", this connector is used to input the external trigger signal.

8. Signal Valid Output Connector

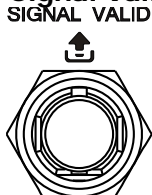

When the RF output frequency or amplitude is modified, after certain response and processing time, the internal circuit of the instrument outputs RF signal with the specified frequency and amplitude via the RF output connector at the front panel. During this process, the **[SIGNAL VALID]** connector outputs a pulse sync signal, indicating that the RF output signal is valid.

- High Level (3.3 V): indicate that the RF signal is in configuration;
- Low Level (0 V): indicate that the RF signal is stable (namely, the signal is valid).

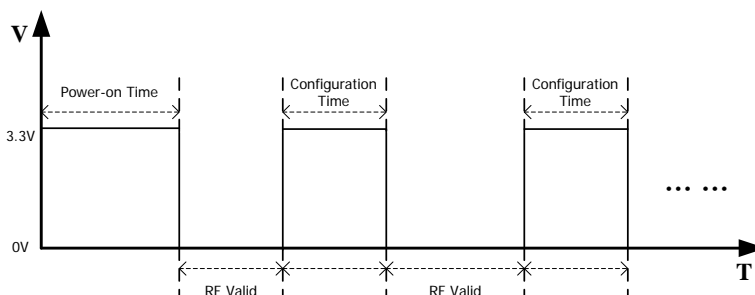

9. Sweep Output Connector

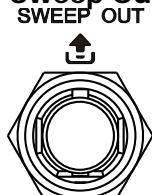

When the RF sweep function is enabled, the **[SWEEP OUT]** connector outputs a signal (0 V to +10 V) while the RF output connector at the front panel outputs the sweep signal according to the current setting. Each sweep corresponds to an output cycle.

- When the sweep type is step, this output signal is related to the sweep shape ("Triangle" or "Ramp") currently selected.
- When the sweep type is list, the default of this output signal is ramp.

10. Pulse Signal Input/Output Connector



The function of this connector is determined by the current working mode of the pulse modulation.

PULSE IN:

- When the modulation source of **Pulse** is external, this connector is used to input the external pulse signal.
- When the modulation source of **Pulse** is internal and the trigger mode is “Ext Trig”, this connector is used to input the external trigger signal.
- When the modulation source of **Pulse** is internal and the trigger mode is “Ext Gate”, this connector is used to input the external gated signal.

PULSE OUT:

When the modulation source of **Pulse** is internal and the switch of pulse output is “On”, this connector is used to output the pulse signal of the internal generator. This output signal is related to pulse mode (“Single”, “Double” or “Train”) currently selected.

11. I/Q Modulating Signal Input/Output Connectors (option)

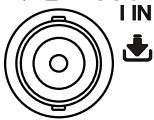

When I/Q modulation type is external, it is used to input the I (In-Phase) baseband signal of I/Q modulation.

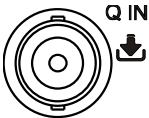

When I/Q modulation type is external, it is used to input the Q (Quadrature Phase) baseband signal of I/Q modulation.

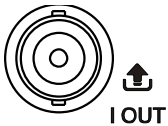

It is used to output the I (In-Phase) components of I/Q modulation of the built-in baseband generator.



It is used to output the Q (Quadrature Phase) components of I/Q modulation of the built-in baseband generator.

12. Reference Signal Input Connector

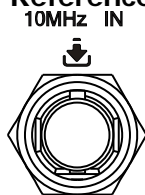

It is used to input the external 10 MHz reference clock signal which is usually used to realize the synchronization with other instruments. For more information about the external clock signal specification of this connector, please refer to the data sheet.

13. Reference Signal Output Connector

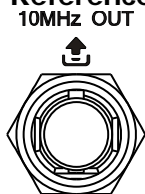

It is used to output the 10 MHz reference clock signal generated by the internal crystal oscillator of the instrument and usually used to realize the synchronization with other instruments. For more information about the output clock signal specification of this connector, please refer to the data sheet.

To Use DSG3000 for the First Time

To Connect to Power

Please connect the signal generator to AC power supply using the power cord supplied in the accessories as shown in the figure below. The AC power supplies supported by this signal generator are 100-240 V, 45-440 Hz. The maximum input power of the instrument cannot exceed 60 W. When the signal generator is connected to AC power supply via this connector, the instrument select the correct voltage range automatically and users do not need to select the voltage range manually.

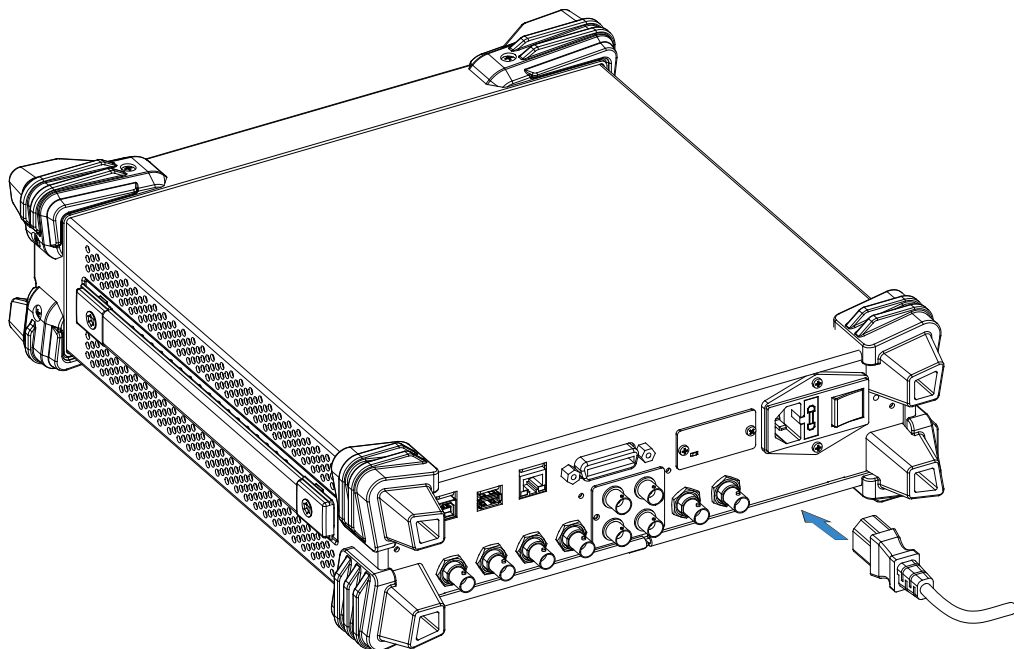



Figure 3 To Connect to Power

**CAUTION**

To avoid electric shock, make sure that the instrument is correctly grounded.

Power-on Inspection

After the power supply is correctly connected, press the power switch at the rear panel and the power key  at the front panel to turn on the signal generator. During the start-up, the instrument performs initialization and self-test. After that, the instrument enters the default interface.

To Set the System Language

DSG3000 series RF signal generator supports multiple system languages. You can press **System** → **Language** to switch the system language.

To Replace the Fuse

To replace the fuse, please use the specified fuse and follow the steps below.

1. Turn off the instrument, cut off the power supply and remove the power cord;
2. Use a small straight screwdriver to prize out the fuse seat;
3. Take out the fuse;
4. Replace the old fuse with a specified fuse;
5. Re-install the fuse seat.

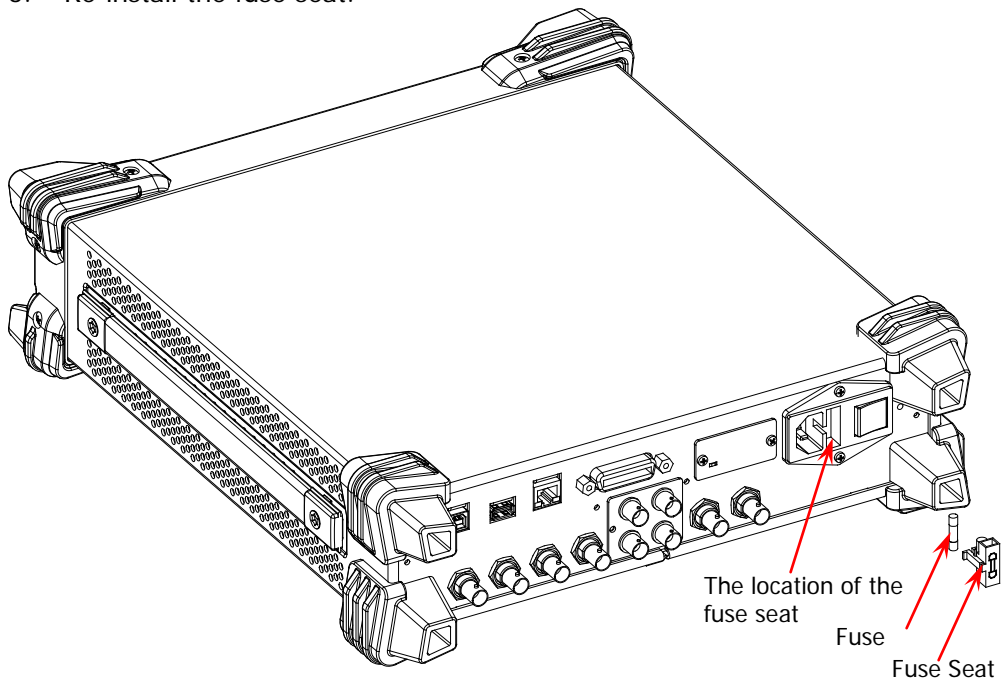

Figure 4 To Replace the Fuse



WARNING

To avoid electric shock, make sure that the instrument is turned off, the power supply is disconnected and the fuse used is up to standard before replacing the fuse.

User Interface

The user interface of DSG3000 series RF signal generator provides two display modes: normal display mode and parameter zoom-in mode. At power-on, the instrument enters the normal display mode by default. In this manual, the normal display mode of DSG3060 is taken as an example to illustrate the user interface of the instrument.

Normal Display Mode

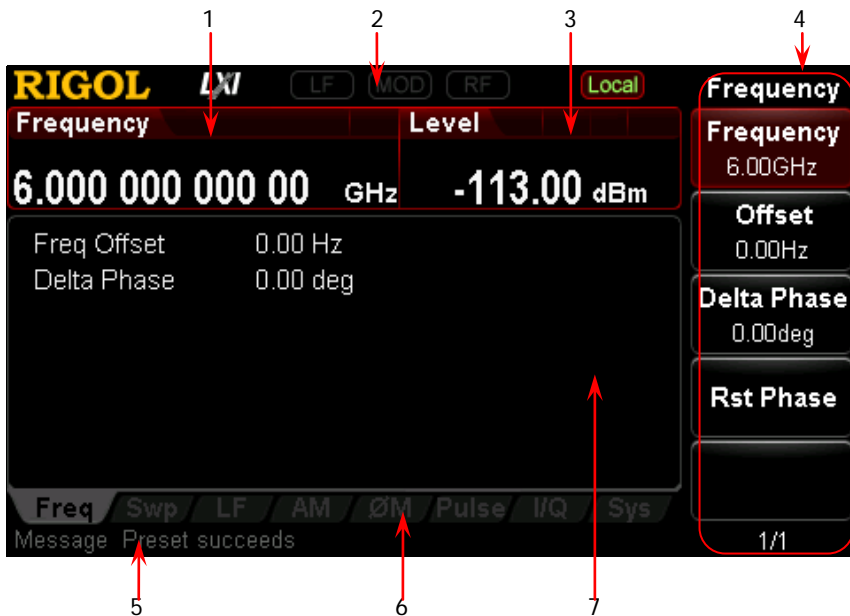

Figure 5 User Interface (Normal Display Mode)





1. Frequency Area

Display the current frequency setting of the RF signal generator.

- **Offs**: Displayed when the frequency offset is not 0 Hz.
- **↻**: Continuous sweep label. Displayed when the sweep type is “Freq” or “Freq&Lev” and the sweep mode is “Cont”.
- **↶**: Single sweep label. Displayed when the sweep type is “Freq” or “Freq&Lev” and the sweep mode is “Single”.
- **↑**: Forward sweep label. Displayed when the sweep type is “Freq” or “Freq&Lev” and the sweep direction is “Fwd”.
- **↓**: Down sweep label. Displayed when the sweep type is “Freq” or “Freq&Lev” and the sweep direction is “Down”.
- **▬**: Frequency sweep progress bar. Displayed when the sweep type is “Freq” or “Freq&Lev”.











2. Status Bar

Indicate the states of some of the RF signal generator functions.

- : Displayed when the LF output is enabled.
- : Displayed when the RF modulation output is enabled.
- : Displayed when the RF output is enabled.
- : The RF signal generator is working in remote control mode.
- : The RF signal generator is working in local mode.

3. Amplitude Area

Display the current level setting of the RF signal generator.

- : Displayed when the attenuation mode is "Fixed".
- : Displayed when the ALC state is "On".
- : Displayed when the ALC state is "Auto".
- : Displayed when the flatness calibration switch is "On".
- : Displayed when the amplitude offset is not 0 dB.
- : Continuous sweep label. Displayed when the sweep type is "Level" or "Freq&Lev" and the sweep mode is "Cont".
- : Single sweep label. Displayed when the sweep type is "Level" or "Freq&Lev" and the sweep mode is "Single".
- : Forward sweep label. Displayed when the sweep type is "Level" or "Freq&Lev" and the sweep direction is "Fwd".
- : Down sweep label. Displayed when the sweep type is "Level" or "Freq&Lev" and the sweep direction is "Down".
- : Amplitude sweep progress bar. Displayed when the sweep type is "Level" or "Freq&Lev".

4. Menu Display Area

This area defines the annotations of the menu softkeys at the right of the screen. The annotations of the menu softkeys change according to the function selected. Pressing any softkey can enable the corresponding function.

5. Error Message Display Area

Display the message in abbreviated form. When multiple messages are generated, only the latest message will be displayed. To view the messages recently displayed, press **System** → **Information** → **System Msg**.

6. Function Status Area

Display the current active states of each function. Each function corresponds to at most four kinds of states as shown in the table below.

Type	Explanation	Example
Gray text on a black background	The function is not selected and enabled.	AM
Black text on a gray background	The function is selected and you can set the corresponding parameters.	AM
White text on a gray background	The function is selected and enabled.	AM
White text on a black background	The function is not selected but it is enabled.	AM

The status labels in the function status area as shown in the figure below.

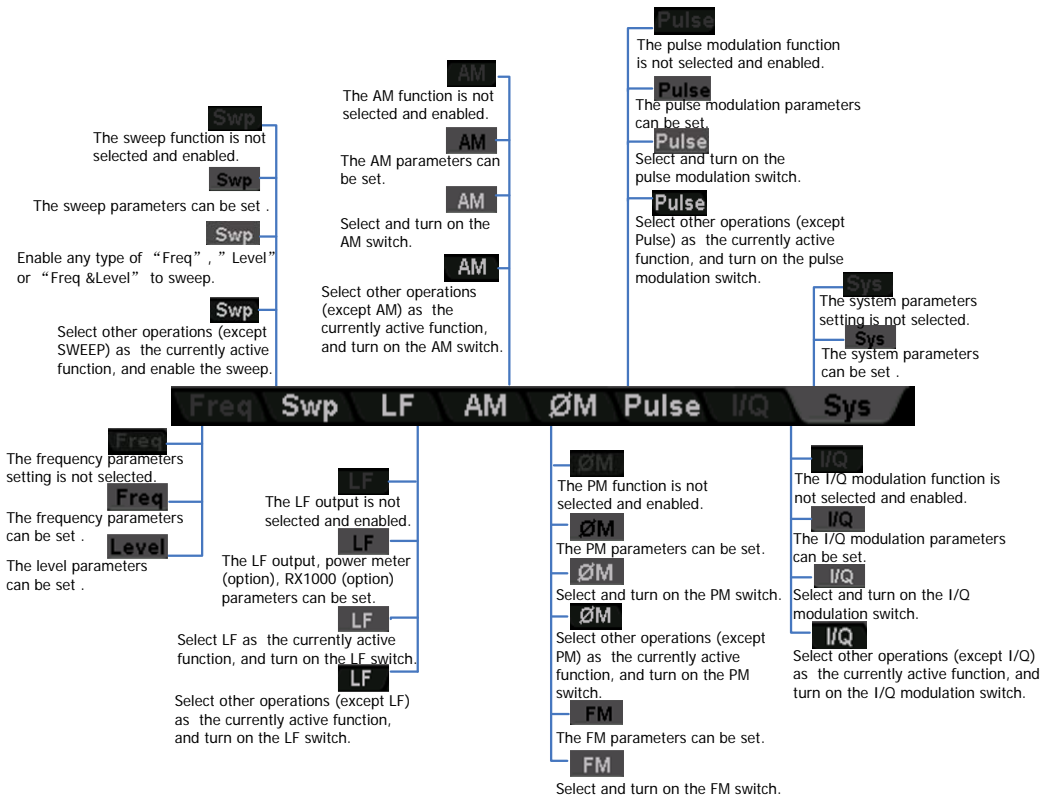

Figure 6 Labels in Function Status Area

7. Text Display Area

Display the corresponding parameter information of the current function of the RF signal generator.

Parameter Zoom-in Mode

In normal display mode, pressing the display switch key **View** at the left of the screen can switch to the parameter zoom-in mode as shown in the figure below.



Figure 7 User Interface (Parameter Zoom-in Mode)

To Use the Built-in Help System

The DSG3000 built-in help system provides help information for all the function keys and menu softkeys at the front panel. Users can view the help of any key when operating the instrument.

1. Acquire the built-in help

Press **Help** and the prompt message about how to acquire the help information is displayed in the test display area of the user interface, as shown in Figure 8. Then, press the desired key and the help information of that key is displayed in the text display area.

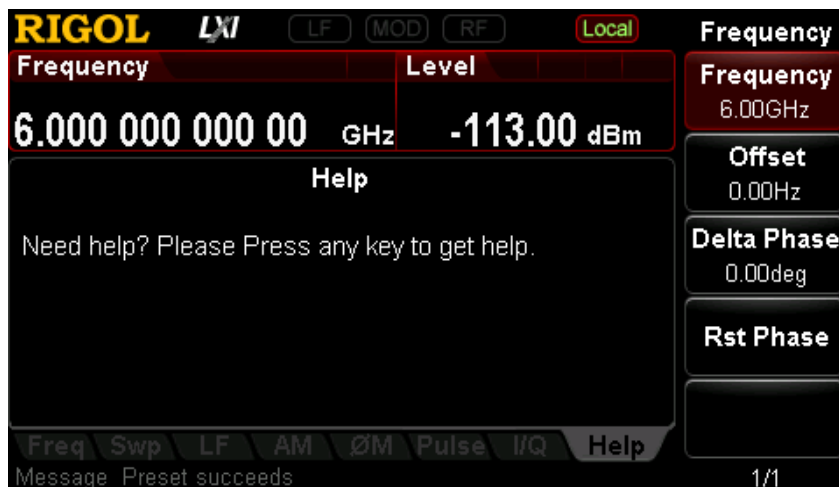

Figure 8 Help Interface

2. Page up/down

When the help information is displayed on multiple pages, users can acquire the help information on the previous or next page using the direction keys or knob.

3. Turn off the current help information

When the help information is displayed in the text display area, pressing any key (except the direction keys and knob) at the front panel will turn off the help information currently displayed.

4. Acquire the help information of a menu softkey

Press **Help** and help information is displayed in the text display area. Then, press the desired menu softkey, the help information of the menu item corresponding to this menu softkey is displayed in the text display area.

5. Acquire the help information of any function key

Press **Help** and help information is displayed in the text display area. Then, press any function key and the function help information of this key is displayed in the text display area.

Basic Operations

To Output RF Signal

Output a RF signal with 1 GHz frequency and -40 dBm amplitude from the **[RF OUTPUT 50Ω]** connector.

1. Restore to factory setting

Press **[System]** → **Reset** → **Preset Type** → “Factory” and then press **[Preset]** to restore the factory setting (by default, the frequency offset is 0 Hz and the amplitude offset is 0 dB).

2. Frequency setting

Press **[FREQ]** → **Frequency**, use the numeric keyboard to input the frequency value (1) and select the desired unit (GHz) from the pop-up unit menu or unit keys.

- The frequency units available are GHz, MHz, kHz and Hz.
- Pressing **[Enter]** can select the default unit Hz.
- You can also press the left/right direction key to enter the parameter editing state and move the cursor to the specified digit; and then use the up/down direction key or knob to modify the value.
- After the frequency is set, you can use the up/down direction key or knob to modify the frequency at the current step.
- Press **[FREQ]** → **Frequency** and then press **[Step]** to set the step.

3. Amplitude setting

Press **[LEVEL]** → **Level**, use the numeric keyboard to input the amplitude value (-40) and select the desired unit (dBm) from the pop-up unit menu or unit keys. You can also press **[Enter]** to select the default unit dBm.

- The amplitude units available are dBm, -dBm, mV, uV and nV.
- You can also press the left/right direction key to enter the parameter editing state and move the cursor to the specified digit; and then use the up/down direction key or knob to modify the value.
- You can also use the up/down direction key or knob to modify the amplitude at the current step.
- Press **[LEVEL]** → **Level** and then press **[Step]** to set the step.

4. Enable the RF output

Press **[RF]**, the backlight goes on and the RF label is displayed in the status bar of

the user interface. The RF output is enabled. At this point, the [RF OUTPUT 50Ω] connector outputs RF signal according to the current configuration.



Figure 9 Parameter Setting Interface (To Output RF Signal)

To Output RF Sweep Signal

This section introduces how to output a RF sweep signal by configuring continuous linear step sweep. Set the frequency range to 1 GHz ~ 2 GHz, the amplitude range to -20 dBm ~ 0 dBm, the number of sweep points to 10 and the dwell time to 500 ms.

1. Restore to factory setting

Press **System** → **Reset** → **Preset Type** → “Factory” and then press **Preset** to restore the factory setting (by default, the sweep mode is continuous, the sweep type is step and the sweep space is linear).

2. Step sweep parameter setting

Press **SWEEP** and use the menu page up/down key  to turn to the 2/3 menu page; then, press **Step Swp** to enter the step sweep parameter setting interface.

- **Start Frequency**
Press **Start Freq**, use the numeric keyboard to input the start frequency value (1) and select the desired unit (GHz) from the pop-up unit menu or unit keys.

- **Stop Frequency**
Press **Stop Freq**, use the numeric keyboard to input the stop frequency value (2) and select the desired unit (GHz) from the pop-up unit menu or unit keys.
- **Start Level**
Press **Start Lev**, use the numeric keyboard to input the start level value (-20) and select the desired unit (dBm) from the pop-up unit menu or unit keys. You can also press **Enter** to select the default unit (dBm).
- **Stop Level**
Press **Stop Lev**, use the numeric keyboard to input the stop level value (0) and select the desired unit (dBm) from the pop-up unit menu or unit keys. You can also press **Enter** to select the default unit (dBm).
- **Sweep Points**
Press **Points**, use the numeric keyboard to input the number of sweep points (10) and then press **OK** or **Enter**.
- **Dwell Time**
The dwell time indicates the duration of a sweep step.
Press **Dwell Time**, use the numeric keyboard to input the time value (500) and select the desired unit (ms) from the pop-up unit menu or unit keys.

3. Enable the RF sweep

Press **SWEEP** → **Sweep** and select "Freq&Level" to enable the frequency and amplitude sweep functions at the same time.

At this point, the RF signal generator sweeps from the start frequency and level to the stop frequency and level continuously at certain step according to the current settings. The frequency and amplitude sweep progress bars as well as the continuous sweep label are displayed in the frequency and amplitude areas in the user interface respectively.

4. Enable the RF output

Press **RF**, the backlight goes on and the RF label is displayed in the status bar of the user interface. The RF output is enabled. At this point, the **[RF OUTPUT 50Ω]** connector outputs RF sweep signal according to the current configuration.



Figure 10 Parameter Setting Interface (To Output RF Sweep Signal)

To Output RF Modulated Signal

This section introduces how to output an AM modulated signal. Set the carrier frequency to 800 MHz, the carrier amplitude to -20 dBm, the AM modulation depth to 60% and the modulation frequency to 20 kHz.

1. Restore to factory setting

Press **System** → **Reset** → **Preset Type** → “Factory” and then press **Preset** to restore the factory setting (by default, the modulation source is internal and the modulation waveform is sine).

2. Set the carrier frequency and amplitude

(1) Carrier Frequency

Press **FREQ** → **Frequency**, use the numeric keyboard to input the frequency value (800) and select the desired unit (MHz) from the pop-up unit menu or unit keys.

(2) Carrier Amplitude

Press **LEVEL** → **Level**, use the numeric keyboard to input the amplitude value (-20) and select the desired unit (dBm) from the pop-up unit menu or unit keys. You can also press **Enter** to select the default unit (dBm).

3. Set the AM modulation parameters

- (1) Press **AM** to enter the amplitude modulation parameter setting interface.
- (2) Press **Depth**, use the numeric keyboard to input the value of the modulation depth (60) and select the desired unit (%) from the pop-up unit menu or by pressing **Enter**.
- (3) Press **Freq**, use the numeric keyboard to input the frequency value (20) and select the desired unit (kHz) from the pop-up unit menu or unit keys.
- (4) Press **Switch** and select "On" to enable the AM function. The backlight of **AM** goes on.

4. Enable the RF modulation output

Press **MOD** and the backlight goes on; then, press **RF** and the backlight goes on. The MOD and RF labels are displayed in the status bar of the user interface. The RF modulation output is enabled. At this point, the **[RF OUTPUT 50Ω]** connector outputs RF modulated signal according to the current configuration.



Note: The backlights of **RF** and **MOD** must have gone on.



Figure 11 Parameter Setting Interface (To Output RF Modulated Signal)

Remote Control

DSG3000 supports to build communication with the PC via USB, LAN or GPIB interface to realize remote control. The remote control is realized on the basis of the SCPI command set (Standard Commands for Programmable Instruments). This section introduces how to send SCPI commands through the **RIGOL** common PC software Ultra Sigma to control the RF signal generator remotely via the USB interface. For the detailed information of the commands, refer to *DSG3000 Programming Guide*.

Note: When the instrument is in remote mode,  is displayed in the user interface and all the front panel keys (except ) are locked. At this point, you can press  to exit the remote mode.

1. Install Ultra Sigma

Acquire the Ultra Sigma software and install it as well as its components according to the instructions. This software is contained in the resource CD in the standard accessories. You can also download the latest version of the software from www.rigol.com.

2. Control via USB

(1) Connect the device

Connect the RF signal generator (USB Device) and PC (USB Host) using a USB cable.

(2) Install USB drive

This RF signal generator is USBTMC device and the **Found New Hardware Wizard** will be displayed after the RF signal generator is correctly connected to the PC (the signal generator will be automatically configured to USB interface) and both of them are started. Please install the "USB Test and Measurement Device" drive program according to the instructions.

(3) Search for device resource

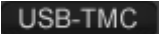
Start Ultra Sigma and the software will search for the RF signal generator resource currently connected to the PC automatically. You can also click  to search for the resource manually.

(4) **View the device resource**

The resource found together with the instrument model and USB interface information will be displayed under the “RIGOL Online Resource” directory, as shown in the figure below.

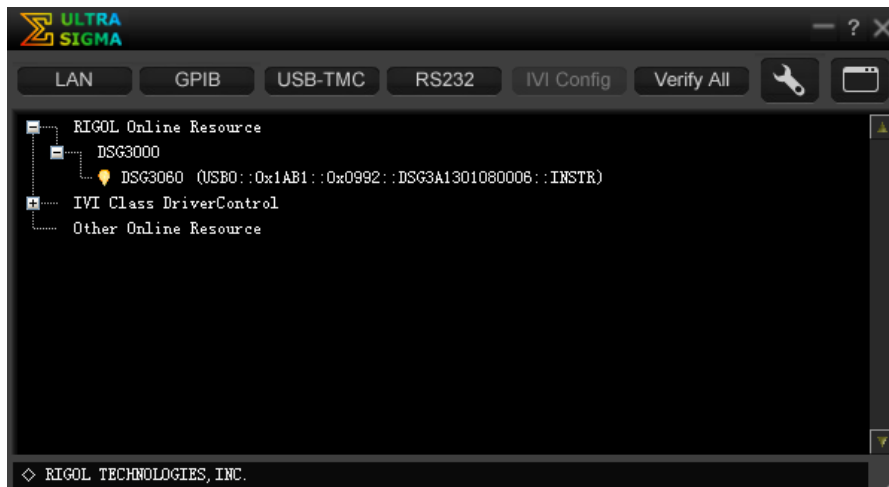

Figure 12 View the USB Device Resource

(5) **Communication test**

Right-click the resource name “DSG3060 (USB0::0x1AB1::0x0992::DSG3A1301080006::INSTR)” and select “SCPI Panel Control” to open the remote command control panel through which you can send commands and read data.

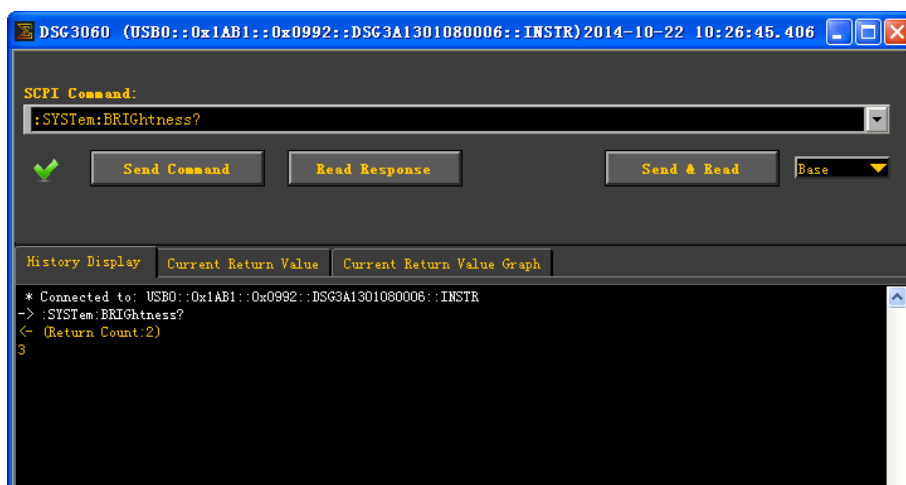

Figure 13 Read and Write Command via USB

Troubleshooting

The commonly encountered failures and their solutions are listed below. When you encounter those problems, please solve them following the corresponding steps. If the problem remains still, please contact **RIGOL** and provide your device information (**System** → **Information** → **System Info**).

1. The screen of the RF signal generator is still dark (no display) after pressing the power key:

- (1) Check whether the fan is running;
 - If the fan is running but the screen is dark, the screen connecting wire might be loose.
 - If the fan is not running, the instrument does not start successfully and please go to step (2).
- (2) Check whether the power is correctly connected and the power switch is really on.
- (3) Check whether the fuse is burned out. If the fuse needs to be replaced, please use the specified fuse (AC 250V, T2A).
- (4) Restart the instrument after finishing the above inspections.
- (5) If it still does not work correctly, please contact **RIGOL**.

2. The screen is too dark and cannot be seen clearly:

- (1) Check whether the brightness setting of the LCD screen is too low.
- (2) Press **System** → **Display** → **Brightness** and use the numeric keys or up/down direction keys to adjust the brightness of the LCD screen of the RF signal generator to a proper value.

3. The RF signal generator is locked:

- (1) Check whether the RF signal generator is in remote control mode (in remote control, **Rmt** is displayed in the status bar of the user interface). Pressing **Esc** can exit the remote control mode and unlock the front panel.
- (2) Check whether the RF signal generator is in local mode with the screen being locked (when the screen is locked, front panel operations are not available). Pressing **Esc** can unlock the screen and exit the locking state.
- (3) If progress bar is displayed on the screen of the signal generator, some operation is in progress. For example, when saving a file, the progress bar will be displayed indicating that the save operation is in progress. At this point, the front panel is locked.
- (4) Pressing **Preset** or restarting the signal generator can also unlock the instrument.

4. The setting is correct but the waveform output is incorrect:

- (1) There is no RF output
 - Check whether the signal connecting wire is tightly connected to the corresponding **[RF OUTPUT 50Ω]** connector.
 - Check whether the connecting wire has internal damage.
 - Check whether the connecting wire is tightly connected to the test instrument.
 - Check whether the backlight of **[RF]** goes on. If not, press this key to illuminate the backlight. At this point, the RF label is displayed in the status bar of the user interface and the RF output is enabled.
 - Check whether the output amplitude of the RF signal is too small. Adjust the output amplitude properly.
- (2) The RF output is not modulated
 - Check whether the signal connecting wire is tightly connected to the corresponding **[RF OUTPUT 50Ω]** connector.
 - Check whether the connecting wire has internal damage.
 - Check whether the connecting wire is tightly connected to the test instrument.
 - Check whether the backlights of **[MOD]** and **[RF]** are both illuminated and check whether the modulation **Switch** is set to "On".
 - Check whether the modulation parameter setting is correct and adjust the parameter appropriately.
 - If external modulation source is used, make sure that the external source is correctly connected and outputs signal. At the same time, the external source should work within the specified range of the signal generator.

5. The sweep is abnormal:

- (1) The sweep stagnates

The sweep progress bar is displayed in the frequency area/amplitude area in the user interface indicating that the sweep is in progress. If the sweep stagnates, please check:

 - At least one manner of sweep is enabled. Press **[SWEEP]** → **Sweep** to select "Freq", "Level" or "Freq&Level".
 - If single sweep mode is selected, press **Single** and the instrument performs a sweep if the trigger condition is met.
 - If the sweep trigger mode is not set to auto, press **[SWEEP]** → **Trig** → "Auto" to make sure whether the sweep stagnates due to the loss of sweep trigger.
 - If the point trigger mode is not set to auto, press **[SWEEP]** → **Point Trig** → "Auto" to make sure whether the sweep stagnates due to the loss of point trigger.
 - Make sure whether the dwell time is too large or too small that the sweep cannot be seen.

- Make sure that at least two points are set in the step sweep or list sweep.
- (2) The dwell time of list sweep is incorrect
 - Press **SWEEP** → **List Swp** to enter the sweep list editing interface.
 - Make sure whether the dwell time of the list sweep is correct.
 - If the dwell time is incorrect, re-edit it; if it is correct, turn to the next step.
 - Press **SWEEP** → **Sweep Type** to make sure that “List” sweep is selected.
If “Step” sweep is currently selected, the signal generator sweeps according to the dwell time of the step sweep.
- (3) The list sweep information recalled from the register is lost
 - The list sweep information cannot be stored in the status register of the instrument as a part of the instrument state.
 - The signal generator can only use the current list for sweep and you can store the list sweep data to the local directory of the instrument.
- (4) In list or step sweep, the amplitude does not change
 - Make sure that the sweep manner is set to “Level” or “Freq&Level”.
 - If the sweep manner is currently set to “Freq”, the amplitude will not change.

6. The USB storage device cannot be recognized:

- (1) Check whether the USB storage device can work normally when connected to other instrument or PC.
- (2) Make sure that the USB storage device used is Flash type. This instrument does not support hardware USB storage device.
- (3) Restart the instrument and insert the USB storage again to check whether it can work normally.
- (4) If the USB storage device still cannot be used normally, please contact **RIGOL**.

7. No response or incorrect response when key is pressed:

- (1) After starting the instrument, make sure that whether all the keys are irresponsive.
- (2) Press **System** → **Self-test** → **Key Test** to enter the keyboard test interface. Press the function keys at the front panel sequentially and check whether some key gives no response or incorrect response when it is pressed.
- (3) If the above failures occur, the keyboard connecting wire might be loose or the keyboard is damaged. Please do not disassemble the instrument and contact **RIGOL**.

8. Performance specification test is not passed:

- (1) Check whether the RF signal generator is within calibration period (1 year).

-
- (2) Make sure that the RF signal generator is warmed up for at least 30 minutes before test.
 - (3) Check whether the RF signal generator is under the specified temperature.
 - (4) Check whether the test is under the magnetic environment.
 - (5) Check whether the power supplies of RF signal generator and test system have strong interference.
 - (6) Check whether the performance of the test device meets the requirement.
 - (7) Make sure that the test device is within calibration period.
 - (8) Check whether the test device meets the required conditions of the manual.
 - (9) Check whether all connections are tight.
 - (10) Check whether all cables have internal damage.
 - (11) Make sure that the operations conform to settings and processes which are required by the performance verification manual.
 - (12) Check whether the error calculation is a mistake.
 - (13) The definitions of "Typical Value" and "Nominal Value" for this product should be correctly understood.
 - Typical Value: the performance specification of this product under specified conditions.
 - Nominal Value: the approximate quantity of the product during application.