

# **RIGOL**

## **User Guide**

# **DSG800 Series RF Signal Generator**

**Aug. 2019**  
**RIGOL (SUZHOU) TECHNOLOGIES INC.**



# Guaranty and Declaration

## Copyright

© 2015 **RIGOL** (SUZHOU) TECHNOLOGIES INC. All Rights Reserved.

## Trademark Information

**RIGOL** is a registered trademark of **RIGOL** (SUZHOU) TECHNOLOGIES INC.

## Publication Number

UGG02108-1110

## Software Version

00.01.07

Software upgrade might change or add product features. Please acquire the latest version of the manual from **RIGOL** website or contact **RIGOL** to upgrade the software.

## Notices

- **RIGOL** products are covered by P.R.C. and foreign patents, issued and pending.
- **RIGOL** reserves the right to modify or change parts of or all the specifications and pricing policies at the company's sole decision.
- Information in this publication replaces all previously released materials.
- Information in this publication is subject to change without notice.
- **RIGOL** shall not be liable for either incidental or consequential losses in connection with the furnishing, use, or performance of this manual, as well as any information contained.
- Any part of this document is forbidden to be copied, photocopied, or rearranged without prior written approval of **RIGOL**.

## Product Certification

**RIGOL** guarantees that this product conforms to the national and industrial standards in China as well as the ISO9001:2015 standard and the ISO14001:2015 standard. Other international standard conformance certifications are in progress.

## Contact Us

If you have any problem or requirement when using our products or this manual, please contact **RIGOL**.

E-mail: [service@rigol.com](mailto:service@rigol.com)

Website: [www.rigol.com](http://www.rigol.com)

# Safety Requirement

## General Safety Summary

Please review the following safety precautions carefully before putting the instrument into operation so as to avoid any personal injury or damage to the instrument and any product connected to it. To prevent potential hazards, please follow the instructions specified in this manual to use the instrument properly.

### **Use Proper Power Cord.**

Only the exclusive power cord designed for the instrument and authorized for use within the local country could be used.

### **Ground the Instrument.**

The instrument is grounded through the Protective Earth lead of the power cord. To avoid electric shock, connect the earth terminal of the power cord to the Protective Earth terminal before connecting any input or output terminals.

### **Connect the Probe Correctly.**

If a probe is used, the probe ground lead must be connected to earth ground. Do not connect the ground lead to high voltage. Improper way of connection could result in dangerous voltages being present on the connectors, controls or other surfaces of the oscilloscope and probes, which will cause potential hazards for operators.

### **Observe All Terminal Ratings.**

To avoid fire or shock hazard, observe all ratings and markers on the instrument and check your manual for more information about ratings before connecting the instrument.

### **Use Proper Overvoltage Protection.**

Ensure that no overvoltage (such as that caused by a bolt of lightning) can reach the product. Otherwise, the operator might be exposed to the danger of an electric shock.

### **Do Not Operate Without Covers.**

Do not operate the instrument with covers or panels removed.

### **Do Not Insert Objects Into the Air Outlet.**

Do not insert objects into the air outlet, as doing so may cause damage to the instrument.

### **Use Proper Fuse.**

Please use the specified fuses.

**Avoid Circuit or Wire Exposure.**

Do not touch exposed junctions and components when the unit is powered on.

**Do Not Operate With Suspected Failures.**

If you suspect that any damage may occur to the instrument, have it inspected by **RIGOL** authorized personnel before further operations. Any maintenance, adjustment or replacement especially to circuits or accessories must be performed by **RIGOL** authorized personnel.

**Provide Adequate Ventilation.**

Inadequate ventilation may cause an increase of temperature in the instrument, which would cause damage to the instrument. So please keep the instrument well ventilated and inspect the air outlet and the fan regularly.

**Do Not Operate in Wet Conditions.**

To avoid short circuit inside the instrument or electric shock, never operate the instrument in a humid environment.

**Do Not Operate in an Explosive Atmosphere.**

To avoid personal injuries or damage to the instrument, never operate the instrument in an explosive atmosphere.

**Keep Instrument Surfaces Clean and Dry.**

To avoid dust or moisture from affecting the performance of the instrument, keep the surfaces of the instrument clean and dry.

**Prevent Electrostatic Impact.**

Operate the instrument in an electrostatic discharge protective environment to avoid damage induced by static discharges. Always ground both the internal and external conductors of cables to release static before making connections.

**Use the Battery Properly.**

Do not expose the battery (if available) to high temperature or fire. Keep it out of the reach of children. Improper change of a battery (lithium battery) may cause an explosion. Use the **RIGOL** specified battery only.

**Handle with Caution.**

Please handle with care during transportation to avoid damage to keys, knobs, interfaces, and other parts on the panels.

## Safety Notices and Symbols

### Safety Notices in this Manual:



---

**WARNING**

Indicates a potentially hazardous situation or practice which, if not avoided, will result in serious injury or death.

---



---

**CAUTION**

Indicates a potentially hazardous situation or practice which, if not avoided, could result in damage to the product or loss of important data.

---

### Safety Terms on the Product:

**DANGER** It calls attention to an operation, if not correctly performed, could result in injury or hazard immediately.

**WARNING** It calls attention to an operation, if not correctly performed, could result in potential injury or hazard.

**CAUTION** It calls attention to an operation, if not correctly performed, could result in damage to the product or other devices connected to the product.

### Safety Symbols on the Product:



Hazardous Voltage



Safety Warning



Protective Earth Terminal



Chassis Ground



Test Ground

## Care and Cleaning

### Care

Do not store or leave the instrument where it may be exposed to direct sunlight for long periods of time.

### Cleaning

Clean the instrument regularly according to its operating conditions.

1. Disconnect the instrument from all power sources.
2. Clean the external surfaces of the instrument with a soft cloth dampened with mild detergent or water. Avoid having any water or other objects into the chassis via the heat dissipation hole. When cleaning the LCD, take care to avoid scarifying it.



---

**CAUTION**

To avoid damage to the instrument, do not expose it to caustic liquids.

---



---

**WARNING**

To avoid short-circuit resulting from moisture or personal injuries, ensure that the instrument is completely dry before connecting it to the power supply.

---

## Environmental Considerations

The following symbol indicates that this product complies with the WEEE Directive 2002/96/EC.



### Product End-of-Life Handling

The equipment may contain substances that could be harmful to the environment or human health. To avoid the release of such substances into the environment and avoid harm to human health, we recommend you to recycle this product appropriately to ensure that most materials are reused or recycled properly. Please contact your local authorities for disposal or recycling information.

You can click on the following link

[http://www.rigol.com/Files/RIGOL\\_RoHS2.0&WEEE.pdf](http://www.rigol.com/Files/RIGOL_RoHS2.0&WEEE.pdf) to download the latest version of the RoHS&WEEE certification file.

## DSG800 Series Overview

DSG800 series RF signal generator provides all-round modulation plans. It provides standard AM/FM/ØM functions as well as optional pulse modulation function, and pulse train generator. Besides, DSG821A and DSG836A are equipped with a standard configuration of I/Q modulation function. All the modulation functions support both external and internal sources. Besides, to fulfill the application requirements of the production lines, severe test verifications are performed on DSG800 during the design and production phases to ensure its stability and reliability. DSG800 provides clear panel layout and is easy-to-operate. It can output stable, accurate and pure signals. Besides, it is small in size and light in weight. DSG800 is an ideal tool for various fields such as communication, computer, instrumentation, research, education, production and maintenance.

### Main Features:

- Up to 1.5 GHz/2.1 GHz/3 GHz/3.6 GHz frequency
- The typical value of amplitude precision is not greater than 0.5 dB
- -110 dBm to +20 dBm output power
- High signal purity; the typical value of phase noise is lower than -112dBc/Hz@20 kHz
- Provide 2 ppm internal clock (standard) as well as an optional 5 ppb highly stable clock
- Provide AM/FM/ØM analog modulation functions (standard)
- Provide optional pulse modulation with up to 70 dB on/off ratio; it also provides optional pulse train generator
- Provide I/Q modulation and I/Q baseband output (the two are available as standard configuration only for DSG821A and DSG836A)
- All the modulation functions support both internal and external modulation modes
- It is designed with a height of 2U which saves the rack space; it also provides the rack mount kit
- Provide USB/LAN remote control interfaces (standard) and standard SCPI command set
- Provide the system flatness calibration (cable, attenuator, amplifier and etc.) function



# Document Overview

## Main Topics in this Manual

### **Chapter 1 Quick Start**

This chapter introduces the front panel, rear panel and user interface of the RF signal generator as well as the precautions when using the instrument for the first time.

### **Chapter 2 Front Panel Operations**

This chapter introduces the functions of the keys at the front panel of the RF signal generator as well as the menu functions under the keys in details.

### **Chapter 3 Remote Control**

This chapter introduces how to control the RF signal generator remotely.

### **Chapter 4 Application Examples**

This chapter provides some application examples of the RF signal generator.

### **Chapter 5 Troubleshooting**

This chapter lists the common failures that might occur when using the RF signal generator as well as their solutions.

### **Chapter 6 Appendix**

This chapter provides the accessory list of the RF signal generator as well as the service and support information.

## Format Conventions in this Manual

### 1. Key:

The key at the front panel is denoted by the format of "Text Box + Key Name (Bold)" in the manual. For example, **FREQ** denotes the **FREQ** key.

### 2. Menu:

The menu is denoted by the format of "Character Shading + Menu Word (Bold)" in the manual. For example, **LF** denotes the low frequency menu item under **FREQ**.

### 3. Connector:

The connector at the front or rear panel is denoted by the format of "Square Brackets + Connector Name (Bold)" in the manual. For example, **[RF OUTPUT 50Ω]**.

### 4. Operation Step:

The next step of operation is denoted by an arrow "→" in the manual. For example, **FREQ** → **LF** denotes pressing **FREQ** at the front panel and then pressing **LF**.

## Content Conventions in this Manual

DSG800 series RF signal generator includes the following models. This manual takes DSG836A as an example.

| Model   | Frequency Range  | I/Q Modulation |
|---------|------------------|----------------|
| DSG815  | 9 kHz to 1.5 GHz | --             |
| DSG821  | 9 kHz to 2.1 GHz | --             |
| DSG821A | 9 kHz to 2.1 GHz | Standard       |
| DSG830  | 9 kHz to 3 GHz   | --             |
| DSG836  | 9 kHz to 3.6 GHz | --             |
| DSG836A | 9 kHz to 3.6 GHz | Standard       |

## Manuals of this Product

The manuals of this product include the quick guide, user guide, programming guide, data sheet and etc. The latest versions of the manuals can be downloaded from [www.rigol.com](http://www.rigol.com).

# Contents

|  |            |
|--|------------|
| <b>Guaranty and Declaration .....</b>                    | <b>I</b>   |
| <b>Safety Requirement .....</b>                          | <b>II</b>  |
| General Safety Summary .....                             | II         |
| Safety Notices and Symbols .....                         | IV         |
| Care and Cleaning .....                                  | V          |
| Environmental Considerations .....                       | V          |
| <b>DSG800 Series Overview.....</b>                       | <b>VI</b>  |
| <b>Document Overview.....</b>                            | <b>VII</b> |
| <b>Chapter 1 Quick Start .....</b>                       | <b>1-1</b> |
| General Inspection .....                                 | 1-2        |
| Appearance and Dimensions.....                           | 1-3        |
| Front Panel Overview.....                                | 1-5        |
| Rear Panel Overview.....                                 | 1-11       |
| To Use DSG800 for the First Time .....                   | 1-16       |
| To Connect the Power Supply.....                         | 1-16       |
| Power-on Inspection .....                                | 1-16       |
| To Set the System Language.....                          | 1-16       |
| User Interface.....                                      | 1-17       |
| To Use the Built-in Help System .....                    | 1-21       |
| <b>Chapter 2 Front Panel Operations .....</b>            | <b>2-1</b> |
| To Set the Frequency/LF Parameters .....                 | 2-2        |
| Frequency.....   | 2-2        |
| LF Output .....  | 2-2        |
| To Set the Amplitude Parameters .....                    | 2-4        |
| Amplitude .....  | 2-4        |
| Flatness Calibration.....                                | 2-4        |
| Amplitude Unit.....                                      | 2-5        |
| Sweep.....   | 2-6        |
| Sweep Manner.....  | 2-6        |
| Sweep Direction.....                                     | 2-6        |
| Sweep Type.....  | 2-7        |
| Sweep Mode.....  | 2-10       |
| Single Sweep.....  | 2-10       |
| To Reset the Sweep .....                                 | 2-11       |
| Trigger Mode.....  | 2-11       |
| Modulation .....   | 2-14       |
| Amplitude Modulation (AM).....                           | 2-14       |
| Frequency Modulation (FM).....                           | 2-17       |
| Phase Modulation (ØM) .....                              | 2-20       |
| Pulse Modulation (Option DSG800-PUM) .....               | 2-23       |
| I/Q Modulation (Only Available for DSG821A/DSG836A)..... | 2-29       |

|   |            |
|---|------------|
| Store and Recall.....                           | 2-35       |
| File Type.....                                  | 2-36       |
| Save.....                                       | 2-37       |
| Recall.....                                     | 2-40       |
| Rename.....                                     | 2-40       |
| Delete.....                                     | 2-40       |
| Copy.....                                       | 2-40       |
| To Create a Directory.....                      | 2-41       |
| Filename Prefix.....                            | 2-41       |
| Format.....                                     | 2-41       |
| System Update.....                              | 2-41       |
| To Set the System Parameters.....               | 2-42       |
| Language.....                                   | 2-42       |
| Reset.....                                      | 2-42       |
| I/O Configuration.....                          | 2-46       |
| Display Setting.....                            | 2-48       |
| Power Status.....                               | 2-48       |
| Information.....                                | 2-49       |
| License.....                                    | 2-49       |
| Self-test.....                                  | 2-50       |
| Sanitation.....                                 | 2-50       |
| <b>Chapter 3 Remote Control.....</b>            | <b>3-1</b> |
| Remote Control Overview.....                    | 3-2        |
| Remote Control Via USB.....                     | 3-3        |
| Remote Control Via LAN.....                     | 3-4        |
| <b>Chapter 4 Application Examples.....</b>      | <b>4-1</b> |
| To Output a RF Signal.....                      | 4-2        |
| To Output a RF Sweep Signal.....                | 4-3        |
| To Output a RF Modulated Signal.....            | 4-5        |
| <b>Chapter 5 Troubleshooting.....</b>           | <b>5-1</b> |
| <b>Chapter 6 Appendix.....</b>                  | <b>6-1</b> |
| Appendix A: DSG800 Accessories and Options..... | 6-1        |
| Appendix B: Warranty.....                       | 6-2        |
| <b>Index.....</b>                               | <b>1</b>   |

# Chapter 1 Quick Start

This chapter guides users to quickly get familiar with the appearance, dimensions, front panel, rear panel and user interface of DSG800 series RF signal generator.

The topics of this chapter:

- General Inspection
- Appearance and Dimensions
- Front Panel Overview
- Rear Panel Overview
- To Use DSG800 for the First Time
- User Interface
- To Use the Built-in Help System

## General Inspection

### 1. Inspect the packaging

If the packaging has been damaged, do not dispose the damaged packaging or cushioning materials until the shipment has been checked for completeness and has passed both electrical and mechanical tests.

The consigner or carrier shall be liable for the damage to the instrument resulting from shipment. **RIGOL** would not be responsible for free maintenance/rework or replacement of the instrument.

### 2. Inspect the instrument

In case of any mechanical damage, missing parts, or failure in passing the electrical and mechanical tests, contact your **RIGOL** sales representative.

### 3. Check the accessories

Please check the accessories according to the packing lists. If the accessories are damaged or incomplete, please contact your **RIGOL** sales representative.

## Appearance and Dimensions

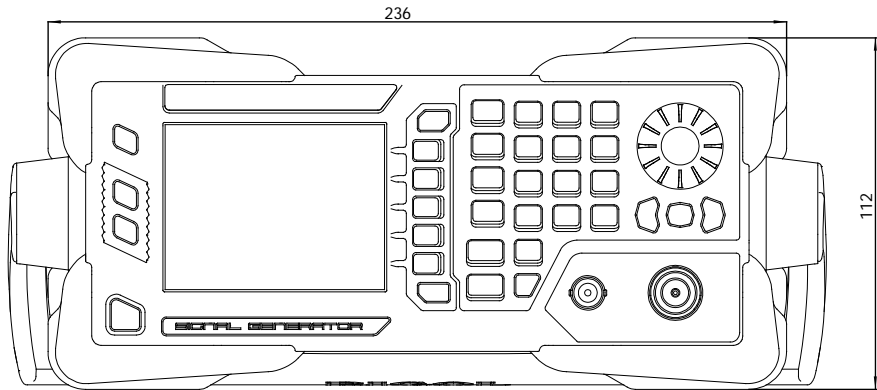

Figure 1-1 Front View (unit: mm)

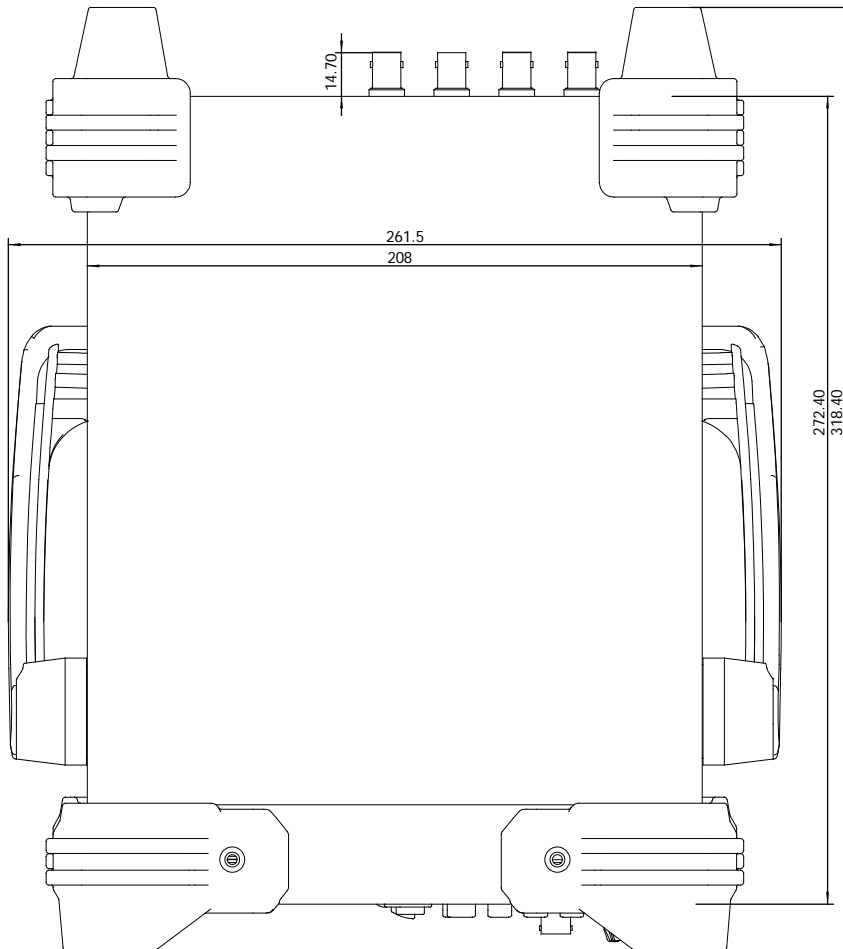

Figure 1-2 Top View (unit: mm)

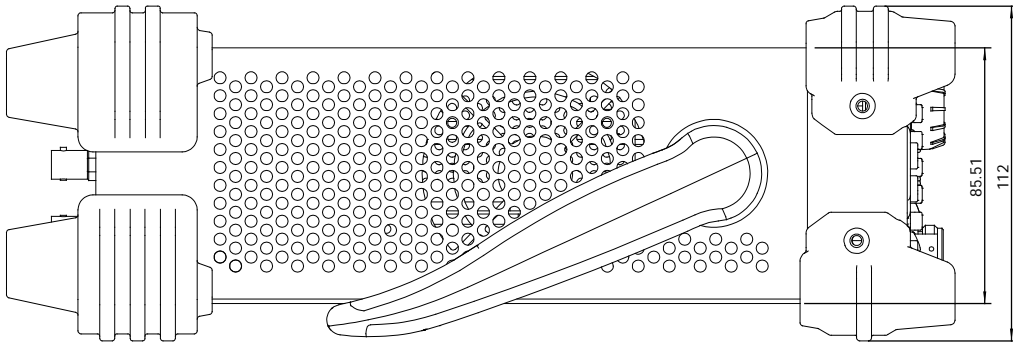

Figure 1-3 Side View (unit: mm)



## Front Panel Overview

The front panel of DSG800 series RF signal generator is as shown in the figure below. You can click the number in the figure to view the corresponding introduction.

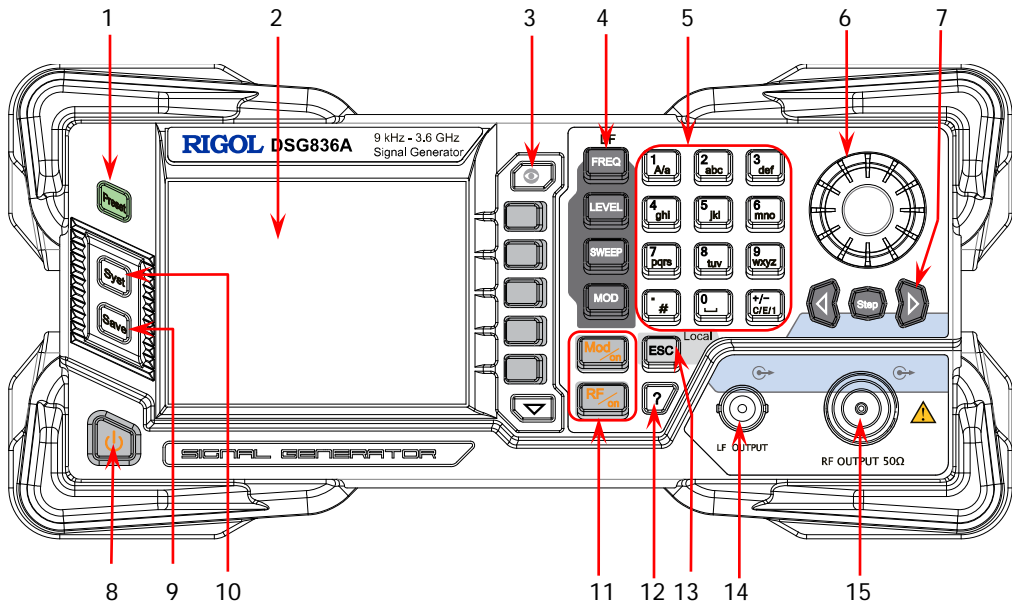

Figure 1-4 Front Panel

### 1. Restore to Preset Key



Restore the instrument to the preset state (the factory default state or user-stored state). For the detailed information, refer to "**Reset**".

### 2. LCD

3.5 inch TFT high-resolution (320×240) color LCD. The current settings and state of the instrument can be clearly displayed. For the detailed information, refer to "**User Interface**".

### 3. Menu Control Keys



Display switching key. In the menu page of any function, you can press this key to open the parameter information display interface of the current function. At this point, you can use the knob or arrow keys to switch the parameter tabs to view the parameter information of different functions. Pressing this key again will switch to the function menu corresponding to the parameter tab currently selected. In addition, you can press any function key to exit the parameter information display interface.



Menu softkeys corresponding to the menus displayed at the left of the softkeys respectively. Pressing the softkey will activate the corresponding menu.

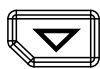

Menu page up/down key.

### 4. Function Keys



Set the frequency parameters of the RF output signal as well as the related parameters of LF output. For the detailed information, refer to "**To Set the Frequency/LF Parameters**".



Set the amplitude parameters of the RF output signal and provide the flatness calibration function. For the detailed information, refer to "**To Set the Amplitude Parameters**".



Set the sweep type, sweep manner, sweep mode and etc. For the detailed information, refer to "**Sweep**".



Set the related parameters of amplitude modulation (AM), frequency modulation (FM), phase modulation (ØM), pulse modulation and pulse generator as well as I/Q modulation and I/Q modulation source. For the detailed information, refer to "**Modulation**".

## 5. Numeric Keyboard

The numeric keyboard supports Chinese characters, English uppercase /lowercase characters, numbers and commonly used symbols (include the decimal point, #, space and positive/negative sign +/-). It is mainly used to edit the file or folder name and set the parameters.

The multiplexing keys of the numbers and letters are used to directly input the desired numbers or letters.



Used to switch among Chinese, English and number input modes.

When setting a parameter, the input mode is fixed at number and this key is used to input the sign ("+" or "-") of the value.



In number input mode, press this key to input 1.

In English input mode, press this key to switch between uppercase and lowercase letter inputs.



The multiplexing key of 0 and space.

In number input mode, press this key to input 0.

In Chinese or English input mode, press this key to input a space.



In number input mode, press this key to insert a decimal point at the current cursor position.

In English input mode, press this key to input "#".

In Chinese input mode, this key is invalid.

## 6. Knob

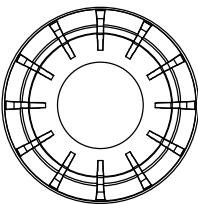

When setting a parameter, the knob is used to modify the value at the cursor or modify the parameter value at the current step.

When editing a filename, it is used to select the desired character.

For the storage function, it is used to select the current directory or file.

In the parameter information display interface, it is used to switch the parameter tabs.

## 7. Arrow Keys/Step Key



When setting a parameter, **Step** is used to set the step of the parameter currently selected; the arrow keys are used to enter the parameter editing state and move the cursor to the specified digit.

For the storage function, the arrow keys are used to collapse and expand the directory currently selected. When editing a filename, the arrow keys are used to select the desired character.

In the parameter information display interface, the arrow keys are used to switch the parameter tabs.

## 8. Power Key

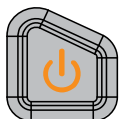

It is used to turn on or off the RF signal generator. You can use the following method to enable or disable this key. Press **Syst** → **Pwr Status** to select "Default" or "Open". When "Default" is selected, you need to press this key to start the instrument after the instrument is powered on. When "Open" is selected, the instrument will start automatically after it is powered on.

Besides, this key provides the delayed switching function (namely, the instrument can be turned on or off only when you press this key and hold it down for a certain period of time) to avoid the shut-down of the instrument due to misoperation.

## 9. Store and Recall Key



Store and recall various types of files (such as the instrument state). For the detailed information, refer to "**Store and Recall**".

## 10. System Setting Key



Set the system-related parameters. For the detailed information, refer to "**To Set the System Parameters**".

## 11. Output Control Keys



Used to turn on or off the RF output.

- Press this key; the backlight of the key and the RF label in the function status area in the user interface are illuminated. At this point, the RF output is turned on and the **[RF OUTPUT 50Ω]** connector outputs RF signal according to the current configuration.
- Press this key again; the backlight of the key turns off and the RF label in the function status area in the user interface is grayed out. At this point, the RF output is turned off.

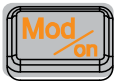

Used to turn on or off the RF modulation output.

- When a modulation function (AM, FM, ØM, Pulse Mod or I/Q Mod) is turned on, press this key; the backlight of the key and the MOD label in the function status area in the user interface are illuminated. At this point, the RF modulation output is turned on and the **[RF OUTPUT 50Ω]** connector outputs the modulated RF signal according to the current configuration (the backlight of **[RF/on]** must be illuminated).
- Press this key again and the backlight of the key turns off. At this point, the RF modulation output is turned off.

## 12. Built-in Help System



To get the help information of any front panel key or menu softkey, press this key and then press the desired key.

## 13. Exit Key



When setting a parameter, this key is used to clear the number in the editing window and exit the parameter input state.

When editing a filename, this key is used to clear the characters in the input bar.

In the keyboard test state, this key is used to exit the current test state.

When the instrument is working in the remote mode, you can press this key to return to the local mode.

After you select the next level of menu, this key is used to exit the current menu and return to the previous menu.

#### 14. LF Output Connector

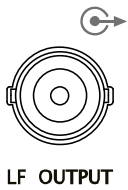

When the LF output is turned on, this connector is used to output the LF signal.

#### 15. RF Output Connector

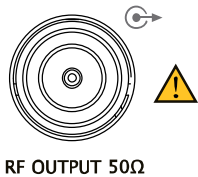

When the backlight of **RF/on** is illuminated, this connector is used to output the RF signal and RF sweep signal.

When the backlights of **RF/on** and **Mod/on** are both illuminated, this connector is used to output the RF modulated signal.



---

#### **CAUTION**

To avoid damaging the instrument, the reverse DC voltage on the RF output connector cannot exceed 50 V and the reverse power cannot exceed +30 dBm (1W) in the 1 MHz to 3.6 GHz frequency segment.

---

## Rear Panel Overview

The rear panel of DSG800 series RF signal generator is as shown in the figure below. You can click the number in the figure to view the corresponding introduction.

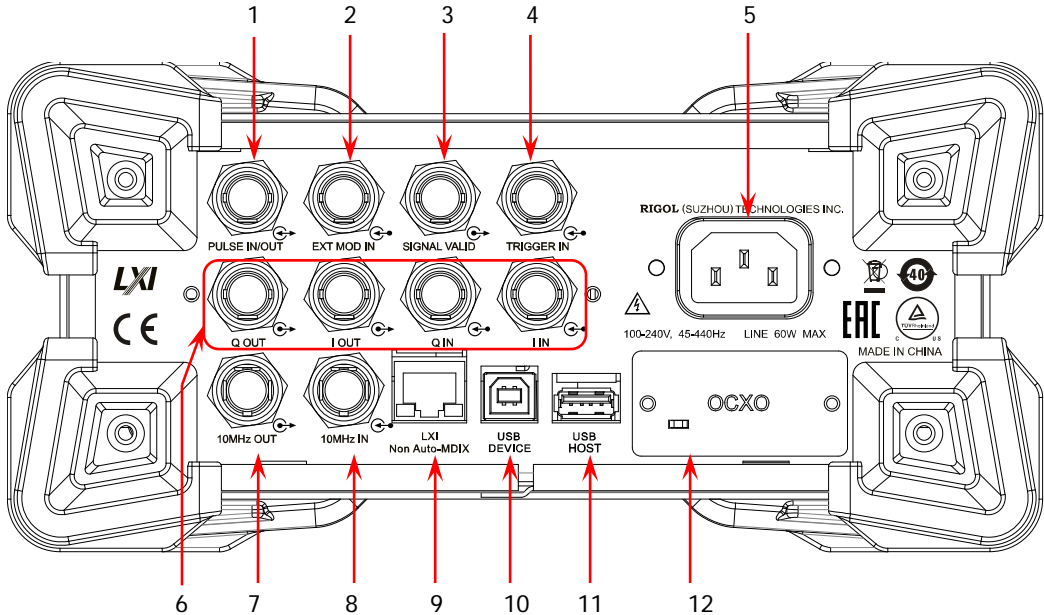
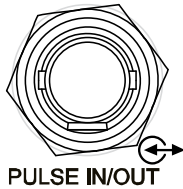

Figure 1-5 Rear Panel

### 1. Pulse Signal Input/Output Connector



The function of this connector is determined by the current working mode of pulse modulation.

#### **PULSE IN:**

When the pulse modulation source is "Ext", this connector is used to input the external pulse signal.

#### **PULSE OUT:**

When the pulse modulation source is "Int" and the pulse output is turned on, this connector is used to output the pulse signal generated by the internal generator. This output signal is related to the pulse "Mode" and can be set to "Single" or "Train".

### 2. External Modulation Input Connector



When the modulation source of AM or FM/ØM is set to "Ext", this connector is used to input the external modulating signal.

### 3. Signal Valid Output Connector



When the RF output frequency or amplitude is modified, after a certain response and processing time of the internal circuit of the instrument, the instrument outputs RF signal with the specified frequency and amplitude via the RF output connector at the front panel. During this process, the **[SIGNAL VALID]** connector outputs a pulse sync signal, indicating that the RF output signal is valid.

- High Level (+3.3 V): indicate that the RF signal is in configuration.
- Low Level (0 V): indicate that the RF signal is stable (namely, the signal is valid).

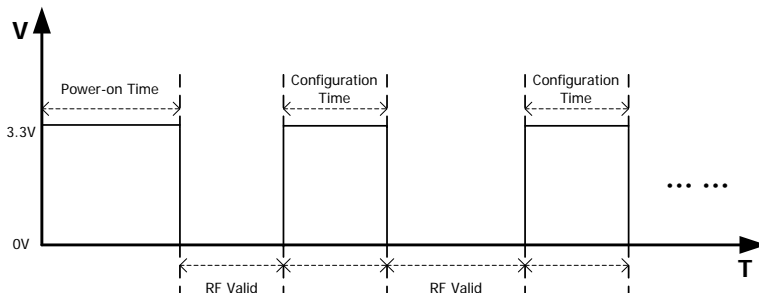



#### 4. External Trigger Input Connector

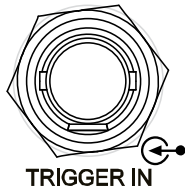

When the trigger mode of **SWEEP** is "Ext", this connector is used to input the external trigger signal. You can press **Trig Slope** to set the polarity of the trigger signal to "Pos" or "Neg". When the trigger mode of I/Q modulation baseband output is "Ext", this connector is used to input the external trigger signal. When the pulse modulation source is "Int" and the trigger mode is "Ext Trig", it is used to input the external trigger signal. When the pulse modulation source is "Int" and the trigger mode is "Ext Gate", it is used to input the external gated signal.

#### 5. Power Input Connector

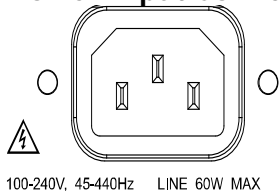

Power input connector. This RF signal generator can accept 100 V to 240 V, 45 Hz to 440 Hz AC power supplies. The power consumption of the instrument cannot exceed 60 W.

#### 6. I/Q Modulating Signal Input/Output Connectors (only available for DSG821A/DSG836A)

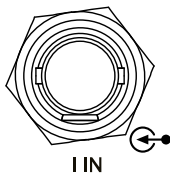

When the I/Q modulation source is "Ext", it is used to input the I (In-Phase) baseband signal of I/Q modulation.

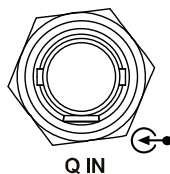

When the I/Q modulation source is "Ext", it is used to input the Q (Quadrature Phase) baseband signal of I/Q modulation.

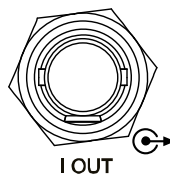

It is used to output the I (In-Phase) components of I/Q modulation of the built-in baseband generator.

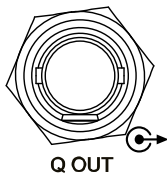

It is used to output the Q (Quadrature Phase) components of I/Q modulation of the built-in baseband generator

**7. Reference Signal Output Connector**

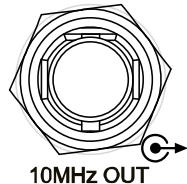

It is used to output the internal 10 MHz reference clock signal which is used to synchronize the generator with other instruments. For more information about the specifications of the clock signal output from this connector, refer to the data sheet of this product.

**8. Reference Signal Input Connector**

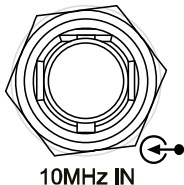

It is used to input the external 10 MHz reference clock signal which is used to synchronize the generator with other instruments. For more information about the specifications of the external clock signal input from this connector, refer to the data sheet of this product.

**9. LAN**

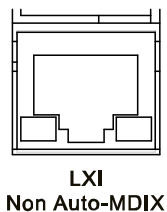

The instrument complies with LXI Core 2011 Device standard. It supports WebServer, Socket and other remote control modes. This interface is used to connect the RF signal generator to the PC or network for remote control.

**10. USB DEVICE**



The instrument complies with USBTMC class protocol. This interface is used to connect the PC for remote control.

## 11. USB HOST

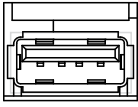

USB  
HOST

This interface is used to connect the USB storage device to update the system or store the system states and etc.

## 12. OCXO (Option OCXO-B08)

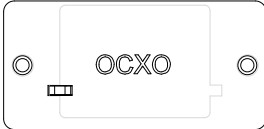

OCXO is an oven controlled crystal oscillator. It is a frequency reference source with higher temperature stability.

**Note:** Sixty minutes of warm-up is required for the OCXO to reach its rated frequency.

For the ordering information of this option, please refer to the data sheet of this product.

## To Use DSG800 for the First Time

### To Connect the Power Supply

Please connect the RF signal generator to AC power supply using the power cable supplied in the accessories. This RF signal generator can accept 100 V to 240 V, 45 HZ to 440 Hz AC power supplies. The power consumption of the instrument cannot exceed 60 W. When the RF signal generator is connected to AC power supply via this connector, the instrument selects the correct voltage range automatically and users do not need to select the voltage range manually.

**CAUTION**

To avoid electric shock, use the standard power cable.

### Power-on Inspection

After the power supply is correctly connected, press the power key  at the front panel to turn on the RF signal generator. During the start-up, the instrument performs initialization and self-test. After that, the instrument enters the default interface.

### To Set the System Language

DSG800 series RF signal generator supports multiple system languages. You can press **Syst** → **Language** to switch the system language.

## User Interface

The user interface of DSG800 series RF signal generator is shown in the figure below.

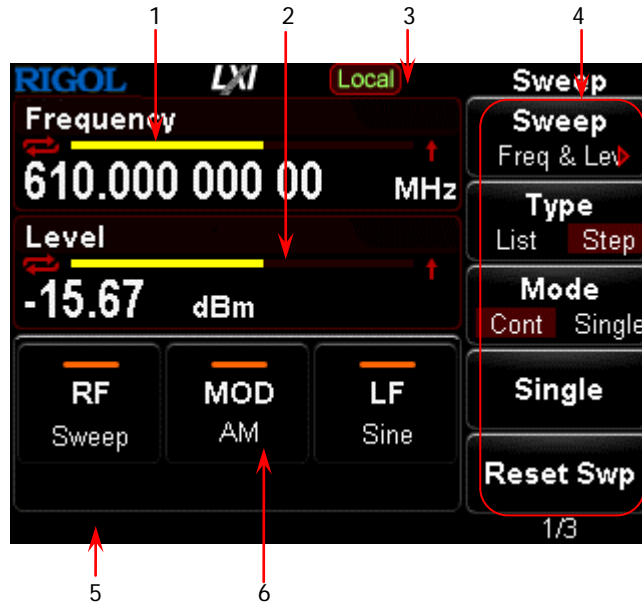

Figure 1-6 User Interface

### 1. Frequency Area



Display the current frequency settings of the RF signal generator.

- : continuous sweep label. It is displayed when the sweep manner is "Freq" or "Freq & Lev" and the sweep mode is "Cont".
- : single sweep label. It is displayed when the sweep manner is "Freq" or "Freq & Lev" and the sweep mode is "Single".
- : forward sweep label. It is displayed when the sweep manner is "Freq" or "Freq & Lev" and the sweep direction is "Fwd".
- : downward sweep label. It is displayed when the sweep manner is "Freq" or "Freq & Lev" and the sweep direction is "Down".
- : frequency sweep progress bar. It is displayed when the sweep manner is "Freq" or "Freq & Lev".

### 2. Amplitude Area





Display the current level settings of the RF signal generator.

- : displayed when the flatness calibration is turned "On".
- : continuous sweep label. It is displayed when the sweep manner is "Level" or "Freq & Lev" and the sweep mode is "Cont".
- : single sweep label. It is displayed when the sweep manner is "Level" or "Freq & Lev" and the sweep mode is "Single".
- : forward sweep label. It is displayed when the sweep manner is

- : downward sweep label. It is displayed when the sweep manner is "Level" or "Freq & Lev" and the sweep direction is "Down".
- : amplitude sweep progress bar. It is displayed when the sweep manner is "Level" or "Freq & Lev".

**3. Status Bar**

Indicate the current system states of the RF signal generator.

- : the RF signal generator is working in the remote control mode.
- : the RF signal generator is working in the local operation mode.
- : displayed when a USB storage device is detected.
- : displayed when the instrument parameter information interface is opened.

**4. Menu Display Area**









The menu items displayed in this area correspond to the softkeys at the right of the screen respectively. Pressing any softkey can enable the corresponding menu function.

**5. Message Display Area**





Display the operation error messages and prompt messages. You can press **Syst** → **Information** → **System Msg** to view the messages. When multiple messages are generated, you can use the arrow keys or knob to select the desired message.

**6. Function Status Area**

Display the current states of the functions of the RF signal generator. The status icons that might be displayed in the function status area are as shown in the table below.

| Icon  | Explanation  | Icon  | Explanation   |
|---|--|---|---|
|  | The RF output is not turned on and no sweep manner is selected.            |  | The LF output is not turned on and Sine waveform is selected.   |
|  | The RF output is not turned on and only a single sweep manner is selected. |  | The LF output is not turned on and Square waveform is selected. |
|  | The RF output is turned on and no sweep manner is selected.                |  | The LF output is turned on and Sine waveform is selected.       |
|  | The RF output is turned on and only a single sweep manner is selected.     |  | The LF output is turned on and Square waveform is selected.     |

|   |  |   |  |
|---|--|---|--|
|    | The RF modulation output is not turned on and only AM is turned on.        |    | The RF modulation output is turned on and AM is turned on.             |
|    | The RF modulation output is not turned on and only FM is turned on.        |    | The RF modulation output is turned on and FM is turned on.             |
|    | The RF modulation output is not turned on and only ØM is turned on.        |    | The RF modulation output is turned on and ØM is turned on.             |
|    | The RF modulation output is not turned on and only Pulse is turned on.     |    | The RF modulation output is turned on and Pulse is turned on.          |
|    | The RF modulation output is not turned on and only IQ is turned on.        |    | The RF modulation output is turned on and IQ is turned on.             |
|    | The RF modulation output is not turned on; AM and FM are turned on.        |    | The RF modulation output is turned on; AM and FM are turned on.        |
|    | The RF modulation output is not turned on; AM and ØM are turned on.        |    | The RF modulation output is turned on; AM and ØM are turned on.        |
|    | The RF modulation output is not turned on; AM and Pulse are turned on.     |    | The RF modulation output is turned on; AM and Pulse are turned on.     |
|   | The RF modulation output is not turned on; FM and Pulse are turned on.     |   | The RF modulation output is turned on; FM and Pulse are turned on.     |
|  | The RF modulation output is not turned on; FM and IQ are turned on.        |  | The RF modulation output is turned on; FM and IQ are turned on.        |
|  | The RF modulation output is not turned on; ØM and Pulse are turned on.     |  | The RF modulation output is turned on; ØM and Pulse are turned on.     |
|  | The RF modulation output is not turned on; ØM and IQ are turned on.        |  | The RF modulation output is turned on; ØM and IQ are turned on.        |
|  | The RF modulation output is not turned on; IQ and Pulse are turned on.     |  | The RF modulation output is turned on; IQ and Pulse are turned on.     |
|  | The RF modulation output is not turned on; AM, FM and Pulse are turned on. |  | The RF modulation output is turned on; AM, FM and Pulse are turned on. |
|  | The RF modulation output is not turned on; AM, ØM                          |  | The RF modulation output is turned on; AM,                             |

|   |  |   |  |
|---|--|---|--|
|   | and Pulse are turned on.   |   | ØM and Pulse are turned on.  |
|  | The RF modulation output is not turned on; FM, IQ and Pulse are turned on.                   |  | The RF modulation output is turned on; FM, IQ and Pulse are turned on. |
|  | The RF modulation output is not turned on; ØM, IQ and Pulse are turned on.                   |  | The RF modulation output is turned on; ØM, IQ and Pulse are turned on. |
|  | The RF modulation output is not turned on and none of the modulation functions is turned on. | --  | --   |

**Tip:** Press **MOD** and the AM/FM/ØM/PUL/IQ modulation icons are displayed in the function status area. If a modulation function is turned on (or off), the corresponding icon will be illuminated (or grayed out).



## To Use the Built-in Help System

The DSG800 built-in help system provides the help information of all the function keys and menu softkeys at the front panel. Users can view the help information of any key when operating the instrument.

### 1. Acquire the built-in help information

Press **[?]** and press the desired function key or menu softkey; the help information of the key will be displayed in the instrument interface.

### 2. Page up/down

When the help information is displayed in multiple pages, you can use the arrow keys or knob to switch the help information page.

### 3. Turn off the current help information

When help information is displayed in the instrument interface, pressing any key (except the arrow keys and knob) at the front panel will turn off the help information currently displayed.

### 4. Acquire the help information of a menu softkey

Press **[?]** and the prompt message about how to acquire the help information is displayed in the instrument interface. Then, press the desired menu softkey and the help information of the menu item corresponding to this menu softkey is displayed in the instrument interface.

### 5. Acquire the help information of any function key

Press **[?]** and the prompt message about how to acquire the help information is displayed in the instrument interface. Then, press the desired function key and the help information of the function of the key is displayed in the instrument interface.



## Chapter 2 Front Panel Operations

This chapter introduces each function key at the front panel as well as the menu functions under it in details.

The topics of this chapter:

- To Set the Frequency/LF Parameters
- To Set the Amplitude Parameters
- Sweep
- Modulation
- Store and Recall
- To Set the System Parameters

## To Set the Frequency/LF Parameters

### Frequency

Set the RF output frequency.

Press **FREQ**, use the numeric keyboard to input the frequency value and select the desired unit from the pop-up unit menu.

- The frequency units available are GHz, MHz, kHz and Hz.
- You can press **Backspace** to delete the number at the left of the cursor.
- You can press the left/right arrow key to enter the parameter editing state and move the cursor to the specified digit; then, rotate the knob to modify the value.
- After the frequency is set, you can rotate the knob to modify the frequency at the current step.
- You can press **FREQ** and then press **Step** to set the step.

### LF Output

LF output denotes the output of the low-frequency signal generated by the internal generator of the RF signal generator. The LF output can be one of the two commonly used waveforms (sine or square). You can set the frequency and amplitude of the low-frequency signal.

Press **FREQ** → **LF** to enter the LF output parameter setting menu.

### To Turn on the LF Output

Press **FREQ** → **LF** → **Switch** to turn "On" or "Off" the LF output. When "On" is selected, the LF label and the label of the waveform currently selected (Sine or Square) in the function status area of the user interface are illuminated. At this point, the **[LF OUTPUT]** connector (as shown in the figure below) outputs the LF signal according to the current configuration.

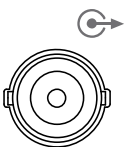

LF OUTPUT

## To Select the LF Waveform

Press **FREQ** → **LF** → **Waveform** to set the waveform of the LF output signal to "Sine" or "Square". The default is "Sine".

## To Set the LF Amplitude

Press **FREQ** → **LF** → **Level** to set the amplitude of the LF signal.

- Use the numeric keyboard to input the amplitude value and select the desired unit from the pop-up unit menu.
- The amplitude units available are V, mV, uV, nV and dBm.
- You can press **Backspace** to delete the number at the left of the cursor.
- You can press the left/right arrow key to enter the parameter editing state and move the cursor to the specified digit; then, rotate the knob to modify the value.
- You can also rotate the knob to modify the amplitude at the current step.
- You can press **Step** to set the step.
- The settable ranges of the amplitudes of sine and square are both from 0 V to 3 V. Note that when the frequency is 0 Hz, the LF output is DC signal and the settable range of the amplitude is from -3 V to 3 V.

## To Set the LF Frequency

Press **FREQ** → **LF** → **Freq** to set the frequency of the LF signal.

- Use the numeric keyboard to input the frequency value and select the desired unit from the pop-up unit menu.
- The frequency units available are GHz, MHz, kHz and Hz.
- You can press **Backspace** to delete the number at the left of the cursor.
- You can press the left/right arrow key to enter the parameter editing state and move the cursor to the specified digit; then, rotate the knob to modify the value.
- After the frequency is set, you can rotate the knob to modify the frequency at the current step.
- You can press **Step** to set the step.

### Explanation

The settable range of sine frequency is from 0 Hz to 200 kHz.  
The settable range of square frequency is from 0 Hz to 20 kHz.

# To Set the Amplitude Parameters

## Amplitude

Set the RF output amplitude.

Press **LEVEL**, use the numeric keyboard to input the amplitude value and select the desired unit from the pop-up unit menu.

- The amplitude units available are dBm, -dBm, mV, uV and nV.
- You can press **Backspace** to delete the number at the left of the cursor.
- You can press the left/right arrow key to enter the parameter editing state and move the cursor to the specified digit; then, rotate the knob to modify the value.
- You can also rotate the knob to modify the amplitude at the current step.
- You can press **LEVEL** and then press **Step** to set the step.

## Flatness Calibration

The flatness calibration function can adjust the RF output amplitudes corresponding to the frequency points within the frequency range of the instrument to compensate for the external loss caused by the cables, switches or other devices. You can load the flatness calibration lists stored in the internal or external memory to DSG800 and view the list contents.

### 1. Set the flatness calibration status

Press **LEVEL** → **Flatness** → **Switch** to turn "On" or "Off" the flatness calibration function. When the flatness calibration function is turned on, the UF status label is displayed in the amplitude area of the user interface.

### 2. Flatness calibration list

Press **LEVEL** → **Flatness** → **Cal List** to enter the flatness calibration list menu.

- Load a list  
Press **Load** to open the store and recall interface. At this point, you can select and read the flatness calibration list files stored. For the detailed operations, refer to "**Store and Recall**". After a list is loaded, the storage directory of the file loaded is displayed in **View**.  
The format of the calibration list file loaded is as shown in the table below. Note that while you edit the value in the flatness calibration list, if no unit is added, then the default frequency unit is mHz and the default amplitude unit is dB.

| SN | Freq               | Level <sup>[1]</sup> |
|----|--------------------|----------------------|
| 1  | 207.854 000 00 MHz | -70.50 dB            |
| 2  | 304.000 000 00 MHz | 7.45 dB              |
| 3  | 800.000 000 00 MHz | -17.80 dB            |

**Note**<sup>[1]</sup>: Amplitude calibration value. When calibrating the amplitude of the current frequency point, only the actual output amplitude will be affected and the amplitude display value will not change.

- View the list  
You can press **View** to view the information of the flatness calibration list currently loaded. Pressing any key (except the arrow keys and knob) at the front panel will return to the flatness calibration list menu.

**Note:** This menu is only valid after a list file is loaded.

## Amplitude Unit

Set the unit of the RF output amplitude.

Press **LEVEL** → **Level Unit** and select the desired unit from the pop-up unit menu. The output amplitude units available are dBm, dBmV, dBuV, Volts and Watts. Wherein, dBm, dBmV and dBuV are logarithmic units; Volts and Watts are linear units. The default is dBm.

## Sweep

When the sweep function is turned on, the RF signal generator outputs RF sweep signal from the **[RF OUTPUT 50Ω]** connector (as shown in the figure below) at the front panel (at this point, the RF output should be turned on).

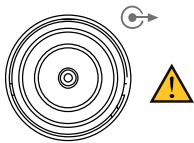

RF OUTPUT 50Ω

## Sweep Manner

DSG800 provides three sweep manners ("Freq", "Level" and "Freq & Lev"). The sweep function is turned on when any of the sweep manners is selected and the Sweep label in the function status area of the user interface is illuminated. By default, the sweep function is turned off.

Press **[SWEEP]** → **Sweep** to select the desired sweep manner.

- Off: the default state. Turn off the sweep function.
- Freq: turn on the frequency sweep function. At this point, the frequency sweep progress bar is displayed in the frequency area in the user interface.
- Level: turn on the amplitude sweep function. At this point, the amplitude sweep progress bar is displayed in the amplitude area in the user interface.
- Freq & Lev: turn on the frequency and amplitude sweep functions at the same time. At this point, the frequency and amplitude sweep progress bars are displayed in the frequency and amplitude areas in the user interface respectively.

## Sweep Direction

Press **[SWEEP]** and use the menu page up/down key  to open the 3/3 page of the menu; then, press **Direct** to select "Fwd" or "Down" and the default is "Fwd".

- Fwd: the RF signal generator sweeps from the start frequency or start level to the stop frequency or stop level. The progress bars in the frequency area and amplitude area in the user interface sweep from left to right.
- Down: the RF signal generator sweeps from the stop frequency or stop level to the start frequency or start level. The progress bars in the frequency area and amplitude area in the user interface sweep from right to left.



## Sweep Type

DSG800 provides two sweep types ("List" and "Step") and the default is "Step".

### List Sweep

#### 1. Select the list sweep mode

Press **SWEEP** → **Type** to select "List". At this point, the RF signal generator sweeps according to the sweep list currently loaded.

#### 2. Sweep list

Press **SWEEP** and use the page up/down key  to open the 2/3 page of the menu; then, press **List Swp** to enter the sweep list menu.

- Load a list

Press **Load** to open the store and recall interface. At this point, you can select and read the sweep list files stored. For the detailed operations, refer to "**Store and Recall**". After a list is loaded, the storage directory of the file loaded is displayed in **View**.

The format of the sweep list file loaded is as shown in the table below. Note that when you edit the value in the sweep list, the unit must be added. If no unit is added, then you may fail to load the list.

| SN | Freq                 | Level <sup>[1]</sup> | Time <sup>[2]</sup> |
|----|----------------------|----------------------|---------------------|
| 1  | 2.000 000 000 10 GHz | -10.00 dBm           | 500.00 ms           |
| 2  | 1.994 152 687 00 GHz | -50.00 dBm           | 500.00 ms           |
| 3  | 1.888 000 000 00 GHz | -60.85 dBm           | 500.00 ms           |

**Note<sup>[1]</sup>**: The amplitude corresponding to the frequency point set.

**Note<sup>[2]</sup>**: The duration of a sweep step.

- View the list

You can press **View** to view the information of the sweep list currently loaded. Pressing any key (except the arrow keys and knob) at the front panel will return to the sweep list menu.

**Note:** This menu is only valid after a list file is loaded.

## Step Sweep

### 1. Select the step sweep mode

Press **[SWEEP]** → **Type** to select "Step". At this point, the RF signal generator performs step sweep according to the current settings.

### 2. Set the sweep parameters

Press **[SWEEP]** and use the menu page up/down key  to open the 2/3 page of the menu; then, press **Step Swp** to set the sweep parameters, such as the start frequency, stop frequency, start level, stop level and number of sweep points.

- **Start Frequency**  
Press **Start Freq**, use the numeric keyboard to input the start frequency value and select the desired unit from the pop-up unit menu. You can press **Backspace** to delete the number at the left of the cursor.
- **Stop Frequency**  
Press **Stop Freq**, use the numeric keyboard to input the stop frequency value and select the desired unit from the pop-up unit menu. You can press **Backspace** to delete the number at the left of the cursor.

#### Explanation

The start frequency and stop frequency are the frequency upper and lower limits of frequency sweep respectively.

- When the sweep direction is forward, the RF signal generator sweeps from the start frequency to the stop frequency.
- When the sweep direction is downward, the RF signal generator sweeps from the stop frequency to the start frequency.

When the "Start Freq" or "Stop Freq" is modified, the RF signal generator will restart the sweep and output from the specified "Start Freq" or "Stop Freq".

- **Start Level**  
Press **Start Lev**, use the numeric keyboard to input the start level value and select the desired unit from the pop-up unit menu. You can press **Backspace** to delete the number at the left of the cursor.
- **Stop Level**  
Press **Stop Lev**, use the numeric keyboard to input the stop level value and select the desired unit from the pop-up unit menu. You can press **Backspace** to delete the number at the left of the cursor.

**Explanation**

The start level and stop level are the amplitude upper and lower limits of amplitude sweep respectively.

- When the sweep direction is forward, the RF signal generator sweeps from the start level to the stop level.
- When the sweep direction is downward, the RF signal generator sweeps from the stop level to the start level.

When the "Start Lev" or "Stop Lev" is modified, the RF signal generator will restart the sweep and output from the specified "Start Lev" or "Stop Lev".

- Number of Sweep Points

Press **Points**, use the numeric keyboard to input the number of sweep points and then press **Enter**. You can press **Backspace** to delete the number at the left of the cursor.

- Dwell Time

The dwell time denotes the duration of a sweep step.

Press **Dwell Time**, use the numeric keyboard to input the time value and select the desired unit from the pop-up unit menu. You can press **Backspace** to delete the number at the left of the cursor.

- Sweep Space

The sweep space denotes the mode in which the instrument changes from one frequency or amplitude to another within one step.

Press **Swp Space** to select "Log" or "Lin" sweep space. Note that level sweep only supports "Lin" sweep space.

- Sweep Shape

The sweep shape denotes the cycle mode of multiple sweeps.

Press **Shape** to select "Ramp" or "Triangle" sweep shape. When the sweep direction is "Fwd", the "Ramp" and "Triangle" sweep shapes are as shown in the figure below.

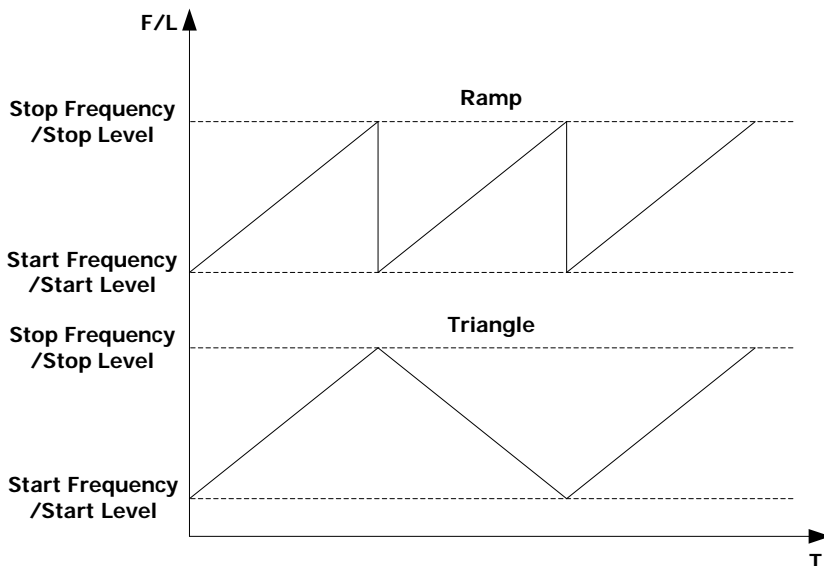

**Ramp:** the sweep period always starts from the start frequency or start level to the stop frequency or stop level and the sweep sequence is similar to a ramp waveform.

**Triangle:** the sweep period always starts from the start frequency or start level to the stop frequency or stop level and then returns back to the start frequency or start level. The sweep sequence is similar to a triangle waveform.

## Sweep Mode

Press **SWEEP** → **Mode** to select "Cont" or "Single" sweep and the default is "Cont".

- **Cont:** when continuous sweep is selected, the continuous sweep label is displayed in the frequency or amplitude area in the user interface. When the trigger condition is met, the instrument sweeps continuously according to the current setting.
- **Single:** when single sweep is selected, the single sweep label is displayed in the frequency or amplitude area in the user interface. When the trigger condition is met, the instrument performs a single sweep according to the current setting and then stops.

## Single Sweep

If the current sweep mode is "Cont", press **Single** to switch the sweep mode to "Single" and the instrument will perform a single sweep if the trigger condition is

met.

If the current sweep mode is "Single", press **Single** and the instrument will perform a single sweep if the trigger condition is met.

## To Reset the Sweep

If the current sweep direction is "Fwd", press **Reset Swp**, the instrument stops the current sweep and restarts the sweep from the start frequency or start level.

If the current sweep direction is "Down", press **Reset Swp**, the instrument stops the current sweep and restarts the sweep from the stop frequency or stop level.

## Trigger Mode

### 1. Trigger Mode

Select the trigger mode of the whole sweep period.

Press **SWEEP** and use the menu page up/down key  to open the 2/3 page of the menu; then, press **Trig Mode** to select "Auto", "Key", "Bus" or "Ext" trigger.

**Note:** The following descriptions are valid when the trigger mode of each sweep point in the sweep period is met.

- **Auto Trigger**  
The default mode is auto. If the sweep mode is set to "Cont", the instrument will start sweeping once a sweep manner is selected. If the sweep mode is set to "Single", you need to press **Single** to meet the single sweep condition; after that, the instrument will start a sweep and then stops.
- **Key Trigger**  
When "Key" trigger is selected, if the sweep mode is set to "Cont", the instrument starts a sweep each time **Key Trig** is pressed; if the sweep mode is set to "Single", you need to press **Single** to meet the single sweep condition and after that, the instrument starts a sweep and then stops each time **Key Trig** is pressed.
- **Bus Trigger**  
When "Bus" trigger is selected, if the sweep mode is set to "Cont", the instrument starts a sweep each time the "\*\*TRG" command is sent; if the sweep mode is set to "Single", you need to press **Single** to meet the single sweep condition and after that, the instrument starts a sweep and then

stops each time the "\*TRG" command is sent.

- External Trigger

In external trigger, the RF signal generator receives the trigger signal input from the **[TRIGGER IN]** connector (as shown in the figure on the next page) at the rear panel. If the sweep mode is set to "Cont", the instrument starts a sweep each time a TTL pulse signal with the specified polarity is received. If the sweep mode is set to "Single", you need to press **Single** to meet the single sweep condition; after that, the instrument starts a sweep and then stops each time a TTL pulse signal with the specified polarity is received.

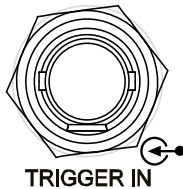

To specify the polarity of the TTL pulse signal, press **Trig Slope** to select "Pos" or "Neg" and the default is "Pos".

## 2. Point Trigger Mode

Select the trigger mode of each sweep point in a sweep period.

Press **[SWEEP]** and use the menu page up/down key  to open the 2/3 page of the menu; then, press **Point Trig** to select "Auto", "Key", "Bus" or "Ext" trigger.

**Note:** The following descriptions are valid when the trigger mode of the corresponding sweep period is met.

- Auto Trigger

The default mode is auto. If the sweep mode is set to "Cont", the instrument will start sweeping each sweep point continuously within a sweep period once a sweep manner is selected. If the sweep mode is set to "Single", you need to press **Single** to meet the single sweep condition; after that, the instrument starts to sweep and then stops after the sweep period expires.

- Key Trigger

When "Key" trigger is selected, if the sweep mode is set to "Cont", the instrument starts to sweep a point each time **Key Trig** is pressed; if the sweep mode is set to "Single", you need to press **Single** to meet the single sweep condition and after that, the instrument starts to sweep a point and then stops after the sweep period expires each time **Key Trig** is pressed.

- **Bus Trigger**  
When "Bus" trigger is selected, if the sweep mode is set to "Cont", the instrument starts to sweep a point each time the "\*TRG" command is sent; if the sweep mode is set to "Single", you need to press **Single** to meet the single sweep condition and after that, the instrument starts to sweep a point and then stops after the sweep period expires each time the "\*TRG" command is sent.
- **External Trigger**  
In external trigger mode, the RF signal generator receives the trigger signal input from the **[TRIGGER IN]** connector (as shown in the figure below) at the rear panel. If the sweep mode is set to "Cont", the instrument starts to sweep a point each time a TTL pulse signal with the specified polarity is received. If the sweep mode is set to "Single", you need to press **Single** to meet the single sweep condition; after that, the instrument starts to sweep a point and then stops after the sweep period expires each time a TTL pulse signal with the specified polarity is received.

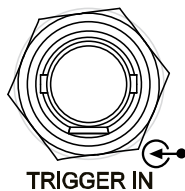

To specify the polarity of the TTL pulse signal, press **Trig Slope** to select "Pos" or "Neg" and the default is "Pos".

### Explanation

When executing the sweep operation, the priority order of the conditions is Single Sweep → Trigger Mode → Point Trigger Mode. For example, when both the trigger mode and point trigger mode are set to "Key" trigger:

- In "Cont" sweep mode, you need to press **Key Trig** to meet the trigger mode of the whole period and then press **Key Trig** again to meet the trigger mode of the points within the sweep period; then, the instrument starts to sweep.
- In "Single" sweep mode, you need to press **Single** to meet the single sweep condition and then press **Key Trig** twice to meet the sweep period trigger mode and point trigger mode respectively; then, the instrument starts to sweep.

# Modulation

## Amplitude Modulation (AM)

During amplitude modulation (AM), the modulating signal changes the amplitude of the RF carrier waveform linearly.

Press **MOD** → **AM** to enter the amplitude modulation parameter setting menu.

### To Turn on Amplitude Modulation

Press **Switch** to select "On" or "Off".

- On: turn on the AM function. The AM label in the function status area in the user interface is illuminated.
- Off: turn off the AM function and this is the default state.

**Note:** If a sweep manner is selected and the step sweep time is lower than 30 ms, "You can turn on the AM when sweep time is greater than 30ms" will be displayed in the user interface when amplitude modulation is turned on.

### To Select the Modulation Source

Press **Source** to select "Int" or "Ext" modulation source.

#### 1. Internal Source

When "Int" is selected, the internal modulation source is turned on. At this point, the instrument provides the modulating signal and you can set the modulation frequency and modulation waveform of the modulating signal.

#### 2. External Source

When "Ext" is selected, **Freq** and **Waveform** are grayed out and disabled. The RF signal generator receives the external modulating signal input from the **[EXT MOD IN]** connector (as shown in the figure below) at the rear panel. This modulating signal can be any waveform.

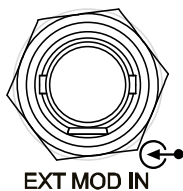

**Note:** The input amplitude of the external modulating signal cannot exceed  $\pm 3$  V (HighZ). To ensure the modulation performance, the input amplitude of the external modulating signal should be less than 1 Vpp.



## To Set the Modulation Depth

The modulation depth denotes the extent of output amplitude variation and is expressed as a percentage. The range of AM modulation depth is from 0% to 100%.

Press **Depth** to set the AM modulation depth.

### 1. When "Int" modulation source is selected

The AM modulation depth ( $m_a$ ) and the amplitude difference ( $\Delta P_{sb}$ ) between the carrier and sidebands satisfy the following relation.

$$\Delta P_{sb} = 6 - 20 \lg m_a$$

- When the modulation depth is 0%, the instrument outputs a carrier signal with a single frequency point.
- The greater the modulation depth is, the smaller the difference between the output amplitude and carrier amplitude will be.

### 2. When "Ext" modulation source is selected

- 100% modulation depth refers to the modulation depth corresponding to 1 Vpp input amplitude of the external modulation source.
- When the input amplitude of the external modulation source is 0.5 Vpp, the modulation depth actually measured is 50%.

## To Select the Modulation Waveform

Press **Source** to select "Int" modulation source; press **Waveform** to select "Sine" or "Square" and the default is "Sine".

**Note:** When "Ext" modulation source is selected, this menu is grayed out and disabled.

## To Set the Modulation Frequency

Press **Source** to select "Int" modulation source; press **Freq** to set the modulation frequency.

- Use the numeric keyboard or knob to input the desired frequency value.
- For sine waveforms, the range of the modulation frequency is from 10 Hz to 100 kHz.
- For square waveforms, the range of the modulation frequency is from 10 Hz to 20 kHz.

**Note:** When "Ext" modulation source is selected, this menu is grayed out and disabled.

## External Coupling

Press **EXT Coup** to select "AC" or "DC" coupling and the default is "AC".

- When "AC" is selected: the DC components of the external signal input from the **[EXT MOD IN]** connector at the rear panel of the instrument will be blocked and the AC components can pass through the connector. The external modulation input port is similar to a high-pass filter which low cutoff frequency is less than 5 Hz.
- When "DC" is selected: all the AC components and DC components of the external input signal can pass through the connector.

**Note:** When "Int" modulation source is selected, this menu is grayed out and disabled.

## Input Impedance

Press **Impedance** to select "50ohm", "600ohm" or "100kohm ". You can set the impedance of the **[EXT MOD IN]** input channel.

**Note:** When "Int" modulation source is selected, this menu is grayed out and disabled.

## Frequency Modulation (FM)

During frequency modulation (FM), the modulating signal changes the frequency of the RF carrier waveform.

Press **MOD** → **FM/ØM** to enter the frequency/phase modulation parameter setting menu.

### To Turn on Frequency Modulation

Press **FM/ØM** to select "FM" and then press **Switch** to select "On" or "Off".

- On: turn on the FM function. The FM label in the function status area in the user interface is illuminated.
- Off: turn off the FM function and this is the default state.

**Note:** The frequency modulation and phase modulation cannot be turned on at the same time. In addition, if a sweep manner is selected and the step sweep time is lower than 200 ms, "You can turn on the FM or ØM when sweep time is greater than 200ms" will be displayed in the user interface when frequency modulation is turned on.

### To Select the Modulation Source

Press **Source** to select "Int" or "Ext" modulation source.

#### 1. Internal Source

When "Int" is selected, the internal modulation source is turned on. At this point, the instrument provides the modulating signal and you can set the modulation rate and modulation waveform of the modulating signal.

#### 2. External Source

When "Ext" is selected, **Rate** and **Waveform** are grayed out and disabled. The RF signal generator receives the external modulating signal input from the **[EXT MOD IN]** connector (as shown in the figure below) at the rear panel. This modulating signal can be any waveform.

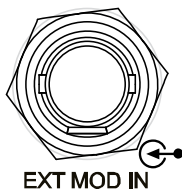

**Note:** The input amplitude of the external modulating signal cannot exceed  $\pm 3$  V (HighZ). To ensure the modulation performance, the input amplitude of the external modulating signal should be less than 1 Vpp.

## To Set the Frequency Deviation

The frequency deviation is the deviation of the frequency of the modulating waveform relative to that of the carrier waveform and the unit is Hz.

Press **Deviation** to set the FM frequency deviation.

- Use the numeric keyboard or knob to input the desired frequency value.
- For different carrier frequencies, the maximum frequency deviations are different.

## To Select the Modulation Waveform

Press **Source** to select "Int" modulation source; use the menu page up/down key  to open the 2/2 page of the menu; press **Waveform** to select "Sine" or "Square" and the default is "Sine".

**Note:** When "Ext" modulation source is selected, this menu is grayed out and disabled.

## To Set the Modulation Frequency

Press **Source** to select "Int" modulation source; press **Rate** to set the modulation frequency.

- Use the numeric keyboard or knob to input the desired frequency value.
- For sine waveforms, the range of the modulation frequency is from 10 Hz to 100 kHz.
- For square waveforms, the range of the modulation frequency is from 10 Hz to 20 kHz.

**Note:** When "Ext" modulation source is selected, this menu is grayed out and disabled.

## External Coupling

Press **EXT Coup** to select "AC" or "DC" coupling and the default is "AC".

- When "AC" is selected: the DC components of the external signal input from the **[EXT MOD IN]** connector at the rear panel of the instrument will be blocked and the AC components can pass through the connector. The external modulation input port is similar to a high-pass filter which low cutoff frequency is less than 5 Hz.
- When "DC" is selected: all the AC components and DC components of the external input signal can pass through the connector.

**Note:** When "Int" modulation source is selected, this menu is grayed out and disabled.

## Input Impedance

Press **Impedance** to select "50ohm", "600ohm" or "100kohm ". You can set the impedance of the **[EXT MOD IN]** input channel.

**Note:** When "Int" modulation source is selected, this menu is grayed out and disabled.

## Phase Modulation (ØM)

During phase modulation (ØM), the modulating signal changes the phase of the RF carrier waveform.

Press **MOD** → **FM/ØM** to enter the frequency/phase modulation parameter setting menu.

### To Turn on Phase Modulation

Press **FM/ØM** to select "ØM" and then press **Switch** to select "On" or "Off".

- On: turn on the ØM function. The ØM label in the function status area in the user interface is illuminated.
- Off: turn off the ØM function and this is the default state.

**Note:** The frequency modulation and phase modulation cannot be turned on at the same time. In addition, if a sweep manner is selected and the step sweep time is lower than 200 ms, "You can turn on the FM or ØM when sweep time is greater than 200ms" will be displayed in the user interface when phase modulation is turned on.

### To Select the Modulation Source

Press **Source** to select "Int" or "Ext" modulation source.

#### 1. Internal Source

When "Int" is selected, the internal modulation source is turned on. At this point, the instrument provides the modulating signal and you can set the modulation rate and modulation waveform of the modulating signal.

#### 2. External Source

When "Ext" is selected, **Rate** and **Waveform** are grayed out and disabled. The RF signal generator receives the external modulating signal input from the **[EXT MOD IN]** connector (as shown in the figure below) at the rear panel. This modulating signal can be any waveform.

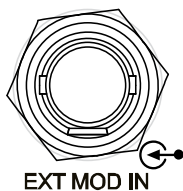

**Note:** The input amplitude of the external modulating signal cannot exceed  $\pm 3$  V (HighZ). To ensure the modulation performance, the input amplitude of the external modulating signal should be less than 1 Vpp.

## To Set the Phase Deviation

The phase deviation is the deviation of the phase of the modulating waveform relative to that of the carrier waveform and the unit is rad.

Press **Deviation** to set the  $\emptyset$ M phase deviation.

- Use the numeric keyboard or knob to input the desired phase value.
- For different carrier frequencies, the maximum phase deviations are different.

## To Select the Modulation Waveform

Press **Source** to select "Int" modulation source; use the menu page up/down key  to open the 2/2 page of the menu; press **Waveform** to select "Sine" or "Square" and the default is "Sine".

**Note:** When "Ext" modulation source is selected, this menu is grayed out and disabled.

## To Set the Modulation Frequency

Press **Source** to select "Int" modulation source; press **Rate** to set the modulation frequency.

- Use the numeric keyboard or knob to input the desired frequency value.
- For sine waveforms, the range of the modulation frequency is from 10 Hz to 100 kHz.
- For square waveforms, the range of the modulation frequency is from 10 Hz to 20 kHz.

**Note:** When "Ext" modulation source is selected, this menu is grayed out and disabled.

## External Coupling

Press **EXT Coup** to select "AC" or "DC" coupling and the default is "AC".

- When "AC" is selected: the DC components of the external signal input from the **[EXT MOD IN]** connector at the rear panel of the instrument will be blocked and the AC components can pass through the connector. The external modulation input port is similar to a high-pass filter which low cutoff frequency is less than 5 Hz.
- When "DC" is selected: all the AC components and DC components of the external input signal can pass through the connector.

**Note:** When "Int" modulation source is selected, this menu is grayed out and disabled.

## Input Impedance

Press **Impedance** to select "50ohm", "600ohm" or "100kohm ". You can set the impedance of the **[EXT MOD IN]** input channel.

**Note:** When "Int" modulation source is selected, this menu is grayed out and disabled.



## Pulse Modulation (Option DSG800-PUM)

During pulse modulation, the RF carrier waveform is modulated by the pulse signal.

Press **MOD** → **Pulse Mod** to enter the pulse modulation parameter setting menu.

### To Turn on Pulse Modulation

Press **Switch** to select "On" or "Off".

- On: turn on the pulse modulation function. The PUL label in the function status area in the user interface is illuminated.
- Off: turn off the pulse modulation function and this is the default state.

**Note:** If a sweep manner is selected and the step sweep time is lower than 50 ms, "You can turn on the Pulse Modulation when sweep time is greater than 50ms" will be displayed in the user interface when pulse modulation is turned on.

### To Select the Modulation Source

Press **Source** to select "Ext" or "Int" modulation source.

#### 1. Internal Source

When "Int" is selected, the internal modulation source is turned on. At this point, the internal pulse generator of the instrument provides the modulating signal and you can set the pulse mode, pulse period and pulse width of the modulating signal.

#### 2. External Source

When "Ext" is selected, **Mode**, **Period**, **Width**, **Trig Mode** and **Pulse Out** are grayed out and disabled. The RF signal generator receives the external pulse signal input from the **[PULSE IN/OUT]** connector (as shown in the figure below) at the rear panel as the modulating signal.

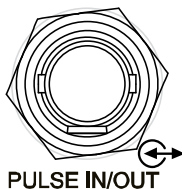

## To Select the Pulse Mode

Press **Source** to select "Int" modulation source; press **Mode** to select "Single" or "Train (option DSG800-PUG)".

- Single: only a single pulse signal is generated for a pulse period. This is the default pulse mode.
- Train: multiple pulse signals are generated for a pulse period. At this point, **Period** and **Width** are grayed out and disabled. You can press **Train List** to load or view the desired pulse train.

**Note:** When "Ext" modulation source is selected, this menu is grayed out and disabled. To use the "Train" pulse mode, you need to install the option DSG800-PUG. For the specific installation methods, please refer to "**License**".

## To Set the Pulse Period

The pulse period is the time interval between two neighboring pulses in periodically-repetitive pulse train.

Press **Source** to select "Int" modulation source; press **Period** to set the period of the "Single" pulse modulating signal.

- Use the numeric keyboard to input the desired value and select the desired unit from the pop-up unit menu.
- You can press **Backspace** to delete the number at the left of the cursor.
- You can also use the knob to modify this parameter.
- The range of the pulse period is from 40 ns to 170 s.
- The pulse period determines the repeating frequency of the internal pulse modulating signal.

**Note:** When "Ext" modulation source or "Train" pulse mode is selected, this menu is grayed out and disabled.

## To Set the Pulse Width

The pulse width is the time that the pulse holds at the maximum value.

Press **Source** to select "Int" modulation source; press **Mode** to select "Single". The single pulse is as shown in the figure below.

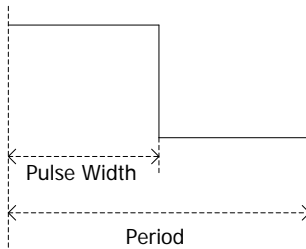

Press **Width** to set the width of the single-pulse modulating signal.

- Use the numeric keyboard or knob to input the desired pulse width value.
- The range of the pulse width is from 10 ns to (170 s - 10 ns).
- The pulse width is limited by the minimum pulse width and pulse period.  
 $\text{Pulse Width} \geq \text{Minimum Pulse Width}$   
 $\text{Pulse Width} \leq \text{Pulse Period} - 10 \text{ ns}$

**Note:** When "Ext" modulation source or "Train" pulse mode is selected, this menu is grayed out and disabled. For the "Train" pulse width and the settings of the related parameters, refer to "**Train List**".

## To Select the Trigger Mode

Press **Source** to select "Int" modulation source; press **Trig Mode** to select "Auto", "Ext Trig", "Ext Gate", "Key" or "Bus" trigger mode.

- **Auto**  
 The default mode is auto. The RF signal generator meets the trigger condition at any time and will start the pulse modulation once the pulse modulation function is turned on.
- **External Trigger**  
 In external trigger, the RF signal generator receives the external trigger signal input from the **[TRIGGER IN]** connector (as shown in the figure on the next page) at the rear panel. The instrument starts a pulse modulation each time a TTL pulse with the specified polarity is received. To specify the polarity of the TTL pulse, press **Trig Slope** to select "Pos" or "Neg" and the default is "Pos".



- **External Gate**

In external gate mode, the RF signal generator receives the external gated signal input from the **[TRIGGER IN]** connector at the rear panel. The instrument starts a pulse modulation within the valid level range each time a gated signal with the specified polarity is received (as shown in the figure below). To specify the polarity of the external gated signal, press **Gate Polar** to select "Normal" or "Inverse" and the default is "Normal".

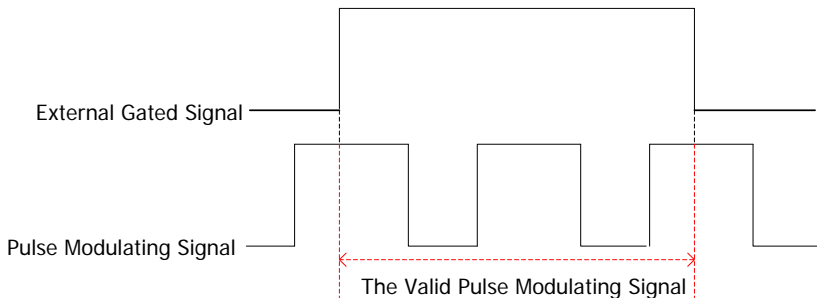

- **Key Trigger**

In key trigger mode, the instrument starts a pulse modulation each time **Key Trig** is pressed.

- **Bus Trigger**

In bus trigger mode, the instrument starts a pulse modulation each time the "\*TRG" command is sent.

**Note:** When "Ext" modulation source is selected, the above-mentioned menus are grayed out and disabled.

## Pulse Output

Press **Source** to select "Int" modulation source; press **Pulse Out** to select "On" or "Off".

- On: turn on the pulse output function. At this point, the RF signal generator can output the pulse signal generated by the internal pulse generator from the **[PULSE IN/OUT]** connector at the rear panel. Note that this output signal is related to the pulse **Mode** setting.

- Off: turn off the pulse output function and this is the default state.

**Note:** When "Ext" modulation source is selected, this menu is grayed out and disabled.

## Trigger Delay

Press **Source** to select "Int" modulation source and select "Ext Trig" mode; press **Trigger Delay** to set the delay from when the pulse modulating signal receives the external trigger signal to the start of the #1 pulse of the pulse modulating signal, as shown in the figure below.

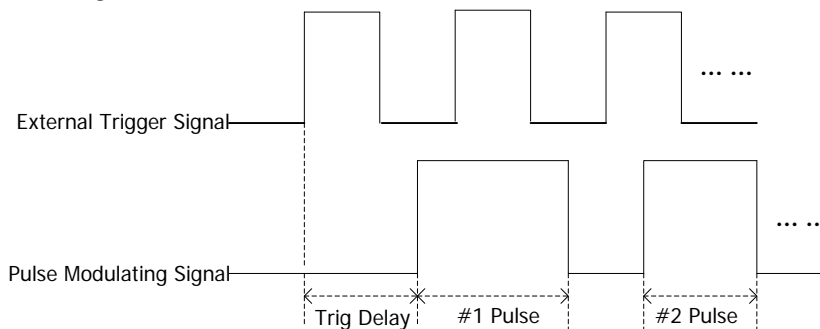

- Use the numeric keyboard or knob to input the desired trigger delay value.
- The range of the trigger delay is from 10 ns to 170 s.

**Note:** When "Ext" modulation source is selected, this menu is grayed out and disabled.

## To Set the Polarity

Press **Polarity** to select "Normal" or "Inverse" to set the polarity of the current pulse modulating signal and the default is "Normal".

## Train List

Press **Train List** to enter the train list menu.

- Load a list  
Press **Load** to open the store and recall interface. At this point, you can select and read the train list files stored. For the detailed operations, refer to "**Store and Recall**". After a list is loaded, the storage directory of the file loaded is displayed in **View**.

The format of the train list file loaded is as shown in the table below. Note that when you edit the value in the train list, if no unit is added, then the default time unit is us.

| SN <sup>[1]</sup> | OnTime <sup>[2]</sup> | OffTime <sup>[3]</sup> | Repeat <sup>[4]</sup> | DwellTime <sup>[5]</sup> |
|-------------------|-----------------------|------------------------|-----------------------|--------------------------|
| 1                 | 4.00 ms               | 5.00 ms                | 2                     | 18.00 ms                 |
| 2                 | 2.00 ms               | 4.00 ms                | 5                     | 30.00 ms                 |
| 3                 | 15.55 ms              | 100.5 us               | 2                     | 31.30 ms                 |

**Note<sup>[1]</sup>:** The number of the pulse set.

**Note<sup>[2]</sup>:** The duration of the high level corresponding to the pulse set.

**Note<sup>[3]</sup>:** The duration of the low level corresponding to the pulse set.

**Note<sup>[4]</sup>:** The number of repetitions of the pulse set.

**Note<sup>[5]</sup>:** The duration of the pulse currently set.

The pulse train (the number of repetitions of pulse 1 is 2) loaded is as shown in the figure below.

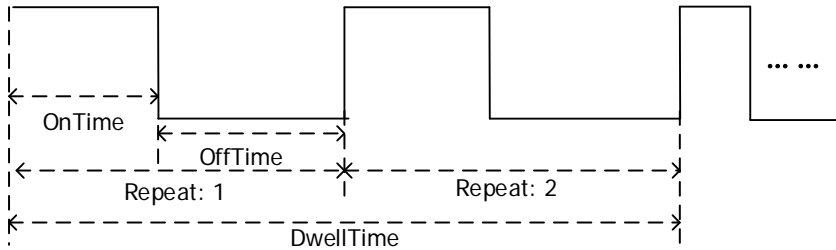

- View the list  
You can press **View** to view the information of the train list currently loaded. Pressing any key (except the arrow keys and knob) at the front panel will return to the train list menu.

**Note:** This menu is only valid after a train list file is loaded.

**Tip:** To load or view the train list, you need to install the option DSG800-PUG. For the installation methods, refer to "**License**".

## I/Q Modulation (Only Available for DSG821A/DSG836A)

I/Q modulation can improve the spectrum utilization. In I/Q modulation, two orthogonal signals (carriers with the same frequency and 90° phase deviation, generally expressed as Sin and Cos) are modulated with the I (In-Phase components) and Q (Quadrature Phase components) signals respectively and then they are transmitted together.

Press **MOD** → **I/Q Mod** to enter the I/Q modulation parameter setting menu.

### To Turn on I/Q Modulation

Press **Switch** to select "On" or "Off".

- On: turn on the I/Q modulation function. The IQ label in the function status area in the user interface is illuminated.
- Off: turn off the I/Q modulation function and this is the default state.

**Note:** The amplitude modulation function and I/Q modulation function cannot be turned on at the same time. If a sweep manner is selected and the step sweep time is lower than 50 ms, "You can turn on the IQ Modulation when sweep time is greater than 50ms" will be displayed in the user interface when I/Q modulation is turned on.

### To Select the Modulation Source

Press **Source** to select "Int" or "Ext" modulation source.

#### 1. Internal Source

When "Int" is selected, the built-in baseband generator (wavetable) of the instrument provides the modulating signal. At this point, if I/Q modulation is already turned on, the baseband output will be turned "On" automatically. The RF signal generator will output the I (In-Phase) components and Q (Quadrature Phase) components of the I/Q modulation baseband signal from the **[I OUT]** and **[Q OUT]** connectors (as shown in the figures below) at the rear panel respectively.

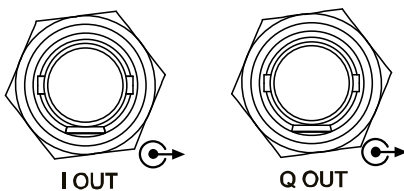

## 2. External Source

When "Ext" is selected, the RF signal generator receives the in-phase baseband signal and quadrature phase modulating signal of I/Q modulation input from the **[I IN]** and **[Q IN]** connectors (as shown in the figures below) at the rear panel respectively.

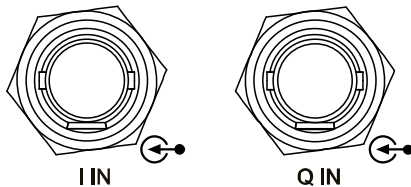

**Tip:** When an external baseband signal is input and the baseband output is turned "On", the instrument can output the I (In-Phase) components and Q (Quadrature Phase) components of the I/Q modulation baseband signal generated by the built-in baseband generator (wavetable) from the **[I OUT]** and **[Q OUT]** connectors at the rear panel respectively.

## Baseband Signal

### 1. Baseband Output

Press **BaseBand** → **Switch** to select "On" or "Off".

- On: turn on the baseband output function. The RF signal generator outputs the I (In-Phase) and Q (Quadrature Phase) components of the I/Q modulation baseband signal from the **[I OUT]** and **[Q OUT]** connectors at the rear panel respectively.
- Off: turn off the baseband output function.

### 2. Baseband Level

Press **BaseBand** → **Level** to set the amplitude of the baseband output signal.

- Use the numeric keyboard to input the amplitude value and select the desired unit from the pop-up unit menu.
- The amplitude units available are V, mV,  $\mu$ V, nV and dBm.
- You can press **Backspace** to delete the number at the left of the cursor.
- You can press the left/right arrow key to enter the parameter editing state and move the cursor to the specified digit; then, rotate the knob to modify the parameter value.
- You can also rotate knob to modify the amplitude at the current step.
- You can press **Step** to set the step.

### 3. ARB



Press **BaseBand** → **ARB** to enter the store and recall interface. At this point, "You can load the ARB files" is displayed in the user interface. Press the right arrow key to unfold the current directory and select the ARB file (namely wavetable file; the format is \*.arb) to be loaded. Then, press **Recall** to load this file. "File loading succeeded" is displayed after the file is loaded. For more information about how to load a file, please refer to "Store and Recall".

**Tip:**

The loadable ARB files should be edited and downloaded to DSG800 using the Ultra IQ Station PC software. For more information about how to download the ARB file, please refer to *Ultra IQ Station\_Help Document*.

#### 4. Clock Frequency

Press **BaseBand** → **Clock Freq**; you can use the numeric keyboard or knob to modify the clock frequency of ARB output.

- The units available are GHz, MHz, kHz and Hz.
- You can press **Backspace** to delete the number at the left of the cursor.
- You can press the left/right arrow key to enter the parameter editing state and move the cursor to the specified digit; then, rotate the knob to modify the parameter value.
- You can also rotate the knob to modify the clock frequency at the current step.
- You can press **Step** to set the step.

**Note:** When loading the ARB file, this value will be automatically set to the clock frequency defined for the current ARB file.

#### 5. Trigger

##### 1) Trigger Mode

Select the trigger mode of the I/Q modulation baseband output.

Press **Trig Mode** to select "Auto", "Key", "Bus" or "Ext".

- Auto Trigger  
This is the default mode. The RF signal generator fulfills the trigger condition at any time and outputs the I/Q baseband signal continuously.
- Key Trigger  
When "Key" trigger mode is selected, the instrument will output the baseband signal each time **Key Trig** is pressed.
- Bus Trigger  
When "Bus" trigger mode is selected, the instrument will output the

baseband signal each time the "\*TRG" command is sent.

- External Trigger  
When "Ext" trigger mode is selected, the RF signal generator receives the external trigger signal input from the **[TRIGGER IN]** connector (as shown in the figure below) at the rear panel. The instrument will output the baseband signal each time a TTL pulse signal with the specified polarity is received.

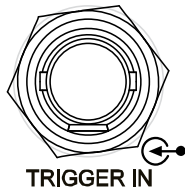

## 2) Operation Mode

Select the operation mode after the I/Q modulation baseband signal is triggered.

Press **Opt Mode** to select "Retrig", "Arm Auto", "Arm Retrig" or "Single".

**Note:** When "Auto" trigger mode is selected, this menu is grayed out and disabled.

- Retrigger  
When the "Retrig" mode is selected, the instrument outputs the baseband signal continuously and restarts to output the signal each time a trigger is received.
- Arm Auto  
When the "Arm Auto" mode is selected, the instrument starts outputting the signal continuously each time a trigger is received until "**Arm ARB**" is selected and then waits for the next trigger.
- Arm Retrigger  
When the "Arm Retrig" mode is selected, the instrument starts outputting the signal continuously each time a trigger is received; the instrument restarts outputting the signal when another trigger is received until "**Arm ARB**" is selected and then waits for the next trigger.
- Single  
When the "Single" mode is selected, the instrument outputs the specified length (specified in "**Duration**") of waveform each time a trigger is received and then stops to wait for the next trigger.

### 3) Arm ARB

Press **Arm ARB** to stop the waveform output manually and wait for the next trigger.

**Note:** This menu is valid only when the operation mode after the I/Q baseband signal is triggered is set to "Arm Auto" or "Arm Retrig".

### 4) Duration Unit

You can press **Dur Unit** to set the duration unit of the IQ modulation wavetable when "Single" trigger is selected.

- SL: trigger by the waveform segment.
- SA: trigger by the data point.

**Note:** This menu is valid when the operation mode after the I/Q modulation baseband signal is triggered is "Single".

### 5) Duration

Press **Duration** to set the duration of the signal in "Single" trigger.

**Note:** This menu is only available when the operation mode after the I/Q modulation baseband signal is triggered is set to "Single". Besides, this value defines the number of points ( $N_r$ ) within the duration and the instrument acquires the actual time ( $T_r$ ) according to the current sample rate ( $S_a$ ). They satisfy the following relation:  $T_r = N_r / S_a$ .

### 6) External Delay

Press **Ext Delay** to set the delay of the response to the trigger when the external trigger signal is received.

**Note:** This menu is only available when the trigger mode of the baseband output of I/Q modulation is set to "Ext". This value defines the number of points ( $N_d$ ) and the instrument acquires the actual delay time ( $T_d$ ) according to the current sample rate ( $S_a$ ). They satisfy the following relation:  $T_d = N_d / S_a$ .

### 7) External Inhibit

Press **Ext Inhibit** to set the time from when an external trigger signal is received to when the instrument receives the next trigger signal.

**Note:** This menu is only available when the trigger mode of the baseband output of I/Q modulation is set to "Ext". This value defines the number of points ( $N_i$ ) and the instrument acquires the actual inhibit time ( $T_i$ ) according to the current sample rate ( $S_a$ ). They satisfy the following

relation:  $T_i = N_i / S_a$  .

## 8) Segment Trigger Mode

Set the trigger mode of the I/Q data segment.

Press **Seg Mode** to select "Same Seg", "Next Seg", "Seamless" or "Sequencer".

- Same Segment  
When the "Same Seg" trigger mode is selected, the instrument outputs the same trigger segment. When **Next Seg** is modified, the output segment will change accordingly.
- Next Segment  
When the "Next Seg" trigger mode is selected, the instrument will switch to the output of the next segment when **Execute Seg** is pressed. You can also output the corresponding segment of the waveform by modifying **Next Seg**.
- Seamless  
When the "Seamless" trigger mode is selected, the instrument will switch to the output of the next segment seamlessly when **Execute Seg** is pressed. This menu is only valid when the sample rates of all the waveform segments in the "Segment" file loaded are the same.
- Sequencer  
When the "Sequencer" trigger mode is selected, the instrument outputs each waveform segment according to the "Seg List" (\*.SEQ) file or "Seg csv" (\*.CSV) file loaded. At this point, **Next Seg** and **Execute Seg** are grayed out and disabled. This menu is valid only when the "Seg List" (\*.SEQ) file or "Seg csv" (\*.CSV) file is loaded.

**Note:** The above menus are valid only when the "Segment" (.SEG) file is loaded.

## 9) Next Segment

You can press **Next Seg** to set the number of the next segment of the ARB.

## 10) Execute Segment

You can press **Execute Seg** to execute the trigger of the next segment.

This menu is only valid when the segment trigger mode is set to "Next Seg" or "Seamless".

## Store and Recall

DSG800 allows users to store various types of files to the internal or external memory and recall them when required.

DSG800 provides a local memory (D disk) and an external memory (E disk).

- D disk: provide storage locations for state file, train csv file, flatness csv file, sweep csv file and etc.
- E disk: available when a USB storage device is detected at the USB HOST interface at the rear panel (the types of files can be stored in the USB storage device are the same with those of the D disk).

Press **Save** at the front panel to enter the store and recall interface as shown in Figure 2-1.



Figure 2-1 Store and Recall Interface

**Note:** DSG800 can recognize files with filenames consisting of Chinese characters, English characters and numbers. If other characters are used in the file or folder name, the file or folder name might not be displayed normally in the store and recall interface.

## File Type

In the store and recall interface, rotate the knob to select the desired storage directory (available when a USB storage device is detected; it is used to switch between D disk and E disk); then, press the right arrow key to unfold the current directory. Press **File Type** to select the desired file type.

The file types available are "All", "State", "Arb", "Flat csv", "Swp csv", "Train csv", "Segment", "Seg List" and "Seg csv". The default is "All". The description of each file type is as shown in the table below.

| File Type | Format | Suffix | Explanation  |
|-----------|--------|--------|--|
| State     | BIN    | .STA   | Store the current system state in binary format.   |
| Arb       | BIN    | .arb   | The arbitrary waveform <sup>[1]</sup> wavetable file stored in binary format. You can load the file when necessary.                        |
| Flat csv  | CSV    | .CSV   | The flatness list file stored in csv format. You can open the file using Excel on the PC to view the list information.                     |
| Swp csv   | CSV    | .CSV   | The sweep list file stored in csv format. You can open the file using Excel on the PC to view the list information.                        |
| Train csv | CSV    | .CSV   | The train list file stored in csv format. You can open the file using Excel on the PC to view the list information.                        |
| Segment   | BIN    | .SEG   | The Multisegment <sup>[1]</sup> wavetable file stored in binary format. You can load the file when necessary.                              |
| Seg List  | BIN    | .SEQ   | The Multisequence <sup>[1]</sup> list file stored in binary format. You can load the file when necessary.                                  |
| Seg csv   | CSV    | .CSV   | The Multisequence <sup>[1]</sup> list file stored in csv format. You can open the file using Excel on the PC to view the list information. |

**Note**<sup>[1]</sup>: The wavetable files should be edited and downloaded to the RF signal generator via the Ultra IQ Station PC software.

**Tip:** You can generate csv format files using Excel on the PC. Then, you can open the file, edit the required parameter values (the unit is required to be added) according to the corresponding file format requirements directly in the Excel table and save it to a USB storage device. In addition, you can also load the file to the RF signal generator when required.

## Save

### 1. Select the file type

Please select the desired file type according to the introduction in "File Type".

**Note:** If **File Type** is currently set to "All", the save operation is not available.

### 2. Open the filename editing interface

Press **Save** to enter the filename editing interface. You can press  to switch among Chinese, English and number input modes.



Letter Selecting Area    Letters Input    Uppercase/Lowercase    English Input Mode

(a) English Input Mode

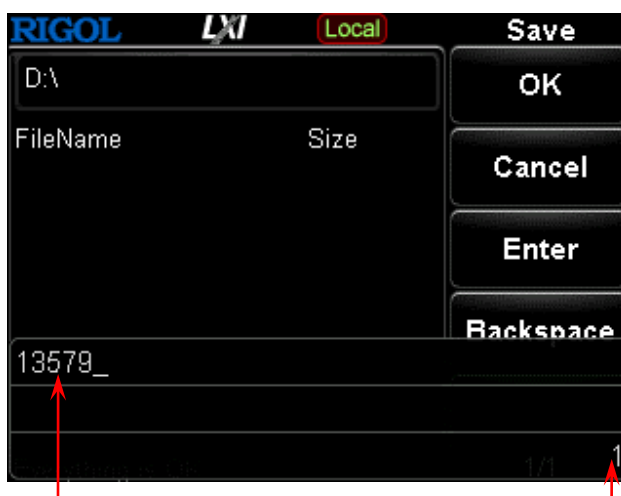

Numbers Input    Number Input Mode

(b) Number Input Mode



Chinese Characters Input      Pinyin Selecting Area      Chinese Input Mode

(c1) Chinese Input Mode 1



Chinese Characters Input      Chinese Character Selecting Area      Operation Prompt

(c2) Chinese Input Mode 2



Figure 2-2 Filename Editing Interface

### 3. Input the filename

Input the new filename in the filename editing interface. The length of the filename cannot exceed 28 English characters or numbers (or 14 Chinese characters).



- **Input an English filename**

- a) Press  to switch to English input mode. You can press  to switch between uppercase and lowercase inputs. At this point, the corresponding label is displayed at the lower-right corner of the filename editing interface.
- b) Press the key of the desired letter. At this point, the letters available are displayed in the **Letter Selecting Area**. Press this key continuously or press the left/right arrow key or rotate the knob until the background of the desired letter turns red. Then, press **Enter** to input the letter. You can press **Backspace** to delete the letter at the left of the cursor.
- c) Use the above method to input the other letters in the filename.

- **Input a Chinese filename**

- a) Press  to switch to Chinese input mode. At this point, the corresponding label is displayed at the lower-right corner of the filename editing interface.
- b) Press the key of the first letter of the pinyin of the desired Chinese character and the pinyins available are displayed in the **Pinyin Selecting Area**. If the desired pinyin is displayed, refer to step c). If the desired pinyin is not displayed, input the whole pinyin and then refer to c).
- c) Press the arrow keys or rotate the knob until the background of the desired pinyin turns red. Press **Enter** to select that pinyin. At this point, the Chinese characters in the **Chinese Character Selecting Area** are numbered. Use the numeric keys to select the desired Chinese character. You can also rotate the knob to open the previous page or next page of the **Chinese Character Selecting Area**. You can press **Backspace** to delete the Chinese character at the left of the cursor.
- d) Use the same method to input the other Chinese characters.

- **Input a filename with numbers**

If you want to use numbers as the filename (or a part of the filename), press  to switch to number input mode and use the numeric keyboard to input the desired numbers. You can press **Backspace** to delete the number at the left of the cursor.

#### 4. Save the file

After inputting the filename in the filename editing interface, press **OK** and the RF signal generator will save the file with the specified filename and file type under the directory currently selected. You can press **Cancel** to cancel the save operation.

- **Replace File:** when the current directory already contains a file or folder with the same name, you can press this key to replace the original file or

folder.

- Reenter: when the current directory already contains a file or folder with the same name, you can press this key to return to the filename editing interface and enter a new filename.

## Recall

Select a file stored and press **Recall** to read the file and load it into the system.

## Rename

Modify the filename of the file stored.

Select a file stored and press **Rename** to enter the filename editing interface; edit a new filename by referring to the introduction in "**Input the filename**" and press **OK** to store the file with the new filename.

## Delete

Select a file stored and press **Delete** → **OK** to delete the file selected.

## Copy

Select a file stored and press **Copy** to select "Copy" or "Paste".

### 1. Copy

Copy the file or folder selected under the current directory.

### 2. Paste

Paste the file or folder.

- When the copy path is the same as the paste path and the current path already contains a file or folder with the same name, the corresponding copy file with the "dup1" prefix is generated after you perform the paste operation.
- When the copy path is different from the paste path and the current path already contains a file or folder with the same name,
  - Replace File: press this key to replace the original file or folder.
  - Cancel: press this key to cancel the paste operation.

## To Create a Directory

Create a new folder. The length of the folder name cannot exceed 28 English characters or numbers (or 14 Chinese characters).

In the store and recall interface, rotate the knob to select the current storage directory (available when a USB storage device is detected; you can switch between D disk and E disk) and press the right arrow key to unfold the current directory. Press **Create Dir** to enter the filename editing interface, edit the folder name according to the introduction in "**Input the filename**" and press **OK** to create an empty folder under the current directory.

## Filename Prefix

Press **Name Prefix** to select "Prefix State" or "Edit Prefix".

### 1. Prefix State

Press **Prefix State** to select "On" or "Off" to enable or disable the prefix edited. When "On" is selected, the edited prefix will be added into the filename input box automatically when saving a file.

### 2. Edit Prefix

Press **Edit Prefix** to enter the filename editing interface and you can use the numeric keyboard to edit the prefix.

## Format

You can press **Format D** to format the local disk.

## System Update

Select the system update file in the USB storage device and press **Update** to update the software of the RF signal generator.

## To Set the System Parameters

Set the system-related parameters.

### Language

DSG800 supports menus in multiple languages as well as Chinese and English help information, prompt messages and interface display.

Press **Syst** → **Language** to select the desired language.

### Reset

Press **Syst** → **Reset** to perform "Power On", "Preset Type" and "Save Preset" operations.

#### 1. Power On

Press **Power On** to select "Last" or "Preset".

- When "Last" is selected, the system setting before the last power-off will be loaded automatically at power-on.
- When "Preset" is selected, the setting defined in **Preset Type** will be loaded automatically at power-on.

#### 2. Preset Type

Press **Preset Type** to select "Factory" or "User".

- When **Power On** is set to "Preset", the specified preset type will be loaded at power-on.
- After the instrument starts, press **Preset** at the front panel under any operation interface to recall the factory setting (as shown in Table 2-1) or user setting.

#### 3. Save Preset

Press **Save Preset** to store the current system configuration as user-defined setting in the internal non-volatile memory. When **Preset Type** is set to "User", the configuration will be loaded when you recall the "Preset" configuration.

**Note:** When **Preset Type** is set to "Factory", this menu is grayed out and disabled.

Table 2-1 Factory Values

| Parameter                        | Factory Value      |
|----------------------------------|--------------------|
| <b>FREQ</b>                      |                    |
| Frequency                        | DSG836(A): 3.6 GHz |
|                                  | DSG830: 3 GHz      |
|                                  | DSG821(A): 2.1 GHz |
|                                  | DSG815: 1.5 GHz    |
| <b>LF</b>                        |                    |
| Switch                           | Off                |
| Output Waveform                  | Sine               |
| Output Level                     | 500 mV             |
| Output Frequency                 | 1 kHz              |
| Square Output Level              | 500 mV             |
| Square Output Frequency          | 1 kHz              |
| <b>LEVEL</b>                     |                    |
| Level                            | -110 dBm           |
| Flatness Switch                  | Off                |
| Amplitude Unit                   | dBm                |
| <b>SWEEP</b>                     |                    |
| Sweep Manner                     | Off                |
| Sweep Type                       | Step               |
| Sweep Mode                       | Cont               |
| Start Frequency of Step Sweep    | 100 MHz            |
| Stop Frequency of Step Sweep     | 1 GHz              |
| Start Level of Step Sweep        | -10 dBm            |
| Stop Level of Step Sweep         | -20 dBm            |
| Number of Sweep Points           | 91                 |
| Dwell Time                       | 100 ms             |
| Sweep Space                      | Lin                |
| Sweep Shape                      | Ramp               |
| Trigger Mode of the Sweep Period | Auto               |
| Trigger Mode of Each Sweep Point | Auto               |
| External Trigger Polarity        | Pos                |

|                           |          |
|---------------------------|----------|
| Sweep Direction           | Fwd      |
| <b>AM</b>                 |          |
| Switch                    | Off      |
| Modulation Source         | Int      |
| Modulation Depth          | 50%      |
| Modulation Frequency      | 10 kHz   |
| Modulation Waveform       | Sine     |
| External Coupling         | AC       |
| Input Impedance           | 100 kohm |
| <b>FM/ØM</b>              |          |
| Modulation Type           | ØM       |
| <b>FM</b>                 |          |
| Switch                    | Off      |
| Modulation Source         | Int      |
| Frequency Deviation       | 10 kHz   |
| Modulation Rate           | 10 kHz   |
| Modulation Waveform       | Sine     |
| External Coupling         | AC       |
| Input Impedance           | 100 kohm |
| <b>ØM</b>                 |          |
| Switch                    | Off      |
| Modulation Source         | Int      |
| Phase Deviation           | 5 rad    |
| Modulation Rate           | 10 kHz   |
| Modulation Waveform       | Sine     |
| External Coupling         | AC       |
| Input Impedance           | 100 kohm |
| <b>Pulse Mod</b>          |          |
| Switch                    | Off      |
| Modulation Source         | Int      |
| Pulse Mode                | Single   |
| Period                    | 1 ms     |
| Pulse Width               | 500 us   |
| Trigger Mode              | Auto     |
| Pulse Output              | Off      |
| Trigger Delay             | 100 us   |
| Modulation Polarity       | Normal   |
| External Gated Polarity   | Normal   |
| External Trigger Polarity | Pos      |
| <b>I/Q Mod</b>            |          |

|                             |          |
|-----------------------------|----------|
| Switch                      | Off      |
| Modulation Source           | Int      |
| Baseband Switch             | Off      |
| Baseband Level              | 1 V      |
| Sample Rate                 | 1 MHz    |
| Trigger Mode                | Auto     |
| Operation Mode              | Retrig   |
| Duration Unit               | SL       |
| Duration                    | 1        |
| Trigger Delay               | 0        |
| Trigger Inhibit             | 0        |
| Segment Trigger Mode        | Same Seg |
| Next Segment                | 0        |
| <b>Output Control</b>       |          |
| RF/on Switch                | Off      |
| Mod/on Switch               | Off      |
| <b>System<sup>[1]</sup></b> |          |
| Language                    | English  |
| Power On Setting            | Preset   |
| Preset Type                 | Factory  |
| Remote Interface            | Off      |
| DHCP                        | On       |
| Auto-IP                     | On       |
| Manual-IP                   | Off      |
| Screen State                | On       |
| Brightness                  | 4        |
| Time/Date                   | Off      |
| Power Status                | Open     |
| <b>Save<sup>[1]</sup></b>   |          |
| File Type                   | All      |
| IME                         | Number   |
| Prefix Switch               | Off      |

**Note<sup>[1]</sup>**: Not affected by the preset setting.

## I/O Configuration

The RF signal generator supports USB and LAN communication interfaces.

Press **Syst** → **I/O Config** to set the "Remote I/O" and "LAN" parameters.

### 1. Remote I/O

Press **Remote I/O** to select "LAN", "USB", "Auto" or "Off" (turn off all the interfaces).

### 2. LAN

Press **LAN** to set the LAN parameters.

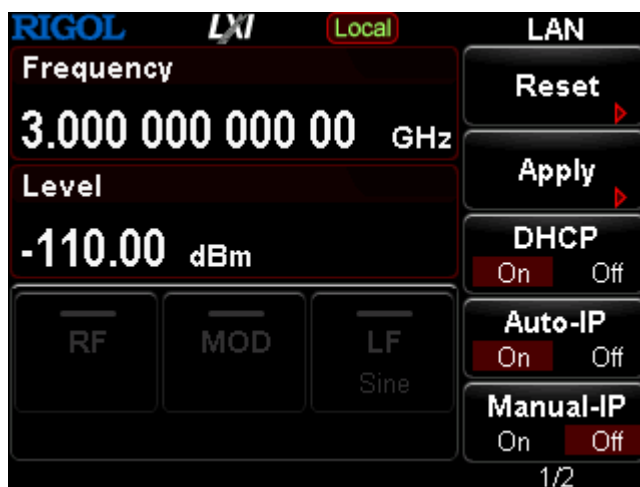

Figure 2-3 LAN Parameter Setup

- **Reset**  
Turn DHCP and auto IP on and turn manual IP off; clear the network password set and restore it to the factory setting.
- **Apply**  
After configuring the LAN parameters, press **Apply** → **OK** and the configuration takes effect.
- **DHCP**  
One of the IP address setting methods. When DHCP it turned on, the DHCP server will assign network parameters (such as the IP address, subnet mask and gateway) for the RF signal generator according to the current network configuration.
- **Auto-IP**  
One of the IP address setting methods. When auto IP is turned on, the RF



signal generator will acquire an IP address from 169.254.0.1 to 169.254.255.254 and subnet mask 255.255.0.0 automatically according to the current network configuration.

- **Manual-IP**  
One of the IP address setting methods. When manual IP is turned on, users can define the IP address of the RF signal generator.
  - **IP**  
Set the IP address, subnet mask and gateway manually.
    - a) Press **IP Address** and use the numeric keyboard to input the desired IP address.  
The format of the IP address is nnn.nnn.nnn.nnn. Wherein, the first nnn ranges from 1 to 223 (except 127) and the other three range from 0 to 255. You are recommended to ask your network administrator for an available IP address.
    - b) Press **Sub Mask** and use the numeric keyboard to input the desired subnet mask.  
The format of the subnet mask is nnn.nnn.nnn.nnn. Wherein, the range of the nnn is from 0 to 255. You are recommended to ask your network administrator for an available subnet mask.
    - c) Press **Gateway** and use the numeric keyboard to input the desired gateway address.  
The format of the gateway is nnn.nnn.nnn.nnn. Wherein, the first nnn ranges from 1 to 223 (except 127) and the other three range from 0 to 255. You are recommended to ask your network administrator for an available gateway address.
- Note:** When configuring the IP address, the priority order of three IP address setting methods is DHCP, auto IP and manual IP; besides, the three setting methods cannot be disabled at the same time.
- **DNS**  
Press **DNS** to set the IP address of the DNS server. The format of the DNS address is nnn.nnn.nnn.nnn. Wherein, the first nnn ranges from 1 to 223 (except 127) and the other three range from 0 to 255. You are recommended to ask your network administrator for an available address.

## Display Setting

Control the screen display.

Press **Syst** → **Display** to set the "Scr State", "Brightness" and "Time/Date".

### 1. Screen State

Press **Scr State** to set the on/off state of the screen.

- On: the default state. Turn on the screen.
- Off: turn off the screen. At this point, the screen stops updating and is locked; the measurement speed is improved. You can press **ESC** to unlock the screen. Screen locking is mainly used in remote operation mode.

### 2. Brightness

Press **Brightness** to set the brightness of the LCD backlight of the RF signal generator.

- Use the numeric keys, knob or arrow keys to modify this parameter.
- The range of the brightness is from 1 to 8.

### 3. Time/Date

You can press **Time/Date** to set the system time of the RF signal generator.

- **Set Time**  
Set the time displayed on the RF signal generator. The input format of the time is "hhmmss".  
For example, 23:12:11 is expressed as 231211.
- **Set Date**  
Set the date displayed on the RF signal generator. The input format of the date is "YYYYMMDD".  
For example, 2014/12/22 is expressed as 20141222.
- **Time/Date**  
Turn on or off the display of the time and date.

## Power Status

Press **Syst** → **Pwr Status** to select "Default" or "Open".

- When "Default" is selected, you need to press the power key at the front panel to start the instrument after the instrument is powered on.
- When "Open" is selected, the instrument starts automatically after it is powered on.

## Information

Press **Syst** → **Information** to view the "System Info", "HW Info" and "System Msg".

### 1. System Information

- Model
- Serial NO.
- SW Version
- Boot Version
- Option

### 2. Hardware Information

- RFB Version
- DB Version
- RFB FPGA
- IQB Version
- IQB FPGA

### 3. System Message

Display the list of the messages recently displayed.

## License

DSG800 provides various options to fulfill your measurement requirements. To order the corresponding option, please contact **RIGOL**.

Press **Syst** → **License** to enter the option management menu in which you can view the option status of the instrument and the license of the option installed as well as install an option.

### 1. Option Information

Press **Option Info** and the option status of this instrument will be displayed.

### 2. License Information

Press **License Info** and the license of the option installed will be displayed.

### 3. Install

Press **Install** and input the option license to activate the corresponding option.

#### Acquire the license:

- 1) Order the corresponding option to acquire the option key.
- 2) Log in to the **RIGOL** official website ([www.rigol.com](http://www.rigol.com)), click **License Activation** to enter the "Registered product license code" interface.

- 3) Input the option key, instrument serial number (press **Syst** → **Information** → **System Info** to acquire the instrument serial number) and indentifying code; click "Generate" to acquire the corresponding option license.

**Tips:**

You can also install an option by operating the RF signal generator remotely.

1. Build the communication between the RF signal generator and PC. You can use the USB or LAN interface. For the connecting methods, please refer to "**Remote Control**".
2. Send the :SYSTem:LKEY <license key> command (for example, :SYSTem:LKEY QA7ZCZEH6AC54SFNKA853MS5CB3A); the RF signal generator identifies the license received and matches it with the corresponding option. At this point, the corresponding option is installed and activated.

## Self-test

### 1. Screen Test

Press **Screen Test** to enter the screen test interface. The system provides five colors (include white, blue, green, red and black) to test whether the display contains bad pixels. Press any key to switch the screen color and exit the test.

### 2. Key Test

Press **Key Test** to enter the keyboard test interface. Press the function keys at the front panel one by one and check whether the corresponding key is illuminated; if not, failure might occur to that key. Press **ESC** three times to exit the test.

**Note:** If the keys at the front panel are transparent, the corresponding backlight will go on during the test.

## Sanitation

Press **Syst** → **Sanitation** to clear all the data set by users and restore them to the factory state, including:

- Format NAND FLASH.
- Restore the user data saved in the NVRAM and NorFlash to factory settings.
- Restore the HOST NAME, IP address and password in LXI to factory settings.

## Chapter 3 Remote Control

Users can control DSG800 series RF signal generator via the USB or LAN remote interface. This chapter describes the basic information and methods of remote control.

The topics of this chapter:

- Remote Control Overview
- Remote Control Via USB
- Remote Control Via LAN

## Remote Control Overview

DSG800 supports to build communication with the PC via the USB or LAN interface to realize remote control. The remote control is realized on the basis of the SCPI (Standard Commands for Programmable Instruments) command set. The remote control is realized in the following two modes.



### 1. User-defined programming

Users can program and control the RF signal generator using the SCPI commands on the basis of NI-VISA (National Instrument-Virtual Instrument Software Architecture) library. For the detailed information of the commands and programming, refer to *DSG800 Programming Guide*.

### 2. Use PC software

Users can use the common PC software (Ultra Sigma) provided by **RIGOL** to send SCPI commands to control the RF signal generator remotely.

This chapter will give a detailed introduction of how to use Ultra Sigma to control the RF signal generator remotely through the USB and LAN interfaces. After acquiring the Ultra Sigma software, install it as well as the desired components according to the corresponding help document. You can download the latest version of the software from [www.rigol.com](http://www.rigol.com).

**Note:** When the instrument is in remote mode,  is displayed in the user interface and all the front panel keys (except ) are locked. At this point, you can press  to exit the remote mode.

## Remote Control Via USB

### 1. Connect the device

Connect the RF signal generator (USB DEVICE) and PC (USB HOST) using a USB cable.

### 2. Install the USB drive

This RF signal generator is a USBTMC device and the **Found New Hardware Wizard** dialog box will be displayed after the RF signal generator is correctly connected to the PC (the RF signal generator will be automatically configured to the USB interface) and both of them are started. Please install the "USB Test and Measurement Device (IVI)" drive program according to the instructions.

### 3. Search for the device resource

Start Ultra Sigma (assume that your PC is already correctly installed with Ultra Sigma) and the software will search for the RF signal generator resource currently connected to the PC automatically. You can also click  to search for the resource.

### 4. View the device resource

The resource found will be displayed under the "RIGOL Online Resource" directory and the model number and USB interface information of the instrument will also be displayed.

For example, DSG830 (USB0::0x1AB1::0x6666::DSG8A170200001::INSTR).

### 5. Communication test

Right-click the resource name "DSG830 (USB0::0x1AB1::0x6666::DSG8A170200001::INSTR)" and select "SCPI Panel Control" to open the remote command control panel through which you can send commands and read data. For more information about the SCPI commands, refer to the *DSG800 Programming Guide*.

## Remote Control Via LAN

### 1. Connect the device

Connect the RF signal generator to your LAN.

### 2. Configure the LAN parameters

Set the LAN parameters of the RF signal generator according to the description in "**I/O Configuration → LAN**".

### 3. Search for the device resource

Start-up Ultra Sigma and click **LAN**; then, click **Search** in the pop-up window and the software starts searching for the RF signal generator resource connected to the LAN. The name of the instrument resource found will be displayed in the resource box at the right of the window. Click **OK** to add the resource.

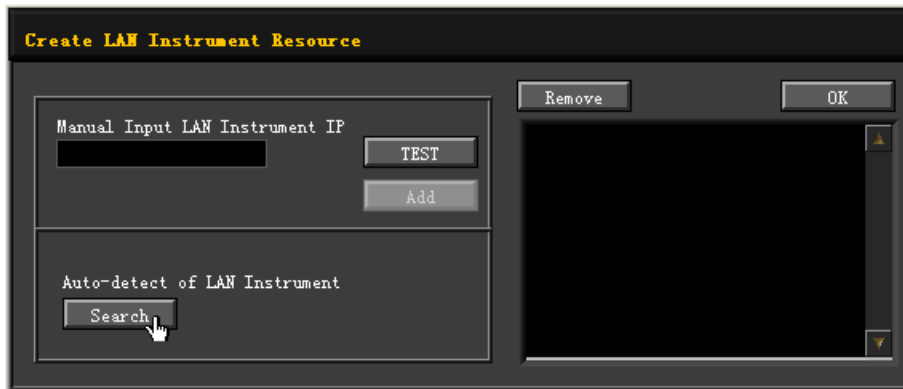

**Note:** The resource selected should keep consistency with the IP address of the LAN interface of the RF signal generator. In addition, if you want to remove the unwanted resource, click the corresponding resource name and click

**Remove**.

### 4. View the device resource

The resource found will appear under the "RIGOL Online Resource" directory. For example, DSG830 (TCPIP::172.16.3.194::INSTR).

### 5. Communication test

Right click the resource name "DSG830 (TCPIP::172.16.3.194::INSTR)" and select "SCPI Panel Control" to open the remote command control panel through which you can send commands and read data.

### 6. Load LXI webpage

The RF signal generator conforms to LXI Core 2011 Device standards. You can load LXI webpage conveniently through Ultra Sigma by right-clicking the



resource name of the instrument and selecting "LXI-Web". Various important information about the instrument (include the model number, manufacturer, serial number, description, MAC address and IP address) will be displayed on the webpage.

**Note:** If you want to view or modify the current network settings of the instrument, click "Network Settings" and input the initial password "RIGOL" (must be uppercase letters, exclude the double quotation marks) in the pop-up window (by default, the user name is empty). Besides, you can click "Security" to reset the password.

**Tip:**

You can also load the LXI webpage by entering the IP address of the RF signal generator in the address bar of the PC browser.



## Chapter 4 Application Examples

This chapter introduces the basic operations of the instrument using specific examples so that users can quickly master the using methods of the RF signal generator.

The topics of this chapter:

- To Output a RF Signal
- To Output a RF Sweep Signal
- To Output a RF Modulated Signal

## To Output a RF Signal

Output a RF signal with 1 GHz frequency and -20 dBm amplitude from the **[RF OUTPUT 50Ω]** connector.

### 1. Restore to the factory setting

Press **Syst** → **Reset** → **Preset Type** → "Factory" and then press **Preset** to restore the instrument to the factory setting.

### 2. Frequency setup

Press **FREQ**, use the numeric keyboard to input the frequency value (1) and select the desired unit (GHz) from the pop-up unit menu.

- The frequency units available are GHz, MHz, kHz and Hz.
- You can press **Backspace** to delete the number at the left of the cursor.
- You can also press the left/right arrow key to enter the parameter editing state and move the cursor to the specified digit; then, rotate the knob to modify the value.
- After the frequency is set, you can rotate the knob to modify the frequency at the current step.
- You can press **FREQ** and then press **Step** to set the step.

### 3. Amplitude setup

Press **LEVEL**, use the numeric keyboard to input the amplitude value (-20) and select the desired unit (dBm) from the pop-up unit menu.

- The amplitude units available are dBm, -dBm, mV, uV and nV.
- You can press **Backspace** to delete the number at the left of the cursor.
- You can also press the left/right arrow key to enter the parameter editing state and move the cursor to the specified digit; then, rotate the knob to modify the value.
- You can also rotate the knob to modify the amplitude at the current step.
- You can press **LEVEL** and then press **Step** to set the step.

### 4. Turn on the RF output

Press **RF/on**; the backlight of the key and the RF label displayed in the function status area in the user interface are illuminated. At this point, the RF output is turned on and the **[RF OUTPUT 50Ω]** connector outputs RF signal according to the current configuration.

## To Output a RF Sweep Signal

This section introduces how to output a RF sweep signal by configuring continuous linear step sweep. Set the frequency range to (1 GHz to 2 GHz), the amplitude range to (-20 dBm to 0 dBm), the number of sweep points to 10 and the dwell time to 500 ms.

### 1. Restore to the factory setting

Press **Syst** → **Reset** → **Preset Type** → "Factory" and then press **Preset** to restore the instrument to the factory setting (by default, the sweep mode is continuous, the sweep type is step and the sweep space is linear).

### 2. Step sweep parameter setup

Press **SWEEP** and use the menu page up/down key  to open the 2/3 page of the menu; then, press **Step Swp** to enter the step sweep parameter setting menu.

- Start Frequency

Press **Start Freq**, use the numeric keyboard to input the start frequency value (1) and select the desired unit (GHz) from the pop-up unit menu.

- Stop Frequency

Press **Stop Freq**, use the numeric keyboard to input the stop frequency value (2) and select the desired unit (GHz) from the pop-up unit menu.

- Start Level

Press **Start Lev**, use the numeric keyboard to input the start level value (-20) and select the desired unit (dBm) from the pop-up unit menu.

- Stop Level

Press **Stop Lev**, use the numeric keyboard to input the stop level value (0) and select the desired unit (dBm) from the pop-up unit menu.

- Sweep Points

Press **Points**, use the numeric keyboard to input the number of sweep points (10) and then press **Enter**.

- Dwell Time

The dwell time indicates the duration of a sweep step.

Press **Dwell Time**, use the numeric keyboard to input the time value (500) and select the desired unit (ms) from the pop-up unit menu.

### 3. Turn on the RF sweep

Press **SWEEP** → **Sweep** and select "Freq & Lev" to turn on the frequency and amplitude sweep functions at the same time.

At this point, the RF signal generator sweeps from the start frequency and level to the stop frequency and level continuously at certain step according to the current settings. The frequency and amplitude sweep progress bars as well as the continuous sweep label are displayed in the frequency and amplitude areas in the user interface respectively; in addition, the Sweep label in the function status area is illuminated.

### 4. Turn on the RF output

Press **RF/on**; the backlight of the key and the RF label displayed in the function status area in the user interface are illuminated. At this point, the RF output is turned on and the **[RF OUTPUT 50Ω]** connector outputs RF sweep signal according to the current configuration.

## To Output a RF Modulated Signal

This section introduces how to output an AM modulated signal by taking amplitude modulation (AM) as an example. Set the carrier frequency to 800 MHz, the carrier amplitude to -20 dBm, the AM modulation depth to 60% and the modulation frequency to 20 kHz.

### 1. Restore to the factory setting

Press **Syst** → **Reset** → **Preset Type** → "Factory" and then press **Preset** to restore the instrument to the factory setting (by default, the modulation source is internal and the modulation waveform is sine).

### 2. Set the carrier frequency and amplitude

#### (1) Carrier Frequency

Press **FREQ**, use the numeric keyboard to input the frequency value (800) and select the desired unit (MHz) from the pop-up unit menu.

#### (2) Carrier Amplitude

Press **LEVEL**, use the numeric keyboard to input the amplitude value (-20) and select the desired unit (dBm) from the pop-up unit menu.

### 3. Set the AM modulation parameters

(1) Press **MOD** → **AM** to enter the amplitude modulation parameter setting menu.

(2) Press **Depth**, use the numeric keyboard to input the value of the modulation depth (60) and select the desired unit (%) from the pop-up unit menu.

(3) Press **Freq**, use the numeric keyboard to input the frequency value (20) and select the desired unit (kHz) from the pop-up unit menu.

(4) Press **Switch** and select "On" to turn on the AM function.

### 4. Turn on the RF modulation output

Press **Mod/on** and the backlight is illuminated. Then, press **RF/on** and the backlight is illuminated. The MOD, AM and RF labels in the function status area in the user interface are illuminated. At this point, the RF modulation output is turned on and the **[RF OUTPUT 50Ω]** connector outputs RF modulated signal according to the current configuration.

**Note:** The backlights of **RF/on** and **Mod/on** must be both illuminated.





## Chapter 5 Troubleshooting

The chapter lists the commonly encountered failures of DSG800 and their solutions. When you encounter those problems, please solve them following the corresponding steps. If the problem remains still, please contact **RIGOL** and provide your device information (**Syst** → **Information** → **System Info**).

- 1. The screen of the RF signal generator is still dark (no display) after the power key is pressed.**
  - (1) Check whether the fan is running;
    - If the fan is running but the screen is dark, the screen connecting wire might be loose.
    - If the fan is not running, the instrument does not start successfully and please go to step (2).
  - (2) Check whether the power is correctly connected and whether the power key is really on.
  - (3) Check whether the fuse is burned out. If the fuse needs to be replaced, please contact **RIGOL**.
  - (4) Restart the instrument after finishing the above inspections.
  - (5) If it still does not work correctly, please contact **RIGOL**.
  
- 2. The screen is too dark and cannot be seen clearly.**
  - (1) Check whether the brightness setting value of the LCD is too low.
  - (2) Press **Syst** → **Display** → **Brightness** and use the numeric keys or knob to adjust the brightness of the LCD of the RF signal generator to a proper value.
  
- 3. The RF signal generator is locked.**
  - (1) Check whether the RF signal generator is in remote control mode (in remote control, **Rmt** is displayed in the status bar of the user interface). Pressing **ESC** can exit the remote control mode and unlock the front panel.
  - (2) Check whether the RF signal generator is in local mode with the screen being locked (when the screen is locked, front panel operations are not available). Pressing **ESC** can unlock the screen and exit the locking state.
  - (3) If progress bar is displayed on the screen of the RF signal generator, some operation is in progress. For example, when saving a file, the progress bar will be displayed indicating that the save operation is in progress. During the operation, the front panel is locked.
  - (4) Pressing **Preset** or restarting the RF signal generator can also unlock the instrument.

#### 4. The setting is correct but the waveform output is incorrect.

- (1) There is no RF output
  - Check whether the signal connecting cable is tightly connected to the corresponding **[RF OUTPUT 50Ω]** connector.
  - Check whether the connecting cable has internal damage.
  - Check whether the connecting cable is tightly connected to the test instrument.
  - Check whether the backlight of **[RF/on]** is illuminated. If not, press this key to illuminate the backlight. At this point, the RF label in the function status area in the user interface is illuminated and the RF output is correctly turned on.
  - Check whether the output amplitude of the RF signal is too small. Adjust the output amplitude properly.
- (2) The RF output is not modulated
  - Check whether the signal connecting cable is tightly connected to the corresponding **[RF OUTPUT 50Ω]** connector.
  - Check whether the connecting cable has internal damage.
  - Check whether the connecting cable is tightly connected to the test instrument.
  - Check whether the backlights of **[Mod/on]** and **[RF/on]** are both illuminated and check whether the modulation **Switch** is turned on.
  - Check whether the modulation parameter settings are proper and adjust the parameters appropriately.
  - If external modulation source is used, make sure that the external source is correctly connected and outputs signal. At the same time, the external source should work within the specified range of the RF signal generator.

#### 5. The sweep is abnormal.

- (1) The sweep stagnates

The sweep progress bar is displayed in the frequency area/amplitude area in the user interface indicating that the sweep is in progress. If the sweep stagnates, please check:

  - At least one manner of sweep is turned on. Press **[SWEEP]** → **Sweep** to select "Freq", "Level" or "Freq & Lev".
  - If single sweep mode is selected, press **Single** to meet the trigger condition and the instrument performs a sweep.
  - If the sweep trigger mode is not set to auto, press **[SWEEP]** → **Trig Mod** → **Auto** to check whether the sweep stagnates due to the loss of the sweep trigger.
  - If the point trigger mode is not set to auto, press **[SWEEP]** → **Point Trig** → **Auto** to check whether the sweep stagnates due to the loss of the point trigger.
  - Check whether the dwell time is too large or too small that the sweep cannot be seen.

- Make sure that at least two points are set in the step sweep or list sweep.
- (2) The dwell time of list sweep is incorrect
    - Press **SWEEP** → **List Swp** to enter the sweep list menu.
    - Press **Load** to load the desired sweep list and press **View** to check whether the dwell time in the sweep list is correct.
    - If the dwell time is incorrect, re-edit the sweep list and load it to the instrument. If the dwell time is correct, turn to the next step.
    - Press **SWEEP** → **Type** to make sure that "List" sweep is selected. If "Step" sweep is currently selected, the RF signal generator sweeps according to the dwell time of step sweep.
  - (3) The list sweep information recalled from the register is lost
    - The list sweep information cannot be stored in the status register of the instrument as a part of the instrument state.
    - The RF signal generator can only use the list currently loaded for sweep.
  - (4) In list or step sweep, the amplitude does not change
    - Make sure that the sweep manner is set to "Level" or "Freq & Lev".
    - If the sweep manner is currently set to "Freq", the amplitude will not change.
- 6. The USB storage device cannot be recognized.**
- (1) Check whether the USB storage device can work normally when being connected to other instrument or PC.
  - (2) Make sure that the USB storage device used is a Flash type. This instrument does not support hardware USB storage device.
  - (3) Restart the instrument and insert the USB storage device to check whether it can work normally.
  - (4) If the USB storage device still cannot be used normally, please contact **RIGOL**.
- 7. No response or incorrect response when a key is pressed.**
- (1) After starting the instrument, check whether all the keys are irresponsive.
  - (2) Press **Syst** → **Self-Test** → **Key Test** to enter the keyboard test interface. Press the function keys at the front panel sequentially and check whether some key gives no response or incorrect response when it is pressed.
  - (3) If the above failures occur, the keyboard connecting wire might be loose or the keyboard is damaged. Please do not disassemble the instrument and contact **RIGOL**.
- 8. The instrument does not pass the performance specification test.**
- (1) Check whether the RF signal generator is within the calibration period (1 year).
  - (2) Check whether the RF signal generator is warmed up for at least 40 minutes before the test.

- (3) Check whether the RF signal generator is working under the specified environment temperature.
- (4) Check whether the test is being performed in a highly magnetic environment.
- (5) Check whether the power supplies of the RF signal generator and test system have strong interference.
- (6) Check whether the performance of the test device meets the requirement.
- (7) Check whether the test device is within the calibration period.
- (8) Check whether the test device is working under the required conditions of the corresponding manual.
- (9) Check whether all the connections are tight.
- (10) Check whether the cables have internal damage.
- (11) Make sure that the operations conform to the settings and processes required by the performance verification guide.
- (12) Check whether the error calculation is correct.
- (13) Get a correct understanding of the definitions of "Typical Value" and "Nominal Value".
  - Typical Value: the performance specifications of this product under the specified conditions.
  - Nominal Value: the approximate quantity of the product during application.

## Chapter 6 Appendix

### Appendix A: DSG800 Accessories and Options

|                      | Description  | Order Number |
|----------------------|--|--------------|
| Models               | RF Signal Generator, 9 kHz to 1.5 GHz  | DSG815       |
|                      | RF Signal Generator, 9 kHz to 2.1 GHz  | DSG821       |
|                      | RF Signal Generator, 9 kHz to 2.1 GHz, I/Q Modulation (Standard Configuration) | DSG821A      |
|                      | RF Signal Generator, 9 kHz to 3 GHz  | DSG830       |
|                      | RF Signal Generator, 9 kHz to 3.6 GHz  | DSG836       |
|                      | RF Signal Generator, 9 kHz to 3.6 GHz, I/Q Modulation (Standard Configuration) | DSG836A      |
| Standard Accessories | Quick Guide (Hard Copy)  | --           |
|                      | Power Cable  | --           |
| Options              | Pulse Modulation, Pulse Generator  | DSG800-PUM   |
|                      | Pulse Train Generator <sup>[1]</sup>   | DSG800-PUG   |
|                      | High Stable Reference Clock  | OCXO-B08     |
|                      | Rack Mount Kit (For one Instrument)  | RM-1-DG1000Z |
|                      | Rack Mount Kit (For two Instruments)   | RM-2-DG1000Z |

**Note:** [1] The option DSG800-PUM will be installed automatically after this option is installed.

## Appendix B: Warranty

**RIGOL** (SUZHOU) TECHNOLOGIES INC. (hereinafter referred to as **RIGOL**) warrants that the product will be free from defects in materials and workmanship within the warranty period. If a product proves defective within the warranty period, **RIGOL** guarantees free replacement or repair for the defective product.

To get repair service, please contact with your nearest **RIGOL** sales or service office.

There is no other warranty, expressed or implied, except such as is expressly set forth herein or other applicable warranty card. There is no implied warranty of merchantability or fitness for a particular purpose. Under no circumstances shall **RIGOL** be liable for any consequential, indirect, ensuing, or special damages for any breach of warranty in any case.

# Index

|                           |                        |                             |                  |
|---------------------------|------------------------|-----------------------------|------------------|
| amplitude.....            | 2-4                    | List Sweep.....             | 2-7              |
| Amplitude Modulation..... | 2-15                   | Modulation Depth.....       | 2-16             |
| Amplitude Sweep.....      | 2-6                    | Modulation Frequency.....   | 2-16             |
| ARB.....                  | 2-32                   | modulation source.....      | 2-30             |
| Arm ARB.....              | 2-34                   | Modulation Waveform.....    | 2-16             |
| Arm Auto.....             | 2-33                   | Next Segment.....           | 2-35             |
| Arm Retrigger.....        | 2-33                   | Number of Sweep Points..... | 2-9              |
| Auto Trigger.....         | 2-11, 2-12, 2-32       | OCXO.....                   | 1-15             |
| Baseband Level.....       | 2-31                   | operation mode.....         | 2-33             |
| baseband output.....      | 2-31                   | Phase Deviation.....        | 2-22             |
| Bus Trigger.....          | 2-12, 2-13, 2-27, 2-33 | Phase Modulation.....       | 2-21             |
| clock frequency.....      | 2-32                   | Point Trigger Mode.....     | 2-12             |
| Continuous Sweep.....     | 2-10                   | Pulse Mode.....             | 2-25             |
| DNS.....                  | 2-49                   | Pulse Modulation.....       | 2-24             |
| Duration.....             | 2-34                   | Pulse Output.....           | 2-27             |
| Duration Unit.....        | 2-34                   | Pulse Period.....           | 2-25             |
| Dwell Time.....           | 2-9                    | Pulse Width.....            | 2-26             |
| Ext Delay.....            | 2-34                   | Reset Sweep.....            | 2-11             |
| Ext Inhibit.....          | 2-35                   | Retrigger.....              | 2-33             |
| External Coupling.....    | 2-17                   | Same Segment.....           | 2-35             |
| External Gate.....        | 2-27                   | Seamless.....               | 2-35             |
| External Trigger.....     | 2-12, 2-13, 2-26, 2-33 | Segment Trigger Mode.....   | 2-35             |
| Flatness Calibration..... | 2-4                    | Single.....                 | 2-34             |
| Frequency.....            | 2-2                    | Single Sweep.....           | 2-10             |
| Frequency Deviation.....  | 2-19                   | Start Frequency.....        | 2-8              |
| Frequency Modulation..... | 2-18                   | Start Level.....            | 2-8              |
| Frequency Sweep.....      | 2-6                    | Step Sweep.....             | 2-8              |
| Gateway.....              | 2-49                   | Stop Frequency.....         | 2-8              |
| I/Q modulation.....       | 2-30                   | Stop Level.....             | 2-8              |
| Input Impedance.....      | 2-17                   | Subnet Mask.....            | 2-49             |
| IP Address.....           | 2-49                   | Sweep.....                  | 2-6              |
| Key Trigger.....          | 2-11, 2-12, 2-27, 2-33 | Sweep Shape.....            | 2-9              |
| LAN.....                  | 2-48                   | Sweep Space.....            | 2-9              |
| LF output.....            | 2-2                    | Train List.....             | 2-28             |
| LF signal amplitude.....  | 2-3                    | Trigger Delay.....          | 2-28             |
| LF signal frequency.....  | 2-3                    | Trigger Mode.....           | 2-11, 2-26, 2-32 |
| LF signal waveform.....   | 2-3                    |                             |                  |