

**RIGOL**

**Programming Guide**

**DSG800 Series RF Signal Generator**

July 2015  
RIGOL Technologies, Inc.



---

# Guaranty and Declaration

## Copyright

© 2015 RIGOL Technologies, Inc. All Rights Reserved.

## Trademark Information

**RIGOL** is a registered trademark of RIGOL Technologies, Inc.

## Publication Number

PGG02102-1110

## Software Version

00.01.02

Software upgrade might change or add product features. Please acquire the latest version of the manual from **RIGOL** website or contact **RIGOL** to upgrade the software.

## Notices

- **RIGOL** products are covered by P.R.C. and foreign patents, issued and pending.
- **RIGOL** reserves the right to modify or change parts of or all the specifications and pricing policies at company's sole decision.
- Information in this publication replaces all previously corresponding material.
- Information in this publication is subject to change without notice.
- **RIGOL** shall not be liable for either incidental or consequential losses in connection with the furnishing, use or performance of this manual as well as any information contained.
- Any part of this document is forbidden to be copied, photocopied or rearranged without prior written approval of **RIGOL**.

## Product Certification

**RIGOL** guarantees this product conforms to the national and industrial standards in China as well as the ISO9001:2008 standard and the ISO14001:2004 standard. Other international standard conformance certification is in progress.

## Contact Us

If you have any problem or requirement when using our products or this manual, please contact **RIGOL**.

E-mail: [service@rigol.com](mailto:service@rigol.com)

Website: [www.rigol.com](http://www.rigol.com)

# Safety Requirement

## General Safety Summary

Please review the following safety precautions carefully before putting the instrument into operation so as to avoid any personal injury or damage to the instrument and any product connected to it. To prevent potential hazards, please use the instrument only specified by this manual.

### **Use Proper Power Cord.**

Only the power cord designed for the instrument and authorized for use within the local country could be used.

### **Ground the Instrument.**

The instrument is grounded through the Protective Earth lead of the power cord. To avoid electric shock, it is essential to connect the earth terminal of the power cord to the Protective Earth terminal before connecting any inputs or outputs.

### **Connect the Probe Correctly.**

If a probe is used, do not connect the ground lead to high voltage since it has isobaric electric potential as the ground.

### **Observe All Terminal Ratings.**

To avoid fire or shock hazard, observe all ratings and markers on the instrument and check your manual for more information about ratings before connecting the instrument.

### **Use Proper Overvoltage Protection.**

Make sure that no overvoltage (such as that caused by a thunderstorm) can reach the product, or else the operator might be exposed to the danger of electrical shock.

### **Do Not Operate Without Covers.**

Do not operate the instrument with covers or panels removed.

### **Do Not Insert Anything Into the Holes of Fan.**

Do not insert anything into the holes of the fan to avoid damaging the instrument.

### **Use Proper Fuse.**

Please use the specified fuses.

### **Avoid Circuit or Wire Exposure.**

Do not touch exposed junctions and components when the unit is powered.

### **Do Not Operate With Suspected Failures.**

If you suspect damage occurs to the instrument, have it inspected by **RIGOL** authorized personnel before further operations. Any maintenance, adjustment or replacement especially to circuits or accessories must be performed by **RIGOL** authorized personnel.

### **Keep Well Ventilation.**

Inadequate ventilation may cause an increase of instrument temperature which would cause damage to the instrument. So please keep the instrument well ventilated and inspect the intake and fan regularly.

### **Do Not Operate in Wet Conditions.**

In order to avoid short circuiting to the interior of the device or electric shock, please do not operate the instrument in a humid environment.

**Do Not Operate in an Explosive Atmosphere.**

In order to avoid damage to the device or personal injuries, it is important to operate the device away from an explosive atmosphere.

**Keep Product Surfaces Clean and Dry.**

To avoid the influence of dust and/or moisture in the air, please keep the surface of the device clean and dry.

**Electrostatic Prevention.**

Operate the instrument in an electrostatic discharge protective environment to avoid damage induced by static discharges. Always ground both the internal and external conductors of cables to release static before making connections.

**Proper Use of Battery.**

If a battery is supplied, it must not be exposed to high temperature or in contact with fire. Keep it out of the reach of children. Improper change of battery (note: lithium battery) may cause explosion. Use **RIGOL** specified battery only.

**Handling Safety.**

Please handle with care during transportation to avoid damage to keys, knob interfaces and other parts on the panels.

## Safety Terms and Symbols

**Terms Used in this Manual.** These terms may appear in this manual:

**WARNING**

Warning statements indicate conditions or practices that could result in injury or loss of life.

**CAUTION**

Caution statements indicate conditions or practices that could result in damage to this product or other property.

**Terms Used on the Product.** These terms may appear on the product:

**DANGER** It calls attention to an operation, if not correctly performed, could result in injury or hazard immediately.

**WARNING** It calls attention to an operation, if not correctly performed, could result in potential injury or hazard.

**CAUTION** It calls attention to an operation, if not correctly performed, could result in damage to the product or other devices connected to the product.

**Symbols Used on the Product.** These symbols may appear on the product:



Hazardous  
Voltage



Safety  
Warning



Protective  
Earth  
Terminal



Chassis  
Ground



Test  
Ground

## Allgemeine Sicherheits Informationen

Überprüfen Sie die folgenden Sicherheitshinweise sorgfältig um Personenschäden oder Schäden am Gerät und an damit verbundenen weiteren Geräten zu vermeiden. Zur Vermeidung von Gefahren, nutzen Sie bitte das Gerät nur so, wie in diesem Handbuche angegeben.

### **Um Feuer oder Verletzungen zu vermeiden, verwenden Sie ein ordnungsgemäßes Netzkabel.**

Verwenden Sie für dieses Gerät nur das für ihr Land zugelassene und genehmigte Netzkabel.

### **Erden des Gerätes.**

Das Gerät ist durch den Schutzleiter im Netzkabel geerdet. Um Gefahren durch elektrischen Schlag zu vermeiden, ist es unerlässlich, die Erdung durchzuführen. Erst dann dürfen weitere Ein- oder Ausgänge verbunden werden.

### **Anschluss eines Tastkopfes.**

Die Erdungsklemmen der Sonden sind auf dem gleichen Spannungspegel des Instruments geerdet. Schließen Sie die Erdungsklemmen an keine hohe Spannung an.

### **Beachten Sie alle Anschlüsse.**

Zur Vermeidung von Feuer oder Stromschlag, beachten Sie alle Bemerkungen und Markierungen auf dem Instrument. Befolgen Sie die Bedienungsanleitung für weitere Informationen, bevor Sie weitere Anschlüsse an das Instrument legen.

### **Verwenden Sie einen geeigneten Überspannungsschutz.**

Stellen Sie sicher, daß keinerlei Überspannung (wie z.B. durch Gewitter verursacht) das Gerät erreichen kann. Andernfalls besteht für den Anwender die Gefahr eines Stromschlages.

### **Nicht ohne Abdeckung einschalten.**

Betreiben Sie das Gerät nicht mit entfernten Gehäuse-Abdeckungen.

### **Betreiben Sie das Gerät nicht geöffnet.**

Der Betrieb mit offenen oder entfernten Gehäuseteilen ist nicht zulässig. Nichts in entsprechende Öffnungen stecken (Lüfter z.B.)

### **Passende Sicherung verwenden.**

Setzen Sie nur die spezifikationsgemäßen Sicherungen ein.

### **Vermeiden Sie ungeschützte Verbindungen.**

Berühren Sie keine unisolierten Verbindungen oder Baugruppen, während das Gerät in Betrieb ist.

### **Betreiben Sie das Gerät nicht im Fehlerfall.**

Wenn Sie am Gerät einen Defekt vermuten, sorgen Sie dafür, bevor Sie das Gerät wieder betreiben, dass eine Untersuchung durch **RIGOL** autorisiertem Personal durchgeführt wird. Jedwede Wartung, Einstellarbeiten oder Austausch von Teilen am Gerät, sowie am Zubehör dürfen nur von **RIGOL** autorisiertem Personal durchgeführt werden.

### **Belüftung sicherstellen.**

Unzureichende Belüftung kann zu Temperaturanstiegen und somit zu thermischen Schäden am Gerät führen. Stellen Sie deswegen die Belüftung sicher und kontrollieren regelmäßig Lüfter und Belüftungsöffnungen.

### **Nicht in feuchter Umgebung betreiben.**

Zur Vermeidung von Kurzschluß im Geräteinneren und Stromschlag betreiben Sie das Gerät bitte niemals in feuchter Umgebung.

### **Nicht in explosiver Atmosphäre betreiben.**

Zur Vermeidung von Personen- und Sachschäden ist es unumgänglich, das Gerät ausschließlich fernab

jedweder explosiven Atmosphäre zu betreiben.

**Geräteoberflächen sauber und trocken halten.**

Um den Einfluß von Staub und Feuchtigkeit aus der Luft auszuschließen, halten Sie bitte die Geräteoberflächen sauber und trocken.

**Schutz gegen elektrostatische Entladung (ESD).**

Sorgen Sie für eine elektrostatisch geschützte Umgebung, um somit Schäden und Funktionsstörungen durch ESD zu vermeiden. Erden Sie vor dem Anschluß immer Innen- und Außenleiter der Verbindungsleitung, um statische Aufladung zu entladen.

**Die richtige Verwendung des Akku.**

Wenn eine Batterie verwendet wird, vermeiden Sie hohe Temperaturen bzw. Feuer ausgesetzt werden. Bewahren Sie es außerhalb der Reichweite von Kindern auf. Unsachgemäße Änderung der Batterie (Anmerkung: Lithium-Batterie) kann zu einer Explosion führen. Verwenden Sie nur von **RIGOL** angegebenen Akkus.

**Sicherer Transport.**

Transportieren Sie das Gerät sorgfältig (Verpackung!), um Schäden an Bedienelementen, Anschlüssen und anderen Teilen zu vermeiden.



## Sicherheits Begriffe und Symbole

**Begriffe in diesem Guide.** Diese Begriffe können in diesem Handbuch auftauchen:



### **WARNING**

Die Kennzeichnung WARNING beschreibt Gefahrenquellen die leibliche Schäden oder den Tod von Personen zur Folge haben können.



### **CAUTION**

Die Kennzeichnung Caution (Vorsicht) beschreibt Gefahrenquellen die Schäden am Gerät hervorrufen können.

**Begriffe auf dem Produkt.** Diese Bedingungen können auf dem Produkt erscheinen:

### **DANGER**

weist auf eine Verletzung oder Gefährdung hin, die sofort geschehen kann.

### **WARNING**

weist auf eine Verletzung oder Gefährdung hin, die möglicherweise nicht sofort geschehen.

### **CAUTION**

weist auf eine Verletzung oder Gefährdung hin und bedeutet, dass eine mögliche Beschädigung des Instruments oder anderer Gegenstände auftreten kann.

**Symbole auf dem Produkt.** Diese Symbole können auf dem Produkt erscheinen:



Gefährliche  
Spannung



Sicherheits-  
Hinweis



Schutz-erde



Gehäusemasse



Erde

# Document Overview

This manual introduces how to program the RF signal generator over the remote interfaces in details.

## Main Topics in this Manual:

### Chapter 1 Programming Overview

This chapter outlines how to build the remote communication between the RF signal generator and PC and how to control the RF signal generator remotely. Besides, it also provides a brief introduction of the SCPI commands.

### Chapter 2 Command System

This chapter introduces the syntax, function, parameter and using instruction of each DSG800 command in alphabetical order (from A to Z).

### Chapter 3 Application Examples

This chapter provides the application examples of the main functions of the RF signal generator. In the application examples, a series of commands are combined to realize the basic functions of the RF signal generator.

### Chapter 4 Programming Demos

This chapter introduces how to program and control DSG800 using development tools, such as Visual C++, Visual Basic and LabVIEW.

### Chapter 5 Appendix

This chapter provides various information, such as the command list and factory setting list.

#### Tip

The latest version of this manual can be downloaded from [www.rigol.com](http://www.rigol.com).

## Format Conventions in this Manual:

### 1. Key

The key at the front panel is denoted by the format of "Key Name (Bold) + Text Box" in the manual. For example, **FREQ** denotes the **FREQ** key.

### 2. Menu

The menu item is denoted by the format of "Menu Word (Bold) + Character Shading" in the manual. For example, **LF** denotes the "LF" menu item under **FREQ**.

### 3. Operation Step

The next step of operation is denoted by an arrow "→" in the manual. For example, **FREQ** → **LF** denotes pressing **FREQ** at the front panel and then pressing **LF**.

## Content Conventions in this Manual:

DSG800 series RF signal generator includes DSG830 and DSG815. The introductions of the DSG800 series commands in this manual are based on DSG830, unless otherwise noted.

# Contents

<b>Guaranty and Declaration</b> .....	<b>I</b>
<b>Safety Requirement</b> .....	<b>II</b>
General Safety Summary .....	II
Safety Terms and Symbols .....	IV
Allgemeine Sicherheits Informationen .....	V
Sicherheits Begriffe und Symbole.....	VII
<b>Document Overview</b> .....	<b>VIII</b>
<b>Chapter 1 Programming Overview</b> .....	<b>1-1</b>
To Build Remote Communication .....	1-2
Remote Control Methods .....	1-3
SCPI Command Overview .....	1-4
Syntax.....	1-4
Symbol Description .....	1-4
Parameter Type.....	1-5
Command Abbreviation .....	1-5
<b>Chapter 2 Command System</b> .....	<b>2-1</b>
IEEE488.2 Common Commands.....	2-2
*IDN? .....	2-2
*TRG .....	2-2
:MMEMory Commands .....	2-3
:MMEMory:CATalog .....	2-3
:MMEMory:CATalog:LENGth .....	2-4
:MMEMory:COPI .....	2-4
:MMEMory:DELe .....	2-4
:MMEMory:DISK:FORMat .....	2-5
:MMEMory:DISK:INFormation .....	2-5
:MMEMory:FILEtype .....	2-5
:MMEMory:LDISk:SPACe.....	2-6
:MMEMory:LOAD .....	2-6
:MMEMory:MDIRectory.....	2-6
:MMEMory:MOVE .....	2-7
:MMEMory:PNAME:EDIT .....	2-7
:MMEMory:PNAME:STATe.....	2-8
:MMEMory:SAVe.....	2-8
:OUTPut Command.....	2-9
:OUTPut[:STATe].....	2-9
:SOURce Commands .....	2-10
[:SOURce]:AM Command Subsystem.....	2-10
[:SOURce]:CORRection Command Subsystem.....	2-16
[:SOURce]:FM Command Subsystem.....	2-18
[:SOURce]:FMPM:TYPE.....	2-23
[:SOURce]:FREQuency Command Subsystem .....	2-24
[:SOURce]:INPut:TRIGger:SLOPe.....	2-25
[:SOURce]:LEVel Command Subsystem .....	2-26
[:SOURce]:LFOutput Command Subsystem.....	2-28
[:SOURce]:MODulation:STATe .....	2-30
[:SOURce]:PM Command Subsystem.....	2-31
[:SOURce]:PULM Command Subsystem.....	2-36
[:SOURce]:SWEep Command Subsystem.....	2-46
:STATus Commands .....	2-63
:STATus:OPERation:CONDition .....	2-66
:STATus:OPERation:ENABLe.....	2-66

:STATus:OPERation[:EVENT] .....	2-66
:STATus:QUEStionable:CALibration:CONDition .....	2-67
:STATus:QUEStionable:CALibration:ENABLE .....	2-68
:STATus:QUEStionable:CALibration[:EVENT] .....	2-68
:STATus:QUEStionable:CONDition .....	2-68
:STATus:QUEStionable:CONNect:CONDition .....	2-69
:STATus:QUEStionable:CONNect:ENABLE .....	2-70
:STATus:QUEStionable:CONNect[:EVENT] .....	2-70
:STATus:QUEStionable:ENABLE .....	2-70
:STATus:QUEStionable[:EVENT] .....	2-71
:STATus:QUEStionable:FREQuency:CONDition .....	2-72
:STATus:QUEStionable:FREQuency:ENABLE .....	2-73
:STATus:QUEStionable:FREQuency[:EVENT] .....	2-73
:STATus:QUEStionable:MODulation:CONDition .....	2-74
:STATus:QUEStionable:MODulation:ENABLE .....	2-75
:STATus:QUEStionable:MODulation[:EVENT] .....	2-75
:STATus:QUEStionable:POWER:CONDition .....	2-76
:STATus:QUEStionable:POWER:ENABLE .....	2-77
:STATus:QUEStionable:POWER[:EVENT] .....	2-77
:STATus:QUEStionable:SELFtest:CONDition .....	2-78
:STATus:QUEStionable:SELFtest:ENABLE .....	2-79
:STATus:QUEStionable:SELFtest[:EVENT] .....	2-79
:STATus:QUEStionable:TEMP:CONDition .....	2-80
:STATus:QUEStionable:TEMP:ENABLE .....	2-81
:STATus:QUEStionable:TEMP[:EVENT] .....	2-81
:SYSTem Commands .....	2-82
:SYSTem:BRIGhtness .....	2-83
:SYSTem:CLEar .....	2-83
:SYSTem:COMMunication:INTerface .....	2-83
:SYSTem:COMMunication:LAN:DHCP .....	2-84
:SYSTem:COMMunication:LAN:IP:ADDRESS .....	2-84
:SYSTem:COMMunication:LAN:IP:AUTO .....	2-85
:SYSTem:COMMunication:LAN:IP:GATeway .....	2-85
:SYSTem:COMMunication:LAN:IP:MANual .....	2-86
:SYSTem:COMMunication:LAN:IP:SET .....	2-86
:SYSTem:COMMunication:LAN:IP:SUBnet:MASK .....	2-87
:SYSTem:COMMunication:LAN:RESet .....	2-87
:SYSTem:COMMunication:LAN[:SELF]:PREFerred .....	2-87
:SYSTem:DATE .....	2-88
:SYSTem:DISPlay:UPDate[:STATe] .....	2-88
:SYSTem:FSWitch:STATe .....	2-89
:SYSTem:LANGuage .....	2-89
:SYSTem:LKEY .....	2-90
:SYSTem:POWER:ON:TYPE .....	2-90
:SYSTem:PRESet .....	2-91
:SYSTem:PRESet:TYPE .....	2-91
:SYSTem:PRESet:SAVE .....	2-91
:SYSTem:TIME .....	2-92
:SYSTem:TIME:STATe .....	2-92
:TRIGger Commands .....	2-93
:TRIGger:PULSe[:IMMEDIATE] .....	2-93
:TRIGger[:SWEep][:IMMEDIATE] .....	2-93
:UNIT Command .....	2-94
:UNIT:POWER .....	2-94
<b>Chapter 3 Application Examples .....</b>	<b>3-1</b>
To Output RF signal .....	3-2
To Output RF Sweep Signal .....	3-2

---

To Output RF Modulated Signal.....	3-3
<b>Chapter 4 Programming Demos.....</b>	<b>4-1</b>
Programming Preparations .....	4-2
Excel Programming Demo .....	4-3
Matlab Programming Demo .....	4-7
LabVIEW Programming Demo.....	4-8
Visual Basic Programming Demo.....	4-12
Visual C++ Programming Demo .....	4-15
<b>Chapter 5 Appendix .....</b>	<b>5-1</b>
Appendix A: Command List .....	5-1
Appendix B: Factory Setting .....	5-6
Appendix C: Warranty .....	5-8



# Chapter 1 Programming Overview

This chapter introduces how to build the remote communication between the instrument and PC and provides an overview of the syntax, abbreviation rules and status system of the SCPI commands.

## Main topics of this chapter:

- ◆ [To Build Remote Communication](#)
- ◆ [Remote Control Methods](#)
- ◆ [SCPI Command Overview](#)

## To Build Remote Communication

You can build the remote communication between DSG800 and the PC via USB or LAN interface.

### Operating Steps:

#### 1. Install the Ultra Sigma common PC software

Acquire the Ultra Sigma common PC software from [www.rigol.com](http://www.rigol.com) or the resource CD in the standard accessories; then, install it according to the instructions.

#### 2. Connect the instrument and PC and configure the interface parameters of the instrument

DSG800 supports USB and LAN communication interfaces, as shown in the figure below.

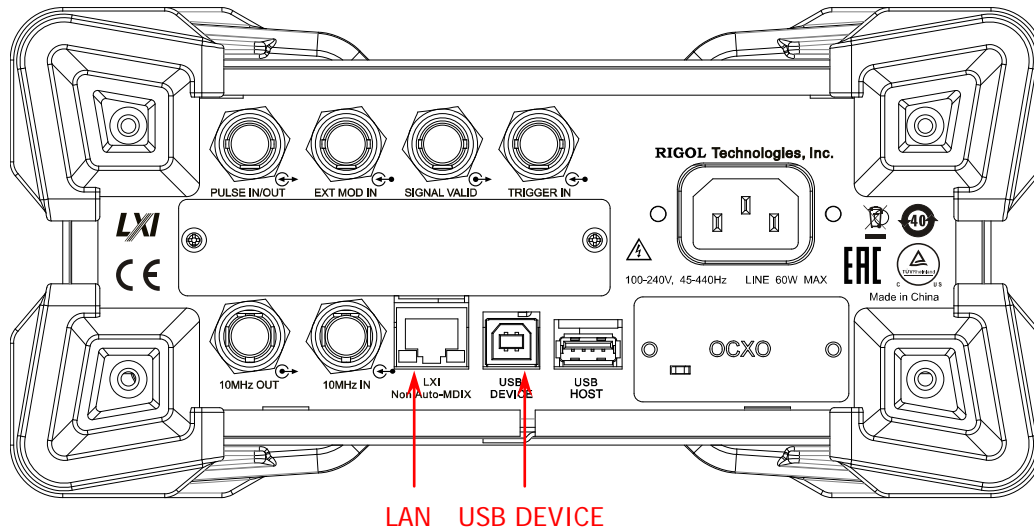

Figure 1-1 DSG800 Communication Interfaces

- (1) Use the USB interface:
  - Connect the USB DEVICE interface at the rear panel of DSG800 and the USB HOST interface of the PC using a USB cable.
- (2) Use the LAN interface:
  - Make sure that your PC is connected to the local network.
  - Check whether your local network supports DHCP or auto IP mode. If not, you need to acquire the network interface parameters available, including the IP address, subnet mask, gateway and DNS.
  - Connect DSG800 to the local network using a network cable.
  - Press **System** → **I/O Config** → **LAN** to configure the IP address, subnet mask, gateway and DNS of the instrument.

#### 3. Check whether the connection is successful

Start-up Ultra Sigma, search for the RF signal generator resource, right-click the resource name and select "SCPI Panel Control" from the pop-up menu. Enter the correct command in the pop-up SCPI control panel and click **Send Command**, **Read Response** or **Send&Read** to check whether the connection is successful, as shown in the figure on the next page (take the USB interface as an example).



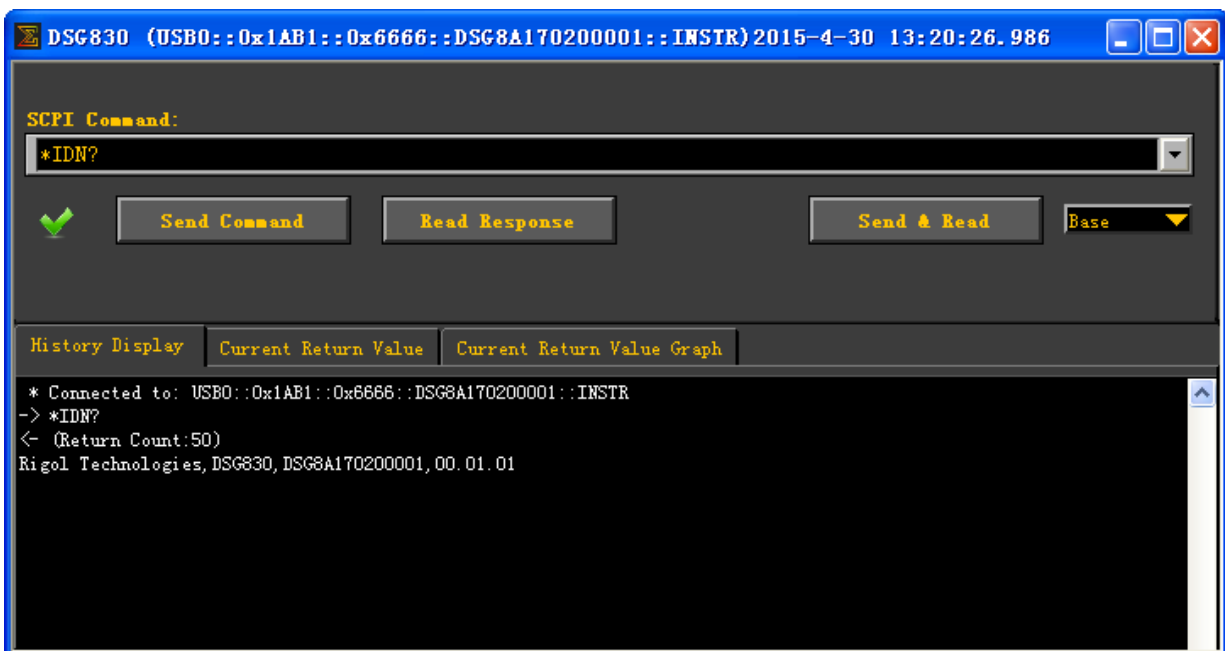
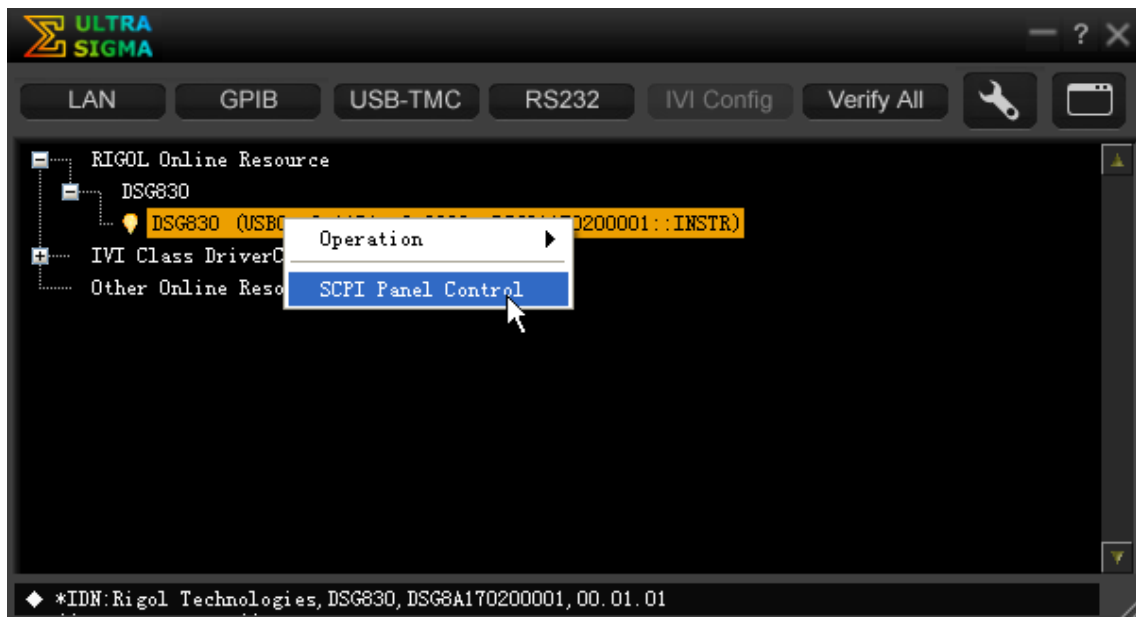

## Remote Control Methods

### 1. User-defined programming

You can program and control DSG800 using the SCPI (Standard Commands for Programmable Instruments) commands listed in chapter 2 [Command System](#) in various development environments (such as Visual C++, Visual Basic and LabVIEW). For the details, refer to the introductions in chapter 4 [Programming Demos](#).

### 2. Send SCPI commands via PC software

You can use the PC software Ultra Sigma (provided by **RIGOL**) to send SCPI commands to control the RF signal generator remotely.

## SCPI Command Overview

SCPI (Standard Commands for Programmable Instruments) is a standardized instrument programming language that is based on the standard IEEE488.1 and IEEE488.2 and conforms to various standards (such as the floating point operation rule in IEEE754 standard, ISO646 7-bit coded character for information interchange (equivalent to ASCII programming)). This chapter describes the syntax, symbols, parameters and abbreviation rules of the SCPI commands.

### Syntax

SCPI commands present a hierarchical tree structure and have multiple sub-systems, each of which contains a root keyword and one or more sub-keywords. The command string usually begins with ":"; the keywords are separated by ":" and are followed by the parameter settings available; "?" is added at the end of the command string to indicate query; space is used to separate the command and parameter.

For example,

```
:SYSTem:COMMunication:LAN:IP:ADDRESS <value>
:SYSTem:COMMunication:LAN:IP:ADDRESS?
```

SYSTem is the root keyword of the command above. COMMunication, LAN, IP and ADDRESS are the second-level, third-level, forth-level and fifth-level keywords respectively. The command string begins with ":" which is also used to separate the multi-level keywords. <value> denotes the parameter available for setting. "?" denotes query and the RF signal generator returns the response information (the output value or internal setting value of the instrument) when receiving a query command. The command :SYSTem:COMMunication:LAN:IP:ADDRESS and parameter <value> are separated by a space.

"," is generally used for separating different parameters contained in the same command; for example, [:SOURce]:SWEep:LIST:LIST? <Start>,<Count>

### Symbol Description

The following four symbols are not the content of SCPI commands and will not be sent with the command; but, they are usually used to describe the parameters in the commands.

#### 1. Braces { }

Multiple optional parameters are enclosed in the braces and one of the parameters must be selected when sending the command.

#### 2. Vertical Bar |

The vertical bar is used to separate multiple parameters. When you send a command, one of the parameters must be selected. For example, the :SYSTem:LANGUage CHINese|ENGLish command.

#### 3. Square Brackets [ ]

The contents (command keywords) enclosed in the square brackets are optional and will be executed no matter whether they are omitted or not. For example, for the [:SOURce]:AM[:DEPT]h? command, sending any of the four commands below can generate the same effect.

```
:AM?
:AM:DEPT?
:SOURce:AM?
:SOURce:AM:DEPT?
```

#### 4. Triangle Brackets < >

The parameter enclosed in the triangle brackets must be replaced by an effective value. For example, send the [:SOURce]:FREQUency <value> command in :FREQUency 4MHz form.

## Parameter Type

The parameters of the commands introduced in this manual contains 5 types: bool, integer, real number, discrete and ASCII string.

### 1. Bool

The parameter could be OFF, ON, 0 or 1. For example, [:SOURce]:AM:STATe ON|OFF|1|0.

### 2. Integer

Unless otherwise noted, the parameter can be any integer within the effective value range. Note that do not set the parameter to a decimal; otherwise, errors will occur. For example, in the :SYSTem:BRIGHtness <value> command, <value> can be any integer from 1 to 8.

### 3. Real Number

Unless otherwise noted, the parameter can be any value within the effective value range. For example, <value> in the [:SOURce]:AM:FREQUency <value> command can be any real number from 10Hz to 100kHz.

### 4. Discrete

The parameter could only be one of the specified values or characters. For example, in the [:SOURce]:AM:WAVEform SINE|SQUA command, the parameter can only be SINE or SQUA.

### 5. ASCII String

The parameter should be the combinations of ASCII characters. For example, in the :MMEMory:SAVe <file\_name> command, <file\_name> is the filename of the file to be saved and can include Chinese characters (a Chinese character occupies two bytes), English characters and numbers. The filename cannot exceed 28 bytes.

## Command Abbreviation

All the commands are case-insensitive and you can use any of them. If abbreviation is used, all the capital letters in the command must be written completely. For example, the :MMEMory:DISK:FORMat command can be abbreviated to :MMEM:DISK:FORM.



## Chapter 2 Command System

This chapter introduces the syntax, function, parameter and using instruction of each DSG800 command in alphabetical (A to Z) order.

### Main topics of this chapter:

- ◆ [IEEE488.2 Common Commands](#)
- ◆ [:MMEMory Commands](#)
- ◆ [:OUTPut Command](#)
- ◆ [:SOURce Commands](#)
- ◆ [:STATus Commands](#)
- ◆ [:SYSTem Commands](#)
- ◆ [:TRIGger Commands](#)
- ◆ [:UNIT Command](#)

## IEEE488.2 Common Commands

The IEEE488.2 common commands are used to query the basic information about the instrument or execute common operations. These commands usually begin with "\*", contain a 3-character command keyword and relate to the status register.

### Command List<sup>[1]</sup>:

- ◆ [\\*IDN?](#)
- ◆ [\\*TRG](#)

### \*IDN?

**Syntax** \*IDN?

**Description** Query the ID string of the instrument.

**Return Format** The query returns the ID string of the instrument. For example, Rigol Technologies,DSG830,DSG8A170200001,00.01.01.

### \*TRG

**Syntax** \*TRG

**Description** Trigger a pulse modulation or RF sweep immediately.

**Related Commands** [:TRIGger:PULSe\[:IMMediate\]](#)  
[:TRIGger\[:SWEep\]\[:IMMediate\]](#)

---

**Note<sup>[1]</sup>:** In the "Command List" in this manual, the parameters in the setting commands and the query commands are not included and you can refer to the complete introductions of the commands in the text according to the keywords.

## :MMEMory Commands

The :MMEMory commands are used to store files to the internal or external memory of the instrument, read or delete the specified file as well as query the disk information.

### Command List:

- ◆ [:MMEMory:CATalog](#)
- ◆ [:MMEMory:CATalog:LENGth](#)
- ◆ [:MMEMory:COpy](#)
- ◆ [:MMEMory:DELeTe](#)
- ◆ [:MMEMory:DISK:FORMat](#)
- ◆ [:MMEMory:DISK:INFormation](#)
- ◆ [:MMEMory:FILEType](#)
- ◆ [:MMEMory:LDISK:SPACe](#)
- ◆ [:MMEMory:LOAD](#)
- ◆ [:MMEMory:MDIRectory](#)
- ◆ [:MMEMory:MOVE](#)
- ◆ [:MMEMory:PNAME:EDIT](#)
- ◆ [:MMEMory:PNAME:STATe](#)
- ◆ [:MMEMory:SAVe](#)

## :MMEMory:CATalog

**Syntax** :MMEMory:CATalog? <path>

**Description** Query all the files and folders under the specified path.

Parameter	Name	Type	Range	Default
	<path>	ASCII string	Valid path	--

- Explanation**
- <path>: the local memory (D disk), external memory (E disk; when a USB storage device is detected by the USB HOST interface at the rear panel) or the subdirectory under the D or E disk.
  - The query returns a list of all the files and folders under the path specified by <path>.

**Return Format** NO.1 File Name: Rigol  
NO.2 File Name: 4.STA

**Example** :MMEM:CAT? D:

## :MMEMory:CATalog:LENGth

**Syntax** :MMEMory:CATalog:LENGth? <path>

**Description** Query the number of files and folders under the specified path.

Parameter	Name	Type	Range	Default
	<path>	ASCII string	Valid path	--

**Explanation** <path> can be the local memory (D disk), external memory (E disk; when a USB storage device is detected by the USB HOST interface at the rear panel) or the subdirectory under the D or E disk.

**Return Format** The query returns an integer. For example, 2.

**Example** :MMEM:CAT:LENG? D: /\*Query and return the number of files and folders in the D disk\*/

## :MMEMory:COpy

**Syntax** :MMEMory:COpy <file\_source>,<file\_destination>

**Description** Copy the file or folder specified by <file\_source> to the destination path specified by <file\_destination>.

Parameter	Name	Type	Range	Default
	<file_source>	ASCII string	The name of the file or folder to be copied	--
	<file_destination>	ASCII string	Valid destination path	--

**Explanation**

- <file\_source> denotes the file or folder to be copied. The file or folder name must contain the path. <file\_destination> denotes the destination path and does not include the filename.
- If the file or folder specified by <file\_source> does not exist, the operation fails.
- If the destination path specified by <file\_destination> does not exist, the copy operation fails.

**Example** :MMEM:COpy D:\1.STA,D:\

## :MMEMory:DELeTe

**Syntax** :MMEMory:DELeTe <file\_name>

**Description** Delete the specified file or folder under the specified operation path.

Parameter	Name	Type	Range	Default
	<file_name>	ASCII string	The name of the file or folder to be deleted	--

**Explanation**

- This command is valid only when the specified file or folder exists under the current operation path or the specified path.
- <file\_name> can be the name of a file or folder under the current operation path or a file or folder name containing the specified path. For example, :MMEM:DEL D:\NEW\8.STA.

**Example** :MMEM:DEL 8.STA /\*Delete the file named "8.STA" under the current operation path\*/



**:MMEMory:DISK:FORMat****Syntax** :MMEMory:DISK:FORMat**Description** Format the local disk (D disk).**:MMEMory:DISK:INFormation****Syntax** :MMEMory:DISK:INFormation? <Disk>**Description** Query the information of the local disk.**Parameter**

Name	Type	Range	Default
<Disk>	ASCII string	D: (or LOCAL)	D: (or LOCAL)

**Return Format** The query returns the information of the local disk, including the disk name, file system, total space, used space and free space. For example,

Disk:D: (or Disk:LOCAL)

File Sys:FAT32

Total:1.0 GB

Used:512 KB

Free:0.99 GB

**Example** :MMEM:DISK:INF? D: /\*The query returns the information of D disk\*/**:MMEMory:FILEtype****Syntax** :MMEMory:FILEtype ALL|STATE|FLACsv|SWPCsv|TRNCsv

:MMEMory:FILEtype?

**Description** Set the file type.

Query the current file type.

**Parameter**

Name	Type	Range	Default
ALL STATE FLACsv SWPCsv TRNCsv	Discrete	ALL STATE FLACsv SWPCsv TRNCsv	ALL

- Explanation**
- The file types available are all, state, flatness csv, sweep csv and train csv.
  - After selecting the corresponding file type, you can view all the files of this file type or save a new file of this file type.

**Return Format** The query returns ALL, STATE, FLACSV, SWPCSV or TRNCsv.**Example** :MMEM:FILE STATE /\*Set the file type to "State"\*/

:MMEM:FILE? /\*Query the current file type and the query returns STATE\*/

### :MMEMory:LDISK:SPACE

**Syntax** :MMEMory:LDISK:SPACE?

**Description** Query the space information of the local disk (D disk).

**Return Format** The query returns the D disk space information including the "Used space" and "Free space". For example, Used:512 k,Free:1048064 k.

### :MMEMory:LOAD

**Syntax** :MMEMory:LOAD <file\_name>

**Description** Read the specified file in the specified operation path.

Parameter	Name	Type	Range	Default
	<file_name>	ASCII string	The name of the file to be read	--

- Explanation**
- This command is valid only when the specified file exists under the current operation path or the specified path.
  - <file\_name> can be the name of a file under the current operation path or a file name containing the specified path. For example, MMEM:LOAD D:\NEW\2.STA.

**Example** :MMEM:LOAD 2.STA /\*Read the file named "2.STA" under the current operation path\*/

### :MMEMory:MDIRECTory

**Syntax** :MMEMory:MDIRECTory <directory\_name>

**Description** Create a new folder under the specified operation path.

Parameter	Name	Type	Range	Default
	<directory_name>	ASCII string	The name of the folder to be created	--

- Explanation**
- The folder name can include Chinese characters (a Chinese character occupies two bytes), English characters or numbers. The folder name cannot exceed 28 bytes.
  - If the name of the folder to be created already exists, this operation is invalid. At this point, "The filename already exists" is displayed in the user interface.
  - <directory\_name> can be a new folder name that does not contain the path (denote creating a folder under the current operation path) or a folder name that contains the specified path (denote creating a new folder under the specified path; for example, :MMEM:MDIR D:\1\NEW).

**Example** :MMEM:MDIR NEW /\*Create a folder named "NEW" under the current operation path\*/

**:MMEMory:MOVE**

**Syntax** :MMEMory:MOVE <file\_source>,<file\_destination>

**Description** Rename the file or folder specified by <file\_source> as the destination file or folder name specified by <file\_destination>.

Parameter	Name	Type	Range	Default
	<file_source>	ASCII string	Valid file or folder name	--
	<file_destination>			

- Explanation**
- The file or folder names specified by <file\_source> and <file\_destination> must contain the path.
  - If the file or folder specified by <file\_source> does not exist, the rename operation fails.
  - If the destination file or folder name specified by <file\_destination> already exists under the current path, the rename operation fails.

**Example** :MMEM:MOVE D:\1.STA, D:\2.STA

**:MMEMory:PNAME:EDIT**

**Syntax** :MMEMory:PNAME:EDIT <pre\_name>

:MMEMory:PNAME:EDIT?

**Description** Edit and save the filename prefix.

Query the filename prefix saved.

Parameter	Name	Type	Range	Default
	<pre_name>	ASCII string	The filename prefix to be edited	--

**Explanation** You can edit any filename prefix.

**Return Format** The query returns the filename prefix. For example, N.

**Example** :MMEM:PNAM:EDIT N /\*Edit the filename prefix as N\*/

:MMEM:PNAM:EDIT? /\*The query returns N\*/

**Related Command** [:MMEMory:PNAME:STATe](#)

**:MMEMemory:PNAME:STATE**

**Syntax** :MMEMemory:PNAME:STATE ON|OFF|1|0

:MMEMemory:PNAME:STATE?

**Description** Turn on or off the filename prefix.

Query the current on/off state of the filename prefix.

Parameter	Name	Type	Range	Default
	ON OFF 1 0	Bool	ON OFF 1 0	OFF 0

- Explanation**
- ON|1: turn on the filename prefix edited.
  - OFF|0: turn off the filename prefix edited.
  - If the filename prefix is turned on, the prefix edited will be added to the filename input box automatically when saving a file.

**Return Format** The query returns 0 or 1.

**Example** :MMEMemory:PNAME:STATE ON

:MMEMemory:PNAME:STATE?

**Related Command** [:MMEMemory:PNAME:EDIT](#)

**:MMEMemory:SAVE**

**Syntax** :MMEMemory:SAVE <File\_name>

**Description** Save the file with the specified filename under the current operation path.

Parameter	Name	Type	Range	Default
	<file_name>	ASCII string	The name of the file to be saved	--

- Explanation**
- The filename can include Chinese characters (a Chinese character occupies two bytes), English characters or numbers. The filename cannot exceed 28 bytes.
  - When the current path already contains a file with the same name, this command will directly overwrite the original file.

**Example** :MMEMemory:SAVE SET.STA /\*Save the current instrument state with the filename "SET.STA" under the current operation path\*/

## :OUTPut Command

### Command List:

#### ◆ [:OUTPut](#)

### :OUTPut[:STATe]

**Syntax** :OUTPut[:STATe] ON|OFF|1|0  
:OUTPut[:STATe]?

**Description** Turn on or off the RF output.

Query the on/off state of the RF output.

#### Parameter

Name	Type	Range	Default
ON OFF 1 0	Bool	ON OFF 1 0	OFF 0

- Explanation**
- ON|1: turn on the RF output. At this point, the backlight of **RF/on** goes on.
  - OFF|0: turn off the RF output. At this point, the backlight of **RF/on** goes off.

**Return Format** The query returns 1 or 0.

**Example** :OUTP ON /\*Turn on the RF output\*/  
:OUTP? /\*The query returns 1\*/

## :SOURce Commands

The :SOURce commands are used to set the related parameters of the main functions of the RF signal generator including the frequency, level, flatness calibration, AM, FM/ØM, Pulse, SWEEP, LF output and so on.

### Command List:

- ◆ [\[:SOURce\]:AM Command Subsystem](#)
- ◆ [\[:SOURce\]:CORRection Command Subsystem](#)
- ◆ [\[:SOURce\]:FM Command Subsystem](#)
- ◆ [\[:SOURce\]:FMPM:TYPE](#)
- ◆ [\[:SOURce\]:FREQuency Command Subsystem](#)
- ◆ [\[:SOURce\]:INPut:TRIGger:SLOPe](#)
- ◆ [\[:SOURce\]:LEVel Command Subsystem](#)
- ◆ [\[:SOURce\]:LFOutput Command Subsystem](#)
- ◆ [\[:SOURce\]:MODulation:STATe](#)
- ◆ [\[:SOURce\]:PM Command Subsystem](#)
- ◆ [\[:SOURce\]:PULM Command Subsystem](#)
- ◆ [\[:SOURce\]:SWEep Command Subsystem](#)

## [:SOURce]:AM Command Subsystem

### Command List:

- ◆ [\[:SOURce\]:AM\[:DEPT\]h\]](#)
- ◆ [\[:SOURce\]:AM\[:DEPT\]h\[:STEP\[:INCR\]ement\]](#)
- ◆ [\[:SOURce\]:AM:EXT:COUP](#)
- ◆ [\[:SOURce\]:AM:EXT:IMP](#)
- ◆ [\[:SOURce\]:AM:FREQuency](#)
- ◆ [\[:SOURce\]:AM:FREQuency:STEP\[:INCR\]ement\]](#)
- ◆ [\[:SOURce\]:AM:SOURce](#)
- ◆ [\[:SOURce\]:AM:STATe](#)
- ◆ [\[:SOURce\]:AM:WAVEform](#)

**[[:SOURce]:AM[:DEPT]h]****Syntax** [[:SOURce]:AM[:DEPT]h] <value>

[[:SOURce]:AM[:DEPT]h]?

**Description** Set the AM modulation depth.

Query the AM modulation depth.

**Parameter**

Name	Type	Range	Default
<value>	Real	0 to 100	50

**Explanation**

- When "Int" modulation source is selected, the AM modulation depth ( $m_a$ ) and amplitude difference ( $\Delta P_{sb}$ ) between the carrier and sidebands satisfy the following relation:  $\Delta P_{sb} = 6 - 20 \lg m_a$ .
- <value> can also be expressed as percentage. For example, 80%.
- After the modulation depth is set, you can rotate the knob to modify the modulation depth at the current step. You can set and query the current step using the [\[:SOURce\]:AM\[:DEPT\]h:STEP\[:INCR\]ement](#) command.

**Return Format** The query returns the modulation depth. For example, 80.00.**Example** :AM:DEPT 80

:AM:DEPT?

**Related Command** [\[:SOURce\]:AM\[:DEPT\]h:STEP\[:INCR\]ement](#)**[[:SOURce]:AM[:DEPT]h:STEP[:INCR]ement]****Syntax** [[:SOURce]:AM[:DEPT]h:STEP[:INCR]ement] <value>

[[:SOURce]:AM[:DEPT]h:STEP[:INCR]ement]?

**Description** Set the AM modulation depth step.

Query the AM modulation depth step.

**Parameter**

Name	Type	Range	Default
<value>	Real	0.1 to 50	10

**Explanation**

- <value> can also be expressed as percentage. For example, 0.2%.
- After the modulation depth step is set, you can rotate the knob to modify the modulation depth at the current step. At this point, you can query or set the modulation depth using the [\[:SOURce\]:AM\[:DEPT\]h](#) command.

**Return Format** The query returns the modulation depth step. For example, 0.20.**Example** AM:DEPT:STEP:INCR 0.2

AM:DEPT:STEP:INCR?

**Related Command** [\[:SOURce\]:AM\[:DEPT\]h](#)

**[[:SOURce]:AM:EXT:COUP**

**Syntax** [:SOURce]:AM:EXT:COUP AC|DC

[:SOURce]:AM:EXT:COUP?

**Description** Set the coupling mode of AM external modulation.

Query the coupling mode of AM external modulation.

**Parameter**

Name	Type	Range	Default
AC DC	Discrete	AC DC	AC

- Explanation**
- AC: set the coupling mode of AM external modulation to "AC".
  - DC: set the coupling mode of AM external modulation to "DC".
  - When the modulation source of AM is set to "Int", this command is invalid.

**Return Format** The query returns AC or DC.

**Example** :AM:EXT:COUP AC

:AM:EXT:COUP?

**Related Command** [\[:SOURce\]:AM:SOURce](#)

**[[:SOURce]:AM:EXT:IMP**

**Syntax** [:SOURce]:AM:EXT:IMP 50|600|100k

[:SOURce]:AM:EXT:IMP?

**Description** Set the impedance of AM external modulation.

Query the impedance of AM external modulation.

**Parameter**

Name	Type	Range	Default
50 600 100k	Discrete	50 600 100k	100k

- Explanation**
- 50: set the impedance of AM external modulation to "50ohm".
  - 600: set the impedance of AM external modulation to "600ohm".
  - 100k: set the impedance of AM external modulation to "100kohm".
  - When the modulation source of AM is set to "Int", this command is invalid.

**Return Format** The query returns 50, 600 or 100k.

**Example** :AM:EXT:IMP 600

:AM:EXT:IMP?

**Related Command** [\[:SOURce\]:AM:SOURce](#)



**[[:SOURce]:AM:FREQuency]**

**Syntax** [:SOURce]:AM:FREQuency <value>

[:SOURce]:AM:FREQuency?

**Description** Set the AM modulation frequency.

Query the AM modulation frequency.

**Parameter**

Name	Type	Range	Default
<value>	Real	10Hz to 100kHz (Sine)/10Hz to 20kHz (Square)	10kHz

**Explanation**

- When <value> is set in "Number" form, the default unit is Hz; for example, 20000. In addition, <value> can also be set in "Number + Unit" form; for example, 20kHz.
- After the modulation frequency is set, you can rotate the knob to modify the modulation frequency at the current step. You can set and query the current step using the [\[:SOURce\]:AM:FREQuency:STEP\[:INCRement\]](#) command.
- When the modulation source of AM is set to "Ext", this command is invalid.

**Return Format** The query returns the AM modulation frequency. For example, 20.00000kHz.

**Example** :AM:FREQ 20kHz

:AM:FREQ?

**Related Commands**

[\[:SOURce\]:AM:FREQuency:STEP\[:INCRement\]](#)

[\[:SOURce\]:AM:SOURce](#)

**[[:SOURce]:AM:FREQuency:STEP[:INCRement]]**

**Syntax** [:SOURce]:AM:FREQuency:STEP[:INCRement] <value>

[:SOURce]:AM:FREQuency:STEP[:INCRement]?

**Description** Set the AM modulation frequency step.

Query the AM modulation frequency step.

**Parameter**

Name	Type	Range	Default
<value>	Real	1Hz to 50kHz	1kHz

**Explanation**

- When <value> is set in "Number" form, the default unit is Hz. In addition, <value> can also be set in "Number + Unit" form; for example, 3.55kHz.
- After the modulation frequency step is set, you can rotate the knob to modify the modulation frequency at the current step. At this point, you can query or set the modulation frequency using the [\[:SOURce\]:AM:FREQuency](#) command.

**Return Format** The query returns the AM modulation frequency step. For example, 3.55000kHz.

**Example** :AM:FREQ:STEP 3.55kHz

:AM:FREQ:STEP?

**Related Command**

[\[:SOURce\]:AM:FREQuency](#)

**[[:SOURce]:AM:SOURce**

**Syntax** [:SOURce]:AM:SOURce EXTernal|INTernal  
[:SOURce]:AM:SOURce?

**Description** Set the AM modulation source.

Query the AM modulation source.

**Parameter**

Name	Type	Range	Default
EXTernal INTernal	Discrete	EXTernal INTernal	INTernal

**Explanation**

- EXTernal: set the modulation source to "Ext". At this point, the external modulating signal is input from the **[EXT MOD IN]** connector.
- INTernal: set the modulation source to "Int". At this point, the instrument provides the modulating signal and you can set the modulation frequency and modulation waveform of the modulating signal.

**Return Format** The query returns the AM modulation source. For example, EXT.

**Example** :AM:SOUR EXT  
:AM:SOUR?

**Related Commands** [\[:SOURce\]:AM:FREQuency](#)  
[\[:SOURce\]:AM:WAVEform](#)

**[[:SOURce]:AM:STATE**

**Syntax** [:SOURce]:AM:STATe ON|OFF|1|0  
[:SOURce]:AM:STATe?

**Description** Set the state of the AM switch.

Query the state of the AM switch.

**Parameter**

Name	Type	Range	Default
ON OFF 1 0	Bool	ON OFF 1 0	OFF 0

**Explanation**

- ON|1: turn on the AM switch to enable the AM function.
- OFF|0: turn off the AM switch to disable the AM function.

**Return Format** The query returns 1 or 0.

**Example** :AM:STAT ON /\*Turn on the AM switch\*/  
:AM:STAT? /\*The query returns 1\*/

**[[:SOURce]:AM:WAVEform**

**Syntax** [:SOURce]:AM:WAVEform SINE|SQUA  
[:SOURce]:AM:WAVEform?

**Description** Set the AM modulation waveform.  
Query the AM modulation waveform.

**Parameter**

Name	Type	Range	Default
SINE SQUA	Discrete	SINE SQUA	SINE

**Explanation**

- SINE: set the AM modulation waveform to "Sine".
- SQUA: set the AM modulation waveform to "Square".
- When the modulation source of AM is set to "Ext", this command is invalid.

**Return Format** The query returns SINE or SQUA.

**Example** :AM:WAVE SQUA  
:AM:WAVE?

**Related Command** [\[:SOURce\]:AM:SOURce](#)

## [[:SOURce]:CORRection Command Subsystem

### Command List:

- ◆ [\[:SOURce\]:CORRection:FLATness:COUNT](#)
- ◆ [\[:SOURce\]:CORRection:FLATness:LIST](#)
- ◆ [\[:SOURce\]:CORRection:FLATness\[:STATe\]](#)

### [[:SOURce]:CORRection:FLATness:COUNT

**Syntax** [:SOURce]:CORRection:FLATness:COUNT?

**Description** Query the number of points in the current flatness calibration list.

**Return Format** The query returns the number of points in the flatness calibration list in integer. For example, 5.

### [[:SOURce]:CORRection:FLATness:LIST

**Syntax** [:SOURce]:CORRection:FLATness:LIST? <Start>,<Count>

**Description** Query the flatness calibration list data within the specified range.

**Parameter**

Name	Type	Range	Default
<Start>	Integer	1 to the total number of rows in the current list	--
<Count>	Integer	1 to the total number of rows in the current list	--

- Explanation**
- <Start>: the number of the start row of the data to be acquired.
  - <Count>: the total number of rows of the data to be acquired.

**Return Format** The query returns the flatness calibration list data acquired. For example,

NO.1:304000000.000000 , 7.450000

NO.2:800000000.000000 , -17.799999

**Example** :CORR:FLAT:LIST? 2,2 /\*Query and return two rows of calibration data starting from the 2nd row of the flatness calibration list\*/

**Related Command** [\[:SOURce\]:CORRection:FLATness:COUNT](#)

**[[:SOURce]:CORRection:FLATness[:STATe]]**

**Syntax** [:SOURce]:CORRection:FLATness[:STATe] ON|OFF|1|0  
[:SOURce]:CORRection:FLATness[:STATe]?

**Description** Turn on or off the flatness calibration switch.  
Query the state of the flatness calibration switch.

**Parameter**

Name	Type	Range	Default
ON OFF 1 0	Bool	ON OFF 1 0	OFF 0

**Explanation**

- ON|1: turn on the flatness calibration switch.
- OFF|0: turn off the flatness calibration switch.

**Return Format** The query returns 1 or 0.

**Example** :CORR:FLAT ON /\*Turn on the flatness calibration switch\*/  
:CORR:FLAT? /\*The query returns 1\*/

## [:SOURce]:FM Command Subsystem

### Command List:

- ◆ [\[:SOURce\]:FM\[:DEViation\]](#)
- ◆ [\[:SOURce\]:FM\[:DEViation\]:STEP\[:INCRement\]](#)
- ◆ [\[:SOURce\]:FM:EXT:COUP](#)
- ◆ [\[:SOURce\]:FM:EXT:IMP](#)
- ◆ [\[:SOURce\]:FM:FREQuency](#)
- ◆ [\[:SOURce\]:FM:FREQuency:STEP\[:INCRement\]](#)
- ◆ [\[:SOURce\]:FM:SOURce](#)
- ◆ [\[:SOURce\]:FM:STATe](#)
- ◆ [\[:SOURce\]:FM:WAVEform](#)

### [:SOURce]:FM[:DEViation]

**Syntax** [:SOURce]:FM[:DEViation] <value>  
[:SOURce]:FM[:DEViation]?

**Description** Set the FM frequency deviation.

Query the FM frequency deviation.

#### Parameter

Name	Type	Range	Default
<value>	Real	100mHz to 1MHz	10kHz

- Explanation**
- When <value> is set in "Number" form, the default unit is Hz; for example, 20000. In addition, <value> can also be set in "Number + Unit" form; for example, 20kHz.
  - After the frequency deviation is set, you can rotate the knob to modify the deviation at the current step. You can set and query the current step using the [\[:SOURce\]:FM\[:DEViation\]:STEP\[:INCRement\]](#) command.

**Return Format** The query returns the FM frequency deviation. For example, 20.00000kHz.

**Example** :FM:DEV 20kHz  
:FM:DEV?

**Related Command** [\[:SOURce\]:FM\[:DEViation\]:STEP\[:INCRement\]](#)

**[[:SOURce]:FM[:DEVIation]:STEP[:INCRement]]**

**Syntax** [:SOURce]:FM[:DEVIation]:STEP[:INCRement] <value>  
[:SOURce]:FM[:DEVIation]:STEP[:INCRement]?

**Description** Set the FM frequency deviation step.  
Query the FM frequency deviation step.

Parameter	Name	Type	Range	Default
	<value>	Real	10mHz to 500kHz	1kHz

**Explanation**

- When <value> is set in "Number" form, the default unit is Hz; for example, 5000. In addition, <value> can also be set in "Number + Unit" form; for example, 5kHz.
- After the frequency deviation step is set, you can rotate the knob to modify the deviation at the current step. At this point, You can query or set the current frequency deviation using the [\[:SOURce\]:FM\[:DEVIation\]](#) command.

**Return Format** The query returns the FM frequency deviation step. For example, 5.00000kHz.

**Example** :FM:STEP:INCR 5kHz  
:FM:STEP:INCR?

**Related Command** [\[:SOURce\]:FM\[:DEVIation\]](#)

**[[:SOURce]:FM:EXT:COUP]**

**Syntax** [:SOURce]:FM:EXT:COUP AC|DC  
[:SOURce]:FM:EXT:COUP?

**Description** Set the coupling mode of FM external modulation.  
Query the coupling mode of FM external modulation.

Parameter	Name	Type	Range	Default
	AC DC	Discrete	AC DC	AC

**Explanation**

- AC: set the coupling mode of FM external modulation to "AC".
- DC: set the coupling mode of FM external modulation to "DC".
- When the modulation source of FM is set to "Int", this command is invalid.

**Return Format** The query returns AC or DC.

**Example** :FM:EXT:COUP AC  
:FM:EXT:COUP?

**Related Command** [\[:SOURce\]:FM:SOURce](#)

**[[:SOURce]:FM:EXT:IMP**

**Syntax** [:SOURce]:FM:EXT:IMP 50|600|100k

[:SOURce]:FM:EXT:IMP?

**Description** Set the impedance of FM external modulation.

Query the impedance of FM external modulation.

**Parameter**

Name	Type	Range	Default
50 600 100k	Discrete	50 600 100k	100k

- Explanation**
- 50: set the impedance of FM external modulation to "50ohm".
  - 600: set the impedance of FM external modulation to "600ohm".
  - 100k: set the impedance of FM external modulation to "100kohm".
  - When the modulation source of FM is set to "Int", this command is invalid.

**Return Format** The query returns 50, 600 or 100k.

**Example** :FM:EXT:IMP 600

:FM:EXT:IMP?

**Related Command** [\[:SOURce\]:FM:SOURce](#)

**[[:SOURce]:FM:FREQuency**

**Syntax** [:SOURce]:FM:FREQuency <value>

[:SOURce]:FM:FREQuency?

**Description** Set the FM modulation frequency.

Query the FM modulation frequency.

**Parameter**

Name	Type	Range	Default
<value>	Real	10Hz to 100kHz (Sine)/10Hz to 20kHz (Square)	10kHz

- Explanation**
- When <value> is set in "Number" form, the default unit is Hz; for example, 20000. In addition, <value> can also be set in "Number + Unit" form; for example, 20kHz.
  - After the modulation frequency is set, you can rotate the knob to modify the modulation frequency at the current step. At this point, you can set and query the current step using the [\[:SOURce\]:FM:FREQuency:STEP\[:INCRement\]](#) command.
  - When the modulation source of FM is set to "Ext", this command is invalid.

**Return Format** The query returns the FM modulation frequency. For example, 20.00000kHz.

**Example** :FM:FREQ 20kHz

:FM:FREQ?

**Related Commands** [\[:SOURce\]:FM:FREQuency:STEP\[:INCRement\]](#)  
[\[:SOURce\]:FM:SOURce](#)



**[[:SOURce]:FM:FREQuency:STEP[:INCRement]]**

**Syntax** [:SOURce]:FM:FREQuency:STEP[:INCRement] <value>  
[:SOURce]:FM:FREQuency:STEP[:INCRement]?

**Description** Set the FM modulation frequency step.  
Query the FM modulation frequency step.

Parameter	Name	Type	Range	Default
	<value>	Real	1Hz to 50kHz	1kHz

**Explanation**

- When <value> is set in "Number" form, the default unit is Hz; for example, 5000. In addition, <value> can also be set in "Number + Unit" form; for example, 5kHz.
- After the modulation frequency step is set, you can rotate the knob to modify the modulation frequency at the current step. At this point, you can query or set the modulation frequency using the [\[:SOURce\]:FM:FREQuency](#) command.

**Return Format** The query returns the FM modulation frequency step. For example, 5.00000kHz.

**Example** :FM:FREQ:STEP 5kHz  
:FM:FREQ:STEP?

**Related Command** [\[:SOURce\]:FM:FREQuency](#)

**[[:SOURce]:FM:SOURce]**

**Syntax** [:SOURce]:FM:SOURce EXTernal|INTernal  
[:SOURce]:FM:SOURce?

**Description** Set the FM modulation source.  
Query the FM modulation source.

Parameter	Name	Type	Range	Default
	EXTernal INTernal	Discrete	EXTernal INTernal	INTernal

**Explanation**

- EXTernal: set the modulation source to "Ext". At this point, the external modulating signal is input from the **[EXT MOD IN]** connector.
- INTernal: set the modulation source to "Int". At this point, the instrument provides the modulating signal and you can set the modulation frequency and modulation waveform of the modulating signal.

**Return Format** The query returns the FM modulation source. For example, INT.

**Example** :FM:SOUR INT  
:FM:SOUR?

**Related Commands** [\[:SOURce\]:FM:FREQuency](#)  
[\[:SOURce\]:FM:WAVEform](#)

**[[:SOURce]:FM:STATe**

**Syntax** [:SOURce]:FM:STATe ON|OFF|1|0  
[:SOURce]:FM:STATe?

**Description** Set the state of the FM switch.

Query the state of the FM switch.

**Parameter**

Name	Type	Range	Default
ON OFF 1 0	Bool	ON OFF 1 0	OFF 0

- Explanation**
- ON|1: turn on the FM switch to enable the FM function.
  - OFF|0: turn off the FM switch to disable the FM function.

**Return Format** The query returns 1 or 0.

**Example** :FM:STAT ON /\*Turn on the FM switch\*/  
:FM:STAT? /\*The query returns 1\*/

**[[:SOURce]:FM:WAVEform**

**Syntax** [:SOURce]:FM:WAVEform SINE|SQUA  
[:SOURce]:FM:WAVEform?

**Description** Set the FM modulation waveform.

Query the FM modulation waveform.

**Parameter**

Name	Type	Range	Default
SINE SQUA	Discrete	SINE SQUA	SINE

- Explanation**
- SINE: set the FM modulation waveform to "Sine".
  - SQUA: set the FM modulation waveform to "Square".
  - When the modulation source of FM is set to "Ext", this command is invalid.

**Return Format** The query returns SINE or SQUA.

**Example** :FM:WAVE SQUA  
:FM:WAVE?

**Related Command** [\[:SOURce\]:FM:SOURce](#)

**[[:SOURce]:FMPM:TYPE**

**Syntax** [[:SOURce]:FMPM:TYPE FM|PM

[[:SOURce]:FMPM:TYPE?

**Description** Set the current modulation type to FM or ØM.

Query the current modulation type.

**Parameter**

Name	Type	Range	Default
FM PM	Discrete	FM PM	PM

**Explanation**

- FM: set the current modulation type to "FM".
- PM: set the current modulation type to "ØM".

**Return Format** The query returns FM or PM.

**Example** :FMPM:TYPE FM

:FMPM:TYPE?

## [[:SOURce]:FREQuency Command Subsystem

### Command List:

- ◆ [\[:SOURce\]:FREQuency](#)
- ◆ [\[:SOURce\]:FREQuency:STEP](#)

### [[:SOURce]:FREQuency

**Syntax** [:SOURce]:FREQuency <value>

[:SOURce]:FREQuency?

**Description** Set the frequency of the RF signal.

Query the frequency of the RF signal.

#### Parameter

Name	Type	Range	Default
<value>	Real	9kHz to 3GHz	3GHz

- Explanation**
- When <value> is set in "Number" form, the default unit is Hz; for example, 4000000. In addition, <value> can also be set in "Number + Unit" form; for example, 4MHz.
  - After the RF frequency is set, you can rotate the knob to modify the frequency at the current step. At this point, you can set and query the current step using the [\[:SOURce\]:FREQuency:STEP](#) command.

**Return Format** The query returns the frequency of the RF signal. For example, 4.00000000MHz.

**Example** :FREQ 4MHz

:FREQ?

**Related Command** [\[:SOURce\]:FREQuency:STEP](#)

**[[:SOURce]:FREQuency:STEP**

**Syntax** [:SOURce]:FREQuency:STEP <value>

[:SOURce]:FREQuency:STEP?

**Description** Set the RF frequency step.

Query the RF frequency step.

**Parameter**

Name	Type	Range	Default
<value>	Real	10mHz to 1GHz	100MHz

- Explanation**
- When <value> is set in "Number" form, the default unit is Hz; for example, 3000. In addition, <value> can also be set in "Number + Unit" form; for example, 3kHz.
  - After the RF frequency step is set, you can rotate the knob to modify the frequency at the current step. At this point, you can query or set the frequency using the [\[:SOURce\]:FREQuency](#) command.

**Return Format** The query returns the RF frequency step. For example, 3.00000kHz.

**Example** :FREQ:STEP 3kHz

:FREQ:STEP?

**Related Command** [\[:SOURce\]:FREQuency](#)

**[[:SOURce]:INPut:TRIGger:SLOPe**

**Syntax** [:SOURce]:INPut:TRIGger:SLOPe POSitive|NEGative

[:SOURce]:INPut:TRIGger:SLOPe?

**Description** Set the polarity of the external trigger input signal.

Query the polarity of the external trigger input signal.

**Parameter**

Name	Type	Range	Default
POSitive NEGative	Discrete	POSitive NEGative	POSitive

- Explanation**
- This command is valid only when the trigger mode of **SWEEP** is set to "Ext".
  - The external trigger signal is input from the **[TRIGGER IN]** connector at the rear panel.

**Return Format** The query returns POS or NEG.

**Example** :INP:TRIG:SLOP POS

:INP:TRIG:SLOP?

## [:SOURce]:LEVel Command Subsystem

### Command List:

- ◆ [\[:SOURce\]:LEVel](#)
- ◆ [\[:SOURce\]:LEVel:STEP](#)

### [:SOURce]:LEVel

**Syntax** [:SOURce]:LEVel <value>

[:SOURce]:LEVel?

**Description** Set the RF output amplitude.

Query the RF output amplitude.

#### Parameter

Name	Type	Range	Default
<value>	Real	-110dBm to 20dBm	-110dBm

- Explanation**
- When <value> is set in "Number" form (for example, 2), the default unit is dBm. In addition, <value> can also be set in "Number + Unit" form (for example, 2dBm); at this point, the amplitude displayed in the RF signal generator interface is related to the setting of **Level Unit**.
    - When the level unit is "dBm", 2.00dBm is displayed;
    - When the level unit is "dBmV", 48.99dBmV is displayed;
    - When the level unit is "dBuV", 108.99dBuV is displayed;
    - When the level unit is "Volts", 281.50mV is displayed;
    - When the level unit is "Watts", 1.58mW is displayed.
  - The default unit of the return value is dBm.
  - After the RF output amplitude is set, you can rotate the knob to modify the amplitude at the current step. At this point, you can set and query the current step using the [\[:SOURce\]:LEVel:STEP](#) command.

**Return Format** The query returns the RF output amplitude. For example, 2.00.

**Example** :LEV 2dBm /\*Set the amplitude of the RF signal to 2dBm\*/

:LEV? /\*Query the amplitude of the RF signal and the query returns 2.00\*/

**Related Command** [\[:SOURce\]:LEVel:STEP](#)

**[[:SOURce]:LEVel:STEP**

**Syntax** [:SOURce]:LEVel:STEP <value>

[:SOURce]:LEVel:STEP?

**Description** Set the RF output amplitude step.

Query the RF output amplitude step.

**Parameter**

Name	Type	Range	Default
<value>	Real	0.01dB to 100dB	10dB

- Explanation**
- When <value> is set in "Number" form, the default unit is dB. Besides, <value> can also be set in "Number + Unit" form; for example, 20dB.
  - The default unit of the return value is dB.
  - After the output amplitude step is set, you can rotate the knob to modify the output amplitude at the current step. At this point, you can query or set the output amplitude using the [\[:SOURce\]:LEVel](#) command.

**Return Format** The query returns the RF output amplitude step. For example, 20.00.

**Example** :LEV:STEP 20

:LEV:STEP?

**Related Command** [\[:SOURce\]:LEVel](#)

## [:SOURce]:LFOOutput Command Subsystem

### Command List:

- ◆ [\[:SOURce\]:LFOOutput:FREQuency](#)
- ◆ [\[:SOURce\]:LFOOutput:LEVel](#)
- ◆ [\[:SOURce\]:LFOOutput:SHAPE](#)
- ◆ [\[:SOURce\]:LFOOutput\[:STATe\]](#)

### [:SOURce]:LFOOutput:FREQuency

**Syntax** [:SOURce]:LFOOutput:FREQuency <value>

[:SOURce]:LFOOutput:FREQuency?

**Description** Set the frequency of the LF output signal.

Query the frequency of the LF output signal.

#### Parameter

Name	Type	Range	Default
<value>	Real	0Hz to 200kHz (Sine)/0Hz to 20kHz (Square)	1kHz

**Explanation** When <value> is set in "Number" form, the default unit is Hz. Besides, <value> can also be set in "Number + Unit" form; for example, 2kHz.

**Return Format** The query returns the frequency of the LF output signal. For example, 2.00000kHz.

**Example** :LFO:FREQ 2kHz

:LFO:FREQ?

### [:SOURce]:LFOOutput:LEVel

**Syntax** [:SOURce]:LFOOutput:LEVel <value>

[:SOURce]:LFOOutput:LEVel?

**Description** Set the amplitude of the LF output signal.

Query the amplitude of the LF output signal.

#### Parameter

Name	Type	Range	Default
<value>	Real	0V to 3V	500mV

**Explanation** ➤ When <value> is set in "Number" form, the default unit is V. Besides, <value> can also be set in "Number + Unit" form; for example, 2V.

➤ The default unit of the return value is V.

**Return Format** The query returns the amplitude of the LF output signal. For example, 2.00.

**Example** :LFO:LEV 2

:LFO:LEV?



**[[:SOURce]:LFOutput:SHAPE]**

**Syntax** [:SOURce]:LFOutput:SHAPE SINE|SQUare  
[:SOURce]:LFOutput:SHAPE?

**Description** Set the waveform of the LF output signal.  
Query the waveform of the LF output signal.

Parameter	Name	Type	Range	Default
	SINE SQUare	Discrete	SINE SQUare	SINE

**Explanation**

- SINE: set the waveform of the LF output signal to "Sine".
- SQUare: set the waveform of the LF output signal to "Square".

**Return Format** The query returns SINE|SQU.

**Example** :LFO:SHAP SINE  
:LFO:SHAP?

**[[:SOURce]:LFOutput[:STATE]]**

**Syntax** [:SOURce]:LFOutput[:STATE] ON|OFF|1|0  
[:SOURce]:LFOutput[:STATE]?

**Description** Turn on or off the LF output switch.  
Query the state of the LF output switch.

Parameter	Name	Type	Range	Default
	ON OFF 1 0	Bool	ON OFF 1 0	OFF 0

**Explanation**

- ON|1: turn on the LF output switch.
- OFF|0: turn off the LF output switch.

**Return Format** The query returns 1 or 0.

**Example** :LFO:STAT ON /\*Turn on the LF output switch\*/  
:LFO:STAT? /\*The query returns 1\*/

## [[:SOURce]:MODulation:STATe

**Syntax** [[:SOURce]:MODulation:STATe ON|OFF|1|0

[[:SOURce]:MODulation:STATe?

**Description** Turn on or off the switch of all the modulation outputs.

Query the on/off state of the switch of all the modulation outputs.

Parameter	Name	Type	Range	Default
	ON OFF 1 0	Bool	ON OFF 1 0	OFF 0

- Explanation**
- ON|1: turn on all the modulation outputs. The backlight of **Mod/on** goes on.
  - OFF|0: turn off all the modulation outputs. The backlight of **Mod/on** goes off.

**Return Format** The query returns 1 or 0.

**Example** :MOD:STAT ON /\*Turn on the switch of all the modulation outputs\*/

:MOD:STAT? /\*The query returns 1\*/

## [[:SOURce]:PM Command Subsystem

### Command List:

- ◆ [\[:SOURce\]:PM\[:DEVIation\]](#)
- ◆ [\[:SOURce\]:PM\[:DEVIation\]:STEP\[:INCRement\]](#)
- ◆ [\[:SOURce\]:PM:EXT:COUP](#)
- ◆ [\[:SOURce\]:PM:EXT:IMP](#)
- ◆ [\[:SOURce\]:PM:FREQuency](#)
- ◆ [\[:SOURce\]:PM:FREQuency:STEP\[:INCRement\]](#)
- ◆ [\[:SOURce\]:PM:SOURce](#)
- ◆ [\[:SOURce\]:PM:STATe](#)
- ◆ [\[:SOURce\]:PM:WAVEform](#)

### [[:SOURce]:PM[:DEVIation]

**Syntax** [:SOURce]:PM[:DEVIation] <value>  
[:SOURce]:PM[:DEVIation]?

**Description** Set the phase deviation of ØM.  
Query the phase deviation of ØM.

Parameter	Name	Type	Range	Default
	<value>	Real	0rad to 5rad	5rad

- Explanation**
- When <value> is set in "Number" form, the default unit is rad. Besides, <value> can also be set in "Number + Unit" form; for example, 2rad.
  - The default unit of the return value is rad.
  - After the phase deviation is set, you can rotate the knob to modify the phase deviation at the current step. At this point, you can query and set the current step using the [\[:SOURce\]:PM\[:DEVIation\]:STEP\[:INCRement\]](#) command.

**Return Format** The query returns the phase deviation of ØM. For example, 2.000000.

**Example** :PM:DEV 2  
:PM:DEV?

**Related Command** [\[:SOURce\]:PM\[:DEVIation\]:STEP\[:INCRement\]](#)

**[[:SOURce]:PM[:DEVIation]:STEP[:INCRement]]**

**Syntax** [:SOURce]:PM[:DEVIation]:STEP[:INCRement] <value>  
[:SOURce]:PM[:DEVIation]:STEP[:INCRement]?

**Description** Set the phase deviation step of ØM.

Query the phase deviation step of ØM.

**Parameter**

Name	Type	Range	Default
<value>	Real	0.01rad to 2.5rad	1rad

- Explanation**
- When <value> is set in "Number" form, the default unit is rad. Besides, <value> can also be set in "Number + Unit" form; for example, 1rad.
  - The default unit of the return value is rad.
  - After the phase deviation step is set, you can rotate the knob to modify the phase deviation at the current step. At this point, you can query or set the phase deviation using the [\[:SOURce\]:PM\[:DEVIation\]](#) command.

**Return Format** The query returns the phase deviation step. For example, 1.000000.

**Example** :PM:DEV:STEP 1  
:PM:DEV:STEP?

**Related Command** [\[:SOURce\]:PM\[:DEVIation\]](#)

**[[:SOURce]:PM:EXT:COUP]**

**Syntax** [:SOURce]:PM:EXT:COUP AC|DC  
[:SOURce]:PM:EXT:COUP?

**Description** Set the coupling mode of ØM external modulation.

Query the coupling mode of ØM external modulation.

**Parameter**

Name	Type	Range	Default
AC DC	Discrete	AC DC	AC

- Explanation**
- AC: set the coupling mode of ØM external modulation to "AC".
  - DC: set the coupling mode of ØM external modulation to "DC".
  - When the modulation source of ØM is set to "Int", this command is invalid.

**Return Format** The query returns AC or DC.

**Example** :PM:EXT:COUP AC  
:PM:EXT:COUP?

**Related Command** [\[:SOURce\]:PM:SOURce](#)

**[[:SOURce]:PM:EXT:IMP**

**Syntax** [:SOURce]:PM:EXT:IMP 50|600|100k

[:SOURce]:PM:EXT:IMP?

**Description** Set the impedance of ØM external modulation.

Query the impedance of ØM external modulation.

**Parameter**

Name	Type	Range	Default
50 600 100k	Discrete	50 600 100k	100k

**Explanation**

- 50: set the impedance of ØM external modulation to "50ohm".
- 600: set the impedance of ØM external modulation to "600ohm".
- 100k: set the impedance of ØM external modulation to "100kohm".
- When the modulation source of ØM is set to "Int", this command is invalid.

**Return Format** The query returns 50, 600 or 100k.

**Example** :PM:EXT:IMP 600

:PM:EXT:IMP?

**Related Command** [\[:SOURce\]:PM:SOURce](#)

**[[:SOURce]:PM:FREQuency**

**Syntax** [:SOURce]:PM:FREQuency <value>

[:SOURce]:PM:FREQuency?

**Description** Set the modulation frequency of ØM.

Query the modulation frequency of ØM.

**Parameter**

Name	Type	Range	Default
<value>	Real	10Hz to 100kHz (Sine)/10Hz to 20kHz (Square)	10kHz

**Explanation**

- When <value> is set in "Number" form, the default unit is Hz. Besides, <value> can also be set in "Number + Unit" form; for example, 20kHz.
- After the modulation frequency is set, you can rotate the knob to modify the modulation frequency at the current step. At this point, you can query or set the current step using the [\[:SOURce\]:PM:FREQuency:STEP\[:INCRement\]](#) command.
- This command is invalid when the ØM modulation source is set to "Ext".

**Return Format** The query returns the ØM modulation frequency. For example, 20.00000kHz.

**Example** :PM:FREQ 20kHz

:PM:FREQ?

**Related Commands** [\[:SOURce\]:PM:FREQuency:STEP\[:INCRement\]](#)  
[\[:SOURce\]:PM:SOURce](#)

**[[:SOURce]:PM:FREQuency:STEP[:INCRement]]**

**Syntax** [[:SOURce]:PM:FREQuency:STEP[:INCRement] <value>

[[:SOURce]:PM:FREQuency:STEP[:INCRement]]?

**Description** Set the modulation frequency step of  $\emptyset$ M.

Query the modulation frequency step of  $\emptyset$ M.

**Parameter**

Name	Type	Range	Default
<value>	Real	1Hz to 50kHz	1kHz

- Explanation**
- When <value> is set in "Number" form, the default unit is Hz. Besides, <value> can also be set in "Number + Unit" form; for example, 5kHz.
  - After the modulation frequency step is set, you can rotate the knob to modify the modulation frequency at the current step. At this point, you can query or set the modulation frequency using the [\[:SOURce\]:PM:FREQuency](#) command.

**Return Format** The query returns the modulation frequency step of  $\emptyset$ M. For example, 5.00000kHz.

**Example** :PM:FREQ:STEP 5kHz

:PM:FREQ:STEP?

**Related Command** [\[:SOURce\]:PM:FREQuency](#)

**[[:SOURce]:PM:SOURce]**

**Syntax** [[:SOURce]:PM:SOURce EXTernal|INTernal

[[:SOURce]:PM:SOURce?

**Description** Set the  $\emptyset$ M modulation source.

Query the  $\emptyset$ M modulation source.

**Parameter**

Name	Type	Range	Default
EXTernal INTernal	Discrete	EXTernal INTernal	INTernal

- Explanation**
- EXTernal: select "Ext" modulation source. At this point, the external modulating signal is input from the **[EXT MOD IN]** connector.
  - INTernal: select "Int" modulation source. At this point, the instrument provides the modulating signal and you can set the modulation frequency and modulation waveform of the modulating signal.

**Return Format** The query returns the  $\emptyset$ M modulation source. For example, INT.

**Example** :PM:SOUR INT

:PM:SOUR?

**Related Commands** [\[:SOURce\]:PM:FREQuency](#)  
[\[:SOURce\]:PM:WAVEform](#)

**[[:SOURce]:PM:STATe**

**Syntax** [:SOURce]:PM:STATe ON|OFF|1|0  
[:SOURce]:PM:STATe?

**Description** Turn on or off the ØM switch.

Query the state of the ØM switch.

**Parameter**

Name	Type	Range	Default
ON OFF 1 0	Bool	ON OFF 1 0	OFF 0

**Explanation**

- ON|1: turn on the ØM switch and enable the ØM function.
- OFF|0: turn off the ØM switch and disable the ØM function.

**Return Format** The query returns 1 or 0.

**Example** :PM:STAT ON /\*Turn on the ØM switch\*/  
:PM:STAT? /\*The query returns 1\*/

**[[:SOURce]:PM:WAVEform**

**Syntax** [:SOURce]:PM:WAVEform SINE|SQUA  
[:SOURce]:PM:WAVEform?

**Description** Set the modulation waveform of ØM.

Query the modulation waveform of ØM.

**Parameter**

Name	Type	Range	Default
SINE SQUA	Discrete	SINE SQUA	SINE

**Explanation**

- SINE: set the modulation waveform of ØM to "Sine".
- SQUA: set the modulation waveform of ØM to "Square".
- This command is invalid when the ØM modulation source is set to "Ext".

**Return Format** The query returns SINE or SQUA.

**Example** :PM:WAVE SQUA  
:PM:WAVE?

**Related Command** [\[:SOURce\]:PM:SOURce](#)

## [:SOURce]:PULM Command Subsystem

### Command List<sup>[3]</sup>:

- ◆ [\[:SOURce\]:PULM:MODE](#)
- ◆ [\[:SOURce\]:PULM:OUT:STATE](#)
- ◆ [\[:SOURce\]:PULM:PERiod](#)
- ◆ [\[:SOURce\]:PULM:PERiod:STEP](#)
- ◆ [\[:SOURce\]:PULM:POLarity](#)
- ◆ [\[:SOURce\]:PULM:SOURce](#)
- ◆ [\[:SOURce\]:PULM:STATe](#)
- ◆ [\[:SOURce\]:PULM:TRAIIn:LIST:COUNT](#)
- ◆ [\[:SOURce\]:PULM:TRAIIn:LIST:GET](#)
- ◆ [\[:SOURce\]:PULM:TRIGger:DELay](#)
- ◆ [\[:SOURce\]:PULM:TRIGger:DELay:STEP](#)
- ◆ [\[:SOURce\]:PULM:TRIGger:EXTernal:GATE:POLarity](#)
- ◆ [\[:SOURce\]:PULM:TRIGger:EXTernal:SLOPe](#)
- ◆ [\[:SOURce\]:PULM:TRIGger:MODE](#)
- ◆ [\[:SOURce\]:PULM:WIDTh](#)
- ◆ [\[:SOURce\]:PULM:WIDTh:STEP](#)

### [:SOURce]:PULM:MODE

**Syntax** [:SOURce]:PULM:MODE SINGLE|TRAIN

[:SOURce]:PULM:MODE?

**Description** Set the pulse modulation mode.

Query the pulse modulation mode.

**Parameter**

Name	Type	Range	Default
SINGLE TRAIN	Discrete	SINGLE TRAIN	SINGLE

- Explanation**
- SINGLE: set the pulse type to "single" and enable the single pulse modulation mode.
  - TRAIN: set the pulse type to "Train" and enable the train pulse modulation mode.
  - When "Ext" modulation source is selected, this command is invalid.

**Return Format** The query returns SINGLE or TRAIN.

**Example** :PULM:MODE SING

:PULM:MODE?

**Related Command** [\[:SOURce\]:PULM:SOURce](#)

**Note**<sup>[3]</sup>: To use the commands related to "Pulse Modulation" and "Pulse Generator", you need to install the DSG800-PUM option; to use the related commands of "Train", you need to install the DSG800-PUG option; otherwise, the command settings are invalid. For the installation methods of the option, refer to *DSG800 User's Guide*.



**[[:SOURce]:PULM:OUT:STATe**

**Syntax** [:SOURce]:PULM:OUT:STATe ON|OFF|0|1  
[:SOURce]:PULM:OUT:STATe?

**Description** Turn on or off the pulse output switch.

Query the state of the pulse output switch.

**Parameter**

Name	Type	Range	Default
ON OFF 0 1	Bool	ON OFF 0 1	OFF 0

- Explanation**
- ON|1: turn on the pulse output switch. At this point, the RF signal generator can output the pulse signal generated by the internal pulse generator from the **[PULSE IN/OUT]** connector at the rear panel. Note that this output signal is related to the pulse "Mode" setting.
  - OFF|0: turn off the pulse output switch.
  - When "Ext" modulation source is selected, this command is invalid.

**Return Format** The query returns 1 or 0.

**Example** :PULM:OUT:STAT ON /\*Turn on the pulse output switch\*/  
:PULM:OUT:STAT? /\*The query returns 1\*/

**Related Commands** [\[:SOURce\]:PULM:MODE](#)  
[\[:SOURce\]:PULM:SOURce](#)

**[[:SOURce]:PULM:PERiod**

**Syntax** [:SOURce]:PULM:PERiod <value>  
[:SOURce]:PULM:PERiod?

**Description** Set the period of pulse modulation.

Query the period of pulse modulation.

**Parameter**

Name	Type	Range	Default
<value>	Real	40ns to 170s	1ms

- Explanation**
- When <value> is set in "Number" form, the default unit is s. Besides, <value> can also be set in "Number + Unit" form; for example, 1000ms.
  - After the pulse period is set, you can rotate the knob to modify the period at the current step. At this point, you can query and set the current step using the [\[:SOURce\]:PULM:PERiod:STEP](#) command.
  - When the modulation source is set to "Ext" or the pulse mode is set to "Train", this command is invalid.

**Return Format** The query returns the period of pulse modulation. For example, 1.000000000s.

**Example** :PULM:PER 1000ms  
:PULM:PER?

**Related Commands** [\[:SOURce\]:PULM:PERiod:STEP](#)  
[\[:SOURce\]:PULM:SOURce](#)  
[\[:SOURce\]:PULM:MODE](#)

**[[:SOURce]:PULM:PERiod:STEP**

**Syntax** [[:SOURce]:PULM:PERiod:STEP <value>

[[:SOURce]:PULM:PERiod:STEP?

**Description** Set the step of the pulse modulation period.

Query the step of the pulse modulation period.

**Parameter**

Name	Type	Range	Default
<value>	Real	10ns to 10s	100us

- Explanation**
- When <value> is set in "Number" form, the default unit is s. Besides, <value> can also be set in "Number + Unit" form; for example, 5000ms.
  - After the pulse period step is set, you can rotate the knob to modify the period at the current step. At this point, you can query and set the pulse period using the [\[\[:SOURce\]:PULM:PERiod](#) command.

**Return Format** The query returns the step of the pulse modulation period. For example, 5.000000000s.

**Example** :PULM:PER:STEP 5000ms

:PULM:PER:STEP?

**Related Command** [\[\[:SOURce\]:PULM:PERiod](#)

**[[:SOURce]:PULM:POLarity**

**Syntax** [[:SOURce]:PULM:POLarity NORMal|INVerse

[[:SOURce]:PULM:POLarity?

**Description** Set the polarity of pulse modulation.

Query the polarity of pulse modulation.

**Parameter**

Name	Type	Range	Default
NORMal INVerse	Discrete	NORMal INVerse	NORMal

- Explanation**
- NORMal: set the polarity of the current pulse modulating signal to "Normal".
  - INVerse: set the polarity of the current pulse modulating signal to "Inverse".

**Return Format** The query returns NORMAL or INVERSE.

**Example** :PULM:POL INV

:PULM:POL?

**[[:SOURce]:PULM:SOURce**

**Syntax** [:SOURce]:PULM:SOURce INTernal|EXTernal  
[:SOURce]:PULM:SOURce?

**Description** Set the pulse modulation source.  
Query the pulse modulation source.

**Parameter**

Name	Type	Range	Default
INTernal EXTernal	Discrete	INTernal EXTernal	INTernal

**Explanation**

- INTernal: select "Int" modulation source. At this point, the internal pulse generator of the instrument provides the modulating signal. When the "Pulse Out" is turned on, the RF signal generator can output the pulse signal generated by the internal pulse generator from the **[PULSE IN/OUT]** connector at the rear panel.
- EXTernal: select "Ext" modulation source. At this point, the RF signal generator receives the external pulse modulating signal input from the **[PULSE IN/OUT]** connector at the rear panel.

**Return Format** The query returns the pulse modulation source (INT or EXT).

**Example** :PULM:SOUR EXT  
:PULM:SOUR?

**Related Command** [\[:SOURce\]:PULM:OUT:STATe](#)

**[[:SOURce]:PULM:STATe**

**Syntax** [:SOURce]:PULM:STATe ON|OFF|1|0  
[:SOURce]:PULM:STATe?

**Description** Set the state of pulse modulation.  
Query the state of pulse modulation.

**Parameter**

Name	Type	Range	Default
ON OFF 1 0	Bool	ON OFF 1 0	OFF 0

**Explanation**

- ON|1: turn on the pulse modulation switch to enable the pulse modulation function.
- OFF|0: turn off the pulse modulation switch to disable the pulse modulation function.

**Return Format** The query returns 1 or 0.

**Example** :PULM:STAT ON /\*Turn on the pulse modulation switch\*/  
:PULM:STAT? /\*Query the state of pulse modulation and the query returns 1\*/

**[[:SOURce]:PULM:TRAI:n:LIST:COUNT**

**Syntax** [:SOURce]:PULM:TRAI:n:LIST:COUNT?

**Description** Acquire the total number of rows in the current train list.

**Return Format** The query returns the total number of rows in the current train list in integer. For example, 2.

**[[:SOURce]:PULM:TRAI:n:LIST:GET**

**Syntax** [[:SOURce]:PULM:TRAI:n:LIST:GET? <Start>,<Count>

**Description** Acquire the train list data within the specified range.

Parameter	Name	Type	Range	Default
	<Start>	Integer	1 to the total number of rows in the current train list	--
	<Count>	Integer	1 to the total number of rows in the current train list	--

- Explanation**
- <Start>: the number of the start row of the train list data to be acquired.
  - <Count>: the total number of rows of the train list data to be acquired.

**Return Format** The query returns the train list data newly acquired. For example,

SN.2:2.00 ms , 4.00 ms, 2, 12.00 ms

SN.3:15.55 ms , 100.50 us, 2, 31.30 ms

**Example** :PULM:TRA:LIST:GET? 2,2 /\*Acquire 2 rows of train data starting from the second row of the train list\*/

**Related Command** [\[:SOURce\]:PULM:TRAI:n:LIST:COUNT](#)

**[[:SOURce]:PULM:TRIGger:DELAy**

**Syntax** [[:SOURce]:PULM:TRIGger:DELAy <value>

[[:SOURce]:PULM:TRIGger:DELAy?

**Description** Set the pulse trigger delay.

Query the pulse trigger delay.

Parameter	Name	Type	Range	Default
	<value>	Real	10ns to 170s	100us

- Explanation**
- When the modulation source is set to "Int" and the trigger mode is set to "Ext", you can use this command to set the delay from when the pulse modulating signal receives the external trigger signal to the start of the #1 pulse of the pulse modulating signal.
  - When <value> is set in "Number" form, the default unit is s. Besides, <value> can also be set in "Number + Unit" form; for example, 30ns.
  - After the trigger delay is set, you can rotate the knob to modify the trigger delay at the current step. At this point, you can query and set the current step using the [\[:SOURce\]:PULM:TRIGger:DELAy:STEP](#) command.

**Return Format** The query returns the trigger delay. For example, 3.000000000s.

**Example** :PULM:TRIG:DEL 3 /\*Set the trigger delay to 3s\*/  
:PULM:TRIG:DEL?

**Related Commands** [\[:SOURce\]:PULM:SOURce](#)  
[\[:SOURce\]:PULM:TRIGger:DELAy:STEP](#)  
[\[:SOURce\]:PULM:TRIGger:MODE](#)

**[[:SOURce]:PULM:TRIGger:DELay:STEP**

**Syntax** [:SOURce]:PULM:TRIGger:DELay:STEP <value>

[:SOURce]:PULM:TRIGger:DELay:STEP?

**Description** Set the step of pulse trigger delay.

Query the step of pulse trigger delay.

**Parameter**

Name	Type	Range	Default
<value>	Real	10ns to 170s	100us

**Explanation**

- When <value> is set in "Number" form, the default unit is s. Besides, <value> can also be set in "Number + Unit" form; for example, 50ms.
- After the trigger delay step is set, you can rotate the knob to modify the trigger delay at the current step. At this point, you can query and set the trigger delay using the [\[:SOURce\]:PULM:TRIGger:DELay](#) command.

**Return Format** The query returns the trigger delay step. For example, 5.000000000s.

**Example** :PULM:TRIG:DEL:STEP 5 /\*Set the trigger delay step to 5s\*/

:PULM:TRIG:DEL:STEP?

**Related Command** [\[:SOURce\]:PULM:TRIGger:DELay](#)

**[[:SOURce]:PULM:TRIGger:EXTernal:GATE:POLarity**

**Syntax** [:SOURce]:PULM:TRIGger:EXTernal:GATE:POLarity NORMal|INVerse

[:SOURce]:PULM:TRIGger:EXTernal:GATE:POLarity?

**Description** Set the polarity of the external gated signal.

Query the polarity of the external gated signal.

**Parameter**

Name	Type	Range	Default
NORMal INVerse	Discrete	NORMal INVerse	NORMal

**Explanation**

- When the trigger mode of pulse modulation is set to "Ext Gate", the RF signal generator receives the external gated signal input from the **[TRIGGER IN]** connector at the rear panel. At this point, you can set the polarity of the external gated signal using this command.
- NORMal: set the polarity of the external gated signal to "Normal".
- INVerse: set the polarity of the external gated signal to "Inverse".
- When the modulation source is set to "Ext", this command is invalid.

**Return Format** The query returns NORMAL or INVERSE.

**Example** :PULM:TRIG:EXT:GATE:POL INV

:PULM:TRIG:EXT:GATE:POL?

**Related Commands** [\[:SOURce\]:PULM:TRIGger:MODE](#)  
[\[:SOURce\]:PULM:SOURce](#)

**[[:SOURce]:PULM:TRIGger:EXTernal:SLOPe**

**Syntax** [:SOURce]:PULM:TRIGger:EXTernal:SLOPe POSitive|NEGative  
[:SOURce]:PULM:TRIGger:EXTernal:SLOPe?

**Description** Set the polarity of the effective edge of the external trigger pulse.  
Query the polarity of the effective edge of the external trigger pulse.

**Parameter**

Name	Type	Range	Default
POSitive NEGative	Discrete	POSitive NEGative	POSitive

- Explanation**
- When the trigger mode of pulse modulation is set to "Ext Trig", the RF signal generator receives the external trigger signal input from the **[TRIGGER IN]** connector at the rear panel. At this point, you can use this command to set the trigger edge of the external trigger signal.
  - POSitive: set the polarity of the effective edge of the external trigger pulse to "Pos".
  - NEGative: set the polarity of the effective edge of the external trigger pulse to "Neg".
  - When the modulation source is set to "Ext", this command is invalid.

**Return Format** The query returns POSITIVE or NEGATIVE.

**Example** :PULM:TRIG:EXT:SLOP NEG  
:PULM:TRIG:EXT:SLOP?

**Related Commands** [\[:SOURce\]:PULM:TRIGger:MODE](#)  
[\[:SOURce\]:PULM:SOURce](#)

**[[:SOURce]:PULM:TRIGger:MODE**

**Syntax** [:SOURce]:PULM:TRIGger:MODE AUTO|EXTernal|EGATe|KEY|BUS  
[:SOURce]:PULM:TRIGger:MODE?

**Description** Set the trigger mode of pulse modulation.

Query the trigger mode of pulse modulation.

**Parameter**

Name	Type	Range	Default
AUTO EXTernal EGATe  KEY BUS	Discrete	AUTO EXTernal EGATe  KEY BUS	AUTO

- Explanation**
- AUTO: select "Auto" trigger mode. At this point, the RF signal generator meets the trigger condition at any time and will start the pulse modulation once the pulse modulation function is turned on.
  - EXTernal: select "Ext" trigger mode. At this point, the RF signal generator receives the external trigger signal input from the **[TRIGGER IN]** connector at the rear panel. The instrument starts a pulse modulation each time a TTL pulse with the specified polarity is received. To specify the polarity of the TTL pulse, use the [\[:SOURce\]:PULM:TRIGger:EXTernal:SLOPe](#) command to select "Pos" or "Neg".
  - EGATe: select "Ext Gate" trigger mode. At this point, the RF signal generator receives the external gated signal input from the **[TRIGGER IN]** connector at the rear panel. The instrument starts a pulse modulation within the valid level range each time a gated signal with the specified polarity is received. To specify the polarity of the external gated signal, use the [\[:SOURce\]:PULM:TRIGger:EXTernal:GATE:POLarity](#) command to select "Normal" or "Inverse".
  - KEY: select "Key" trigger mode. At this point, the instrument starts a pulse modulation each time **Key Trig** is pressed.
  - BUS: select "Bus" trigger mode. At this point, the instrument starts a pulse modulation each time the [\\*TRG](#) or [:TRIGger:PULSe\[:IMMEDIATE\]](#) command is sent.
  - When the modulation source is set to "Ext", this command is invalid.

**Return Format** The query returns the trigger mode of pulse modulation. For example, EGAT.

**Example** :PULM:TRIG:MODE EGAT  
:PULM:TRIG:MODE?

**Related Commands**

[\[:SOURce\]:PULM:TRIGger:EXTernal:GATE:POLarity](#)  
[\[:SOURce\]:PULM:TRIGger:EXTernal:SLOPe](#)  
[\[:SOURce\]:PULM:SOURce](#)  
[\\*TRG](#)  
[:TRIGger:PULSe\[:IMMEDIATE\]](#)

**[[:SOURce]:PULM:WIDTH**

**Syntax** [:SOURce]:PULM:WIDTH <value>

[:SOURce]:PULM:WIDTH?

**Description** Set the width of the pulse modulating signal.

Query the width of the pulse modulating signal.

**Parameter**

Name	Type	Range	Default
<value>	Real	10ns to 170s - 10ns	500us

- Explanation**
- When <value> is set in "Number" form, the default unit is s. Besides, <value> can also be set in "Number + Unit" form; for example, 2000ms.
  - When the modulation source is set to "Int" and the pulse mode is set to "Single", you can use this command to set the width of the single pulse; otherwise, this command is invalid.
  - After the pulse width is set, you can rotate the knob to modify the pulse width at the current step. At this point, you can query and set the current step using the [\[:SOURce\]:PULM:WIDTH:STEP](#) command.
  - The single pulse width is limited by the minimum pulse width and pulse period and they fulfill the following relations.  
Pulse Width ≥ Minimum Pulse Width  
Pulse Width ≤ Pulse Period - 10 ns

**Return Format** The query returns the width of the pulse modulating signal. For example, 2.000000000s.

**Example** :PULM:WIDT 2

:PULM:WIDT?

**Related** [\[:SOURce\]:PULM:MODE](#)

**Commands** [\[:SOURce\]:PULM:PERiod](#)

[\[:SOURce\]:PULM:SOURce](#)

[\[:SOURce\]:PULM:WIDTH:STEP](#)



**[[:SOURce]:PULM:WIDTH:STEP**

**Syntax** [:SOURce]:PULM:WIDTH:STEP <value>

[:SOURce]:PULM:WIDTH:STEP?

**Description** Set the step of the width of the pulse modulating signal.

Query the step of the width of the pulse modulating signal.

**Parameter**

Name	Type	Range	Default
<value>	Real	10ns to 10s	100us

- Explanation**
- When <value> is set in "Number" form, the default unit is s. Besides, <value> can also be set in "Number + Unit" form; for example, 3000ms.
  - After the pulse width step is set, you can rotate the knob to modify the pulse width at the current step. At this point, you can query or set the pulse width using the [\[:SOURce\]:PULM:WIDTH](#) command.

**Return Format** The query returns the step of the width of the pulse modulating signal. For example, 3.000000000s.

**Example** :PULM:WIDT:STEP 3

:PULM:WIDT:STEP?

**Related Command** [\[:SOURce\]:PULM:WIDTH](#)

## [[:SOURce]:SWEep Command Subsystem

### Command List:

- ◆ [\[:SOURce\]:SWEep:DIRection](#)
- ◆ [\[:SOURce\]:SWEep:EXECute](#)
- ◆ [\[:SOURce\]:SWEep:LIST:CPOint](#)
- ◆ [\[:SOURce\]:SWEep:LIST:INITialize:FSTep](#)
- ◆ [\[:SOURce\]:SWEep:LIST:INITialize:PRESet](#)
- ◆ [\[:SOURce\]:SWEep:LIST:LIST](#)
- ◆ [\[:SOURce\]:SWEep:MODE](#)
- ◆ [\[:SOURce\]:SWEep:POINT:TRIGger:TYPE](#)
- ◆ [\[:SOURce\]:SWEep:RESet\[:ALL\]](#)
- ◆ [\[:SOURce\]:SWEep:STATe](#)
- ◆ [\[:SOURce\]:SWEep:STEP:DWELI](#)
- ◆ [\[:SOURce\]:SWEep:STEP:DWELI:STEP](#)
- ◆ [\[:SOURce\]:SWEep:STEP:POINTs](#)
- ◆ [\[:SOURce\]:SWEep:STEP:POINTs:STEP](#)
- ◆ [\[:SOURce\]:SWEep:STEP:SHAPE](#)
- ◆ [\[:SOURce\]:SWEep:STEP:SPACing](#)
- ◆ [\[:SOURce\]:SWEep:STEP:START:FREQuency](#)
- ◆ [\[:SOURce\]:SWEep:STEP:START:FREQuency:STEP](#)
- ◆ [\[:SOURce\]:SWEep:STEP:START:LEVel](#)
- ◆ [\[:SOURce\]:SWEep:STEP:START:LEVel:STEP](#)
- ◆ [\[:SOURce\]:SWEep:STEP:STOP:FREQuency](#)
- ◆ [\[:SOURce\]:SWEep:STEP:STOP:FREQuency:STEP](#)
- ◆ [\[:SOURce\]:SWEep:STEP:STOP:LEVel](#)
- ◆ [\[:SOURce\]:SWEep:STEP:STOP:LEVel:STEP](#)
- ◆ [\[:SOURce\]:SWEep:SWEep:TRIGger:TYPE](#)
- ◆ [\[:SOURce\]:SWEep:TYPE](#)

**[[:SOURce]:SWEep:DIRection**

**Syntax** [:SOURce]:SWEep:DIRection FWD|REV  
[:SOURce]:SWEep:DIRection?

**Description** Set the sweep direction.

Query the sweep direction.

**Parameter**

Name	Type	Range	Default
FWD REV	Discrete	FWD REV	FWD

**Explanation**

- FWD: select "Fwd" sweep direction. At this point, the RF signal generator sweeps from the start frequency or start level to the stop frequency or stop level.
- REV: select "Down" sweep direction. At this point, the RF signal generator sweeps from the stop frequency or stop level to the start frequency or stop level.

**Return Format** The query returns FWD or REV.

**Example** :SWE:DIR FWD /\*Set the sweep direction to "Fwd"\*/  
:SWE:DIR? /\*The query returns FWD\*/

**[[:SOURce]:SWEep:EXECute**

**Syntax** [:SOURce]:SWEep:EXECute

**Description** Execute a sweep.

**Explanation**

- If the current sweep mode is "Cont", sending this command will change the sweep mode to "Single". The instrument starts a sweep if the trigger condition is currently met.
- If the current sweep mode is "Single", the instrument starts a sweep if the trigger condition is met after sending this command.

**Related Command** [\[:SOURce\]:SWEep:MODE](#)

**[[:SOURce]:SWEep:LIST:CPOint**

**Syntax** [:SOURce]:SWEep:LIST:CPOint?

**Description** Query the total number of points in the current sweep list.

**Return Format** The query returns the total number of sweep points in the sweep list. For example, 5.

**[[:SOURce]:SWEep:LIST:INITialize:FSTep**

**Syntax** [[:SOURce]:SWEep:LIST:INITialize:FSTep

**Description** Recalculate the data points set in the current step sweep to generate a new sweep list.

- Explanation**
- In the new sweep list, "SN" depends on the "Points" of step sweep.
  - "Freq" depends on the "Start Freq" and "Stop Freq" of step sweep.
  - "Level" depends on the "start Lev" and "Stop Lev" of step sweep.
  - "Time" depends on the "Dwell Time" of step sweep.

**Related Commands**

[\[\[:SOURce\]:SWEep:STEP:DWELl](#)

[\[\[:SOURce\]:SWEep:STEP:POINts](#)

[\[\[:SOURce\]:SWEep:STEP:STARt:FREQuency](#)

[\[\[:SOURce\]:SWEep:STEP:STARt:LEVel](#)

[\[\[:SOURce\]:SWEep:STEP:STOP:FREQuency](#)

[\[\[:SOURce\]:SWEep:STEP:STOP:LEVel](#)

**[[:SOURce]:SWEep:LIST:INITialize:PRESet**

**Syntax** [[:SOURce]:SWEep:LIST:INITialize:PRESet

**Description** Reset the sweep list to the factory setting.

**Explanation** After resetting the sweep list to the default using this command, the sweep list only contains one frequency point (3GHz) and level point (-20dBm).

**[[:SOURce]:SWEep:LIST:LIST**

**Syntax** [[:SOURce]:SWEep:LIST:LIST? <Start>,<Count>

**Description** Acquire the sweep data within the specified range of the sweep list.

**Parameter**

Name	Type	Range	Default
<Start>	Integer	1 to the total number of rows in the current list	--
<Count>	Integer	1 to the total number of rows in the current list	--

- Explanation**
- <Start>: denote the number of the start row of the sweep data to be acquired.
  - <Count>: denote the total number of rows of the sweep data to be acquired.

**Return Format** The query returns the sweep data newly acquired. For example,

SN.2:2994152687 , -50.000000, 0.500000

SN.3:2888000000 , -60.849998, 0.500000

SN.4:2550000000 , -75.750000, 0.500000

**Example** :SWE:LIST:LIST? 2,3 /\*Acquire 3 rows of sweep data starting from the second row in the sweep list\*/

**[[:SOURce]:SWEep:MODE**

**Syntax** [:SOURce]:SWEep:MODE CONTInue|SINGle  
[:SOURce]:SWEep:MODE?

**Description** Set the sweep mode.

Query the sweep mode.

**Parameter**

Name	Type	Range	Default
CONTInue SINGle	Discrete	CONTInue SINGle	CONTInue

**Explanation**

- CONTInue: select "Cont" sweep mode. The instrument sweeps continuously according to the current setting when the trigger condition is met.
- SINGle: select "Single" sweep mode. The instrument performs a sweep according to the current setting and then stops when the trigger condition is met.

**Return Format** The query returns the sweep mode (CONT or SING).

**Example** :SWE:MODE CONT  
:SWE:MODE?

**[[:SOURce]:SWEep:POINt:TRIGger:TYPE**

**Syntax** [[:SOURce]:SWEep:POINt:TRIGger:TYPE AUTO|KEY|BUS|EXT

[[:SOURce]:SWEep:POINt:TRIGger:TYPE?

**Description** Set the point trigger mode of the sweep.

Query the point trigger mode of the sweep.

**Parameter**

Name	Type	Range	Default
AUTO KEY BUS EXT	Discrete	AUTO KEY BUS EXT	AUTO

- Explanation**
- AUTO: select "Auto" trigger mode. If the sweep mode is set to "Cont", the instrument will start sweeping each sweep point continuously within a sweep period once a sweep manner is selected. If the sweep mode is set to "Single", you need to send the [\[:SOURce\]:SWEep:EXECute](#) command to meet the single sweep condition; after that, the instrument starts to sweep and then stops after the sweep period expires.
  - KEY: select "Key" trigger mode. If the sweep mode is set to "Cont", the instrument starts to sweep a point each time **Key Trig** is pressed; if the sweep mode is set to "Single", you need to send the [\[:SOURce\]:SWEep:EXECute](#) command to meet the single sweep condition and after that, the instrument starts to sweep a point and then stops after the sweep period expires each time **Key Trig** is pressed.
  - BUS: select "Bus" trigger mode. If the sweep mode is set to "Cont", the instrument starts to sweep a point each time the [\\*TRG](#) or [:TRIGger\[:SWEep\]\[:IMMEDIATE\]](#) command is sent; if the sweep mode is set to "Single", you need to send the [\[:SOURce\]:SWEep:EXECute](#) command to meet the single sweep condition and after that, the instrument starts to sweep a point and then stops after the sweep period expires each time the [\\*TRG](#) or [:TRIGger\[:SWEep\]\[:IMMEDIATE\]](#) command is sent.
  - EXT: select "Ext" trigger mode. The RF signal generator receives the trigger signal input from the **[TRIGGER IN]** connector at the rear panel. If the sweep mode is set to "Cont", the instrument starts to sweep a point each time a TTL pulse signal with the specified polarity is received. If the sweep mode is set to "Single", you need to send the [\[:SOURce\]:SWEep:EXECute](#) command to meet the single sweep condition; after that, the instrument starts to sweep a point and then stops after the sweep period expires each time a TTL pulse signal with the specified polarity is received.
- Note:** The above descriptions are valid when the trigger mode of the corresponding sweep period is met.
- When executing the sweep operation, the priority of the required conditions is: single sweep → trigger mode → point trigger mode.

**Return Format** The query returns the point trigger mode. For example, AUTO.

**Example** :SWE:POIN:TRIG:TYPE AUTO

:SWE:POIN:TRIG:TYPE?

**Related Commands**

[\[:SOURce\]:SWEep:EXECute](#)

[\[:SOURce\]:SWEep:MODE](#)

[\[:SOURce\]:SWEep:SWEep:TRIGger:TYPE](#)

[\\*TRG](#)

[:TRIGger\[:SWEep\]\[:IMMEDIATE\]](#)

### [[:SOURce]:SWEep:RESet[:ALL]]

**Syntax** [:SOURce]:SWEep:RESet[:ALL]

**Description** Reset all the sweeps to the start point.

- Explanation**
- If the current sweep direction is "Fwd", the instrument will stop the current sweep and sweep from the start frequency or start level after sending this command.
  - If the current sweep direction is "Down", the instrument will stop the current sweep and sweep from the stop frequency or stop level after sending this command.

**Related Command** [\[:SOURce\]:SWEep:DIRection](#)

### [[:SOURce]:SWEep:STATe]

**Syntax** [:SOURce]:SWEep:STATe OFF|FREQuency|LEVel[,FREQuency]  
[:SOURce]:SWEep:STATe?

**Description** Set the sweep manner.

Query the sweep manner.

Parameter	Name	Type	Range	Default
	OFF FREQuency LEVel[,FREQuency]	Discrete	OFF FREQuency LEVel LEVel,FREQuency	OFF

- Explanation**
- OFF: turn off the sweep function.
  - FREQuency: enable the frequency sweep function.
  - LEVel: enable the level sweep function.
  - LEVel,FREQuency: enable the frequency and level sweep functions at the same time.

**Return Format** The query returns the sweep manner. For example, FREQ.

**Example** :SWE:STAT FREQ  
:SWE:STAT?

**[[:SOURce]:SWEep:STEP:DWELI**

**Syntax** [[:SOURce]:SWEep:STEP:DWELI <value>

[[:SOURce]:SWEep:STEP:DWELI?

**Description** Set the dwell time of step sweep.

Query the dwell time of step sweep.

Parameter	Name	Type	Range	Default
	<value>	Real	20ms to 100s	100ms

- Explanation**
- When <value> is set in "Number" form, the default unit is s. Besides, <value> can also be set in "Number + Unit" form; for example, 3000ms.
  - After the dwell time is set, you can rotate the knob to modify the dwell time at the current step. At this point, you can query and set the current step using the [\[\[:SOURce\]:SWEep:STEP:DWELI:STEP](#) command.

**Return Format** The query returns the dwell time of step sweep. For example, 3.000000000s.

**Example** :SWE:STEP:DWEL 3

:SWE:STEP:DWEL?

**Related Command** [\[\[:SOURce\]:SWEep:STEP:DWELI:STEP](#)

**[[:SOURce]:SWEep:STEP:DWELI:STEP**

**Syntax** [[:SOURce]:SWEep:STEP:DWELI:STEP <value>

[[:SOURce]:SWEep:STEP:DWELI:STEP?

**Description** Set the dwell time step.

Query the dwell time step.

Parameter	Name	Type	Range	Default
	<value>	Real	10ms to 10s	10ms

- Explanation**
- When <value> is set in "Number" form, the default unit is s. Besides, <value> can also be set in "Number + Unit" form; for example, 3000ms.
  - After the dwell time step is set, you can rotate the knob to modify the dwell time at the current step. At this point, you can query or set the dwell time using the [\[\[:SOURce\]:SWEep:STEP:DWELI](#) command.

**Return Format** The query returns the dwell time step. For example, 3.000000000s.

**Example** :SWE:STEP:DWEL:STEP 3

:SWE:STEP:DWEL:STEP?

**Related Command** [\[\[:SOURce\]:SWEep:STEP:DWELI](#)



**[[:SOURce]:SWEep:STEP:POINTs]****Syntax** [[:SOURce]:SWEep:STEP:POINTs <value>

[[:SOURce]:SWEep:STEP:POINTs?

**Description** Set the number of points of step sweep.

Query the number of points of step sweep.

**Parameter**

Name	Type	Range	Default
<value>	Integer	2 to 65535	91

**Explanation**

- The number of sweep points decides the time interval between two neighboring sweep points.
- After the number of sweep points is set, you can rotate the knob to modify the number of sweep points at the current step. At this point, you can query or set the current step using the [\[\[:SOURce\]:SWEep:STEP:POINTs:STEP\]](#) command.

**Return Format** The query returns the number of sweep points. For example, 5.**Example** :SWE:STEP:POIN 5

:SWE:STEP:POIN?

**Related Command** [\[\[:SOURce\]:SWEep:STEP:POINTs:STEP\]](#)**[[:SOURce]:SWEep:STEP:POINTs:STEP]****Syntax** [[:SOURce]:SWEep:STEP:POINTs:STEP <value>

[[:SOURce]:SWEep:STEP:POINTs:STEP?

**Description** Set the step of the number of sweep points.

Query the step of the number of sweep points.

**Parameter**

Name	Type	Range	Default
<value>	Integer	1 to 10000	1

**Explanation**

After the step of the number of sweep points is set, you can rotate the knob to modify the number of sweep points at the current step. At this point, you can query or set the number of sweep points using the [\[\[:SOURce\]:SWEep:STEP:POINTs\]](#) command.

**Return Format** The query returns the step of the number of sweep points. For example, 2.**Example** :SWE:STEP:POIN:STEP 2

:SWE:STEP:POIN:STEP?

**Related Command** [\[\[:SOURce\]:SWEep:STEP:POINTs\]](#)

**[[:SOURce]:SWEep:STEP:SHAPE**

**Syntax** [[:SOURce]:SWEep:STEP:SHAPE TRIangle|RAMP

[[:SOURce]:SWEep:STEP:SHAPE?

**Description** Set the step sweep shape.

Query the step sweep shape.

**Parameter**

Name	Type	Range	Default
TRIangle RAMP	Discrete	TRIangle RAMP	RAMP

- Explanation**
- The sweep shape decides the cycle mode of multiple sweeps.
  - TRIangle: select "Triangle" waveform. The sweep period always starts from the start frequency or start level to the stop frequency or stop level and then returns back to the start frequency or start level (when the sweep direction is "Fwd").
  - RAMP: select "Ramp" waveform. The sweep period always starts from the start frequency or start level to the stop frequency or stop level (when the sweep direction is "Fwd").

**Return Format** The query returns TRI or RAMP.

**Example** :SWE:STEP:SHAP TRI

:SWE:STEP:SHAP?

**Related Command** [\[:SOURce\]:SWEep:DIRection](#)

**[[:SOURce]:SWEep:STEP:SPACing**

**Syntax** [[:SOURce]:SWEep:STEP:SPACing LINear|LOGarithmic

[[:SOURce]:SWEep:STEP:SPACing?

**Description** Set the step sweep spacing.

Query the step sweep spacing.

**Parameter**

Name	Type	Range	Default
LINear LOGarithmic	Discrete	LINear LOGarithmic	LINear

- Explanation**
- The sweep spacing refers to the variation mode from one frequency or level to another frequency or level within a step.
  - LINear: set the sweep spacing to "Lin". Note that level sweep only supports "Lin" sweep spacing.
  - LOGarithmic: set the sweep spacing to "Log".

**Return Format** The query returns LIN or LOG.

**Example** :SWE:STEP:SPAC LIN

:SWE:STEP:SPAC?

**[[:SOURce]:SWEep:STEP:START:FREQuency]**

**Syntax** [:SOURce]:SWEep:STEP:START:FREQuency <value>  
[:SOURce]:SWEep:STEP:START:FREQuency?

**Description** Set the start frequency of the sweep.

Query the start frequency of the sweep.

**Parameter**

Name	Type	Range	Default
<value>	Real	9kHz to 3GHz	100MHz

- Explanation**
- When <value> is set in "Number" form, the default unit is Hz. Besides, <value> can also be set in "Number + Unit" form; for example, 4MHz.
  - After the start frequency is set, you can rotate the knob to modify the start frequency at the current step. At this point, you can query or set the current step using the [\[:SOURce\]:SWEep:STEP:START:FREQuency:STEP](#) command.

**Return Format** The query returns the start frequency of the sweep. For example, 4.00000000MHz.

**Example** :SWE:STEP:STAR:FREQ 4MHz  
:SWE:STEP:STAR:FREQ?

**Related Command** [\[:SOURce\]:SWEep:STEP:START:FREQuency:STEP](#)

**[[:SOURce]:SWEep:STEP:START:FREQuency:STEP]**

**Syntax** [:SOURce]:SWEep:STEP:START:FREQuency:STEP <value>  
[:SOURce]:SWEep:STEP:START:FREQuency:STEP?

**Description** Set the start frequency step of the sweep.

Query the start frequency step of the sweep.

**Parameter**

Name	Type	Range	Default
<value>	Real	10mHz to 1GHz	100MHz

- Explanation**
- When <value> is set in "Number" form, the default unit is Hz. Besides, <value> can also be set in "Number + Unit" form; for example, 3kHz.
  - After the start frequency step is set, you can rotate the knob to modify the start frequency at the current step. At this point, you can query or set the start frequency using the [\[:SOURce\]:SWEep:STEP:START:FREQuency](#) command.

**Return Format** The query returns the start frequency step of the sweep. For example, 3.00000kHz.

**Example** :SWE:STEP:STAR:FREQ:STEP 3kHz  
:SWE:STEP:STAR:FREQ:STEP?

**Related Command** [\[:SOURce\]:SWEep:STEP:START:FREQuency](#)

**[[:SOURce]:SWEep:STEP:START:LEVel]**

**Syntax** [[:SOURce]:SWEep:STEP:START:LEVel <value>

[[:SOURce]:SWEep:STEP:START:LEVel?

**Description** Set the start level of the sweep.

Query the start level of the sweep.

**Parameter**

Name	Type	Range	Default
<value>	Real	-110dBm to 20dBm	-10dBm

- Explanation**
- When <value> is set in "Number" form (for example, 2), the default unit is dBm. When <value> is set in "Number + Unit" form (for example, 2dBm), the start level displayed in the interface of the RF signal generator is related to the setting of **Level Unit**.
    - When the level unit is "dBm", 2.00dBm is displayed.
    - When the level unit is "dBmV", 48.99dBmV is displayed.
    - When the level unit is "dBuV", 108.99dBuV is displayed.
    - When the level unit is "Volts", 281.50mV is displayed.
    - When the level unit is "Watts", 1.58mW is displayed.
  - The default unit of the return value is dBm.
  - After the start level is set, you can rotate the knob to modify the start level at the current step. At this point, you can query or set the current step using the [\[:SOURce\]:SWEep:STEP:START:LEVel:STEP](#) command.

**Return Format** The query returns the start level of the sweep. For example, 2.00.

**Example** :SWE:STEP:STAR:LEV 2dBm

:SWE:STEP:STAR:LEV?

**Related Command** [\[:SOURce\]:SWEep:STEP:START:LEVel:STEP](#)

**[[:SOURce]:SWEep:STEP:STARt:LEVel:STEP**

**Syntax** [:SOURce]:SWEep:STEP:STARt:LEVel:STEP <value>  
[:SOURce]:SWEep:STEP:STARt:LEVel:STEP?

**Description** Set the start level step of the sweep.

Query the start level step of the sweep.

Parameter	Name	Type	Range	Default
	<value>	Real	0.01dB to 100dB	1dB

- Explanation**
- When <value> is set in "Number" form, the default unit is dB. Besides, <value> can also be set in "Number + Unit" form; for example, 20dB.
  - The default unit of the return value is dB.
  - After the start level step is set, you can rotate the knob to modify the start level at the current step. At this point, you can query or set the start level using the [\[:SOURce\]:SWEep:STEP:STARt:LEVel](#) command.

**Return Format** The query returns the start level step of the sweep. For example, 20.00.

**Example** :SWE:STEP:STAR:LEV:STEP 20  
:SWE:STEP:STAR:LEV:STEP?

**Related Command** [\[:SOURce\]:SWEep:STEP:STARt:LEVel](#)

**[[:SOURce]:SWEep:STEP:STOP:FREQuency**

**Syntax** [:SOURce]:SWEep:STEP:STOP:FREQuency <value>  
[:SOURce]:SWEep:STEP:STOP:FREQuency?

**Description** Set the stop frequency of the sweep.

Query the stop frequency of the sweep.

Parameter	Name	Type	Range	Default
	<value>	Real	9kHz to 3GHz	1GHz

- Explanation**
- When <value> is set in "Number" form, the default unit is Hz. Besides, <value> can also be set in "Number + Unit" form; for example, 4MHz.
  - After the stop frequency is set, you can rotate the knob to modify the stop frequency at the current step. At this point, you can query or set the current step using the [\[:SOURce\]:SWEep:STEP:STOP:FREQuency:STEP](#) command.

**Return Format** The query returns the stop frequency of the sweep. For example, 4.00000000MHz.

**Example** :SWE:STEP:STOP:FREQ 4MHz  
:SWE:STEP:STOP:FREQ?

**Related Command** [\[:SOURce\]:SWEep:STEP:STOP:FREQuency:STEP](#)

**[[:SOURce]:SWEep:STEP:STOP:FREQuency:STEP**

**Syntax** [[:SOURce]:SWEep:STEP:STOP:FREQuency:STEP <value>

[[:SOURce]:SWEep:STEP:STOP:FREQuency:STEP?

**Description** Set the stop frequency step of the sweep.

Query the stop frequency step of the sweep.

**Parameter**

Name	Type	Range	Default
<value>	Real	10mHz to 1GHz	100MHz

- Explanation**
- When <value> is set in "Number" form, the default unit is Hz. Besides, <value> can also be set in "Number + Unit" form, for example, 3kHz.
  - After the stop frequency step is set, you can rotate the knob to modify the stop frequency at the current step. At this point, you can query or set the stop frequency using the [\[:SOURce\]:SWEep:STEP:STOP:FREQuency](#) command.

**Return Format** The query returns the stop frequency step of the sweep. For example, 3.00000kHz.

**Example** :SWE:STEP:STOP:FREQ:STEP 3kHz

:SWE:STEP:STOP:FREQ:STEP?

**Related Command** [\[:SOURce\]:SWEep:STEP:STOP:FREQuency](#)

**[[:SOURce]:SWEep:STEP:STOP:LEVel**

**Syntax** [[:SOURce]:SWEep:STEP:STOP:LEVel <value>

[[:SOURce]:SWEep:STEP:STOP:LEVel?

**Description** Set the stop level of the sweep.

Query the stop level of the sweep.

**Parameter**

Name	Type	Range	Default
<value>	Real	-110dBm to 20dBm	-20dBm

**Explanation**

- When <value> is set in "Number" form (for example, 2), the default unit is dBm. When <value> is set in "Number + Unit" form (for example, 2dBm), the stop level displayed in the interface of the RF signal generator is related to the setting of **Level Unit**.
  - When the level unit is "dBm", 2.00dBm is displayed.
  - When the level unit is "dBmV", 48.99dBmV is displayed.
  - When the level unit is "dBuV", 108.99dBuV is displayed.
  - When the level unit is "Volts", 281.50mV is displayed.
  - When the level unit is "Watts", 1.58mW is displayed.
- The default unit of the return value is dBm.
- After the stop level is set, you can rotate the knob to modify the stop level at the current step. At this point, you can query or set the current step using the [\[\[:SOURce\]:SWEep:STEP:STOP:LEVel:STEP](#) command.

**Return Format** The query returns the stop level of the sweep. For example, 2.000000.

**Example** :SWE:STEP:STOP:LEV 2dBm

:SWE:STEP:STOP:LEV?

**Related Command** [\[\[:SOURce\]:SWEep:STEP:STOP:LEVel:STEP](#)

**[[:SOURce]:SWEep:STEP:STOP:LEVel:STEP**

**Syntax** [[:SOURce]:SWEep:STEP:STOP:LEVel:STEP <value>

[[:SOURce]:SWEep:STEP:STOP:LEVel:STEP?

**Description** Set the stop level step of the sweep.

Query the stop level step of the sweep.

**Parameter**

Name	Type	Range	Default
<value>	Real	0.01dB to 100dB	1dB

- Explanation**
- When <value> is set in "Number" form, the default unit is dB. Besides, <value> can also be set in "Number + Unit" form; for example, 20dB.
  - The default unit of the return value is dB.
  - After the stop level step is set, you can rotate the knob to modify the stop level at the current step. At this point, you can query or set the stop level using the [\[\[:SOURce\]:SWEep:STEP:STOP:LEVel](#) command.

**Return Format** The query returns the stop level step of the sweep. For example, 20.000000.

**Example** :SWE:STEP:STOP:LEV:STEP 20

:SWE:STEP:STOP:LEV:STEP?

**Related Command** [\[\[:SOURce\]:SWEep:STEP:STOP:LEVel](#)



**[[:SOURce]:SWEep:SWEep:TRIGger:TYPE**

**Syntax** [:SOURce]:SWEep:SWEep:TRIGger:TYPE AUTO|KEY|BUS|EXT  
[:SOURce]:SWEep:SWEep:TRIGger:TYPE?

**Description** Set the trigger mode of the sweep period.

Query the trigger mode of the sweep period.

Parameter	Name	Type	Range	Default
	AUTO KEY BUS EXT	Discrete	AUTO KEY BUS EXT	AUTO

- Explanation**
- AUTO: select "Auto" trigger mode. If the sweep mode is set to "Cont", the instrument will start sweeping once a sweep manner is selected. If the sweep mode is set to "Single", you need to send the [\[:SOURce\]:SWEep:EXECute](#) command to meet the single sweep condition; after that, the instrument will start a sweep and then stops.
  - KEY: select "Key" trigger mode. If the sweep mode is set to "Cont", the instrument starts a sweep each time **Key Trig** is pressed; if the sweep mode is set to "Single", you need to send the [\[:SOURce\]:SWEep:EXECute](#) command to meet the single sweep condition and after that, the instrument starts a sweep and then stops each time **Key Trig** is pressed.
  - BUS: select "Bus" trigger mode. If the sweep mode is set to "Cont", the instrument starts a sweep each time the [\\*TRG](#) or [:TRIGger\[:SWEep\]\[:IMMEDIATE\]](#) command is sent; if the sweep mode is set to "Single", you need to send the [\[:SOURce\]:SWEep:EXECute](#) command to meet the single sweep condition and after that, the instrument starts a sweep and then stops each time the [\\*TRG](#) or [:TRIGger\[:SWEep\]\[:IMMEDIATE\]](#) command is sent.
  - EXT: select "Ext" trigger mode. The RF signal generator receives the trigger signal input from the **[TRIGGER IN]** connector at the rear panel. If the sweep mode is set to "Cont", the instrument starts a sweep each time a TTL pulse signal with the specified polarity is received. If the sweep mode is set to "Single", you need to send the [\[:SOURce\]:SWEep:EXECute](#) command to meet the single sweep condition; after that, the instrument starts a sweep and then stops each time a TTL pulse signal with the specified polarity is received.
- Note:** The above explanations are only valid when the trigger mode of each sweep point within the sweep period is met.
- When executing the sweep operation, the priority of the required conditions is: single sweep → trigger mode → point trigger mode.

**Return Format** The query returns the trigger mode of the sweep. For example, AUTO.

**Example** :SWE:SWE:TRIG:TYPE AUTO  
:SWE:SWE:TRIG:TYPE?

**Related Commands** [\[:SOURce\]:SWEep:EXECute](#)  
[\[:SOURce\]:SWEep:MODE](#)  
[\[:SOURce\]:SWEep:POINT:TRIGger:TYPE](#)  
[\\*TRG](#)  
[:TRIGger\[:SWEep\]\[:IMMEDIATE\]](#)

**[[:SOURce]:SWEep:TYPE**

**Syntax** [:SOURce]:SWEep:TYPE LIST|STEP

[:SOURce]:SWEep:TYPE?

**Description** Set the sweep type.

Query the sweep type.

**Parameter**

Name	Type	Range	Default
LIST STEP	Discrete	LIST STEP	STEP

- Explanation**
- LIST: select "List" sweep type. At this point, the RF signal generator sweeps according to the sweep list currently loaded.
  - STEP: select "Step" sweep type. At this point, the RF signal generator performs step sweep according the current setting.

**Return Format** The query returns the sweep type (LIST or STEP).

**Example** :SWE:TYPE STEP

:SWE:TYPE?

## :STATus Commands

The :STATus commands and IEEE488.2 common commands are mainly used to operate or query the status register. The structure of the status register is as shown in the figure below. It includes the questionable status register, operation status register, standard event status register, status byte register and error queue. The STATus commands are used to set and query the questionable status register and operation status register; the IEEE488.2 common commands are used to perform operations on the standard event status register and status byte register.

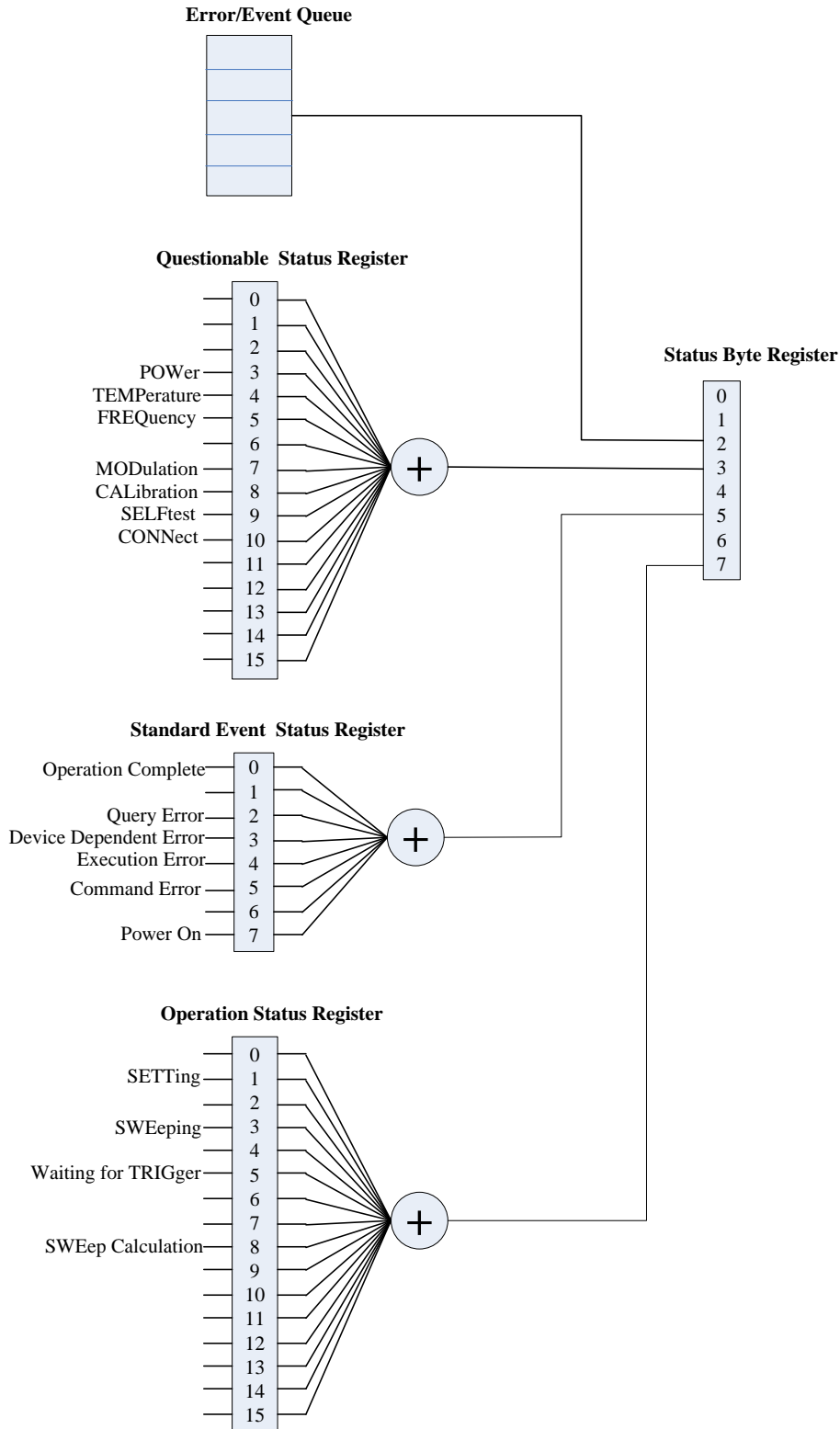

The definitions of the questionable status register are as shown in the table below. Wherein, bit 0 to bit 2, bit 6 and bit 11 to bit 15 are not used and will be always treated as 0.

Bit	Value	Definition
0	0	Not Used
1	0	Not Used
2	0	Not Used
3	8	Power
4	16	Temperature
5	32	Frequency
6	0	Not Used
7	128	Modulation
8	256	Calibration
9	512	Selftest
10	1024	Connect
11	0	Not Used
12	0	Not Used
13	0	Not Used
14	0	Not Used
15	0	Not Used

The definitions of the operation status register are as shown in the table below. Wherein, bit 0, bit 2, bit 4, bit 6, bit 7 and bit 9 to bit 15 are not used and will always be treated as 0.

Bit	Value	Definition
0	0	Not Used
1	2	Setting
2	0	Not Used
3	8	Sweeping
4	0	Not Used
5	32	Waiting for Trigger
6	0	Not Used
7	0	Not Used
8	256	Sweep Calculation
9	0	Not Used
10	0	Not Used
11	0	Not Used
12	0	Not Used
13	0	Not Used
14	0	Not Used
15	0	Not Used

**Command List:**

- ◆ [:STATus:OPERation:CONDition](#)
- ◆ [:STATus:OPERation:ENABLE](#)
- ◆ [:STATus:OPERation\[:EVENT\]](#)
- ◆ [:STATus:QUEStionable:CALibration:CONDition](#)
- ◆ [:STATus:QUEStionable:CALibration:ENABLE](#)
- ◆ [:STATus:QUEStionable:CALibration\[:EVENT\]](#)
- ◆ [:STATus:QUEStionable:CONDition](#)
- ◆ [:STATus:QUEStionable:CONNect:CONDition](#)
- ◆ [:STATus:QUEStionable:CONNect:ENABLE](#)
- ◆ [:STATus:QUEStionable:CONNect\[:EVENT\]](#)
- ◆ [:STATus:QUEStionable:ENABLE](#)
- ◆ [:STATus:QUEStionable\[:EVENT\]](#)
- ◆ [:STATus:QUEStionable:FREQuency:CONDition](#)
- ◆ [:STATus:QUEStionable:FREQuency:ENABLE](#)
- ◆ [:STATus:QUEStionable:FREQuency\[:EVENT\]](#)
- ◆ [:STATus:QUEStionable:MODulation:CONDition](#)
- ◆ [:STATus:QUEStionable:MODulation:ENABLE](#)
- ◆ [:STATus:QUEStionable:MODulation\[:EVENT\]](#)
- ◆ [:STATus:QUEStionable:POWer:CONDition](#)
- ◆ [:STATus:QUEStionable:POWer:ENABLE](#)
- ◆ [:STATus:QUEStionable:POWer\[:EVENT\]](#)
- ◆ [:STATus:QUEStionable:SELFtest:CONDition](#)
- ◆ [:STATus:QUEStionable:SELFtest:ENABLE](#)
- ◆ [:STATus:QUEStionable:SELFtest\[:EVENT\]](#)
- ◆ [:STATus:QUEStionable:TEMP:CONDition](#)
- ◆ [:STATus:QUEStionable:TEMP:ENABLE](#)
- ◆ [:STATus:QUEStionable:TEMP\[:EVENT\]](#)

### :STATus:OPERation:CONDition

**Syntax** :STATus:OPERation:CONDition?

**Description** Query the value of the condition register for the operation status register.

**Explanation** The bit 0, bit 2, bit 4, bit 6, bit 7 and bit 9 to bit 15 of the operation status register are not used and will always be treated as 0; therefore, the range of the return value of the command are the decimal numbers corresponding to the binary numbers ranging from 0000000000000000 (0 in decimal) to 1111111111111111 (32767 in decimal) and of which the bit 0, bit 2, bit 4, bit 6, bit 7 and bit 9 to bit 15 are 0.

**Return Format** The query returns the value of the condition register in integer. For example, 0.

### :STATus:OPERation:ENABLE

**Syntax** :STATus:OPERation:ENABle <value>  
:STATus:OPERation:ENABle?

**Description** Set the value of the enable register for the operation status register.  
Query the value of the enable register for the operation status register.

Parameter	Name	Type	Range	Default
	<value>	Integer	Refer to the "Explanation"	0

**Explanation** The range of <value> are the decimal numbers corresponding to the binary numbers ranging from 0000000000000000 (0 in decimal) to 1111111111111111 (32767 in decimal).

**Return Format** The query returns the value of the enable register of the operation status register in integer.

**Example** :STAT:OPER:ENAB 100  
:STAT:OPER:ENAB?

### :STATus:OPERation[:EVENT]

**Syntax** :STATus:OPERation[:EVENT]?

**Description** Query the value of the event register for the operation status register.

**Explanation** The bit 0, bit 2, bit 4, bit 6, bit 7 and bit 9 to bit 15 of the operation status register are not used and will always be treated as 0; therefore, the range of the return value of the command are the decimal numbers corresponding to the binary numbers ranging from 0000000000000000 (0 in decimal) to 1111111111111111 (32767 in decimal) and of which the bit 0, bit 2, bit 4, bit 6, bit 7 and bit 9 to bit 15 are 0.

**Return Format** The query returns the value of the event register in integer. For example, 0.

## :STATus:QUEStionable:CALibration:CONDition

**Syntax** :STATus:QUEStionable:CALibration:CONDition?

**Description** Query the value of the condition register for the questionable calibration status register.

**Explanation** ➤ The relation between the calibration status register and questionable status register is as shown in the figure below.

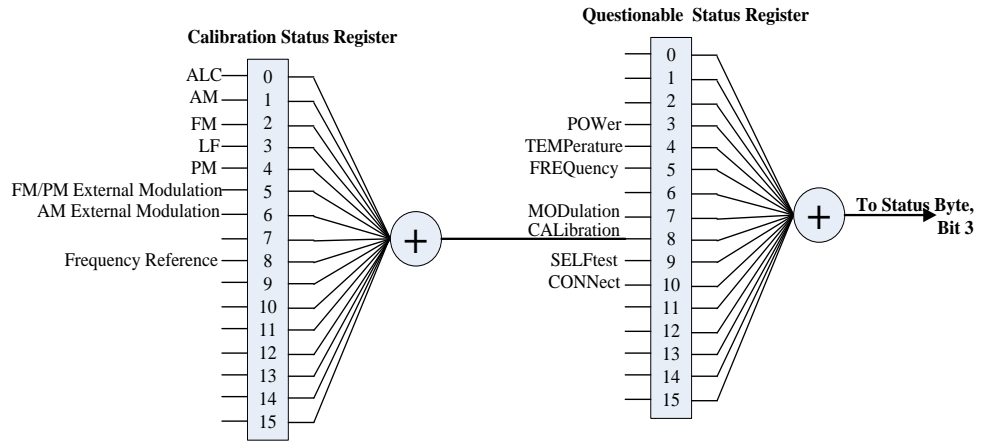

➤ The definitions of the questionable calibration status register are as shown in the table below. Wherein, bit 0 and bit 9 to bit 15 are not used and will be always treated as 0. The range of the return value are the decimal numbers corresponding to the binary numbers ranging from 0000000000000000 (0 in decimal) to 1111111111111111 (32767 in decimal) and of which the bit 0 and bit 9 to bit 15 are 0 (bit 2 and bit 4 cannot be 1 at the same time).

Bit	Value	Definition
0	1	Not Used
1	2	AM
2	4	FM
3	8	LF
4	16	ØM
5	32	FM/ØM External Modulation
6	64	AM External Modulation
7	0	Not Used
8	256	Frequency Reference
9	0	Not Used
10	0	Not Used
11	0	Not Used
12	0	Not Used
13	0	Not Used
14	0	Not Used
15	0	Not Used

**Return Format** The query returns the value of the condition register of the questionable calibration status register in integer. For example, 24.

**:STATus:QUEStionable:CALibration:ENABle**

**Syntax** :STATus:QUEStionable:CALibration:ENABle <value>

:STATus:QUEStionable:CALibration:ENABle?

**Description** Set the value of the enable register for the questionable calibration status register.

Query the value of the enable register for the questionable calibration status register.

Parameter	Name	Type	Range	Default
	<value>	Integer	Refer to the "Explanation"	0

**Explanation** In the questionable calibration status register, the range of <value> are the decimal numbers corresponding to the binary numbers ranging from 0000000000000000 (0 in decimal) to 1111111111111111 (32767 in decimal).

**Return Format** The query returns the value of the enable register of the questionable calibration status register in integer.

**Example** :STAT:QUES:CAL:ENAB 100

:STAT:QUES:CAL:ENAB?

**:STATus:QUEStionable:CALibration[:EVENT]**

**Syntax** :STATus:QUEStionable:CALibration[:EVENT]?

**Description** Query the value of the event register for the questionable calibration status register.

**Explanation** The bit 0 and bit 9 to bit 15 of the questionable calibration status register are not used and will be always treated as 0. The range of the return value are the decimal numbers corresponding to the binary numbers ranging from 0000000000000000 (0 in decimal) to 1111111111111111 (32767 in decimal) and of which the bit 0 and bit 9 to bit 15 are 0 (bit 2 and bit 4 cannot be 1 at the same time).

**Return Format** The query returns the value of the event register of the questionable calibration status register in integer. For example, 24.

**:STATus:QUEStionable:CONDition**

**Syntax** :STATus:QUEStionable:CONDition?

**Description** Query the value of the condition register for the questionable status register.

**Explanation** The bit 0 to bit 2, bit 6 and bit 11 to bit 15 of the questionable status register are not used and are always treated as 0; therefore, the range of the return value are the decimal numbers corresponding to the binary numbers ranging from 0000000000000000 (0 in decimal) to 1111111111111111 (32767 in decimal) and of which the bit 0 to bit 2, bit 6 and bit 11 to bit 15 are 0.

**Return Format** The query returns the value of the condition register of the questionable status register in integer. For example, 0.



## :STATus:QUEStionable:CONNect:CONDition

**Syntax** :STATus:QUEStionable:CONNect:CONDition?

**Description** Query the value of the condition register for the questionable connect status register.

**Explanation** ➤ The relation between the connect status register and questionable status register is as shown in the figure below.

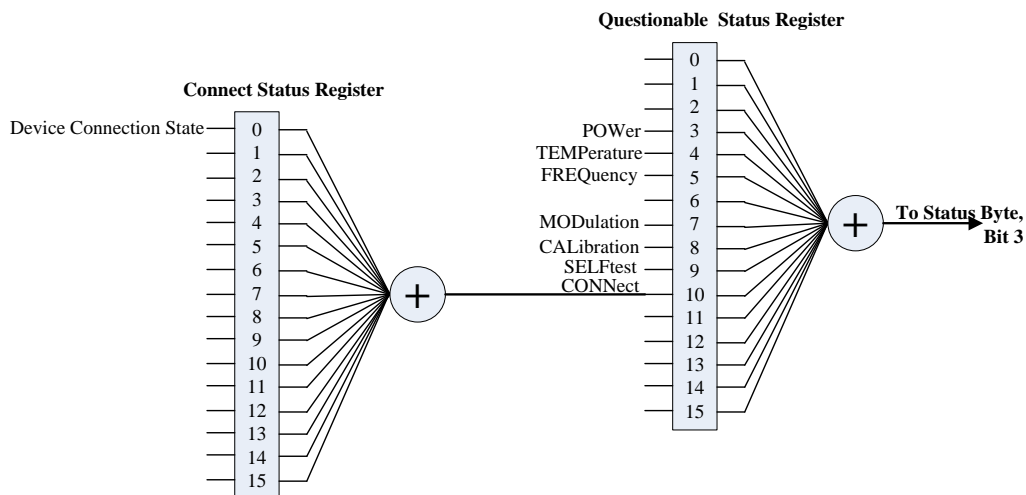

➤ The definitions of the questionable connect status register are as shown in the table below. Wherein, bit 1 to bit 15 are not used and will be always treated as 0. The range of the return value are the decimal numbers corresponding to the binary numbers ranging from 0000000000000000 (0 in decimal) to 0000000000000001 (1 in decimal).

Bit	Value	Definition
0	1	Device Connection State
1	0	Not Used
2	0	Not Used
3	0	Not Used
4	0	Not Used
5	0	Not Used
6	0	Not Used
7	0	Not Used
8	0	Not Used
9	0	Not Used
10	0	Not Used
11	0	Not Used
12	0	Not Used
13	0	Not Used
14	0	Not Used
15	0	Not Used

**Return Format** The query returns the value of the condition register of the questionable connect status register in integer. For example, 0.

### :STATus:QUEStionable:CONNect:ENABle

**Syntax** :STATus:QUEStionable:CONNect:ENABle <value>  
:STATus:QUEStionable:CONNect:ENABle?

**Description** Set the value of the enable register for the questionable connect status register.  
Query the value of the enable register for the questionable connect status register.

Parameter	Name	Type	Range	Default
	<value>	Integer	Refer to the "Explanation"	0

**Explanation** In the questionable connect status register, the range of <value> are the decimal numbers corresponding to the binary numbers ranging from 0000000000000000 (0 in decimal) to 1111111111111111 (32767 in decimal).

**Return Format** The query returns the value of the enable register of the questionable connect status register in integer.

**Example** :STAT:QUES:CONN:ENAB 1  
:STAT:QUES:CONN:ENAB?

### :STATus:QUEStionable:CONNect[:EVENT]

**Syntax** :STATus:QUEStionable:CONNect[:EVENT]?

**Description** Query the value of the event register for the questionable connect status register.

**Explanation** The bit 1 to bit 15 of the questionable connect status register are not used and will be always treated as 0. The range of the return value are the decimal numbers corresponding to the binary numbers ranging from 0000000000000000 (0 in decimal) to 0000000000000001 (1 in decimal).

**Return Format** The query returns the value of the event register of the questionable connect status register in integer.

### :STATus:QUEStionable:ENABle

**Syntax** :STATus:QUEStionable:ENABle <value>  
:STATus:QUEStionable:ENABle?

**Description** Set the value of the enable register for the questionable status register.  
Query the value of the enable register for the questionable status register.

Parameter	Name	Type	Range	Default
	<value>	Integer	Refer to the "Explanation"	0

**Explanation** The range of <value> are the decimal numbers corresponding to the binary numbers ranging from 0000000000000000 (0 in decimal) to 1111111111111111 (32767 in decimal).

**Return Format** The query returns the value of the enable register of the questionable status register in integer.

**Example** :STAT:QUES:ENAB 100  
:STAT:QUES:ENAB?

## :STATus:QUEStionable[:EVENT]

**Syntax** :STATus:QUEStionable[:EVENT]?

**Description** Query the value of the event register for the questionable status register.

**Explanation** The bit 0 to bit 2, bit 6 and bit 11 to bit 15 of the questionable status register are not used and are always treated as 0; therefore, the range of the return value are the decimal numbers corresponding to the binary numbers ranging from 0000000000000000 (0 in decimal) to 1111111111111111 (32767 in decimal) and of which the bit 0 to bit 2, bit 6 and bit 11 to bit 15 are 0.

**Return Format** The query returns the value of the event register of the questionable status register in integer. For example, 0.

## :STATus:QUEStionable:FREQuency:CONDition

**Syntax** :STATus:QUEStionable:FREQuency:CONDition?

**Description** Query the value of the condition register for the questionable frequency status register.

**Explanation** ➤ The relation between the frequency status register and questionable status register is as shown in the figure below.

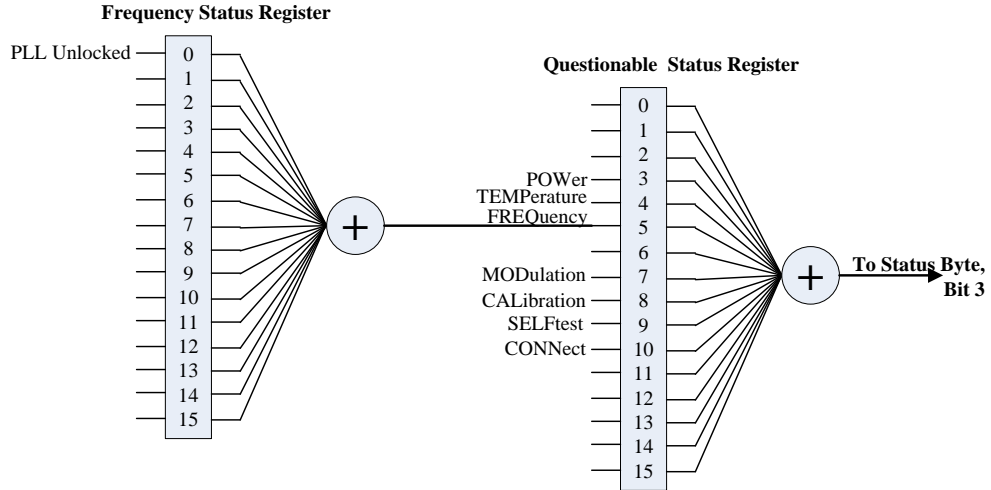

➤ The definitions of the questionable frequency status register are as shown in the table below. Wherein, bit 1 to bit 15 are not used and will be always treated as 0. The range of the return value are the decimal numbers corresponding to the binary numbers ranging from 0000000000000000 (0 in decimal) to 0000000000000001 (1 in decimal).

Bit	Value	Definition
0	1	PLL Unlocked
1	0	Not Used
2	0	Not Used
3	0	Not Used
4	0	Not Used
5	0	Not Used
6	0	Not Used
7	0	Not Used
8	0	Not Used
9	0	Not Used
10	0	Not Used
11	0	Not Used
12	0	Not Used
13	0	Not Used
14	0	Not Used
15	0	Not Used

**Return Format** The query returns the value of the condition register of the questionable frequency status register in integer.

**:STATus:QUEStionable:FREQuency:ENABle**

**Syntax** :STATus:QUEStionable:FREQuency:ENABle <value>  
:STATus:QUEStionable:FREQuency:ENABle?

**Description** Set the value of the enable register for the questionable frequency status register.  
Query the value of the enable register for the questionable frequency status register.

**Parameter**

Name	Type	Range	Default
<value>	Integer	Refer to the "Explanation"	0

**Explanation** In the questionable frequency status register, the range of <value> are the decimal numbers corresponding to the binary numbers ranging from 0000000000000000 (0 in decimal) to 1111111111111111 (32767 in decimal).

**Return Format** The query returns the value of the enable register of the questionable frequency status register in integer.

**Example** :STAT:QUES:FREQ:ENAB 1  
:STAT:QUES:FREQ:ENAB?

**:STATus:QUEStionable:FREQuency[:EVENT]**

**Syntax** :STATus:QUEStionable:FREQuency[:EVENT]?

**Description** Query the value of the event register for the questionable frequency status register.

**Explanation** The bit 1 to bit 15 of the questionable frequency status register are not used and will be always treated as 0. The range of the return value are the decimal numbers corresponding to the binary numbers ranging from 0000000000000000 (0 in decimal) to 0000000000000001 (1 in decimal).

**Return Format** The query returns the value of the event register of the questionable frequency status register in integer.

## :STATus:QUESTionable:MODulation:CONDition

**Syntax** :STATus:QUESTionable:MODulation:CONDition?

**Description** Query the value of the condition register for the questionable modulation status register.

**Explanation** ➤ The relation between the modulation status register and questionable status register is as shown in the figure below.

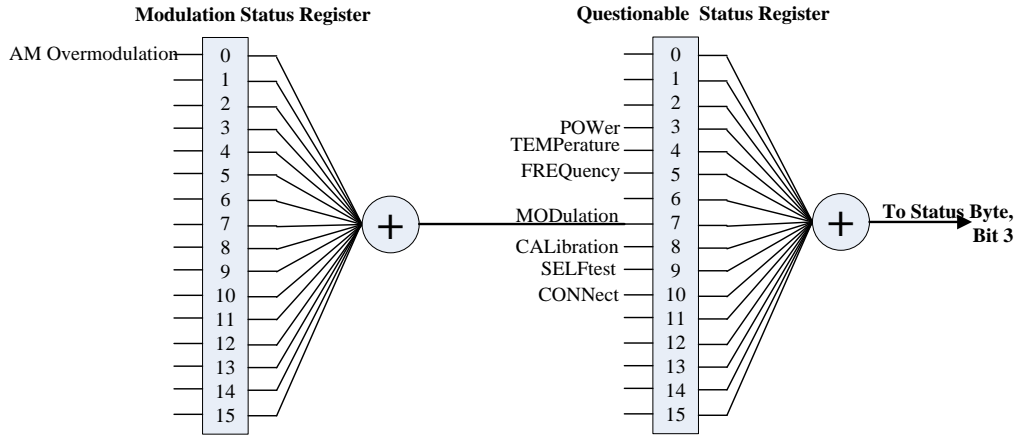

➤ The definitions of the questionable modulation status register are as shown in the table below. Wherein, bit 1 to bit 15 are not used and will be always treated as 0. The range of the return value are the decimal numbers corresponding to the binary numbers ranging from 0000000000000000 (0 in decimal) to 0000000000000001 (1 in decimal).

Bit	Value	Definition
0	1	AM Overmodulation
1	0	Not Used
2	0	Not Used
3	0	Not Used
4	0	Not Used
5	0	Not Used
6	0	Not Used
7	0	Not Used
8	0	Not Used
9	0	Not Used
10	0	Not Used
11	0	Not Used
12	0	Not Used
13	0	Not Used
14	0	Not Used
15	0	Not Used

**Return Format** The query returns the value of the condition register of the questionable modulation status register in integer.

**:STATus:QUEStionable:MODulation:ENABLE**

**Syntax** :STATus:QUEStionable:MODulation:ENABLE <value>  
:STATus:QUEStionable:MODulation:ENABLE?

**Description** Set the value of the enable register for the questionable modulation status register.  
Query the value of the enable register for the questionable modulation status register.

Parameter	Name	Type	Range	Default
	<value>	Integer	Refer to the "Explanation"	0

**Explanation** In the questionable modulation status register, the range of <value> are the decimal numbers corresponding to the binary numbers ranging from 0000000000000000 (0 in decimal) to 1111111111111111 (32767 in decimal).

**Return Format** The query returns the value of the enable register of the questionable modulation status register in integer.

**Example** :STAT:QUES:MOD:ENAB 1  
:STAT:QUES:MOD:ENAB?

**:STATus:QUEStionable:MODulation[:EVENT]**

**Syntax** :STATus:QUEStionable:MODulation[:EVENT]?

**Description** Query the value of the event register for the questionable modulation status register.

**Explanation** The bit 1 to bit 15 of the questionable modulation status register are not used and will be always treated as 0. The range of the return value are the decimal numbers corresponding to the binary numbers ranging from 0000000000000000 (0 in decimal) to 0000000000000001 (1 in decimal).

**Return Format** The query returns the value of the event register of the questionable modulation status register in integer.

## :STATus:QUESTionable:POWer:CONDition

**Syntax** :STATus:QUESTionable:POWer:CONDition?

**Description** Query the value of the condition register for the questionable power status register.

**Explanation** ➤ The relation between the power status register and questionable status register is as shown in the figure below.

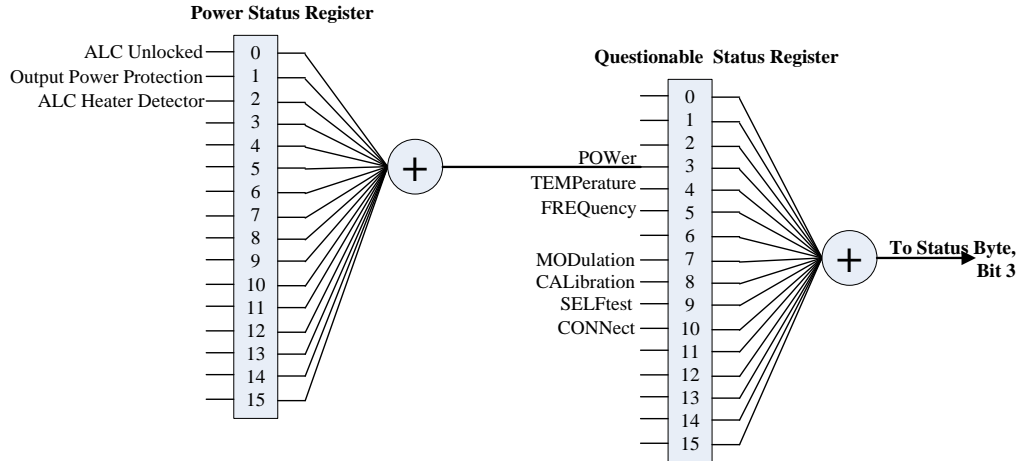

➤ The definitions of the questionable power status register are as shown in the table below. Wherein, bit 3 to bit 15 are not used and will be always treated as 0. The range of the return value are the decimal numbers corresponding to the binary numbers ranging from 0000000000000000 (0 in decimal) to 1111111111111111 (32767 in decimal) and of which the bit 3 to bit 15 are 0.

Bit	Value	Definition
0	1	ALC Unlocked
1	2	Output Power Protection
2	4	ALC Heater Detector, 30 min
3	0	Not Used
4	0	Not Used
5	0	Not Used
6	0	Not Used
7	0	Not Used
8	0	Not Used
9	0	Not Used
10	0	Not Used
11	0	Not Used
12	0	Not Used
13	0	Not Used
14	0	Not Used
15	0	Not Used

**Return Format** The query returns the value of the condition register of the questionable power status register in integer.



**:STATus:QUEStionable:POWer:ENABle**

**Syntax** :STATus:QUEStionable:POWer:ENABle <value>  
:STATus:QUEStionable:POWer:ENABle?

**Description** Set the value of the enable register for the questionable power status register.  
Query the value of the enable register for the questionable power status register.

Parameter	Name	Type	Range	Default
	<value>	Integer	Refer to the "Explanation"	0

**Explanation** In the questionable power status register, the range of <value> are the decimal numbers corresponding to the binary numbers ranging from 0000000000000000 (0 in decimal) to 1111111111111111 (32767 in decimal).

**Return Format** The query returns the value of the enable register of the questionable power status register in integer.

**Example** :STAT:QUES:POW:ENAB 6  
:STAT:QUES:POW:ENAB?

**:STATus:QUEStionable:POWer[:EVENT]**

**Syntax** :STATus:QUEStionable:POWer[:EVENT]?

**Description** Query the value of the event register for the questionable power status register.

**Explanation** The bit 3 to bit 15 of the questionable power status register are not used and will be always treated as 0. The range of the return value are the decimal numbers corresponding to the binary numbers ranging from 0000000000000000 (0 in decimal) to 1111111111111111 (32767 in decimal) and of which the bit 3 to bit 15 are 0.

**Return Format** The query returns the value of the event register of the questionable power status register in integer.

## :STATus:QUEStionable:SELFtest:CONDition

**Syntax** :STATus:QUEStionable:SELFtest:CONDition?

**Description** Query the value of the condition register for the questionable selftest status register.

**Explanation** ➤ The relation between the selftest status register and questionable status register is as shown in the figure below.

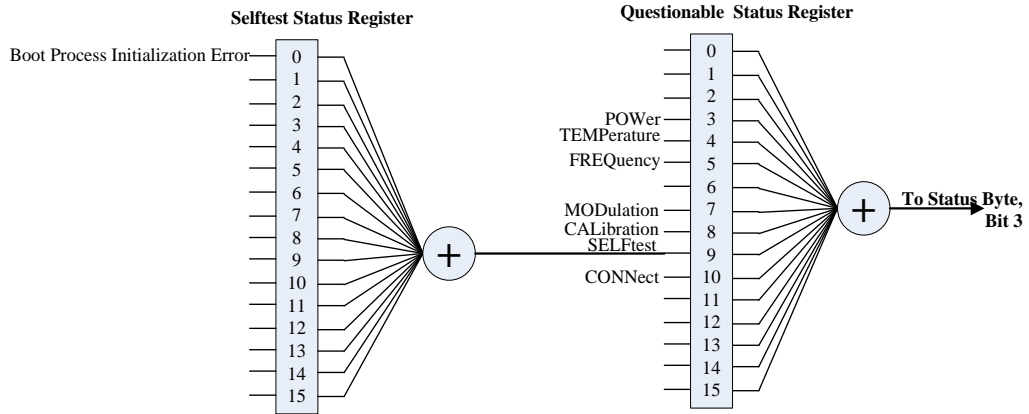

➤ The definitions of the questionable selftest status register are as shown in the table below. Wherein, bit 1 to bit 15 are not used and will be always treated as 0. The range of the return value are the decimal numbers corresponding to the binary numbers ranging from 0000000000000000 (0 in decimal) to 0000000000000001 (1 in decimal).

Bit	Value	Definition
0	1	Boot Process Initialization Error
1	0	Not Used
2	0	Not Used
3	0	Not Used
4	0	Not Used
5	0	Not Used
6	0	Not Used
7	0	Not Used
8	0	Not Used
9	0	Not Used
10	0	Not Used
11	0	Not Used
12	0	Not Used
13	0	Not Used
14	0	Not Used
15	0	Not Used

**Return Format** The query returns the value of the condition register of the questionable selftest status register in integer.

**:STATus:QUEStionable:SELfTest:ENABle**

**Syntax** :STATus:QUEStionable:SELfTest:ENABle <value>  
:STATus:QUEStionable:SELfTest:ENABle?

**Description** Set the value of the enable register for the questionable selftest status register.  
Query the value of the enable register for the questionable selftest status register.

Parameter	Name	Type	Range	Default
	<value>	Integer	Refer to the "Explanation"	0

**Explanation** In the questionable selftest status register, the range of <value> are the decimal numbers corresponding to the binary numbers ranging from 0000000000000000 (0 in decimal) to 1111111111111111 (32767 in decimal).

**Return Format** The query returns the value of the enable register of the questionable selftest status register in integer.

**Example** :STAT:QUES:SELF:ENAB 1  
:STAT:QUES:SELF:ENAB?

**:STATus:QUEStionable:SELfTest[:EVENT]**

**Syntax** :STATus:QUEStionable:SELfTest[:EVENT]?

**Description** Query the value of the event register for the questionable selftest status register.

**Explanation** The bit 1 to bit 15 of the questionable selftest status register are not used and will be always treated as 0. The range of the return value are the decimal numbers corresponding to the binary numbers ranging from 0000000000000000 (0 in decimal) to 0000000000000001 (1 in decimal).

**Return Format** The query returns the value of the event register of the questionable selftest status register in integer.

### :STATus:QUEStionable:TEMP:CONDition

**Syntax** :STATus:QUEStionable:TEMP:CONDition?

**Description** Query the value of the condition register for the questionable temperature status register.

**Explanation** ➤ The relation between the temperature status register and questionable status register is as shown in the figure below.

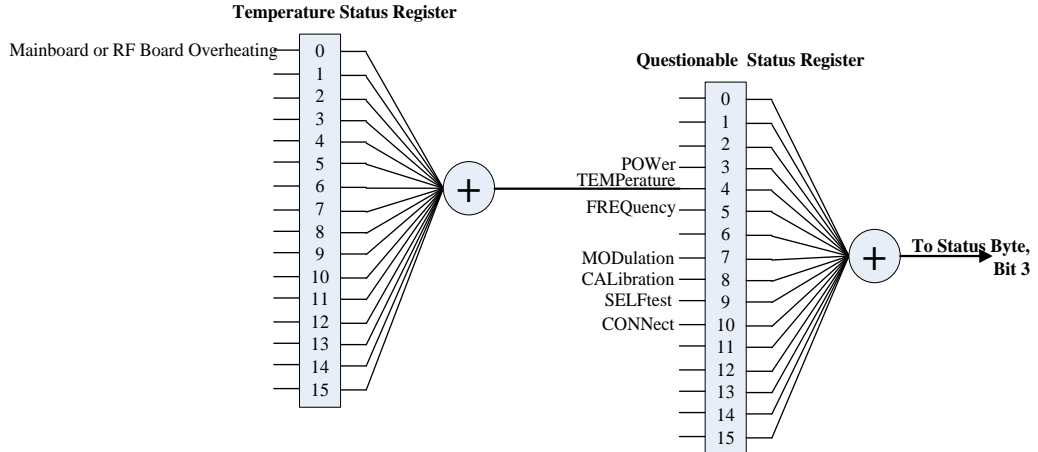

➤ The definitions of the questionable temperature status register are as shown in the table below. Wherein, bit 1 to bit 15 are not used and will be always treated as 0. The range of the return value are the decimal numbers corresponding to the binary numbers ranging from 0000000000000000 (0 in decimal) to 0000000000000001 (1 in decimal).

Bit	Value	Definition
0	1	Mainboard or RF Board Overheating
1	0	Not Used
2	0	Not Used
3	0	Not Used
4	0	Not Used
5	0	Not Used
6	0	Not Used
7	0	Not Used
8	0	Not Used
9	0	Not Used
10	0	Not Used
11	0	Not Used
12	0	Not Used
13	0	Not Used
14	0	Not Used
15	0	Not Used

**Return Format** The query returns the value of the condition register of the questionable temperature status register in integer.

**:STATus:QUEStionable:TEMP:ENABLE**

**Syntax** :STATus:QUEStionable:TEMP:ENABLE <value>  
:STATus:QUEStionable:TEMP:ENABLE?

**Description** Set the value of the enable register for the questionable temperature status register.  
Query the value of the enable register for the questionable temperature status register.

Parameter	Name	Type	Range	Default
	<value>	Integer	Refer to the "Explanation"	0

**Explanation** In the questionable temperature status register, the range of <value> are the decimal numbers corresponding to the binary numbers ranging from 0000000000000000 (0 in decimal) to 1111111111111111 (32767 in decimal).

**Return Format** The query returns the value of the enable register of the questionable temperature status register in integer.

**Example** :STAT:QUES:TEMP:ENAB 1  
:STAT:QUES:TEMP:ENAB?

**:STATus:QUEStionable:TEMP[:EVENT]**

**Syntax** :STATus:QUEStionable:TEMP[:EVENT]?

**Description** Query the value of the event register for the questionable temperature status register.

**Explanation** The bit 1 to bit 15 of the questionable temperature status register are not used and will be always treated as 0. The range of the return value are the decimal numbers corresponding to the binary numbers ranging from 0000000000000000 (0 in decimal) to 0000000000000001 (1 in decimal).

**Return Format** The query returns the value of the event register of the questionable temperature status register in integer.

## :SYSTem Commands

The :SYSTem commands are used to set a series of parameters relating to the system and the settings of these parameters do not affect the output signal of the RF signal generator.

### Command List:

- ◆ [:SYSTem:BRIGhtness](#)
- ◆ [:SYSTem:CLEAr](#)
- ◆ [:SYSTem:COMMunication:INTerface](#)
- ◆ [:SYSTem:COMMunication:LAN:DHCP](#)
- ◆ [:SYSTem:COMMunication:LAN:IP:ADDress](#)
- ◆ [:SYSTem:COMMunication:LAN:IP:AUTO](#)
- ◆ [:SYSTem:COMMunication:LAN:IP:GATeway](#)
- ◆ [:SYSTem:COMMunication:LAN:IP:MANual](#)
- ◆ [:SYSTem:COMMunication:LAN:IP:SET](#)
- ◆ [:SYSTem:COMMunication:LAN:IP:SUBnet:MASK](#)
- ◆ [:SYSTem:COMMunication:LAN:RESet](#)
- ◆ [:SYSTem:COMMunication:LAN\[:SELF\]:PREFerred](#)
- ◆ [:SYSTem:DATE](#)
- ◆ [:SYSTem:DISPlay:UPDate\[:STATe\]](#)
- ◆ [:SYSTem:FSWitch:STATe](#)
- ◆ [:SYSTem:LANGuage](#)
- ◆ [:SYSTem:LKEY](#)
- ◆ [:SYSTem:POWer:ON:TYPE](#)
- ◆ [:SYSTem:PRESet](#)
- ◆ [:SYSTem:PRESet:TYPE](#)
- ◆ [:SYSTem:PRESet:SAVE](#)
- ◆ [:SYSTem:TIME](#)

**:SYSTem:BRIGhtness**

**Syntax** :SYSTem:BRIGhtness <value>

:SYSTem:BRIGhtness?

**Description** Set the brightness of the LCD.

Query the brightness of the LCD.

**Parameter**

Name	Type	Range	Default
<value>	Integer	1 to 8	--

**Explanation** The "Brightness" setting will not be affected by factory reset.

**Return Format** The query returns an integer. For example, 3.

**Example** :SYST:BRIG 3

:SYST:BRIG?

**:SYSTem:CLEAr**

**Syntax** :SYSTem:CLEAr

**Description** Clear all the user-defined data.

**Explanation** The instrument will be reset to the factory setting after the data is cleared.

- Format the NAND FLASH;
- Reset the user data saved in NVRAM and NorFlash to the factory setting;
- Reset the HOST NAME, IP address and password in LXI to the factory setting.

**:SYSTem:COMMunication:INTerface**

**Syntax** :SYSTem:COMMunication:INTerface OFF|USB|LAN|AUTO

:SYSTem:COMMunication:INTerface?

**Description** Set the communication interface.

Query the communication interface.

**Parameter**

Name	Type	Range	Default
OFF USB LAN AUTO	Discrete	OFF USB LAN AUTO	OFF

- Explanation**
- The parameter USB|LAN|AUTO can set the communication interface to "USB", "LAN" or "Auto". When "OFF" is selected, all the communication interfaces are turned off.
  - If you are currently using a communication interface (for example, the USB interface), at this point, the query will always return the communication interface currently used no matter which type of communication interface you select.

**Return Format** The query returns the current communication interface. For example, USB.

**Example** :SYST:COMM:INT USB

:SYST:COMM:INT?

## :SYSTem:COMMunication:LAN:DHCP

**Syntax** :SYSTem:COMMunication:LAN:DHCP ON|OFF|1|0

:SYSTem:COMMunication:LAN:DHCP?

**Description** Turn on or off the DHCP mode.

Query the state of the DHCP mode.

Parameter	Name	Type	Range	Default
	ON OFF 1 0	Bool	ON OFF 1 0	ON 1

- Explanation**
- In DHCP mode, the DHCP server in the current network distributes network parameters (such as the IP address) for the instrument.
  - When all the three IP configuration modes are "On", the priority order of parameter configuration is "DHCP", "Auto-IP" and "Manual-IP".
  - The three IP configuration modes cannot be all set to "Off" at the same time.

**Return Format** The query returns 1 or 0.

**Example** :SYST:COMM:LAN:DHCP ON

:SYST:COMM:LAN:DHCP?

**Related Commands** [:SYSTem:COMMunication:LAN:IP:AUTO](#)  
[:SYSTem:COMMunication:LAN:IP:MANual](#)

## :SYSTem:COMMunication:LAN:IP:ADDRESS

**Syntax** :SYSTem:COMMunication:LAN:IP:ADDRESS <value>

:SYSTem:COMMunication:LAN:IP:ADDRESS?

**Description** Set the IP address.

Query the current IP address.

Parameter	Name	Type	Range	Default
	<value>	ASCII string	The format is nnn.nnn.nnn.nnn; wherein, the range of the first nnn is from 1 to 223 (except 127) and the ranges of the other three nnn are from 0 to 255	--

- Explanation**
- This command is only valid when the Manual-IP configuration mode is turned on.
  - You are recommended to ask your network administrator for an address available.

**Return Format** The query returns the IP address. For example, 172.16.3.199.

**Example** :SYST:COMM:LAN:IP:ADD 172.16.3.199

:SYST:COMM:LAN:IP:ADD?

**Related Command** [:SYSTem:COMMunication:LAN:IP:MANual](#)



**:SYSTem:COMMunication:LAN:IP:AUTO**

**Syntax** :SYSTem:COMMunication:LAN:IP:AUTO ON|OFF|1|0  
:SYSTem:COMMunication:LAN:IP:AUTO?

**Description** Turn on or off the Auto-IP configuration mode.  
Query the state of the Auto-IP configuration mode.

Parameter	Name	Type	Range	Default
	ON OFF 1 0	Bool	ON OFF 1 0	ON 1

- Explanation**
- In the Auto-IP configuration mode, the instrument acquires an IP address within 169.254.0.1 and 169.254.255.254 and the subnet mask 255.255.0.0 automatically based on the current network configuration.
  - When all the three IP configuration modes are "On", the priority order of parameter configuration is "DHCP", "Auto-IP" and "Manual-IP".
  - The three IP configuration modes cannot be all set to "Off" at the same time.

**Return Format** The query returns 1 or 0.

**Example** :SYST:COMM:LAN:IP:AUTO ON  
:SYST:COMM:LAN:IP:AUTO?

**Related Commands** [:SYSTem:COMMunication:LAN:DHCP](#)  
[:SYSTem:COMMunication:LAN:IP:MANual](#)

**:SYSTem:COMMunication:LAN:IP:GATeway**

**Syntax** :SYSTem:COMMunication:LAN:IP:GATeway <string>  
:SYSTem:COMMunication:LAN:IP:GATeway?

**Description** Set the default gateway.  
Query the current default gateway.

Parameter	Name	Type	Range	Default
	<string>	ASCII string	The format is nnn.nnn.nnn.nnn; wherein, the range of the first nnn is from 1 to 223 (except 127) and the ranges of the other three nnn are from 0 to 255	--

- Explanation**
- This command is only valid when the Manual-IP configuration mode is turned on.
  - You are recommended to ask your network administrator for an address available.

**Return Format** The query returns the default gateway. For example, 172.16.3.1.

**Example** :SYST:COMM:LAN:IP:GAT 172.16.3.1  
:SYST:COMM:LAN:IP:GAT?

**Related Command** [:SYSTem:COMMunication:LAN:IP:MANual](#)

## :SYSTem:COMMunication:LAN:IP:MANual

**Syntax** :SYSTem:COMMunication:LAN:IP:MANual ON|OFF|1|0

:SYSTem:COMMunication:LAN:IP:MANual?

**Description** Turn on or off the Manual-IP configuration mode.

Query the status of the Manual-IP configuration mode.

**Parameter**

Name	Type	Range	Default
ON OFF 1 0	Bool	ON OFF 1 0	OFF 0

- Explanation**
- In the Manual-IP configuration mode, the network parameters (such as the IP address) are defined by users.
  - When all the three IP configuration modes are "On", the priority order of parameter configuration is "DHCP", "Auto-IP" and "Manual-IP".
  - The three IP configuration modes cannot be all set to "Off" at the same time.

**Return Format** The query returns 1 or 0.

**Example** :SYST:COMM:LAN:IP:MAN ON

:SYST:COMM:LAN:IP:MAN?

**Related Commands** [:SYSTem:COMMunication:LAN:DHCP](#)  
[:SYSTem:COMMunication:LAN:IP:AUTO](#)

## :SYSTem:COMMunication:LAN:IP:SET

**Syntax** :SYSTem:COMMunication:LAN:IP:SET

**Description** Apply the current network parameter settings.

**Explanation** After setting the LAN parameters, you have to execute this command to apply the parameters. Otherwise, the settings are invalid.

**:SYSTem:COMMunication:LAN:IP:SUBnet:MASK**

**Syntax** :SYSTem:COMMunication:LAN:IP:SUBnet:MASK <value>  
:SYSTem:COMMunication:LAN:IP:SUBnet:MASK?

**Description** Set the subnet mask.

Query the current subnet mask.

Parameter	Name	Type	Range	Default
	<value>	ASCII string	The format is nnn.nnn.nnn.nnn and the range of the nnn is from 0 to 255.	--

**Explanation**

- This command is only valid when the Manual-IP configuration mode is turned on.
- You are recommended to ask your network administrator for a subnet mask available.

**Return Format** The query returns the subnet mask. For example, 255.255.255.0.

**Example** :SYST:COMM:LAN:IP:SUB:MASK 255.255.255.0  
:SYST:COMM:LAN:IP:SUB:MASK?

**Related Command** [:SYSTem:COMMunication:LAN:IP:MANual](#)

**:SYSTem:COMMunication:LAN:RESet**

**Syntax** :SYSTem:COMMunication:LAN:RESet

**Description** Reset the current network parameters.

**Explanation** After resetting the current parameters, DHCP and Auto-IP are turned on and Manual-IP is turned off.

**:SYSTem:COMMunication:LAN[:SELF]:PREFerred**

**Syntax** :SYSTem:COMMunication:LAN[:SELF]:PREFerred <value>  
:SYSTem:COMMunication:LAN[:SELF]:PREFerred?

**Description** Set the DNS (Domain Name Service).

Query the current DNS.

Parameter	Name	Type	Range	Default
	<value>	ASCII string	The format is nnn.nnn.nnn.nnn, wherein, the range of the first nnn is from 1 to 223 (except 127) and the ranges of the other three nnn are from 0 to 255	--

**Explanation** You are recommended to ask your network administrator for an address available.

**Return Format** The query returns the DNS address. For example, 172.16.2.3.

**Example** :SYST:COMM:LAN:PREF 172.16.2.3  
:SYST:COMM:LAN:PREF?

**:SYSTem:DATE**

**Syntax** :SYSTem:DATE <year>,<month>,<day>

:SYSTem:DATE?

**Description** Set the date of the instrument.

Query the date of the instrument.

**Parameter**

Name	Type	Range	Default
<year>	ASCII string	2000 to 2099	--
<month>	ASCII string	01 to 12	--
<day>	ASCII string	01 to 31	--

**Return Format** The query returns the current date in "YYYY,MM,DD" format. For example, 2015,04,21.

**Example** :SYST:DATE 2015,04,21

:SYST:DATE?

**:SYSTem:DISPlay:UPDate[:STATe]**

**Syntax** :SYSTem:DISPlay:UPDate[:STATe] ON|OFF|1|0

:SYSTem:DISPlay:UPDate[:STATe]?

**Description** Set the on/off state of the screen.

Query the on/off state of the screen.

**Parameter**

Name	Type	Range	Default
ON OFF 1 0	Bool	ON OFF 1 0	ON 1

**Explanation** When the screen is turned off, the screen stops updating and is locked. At this point, the measurement speed is improved. You can press **ESC** to unlock the screen. Screen locking is mainly used in remote operation mode.

**Return Format** The query returns 1 or 0.

**Example** :SYST:DISP:UPD OFF

:SYST:DISP:UPD?

**:SYSTem:FSWitch:STATe**

**Syntax** :SYSTem:FSWitch:STATe OPEN|DEFault  
:SYSTem:FSWitch:STATe?

**Description** Set the power status of the RF signal generator after power-on.  
Query the power status of the RF signal generator after power-on.

Parameter	Name	Type	Range	Default
	OPEN DEFault	Discrete	OPEN DEFault	--

**Explanation**

- OPEN: select "Open" state. The RF signal generator starts automatically after power-on.
- DEFault: select "Default" state. You have to press the power key at the front panel to start the RF signal generator after power-on.

**Return Format** The query returns Open or Default.

**Example** :SYST:FSW:STAT OPEN  
:SYST:FSW:STAT?

**:SYSTem:LANGuage**

**Syntax** :SYSTem:LANGuage CHINese|ENGLISH  
:SYSTem:LANGuage?

**Description** Set the system language.  
Query the system language.

Parameter	Name	Type	Range	Default
	CHINese ENGLISH	Discrete	CHINese ENGLISH	--

**Return Format** The query returns CHINESE or ENGLISH.

**Example** :SYST:LANG CHIN  
:SYST:LANG?

**:SYSTem:LKEY**

**Syntax** :SYSTem:LKEY <license key>

:SYSTem:LKEY? <option>

**Description** Install and activate the option of the instrument.

Query the license of the option installed.

Parameter	Name	Type	Range	Default
	<license key>	String	License of the option you bought	--
	<option>	Integer	Number of the option you bought (1 or 2)	--

- Explanation**
- The license for each option is unique and can only be used by one instrument (namely, the license of the option corresponds to the serial number of the instrument you bought).
  - The number of the option corresponds to the name of the option; wherein, 1 corresponds to DSG800-PUM and 2 corresponds to DSG800-PUG.

**Example** :SYST:LKEY JAVX3HDBQALKVSTDMAX2QJSMBBQT

:SYST:LKEY? 1

**:SYSTem:POWer:ON:TYPE**

**Syntax** :SYSTem:POWer:ON:TYPE LAST|PRESet

:SYSTem:POWer:ON:TYPE?

**Description** Select the instrument configuration to be used at start-up.

Query the instrument configuration to be used at start-up.

Parameter	Name	Type	Range	Default
	LAST PRESet	Discrete	LAST PRESet	--

- Explanation**
- LAST: the instrument loads the system configuration used before the last power-off automatically at start-up.
  - PRESet: the instrument loads the settings defined by the [:SYSTem:PRESet:TYPE](#) command automatically at start-up.

**Return Format** The query returns LAST or PRESET.

**Example** :SYST:POW:ON:TYPE LAST

:SYST:POW:ON:TYPE?

**Related Command** [:SYSTem:PRESet:TYPE](#)

## :SYSTem:PRESet

**Syntax** :SYSTem:PRESet

**Description** Reset the instrument to the preset state (the settings (FACTory or USER) defined by the [:SYSTem:PRESet:TYPE](#) command).

**Explanation** Sending this command is equivalent to pressing **Preset** at the front panel, namely recalling the default values or user-preset values related to this key.

**Related Commands** [:SYSTem:POWER:ON:TYPE](#)  
[:SYSTem:PRESet:TYPE](#)

## :SYSTem:PRESet:TYPE

**Syntax** :SYSTem:PRESet:TYPE FACTory|USER  
 :SYSTem:PRESet:TYPE?

**Description** Select the preset type of the system.

Query the preset type of the system.

Parameter	Name	Type	Range	Default
	FACTory USER	Discrete	FACTory USER	--

**Explanation**

- When the power-on setting is set to "Preset", the instrument loads the specified preset type ("Factory" or "User") after start-up.
- Pressing **Preset** at the front panel will recall the specified preset type.
- When the preset type is set to "User", you can use the [:SYSTem:PRESet:SAVE](#) command to save the current system configuration.

**Return Format** The query returns FACTORY or USER.

**Example** :SYST:PRESet:TYPE USER  
 :SYST:PRESet:TYPE?

**Related Commands** [:SYSTem:POWER:ON:TYPE](#)  
[:SYSTem:PRESet:SAVE](#)

## :SYSTem:PRESet:SAVE

**Syntax** :SYSTem:PRESet:SAVE

**Description** Save the user setting.

**Explanation**

- Using this command can save the current system configuration as user-defined setting in the internal non-volatile memory.
- When **Preset Type** is set to "User" (use the [:SYSTem:PRESet:TYPE](#) command), this configuration will be loaded when recalling "Preset" (use the [:SYSTem:POWER:ON:TYPE](#) command).
- When **Preset Type** is set to "Factory", this command is invalid.

**Related Commands** [:SYSTem:POWER:ON:TYPE](#)  
[:SYSTem:PRESet:TYPE](#)

**:SYSTem:TIME**

**Syntax** :SYSTem:TIME <hour>,<min>,<sec>

:SYSTem:TIME?

**Description** Set the time of the instrument.

Query the time of the instrument.

Parameter	Name	Type	Range	Default
	<hour>	ASCII string	00 to 23	--
	<min>	ASCII string	00 to 59	--
	<sec>	ASCII string	00 to 59	--

**Return Format** The query returns the current time in "hh,mm,ss" format. For example, 16,40,30.

**Example** SYST:TIME 16,40,30

SYST:TIME?

**:SYSTem:TIME:STATe**

**Syntax** :SYSTem:TIME:STATe ON|OFF

:SYSTem:TIME:STATe?

**Description** Set the on/off status of the display of the time and date.

Query the on/off status of the display of the time and date.

Parameter	Name	Type	Range	Default
	ON OFF	Bool	ON OFF	OFF

- Explanation**
- ON: turn on the display of the time and date.
  - OFF: turn off the display of the time and date.

**Return Format** The query returns ON or OFF.

**Example** SYST:TIME:STAT ON

SYST:TIME:STAT?



## :TRIGger Commands

### Command List:

- ◆ [:TRIGger:PULSe\[:IMMEDIATE\]](#)
- ◆ [:TRIGger\[:SWEep\]\[:IMMEDIATE\]](#)

### :TRIGger:PULSe[:IMMEDIATE]

**Syntax** :TRIGger:PULSe[:IMMEDIATE]

**Description** Trigger a pulse modulation immediately.

**Explanation** When the "Trig Mode" of pulse modulation is set to "Bus", the instrument starts a pulse modulation each time this command is sent.

**Example** :TRIG:PULS

**Related Command** [\\*TRG](#)

### :TRIGger[:SWEep][:IMMEDIATE]

**Syntax** :TRIGger[:SWEep][:IMMEDIATE]

**Description** Trigger a RF sweep immediately.

**Explanation** When the "Trig Mode" or "Point Trig" mode of SWEEP is set to "Bus" and the corresponding trigger condition is met, the instrument starts a RF sweep within the sweep period or sweeps a point and then stops each time this command is sent.

**Example** :TRIG:SWE

**Related Command** [\\*TRG](#)

## :UNIT Command

### Command List:

◆ [:UNIT:POWer](#)

### :UNIT:POWer

**Syntax** :UNIT:POWer DBM|DBMV|DBUV|V|W  
:UNIT:POWer?

**Description** Set the output and display unit of the amplitude.  
Query the output and display unit of the amplitude.

#### Parameter

Name	Type	Range	Default
DBM DBMV DBUV V W	Discrete	DBM DBMV DBUV V W	DBM

**Return Format** The query returns DBM, DBMV, DBUV, V or W.

**Example** :UNIT:POW V  
:UNIT:POW?

## Chapter 3 Application Examples

This chapter provides some application examples of the SCPI commands. A series of SCPI commands are combined to realize the main functions of the RF signal generator.

### Note:

1. The examples in this chapter are based on DSG830. For other models, the ranges of some parameters might be different. When using the commands, please make proper adjustment according to the model of your instrument.
2. Before using the examples in this chapter, please select the desired communication interface (USB or LAN) and make correct connections (refer to the introductions in [To Build Remote Communication](#)). Besides, you have to install Ultra Sigma or other PC software for sending commands on your PC.
3. The content enclosed in "/"\* and "\*" /" after each command in the application examples in this chapter is annotation for easier understanding and is not a part of the command.

### Main topics of this chapter:

- ◆ [To Output RF signal](#)
- ◆ [To Output RF Sweep Signal](#)
- ◆ [To Output RF Modulated Signal](#)

## To Output RF signal

### Requirement

Use the SCPI commands to realize the following functions:

Output a RF signal with 1GHz frequency and -20dBm amplitude from the **[RF OUTPUT 50Ω]** connector.

### Method

- |    |                     |  |
|----|---------------------|--|
| 1. | *IDN?               | /*Query the ID string of the RF signal generator to check whether the remote communication is normal*/ |
| 2. | :SYST:PRES:TYPE FAC | /*Set the preset type to "Factory"*/   |
| 3. | :SYST:PRES          | /*Restore the instrument to the factory setting*/  |
| 4. | :FREQ 1GHz          | /*Set the RF signal frequency to 1GHz*/  |
| 5. | :LEV -20            | /*Set the RF signal amplitude to -20dBm*/  |
| 6. | :OUTP ON            | /*Turn on the RF output*/  |

## To Output RF Sweep Signal

### Requirement

Use the SCPI commands to realize the following functions:

Output a RF sweep signal from the **[RF OUTPUT 50Ω]** connector by configuring continuous linear step sweep. Set the frequency range to 1GHz to 2GHz, the amplitude range to -20dBm to 0dBm, the number of sweep points to 10 and the dwell time to 500ms.

### Method

- |     |                          |  |
|-----|--------------------------|--|
| 1.  | *IDN?                    | /*Query the ID string of the RF signal generator to check whether the remote communication is normal*/   |
| 2.  | :SYST:PRES:TYPE FAC      | /*Set the preset type to "Factory"*/   |
| 3.  | :SYST:PRES               | /*Restore the instrument to the factory setting (by default, the sweep mode is continuous, the sweep type is step and the sweep spacing is linear)*/ |
| 4.  | :SWE:STEP:STAR:FREQ 1GHz | /*Set the start frequency of step sweep to 1GHz*/  |
| 5.  | :SWE:STEP:STOP:FREQ 2GHz | /*Set the stop frequency of step sweep to 2GHz*/   |
| 6.  | :SWE:STEP:STAR:LEV -20   | /*Set the start level of step sweep to -20dBm*/  |
| 7.  | :SWE:STEP:STOP:LEV 0     | /*Set the stop level of step sweep to 0dBm*/   |
| 8.  | :SWE:STEP:POIN 10        | /*Set the number of step sweep points to 10*/  |
| 9.  | :SWE:STEP:DWEL 500ms     | /*Set the dwell time of step sweep to 500ms*/  |
| 10. | :SWE:STAT LEV,FREQ       | /*Turn on the frequency and level sweep functions at the same time*/   |
| 11. | :OUTP ON                 | /*Turn on the RF output*/  |

## To Output RF Modulated Signal

### Requirement

Use the SCPI commands to realize the following functions:

Output an AM modulated signal. Set the carrier frequency to 800MHz, the carrier amplitude to -20dBm, the AM modulation depth to 60% and the modulation frequency to 20kHz.

### Method

1.    \*IDN?                                   /\*Query the ID string of the RF signal generator to check whether the remote communication is normal\*/
2.    :SYST:PRES:TYPE FAC               /\*Set the preset type to "Factory"\*/
3.    :SYST:PRES                         /\*Restore the instrument to the factory setting (by default, the modulation source is internal and the modulation waveform is sine)\*/
4.    :FREQ 800MHz                       /\*Set the RF carrier frequency to 800MHz\*/
5.    :LEV -20                             /\*Set the RF carrier amplitude to -20dBm\*/
6.    :AM:DEPT 60                        /\*Set the AM modulation depth to 60%\*/
7.    :AM:FREQ 20kHz                     /\*Set the AM modulation frequency to 20kHz\*/
8.    :AM:STAT ON                        /\*Turn on the AM function\*/
9.    :MOD:STAT ON                       /\*Turn on the RF modulation\*/
10.   :OUTP ON                            /\*Turn on the RF output\*/

**Note:** The **RF/on** and **Mod/on** switches must be turned on.



## Chapter 4 Programming Demos

This chapter provides the demos for programming and controlling the RF signal generator using SCPI commands under Excel, Matlab, LabVIEW, Visual Basic and Visual C++ environment on the basis of NI-VISA.

NI-VISA (National Instrument-Virtual Instrument Software Architecture) is an advanced application programming interface developed by NI (National Instrument) for communicating with various instrument buses. It can communicate with the instrument in the same method regardless of the type of the instrument interface (USB or LAN/Ethernet).

The instrument communicating with NI-VISA via various interfaces is called "resource". The VISA descriptor (namely the "resource name") is used to describe the accurate name and location of the VISA resource. If LAN interface is currently used for communicating with the instrument, the VISA descriptor is :TCPIP0::172.16.3.199::INSTR. Before programming, please acquire the correct VISA descriptor.

### Main topics of this chapter:

- ◆ [Programming Preparations](#)
- ◆ [Excel Programming Demo](#)
- ◆ [Matlab Programming Demo](#)
- ◆ [LabVIEW Programming Demo](#)
- ◆ [Visual Basic Programming Demo](#)
- ◆ [Visual C++ Programming Demo](#)

# Programming Preparations

Before programming, you need to make the following preparations.

1. Make sure that your PC has been installed with the NI-VISA library (can be downloaded from the NI website: <http://www.ni.com/visa>). Here, the default installation path is C:\Program Files\IVI Foundation\VISA.
2. In this manual, the USB interface of the RF signal generator is used to communicate with the PC and please use a USB cable to connect the USB DEVICE interface at the rear panel of the RF signal generator to the PC.
3. Turn on the instrument after correctly connecting the RF signal generator and PC.
4. At this point, the "Found New Hardware Wizard" dialog box appears on the PC. Please follow the instructions to install the "USB Test and Measurement Device (IVI)".

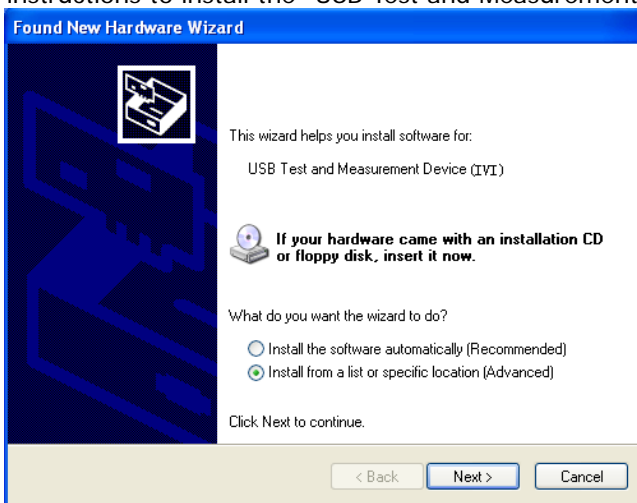

5. Acquire the USB VISA descriptor of the RF signal generator: run Ultra Sigma and search for the RF signal generator resource currently connected to the PC. The resource found is displayed under the "RIGOL Online Resource" directory, including the instrument model and the USB interface information (namely the VISA descriptor) as shown in the figure below. Here, the VISA descriptor of the RF signal generator is USB0::0x1AB1::0x6666::DSG8A170200001::INSTR.

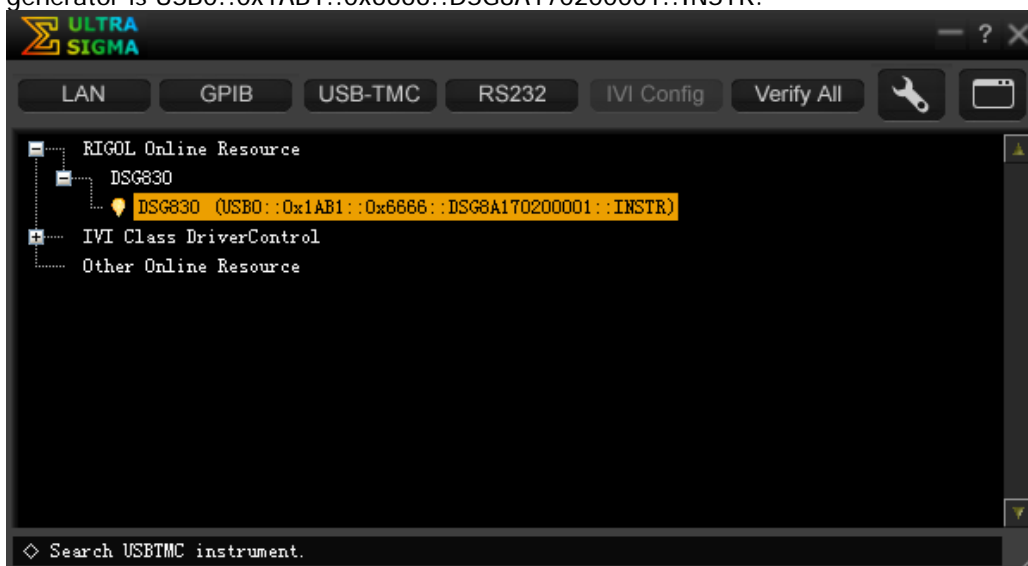

By now, the programming preparations are finished.



## Excel Programming Demo

The program used in this demo: Microsoft Excel 2010

The functions realized in this demo: send the \*IDN? Command to read the device information.

1. Create a new Excel file that enables the Macro. In this example, the file is named as DSG800\_Demo\_Excel.xlsm.
2. Run DSG800\_Demo\_Excel.xlsm. Click **File** → **Options** at the upper-left corner of the Excel file to open the interface as shown in the figure below. Click **Customize Ribbon** at the left, check **Developer** and click **OK**. At this point, the Excel menu bar displays the **Developer** menu.

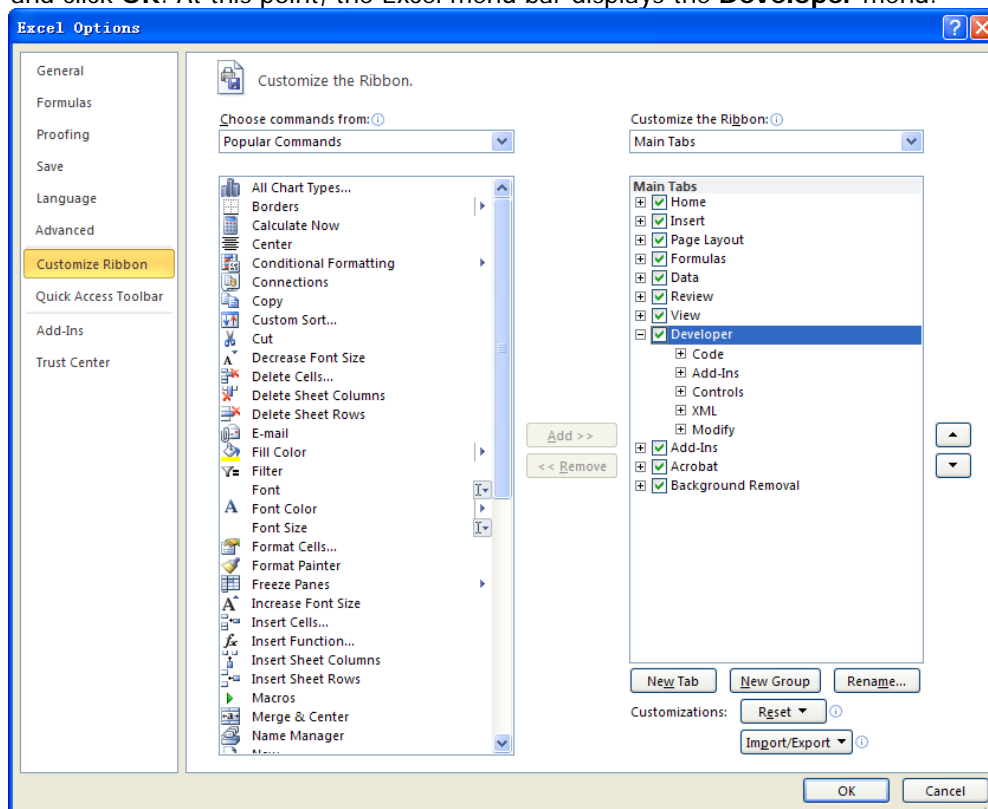

3. Input the VISA descriptor into a cell of the file as shown in the figure below. Click the **Developer** menu and select the **Visual Basic** option to open the Microsoft Visual Basic.

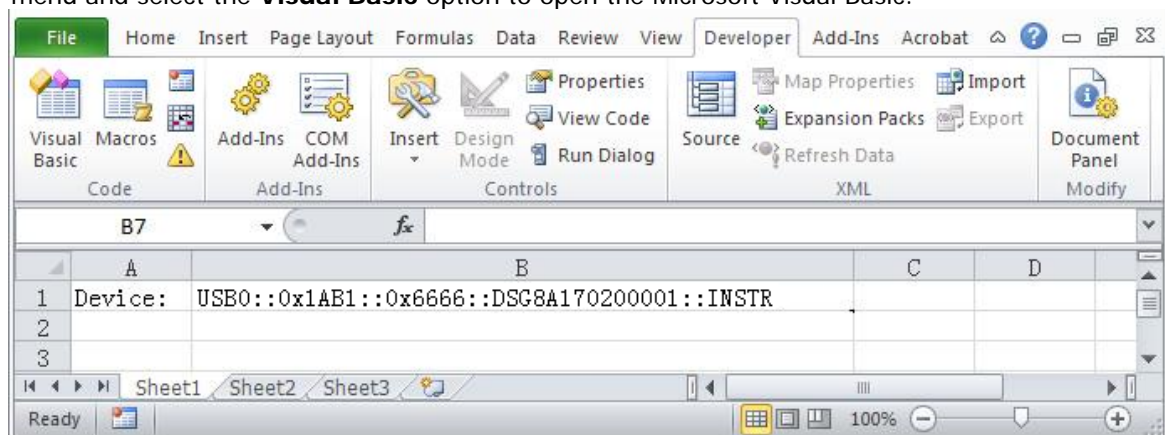

- 4. Select **Tools** in the Microsoft Visual Basic menu bar and click **References**.

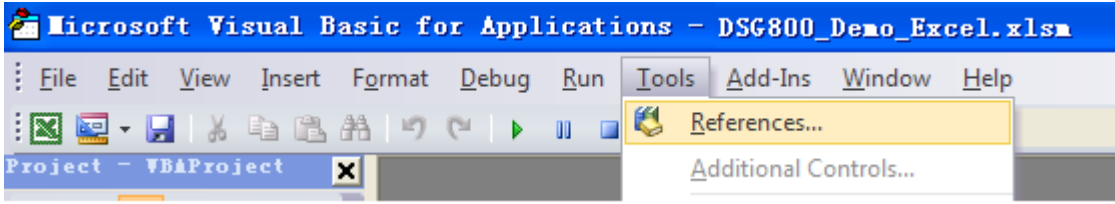

Select **VISA Library** in the pop-up dialog box and click **OK** to refer to the VISA Library.

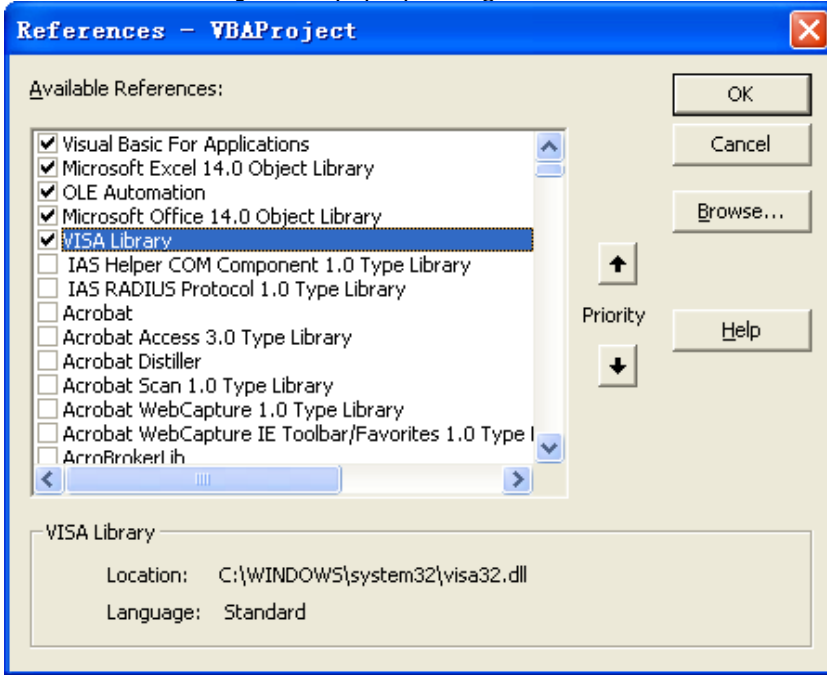

**Explanation:**

If you cannot find the VISA Library in the left list in the figure above, please try to find it using the following method.

- (1) Make sure that you have installed the NI-VISA library on your PC.
- (2) Click **Browse...** at the right and set the search range to **C:\WINDOWS\system32** and the filename to **visa32.dll**, as shown in the figure below.

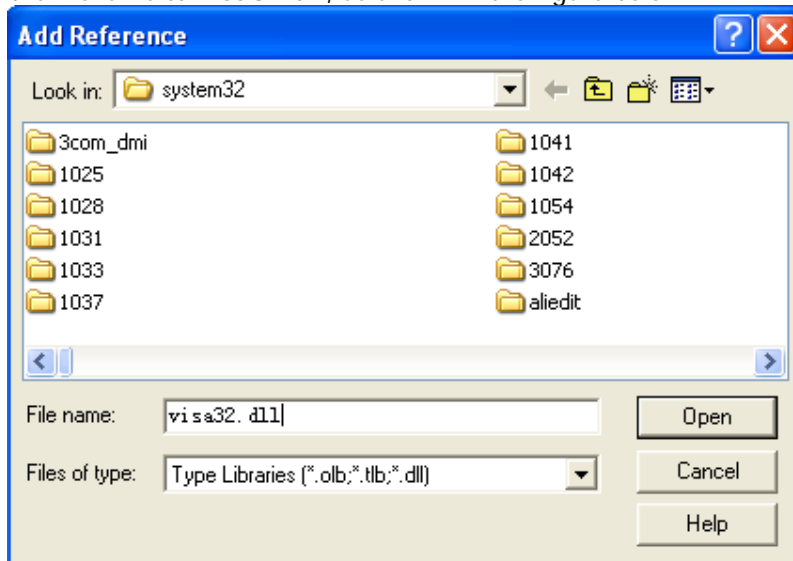

- Click **View Code** in the **Developer** menu to enter the Microsoft Visual Basic interface. Add the following codes and save the file.

**Note:** If the Excel file created at step 2 does not enable the Macros, at this point, the prompt message "The following features cannot be saved in macro-free workbooks" will be displayed. In this situation, please save the Excel file as a file using the Macros.

Sub QueryIdn()

```
Dim viDefRm As Long
Dim viDevice As Long
Dim viErr As Long
Dim cmdStr As String
Dim idnStr As String * 128
Dim ret As Long
```

'Turn on the device. The device resource descriptor is in CELLS(1,2) of SHEET1'

```
viErr = visa.viOpenDefaultRM(viDefRm)
viErr = visa.viOpen(viDefRm, Sheet1.Cells(1, 2), 0, 5000, viDevice)
```

'Send request to read data. The return value is in CELLS(2,2) of SHEET1'

```
cmdStr = "*IDN?"
viErr = visa.viWrite(viDevice, cmdStr, Len(cmdStr), ret)
viErr = visa.viRead(viDevice, idnStr, 128, ret)
Sheet1.Cells(2, 2) = idnStr
```

'Turn off the device'

```
visa.viClose (viDevice)
visa.viClose (viDefRm)
```

End Sub

- Add button control: click **Insert** in the **Developer** menu, select the desired button in **Form Controls** and put it into the cell of the Excel. At this point, the **Assign Macro** interface is displayed, select "Sheet1.QueryIdn" and click **OK**.

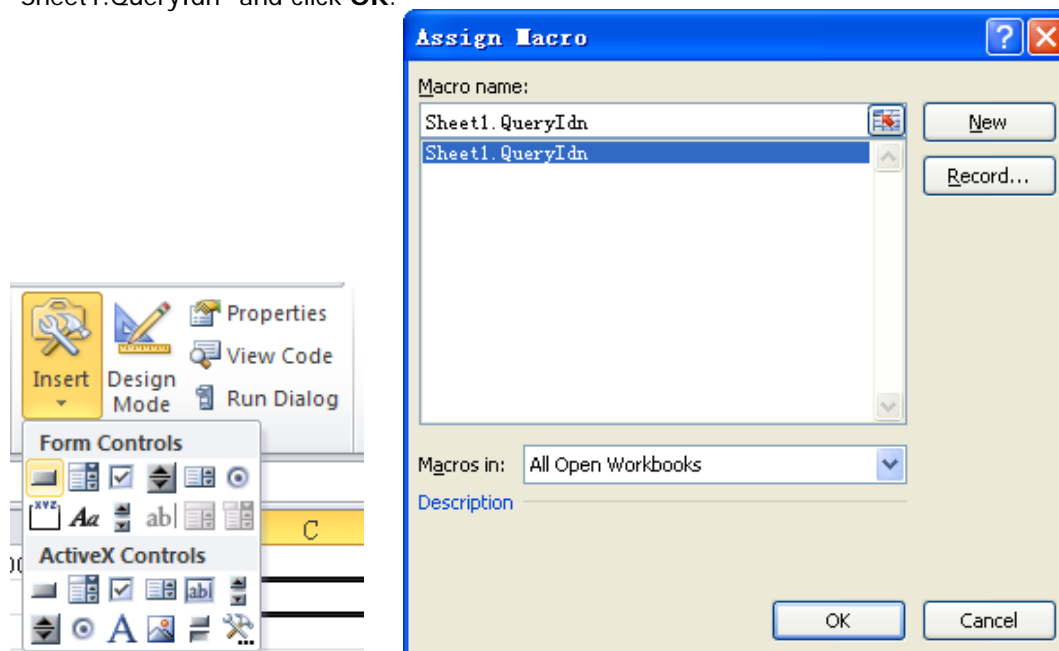

By default, the button name is "Button 1". Right-click the button and select **Edit Text** in the pop-up

menu to change the button name to "\*IDN?".

7. Click the "\*IDN?" button to run the program. The device information of the RF signal generator is as shown in the figure below.

A	B	C
Device:	USB0::0x1AB1::0x6666::DSG8A170200001::INSTR	*IDN?
	Rigol Technologies, DSG830, DSG8A170200001, 00.01.01	

## Matlab Programming Demo

**The program used in this demo:** MATLAB R2009a

**The functions realized in this demo:** read the current frequency and amplitude of the RF signal generator.

1. Run Matlab and modify the current directory (namely modify the **Current Directory** at the top of the software). In this example, the current directory is changed to D:\DSG800\_Demo.

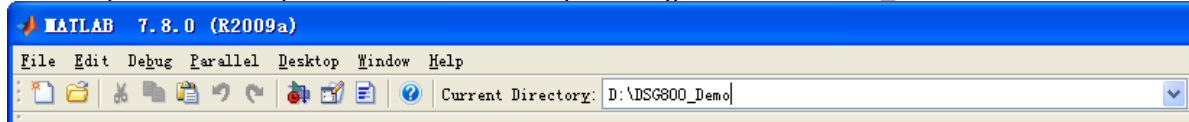

2. Click **File** → **New** → **Blank M-File** in the Matlab interface to create a blank M file.
3. Add the following codes in the M file.

```
dsg800 = visa('ni','USB0::0x1AB1::0x6666::DSG8A170200001::INSTR'); %Create Visa object

fopen(dsg800); %Open the visa object created

fprintf(dsg800, ':FREQ? '); %Send request to query the frequency

meas_RF_FREQ = fscanf(dsg800); %Read the frequency data

fprintf(dsg800, ':LEV? '); %Send request to query the amplitude

meas_RF_LEV = fscanf(dsg800); %Read the amplitude data

fclose(dsg800); %Close the visa object

display(meas_RF_FREQ); %Display the frequency read

display(meas_RF_LEV) %Display the amplitude read
```

4. Save the M file in the current directory. In this example, the M file is named as DSG800\_Demo\_MATLAB.m.
5. Run the M file and the command window displays the following results.

```
meas_RF_FREQ =
1.500 000 000 00GHz

meas_RF_LEV =
-20.00
```

The results above denote that the current frequency of the RF signal generator is 1.5GHz and the amplitude is -20dBm.

# LabVIEW Programming Demo

The program used in this demo: LabVIEW 2009

The functions realized in this demo: search for the instrument address, connect the instrument, send command and read the return value.

1. Run LabVIEW 2009. Create a new VI file and name it as DSG800\_Demo\_LABVIEW.
2. Add controls in the front panel interface, including the address bar, command bar and return bar as well as the Connect, Write, Read and Exit buttons.

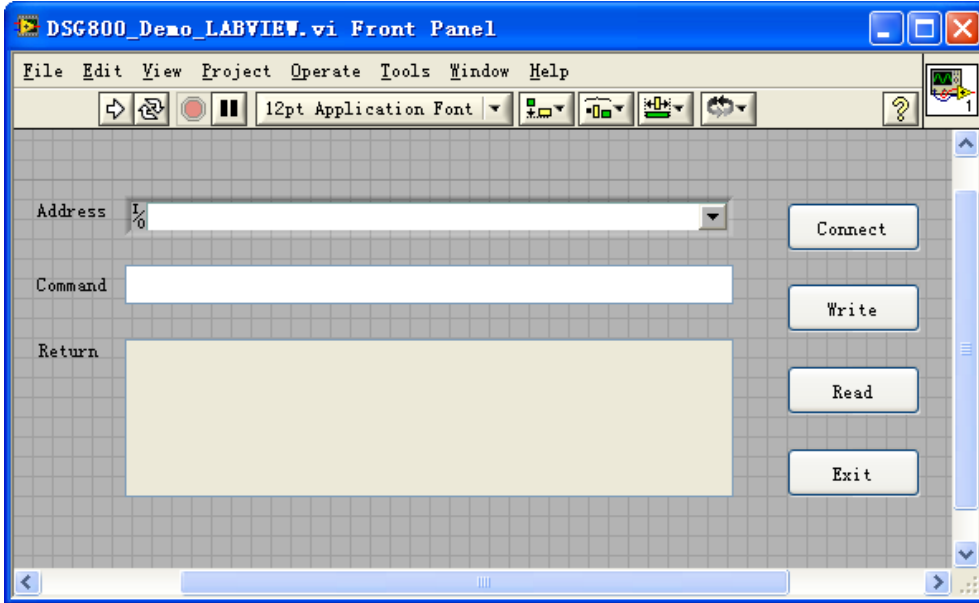

3. Click **Show Block Diagram** in the Window menu and add the While cycle to create the event structure.

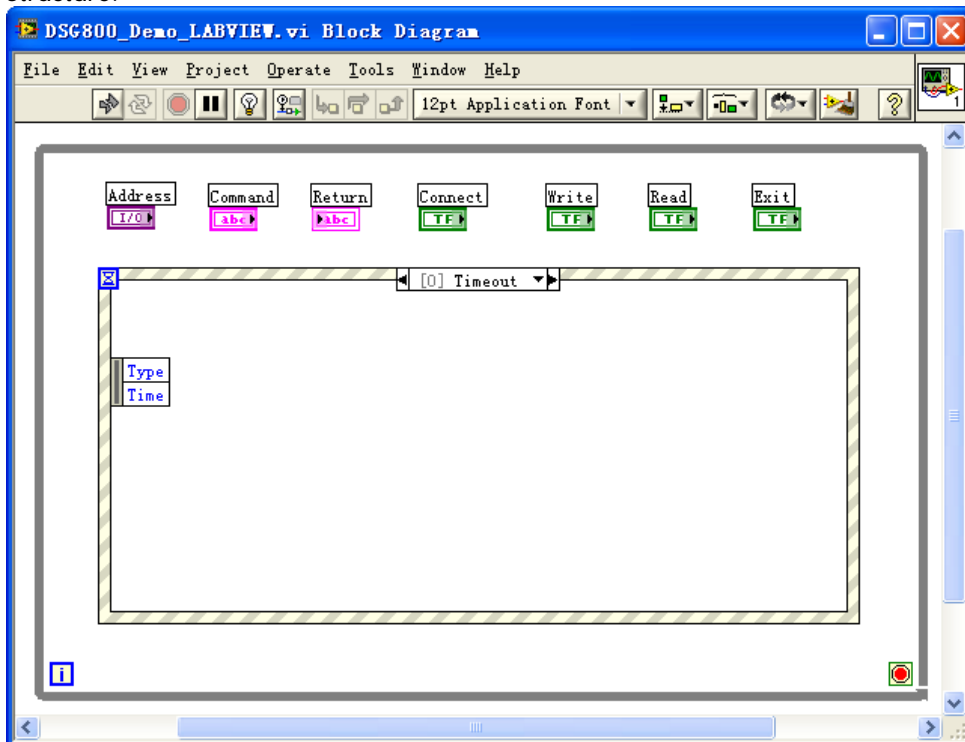

4. Add events, including connect the instrument, write operation, read operation and exit.
  - (1) Connect the instrument (include error processing).

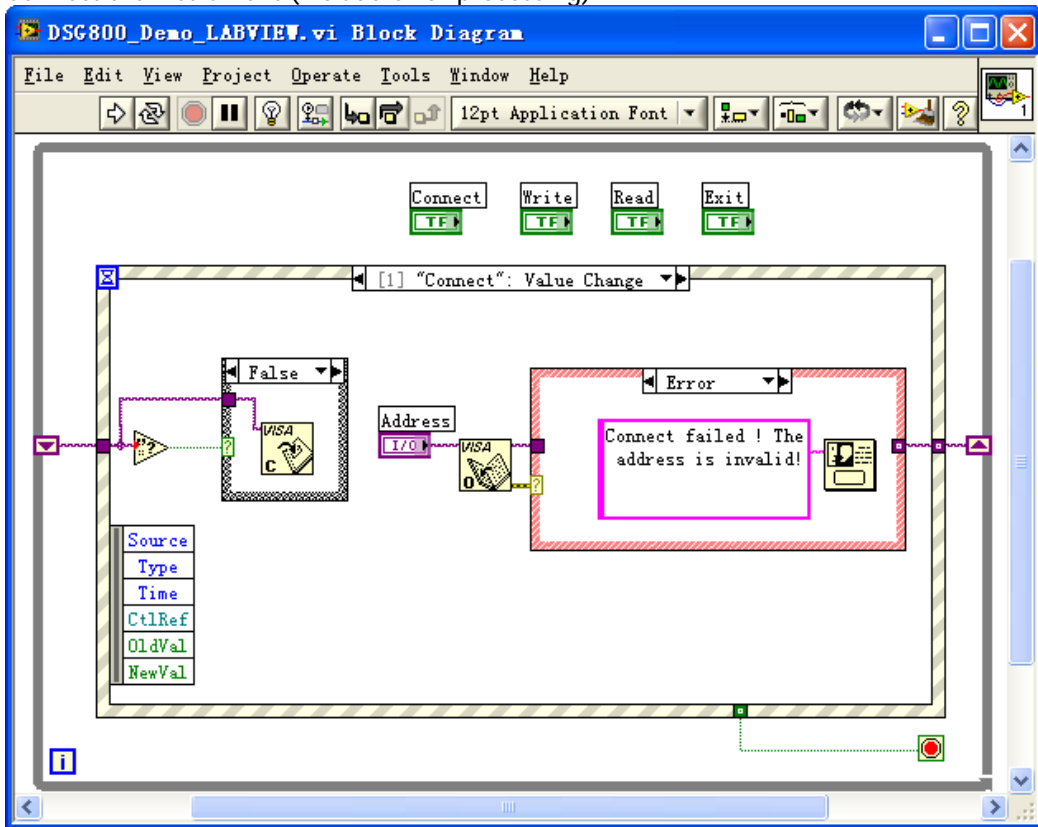

- (2) Write operation (include error judgment).

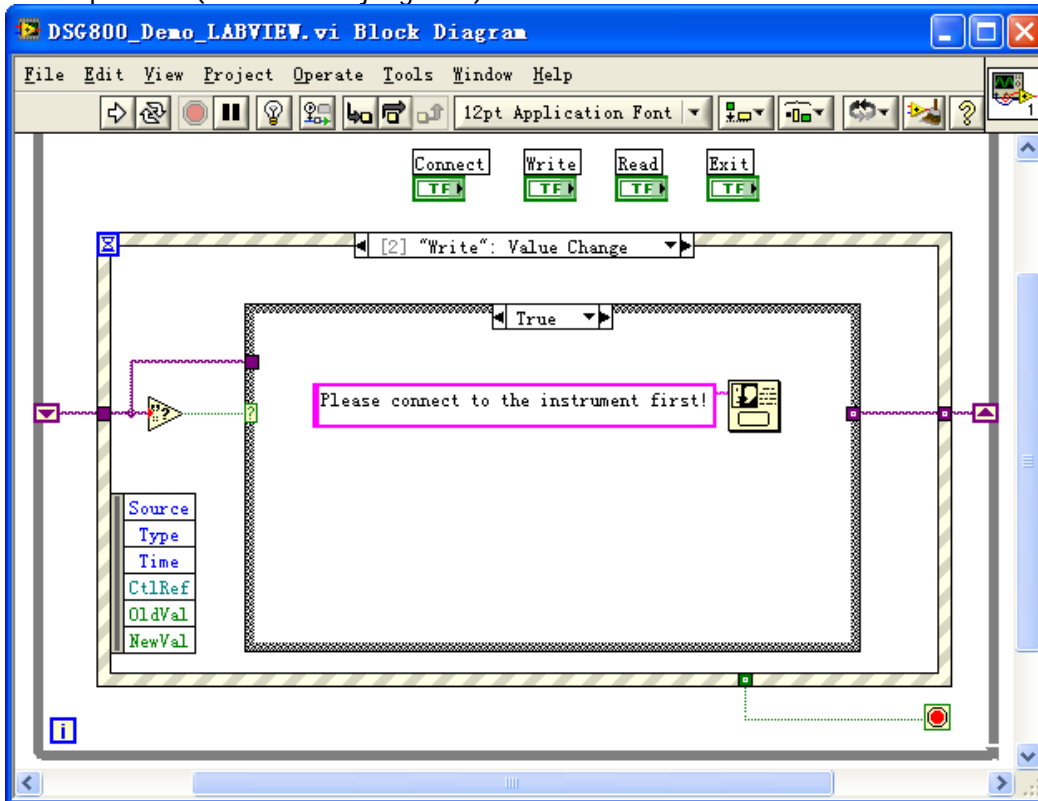

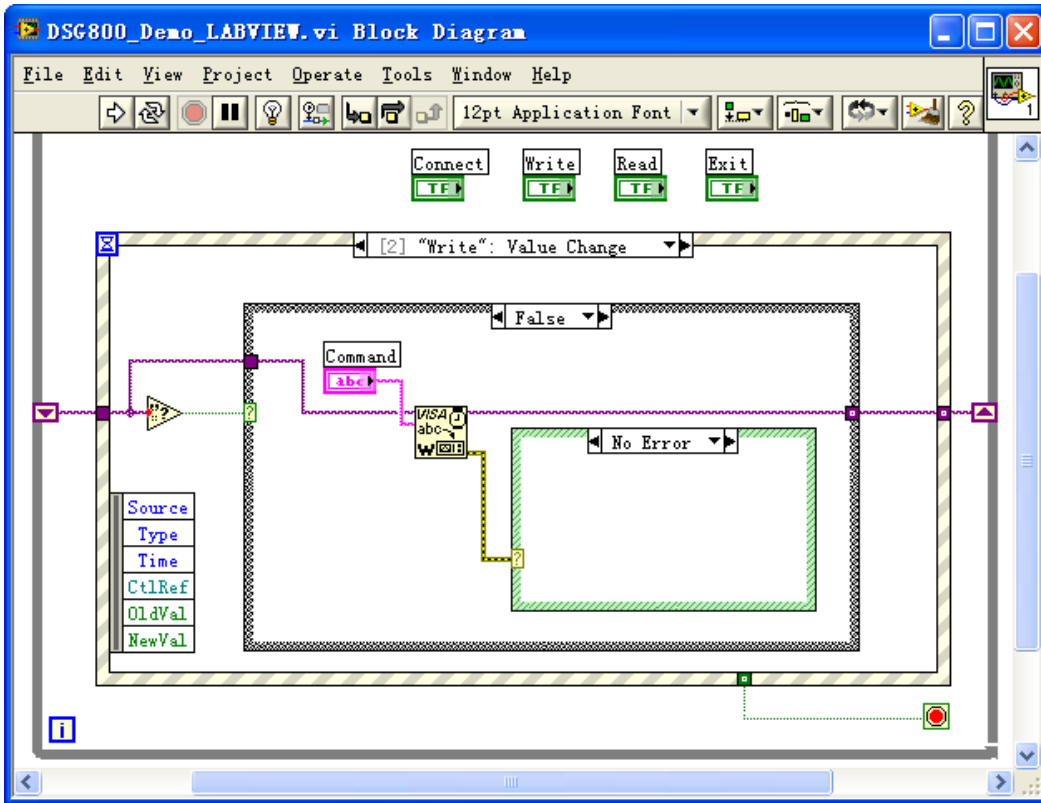

(3) Read operation (include error processing).

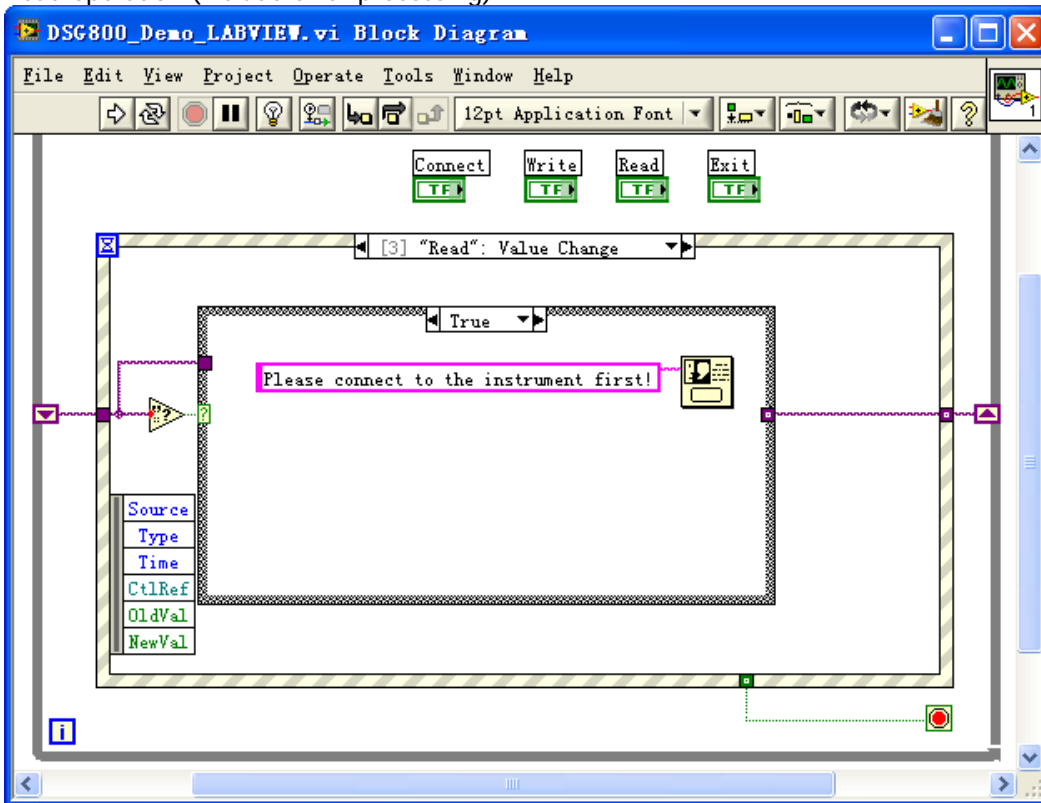



- (4) Exit.

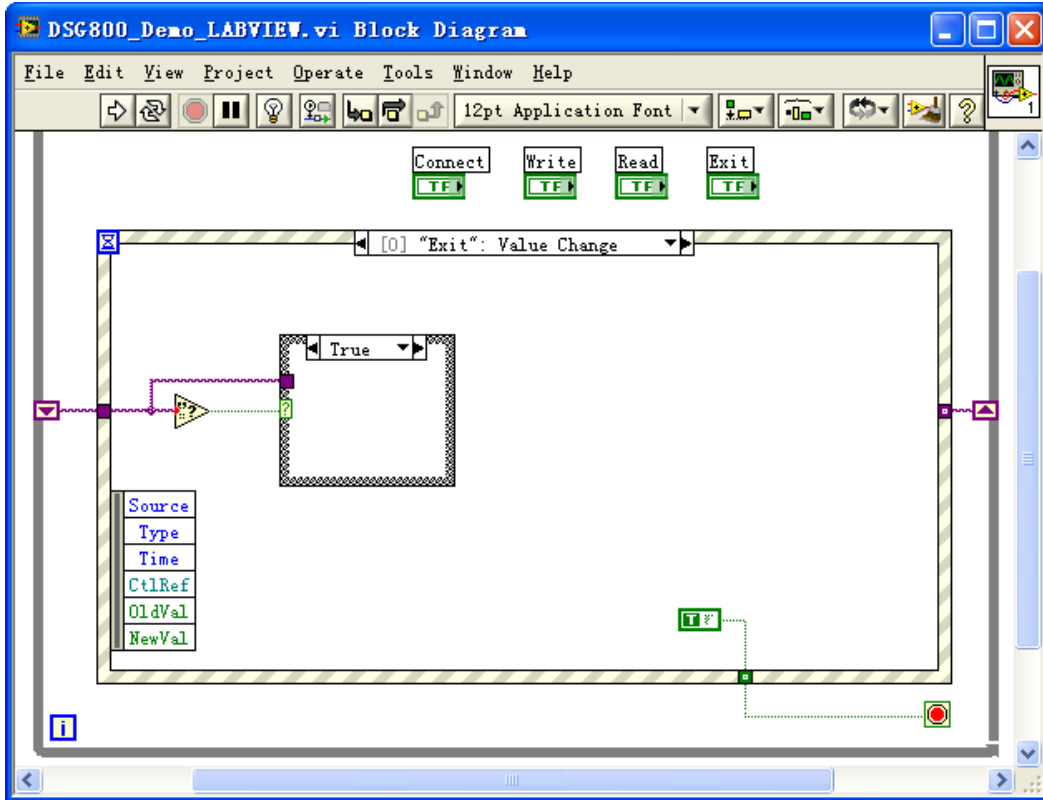

- 5. Run the program and the interface as shown below is displayed. Click the **Address** dropdown box and select the VISA resource name. Click **Connect** to connect the instrument, input the command in the **Command** text box and click **Write** to write the command into the instrument. If the command is a query command (for example, :FREQ?), you need to first click **Write** to write the command into the instrument and then click **Read**. The return value 1.500 000 000 00GHz (denote that the current frequency of the RF signal generator is 1.5GHz) is displayed in the **Return** text box. Click **Exit** to exit the program.

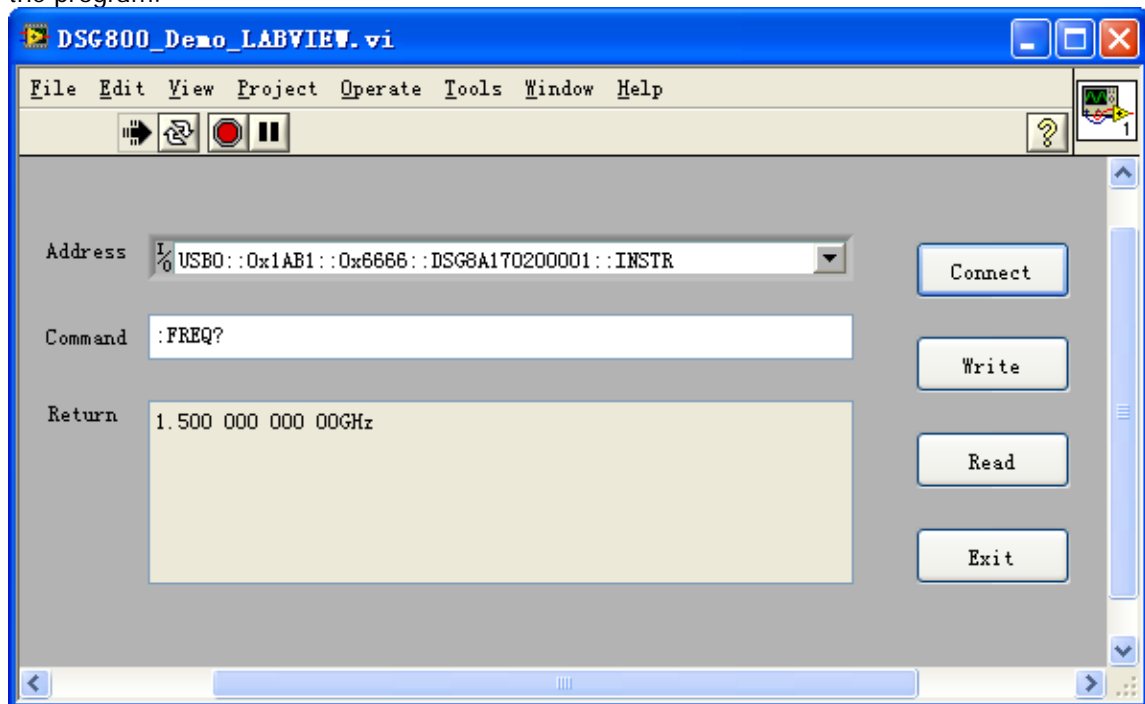

## Visual Basic Programming Demo

The program used in this demo: Visual Basic 6.0

The functions realized in this demo: turn on the LF, MOD and RF output switches respectively and use yellow label to indicate that the output is turned on.

1. Build a standard application program project (Standard EXE) and name it as DSG800\_Demo\_VB.
2. Click the **Existing** tab under **Project** → **Add Module**. Find the visa32.bas file under the **include** folder in the installation directory of NI-VISA and add the file.

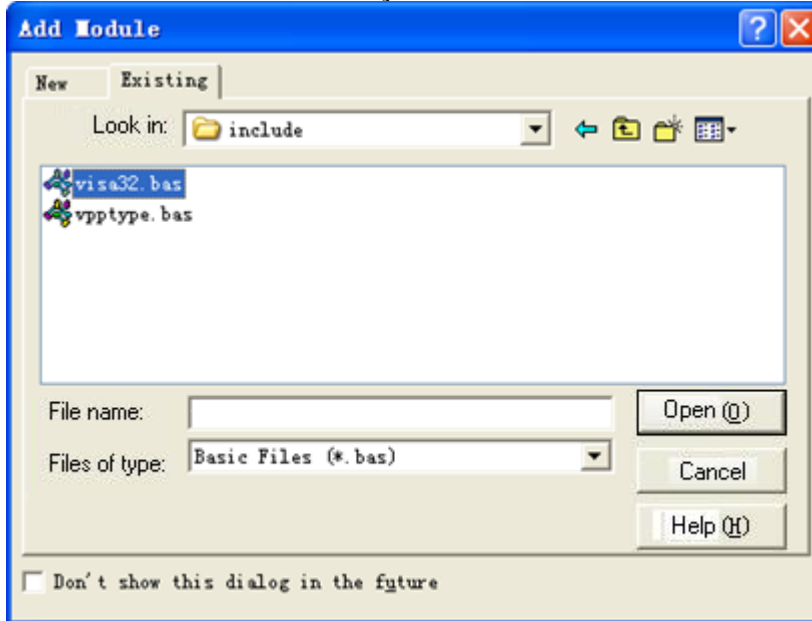

3. Add three CommandButton controls to represent LF, MOD and RF respectively. Add three Label controls (Label1(0), Label1(1) and Label1(2)) to denote the status of the three switches respectively (the controls are gray by default and are yellow when the output switches are turned on). The layout is as shown in the figure below.

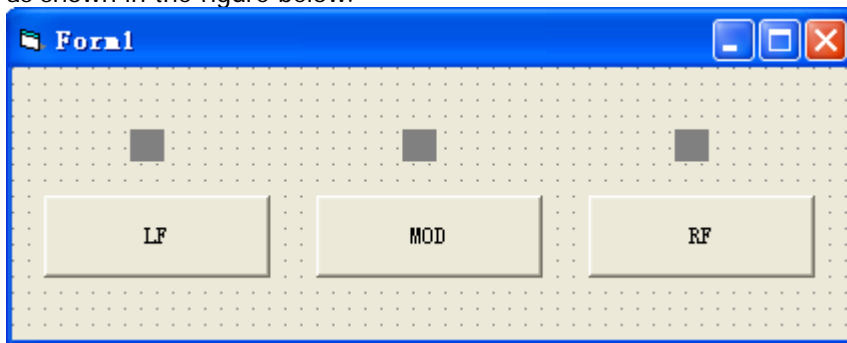

4. Open the **General** tab under **Project** → **Project1 Properties** and select **Form1** from the **Startup Object** dropdown box.
5. Double-click the LF button to enter the programming environment and add the following codes to realize the control of LF, MOD and RF. The codes of LF are as shown below. The codes of MOD and RF are similar.

```
Dim defrm As Long
Dim vi As Long
Dim strRes As String * 20
```

```
Dim list As Long
Dim nmatches As Long
Dim matches As String * 200 'Keep the device number acquired
```

```
'Acquire the usb resource of visa
```

```
Call viOpenDefaultRM(defrm)
```

```
Call viFindRsrc(defrm, "USB?* ", list, nmatches, matches)
```

```
'Turn on the device
```

```
Call viOpen(defrm, matches, 0, 0, vi)
```

```
'Send command to query the status of the LF switch
```

```
Call viVPrintf(vi, ":LFO?" + Chr$(10), 0)
```

```
'Acquire the status of LF
```

```
Call viVScanf(vi, "%t", strRes)
```

```
If strRes = 1 Then
```

```
'Send the setting command
```

```
Call viVPrintf(vi, ":LFO OFF" + Chr$(10), 0)
```

```
Label1(0).ForeColor = &H808080 'Gray
```

```
Else
```

```
Call viVPrintf(vi, ":LFO ON" + Chr$(10), 0)
```

```
Label1(0).ForeColor = &HFFFF& 'Yellow
```

```
End If
```

```
'Turn off the resource
```

```
Call viClose(vi)
```

```
Call viClose(defrm)
```

## 6. Execution Results

- 1) Click "LF" to turn on the LF output. The control above the **LF** button turns yellow (as shown in the figure below). At this point, the RF signal generator can output LF signal via the **[LF OUTPUT]** connector according to the current configuration. Click "LF" again to turn off the LF output and the control above the **LF** button turns gray.



- 2) Click "MOD" to turn on the modulation output and the control above the **MOD** button turns yellow (as shown in the figure below). At this point, the RF signal generator can output the RF modulated signal via the **[RF OUTPUT 50Ω]** connector if the RF output is turned on. Click "MOD" again to turn off the modulation output and the control above the **MOD** button turns gray.

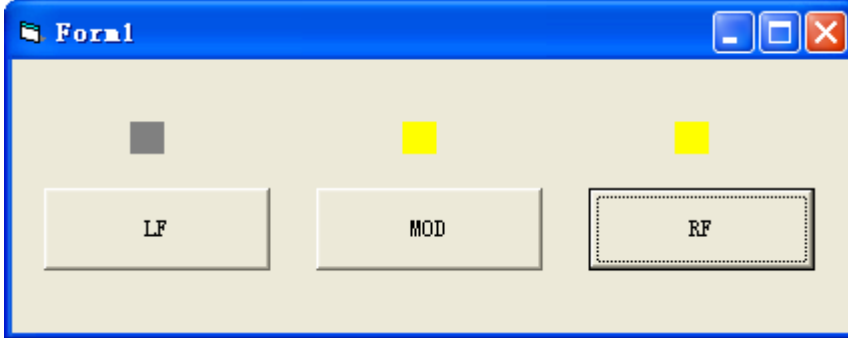

- 3) Click "RF" to turn on the RF output and the control above the **RF** button turns yellow (as shown in the figure below). At this point, the RF signal generator can output RF signal via the **[RF OUTPUT 50Ω]** connector according to the current configuration. Click "RF" again to turn off the RF output and the control above the **RF** button turns gray.

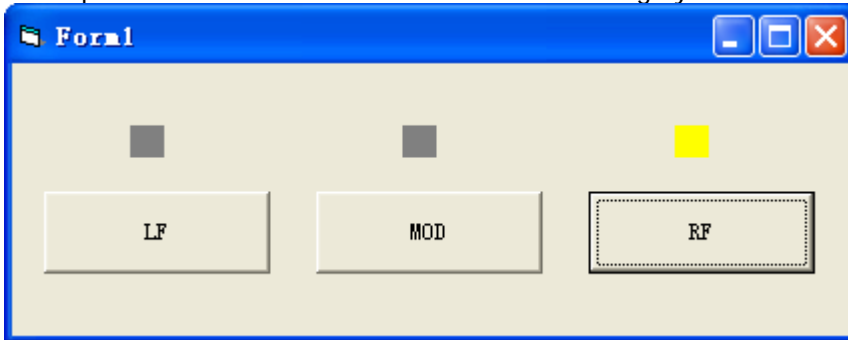

## Visual C++ Programming Demo

**The program used in this demo:** Microsoft Visual C++ 6.0

**The functions realized in this demo:** search for the instrument address, connect the instrument, send command and read the return value.

1. Run Microsoft Visual C++ 6.0. Create a new MFC project based on dialog box and name it as DSG800\_DEMO\_VC.
2. Click **Project** → **Settings** and add **visa32.lib** under the **Link** tab in the pop-up interface manually.

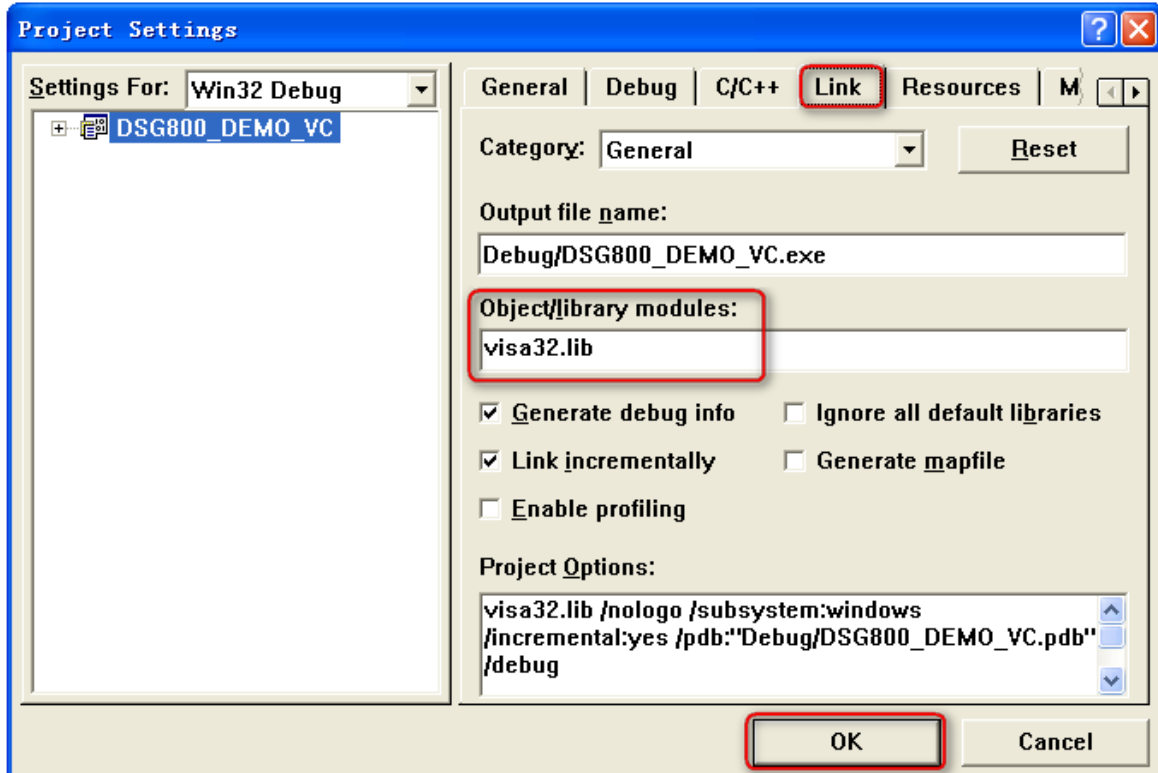

3. Click **Tools** → **Options** and add the **Include** and **Lib** directories under the **Directories** tab in the pop-up interface.

Select **Include files** in **Show directories for** and double-click at the blank in **Directories** to add the path of **Include**: C:\Program Files\IVI Foundation\VISA\WinNT\include.

Select **Library files** in **Show directories for** and double-click at the blank in **Directories** to add the path of **Lib**: C:\Program Files\IVI Foundation\VISA\WinNT\lib\msc.

**Note:**

The two directories are related to the installation directory of NI-VISA on your PC. Here, NI-VISA is installed under C:\Program Files\IVI Foundation\VISA by default.

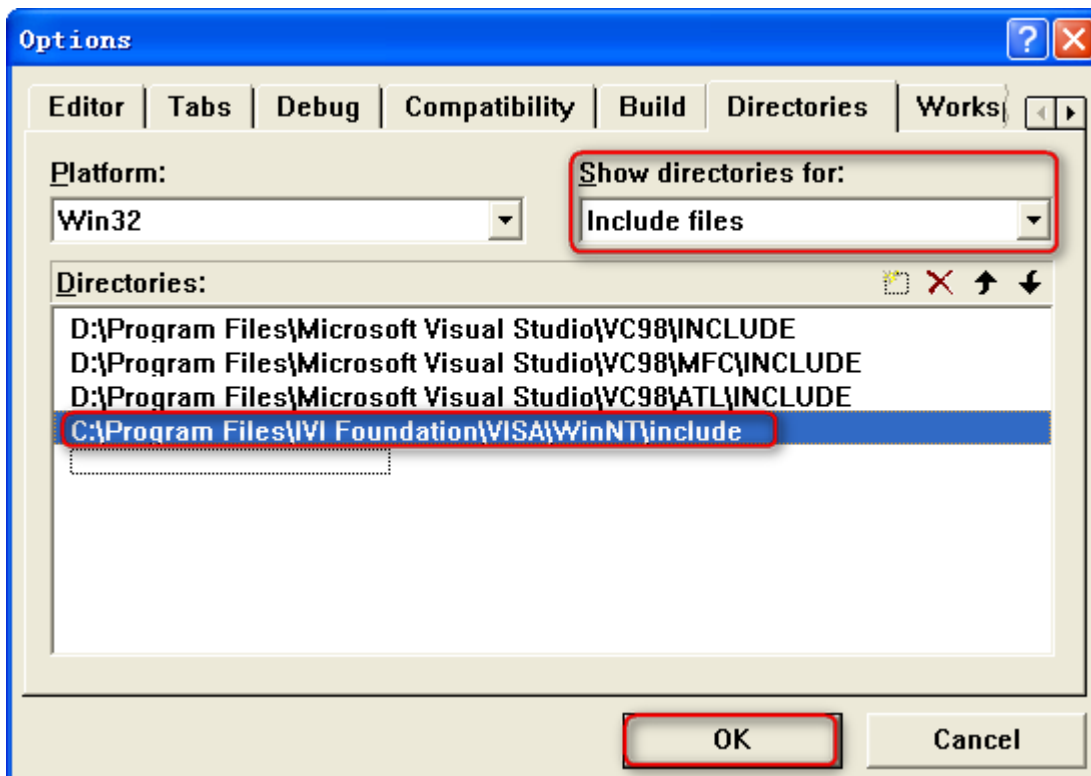

4. Add the **Text**, **Edit** and **Button** controls. The layout is as shown in the figure below.

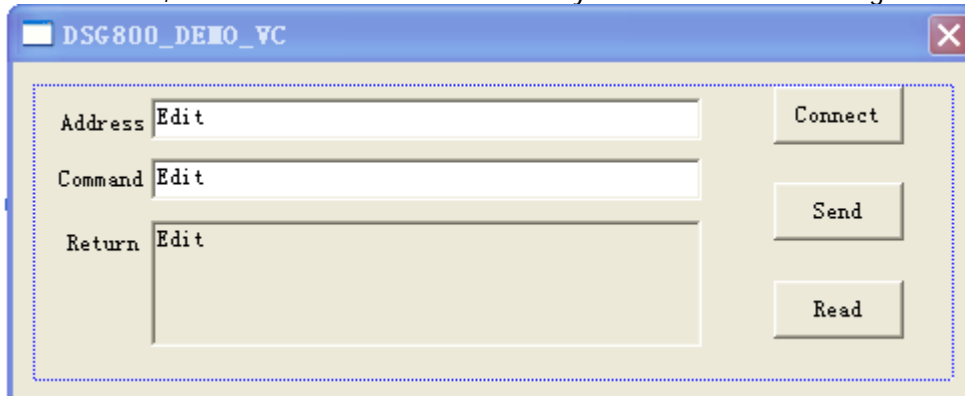

5. Click **View** → **ClassWizard** and add the control variables under the **Member Variables** tab in the pop-up interface.
- Instrument Address: CString m\_strInstrAddr  
 Command: CString m\_strCommand  
 Return Value: CString m\_strResult

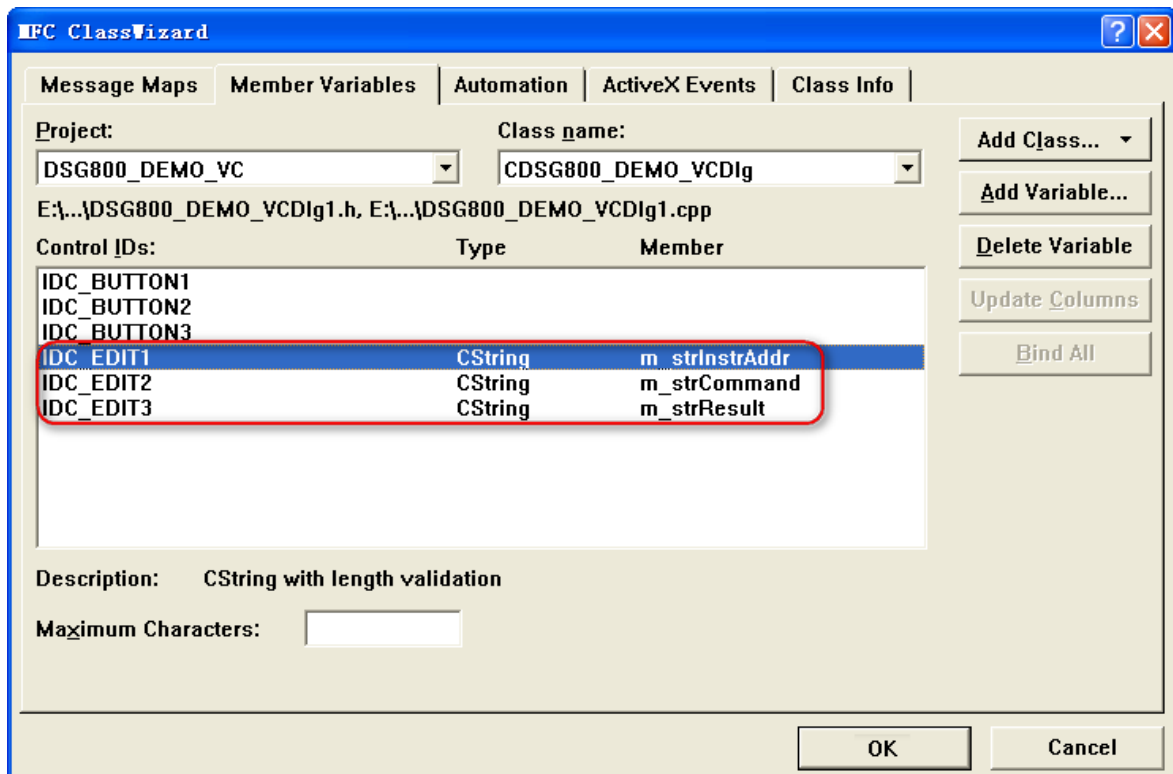

6. Encapsulate the read and write operations of VISA.

1) Encapsulate the write operation of VISA for easier operation.

```
bool CDSG800_DEMO_VCDlg::InstrWrite(CString strAddr, CString strContent) //write function
```

```
{
```

```
    ViSession defaultRM,instr;
```

```
    ViStatus status;
```

```
    ViUInt32 retCount;
```

```
    char * SendBuf = NULL;
```

```
    char * SendAddr = NULL;
```

```
    bool bWriteOK = false;
```

```
    CString str;
```

```
    //Change the address's data style from CString to char*
```

```
    SendAddr = strAddr.GetBuffer(strAddr.GetLength());
```

```
    strcpy(SendAddr,strAddr);
```

```
    strAddr.ReleaseBuffer();
```

```
    //Change the command's data style from CString to char*
```

```
    SendBuf = strContent.GetBuffer(strContent.GetLength());
```

```
    strcpy(SendBuf,strContent);
```

```
    strContent.ReleaseBuffer();
```

```
    //Open the VISA instrument
```

```
    status = viOpenDefaultRM(&defaultRM);
```

```
    if (status < VI_SUCCESS)
```

```
    {
```

```
        AfxMessageBox("No VISA instrument was opened !");
```

```
        return false;
```

```
    }
```

```
    status = viOpen(defaultRM, SendAddr, VI_NULL, VI_NULL, &instr);
```

```
    //Write command to the instrument
```

```
    status = viWrite(instr, (unsigned char *)SendBuf, strlen(SendBuf), &retCount);
```

```

    //Close the instrument
    status = viClose(instr);
    status = viClose(defaultRM);

    return bWriteOK;
}

2) Encapsulate the read operation of VISA for easier operation.
bool CDSG800_DEMO_VCDlg::InstrRead(CString strAddr, CString *pstrResult)
//Read from the instrument
{
    ViSession defaultRM,instr;
    ViStatus status;
    ViUInt32 retCount;
    char * SendAddr = NULL;
    unsigned char RecBuf[MAX_REC_SIZE];
    bool bReadOK = false;
    CString str;

    //Change the address's data style from CString to char*
    SendAddr = strAddr.GetBuffer(strAddr.GetLength());
    strcpy(SendAddr,strAddr);
    strAddr.ReleaseBuffer();

    memset(RecBuf,0,MAX_REC_SIZE);

    //Open the VISA instrument
    status = viOpenDefaultRM(&defaultRM);
    if (status < VI_SUCCESS)
    {
        //Error Initializing VISA...exiting
        AfxMessageBox("No VISA instrument was opened !");
        return false;
    }

    //Open the instrument
    status = viOpen(defaultRM, SendAddr, VI_NULL, VI_NULL, &instr);

    //Read from the instrument
    status = viRead(instr, RecBuf, MAX_REC_SIZE, &retCount);

    //Close the instrument
    status = viClose(instr);
    status = viClose(defaultRM);

    (*pstrResult).Format("%s",RecBuf);

    return bReadOK;
}

```

7. Add the control message response codes.

```

1) Connect the instrument
void CDSG800_DEMO_VCDlg::OnConnect()
{
    //TODO: Add your control notification handler code here
    ViStatus status;
    ViSession defaultRM;
    ViString expr = "?*";

```



```

ViPFindList findList = new unsigned long;
ViPUInt32 retcnt = new unsigned long;
ViChar instrDesc[1000];
CString strSrc = "";
CString strInstr = "";
unsigned long i = 0;
bool bFindDSG = false;

status = viOpenDefaultRM(&defaultRM);
if (status < VI_SUCCESS)
{
    //Error Initializing VISA...exiting
    MessageBox("No VISA instrument was opened ! ");
    return ;
}

memset(instrDesc,0,1000);

//Find resource
status = viFindRsrc(defaultRM,expr,findList, retcnt, instrDesc);

for (i = 0;i < (*retcnt);i++)
{
    //Get instrument name
    strSrc.Format("%s",instrDesc);
    InstrWrite(strSrc,"*IDN?");
    ::Sleep(200);
    InstrRead(strSrc,&strInstr);

    //If the instrument(resource) belongs to the DSG series then jump out from the loop
    strInstr.MakeUpper();
    if (strInstr.Find("DSG") >= 0)
    {
        bFindDSG = true;
        m_strInstrAddr = strSrc;
        break;
    }

    //Find next instrument
    status = viFindNext(*findList,instrDesc);
}

if (bFindDSG == false)
{
    MessageBox("Didn't find any DSG!");
}
UpdateData(false);
}

2) Write operation
void CDSG800_DEMO_VCDlg::OnSend()
{
    //TODO: Add your control notification handler code here
    UpdateData(true);
    if (m_strInstrAddr.IsEmpty())
    {
        MessageBox("Please connect to the instrument first!");
    }
}

```

```
InstrWrite(m_strInstrAddr,m_strCommand);  
m_strResult.Empty();  
UpdateData(false);  
}  
  
3) Read operation  
void CDSG800_DEMO_VCDlg::OnRead()  
{  
    //TODO: Add your control notification handler code here  
    UpdateData(true);  
    InstrRead(m_strInstrAddr,&m_strResult);  
    UpdateData(false);  
}
```

#### 8. Execution Results

- 1) Click "Connect" to find and connect the RF signal generator. If the instrument is successfully connected, the corresponding USB VISA descriptor will be displayed in the address bar.
- 2) Input command in the "Command" edit box; for example, :SWE:DIR?.
- 3) Click "Send" to send the command.
- 4) Click "Read" to read the return value.

The execution results are as shown in the figure below.

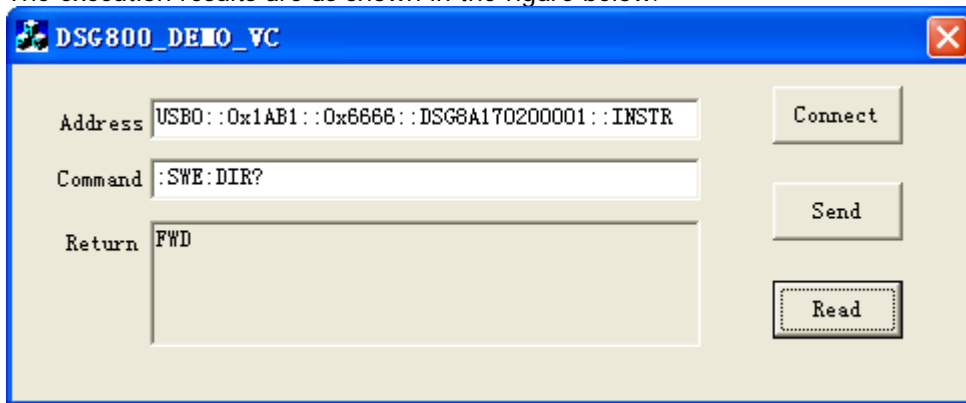

## Chapter 5 Appendix

### Appendix A: Command List

- ◆ [IEEE488.2 Common Commands](#)

- [\\*IDN?](#)

- [\\*TRG](#)

- ◆ [:MMEMory Commands](#)

- [:MMEMory:CATalog](#)

- [:MMEMory:CATalog:LENGth](#)

- [:MMEMory:COPI](#)

- [:MMEMory:DELe](#)

- [:MMEMory:DISK:FORMat](#)

- [:MMEMory:DISK:INFormation](#)

- [:MMEMory:FILEtype](#)

- [:MMEMory:LDISK:SPACe](#)

- [:MMEMory:LOAD](#)

- [:MMEMory:MDIRectory](#)

- [:MMEMory:MOVE](#)

- [:MMEMory:PNAME:EDIT](#)

- [:MMEMory:PNAME:STATe](#)

- [:MMEMory:SAVe](#)

- ◆ [:OUTPut Command](#)

- [:OUTPut\[:STATe\]](#)

- ◆ [:SOURce Commands](#)

- [\[:SOURce\]:AM Command Subsystem](#)

- [\[:SOURce\]:AM\[:DEPT](#)

- [\[:SOURce\]:AM\[:DEPT\]:STEP\[:INCRement\]](#)

- [\[:SOURce\]:AM:EXT:COUP](#)

- [\[:SOURce\]:AM:EXT:IMP](#)

- [\[:SOURce\]:AM:FREQuency](#)

- [\[:SOURce\]:AM:FREQuency:STEP\[:INCRement\]](#)

- [\[:SOURce\]:AM:SOURce](#)

- [\[:SOURce\]:AM:STATe](#)

- [\[:SOURce\]:AM:WAVEform](#)

- [\[:SOURce\]:CORRection Command Subsystem](#)

- [\[:SOURce\]:CORRection:FLATness:COUNT](#)

- [\[:SOURce\]:CORRection:FLATness:LIST](#)

- [\[:SOURce\]:CORRection:FLATness\[:STATe\]](#)

[\[:SOURce\]:FM Command Subsystem](#)

- [\[:SOURce\]:FM\[:DEViation\]](#)
- [\[:SOURce\]:FM\[:DEViation\]:STEP\[:INCRement\]](#)
- [\[:SOURce\]:FM:EXT:COUP](#)
- [\[:SOURce\]:FM:EXT:IMP](#)
- [\[:SOURce\]:FM:FREQuency](#)
- [\[:SOURce\]:FM:FREQuency:STEP\[:INCRement\]](#)
- [\[:SOURce\]:FM:SOURce](#)
- [\[:SOURce\]:FM:STATe](#)
- [\[:SOURce\]:FM:WAVEform](#)

[\[:SOURce\]:FM:PM:TYPE](#)

[\[:SOURce\]:FREQuency Command Subsystem](#)

- [\[:SOURce\]:FREQuency](#)
- [\[:SOURce\]:FREQuency:STEP](#)

[\[:SOURce\]:INPut:TRIGger:SLOPe](#)

[\[:SOURce\]:LEVel Command Subsystem](#)

- [\[:SOURce\]:LEVel](#)
- [\[:SOURce\]:LEVel:STEP](#)

[\[:SOURce\]:LFOutput Command Subsystem](#)

- [\[:SOURce\]:LFOutput:FREQuency](#)
- [\[:SOURce\]:LFOutput:LEVel](#)
- [\[:SOURce\]:LFOutput:SHAPE](#)
- [\[:SOURce\]:LFOutput\[:STATe\]](#)

[\[:SOURce\]:MODulation:STATe](#)

[\[:SOURce\]:PM Command Subsystem](#)

- [\[:SOURce\]:PM\[:DEViation\]](#)
- [\[:SOURce\]:PM\[:DEViation\]:STEP\[:INCRement\]](#)
- [\[:SOURce\]:PM:EXT:COUP](#)
- [\[:SOURce\]:PM:EXT:IMP](#)
- [\[:SOURce\]:PM:FREQuency](#)
- [\[:SOURce\]:PM:FREQuency:STEP\[:INCRement\]](#)
- [\[:SOURce\]:PM:SOURce](#)
- [\[:SOURce\]:PM:STATe](#)
- [\[:SOURce\]:PM:WAVEform](#)

[\[:SOURce\]:PULM Command Subsystem](#)

- [\[:SOURce\]:PULM:MODE](#)
- [\[:SOURce\]:PULM:OUT:STATe](#)
- [\[:SOURce\]:PULM:PERiod](#)
- [\[:SOURce\]:PULM:PERiod:STEP](#)

[\[:SOURce\]:PULM:POLarity](#)  
[\[:SOURce\]:PULM:SOURce](#)  
[\[:SOURce\]:PULM:STATe](#)  
[\[:SOURce\]:PULM:TRAI:n:LIST:COUNT](#)  
[\[:SOURce\]:PULM:TRAI:n:LIST:GET](#)  
[\[:SOURce\]:PULM:TRIGger:DELay](#)  
[\[:SOURce\]:PULM:TRIGger:DELay:STEP](#)  
[\[:SOURce\]:PULM:TRIGger:EXTErnal:GATE:POLarity](#)  
[\[:SOURce\]:PULM:TRIGger:EXTErnal:SLOPe](#)  
[\[:SOURce\]:PULM:TRIGger:MODE](#)  
[\[:SOURce\]:PULM:WIDTH](#)  
[\[:SOURce\]:PULM:WIDTH:STEP](#)  
[\[:SOURce\]:SWEep Command Subsystem](#)  
[\[:SOURce\]:SWEep:DIRection](#)  
[\[:SOURce\]:SWEep:EXECute](#)  
[\[:SOURce\]:SWEep:LIST:CPOint](#)  
[\[:SOURce\]:SWEep:LIST:INITialize:FSTep](#)  
[\[:SOURce\]:SWEep:LIST:INITialize:PRESet](#)  
[\[:SOURce\]:SWEep:LIST:LIST](#)  
[\[:SOURce\]:SWEep:MODE](#)  
[\[:SOURce\]:SWEep:POINt:TRIGger:TYPE](#)  
[\[:SOURce\]:SWEep:RESet\[:ALL\]](#)  
[\[:SOURce\]:SWEep:STATe](#)  
[\[:SOURce\]:SWEep:STEP:DWELl](#)  
[\[:SOURce\]:SWEep:STEP:DWELl:STEP](#)  
[\[:SOURce\]:SWEep:STEP:POINts](#)  
[\[:SOURce\]:SWEep:STEP:POINts:STEP](#)  
[\[:SOURce\]:SWEep:STEP:SHAPE](#)  
[\[:SOURce\]:SWEep:STEP:SPACing](#)  
[\[:SOURce\]:SWEep:STEP:STARt:FREQuency](#)  
[\[:SOURce\]:SWEep:STEP:STARt:FREQuency:STEP](#)  
[\[:SOURce\]:SWEep:STEP:STARt:LEVel](#)  
[\[:SOURce\]:SWEep:STEP:STARt:LEVel:STEP](#)  
[\[:SOURce\]:SWEep:STEP:STOP:FREQuency](#)  
[\[:SOURce\]:SWEep:STEP:STOP:FREQuency:STEP](#)  
[\[:SOURce\]:SWEep:STEP:STOP:LEVel](#)  
[\[:SOURce\]:SWEep:STEP:STOP:LEVel:STEP](#)  
[\[:SOURce\]:SWEep:SWEep:TRIGger:TYPE](#)  
[\[:SOURce\]:SWEep:TYPE](#)

◆ [:STATus Commands](#)

[:STATus:OPERation:CONDition](#)  
[:STATus:OPERation:ENABLE](#)  
[:STATus:OPERation\[:EVENT\]](#)  
[:STATus:QUEStionable:CALibration:CONDition](#)  
[:STATus:QUEStionable:CALibration:ENABLE](#)  
[:STATus:QUEStionable:CALibration\[:EVENT\]](#)  
[:STATus:QUEStionable:CONDition](#)  
[:STATus:QUEStionable:CONNect:CONDition](#)  
[:STATus:QUEStionable:CONNect:ENABLE](#)  
[:STATus:QUEStionable:CONNect\[:EVENT\]](#)  
[:STATus:QUEStionable:ENABLE](#)  
[:STATus:QUEStionable\[:EVENT\]](#)  
[:STATus:QUEStionable:FREQuency:CONDition](#)  
[:STATus:QUEStionable:FREQuency:ENABLE](#)  
[:STATus:QUEStionable:FREQuency\[:EVENT\]](#)  
[:STATus:QUEStionable:MODulation:CONDition](#)  
[:STATus:QUEStionable:MODulation:ENABLE](#)  
[:STATus:QUEStionable:MODulation\[:EVENT\]](#)  
[:STATus:QUEStionable:POWER:CONDition](#)  
[:STATus:QUEStionable:POWER:ENABLE](#)  
[:STATus:QUEStionable:POWER\[:EVENT\]](#)  
[:STATus:QUEStionable:SELftest:CONDition](#)  
[:STATus:QUEStionable:SELftest:ENABLE](#)  
[:STATus:QUEStionable:SELftest\[:EVENT\]](#)  
[:STATus:QUEStionable:TEMP:CONDition](#)  
[:STATus:QUEStionable:TEMP:ENABLE](#)  
[:STATus:QUEStionable:TEMP\[:EVENT\]](#)

◆ [:SYSTem Commands](#)

[:SYSTem:BRIGHtness](#)  
[:SYSTem:CLEAr](#)  
[:SYSTem:COMMunication:INTerface](#)  
[:SYSTem:COMMunication:LAN:DHCP](#)  
[:SYSTem:COMMunication:LAN:IP:ADDRESS](#)  
[:SYSTem:COMMunication:LAN:IP:AUTO](#)  
[:SYSTem:COMMunication:LAN:IP:GATeway](#)  
[:SYSTem:COMMunication:LAN:IP:MANual](#)  
[:SYSTem:COMMunication:LAN:IP:SET](#)  
[:SYSTem:COMMunication:LAN:IP:SUBnet:MASK](#)

[:SYSTem:COMMunication:LAN:RESet](#)  
[:SYSTem:COMMunication:LAN\[:SELF\]:PREFferred](#)  
[:SYSTem:DATE](#)  
[:SYSTem:DISPlay:UPDate\[:STATe\]](#)  
[:SYSTem:FSWitch:STATe](#)  
[:SYSTem:LANGuage](#)  
[:SYSTem:LKEY](#)  
[:SYSTem:POWer:ON:TYPE](#)  
[:SYSTem:PRESet](#)  
[:SYSTem:PRESet:TYPE](#)  
[:SYSTem:PRESet:SAVE](#)  
[:SYSTem:TIME](#)

◆ [:TRIGger Commands](#)

[:TRIGger:PULSe\[:IMMediate\]](#)  
[:TRIGger\[:SWEep\]\[:IMMediate\]](#)

◆ [:UNIT Command](#)

[:UNIT:POWer](#)

## Appendix B: Factory Setting

Parameter	Factory Value
<b>FREQ</b>	
Frequency	DSG830: 3GHz
	DSG815: 1.5GHz
<b>LF</b>	
Switch	Off
Output Waveform	Sine
Output Level	500mV
Output Frequency	1kHz
Square Output Level	500mV
Square Output Frequency	1kHz
<b>LEVEL</b>	
Level	-110dBm
Flatness Switch	Off
Amplitude Unit	dBm
<b>SWEEP</b>	
Sweep Manner	Off
Sweep Type	Step
Sweep Mode	Cont
Start Frequency of Step Sweep	100MHz
Stop Frequency of Step Sweep	1GHz
Start Level of Step Sweep	-10dBm
Stop Level of Step Sweep	-20dBm
Number of Sweep Points	91
Dwell Time	100ms
Sweep Space	Lin
Sweep Shape	Ramp
Trigger Mode of the Sweep Period	Auto
Trigger Mode of Each Sweep Point	Auto
External Trigger Polarity	Pos
Sweep Direction	Fwd
<b>AM</b>	
Switch	Off
Modulation Source	Int
Modulation Depth	50%
Modulation Frequency	10kHz
Modulation Waveform	Sine
External Coupling	AC
Input Impedance	100kohm
<b>FM/ØM</b>	
Modulation Type	ØM
<b>FM</b>	
Switch	Off
Modulation Source	Int
Frequency Deviation	10kHz
Modulation Rate	10kHz
Modulation Waveform	Sine



External Coupling	AC
Input Impedance	100kohm
<b>ØM</b>	
Switch	Off
Modulation Source	Int
Phase Deviation	5rad
Modulation Rate	10kHz
Modulation Waveform	Sine
External Coupling	AC
Input Impedance	100kohm
<b>Pulse Mod</b>	
Switch	Off
Modulation Source	Int
Pulse Mode	Single
Period	1ms
Pulse Width	500us
Trigger Mode	Auto
Pulse Output	Off
Trigger Delay	100us
Modulation Polarity	Normal
External Gated Polarity	Normal
External Trigger Polarity	Pos
<b>Output Control</b>	
RF/on Switch	Off
Mod/on Switch	Off
<b>System<sup>[1]</sup></b>	
Language	English
Power On Setting	Preset
Preset Type	Factory
Remote Interface	Off
DHCP	On
Auto-IP	On
Manual-IP	Off
Screen State	On
Brightness	4
Time/Date	Off
Power Status	Open
<b>Save<sup>[1]</sup></b>	
File Type	All
IME	Number
Prefix Switch	Off

**Note<sup>[1]</sup>:** Not affected by the preset setting.

## Appendix C: Warranty

**RIGOL** warrants that its products mainframe and accessories will be free from defects in materials and workmanship within the warranty period.

If a product is proven to be defective within the respective period, **RIGOL** guarantees the free replacement or repair of products which are approved defective. To get repair service, please contact with your nearest **RIGOL** sales or service office.

**RIGOL** does not provide other warranty items except the one being provided by this warranty statement. The warranty items include but not being subjected to the hint guarantee items related to tradable characteristic and any particular purpose. **RIGOL** will not take any responsibility in cases regarding to indirect, particular and ensuing damage.