

# **RIGOL**

## **Quick Guide**

### **MSO2000A/DS2000A Series Digital Oscilloscope**

**May 2019**

**RIGOL(SUZHOU) TECHNOLOGIES INC.**



# Guaranty and Declaration

## Copyright

© 2013 **RIGOL** (SUZHOU) TECHNOLOGIES INC. All Rights Reserved.

## Trademark Information

**RIGOL** is a registered trademark of **RIGOL** (SUZHOU) TECHNOLOGIES INC.

## Publication Number

QGA18104-1110

## Notices

- **RIGOL** products are covered by P.R.C. and foreign patents, issued and pending.
- **RIGOL** reserves the right to modify or change parts of or all the specifications and pricing policies at the company's sole decision.
- Information in this publication replaces all previously released materials.
- Information in this publication is subject to change without notice.
- **RIGOL** shall not be liable for either incidental or consequential losses in connection with the furnishing, use, or performance of this manual, as well as any information contained.
- Any part of this document is forbidden to be copied, photocopied, or rearranged without prior written approval of **RIGOL**.

## Product Certification

**RIGOL** guarantees that this product conforms to the national and industrial standards in China as well as the ISO9001:2015 standard and the ISO14001:2015 standard. Other international standard conformance certifications are in progress.

## Contact Us

If you have any problem or requirement when using our products or this manual, please contact **RIGOL**.

E-mail: [service@rigol.com](mailto:service@rigol.com)

Website: [www.rigol.com](http://www.rigol.com)

# Safety Requirement

## General Safety Summary

1. Only the exclusive power cord designed for the instrument and authorized for use within the local country could be used.
2. Ensure that the instrument is safely grounded.
3. Connect the probe correctly.
4. Observe all terminal ratings.
5. Use proper overvoltage protection.
6. Do not operate without covers.
7. Do not insert objects into the air outlet.
8. Use the proper fuse.
9. Avoid circuit or wire exposure.
10. Do not operate the instrument with suspected failures.
11. Provide adequate ventilation.
12. Do not operate in wet conditions.
13. Do not operate in an explosive atmosphere.
14. Keep instrument surfaces clean and dry.
15. Prevent electrostatic impact.
16. Handle with caution.

## Safety Notices and Symbols

### Safety Notices in this Manual:



#### **WARNING**

Indicates a potentially hazardous situation or practice which, if not avoided, will result in serious injury or death.



#### **CAUTION**

Indicates a potentially hazardous situation or practice which, if not avoided, could result in damage to the product or loss of important data.

### Safety Terms on the Product:

**DANGER** It calls attention to an operation, if not correctly performed, could result in injury or hazard immediately.

**WARNING** It calls attention to an operation, if not correctly performed, could result in potential injury or hazard.

**CAUTION** It calls attention to an operation, if not correctly performed, could result in damage to the product or other devices connected to the product.

### Safety Symbols on the Product:



Hazardous  
Voltage



Safety  
Warning



Protective  
Earth  
Terminal



Chassis  
Ground



Test  
Ground

## Measurement Category

### Measurement Category

MSO2000A/DS2000A series digital oscilloscopes can make measurements in Measurement Category I.



---

**WARNING**

This oscilloscope can only be used for measurements within its specified measurement categories.

---

### Measurement Category Definitions

Measurement category I is for measurements performed on circuits not directly connected to MAINS. Examples are measurements on circuits not derived from MAINS, and specially protected (internal) MAINS derived circuits. In the latter case, transient stresses are variable; for that reason, the transient withstand capability of the equipment is made known to the user.

Measurement category II is for measurements performed on circuits directly connected to the low voltage installation. Examples are measurements on household appliances, portable tools and similar equipment.

Measurement category III is for measurements performed in the building installation. Examples are measurements on distribution boards, circuit-breakers, wiring, including cables, bus-bars, junction boxes, switches, socket-outlets in the fixed installation, and equipment for industrial use and some other equipment, for example. Stationary motors with permanent connection to the fixed installation.

Measurement category IV is for measurements performed at the source of the low-voltage installation. Examples are electricity meters and measurements on primary overcurrent protection devices and ripple control units.

## Ventilation Requirement

This oscilloscope uses fan to force cooling. Please make sure that the air intake and exhaust areas are free from obstructions and have free air. When using the oscilloscope in a bench-top or rack setting, provide at least 10 cm clearance beside, above and behind the instrument for adequate ventilation.



---

**WARNING**

Inadequate ventilation may cause temperature increase which would damage the instrument. So please keep the instrument well ventilated during operation and inspect the intake and fan regularly.

---

## Working Environment

### Temperature

Operating: 0°C to +50°C

Non-operating: -40°C to +70°C

### Humidity

0°C to +30°C: ≤95% relative humidity

+30°C to +40°C: ≤75% relative humidity

+40°C to +50°C: ≤45% relative humidity



#### **WARNING**

To avoid short circuit inside the instrument or electric shock, please do not operate in humid environment.

---

### Altitude

Operating: less than 3 km

Non-operating: less than 15 km

### Installation (overvoltage) Category

This product is powered by mains conforming to installation (overvoltage) category II.



#### **WARNING**

Make sure that no overvoltage (such as that caused by thunderbolt) can reach the product, or else the operator might expose to danger of electric shock.

---

### Installation (overvoltage) Category Definitions

Installation (overvoltage) category I refers to signal level which is applicable to equipment measurement terminals connected to the source circuit. In these terminals, precautions are done to limit the transient voltage to the corresponding low level.

Installation (overvoltage) category II refers to the local power distribution level which is applicable to equipment connected to the AC line(AC power).

### Pollution Degree

Degree 2

### Pollution Degree Definitions

Pollution degree 1: No pollution or only dry, non-conductive pollution occurs. The pollution has no influence. For example: a clean room or air-conditioned office environment.

Pollution degree 2: Normally only dry, non-conductive pollution occurs. Occasionally a temporary conductivity caused by condensation may occur. For example: general indoor environment.

Pollution degree 3: Conductive pollution occurs, or dry, non-conductive pollution occurs which becomes conductive due to condensation which is expected. For example: Sheltered outdoor environment.

Pollution degree 4: Pollution that generates persistent conductivity through conductive dust, rain, or snow. For example: outdoor locations.

### **Safety Class**

Class 1 – Grounded Product

## **General Care and Cleaning**

### **Care:**

Do not store or leave the instrument in where the instrument will be exposed to direct sunlight for long periods of time.

### **Cleaning:**

Clean the instrument regularly according to its operating conditions.

1. Disconnect the instrument from all power sources.
2. Clean the external surfaces of the instrument with a soft cloth dampened with mild detergent or water. Avoid having any water or other objects into the chassis via the heat dissipation hole. When cleaning the LCD, take care to avoid scarifying it.



---

### **CAUTION**

To avoid damage to the instrument, do not expose it to caustic liquids.

---



---

### **WARNING**

To avoid short-circuit resulting from moisture or personal injuries, ensure that the instrument is completely dry before connecting it to the power supply.

---

## Environmental Considerations

The following symbol indicates that this product complies with the WEEE Directive 2002/96/EC.



### Product End-of-Life Handling

The equipment may contain substances that could be harmful to the environment or human health. To avoid the release of such substances into the environment and avoid harm to human health, we recommend you to recycle this product appropriately to ensure that most materials are reused or recycled properly. Please contact your local authorities for disposal or recycling information.

## Document Overview

This manual is used to guide users to quickly get familiar with the front panel, rear panel, user interface and basic operation method of MSO2000A/DS2000A series digital oscilloscope. You can download the newest version of the manual from **RIGOL** official website ([www.rigol.com](http://www.rigol.com)).

### Format Conventions in this Manual:

#### 1. Button

The front panel keys are denoted by the format of "Button Name (Bold) + Text Box". For example, **Utility** denotes the "Utility" key.





#### 2. Menu

The menu softkeys are denoted by the format of "Menu Word (Bold) + Character Shading". For example, **System** denotes the "System" menu under **Utility**.

#### 3. Operation Step

The next step of operation is denoted by an arrow "→". For example, **Utility** → **System** denotes that first press **Utility** on the front panel and then press **System**.

#### 4. Knob

| Label   | Knob                     |
|---|--------------------------|
| <b>HORIZONTAL</b>  <b>SCALE</b>    | Horizontal Scale Knob    |
| <b>HORIZONTAL</b>  <b>POSITION</b> | Horizontal Position Knob |
| <b>VERTICAL</b>  <b>SCALE</b>      | Vertical Scale Knob      |
| <b>VERTICAL</b>  <b>POSITION</b>   | Vertical Position Knob   |
| <b>TRIGGER</b>  <b>LEVEL</b>       | Trigger Level Knob       |



**Content Conventions in this Manual:**

MSO2000A/DS2000A series includes the following models. This manual takes MSO2302A-S as an example to illustrate the functions and operation methods of MSO2000A/DS2000A series.

| <b>Model</b>     | <b>Analog Bandwidth</b> | <b>Number of Analog Channels</b> | <b>Number of Source Channels</b> |
|------------------|-------------------------|----------------------------------|----------------------------------|
| MSO2102A/DS2102A | 100 MHz                 | 2                                | --                               |
| MSO2102A-S       | 100 MHz                 | 2                                | 2                                |
| MSO2202A/DS2202A | 200 MHz                 | 2                                | --                               |
| MSO2202A-S       | 200 MHz                 | 2                                | 2                                |
| MSO2302A/DS2302A | 300 MHz                 | 2                                | --                               |
| MSO2302A-S       | 300 MHz                 | 2                                | 2                                |

# Contents

|                                       |           |
|---------------------------------------|-----------|
| <b>Guaranty and Declaration</b> ..... | <b>I</b>  |
| <b>Safety Requirement</b> .....       | <b>II</b> |
| General Safety Summary.....           | II        |
| Safety Notices and Symbols .....      | II        |
| Measurement Category.....             | III       |
| Ventilation Requirement.....          | III       |
| Working Environment .....             | IV        |
| General Care and Cleaning .....       | V         |
| Environmental Considerations.....     | VI        |
| <b>Document Overview</b> .....        | <b>VI</b> |
| <b>Quick Start</b> .....              | <b>1</b>  |
| General Inspection .....              | 1         |
| Appearance and Dimensions .....       | 2         |
| To Prepare for Operation.....         | 3         |
| To Adjust the Supporting Legs .....   | 3         |
| To Connect to AC Power Supply .....   | 3         |
| Turn-on Checkout .....                | 4         |
| To Connect the Probe.....             | 4         |
| Function Inspection .....             | 6         |
| Probe Compensation .....              | 7         |
| Front Panel Overview .....            | 8         |
| Rear Panel Overview .....             | 9         |
| Front Panel Function Overview .....   | 11        |
| VERTICAL .....                        | 11        |
| HORIZONTAL .....                      | 12        |
| TRIGGER .....                         | 13        |
| CLEAR .....                           | 14        |
| RUN/STOP .....                        | 14        |
| SINGLE.....                           | 14        |
| AUTO .....                            | 14        |
| Knob .....                            | 15        |
| Navigation Knob .....                 | 15        |
| MENU.....                             | 16        |
| Signal Source .....                   | 16        |
| Record.....                           | 17        |
| Print.....                            | 17        |
| Logic Analyzer .....                  | 18        |
| User Interface.....                   | 19        |
| To Use the Security Lock.....         | 24        |
| To Use the Built-in Help System ..... | 25        |
| <b>Troubleshooting</b> .....          | <b>26</b> |

# Quick Start

## General Inspection

### 1. Inspect the packaging

If the packaging has been damaged, do not dispose the damaged packaging or cushioning materials until the shipment has been checked for completeness and has passed both electrical and mechanical tests.

The consigner or carrier shall be liable for the damage to the instrument resulting from shipment. **RIGOL** would not be responsible for free maintenance/rework or replacement of the instrument.

### 2. Inspect the instrument

In case of any mechanical damage, missing parts, or failure in passing the electrical and mechanical tests, contact your **RIGOL** sales representative.

### 3. Check the accessories

Please check the accessories according to the packing lists. If the accessories are damaged or incomplete, please contact your **RIGOL** sales representative.

# Appearance and Dimensions

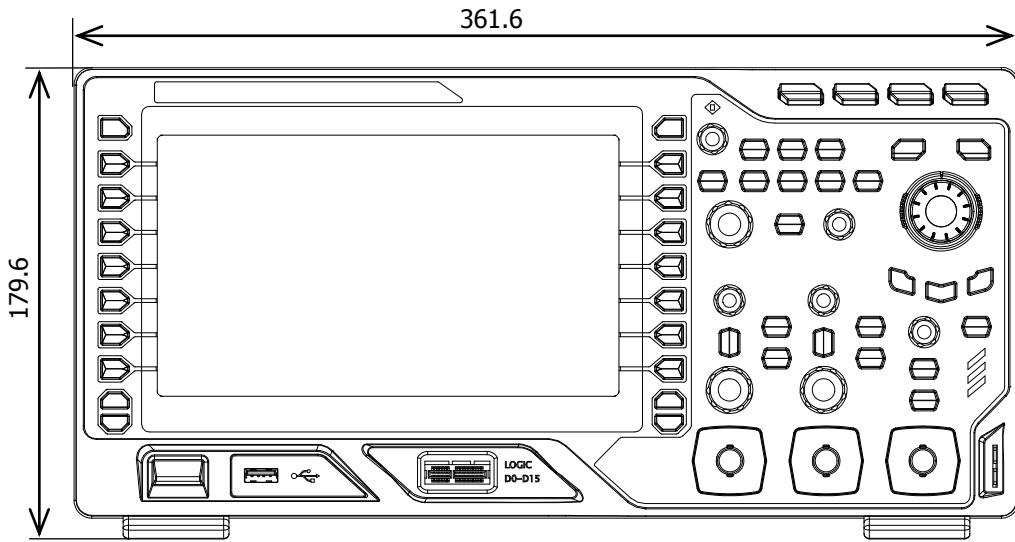

Figure 1 Front View

Unit: mm

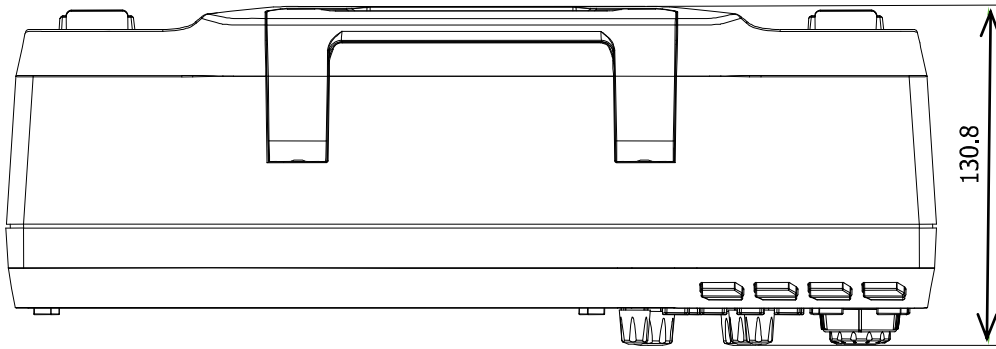

Figure 2 TopView

Unit: mm

## To Prepare for Operation

### To Adjust the Supporting Legs

Adjust the supporting legs properly to use them as stands to tilt the oscilloscope upwards for stable placement of the oscilloscope as well as better operation and observation.

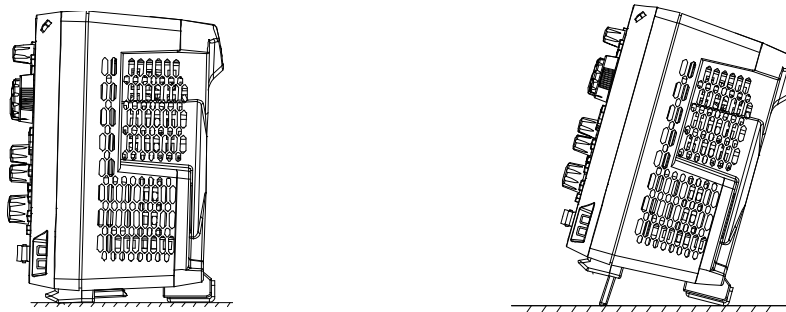



Figure 3 To Adjust the Supporting Legs

### To Connect to AC Power Supply

This oscilloscope can accept 100-240V, 45-440 Hz AC power supply. Please use the power cord supplied with the accessories to connect the oscilloscope to the power supply as shown in the figure below. When the oscilloscope is powered on and the Power key  at the lower-left corner of the front panel is blinking.

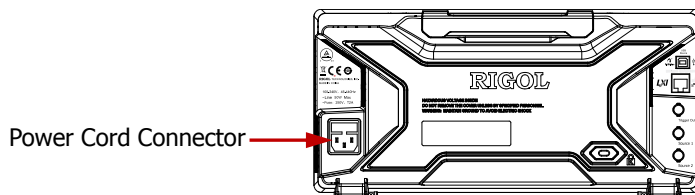



Figure 4 To Connect to AC Power Supply

## Turn-on Checkout

When the oscilloscope is connected to power, press the Power key  at the lower-left corner of the front panel to start the oscilloscope. During the start-up process, the oscilloscope performs a series of self-test items and you can hear the sound of relay switching. After the self-test, the welcome screen is displayed. The instrument is installed with the trial versions of the options before leaving factory and the remaining time is about 2,000 minutes. The "Current Options" dialog box will be displayed if your instrument has currently installed the trial versions of options. From this dialog box you can view the types, names, versions and the remaining time of the options currently installed.

## To Connect the Probe

**RIGOL** provides passive probes for DS2000A, and provides passive probes and logic probes for MSO2000A. For the model of the probes, please refer to *MSO2000A&DS2000A Series Datasheet*. For detailed technical information of the probes, please refer to corresponding Probe User's Guide.

### Connect the Passive Probe:

1. Connect the BNC terminal of the probe to an analog channel input of the oscilloscope on the front panel.
2. Connect the ground alligator clip or spring of the probe to the circuit ground terminal and then connect the probe tip to the circuit point under test.

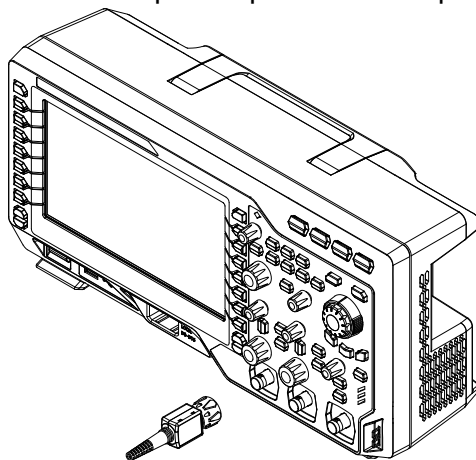

Figure 5 To Connect the Passive Probe

After you connect the passive probe, check the probe function and probe compensation adjustment before making measurements. For detailed procedures, refer to "**Function Inspection**" and "**Probe Compensation**" sections in this manual.

### Connect the Logic Probe:

1. Connect the single-wire terminal of the logic probe to the **[LOGIC D0-D15]** digital channel terminal on the front panel of MSO2000A in the correct direction.
2. Connect the other terminal of the logic probe to the signal under test. **RIGOL** provides MSO2000A with the standard RPL2316 logic probe. To cater to different application scenarios, RPL2316 provides three connection methods for the signal under test. For details, please refer to the *RPL2316 Logic Probe User's Guide*.

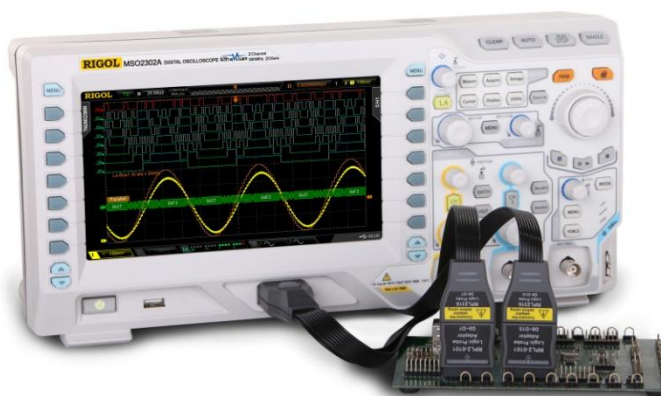

Figure 6 To Connect the Logic Probe

**Note:** The digital channel input terminal does not support hot plugging. Please do not insert or pull out the logic probe when the instrument is in power-on state.

## Function Inspection

1. Press **Storage** → **Default** to restore the oscilloscope to its default configuration.
2. Connect the groundalligator clip of the probe to the "GroundTerminal" as shown in the figure below.
3. Use the probe to connect the input terminal of CH1 and the "Compensation Signal Output Terminal" of the oscilloscope.

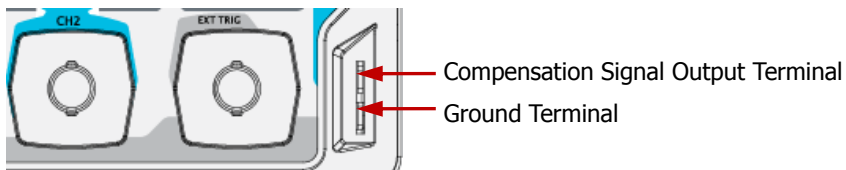

Figure 7 To Use the Compensation Signal

4. Set the attenuation on the probe to 10X. Then press **AUTO**.
5. Observe the waveform on the display. In normal condition, the display should be a square waveform as shown in the figure below:

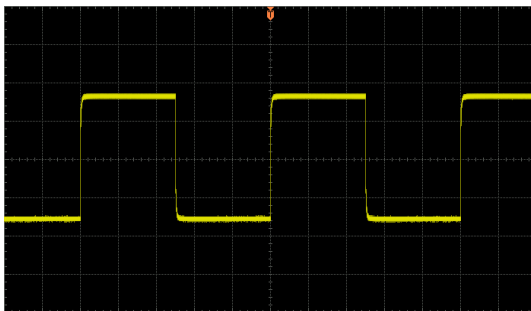

Figure 8 Square Waveform

6. Use the same method to test the other channels. If the square waveforms actually shown do not match that in the figure above, please perform "**Probe Compensation**".



### WARNING

To avoid electric shock during the use of probe, please make sure that the insulated wire of the probe is in good condition. Do not touch the metallic part of the probe when the probe is connected to high voltage source.



**Tip**

The signal output from the probe compensation connector can only be used for probe compensation adjustment and cannot be used for calibration.

## Probe Compensation

When the probes are used for the first time, you should compensate the probes to match the input channels of the oscilloscope. Non-compensated or poorly compensated probes may cause measurement inaccuracy or errors. The probe compensation procedures are as follows:

1. Perform Step 1, 2, 3 and 4 specified in "**Function Inspection**".
2. Check the displayed waveforms and compare them with the waveforms in the following figure.

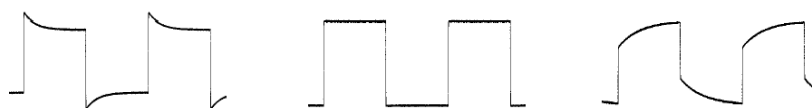

Over compensated Perfectly compensated Under compensated

Figure 9 Probe Compensation

3. Use a nonmetallic driver to adjust the low-frequency compensation adjustment hole on the probe until the displayed waveform is displayed as the "Perfectly compensated" in the figure above.

# Front Panel Overview

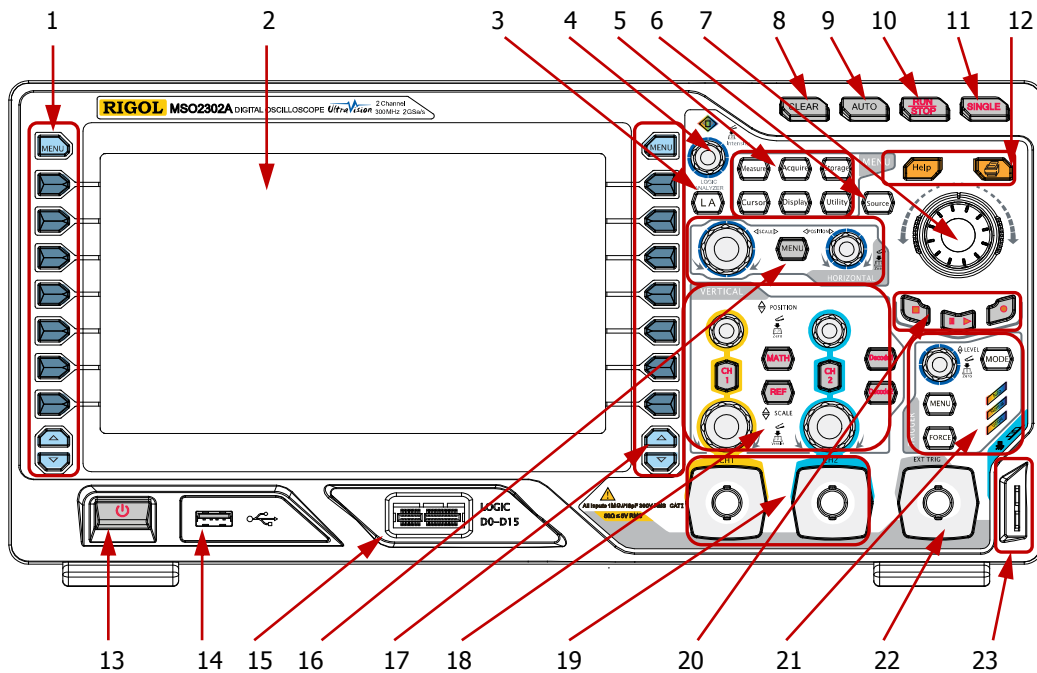

Figure 10 Front Panel Overview

Table 1 Front Panel Description

| No. | Description                               | No. | Description  |
|-----|---|-----|--|
| 1   | Measurement Menu Softkeys                 | 13  | Power Key  |
| 2   | LCD                                       | 14  | USB HOST Interface   |
| 3   | Logic Analysis Control Key <sup>[1]</sup> | 15  | Digital Channel Input Interface <sup>[1]</sup>             |
| 4   | Multifunction Knob                        | 16  | HORIZONTAL Control Area                                    |
| 5   | Function Menu Keys                        | 17  | Function Menu Softkeys                                     |
| 6   | Signal Source <sup>[2]</sup>              | 18  | VERTICAL Control Area                                      |
| 7   | Navigation Knob                           | 19  | Analog Channel Input Area                                  |
| 8   | CLEAR                                     | 20  | Waveform Record/Playback Control Keys                      |
| 9   | AUTO                                      | 21  | TRIGGER Control Area                                       |
| 10  | RUN/STOP                                  | 22  | EXT TRIG Input Terminal                                    |
| 11  | SINGLE                                    | 23  | Probe Compensation Signal Output Terminal/ Ground Terminal |
| 12  | Help/Print                                | --  | --   |

**Note<sup>[1]</sup>:** Only applicable to MSO2000A and MSO2000A-S models.

**Note<sup>[2]</sup>:** Only applicable to the MSO2000A-S model.

## Rear Panel Overview

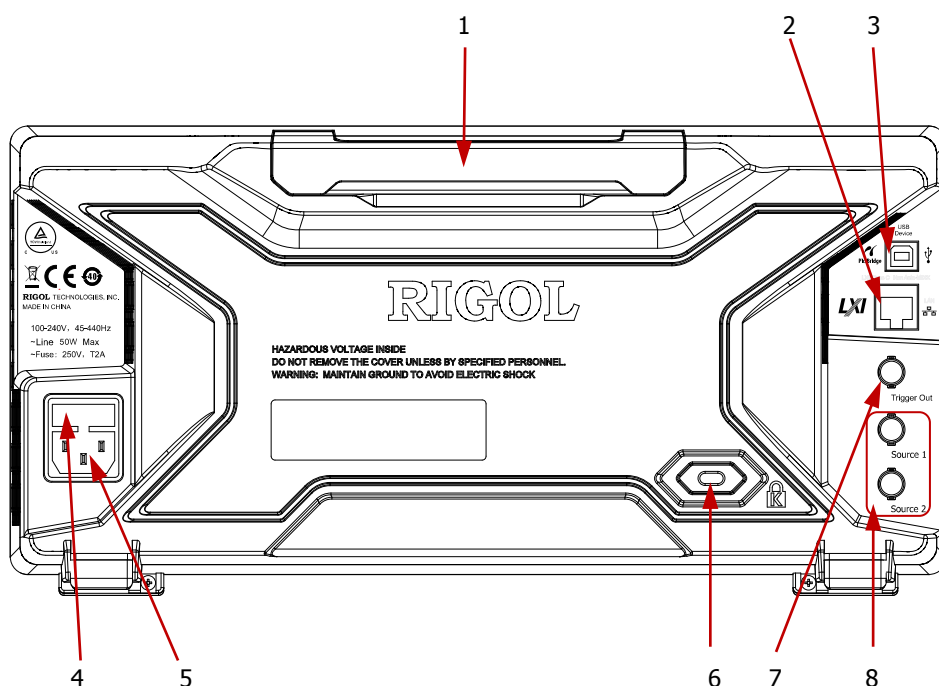

Figure 11 Rear Panel Overview

### 1. Handle

Pull up the handle vertically for easy carrying of the instrument. When you do not need the handle, press it down.

### 2. LAN

Connect the instrument to the network via this interface for remote control. This oscilloscope conforms to the LXI CORE 2011 DEVICE class instrument standards and can quickly build test system with other instruments.

### 3. USB DEVICE

PictBridge printer or PC can be connected via this interface to print waveform data or control the instrument using PC software.

### 4. Fuse

If a new fuse is required, please use the specified fuse (250V, T2A). The operation method is as follows:

- (1) Turn off the instrument and remove the power cord.
- (2) Insert a small straight screwdriver into the slot at the power cord connector and pry out the fuse holder gently.
- (3) Take out the fuse and replace it with a specified fuse. Then, install the fuse holder.

## **5. AC PowerCord Connector**

AC power input terminal. The power requirements of this oscilloscope are 100-240 V, 45-440 Hz. Use the power cord provided with the accessories to connect the instrument to AC power. Then, you can press the Power key on the front panel to start the instrument.

## **6. Lock Hole**

You can lock the instrument to a fixed location by using the security lock (please purchase it yourself) via the lock hole.

## **7. Trigger Out**

The oscilloscope can output a signal that can reflect the current capture rate of the oscilloscope at each trigger via this interface. Connect the signal to a waveform display device and measure the frequency of the signal. The measurement result is the same as the current capture rate. The instrument can also output a signal when a failed waveform is detected during the pass/fail test.

## **8. Source Output**

When Source1 or Source2 is enabled, the signal currently set can be output through the **[Source1]** or **[Source2]** connector on the rear panel to the analog input terminal of the oscilloscope or external devices connected to the connector. This function is only available for the MSO2000A-S model.

## Front Panel Function Overview

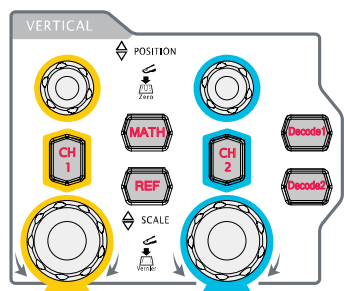

### VERTICAL





**CH1**, **CH2**: analog input channels. The 2 channels are marked by different colors which are also used to mark both the corresponding waveforms on the screen and the channel input connectors. Press any key to open the corresponding channel menu and press again to turn off the channel.

**MATH**: press this key to open the math operation menu under which add, subtract, multiply, divide, FFT, logic and advanced operations are provided.

**REF**: press this key to enable the reference waveform function to compare the waveform actually tested with the reference waveform.

**Vertical**  **POSITION**: modify the vertical position of the current channel waveform. Turn clockwise to increase the position and turn counterclockwise to decrease. During the modification, the waveform would move up and down and the position message (e.g. ) at the lower-left corner of the screen would change accordingly. Press down this knob to quickly reset the vertical position to zero.

**VERTICAL**  **SCALE**: modify the vertical scale of the current channel. Turn clockwise to decrease the scale and turn counterclockwise to increase. During the modification, the display amplitude of the waveform would enlarge or reduce but the actual amplitude remains unchanged. The scale information (e.g. ) at the lower side of the screen would change accordingly. Press down this knob to quickly switch the vertical scale adjustment modes between "Coarse" and "Fine".

**Decode1**, **Decode2**: decoding function keys. Press the corresponding key to open the decoding function menu. MSO2000A/DS2000A support parallel decoding and protocol decoding.

## HORIZONTAL

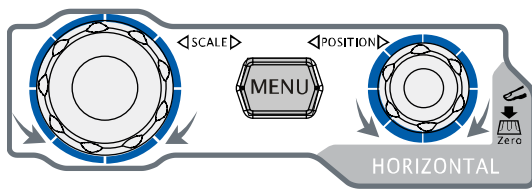

**MENU**: press this key to open the horizontal control menu under which to turn on or off the delayed sweep function, switch between different time base modes, switch between

"Coarse" and "Fine" adjustment of scale as well as modify the horizontal reference setting.

**HORIZONTAL**  **SCALE**: modify the horizontal time base. Turn clockwise to reduce the time base and turn counterclockwise to increase the time base. During the modification, waveforms of all the channels will be displayed in expanded or compressed mode and the time base message (e.g. **H 5.000ns**) at the upper side of the screen would change accordingly. Press down this knob to quickly switch to the delayed sweep state.

**HORIZONTAL**  **POSITION**: modify the horizontal position. The trigger point would move left or right relative to the center of the screen when you turn the knob. During the modification, waveforms of all the channels would move left or right and the trigger position message (e.g. **D 5.8000000ns**) at the upper-right corner of the screen would change accordingly. Press down this knob to quickly reset the trigger position (or the delayed sweep position).

## TRIGGER

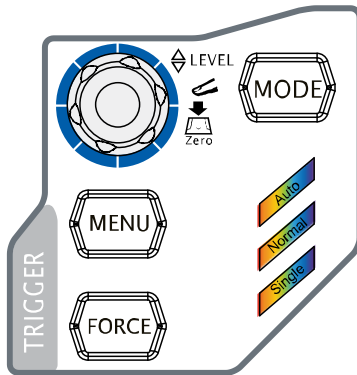

**MODE**: press this key to switch the trigger mode to **Auto**, **Normal** or **Single** and the corresponding state backlight of the current trigger mode would be illuminated.

**TRIGGER LEVEL**: modify the trigger level. Turn clockwise to increase the level and turn counterclockwise to reduce the level. During the modification, the trigger level line would move up

and down and the value in the trigger level message box (e.g. Trig Level: 1.88 V) at the lower-left corner of the screen would change accordingly. Press down the knob to quickly reset the trigger level to zero point.

**MENU**: press this key to open the trigger operation menu. This oscilloscope provides various trigger types.

**FORCE**: in **Normal** and **Single** trigger modes, press this key to generate a trigger signal forcefully.

## CLEAR



Press this key to clear all the waveforms on the screen. If the oscilloscope is in the "RUN" state (the key is illuminated in yellow), new waveforms will still be displayed.

## RUN/STOP



Press this key to set the state of the oscilloscope to "RUN" or "STOP".

In the "RUN" state, the key is illuminated in yellow.

In the "STOP" state, the key is illuminated in red.

## SINGLE



Press this key to set the trigger mode to "Single", the key is illuminated in orange. In single trigger mode, press **FORCE** to generate a trigger signal immediately.

## AUTO



Press this key to enable the waveform auto setting function. The oscilloscope will automatically adjust the vertical scale, horizontal time base and trigger mode according to the input signal to realize optimum waveform display. **Note:** auto setting requires that the frequency of the signal under test should be no lower than 25Hz. If the parameter exceed the limit, "Can't detect any signal!" will be displayed after pressing this key and the quick parameter measurement menu might not be displayed.



## Knob



### Adjust waveform brightness:

In non-menu-operation mode (menu is hidden), turn this knob to adjust the brightness of waveform display. The adjustable range is from 0% to 100%. Turn clockwise to increase the brightness and counterclockwise to reduce. Press down this knob to reset the brightness to 50%. You can also press **Display** → **WaveIntensity** and use the knob to adjust the waveform brightness.

### Multifunction(the backlight goes on during operation):

In menu operation, press any menu softkey and turn the knob to select the submenus under this menu and then press down the knob to select the current submenu. It can also be used to modify parameters and input filename. In addition, for MSO2000A-S, in the source interface, press the corresponding menu softkey and then press the knob; the numeric keyboard will be displayed on the screen and you can input the desired parameter value and unit directly using this knob.

## Navigation Knob

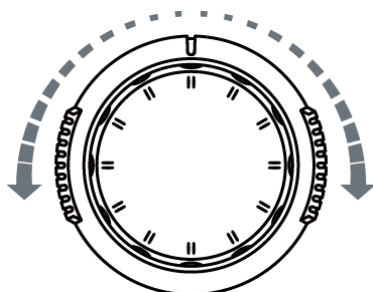

This knob provides quick Adjust/Locate function for numerical parameters with relatively large settable range. Turn clockwise (counterclockwise) to increase (reduce) the value. The inner knob is used for fine adjustment and the outer knob for coarse adjustment.

For example, this knob can be used to quickly locate the waveform frame ("Current Frame" menu) to be played back in the waveform playback function. Similar menus include trigger holdoff, pulse width setting, slope time etc.

## MENU

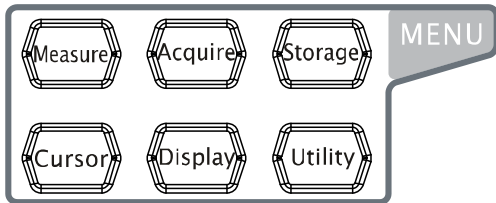

**Measure:** press this key to open the measurement setting menu. You can set the measurement setting, all measure, statistic function etc.

Press **MENU** at the left of the screen

to open the measurement menus of 29 waveform parameters. Then, press down the corresponding menu softkey to quickly realize one-key measurement and the measurement result will be displayed at the bottom of the screen.

**Acquire:** press this key to enter the sample setting menu to set the acquisition mode, memory depth and antialiasing function of the oscilloscope.

**Storage:** press this key to enter the file store and recall interface. The storable file types include traces, waveforms, setups, picture and CSV. The picture can be stored in bmp, png, jpeg and tiff formats. Internal and external storage as well as disk management are also supported.

**Cursor:** press this key to enter the cursor measurement menu. The oscilloscope provides four cursor modes: manual, track, auto and X-Y. **Note:**X-Y cursor mode is only available for the X-Ytime base mode.

**Display:** press this key to enter the display setting menu to set the display type, persistence time, wave intensity, grid type, grid brightness and menu display time of the waveform.

**Utility:** press this key to enter the system utility function setting menu to set the system-related functions or parameters, such as the I/O, sound and language. Besides, some advanced functions (such as the pass/fail test, waveform record and print setting) are also supported.

## Signal Source



Press this key to enter the source setting interface. You can enable or disable the output of the **[Source1]** or **[Source2]** connector on the rear panel, set the output signal parameters (such as the frequency, amplitude, offset and phase).

**Note:** This function is only available for MSO2000A-S.

## Record

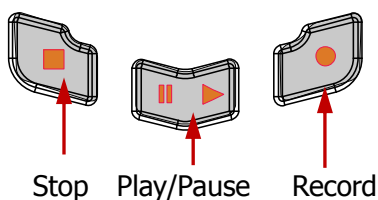

**Record:** press this key to start recording the waveform. At this moment, the red backlight of the key will start flashing. Besides, when the record constant on (Open) is enabled, the backlight will also keep flashing.

**Play/Pause:** in the stop or pause state, press this key to play back the waveform and press again to pause the play. The backlight is illuminated in yellow.

**Stop:** press this key to stop the waveform being recorded or being played back. The backlight is illuminated in orange.

## Print



Press this key to execute the print function or save the screen in the USB storage device. If a PictBridge printer is currently connected and the printer is in idle state, pressing this key will execute the print function. If no printer but a USB storage device is currently connected, pressing this key will save the screen to the USB storage device in ".png" format by default. You can also save the screen in the specified picture format (bmp, png, jpeg and tiff) by pressing the **Storage** to set the storage type as picture, and then pressing the **Pic Type** to select the desired format. When printer and USB storage device are connected at the same time, the printer enjoys higher priority.

## Logic Analyzer



Press this key to open the logic analyzer control menu. You can turn on or off any channel or channel group, modify the display size of the digital channel, modify the logic threshold of the digital channel as well as group the 16 digital channels and display them as a bus. You can also set a label for each digital channel.

**Note:** This function is only applicable to MSO2000A and MSO2000A-S.

## User Interface

MSO2000A/DS2000A provides 8.0 inch, WVGA (800\*480) 160,000 color TFT LCD. What is worth mentioning is that the 14-grid ultra-wide screen enables you to view "longer" waveform.

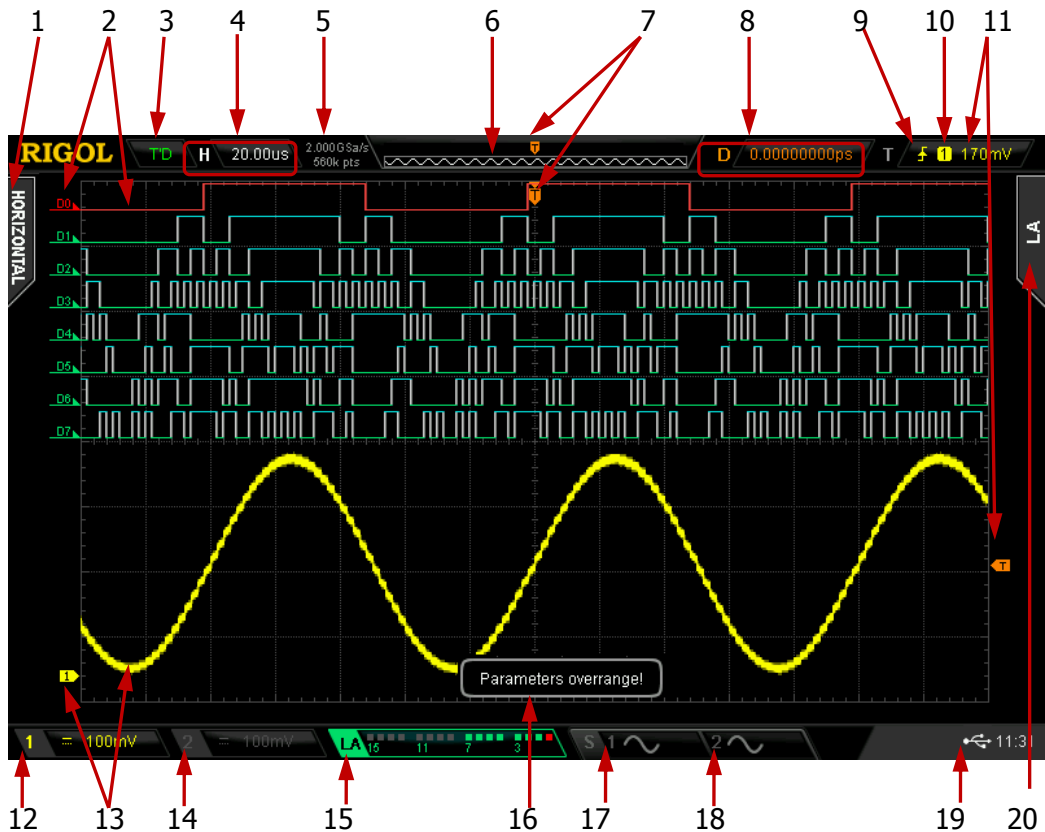

Figure 12 User Interface

### 1. Auto Measurement Items

Provide 16 horizontal (HORIZONTAL) and 13 vertical (VERTICAL) measurement parameters. Press the softkey at the left of the screen to activate the corresponding measurement item. Press **MENU** continuously to switch between the horizontal and vertical parameters.

## 2. Digital Channel Label/Waveform

The logic high level of the digital waveform is displayed in blue and the logic low level in green (correspond to the color of the channel label). Its edge is displayed in white. The label and waveform of the digital channel currently selected are displayed in red. **Note:** This function is only applicable to MSO2000A and MSO2000A-S.

## 3. Status

Available states include RUN, STOP, T'D (triggered), WAIT and AUTO.

## 4. Horizontal Time Base

- Represent the time per grid on the horizontal axis on the screen.
- Use **HORIZONTAL**  **SCALE** to modify this parameter. The range available is from 1.000 ns to 1.000 ks (for 200 MHz bandwidth oscilloscope, the range available is 2.000 ns to 1.000 ks; for 100 MHz and 70 MHz bandwidth oscilloscope, the range available is 5.000 ns to 1.000 ks).

## 5. Sample Rate/Memory Depth

- Display the current sample rate and memory depth of the oscilloscope.
- Use **HORIZONTAL**  **SCALE** to modify this parameter.

## 6. Waveform Memory

Provide the schematic diagram of the memory position of the waveform currently on the screen.

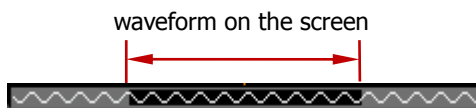

## 7. Trigger Position

Display the trigger position of the waveform in the waveform memory and on the screen.

## 8. Horizontal Position

Use **HORIZONTAL**  **POSITION** to modify this parameter. Press down the knob to automatically set the parameter to zero.





## 9. Trigger Type

Display the currently selected trigger type and trigger condition setting. Different labels are displayed when different trigger types are selected. For example:  represents triggering on the rising edge in "Edge" trigger.





## 10. Trigger Source

Display the trigger source currently selected (CH1, CH2, EXT, EXT/5, AC Line or D0-D15). Different labels are displayed when different trigger sources are selected and the color of the trigger parameter area will change accordingly. For example:  denotes that CH1 is selected as the trigger source. **Note:** EXT/5 is only applicable to MSO2000A and MSO2000A-S.

## 11. Trigger Level

- When the trigger source is set to CH1 or CH2, the trigger level label  is displayed at the right of the screen and the trigger level value is displayed at the upper-right corner of the screen. When using **TRIGGER**  **LEVEL** to modify the trigger level, the trigger level value will change with the up and down of .
- When the trigger source is set to EXT or EXT/5, the trigger level value is displayed at the upper-right corner of the screen. No trigger level label is displayed.
- When the trigger source is set to AC Line, no trigger level value and trigger level label is displayed.
- When the trigger source is set to D0 to D15, the trigger threshold is displayed at the upper-right corner of the screen. No trigger level label is displayed.
- In Runt trigger, Slope trigger and Windows trigger, two trigger level labels ( and ) are displayed.



## 12. CH1 Vertical Scale

- Display the voltage value per grid of CH1 waveform vertically.
- Use **VERTICAL**  **SCALE** of CH1 to modify this parameter.
- The following labels will be displayed according to the current channel setting: channel coupling (e.g. ) , input impedance (e.g. ) and bandwidth limit (e.g. ) .

### 13. Analog Channel Label/Waveform

Different channels are marked with different colors and the colors of the channel label and waveform are the same.

### 14. CH2 Vertical Scale

- Display the voltage value per grid of CH2 waveform vertically.
- Use **VERTICAL SCALE** of CH2 to modify this parameter.
- The following labels will be displayed according to the current channel setting: channel coupling (e.g. ) , input impedance (e.g. ) and bandwidth limit (e.g. ) .



### 15. Digital Channel Status Area

Display the current status of the 16 digital channels (D0 to D15 from right to left). The digital channels currently turned on are displayed in green and the digital channel currently selected is displayed in red. The digital channels turned off are displayed in grey in the digital channel area. **Note:** This function is only applicable to MSO2000A and MSO2000A-S.



### 16. Message Box

Display the prompt messages.

### 17. Source1 Waveform

- Display the type of waveform currently set for Source1.
- When the impedance of source 1 is set to 50  $\Omega$ ,  will be displayed at the right of the Source1 waveform.
- When the modulation of source 1 is enabled,  will be displayed at the right of the Source1 waveform.
- Only available for MSO2000A-S.



### 18. Source2 Waveform

- Display the type of waveform currently set for Source2.
- When the impedance of source 2 is set to 50  $\Omega$ ,  will be displayed at the right of the Source2 waveform.
- When the modulation of source 2 is enabled,  will be displayed at the right of the Source2 waveform.
- Only available for MSO2000A-S.



## 19. Notification Area



Display the system time, sound icon and USB storage device icon.

- System Time: displayed in "hh:mm (hour:minute)" format. When printing or storing the waveform, the output file will contain this time message. Press **Utility**→**System**→**System Time**→**System Time** to set through the following format:  
yyyy-mm-ddhh:mm:ss (year-month-datehour:minute:second)
- Sound Icon: when the sound is enabled,  will be displayed. Press **Utility**→**Sound** to enable or disable the sound.
- USB Storage Device Icon: when a USB storage device is detected,  will be displayed.



## 20. Operation MENU

Press any softkey to activate the corresponding menu. The following symbols might be displayed in the menu:





Denote that  on the front panel can be used to select the parameter items. The backlight of  turns on when the parameter selection is valid.



Denote that  can be used to modify the parameter values. The backlight of  turns on when the parameter input is valid.





Denote that  can be used to modify the parameter values and press  to input the desired parameter values directly using the pop-up numeric keyboard. The backlight of  turns on when the parameter input is valid.



Denote that you can use the "**Navigation Knob**" to quickly adjust/locate parameters.



Denote that you can use  to adjust the parameter and then press down  to select the parameter. The backlight of  is constant on.



Denote that the current menu has several options.



Denote that the current menu has a lower level menu.



Press this key to return to the previous menu.

**Note:** The following direction keys might appear in the grid at the lower-left corner of the menu bar:



Denote that you can open the next page menu.



Denote that you can open the previous page menu.

## To Use the Security Lock

If needed, you can use the security lock (please buy it yourself) to lock the oscilloscope to a fixed location. The method is as follows, align the lock with the lock hole and plug it into the lock hole vertically, turn the key clockwise to lock the oscilloscope and then pull the key out.

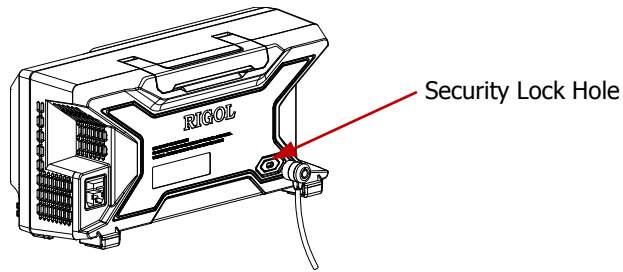

Figure 13 To Use the Security Lock

**Note:** Please do not insert other articles into the security lock hole to avoid damaging the instrument.

## To Use the Built-in Help System

The help system of this oscilloscope provides instructions for all the function keys (including the menu keys) on the front panel. Press **Help** to open the help interface and press again to close the interface. The help interface mainly consists of two parts. The left is "Help Options" and you can use "Button" or "Index" mode to select. The right is "Help Display Area".

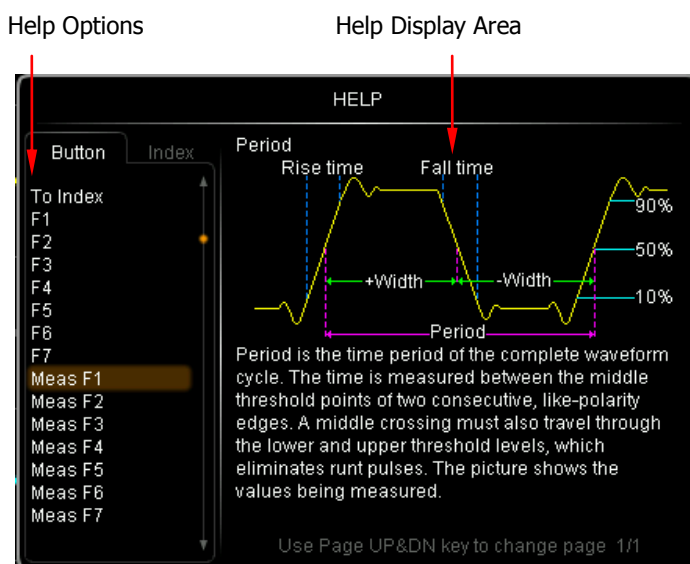









Figure 14 Help Information

### Button:

Default mode. In this mode, you can press the button (except the power key  and the function menu page up/down key  at the right of the screen) or rotate the multifunction knob  on the front panel to select the button name to get the corresponding help information in the "Help Display Area". In addition, you can get the help information of the navigation knob by rotating the navigation knob directly or using  to select "WaveSearch". Rotate  to select "To Index" and then press the knob to switch to **Index** mode.

### Index:

In this mode, use  to select the item that needs to get help (for example, "BW"). The item currently selected is displayed in brown. Press the knob to get the corresponding help information in the "Help Display Area". Use  to select "To Button" and then press the knob to switch to **Button** mode.

# Troubleshooting

The commonly encountered failures and their solutions are listed below. When you encounter those failures, please solve them following the corresponding steps. If the problem remains still, please contact **RIGOL** and provide your device information (acquisition method: **Utility** → **System** → **SystemInfo**).

## 1. The screen is still dark (no display) after you powered on the instrument.

- (1) Check whether the power switch is turned on.
- (2) Check whether the power is correctly connected.
- (3) Check whether the fuse is burned out. If the fuse needs to be changed, please use the specified fuse.
- (4) Restart the instrument after finishing the above inspections.
- (5) If it still persists, please contact **RIGOL**.

## 2. The signal is sampled but no waveform of the signal is displayed.

- (1) Check whether the probe is correctly connected to the item under tested.
- (2) Check whether signals are generated from the item under test (you can connect the probe compensation signal to the problematic channel to locate the problem).
- (3) Resample the signal.

## 3. The voltage amplitude measured is greater or smaller than the actual value (note that this failure usually only occurs when probe is used).

Check whether the attenuation ratio of the channel complies with the attenuation ratio of the probe.

## 4. Waveforms are found to be displayed but not stable.

- (1) Check the trigger signal source: press **MENU** of the TRIGGER Control Area on the front panel, then press **Source** to confirm whether the setting complies with the signal channel actually used.
- (2) Check the trigger type: general signals should use "Edge" trigger and video signal should use "Video" trigger. Only when the proper trigger type is used, can the waveform be displayed stably.
- (3) Check the trigger level: adjust the trigger level to the middle of the signal.

(4) Change the trigger holdoff setting.

#### 5. No display is found after pressing **RUN/STOP**.

Check the TRIGGER Control Area on the front panel to confirm whether the trigger mode is "Normal" or "Single" and whether the trigger level exceeds the waveform range. If yes, set the trigger level to the middle or press the **MODE** to set the trigger mode to "Auto".

**Note:** Pressing **AUTO** could automatically finish the above setting.

#### 6. The display of waveform is ladder-like.

- (1) The horizontal time base might be too low. Increase the horizontal time base to increase the horizontal resolution and improve the display.
- (2) If the display **Type** is "Vectors", the lines between the sample points may cause ladder-like display. Press **Display** → **Type**, set the display type to "Dots" to solve the problem.

#### 7. I fail to connect PC or PictBridge through USB.

- (1) Press **Utility** → **IO Setting** → **USB Device** to check whether the setting matches the device currently connected.
- (2) Check whether the USB cable is correctly connected to the instrument and PC.
- (3) Check whether the USB cable is in good condition. If needed, restart the oscilloscope.

#### 8. The USB storage device cannot be recognized.

- (1) Check whether the USB storage device can work normally.
- (2) Check whether the USB storage device being used is flash type. This oscilloscope does not support USB 3.0 and hardware type USB storage device.
- (3) Check whether the capacity of the USB storage device is too large. It is recommended that the capacity of the USB storage device being used with this oscilloscope should not exceed 8GB.
- (4) Restart the instrument and then insert the USB storage device to check it.
- (5) If the USB storage device still cannot be used normally, please contact **RIGOL**.



# **RIGOL**

## **快速指南**

# **MSO2000A/DS2000A 系列 数字示波器**

**2019 年 5 月**

**RIGOL (SUZHOU) TECHNOLOGIES INC.**





# 保证和声明

## 版权

© 2013 苏州普源精电科技有限公司

## 商标信息

**RIGOL** 是苏州普源精电科技有限公司的注册商标。

## 文档编号

QGA18004-1110

## 声明

- 本公司产品受中国及其它国家和地区的专利（包括已取得的和正在申请的专利）保护。
- 本公司保留改变规格及价格的权利。
- 本手册提供的信息取代以往出版的所有资料。
- 本手册提供的信息如有变更，恕不另行通知。
- 对于本手册可能包含的错误，或因手册所提供的信息及演绎的功能以及因使用本手册而导致的任何偶然或继发的损失，**RIGOL** 概不负责。
- 未经 **RIGOL** 事先书面许可，不得影印、复制或改编本手册的任何部分。

## 产品认证

**RIGOL** 认证本产品符合中国国家产品标准和行业产品标准及 ISO9001:2015 标准和 ISO14001:2015 标准，并进一步认证本产品符合其它国际标准组织成员的相关标准。

## 联系我们

如您在使用此产品或本手册的过程中有任何问题或需求，可与 **RIGOL** 联系：

电子邮箱：service@rigol.com

网址：www.rigol.com

# 安全要求

## 一般安全概要

1. 请使用所在国家认可的本产品专用电源线。
2. 请确保产品可靠接地。
3. 正确连接探头。
4. 查看所有终端额定值。
5. 请使用合适的过压保护。
6. 请勿开盖操作。
7. 请勿将异物插入排风口。
8. 请使用合适的保险丝。
9. 避免电路外露。
10. 怀疑产品出故障时，请勿进行操作。
11. 请保持适当的通风。
12. 请勿在潮湿环境下操作。
13. 请勿在易燃易爆的环境下操作。
14. 请保持产品表面的清洁和干燥。
15. 请注意防静电保护。
16. 请注意搬运安全。

## 安全术语和符号

本手册中的安全术语：



### 警告

警告性声明指出可能会造成人身伤害或危及生命安全的情况或操作。



### 注意

注意性声明指出可能导致本产品损坏或数据丢失的情况或操作。

产品上的安全术语：

**DANGER** 表示您如果不进行此操作，可能会立即对您造成危害。

**WARNING** 表示您如果不进行此操作，可能会对您造成潜在的危害。

**CAUTION** 表示您如果不进行此操作，可能会对本产品或连接到本产品的其他设备造成损坏。

产品上的安全符号：



高电压



安全警告



保护性接地端



壳体接地端



测量接地端

## 测量类别

### 测量类别

MSO2000A/DS2000A 系列数字示波器可在测量类别 I 下进行测量。



#### 警告

本示波器仅允许在指定的测量类别中使用。

### 测量类别定义

测量类别 I 是指在没有直接连接到主电源的电路上进行测量。例如，对没有从主电源导出的电路，特别是受保护（内部）的主电源导出的电路进行测量。在后一种情况下，瞬间应力会发生变化。因此，用户应了解设备的瞬间承受能力。

测量类别 II 是指在直接连接到低压设备的电路上进行测量。例如，对家用电器、便携式工具和类似的设备进行测量。

测量类别 III 是指在建筑设备中进行测量。例如，在固定设备中的配电板、断路器、线路（包括电缆、母线、接线盒、开关、插座）以及工业用途的设备和某些其它设备（例如，永久连接到固定装置的固定电机）上进行测量。

测量类别 IV 是指在低压设备的源上进行测量。例如，电量计在主要过电保护设备与脉冲控制单元上的测量。

## 通风要求

本示波器通过风扇强制冷却。请确保进气和排气区域无阻塞并有自由流动的空气。为保证充分的通风，在工作台机架中使用示波器时，请确保其两侧、上方、后面应留出至少 10 厘米的间隙。



#### 警告

通风不良会引起仪器温度升高，进而引起仪器损坏。使用时应保持良好的通风，定期检查通风口和风扇。

## 工作环境

### 温度

操作时：0°C至+50°C

非操作时：-40°C至+70°C

### 湿度

0°C至+30°C：≤95%相对湿度

+30°C至+40°C：≤75%相对湿度

+40°C至+50°C：≤45%相对湿度



#### 警告

为避免仪器内部电路短路或发生电击的危险，请勿在潮湿环境下操作仪器。

### 海拔高度

操作时：3000 米以下

非操作时：15000 米以下

### 安装（过电压）类别

本产品由符合安装（过电压）类别 II 的主电源供电。



#### 警告

确保没有过电压（如由雷电造成的电压）到达该产品。否则操作人员可能有遭受电击的危险。

### 安装（过电压）类别定义

安装（过电压）类别 I 是指信号电平，其适用于连接到源电路中的设备测量端子，其中已经采取措施，把瞬时电压限定在相应的低水平。

安装（过电压）类别 II 是指本地配电电平，其适用于连接到市电（交流电源）的设备。

### 污染程度

2 类

### 污染程度定义

污染度 1：无污染，或仅发生干燥的非传导性污染。此污染级别没有影响。例如：清洁的房间或有空调控制的办公环境。

污染度 2：一般只发生干燥非传导污染。有时可能发生由于冷凝而造成的暂时性传导。例如：一般室内环境。

污染度 3：发生传导性污染，或干燥的非传导性污染，由于冷凝而变为具有传导性。

例如：有遮棚的室外环境。

污染度 4：通过传导性的尘埃、雨水或雪产生永久的可导电性污染。

例如：户外场所。

## 安全级别

1 级 - 接地产品

## 保养与清洁

### 保养

请勿将仪器放置在长时间受到日照的地方。

### 清洁

请根据使用情况经常对仪器进行清洁。方法如下：

1. 断开电源。
2. 用柔和的清洁剂或清水浸湿软布擦拭仪器外部，请注意不要将水或其他异物通过散热孔进入机箱内。清洁带有液晶显示屏的仪器时，请注意不要划伤 LCD 显示屏。



#### 注意

请勿使任何腐蚀性的液体沾到仪器上，以免损坏仪器。



#### 警告

重新通电之前，请确认仪器已经干透，避免因水分造成电气短路甚至人身伤害。

## 环境注意事项

以下符号表明本产品符合 WEEE Directive 2002/96/EC 所制定的要求。



### 设备回收

本产品中包含的某些物质可能会对环境或人体健康有害，为避免将有害物质释放到环境中或危害人体健康，建议采用适当的方法回收本产品，以确保大部分材料可正确地重复使用或回收。有关处理或回收的信息，请与当地权威机构联系。

## 文档概述

本文档用于指导用户快速了解MSO2000A/DS2000A系列数字示波器的前后面板、用户界面及基本操作方法。您可登录**RIGOL**网站（[www.rigol.com](http://www.rigol.com)）下载所需文档的最新版本。

### 文档格式的约定：

#### 1. 按键

用“按键字符（加粗）+文本框”，表示前面板功能按键，如 **Utility** 表示“Utility”按键。





#### 2. 菜单

用“菜单文字（加粗）+字符底纹”，表示一个菜单选项，如 **系统** 表示 **Utility** 按键下“系统”菜单选项。

#### 3. 操作步骤

用箭头“→”表示下一步操作，例如：**Utility** → **系统** 表示按下前面板上的 **Utility** 功能键后，再按 **系统** 菜单键。

#### 4. 旋钮

| 标识   | 旋钮     | 标识   | 旋钮       |
|--|--------|--|----------|
| 水平  <b>SCALE</b>     | 水平档位旋钮 | 垂直  <b>SCALE</b>     | 通道垂直档位旋钮 |
| 水平  <b>POSITION</b> | 水平位移旋钮 | 垂直  <b>POSITION</b> | 通道垂直位移旋钮 |
| 触发  <b>LEVEL</b>    | 触发电平旋钮 | ——   | ——       |

### 文档内容的约定：

MSO2000A/DS2000A 系列包含以下型号，本手册以 MSO2302A-S 为例说明 MSO2000A/DS2000A 系列的功能和操作方法。

| 型号               | 模拟带宽    | 通道数 | 信号源通道数 |
|------------------|---------|-----|--------|
| MSO2102A/DS2102A | 100 MHz | 2   | ——     |
| MSO2102A-S       | 100 MHz | 2   | 2      |
| MSO2202A/DS2202A | 200 MHz | 2   | ——     |
| MSO2202A-S       | 200 MHz | 2   | 2      |
| MSO2302A/DS2302A | 300 MHz | 2   | ——     |
| MSO2302A-S       | 300 MHz | 2   | 2      |

# 目录

|               |           |
|---------------|-----------|
| 保证和声明.....    | <b>I</b>  |
| 安全要求.....     | <b>II</b> |
| 一般安全概要.....   | II        |
| 安全术语和符号.....  | II        |
| 测量类别.....     | III       |
| 通风要求.....     | III       |
| 工作环境.....     | IV        |
| 保养与清洁.....    | V         |
| 环境注意事项.....   | V         |
| 文档概述.....     | <b>VI</b> |
| 快速入门.....     | <b>1</b>  |
| 一般性检查.....    | 1         |
| 外观尺寸.....     | 2         |
| 使用前准备.....    | 3         |
| 调节支撑脚.....    | 3         |
| 连接电源.....     | 3         |
| 开机检查.....     | 4         |
| 连接探头.....     | 4         |
| 功能检查.....     | 6         |
| 探头补偿.....     | 7         |
| 前面板总览.....    | 8         |
| 后面板总览.....    | 9         |
| 前面板功能概述.....  | 11        |
| 垂直控制.....     | 11        |
| 水平控制.....     | 12        |
| 触发控制.....     | 12        |
| 全部清除.....     | 13        |
| 运行控制.....     | 13        |
| 单次触发.....     | 13        |
| 波形自动显示.....   | 13        |
| 多功能旋钮.....    | 14        |
| 导航旋钮.....     | 14        |
| 功能菜单.....     | 15        |
| 信号源.....      | 15        |
| 波形录制.....     | 16        |
| 打印.....       | 16        |
| 逻辑分析仪.....    | 16        |
| 用户界面.....     | 17        |
| 使用安全锁.....    | 21        |
| 使用内置帮助系统..... | 22        |
| 故障处理.....     | <b>23</b> |





---

# 快速入门

## 一般性检查

### 1. 检查运输包装

如运输包装已损坏，请保留被损坏的包装或防震材料，直到货物经过完全检查且仪器通过电性和机械测试。

因运输造成仪器损坏，由发货方和承运方联系赔偿事宜。**RIGOL**公司恕不进行免费维修或更换。

### 2. 检查整机

若存在机械损坏或缺失，或者仪器未通过电性和机械测试，请联系您的 **RIGOL** 经销商。

### 3. 检查随机附件

请根据装箱单检查随机附件，如有损坏或缺失，请联系您的**RIGOL**经销商。

# 外观尺寸



图 1 正视图

单位: mm

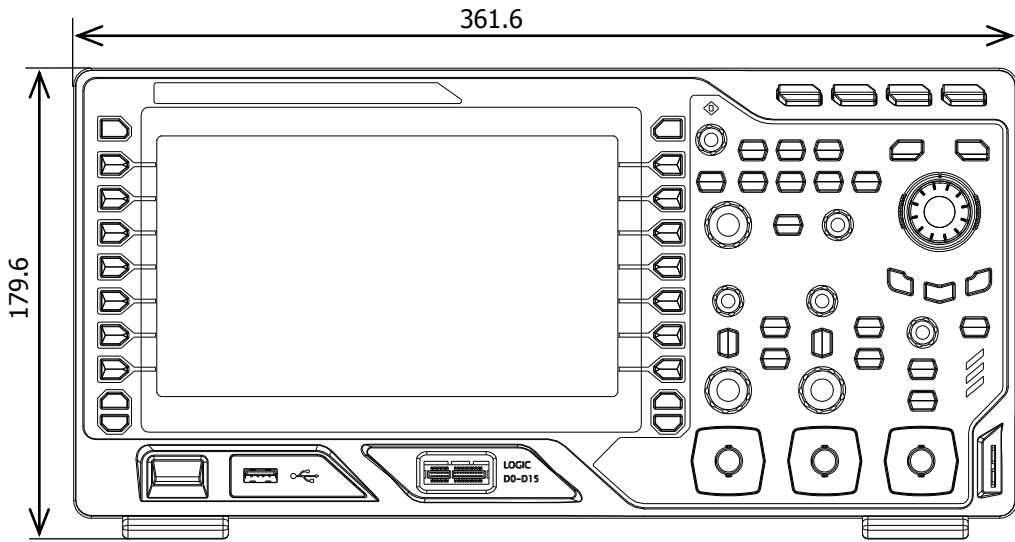

图 2 俯视图

单位: mm

## 使用前准备

### 调节支撑脚

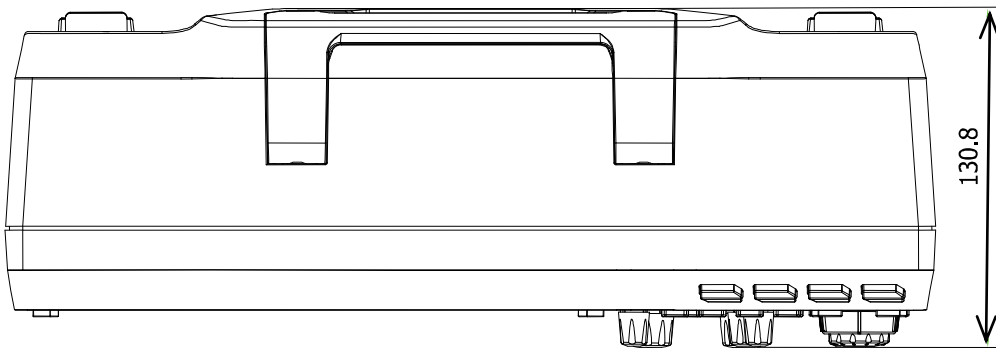
适当调整支撑脚，将其作为支架使示波器向上倾斜，以稳定放置示波器，便于更好地操作和观察显示屏。





图 3 调节支撑脚

### 连接电源

本示波器可输入的交流电源规格为：100-240 V，45-440 Hz。请使用附件提供的电源线如下图所示将示波器连接至 AC 电源。示波器处于通电状态时，前面板左下角的电源键  呈呼吸状态。

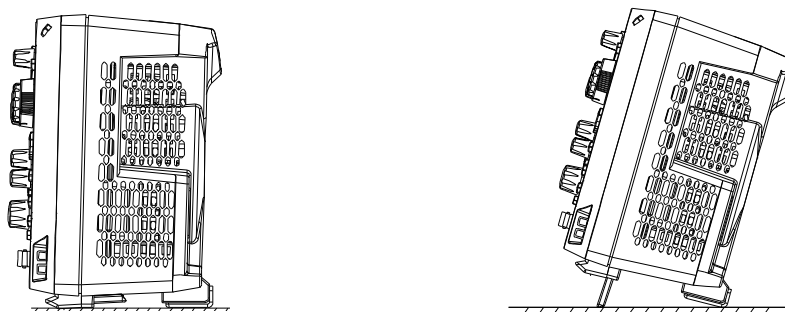



图 4 连接电源

## 开机检查

当示波器处于通电状态时，按前面板左下角的电源键  即可启动示波器。开机过程中示波器执行一系列自检，您可以听到继电器切换的声音。自检结束后出现开机画面。仪器出厂时我们为用户提供了选件的试用版本，剩余时间约为 2000 分钟。如果您的仪器当前安装了试用版本的选件，屏幕将弹出“当前选件”对话框，您可以查看当前安装的选件类型、选件名称、选件版本和剩余时间。

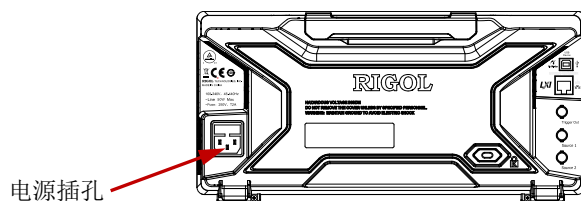
## 连接探头

**RIGOL** 为 DS2000A 提供无源探头，为 MSO2000A 提供无源探头和逻辑探头。探头的具体型号请参考《MSO2000A&DS2000A 系列数据手册》。有关探头的详细技术信息请参考相应的探头用户手册。

### 连接无源探头：

1. 将探头的 BNC 端连接至示波器前面板的模拟通道输入端。
2. 将探头接地鳄鱼夹或接地弹簧连接至电路接地端，然后将探针连接至待测电路测试点。



图 5 连接无源探头

连接无源探头后，您需要在测量前进行探头功能检查和探头补偿调节，具体步骤请参考本手册中“功能检查”和“探头补偿”一节介绍的内容。

### 连接逻辑探头：

1. 将逻辑探头单线端按正确的方向连接至 MSO2000A 系列数字示波器前面板的 **[LOGIC D0-D15]** 数字通道接口。
2. 将逻辑探头另一端连接至被测信号端。**RIGOL** 为 MSO2000A 标配 RPL2316 逻辑探头。为适应不同的应用场合，RPL2316 提供了三种连接被测信号的方法。具体请参考《RPL2316 逻辑探头用户手册》。

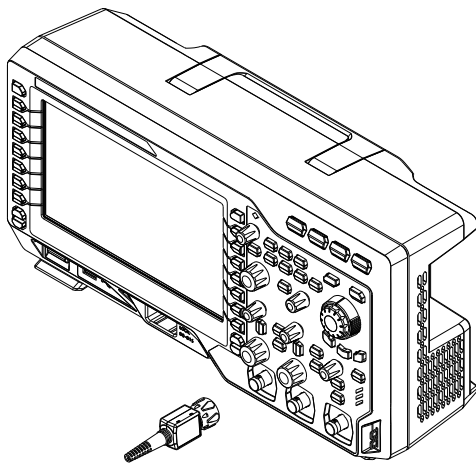

图 6 连接逻辑探头

**注意：**数字通道输入接口不支持热插拔，请勿在仪器带电的情况下插入或拔出逻辑探头。

## 功能检查

1. 按 **Storage** → **默认设置**，将示波器恢复为默认配置。
2. 将探头的接地鳄鱼夹连接至如下图所示的“接地端”。
3. 使用探头连接示波器的通道 1 (CH1) 输入端和“补偿信号输出端”。



图 7 使用补偿信号

4. 将探头衰减比设定为 10X，然后按 **AUTO** 键。
5. 观察示波器显示屏上的波形，正常情况下应显示下图所示的方波：

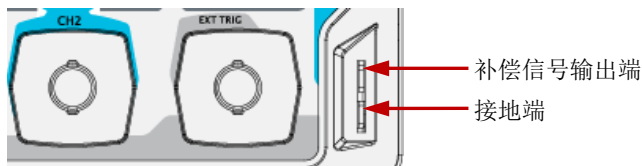

图 8 方波信号

6. 用同样方法检查其他通道。如实际显示的方波形状与上图不相符，请执行下一节“探头补偿”。

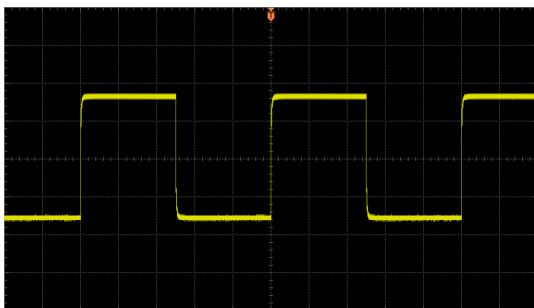

### 警告

为避免使用探头时被电击，请首先确保探头的绝缘导线完好，并且在连接高压源时不要接触探头的金属部分。

### 提示

探头补偿连接器上输出的信号仅作探头补偿调整之用，不可用于校准。

## 探头补偿

首次使用探头时，应进行探头补偿调节，使探头与示波器输入通道匹配。未经补偿或补偿偏差的探头会导致测量误差或错误。探头补偿步骤如下：

1. 执行上一节“功能检查”中的步骤 1、2、3 和 4。
2. 检查所显示的波形形状并与下图对比。



图 9 探头补偿

3. 用非金属质地的改锥调整探头上的低频补偿调节孔，直到显示的波形如上图“补偿正确”。

## 前面板总览

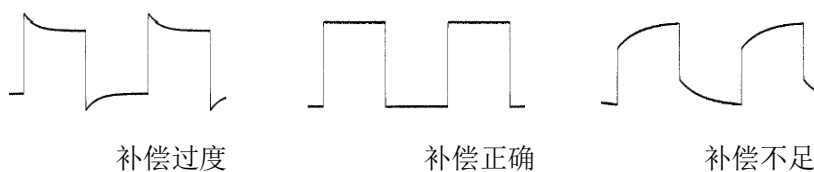

图 10 前面板总览

表 1 前面板总览

| 编号 | 说明                      | 编号 | 说明                      |
|----|-------------------------|----|-------------------------|
| 1  | 测量菜单软键                  | 13 | 电源键                     |
| 2  | LCD                     | 14 | USB HOST 接口             |
| 3  | 逻辑分析仪控制键 <sup>[1]</sup> | 15 | 数字通道输入接口 <sup>[1]</sup> |
| 4  | 多功能旋钮                   | 16 | 水平控制区                   |
| 5  | 功能菜单键                   | 17 | 功能菜单软键                  |
| 6  | 信号源 <sup>[2]</sup>      | 18 | 垂直控制区                   |
| 7  | 导航旋钮                    | 19 | 模拟通道输入区                 |
| 8  | 全部清除键                   | 20 | 波形录制/回放控制键              |
| 9  | 波形自动显示                  | 21 | 触发控制区                   |
| 10 | 运行/停止控制键                | 22 | 外触发输入端                  |
| 11 | 单次触发控制键                 | 23 | 探头补偿器输出端/接地端            |
| 12 | 内置帮助/打印键                | —— | ——                      |

注<sup>[1]</sup>: 仅适用于 MSO2000A 和 MSO2000A-S 型号的混合信号数字示波器。

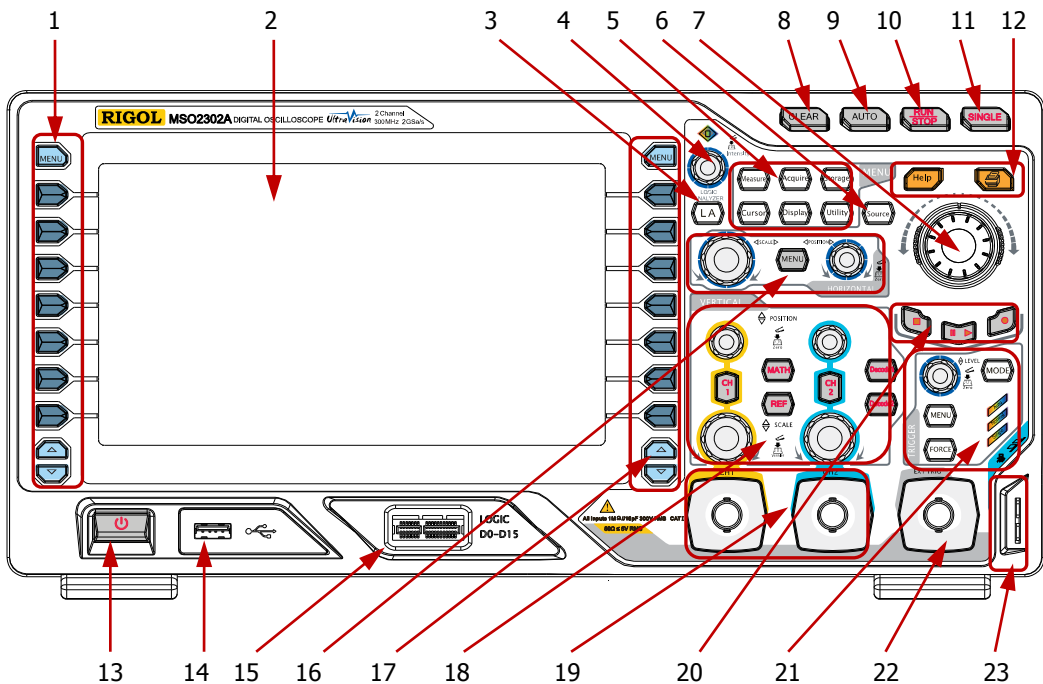
注<sup>[2]</sup>: 仅适用于 MSO2000A-S 型号的数字示波器。



## 后面板总览



图 11 后面板总览

### 1. 手柄

垂直拉起该手柄，可方便携提示波器。不需要时，向下轻按手柄即可。

### 2. LAN

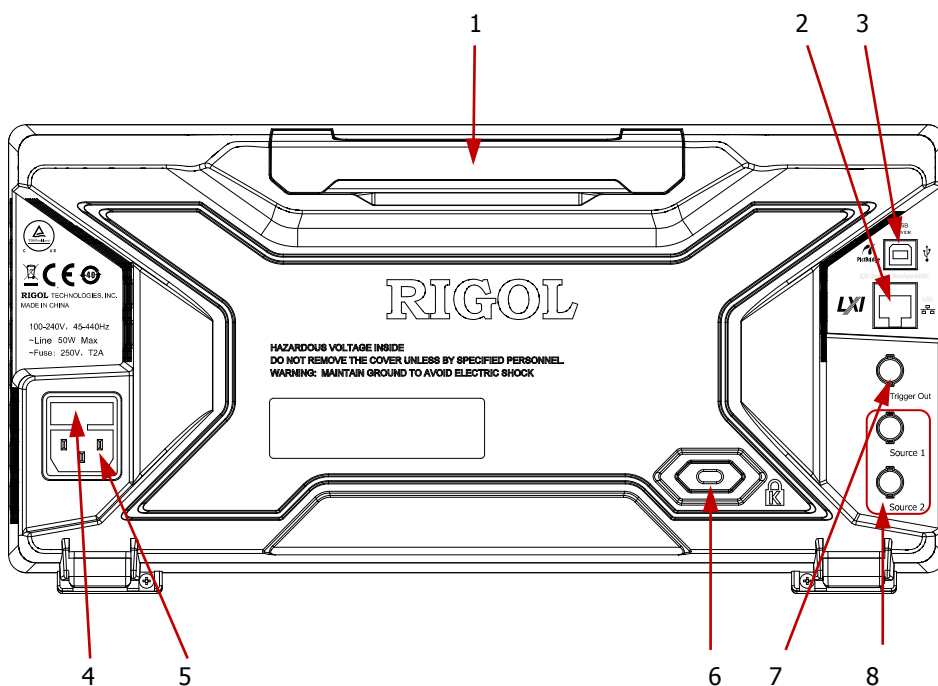
通过该接口将示波器连接到网络中，对其进行远程控制。本示波器符合 LXI CORE 2011 DEVICE 类仪器标准，可快速搭建测试系统。

### 3. USB DEVICE

通过该接口可连接 PictBridge 打印机以打印波形数据，或连接 PC，通过上位机软件对示波器进行控制。

### 4. 保险丝

如需更换保险丝，请使用符合规格的保险丝。本示波器的保险丝规格为 250V，T2A。更换方法为：

(1) 关闭仪器，拔出电源线。

(2) 使用小一字螺丝刀插入电源插口处的凹槽，轻轻撬出保险丝座。

(3) 取出保险丝，更换指定规格的保险丝，然后将保险丝座安装回原处。

## 5. AC 电源插孔

AC 电源输入端。本示波器的供电要求为 100-240 V，45-440 Hz。请使用附件提供的电源线将示波器连接至 AC 电源，按下前面板电源键即可开机。

## 6. 锁孔

可以使用安全锁（请用户自行购买）通过该锁孔将示波器锁定在固定位置。

## 7. 触发输出

当示波器产生一次触发时，可通过该接口输出一个反映示波器当前捕获率的信号，将该信号连接至波形显示设备，测量该信号的频率，测量结果与当前捕获率相同。该接口还可以在通过/失败测试中检测到失败波形时输出信号。

## 8. 信号源输出

当示波器中对应的源 1 开关或源 2 开关打开时，通过后面板**[Source1]**或**[Source2]**连接器可将当前设置的信号输出至示波器的模拟通道输入端或与其连接的外部设备。该功能仅适用于 MSO2000A-S 型号的示波器。

## 前面板功能概述

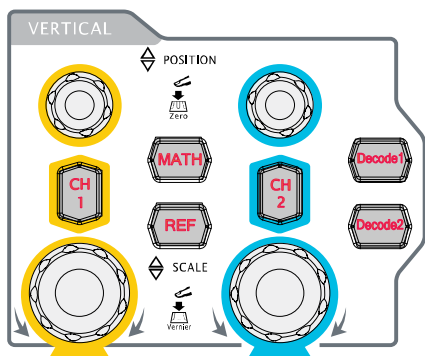

### 垂直控制





**CH1**、**CH2**: 模拟输入通道。2 个通道标签用不同颜色标识，并且屏幕中的波形和通道输入连接器的颜色也与之对应。按下任一按键打开相应通道菜单，再次按下关闭通道。

**MATH**: 按下该键打开数学运算菜单。可进行加、减、乘、除、FFT、逻辑、高级运算。

**REF**: 按下该键打开参考波形功能。可将实测波形和参考波形比较。

**垂直**  **POSITION**: 修改当前通道波形的垂直位移。顺时针转动增大位移，逆时针转动减小位移。修改过程中波形会上下移动，同时屏幕左下角弹出的位移信息（如 ）实时变化。按下该旋钮可快速将垂直位移归零。

**垂直**  **SCALE**: 修改当前通道的垂直档位。顺时针转动减小档位，逆时针转动增大档位。修改过程中波形显示幅度会增大或减小，实际幅度保持不变，同时屏幕下方的档位信息（如 ）实时变化。按下该旋钮可快速切换垂直档位调节方式为“粗调”或“微调”。

**Decode1**、**Decode2**: 解码功能按键。按下相应的按键打开解码功能菜单。MSO2000A/DS2000A 支持并行解码和协议解码。

## 水平控制

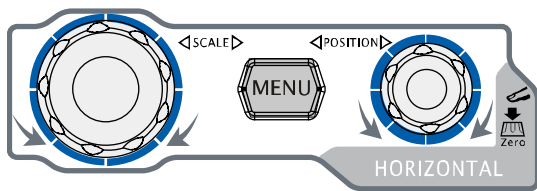

**MENU**: 按下该键打开水平控制菜单。可开关延迟扫描功能，切换不同的时基模式，切换档位的微调或粗调，以及修改水平参考设置。

**水平 SCALE**: 修改水平时基。顺时针转动减小时基，逆时针转动增大时基。修改过程中，所有通道的波形被扩展或压缩显示，同时屏幕上方的时基信息（如 **5.000ns**）实时变化。按下该旋钮可快速切换至延迟扫描状态。

**水平 POSITION**: 修改水平位移。转动旋钮时触发点相对屏幕中心左右移动。修改过程中，所有通道的波形左右移动，同时屏幕右上角的触发位移信息（如 **5.8000000ns**）实时变化。按下该旋钮可快速复位触发位移（或延迟扫描位移）。

## 触发控制

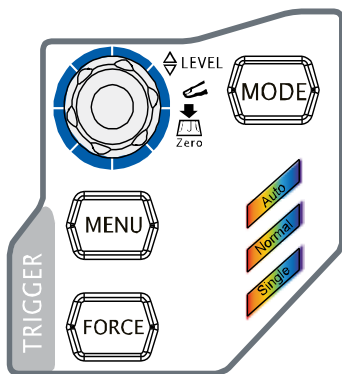

**MODE**: 按下该键切换触发方式为 **Auto**、**Normal** 或 **Single**，当前触发方式对应的状态背灯会变亮。

**触发 LEVEL**: 修改触发电平。顺时针转动增大电平，逆时针转动减小电平。修改过程中，触发电平线上下移动，同时屏幕左下角的触发电平消息框（如 **Trig Level: 1.88 V**）中的值实时变化。按下该旋钮可快速将触发电平恢复至零点。

**MENU**: 按下该键打开触发操作菜单。本示波器提供丰富的触发类型。

**FORCE**: 在 **Normal** 和 **Single** 触发方式下，按下该键将强制产生一个触发信号。

## 全部清除



按下该键清除屏幕上所有的波形。如果示波器处于“运行”状态，则继续显示新波形。

## 运行控制



按下该键将示波器的运行状态设置为“运行”或“停止”。  
“运行”状态下，该键黄色背灯点亮。  
“停止”状态下，该键红色背灯点亮。

## 单次触发



按下该键将示波器的触发方式设置为“Single”，该键橙色背灯点亮。单次触发方式下，按 **FORCE** 键立即产生一个触发信号。

## 波形自动显示



按下该键启用波形自动设置功能。示波器将根据输入信号自动调整垂直档位、水平时基以及触发方式，使波形显示达到最佳状态。**注意：**在实际检测中，应用自动设置时，要求被测信号的频率不小于 25 Hz，如果不满足此参数范围，按下该键后可能会弹出“未检测到任何信号！”消息框，而且用户界面可能不显示快速参数测量菜单。

## 多功能旋钮



### 调节波形亮度：

非菜单操作时（菜单隐藏），转动该旋钮可调整波形显示的亮度。亮度可调节范围为 0%至 100%。顺时针转动增大波形亮度，逆时针转动减小波形亮度。按下旋钮将波形亮度恢复至 50%。

也可按 **Display** → **波形亮度**，使用该旋钮调节波形亮度。

### 多功能：（操作时，背灯变亮）

菜单操作时，按下某个菜单软键后，转动该旋钮可选择该菜单下的子菜单，然后按下旋钮可选中当前选择的子菜单。该旋钮还可以用于修改参数、输入文件名等。此外，对于 MSO2000A-S 型号的示波器，当前操作界面为信号源时，按下对应的菜单键后，按下该旋钮，将弹出数字键盘，使用该旋钮可以直接输入所需要的数值值及其单位。

## 导航旋钮

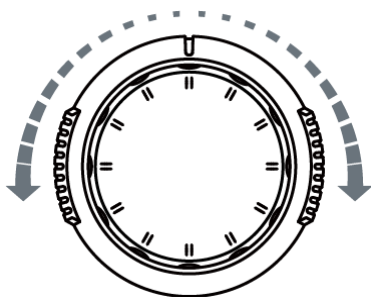

对于某些可设置范围较大的数值参数，该旋钮提供了快速调节/定位的功能。顺时针（逆时针）旋转增大（减小）数值；内层旋钮可微调，外层旋钮可粗调。例如，在回放波形时，使用该旋钮可以快速定位需要回放的波形帧（“当前帧”菜单）。类似的菜单还有：触发释抑、脉宽设置、斜率时间等。

## 功能菜单

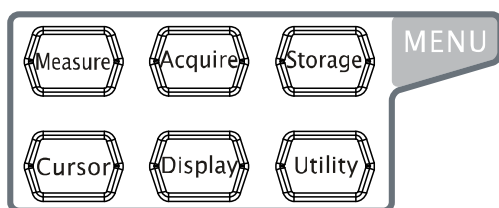

**Measure**: 按下该键进入测量设置菜单。可设置测量设置、全部测量、统计功能等。按下屏幕左侧的 **MENU**，可打开 29 种波形参数测量菜单，然后按下相应的菜单软键快速实现“一键”测量，测量结果将出现在屏幕底部。

**Acquire**: 按下该键进入采样设置菜单。可设置示波器的获取方式、存储深度和抗混叠功能。

**Storage**: 按下该键进入文件存储和调用界面。可存储的文件类型包括：轨迹存储、波形存储、设置存储、图像存储和 CSV 存储，图像可存储为 bmp、png、jpeg、tiff 格式。同时支持内、外部存储和磁盘管理。

**Cursor**: 按下该键进入光标测量菜单。示波器提供手动、追踪、自动测量和 X-Y 四种光标模式。**注意**：X-Y 光标模式仅在水平时基为 X-Y 模式时可用。

**Display**: 按下该键进入显示设置菜单。设置波形显示类型、余辉时间、波形亮度、屏幕网格、网格亮度和菜单保持时间。

**Utility**: 按下该键进入系统辅助功能设置菜单。设置系统相关功能或参数，例如接口、声音、语言等。此外，还支持一些高级功能，例如通过/失败测试、波形录制和打印设置等。

## 信号源



按下该键进入信号源设置界面，您可以打开或关闭后面板 **[Source1]**或**[Source2]**连接器的输出，设置输出信号的参数，如频率、幅度、偏移和相位等。

**注意**：该功能仅适用于 MSO2000A-S 型号的示波器。

## 波形录制

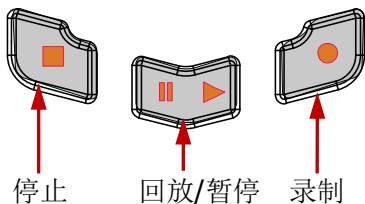

**录制:** 按下该键开始波形录制，同时该键红色背灯开始闪烁。此外，打开录制常开模式时，该键红色背灯也不停闪烁。

**回放/暂停:** 在停止或暂停的状态下，按下该键回放波形，再次按下该键暂停回放，按键背灯为黄色。

**停止:** 按下该键停止正在录制或回放的波形，该键橙色背灯点亮。

## 打印



按下该键执行打印功能或将屏幕保存到 U 盘中。若当前已连接 PictBridge 打印机，并且打印机处于闲置状态，按下该键将执行打印功能。若当前未连接打印机，但连接 U 盘，按下该键则屏幕图形默认以 “.png” 格式保存到 U 盘中。也可以按 **Storage** 键选择存储类型为图像存储，再按 **图片格式** 软键，将屏幕图形以指定的图片格式（bmp、png、jpeg 和 tiff）保存。同时连接打印机和 U 盘时，打印机优先级较高。

## 逻辑分析仪



按下该键打开逻辑分析仪控制菜单。您可以打开或关闭任意通道或通道组、更改数字通道的显示大小、更改数字通道的逻辑阈值、对 16 个数字通道进行分组并将其显示为总线。您还可以为每一个数字通道设置标签。

**注意:** 该功能仅适用于 MSO2000A 和 MSO2000A-S 型号的示波器。



## 用户界面

MSO2000A/DS2000A 系列数字示波器提供 8.0 英寸 WVGA(800\*480)160,000 色 TFT LCD。值得一提的是，14 格超宽的屏幕可让您观察到更“长”时间的波形。



图 12 用户界面

### 1. 自动测量选项

提供 16 种水平（HORIZONTAL）和 13 种垂直（VERTICAL）测量参数。按下屏幕左侧的测量菜单软键即可打开相应的测量项，连续按下 **MENU** 键，可切换水平和垂直测量参数。

### 2. 数字通道标记/波形

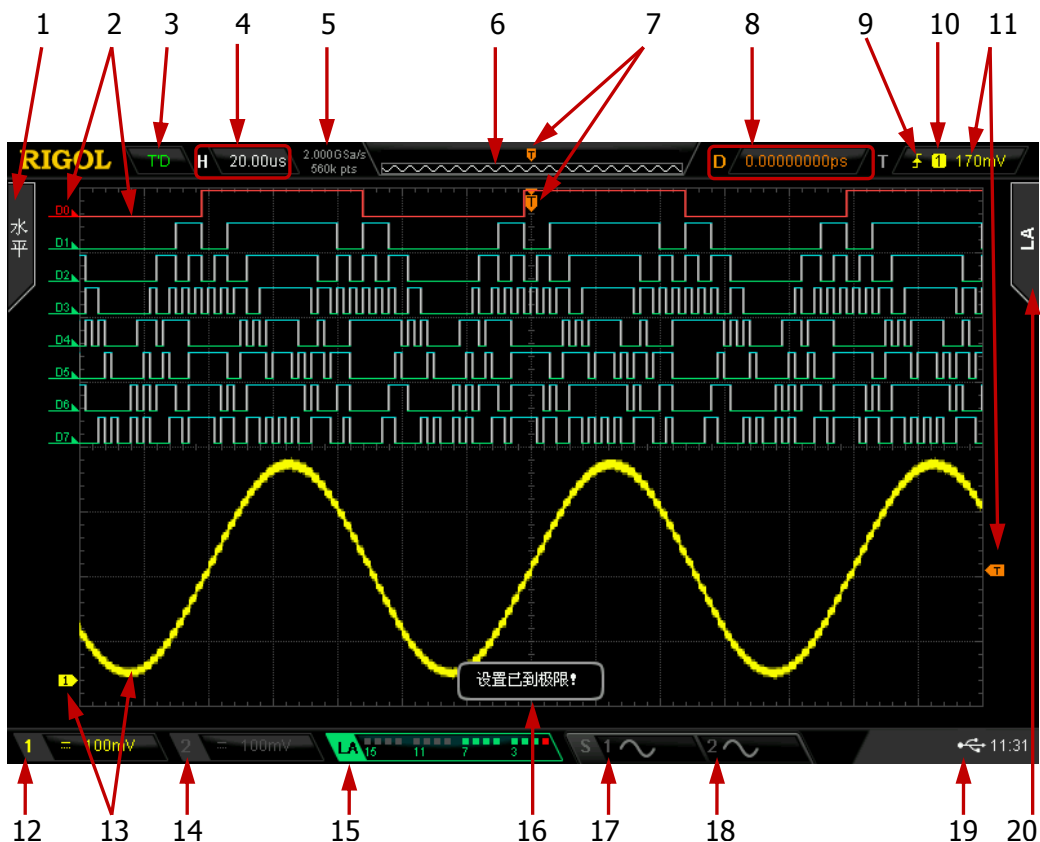
数字波形的逻辑高电平显示为蓝色，逻辑低电平显示为绿色（与通道标记颜色一致），边沿呈白色。当前选中的数字通道标记和波形均显示为红色。**注意：**该功能仅适用于 MSO2000A 和 MSO2000A-S 型号的示波器。

### 3. 运行状态

可能的状态包括：RUN（运行）、STOP（停止）、T'D（已触发）、WAIT（等待）和 AUTO（自动）。

### 4. 水平时基

- 表示屏幕水平轴上每格所代表的时间长度。
- 使用水平  **SCALE** 可以修改该参数，可设置范围为 1.000 ns 至 1.000 ks（对于 200 MHz 带宽的示波器，该范围为 2.000 ns 至 1.000 ks；对于 100 MHz 和 70 MHz 带宽的示波器，该范围为 5.000 ns 至 1.000 ks）。

### 5. 采样率/存储深度

- 显示当前示波器使用的采样率以及存储深度。
- 使用水平  **SCALE** 可以修改该参数。

### 6. 波形存储器

提供当前屏幕中的波形在存储器中的位置示意图。

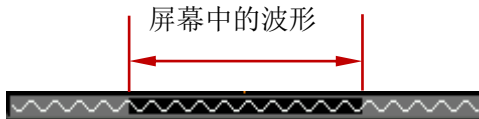

### 7. 触发位置

显示波形存储器和屏幕中波形的触发位置。

### 8. 水平位移

使用水平  **POSITION** 可以调节该参数。按下旋钮时参数自动设置为 0。

### 9. 触发类型





显示当前选择的触发类型及触发条件设置。选择不同触发类型时显示不同的标识。例如， 表示在“边沿触发”的上升沿处触发。

### 10. 触发源





显示当前选择的触发源（CH1、CH2、EXT、EXT/5、市电或 D0-D15）。选择不同触发源时，显示不同的标识，并改变触发参数区的颜色。

例如， 表示选择 CH1 作为触发源。**注意：**触发源 EXT/5 仅适用于 MSO2000A 和 MSO2000A-S 型号的示波器。

## 11. 触发电平

- 触发信源选择 CH1 或 CH2 时，屏幕右侧将出现触发电平标记 ，右上角为触发电平值。使用触发  **LEVEL** 修改触发电平时，触发电平值会随  的上下移动而改变。
- 触发信源选择 EXT 或 EXT/5 时，右上角为触发电平值，无触发电平标记。
- 触发信源选择市电时，无触发电平值和触发电平标记。
- 触发信源选择 D0 至 D15 时，右上角为触发阈值，无触发电平标记。
- 欠幅脉冲触发、斜率触发和超幅触发时，有两个触发电平标记 ( 和  )。





## 12. CH1 垂直档位

- 显示屏幕垂直方向 CH1 每格波形所代表的电压大小。
- 使用 CH1 的垂直  **SCALE** 可以修改该参数。
- 此外还会根据当前的通道设置给出如下标记：通道耦合（如 ）、输入阻抗（如 ）、带宽限制（如 ）。

## 13. 模拟通道标记/波形

不同通道用不同的颜色表示，通道标记和波形的颜色一致。

## 14. CH2 垂直档位

- 显示屏幕垂直方向 CH2 每格波形所代表的电压大小。
- 使用 CH2 的垂直  **SCALE** 可以修改该参数。
- 此外还会根据当前的通道设置给出如下标记：通道耦合（如 ）、输入阻抗（如 ）、带宽限制（如 ）。



## 15. 数字通道状态区

显示 16 个数字通道当前的状态。从右至左依次为 D0 至 D15，当前打开的数字通道显示为绿色，当前选中的数字通道突出显示为红色。在数字通道活动区中任何已关闭的数字通道均显示为灰色。**注意：**该功能仅适用于 MSO2000A 和 MSO2000A-S 型号的示波器。

## 16. 消息框



显示提示信息。

## 17. 源 1 波形

- 显示当前源 1 设置中的波形类型。
- 当源 1 的阻抗设置为 50  $\Omega$  时，源 1 波形的右边会显示  标识。
- 当源 1 的调制打开时，源 1 波形的右边会显示  标识。

- 仅适用于 MSO2000A-S 型号的示波器。

## 18. 源 2 波形

- 显示当前源 2 设置中的波形类型。
- 当源 2 的阻抗设置为 50 Ω 时，源 2 波形的右边会显示  标识。
- 当源 2 的调制打开时，源 2 波形的右边会显示  标识。
- 仅适用于 MSO2000A-S 型号的示波器。



















## 19. 通知区域

显示系统时间、声音图标和 U 盘图标。



- 系统时间：以“hh:mm（时:分）”的格式显示。在打印或存储波形时，输出文件将包含该时间信息。按 **Utility** → **系统** → **系统时间** → **系统时间**，通过下面格式设置：  
yyyy-mm-dd hh:mm:ss (年-月-日 时:分:秒)
- 声音图标：声音打开时，该区域显示 。按 **Utility** → **声音** 可以打开或关闭声音。
- U 盘图标：当示波器检测到 U 盘时，该区域显示 。

## 20. 操作菜单

按下任一软键可激活相应的菜单。下面的符号可能显示在菜单中：

-  表示可以用前面板上的多功能旋钮  选择参数项。 的背灯在参数选择有效时变亮。
-  表示可以用  修改参数值。 的背灯在参数输入有效时变亮。
-  表示可以用  修改参数值并且按下  将弹出数字键盘，可直接输入所需的参数值。 的背灯在参数输入有效时变亮。
-  表示可以用“**导航旋钮**”快速调节/定位参数。
-  表示使用  调节参数，然后按下  选中参数。 的背灯在此状态下常亮。
-  表示当前菜单有若干选项。
-  表示当前菜单有下一层菜单。
-  按下该键可以返回上一级菜单。

**注意：**操作菜单左下角的网格中也可能出现下面的方向键：

-  表示可以打开下一页菜单。
-  表示可以打开上一页菜单。

## 使用安全锁

如有必要，您可以使用安全锁（请自行购买）将示波器锁在固定位置。方法如下，沿与后面板垂直的方向对准锁孔将锁头插入，顺时针旋转钥匙锁定示波器，然后拔出钥匙。



图 13 使用安全锁

**注意：**请勿将其它物品插入安全锁孔以免损坏仪器。

## 使用内置帮助系统

本示波器的帮助系统提供了前面板各功能键（包括菜单键）的说明。按 **Help** 键打开帮助界面，再次按下则关闭。帮助界面主要分两部分，左边为“帮助选项”，可使用“Button”或“Index”方式选择，右边为“帮助显示区”。

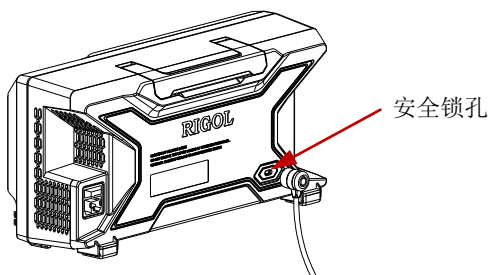







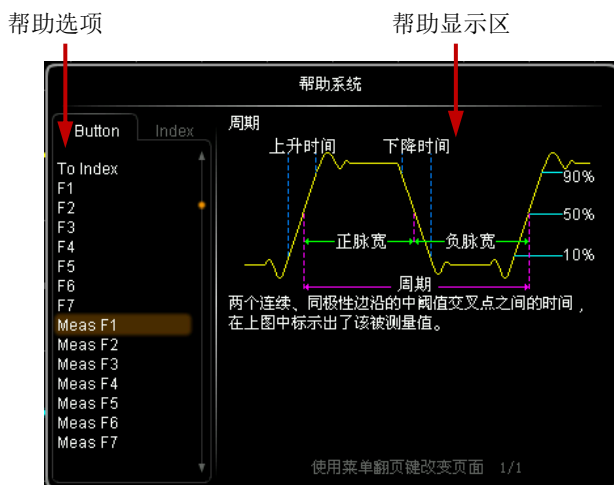

图 14 帮助信息

### Button:

默认方式。该方式下，您可以直接按面板上的按键（电源键  和屏幕右侧功能菜单翻页键  除外），或者旋转多功能旋钮  选择按键名称，即可在“帮助显示区”中获得相应的帮助信息。此外，直接旋转导航旋钮或使用  选中“WaveSearch”项，即可获取导航旋钮的帮助信息。旋转  选择“To Index”后按下旋钮可切换到 **Index** 方式。

### Index:

该方式下，使用  选择需要获得帮助的选项（例如“带宽限制”），当前选中的选项显示为棕色，按下旋钮，即可在“帮助显示区”中获得相应的帮助信息。使用  选择“To Button”后按下旋钮可切换到 **Button** 方式。

## 故障处理

下面列举了示波器在使用过程中可能出现的故障及排查方法。当您遇到这些故障时，请按照相应的步骤进行处理，如不能处理，请与 **RIGOL** 联系，同时请提供您机器的设备信息（获取方法：**Utility** → **系统** → **系统信息**）。

### 1. 如果按下电源键示波器仍然黑屏，没有任何显示：

- (1) 检查电源开关是否打开。
- (2) 检查电源接头是否接好。
- (3) 检查保险丝是否熔断。如需更换保险丝，请使用符合本产品规格的保险丝。
- (4) 做完上述检查后，重新启动仪器。
- (5) 如果仍然无法正常使用本产品，请与 **RIGOL** 联系。

### 2. 采集信号后，画面中并未出现信号的波形：

- (1) 检查探头是否与待测物正常连接。
- (2) 检查待测物是否有信号产生（可将探头补偿输出信号连接到有问题的通道确定是通道还是待测物的问题）。
- (3) 再重新采集信号一次。

### 3. 测量的电压幅度值比实际值大或者小（**注意**：此处一般在使用探头时才会出现）： 检查通道的探头比设置是否与实际使用的探头衰减比例相符。

### 4. 有波形显示，但不能稳定下来：

- (1) 检查触发信源：按前面板触发控制区（TRIGGER）的 **MENU** → **信源选择**，确认所选的触发信源是否与实际使用的信号通道相符。
- (2) 检查触发类型：一般的信号应使用“边沿触发”方式，视频信号应使用“视频触发”方式。只有应用适合的触发方式，波形才能稳定显示。
- (3) 检查触发电平：将触发电平调整至信号的中间位置。
- (4) 改变触发释抑设置。

### 5. 按下 **RUN/STOP** 键无任何显示：

检查前面板触发控制区（TRIGGER），确认触发方式是否为“普通”或“单次”档，且触发电平是否超出波形范围。如果是，将触发电平居中或者按 **MODE** 将触发方式设置为“自动”档。

**注**：使用自动设置 **AUTO** 按钮可自动完成以上设置。

**6. 波形显示呈阶梯状:**

- (1) 水平时基档位可能过低，增大水平时基以提高水平分辨率，可以改善显示。
- (2) 若显示类型为“矢量”，采样点间的连线，可能造成波形阶梯状显示。按 **Display** → **显示类型**，设置为“点”显示方式，即可解决。

**7. 通过 USB 连接 PC 或 PictBridge 打印机失败:**

- (1) 按 **Utility** → **接口设置** → **USB 设备**，检查当前设置是否与当前连接的设备匹配。
- (2) 检查 USB 数据线是否与示波器和 PC 连接正常。
- (3) 检查 USB 数据线是否完好，必要时重启示波器。

**8. U 盘不能被识别:**

- (1) 检查 U 盘是否可以正常工作。
- (2) 确认使用的为 Flash 型 U 盘，本仪器不支持 USB3.0 的 U 盘和硬盘型 U 盘。
- (3) 确认使用的 U 盘容量是否过大，本示波器推荐使用不超过 8 GBytes 的 U 盘。
- (4) 重新启动仪器后，再插入 U 盘设备进行检查。
- (5) 如果仍然无法正常使用 U 盘，请与 **RIGOL** 联系。