

R&S[®]SMCVB-K163

DVB-T

User Manual



1179099702
Version 03

ROHDE & SCHWARZ
Make ideas real



This document describes the following software options:

- R&S®SMCVB-K163 DVB-T (1434.3877.xx)

This manual describes firmware version FW 4.90.002.xx and later of the R&S®SMCV100B.

© 2021 Rohde & Schwarz GmbH & Co. KG

Mühlhofstr. 15, 81671 München, Germany

Phone: +49 89 41 29 - 0

Email: info@rohde-schwarz.com

Internet: www.rohde-schwarz.com

Subject to change – data without tolerance limits is not binding.

R&S® is a registered trademark of Rohde & Schwarz GmbH & Co. KG.

Trade names are trademarks of the owners.

1179.0997.02 | Version 03 | R&S®SMCVB-K163

The following abbreviations are used throughout this manual: R&S®SMCV100B is abbreviated as R&S SMCVB, R&S®WinIQSIM2 is abbreviated as R&S WinIQSIM2

Contents

1	Welcome to the DVB-T Option.....	5
1.1	Accessing the DVB-T Dialog.....	5
1.2	Documentation Overview.....	5
1.2.1	Getting Started Manual.....	5
1.2.2	User Manuals and Help.....	6
1.2.3	Service Manual.....	6
1.2.4	Instrument Security Procedures.....	6
1.2.5	Printed Safety Instructions.....	6
1.2.6	Data Sheets and Brochures.....	6
1.2.7	Release Notes and Open Source Acknowledgment (OSA).....	7
1.2.8	Application Notes, Application Cards, White Papers, etc.....	7
1.3	Scope.....	7
1.4	Notes on Screenshots.....	7
2	About the DVB-T Option.....	9
2.1	Required Options.....	9
2.2	About DVB-H/T.....	9
3	DVB-T Configuration and Settings.....	11
3.1	General Settings.....	11
3.2	Input Signal Settings.....	13
3.2.1	General Settings.....	13
3.2.2	Info.....	17
3.2.3	Test Signal Settings.....	19
3.2.4	IP Channel x Settings.....	20
3.3	Coding Settings.....	24
3.4	TPS Settings.....	27
3.5	Special Settings.....	30
3.6	Global Connector Settings.....	31
3.7	TS Player.....	31
3.7.1	TS Player Settings.....	33
3.7.2	Player Output Settings.....	36
3.7.2.1	General Settings.....	36

3.7.2.2	Stuffing Settings.....	38
3.7.3	Seamless Loop Settings.....	39
3.8	Local IP Data Network Settings.....	41
4	Performing DVB-T Signal Generation Tasks.....	44
4.1	Configuring the Input Signal.....	44
4.1.1	How to Apply an External IP Input Signal.....	44
4.1.2	How to Apply an External TS Input Signal.....	47
4.1.3	How to Generate an Internal TS Signal.....	48
4.2	Monitoring the Input Signal.....	49
4.2.1	How to Monitor External IP Input Data.....	49
4.2.2	How to Monitor an External TS Input Signal.....	50
4.2.3	How to Monitor an Internal TS Player Signal.....	50
4.3	Calculating the Input Data Rate.....	50
5	Remote-Control Commands.....	52
5.1	General Commands.....	53
5.2	Input Commands.....	55
5.2.1	General Commands.....	55
5.2.2	Info Commands.....	58
5.2.3	Test Signal Commands.....	61
5.2.4	IP Subsystem.....	63
5.3	Coding Commands.....	66
5.4	TPS Commands.....	69
5.5	Special Commands.....	71
5.6	TSGen Subsystem.....	72
5.7	BCIP Subsystem.....	80
	Glossary: Abbreviations.....	83
	Glossary: Specifications.....	85
	List of commands.....	86
	Index.....	88

1 Welcome to the DVB-T Option

The R&S SMCVB-K163 is a firmware application that adds functionality to generate signals in accordance with the DVB-T digital standard.

The R&S SMCVB-K163 option features:

- DVB-T signal generation

This user manual contains a description of the functionality that the application provides, including remote control operation.

All functions not discussed in this manual are the same as in the base unit and are described in the R&S SMCV100B user manual. The latest version is available at:

www.rohde-schwarz.com/manual/SMCV100B

Installation

You can find detailed installation instructions in the delivery of the option or in the R&S SMCV100B service manual.

1.1 Accessing the DVB-T Dialog

To open the dialog with DVB-T settings

- ▶ In the block diagram of the R&S SMCV100B, select "Baseband > DVB-T".

A dialog box opens that displays the provided general settings.

The signal generation is not started immediately. To start signal generation with the default settings, select "State > On".

1.2 Documentation Overview

This section provides an overview of the R&S SMCV100B user documentation. Unless specified otherwise, you find the documents on the R&S SMCV100B product page at:

www.rohde-schwarz.com/manual/smcv100b

1.2.1 Getting Started Manual

Introduces the R&S SMCV100B and describes how to set up and start working with the product. Includes basic operations, typical measurement examples, and general information, e.g. safety instructions, etc. A printed version is delivered with the instrument.

1.2.2 User Manuals and Help

Separate manuals for the base unit and the software options are provided for download:

- **Base unit manual**
Contains the description of all instrument modes and functions. It also provides an introduction to remote control, a complete description of the remote control commands with programming examples, and information on maintenance, instrument interfaces and error messages. Includes the contents of the getting started manual.
- **Software option manual**
Contains the description of the specific functions of an option. Basic information on operating the R&S SMCV100B is not included.

The contents of the user manuals are available as help in the R&S SMCV100B. The help offers quick, context-sensitive access to the complete information for the base unit and the software options.

All user manuals are also available for download or for immediate display on the Internet.

1.2.3 Service Manual

Describes the performance test for checking compliance with rated specifications, firmware update, troubleshooting, adjustments, installing options and maintenance.

The service manual is available for registered users on the global Rohde & Schwarz information system (GLORIS):

<https://gloris.rohde-schwarz.com>

1.2.4 Instrument Security Procedures

Deals with security issues when working with the R&S SMCV100B in secure areas. It is available for download on the Internet.

1.2.5 Printed Safety Instructions

Provides safety information in many languages. The printed document is delivered with the product.

1.2.6 Data Sheets and Brochures

The data sheet contains the technical specifications of the R&S SMCV100B. It also lists the options and their order numbers and optional accessories.

The brochure provides an overview of the instrument and deals with the specific characteristics.

See www.rohde-schwarz.com/brochure-datasheet/smcv100b

1.2.7 Release Notes and Open Source Acknowledgment (OSA)

The release notes list new features, improvements and known issues of the current firmware version, and describe the firmware installation.

The open-source acknowledgment document provides verbatim license texts of the used open source software.

See www.rohde-schwarz.com/firmware/smcv100b

1.2.8 Application Notes, Application Cards, White Papers, etc.

These documents deal with special applications or background information on particular topics.

See www.rohde-schwarz.com/application/smcv100b

1.3 Scope



Tasks (in manual or remote operation) that are also performed in the base unit in the same way are not described here.

In particular, it includes:

- Managing settings and data lists, like saving and loading settings, creating and accessing data lists, or accessing files in a particular directory.
- Information on regular trigger, marker and clock signals and filter settings, if appropriate.
- General instrument configuration, such as checking the system configuration, configuring networks and remote operation
- Using the common status registers

For a description of such tasks, see the R&S SMCV100B user manual.

1.4 Notes on Screenshots

When describing the functions of the product, we use sample screenshots. These screenshots are meant to illustrate as many as possible of the provided functions and possible interdependencies between parameters. The shown values may not represent realistic usage scenarios.

The screenshots usually show a fully equipped product, that is: with all options installed. Thus, some functions shown in the screenshots may not be available in your particular product configuration.

2 About the DVB-T Option

The transmission standard complies with the specification ETSI EN 300 744 (DVB-T and DVB-H).



Hierarchical coding

If you can define separate entries for the high-priority path (HP) and low-priority path (LP), a parameter is displayed twice, distinguished by HP or LP.

See also "[Hierarchy](#)" on page 12.

2.1 Required Options

The equipment layout for generating DVB-T signals includes:

- Base unit
- Option Enable Broadcast Standard (R&S SMCVB-K519)
- Option DVB-T (R&S SMCVB-K163)

2.2 About DVB-H/T

The **DVB-H** standard is based on the earlier standard **DVB-T**, that is used for terrestrial digital broadcasting.

[Figure 2-1](#) shows the components of the DVB-H transmission system.

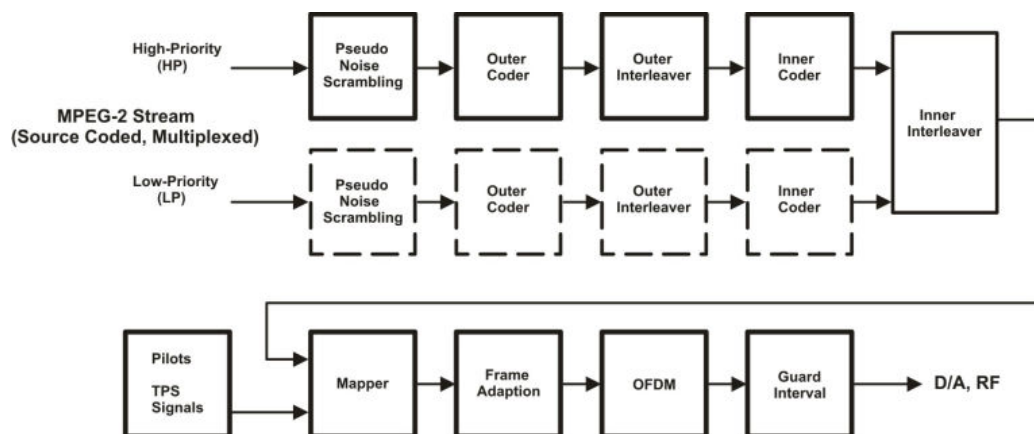

Figure 2-1: Components of the transmission system DVB-H

DVB-H provides features to meet the specific requirements for handheld, mobile terminals such as:

- Power off some part of the reception chain to increase the battery duration
- Ease access to the services when receivers switching to the next cell

- Mitigate the effects of man-made noise and severe mobile multipath channels on the receiving capabilities
- Offer sufficient flexibility and scalability to allow reception of services at various speeds
- Offer the flexibility to be used in various transmission bands and channel bandwidths

The basic technical extensions that make it possible to receive digital video broadcasting services on handheld terminals are:

- 4K mode and in-depth interleavers
- Time-slicing
- Forward error correction for multiprotocol encapsulated data (MPE-FEC)

3 DVB-T Configuration and Settings

Access:

- ▶ Select "Baseband > DVB-T".

The remote commands required to define these settings are described in [Chapter 5, "Remote-Control Commands"](#), on page 52.

Settings:

• General Settings	11
• Input Signal Settings	13
• Coding Settings	24
• TPS Settings	27
• Special Settings	30
• Global Connector Settings	31
• TS Player	31
• Local IP Data Network Settings	41

3.1 General Settings

Access:

- ▶ Select "Baseband > DVB-T".

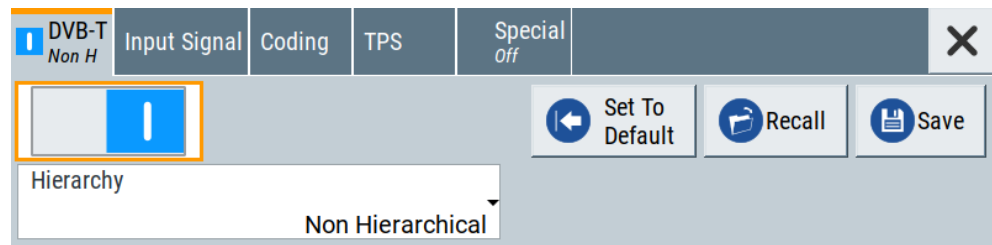

This tab provides functionality for calling default settings, save and recall settings and hierarchy coding settings.



If hierarchical coding is active, some parameters require setting for high priority and low priority input data streams. The settings are displayed separately for both paths, but summarized in this description.

Settings:

State	12
Set To Default	12
Save/Recall	12
Hierarchy	12

State

Activates the standard and deactivates all the other digital standards and digital modulation modes in the same path.

Remote command:

`[:SOURce<hw>] :BB:DVBT:STATe` on page 53

Set To Default

Calls the default settings. The values of the main parameters are listed in the following table.

Parameter	Value
State	Not affected by the "Set to Default"

Remote command:

`[:SOURce<hw>] :BB:DVBT:PRESet` on page 53

Save/Recall

Accesses the "Save/Recall" dialog, that is the standard instrument function for saving and recalling the complete dialog-related settings in a file. The provided navigation possibilities in the dialog are self-explanatory.

The settings are saved in a file with predefined extension. You can define the filename and the directory, in that you want to save the file.

See also, chapter "File and Data Management" in the R&S SMCV100B user manual.

Remote command:

`[:SOURce<hw>] :BB:DVBT:SETTing:CATAlog?` on page 54

`[:SOURce<hw>] :BB:DVBT:SETTing:DELeTe` on page 54

`[:SOURce<hw>] :BB:DVBT:SETTing:LOAD` on page 54

`[:SOURce<hw>] :BB:DVBT:SETTing:STORe` on page 54

Hierarchy

Selects the coding hierarchy.

Note: If hierarchical coding is active, some parameters require setting for high priority (HP) and low priority (LP) input data streams. The settings are displayed separately for both paths, but summarized in this description.

"Non Hierarchical"

Non-hierarchical coding used for one input data stream.

"Alpha 1/2/4"

Hierarchical coding used for two input data streams HP and LP.

For some settings, there are two parameters: one for HP and one for LP.

Remote command:

`[:SOURce<hw>] :BB:DVBT:HIERarchy` on page 54

3.2 Input Signal Settings

Access:

- ▶ Select "Baseband > DVB-T > Input Signal".

The dialog provides access to settings necessary to configure the input signal.



Most broadcast standards share the following parameters, i.e. they have the same setting independent from the standard:

- "Source"
- "Input"
- "IP TS Channel"

Settings:

- [General Settings](#)..... 13
- [Info](#)..... 17
- [Test Signal Settings](#).....19
- [IP Channel x Settings](#).....20

3.2.1 General Settings

Access:

- ▶ Select "Input Signal > General".

Source HP		Source LP		
Source	External	Source	Test Signal	General
Global Connectors ...		Test Signal	Test TS Packet	Info
Input	TS IN			Test Signal
Input Format	ASI			
Stuffing	<input checked="" type="checkbox"/>			

The dialog provides settings necessary to configure the input signal. Also, it provides physical layer information for external signals and transport stream (TS) signals. For internal test signals, you can configure payload and structure of test packets.

Settings:

Source	14
Input	15
Input Format	15
IP TS Channel.....	15
Stuffing.....	15
Test Signal	16

Source

Sets the modulation source for the input signal.

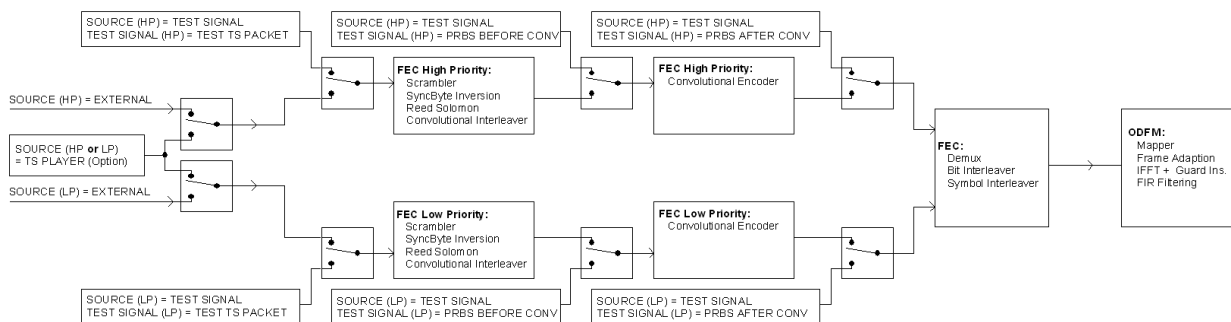

Figure 3-1: Block diagram with test signal insertion

- "External" Uses a transport stream, that is input at the "TS IN"/"IP Data" interface.
- For more information about connecting to the interfaces, see also:
- "TS IN" interface: Section "Configuring the Global Connectors" in the R&S SMCV100B user manual.
 - "IP Data" interface: [Chapter 3.8, "Local IP Data Network Settings"](#), on page 41.
- "TS Player" Uses an internal transport stream with TS packet data played from a file. The player requires no option. Playing encrypted files with extension `_c` requires a stream library option R&S SMCVB-KSx.
- See also:
- [Chapter 3.7, "TS Player"](#), on page 31
 - [Supported TS player file types](#)
- "Test Signal" Uses an internal test signal as specified in [Chapter 3.2.3, "Test Signal Settings"](#), on page 19.

Remote command:

Non-hierarchical coding

`[:SOURce<hw>] :BB:DVB-T:SOURce [:HIGH]` on page 56

Hierarchical coding

`[:SOURce<hw>] :BB:DVB-T:SOURce [:HIGH]` on page 56

`[:SOURce<hw>] :BB:DVB-T:SOURce:LOW` on page 56

Input

Requires "Source > External".

Sets the external input interface.

"TS IN" Input for serial transport stream data. The signal is input at the "User 1" connector.

"IP" Requires "Hierarchy > Non Hierarchical", i.e. IP input requires non-hierarchical coding.

Input for IP-based transport stream data (TSoverIP). The signal is input at the "IP Data" connector.

Remote command:

Non-hierarchical coding

[\[:SOURCE<hw>\]:BB:DVBT:INPUT\[:HIGH\]](#) on page 56

Hierarchical coding

[\[:SOURCE<hw>\]:BB:DVBT:INPUT\[:HIGH\]](#) on page 56

[\[:SOURCE<hw>\]:BB:DVBT:INPUT:LOW](#) on page 56

Input Format

Requires "Input > TS IN".

Sets the format of the input signal.

"ASI" [ASI](#) format

"SMPTE 310" [SMPTE 310](#) format

Remote command:

Non-hierarchical coding

[\[:SOURCE<hw>\]:BB:DVBT:INPUT:FORMAT](#) on page 56

Hierarchical coding

[\[:SOURCE<hw>\]:BB:DVBT:INPUT:FORMAT](#) on page 56

[\[:SOURCE<hw>\]:BB:DVBT:INPUT:FORMAT:LOW](#) on page 56

IP TS Channel

Requires "Input > IP".

Selects the IP-based transport stream (TS) channel. You can select 1 out of 4 IP TS channels as input at the "IP Data" interface.

To configure a particular channel, see [Chapter 3.2.4, "IP Channel x Settings"](#), on page 20.

Remote command:

Non-hierarchical coding only

[\[:SOURCE<hw>\]:BB:DVBT:INPUT:TSCChannel\[:HIGH\]](#) on page 57

Stuffing

Requires "Source > External/TS Player".

Activates stuffing.

"On" The installed input interface provides the transport stream data rate required for the current modulation parameters (regardless of the input data rate of the external transport stream).

"Off" The data rate of the transport stream source must match the data rate required for the current modulation parameters.
The value equals the " [Max. Useful Data Rate](#) " on page 18.

Remote command:

Non-hierarchical coding

`[:SOURCE<hw>] :BB:DVBT:STUFFing [:HIGH]` on page 57

Hierarchical coding

`[:SOURCE<hw>] :BB:DVBT:STUFFing [:HIGH]` on page 57

`[:SOURCE<hw>] :BB:DVBT:STUFFing:LOW` on page 57

Test Signal

Defines the test signal data.

Use the parameter to measure the bit error rate before the Viterbi decoder with the BER application, the R&S ETL measurement receivers, and its serial outputs (clock and data).

"Test TS Packet"

Standardized packet data used as modulation data in the transport stream.

To configure the packet structure, select the side tab "Test Signal > Test TS Packet". See also [Chapter 3.2.3, "Test Signal Settings"](#), on page 19.

"PRBS before Conv. Enc."

Pure pseudo-random bit sequence (PRBS) data used as modulation data with no packet structure. The sequence is inserted before the convolutional encoder. PRBS data conforms with [ITU-T O.151](#) specification.

To configure the PRBS type, select the side tab "Test Signal > PRBS". See also "[PRBS](#)" on page 20.

"PRBS after Conv. Enc."

Pure pseudo-random bit sequence (PRBS) data used as modulation data with no packet structure. The sequence is inserted after the convolutional encoder.

Remote command:

Non-hierarchical coding

`[:SOURCE<hw>] :BB:DVBT:TESTsignal [:HIGH]` on page 62

Hierarchical coding

`[:SOURCE<hw>] :BB:DVBT:TESTsignal [:HIGH]` on page 62

`[:SOURCE<hw>] :BB:DVBT:TESTsignal:LOW` on page 62

3.2.2 Info

Access:

- ▶ Select "Input Signal > PLP Info".

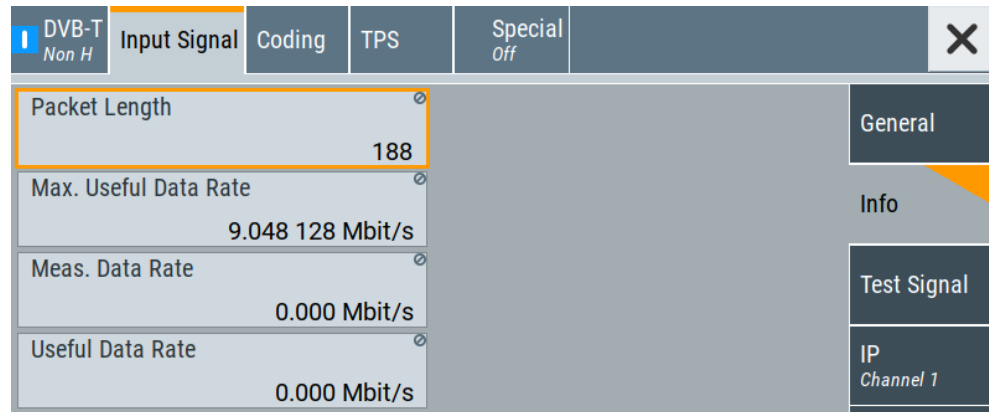

The tab displays the information on the input signal.

How to: [Chapter 4.3, "Calculating the Input Data Rate"](#), on page 50

Settings:

Packet Length	17
Max. Useful Data Rate	18
Measured Data Rate	18
Useful Data Rate	18

Packet Length

Requires "Source > External".

Displays the packet length of the external transport stream in bytes.

If the packet length does not match the specified length, the output signal is erroneous. "Packet Length > Invalid" is displayed.

"188"	188 byte packets specified for serial input and parallel input.
"204"	204 byte packets specified for serial input and parallel input.
"208"	208 byte packets specified for serial input and parallel input.
"Invalid"	Packet length ≠ 188 bytes, 204 bytes or 208 bytes, i.e. the length is not as specified.

Remote command:

Non-hierarchical coding

`[:SOURce<hw>] :BB:DVBT:PACKetlength [:HIGH] ?` on page 59

Hierarchical coding

`[:SOURce<hw>] :BB:DVBT:PACKetlength [:HIGH] ?` on page 59

`[:SOURce<hw>] :BB:DVBT:PACKetlength:LOW?` on page 59

Max. Useful Data Rate

Requires "Source > External/TS Player".

Displays the maximum data rate, that is derived from the current modulation parameter settings.

The value is the optimal value at the TS input interface, that is necessary for the modulator.

If "Stuffing > On", the value indicates the maximum useful data rate, that is allowed in the transport stream.

If "Stuffing > Off", the value indicates the transport stream input data rate that is required for the transport stream.

How to: [Chapter 4.3, "Calculating the Input Data Rate"](#), on page 50.

Remote command:

Non-hierarchical coding

`[:SOURCE<hw>] :BB:DVBT:USEFUL [:RATE] :MAX [:HIGH] ?` on page 59

Hierarchical coding

`[:SOURCE<hw>] :BB:DVBT:USEFUL [:RATE] :MAX [:HIGH] ?` on page 59

`[:SOURCE<hw>] :BB:DVBT:USEFUL [:RATE] :MAX:LOW?` on page 59

Measured Data Rate

Requires "Source > External".

Displays the measured value of the data rate r_{meas} of one of the following:

- External transport stream including null packets input at "User 1" connector
- External transport stream including null packets input at "IP Data/LAN" connector (TSoverIP)

The value r_{meas} equals the sum of useful data rate r_{useful} and the rate of null packets r_0 :

If "Stuffing > Off", ensure that the measured data rate equals the maximum useful data rate ($r_{\text{meas}} = r_{\text{max. useful}}$).

Remote command:

Non-hierarchical coding

`[:SOURCE<hw>] :BB:DVBT [:INPUT] :DATARATE [:HIGH] ?` on page 60

Hierarchical coding

`[:SOURCE<hw>] :BB:DVBT [:INPUT] :DATARATE [:HIGH] ?` on page 60

`[:SOURCE<hw>] :BB:DVBT [:INPUT] :DATARATE:LOW?` on page 60

Useful Data Rate

Requires "Source > External/TS Player".

Displays the data rate of useful data r_{useful} of the external transport stream. The data rate is measured at the input of the installed input interface.

Remote command:

Non-hierarchical coding

`[:SOURCE<hw>] :BB:DVBT:USEFUL [:RATE] [:HIGH] ?` on page 59

Hierarchical coding

`[:SOURCE<hw>] :BB:DVBT:USEFUL [:RATE] [:HIGH] ?` on page 59

`[:SOURCE<hw>] :BB:DVBT:USEFUL [:RATE] :LOW?` on page 59

3.2.3 Test Signal Settings

Access:

- ▶ Select "Input Signal > Test Signal".

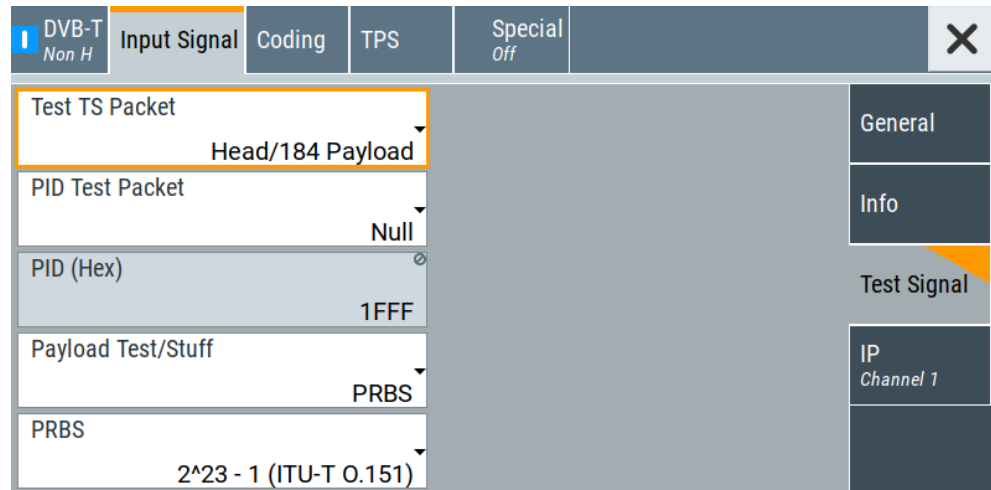

The tab provides settings necessary to configure the input test signal.

Settings:

Test TS Packet.....	19
PID Test Packet.....	19
PID (Hex).....	20
Payload Test/Stuff.....	20
PRBS.....	20

Test TS Packet

Specifies the structure of the test transport stream packet that is fed to the modulator.

"Head/184 Payload"

A sync byte (0x47) followed by three header bytes and 184 payload bytes.

"Sync/187 Payload"

A sync byte (0x47) followed by 187 payload bytes.

Remote command:

[:SOURce<hw>] :BB:DVBT:TSPacket on page 63

PID Test Packet

If a header is present in the test packet ("Test TS Packet > Head/184 Payload"), you can specify a fixed or variable packet identifier (PID).

"Null" The header of the test transport stream packets has a fixed setting of null packet header 1FFF (hex).

"Variable" Uses the header value defined with [PID \(Hex\)](#).

Remote command:

[:SOURce<hw>] :BB:DVBT:PIDTestpack on page 62

PID (Hex)

Sets the PID.

Remote command:

[:SOURce<hw>] :BB:DVBT:PID on page 62

Payload Test/Stuff

Defines the payload area content of the TS packet.

For "Source > Test Signal", the packet is a test packet.

For "Stuffing > On", the packet is a null packet. Null packets are inserted into the external transport stream to adapt the stream data rate.

"PRBS" PRBS data in accordance with ITU-T O.151

"0x00" Exclusively 00 (hex) data

"0xFF" Exclusively FF (hex) data

Remote command:

[:SOURce<hw>] :BB:DVBT:PAYLoad on page 61

PRBS

Sets the length of the PRBS sequence.

You can select a PRBS 15 or a PRBS 23 sequence as specified by ITU-T O.151.

Remote command:

[:SOURce<hw>] :BB:DVBT:PRBS [:SEQuence] on page 62

3.2.4 IP Channel x Settings

Access:

1. Select "Input Signal > General".
2. Select "Source > External"
3. Select "Input > IP"

4. Select "Input Signal > IP Channel x"

Input IP <input type="checkbox"/>	Alias	Alias 1	General
Type Unicast	Multicast Address	226.0.0.0	Info
Port 6 002	IGMPv3 Source Address	0.0.0.0	Test Signal
Ping Source Address	Local IP Data Network ...		IP Channel 1
Ping Result			

The tab provides settings necessary to configure IP channel x.

You can configure settings for 4 IP channels $x = 1$ to 4 individually, see also "Input Signal > General > IP TS Channel".



IP channel settings affect input IP data of the local IP data network. The settings are independent from the used broadcast standard configuration.

Saving/recalling a certain IP channel or local IP data network configuration is not possible via the broadcast standard-specific functionality.

Use the global save/recall functionality instead, see section "Saving and Recalling Instrument Settings" in the R&S SMCV100B user manual.

The table below shows the availability of the tab in the broadcast standard configuration.

Table 3-1: IP channel configuration support in broadcast standards

Baseband standard	"IP Channel x"	Baseband standard	"IP Channel x"
"ATSC/ATSC-M/H"	Yes	"T-DMB/DAB"	Yes
"ATSC 3.0"	No	"DVB-S"	Yes
"DTMB"	Yes	"DVB-S2"	Yes
"DVB-T"	Yes	"DRM"	No
"DVB-T2"	Yes	"Audio AM"	No
"ISDB-T"	Yes	"Audio FM"	No

See also:

- [Chapter 4.1.1, "How to Apply an External IP Input Signal"](#), on page 44
- [Chapter 3.8, "Local IP Data Network Settings"](#), on page 41

Requirements

At your IP source, set the "transport stream packets per internet protocol packet" (TP per IP) parameter as follows:

- If TP packet length = 188 bytes: Set TP per IP to 7 or 6.
- If TP packet length = 204/208 bytes: Set TP per IP to 6.

We recommend that youFurthermore, we recommend that you use a separate LAN infrastructure to stream the transport streams via IP to the IP connector of the base-band board. We recommend that you avoid TS packet losses during IP transmission.

Settings:

Input IP.....	22
Alias.....	22
Type.....	22
Multicast Address.....	22
Port.....	23
IGMPv3 Source Address.....	23
Ping Source Address.....	23
Ping Result.....	23
Local IP Data Network.....	23

Input IP

Activates/deactivates the IP input.

Remote command:

[:SOURce<hw>] :BB: INPut : IP<ch> [:STATe] on page 64

Alias

Sets a unique name for the IP connection.

The definition of a name is optional but facilitates identification in the measurement views. The name input fits maximum 16 characters in ASCII format.

Remote command:

[:SOURce<hw>] :BB: INPut : IP<ch> : ALIas on page 64

Type

Sets the input signal type.

- | | |
|-------------|---|
| "Unicast" | Analyzes all unicast IP packets that arrive at the specified "Port". |
| "Multicast" | When an IP address is in the multicast address range, an attempt is made to join a multicast group using IGMP.
Set "Multicast Address" and "Port". |

Remote command:

[:SOURce<hw>] :BB: INPut : IP<ch> : TYPE on page 65

Multicast Address

Editing requires "Type > Multicast".

Sets the destination IP address (IPv4) of the IP connection.

You can set addresses from "224.0.0.0" to "239.255.255.255".

Remote command:

[:SOURce<hw>] :BB:INPut:IP<ch>:MULticast:ADDRes on page 65

Port

Sets the destination UDP port.

Due to [UDP/RTP](#) autosensing, we recommend that you set a port offset of at least 6 between neighboring IP TS channels.

Remote command:

[:SOURce<hw>] :BB:INPut:IP<ch>:PORT on page 65

IGMPv3 Source Address

Requires "Type > Multicast".

Sets the [IGMPv3](#) source address.

If you need to filter the data sent to the multicast address, specify the source address. A source address different from "0.0.0.0" accepts only data originating from the specified IP address.

Remote command:

[:SOURce<hw>] :BB:INPut:IP<ch>:IGMP [:SOURce] :ADDRes on page 66

Ping Source Address

Clicking "Ping Source Address" triggers pinging of the [IGMPv3](#) source address.

If you set a different value from "IGMPv3 Source Address = 0.0.0.0" and click the button, the software checks if the address is reachable.

Remote command:

[:SOURce<hw>] :BB:INPut:IP<ch>:IGMP [:SOURce] :PING on page 66

Ping Result

Displays the result after pinging the source address.

If "Ping Result > Ping: Successful", the source address is available in the network.

If "Ping Result > Ping: Transmit Failed. xxx", the source address is not available in the network. "xxx" can be, e.g. "General Failure". Try another "IGMPv3 Source Address".

Remote command:

[:SOURce<hw>] :BB:INPut:IP<ch>:IGMP [:SOURce] :RESult? on page 66

Local IP Data Network

Accesses local IP data network settings, see [Chapter 3.8, "Local IP Data Network Settings"](#), on page 41.

3.3 Coding Settings

Access:

- ▶ Select "Baseband > DVB-T > Coding".

DVB-T Non H	Input Signal	Coding	TPS	Special Off		X
Hierarchy		Non Hierarchical		Constellation		64QAM
Channel Bandwidth		8 MHz		Used Bandwidth		7.607 142 9 MHz
FFT-Mode		8 K		Guard Interval		1/32
DVB-H State		<input type="checkbox"/>				
Code Rate		3/4				

The tab provides settings for coding of one or two input paths.

Settings:

Hierarchy	24
Constellation	25
Channel Bandwidth	25
Used Bandwidth	25
FFT-Mode	25
Guard Interval	26
DVB-H State	26
Symbol Interleaver	26
Code Rate	27

Hierarchy

Selects the coding hierarchy.

Note: If hierarchical coding is active, some parameters require setting for high priority (HP) and low priority (LP) input data streams. The settings are displayed separately for both paths, but summarized in this description.

"Non Hierarchical"

Non-hierarchical coding used for one input data stream.

"Alpha 1/2/4"

Hierarchical coding used for two input data streams HP and LP.

For some settings, there are two parameters: one for HP and one for LP.

Remote command:

[:SOURce<hw>] :BB:DVB T:HIERarchy on page 54

Constellation

Defines the constellation.

The higher the coding hierarchy, that is the alpha factor, the greater is the distance between the constellation points of two different quadrants. With identical power output, the high priority path is transmitted more reliably at a higher alpha factor (at the expense of the low priority path).

"QPSK" Requires "Hierarchy > Non-hierarchical".

"16 QAM/64 QAM"

Requires "Hierarchy > Alpha 1/2/4".

The high priority path is mapped to the 4 quadrants and therefore represents a QPSK.

Remote command:

`[:SOURCE<hw>] :BB:DVB-T:CONSTel` on page 67

Channel Bandwidth

Selects the channel bandwidth.

The channel bandwidth correlates with the "Used Bandwidth", that is smaller. For the correlation between the two bandwidths, see [Table 3-2](#).

Remote command:

`[:SOURCE<hw>] :BB:DVB-T:CHANnel [:BANDwidth]` on page 67

Used Bandwidth

Defines the used bandwidth.

The used bandwidth correlates with the "Channel Bandwidth", see [Table 3-2](#). triggers the used bandwidth value the automatic setting "Channel Bandwidth > Variable".

Table 3-2: Correlation between channel bandwidth and used bandwidth

"Channel bandwidth"	"Used bandwidth"	Elementary frequency
5 MHz	4.7544643 MHz	40/7 MHz
6 MHz	5.70535717 MHz	48/7 MHz
7 MHz	6.6562500 MHz	56/7 MHz
8 MHz	7.6071429 MHz	64/7 MHz
Variable	1 MHz to 10 MHz	

Remote command:

`[:SOURCE<hw>] :BB:DVB-T:USED [:BANDwidth]` on page 69

FFT-Mode

Sets the fast fourier transform (FFT) window to determine the number of carriers per OFDM symbol.

To find out the number of carriers for a given FFT window, see [Table 3-3](#).

Table 3-3: Number of carriers

Parameter	2K	4K	8K
Number of K carriers	1705	3409	6817
Number of data carriers	1512	3024	6048

The frequency spacing between adjacent OFDM carriers $1/T_u$ and the useful part of the OFDM symbol period T_u also depend on the channel bandwidth Δf . [Table 3-4](#) provides an overview.

Table 3-4: OFDM carrier spacing and OFDM symbol period relation with channel bandwidth

Parameter	Δf	2K	4K	8K
$1/T_u$	5 MHz	2.790 kHz	1.395 kHz	0.698 kHz
	6 MHz	3.348 kHz	1.674 kHz	0.837 kHz
	7 MHz	3.906 kHz	1.953 kHz	0.977 kHz
	8 MHz	4.464 kHz	2.232 kHz	1.116 kHz
T_u	5 MHz	358.4 us	716.8 us	1433.6 us
	6 MHz	298.7 us	597.3 us	1194.7 us
	7 MHz	256 us	512 us	1024 us
	8 MHz	224 us	448 us	896 us

Remote command:

`[:SOURCE<hw>] :BB:DVBT:FFT:MODE` on page 68

Guard Interval

Sets the guard interval. The interval is expressed in fractions of the useful part of the OFDM symbol period T_u .

Remote command:

`[:SOURCE<hw>] :BB:DVBT:GUARD:INTERVAL` on page 68

DVB-H State

Enables or disables [DVB-H](#).

If enabled, extended functionality becomes available for handheld operation (DVB-H) as specified in annex F of [ETSI EN 300 744](#). The functionality comprises for example:

- Set between "In-Depth" or "Native" symbol interleaver, see "[Symbol Interleaver](#)" on page 26.
- Specify TPS bits for "Time Slicing" and "MPE FEC", see [Chapter 3.4, "TPS Settings"](#), on page 27.

If disabled, DVB-T only functionality of specification [ETSI EN 300 744](#) is available.

Remote command:

`[:SOURCE<hw>] :BB:DVBT:DVHState` on page 68

Symbol Interleaver

Requires "DVB-H State > On".

Sets the symbol interleaver.

For "DVB-H State > Off", the "Symbol Interleaver > Native" is set automatically. The setting is hidden.

Remote command:

[:SOURce<hw>] :BB:DVBT:DVBH:SYMBOL [:INTerleaver] on page 67

Code Rate

Sets the code rate.

With hierarchical coding enabled, you can set individual code rates for high priority path and low priority path.

Remote command:

Non-hierarchical coding

[:SOURce<hw>] :BB:DVBT:RATE [:HIGH] on page 68

Hierarchical coding

[:SOURce<hw>] :BB:DVBT:RATE [:HIGH] on page 68

[:SOURce<hw>] :BB:DVBT:RATE:LOW on page 68

3.4 TPS Settings

Access:

- ▶ Select "Baseband > DVB-T > TPS".

DVB-T Non H	Input Signal	Coding	TPS	Special off	X
TPS Cell Id (Hex) 0					
TPS Reserved State <input type="checkbox"/>					
TPS Reserved Bits (Hex) 0					

The tab provides settings of the TPS carriers that are not related to transmission parameters.

Settings:

TPS Cell ID (Hex).....	27
TPS Reserved State.....	28
TPS Reserved Bits (Hex).....	28
Time Slicing.....	28
MPE FEC.....	29

TPS Cell ID (Hex)

Sets the cell ID in four-digit hexadecimal format.

8 bit are used for this purpose. The most significant byte is transferred in the OFDM frames 1 and 3. The least significant byte is transferred in the OFDM frames 2 and 4, see [Table 3-5](#).

Table 3-5: TPS cell ID in binary form

TPS bit number	TPS cell ID	
	OFDM frame 1 and 3	OFDM frame 2 and 4
s40	(15) - MSB	(7)
s41	(14)	(6)
s42	(13)	(5)
s43	(12)	(4)
s44	(11)	(3)
s45	(10)	(2)
s46	(9)	(1)
s47	(8)	(0) - LSB

MSB = most significant bit, LSB = least significant bit

Remote command:

`[:SOURce<hw>] :BB:DVBT:CELL:ID` on page 69

TPS Reserved State

Enables or disables the reserved TPS bits.

See "[TPS Reserved Bits \(Hex\)](#)" on page 28.

Remote command:

`[:SOURce<hw>] :BB:DVBT:TPSReserved:STATE` on page 70

TPS Reserved Bits (Hex)

Sets the reserved bits in one-digit hexadecimal format.

4 bit are used for this purpose, see [Table 3-5](#).

Table 3-6: TPS reserved bits in binary form

TPS bit number	TPS reserved bits
s50	(3)
s51	(2)
s52	(1)
s53	(0)

Remote command:

`[:SOURce<hw>] :BB:DVBT:TPSReserved:VALue` on page 71

Time Slicing

Requires "Coding > DVB-H > On".

Enables/disables time slicing.

If enabled, 1 TPS bit (s48) is used to signal that at least one data stream with time slicing exists in the multiplex.

For hierarchical coding, the information for the HP path is transmitted in OFDM frames 1 and 3. The information for the LP path is transmitted in OFDM frames 2 and 4. See [Table 3-7](#).

For non-hierarchical coding, no distinction is made between the OFDM frames.

Table 3-7: Time slicing for hierarchical coding

TPS bit number	Time slicing	
	OFDM frame 1 and 3	OFDM frame 2 and 4
s48	HP	LP

Remote command:

Non-hierarchical coding

[\[:SOURCE<hw>\]:BB:DVBT:TIMESlice\[:HIGH\]](#) on page 70

Hierarchical coding

[\[:SOURCE<hw>\]:BB:DVBT:TIMESlice\[:HIGH\]](#) on page 70

[\[:SOURCE<hw>\]:BB:DVBT:TIMESlice:LOW](#) on page 70

MPE FEC

Requires "Coding > DVB-H > On".

Enables/disables [MPE FEC](#).

If enabled, 1 TPS bit (s49) is used to signal that MPE FEC is used in at least one data stream.

For hierarchical coding, the information for the HP path is transmitted in OFDM frames 1 and 3. The information for the LP path is transmitted in OFDM frames 2 and 4. See [Table 3-8](#).

For non-hierarchical coding, no distinction is made between the OFDM frames.

Table 3-8: MPE FEC for hierarchical coding

TPS bit number	MPE FEC	
	OFDM frame 1 and 3	OFDM frame 2 and 4
s49	HP	LP

Remote command:

Non-hierarchical coding

[\[:SOURCE<hw>\]:BB:DVBT:MPEFec\[:HIGH\]](#) on page 70

Hierarchical coding

[\[:SOURCE<hw>\]:BB:DVBT:MPEFec\[:HIGH\]](#) on page 70

[\[:SOURCE<hw>\]:BB:DVBT:TIMESlice:LOW](#) on page 70

3.5 Special Settings

Access:

- ▶ Select "Baseband > DVB-T > Special".

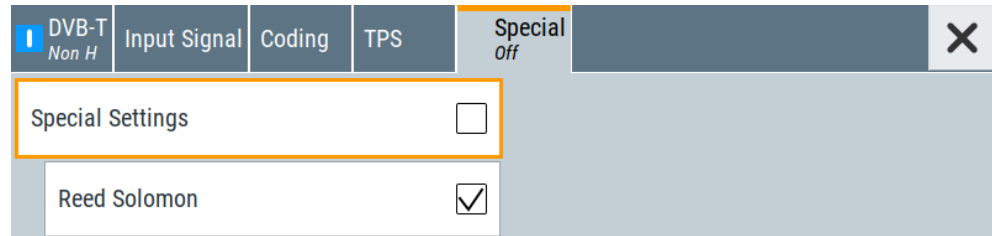

The tab provides settings, that differ from the specification of the broadcast standard.



Settings different from the broadcast standard can be useful for research and development. Applying these settings requires "Special Settings > On".

If you set a parameter different from the specification, the warning icon is displayed left to the parameter.

Settings:

Special Settings	30
Reed Solomon	30

Special Settings

Enables/disables special settings.

The setting allows you to switch between standard-compliant and user-defined channel coding.

Remote command:

`[:SOURce<hw>] :BB:DVBT [:SPECial] :SETTing [:STATe]` on page 72

Reed Solomon

Enables/disables the Reed-Solomon encoder.

The standard stipulates a Reed-Solomon RS (204, 188), i.e. "Reed Solomon > On". Incoming packets of the TS frame have a length of 188 bytes or, in special cases, a length of 204 bytes. The packet length determines

- "On"
- "Packet Length = 188": The Reed-Solomon encoder adds 16 Reed-Solomon bytes to the incoming 188 bytes of an MPEG transport stream frame. The Reed-Solomon decoder can correct up to 8 erroneous bytes in a Reed-Solomon packet (= 204 bytes). The number of incorrect bits in an errored byte is irrelevant.
 - "Packet Length = 204": Of the incoming 204 bytes of an MPEG transport stream frame, the Reed-Solomon encoder overwrites the last 16 bytes with its own Reed-Solomon bytes.

- "Off"
- "Packet Length = 188": 16 dummy bytes are transmitted instead of the 16 Reed-Solomon bytes. The data rate is not changed.
 - "Packet Length = 204": All 204 bytes of an MPEG frame are forwarded unchanged. The data rate is not changed.

Remote command:

Non-hierarchical coding

`[:SOURCE<hw>] :BB:DVBT [:SPECial] :REEDsolomon [:HIGH]` on page 71

Hierarchical coding

`[:SOURCE<hw>] :BB:DVBT [:SPECial] :REEDsolomon [:HIGH]` on page 71

`[:SOURCE<hw>] :BB:DVBT [:SPECial] :REEDsolomon:LOW` on page 71

3.6 Global Connector Settings

The "Input Signal" dialog, the "Trigger/Marker/Clock" dialog and "Trigger In", "Marker" and "Clock" tabs in "Baseband > ARB/Custom Digital Mod" configuration dialogs provide quick access to the related connector settings. Click the "Global Connectors" button to access the settings.

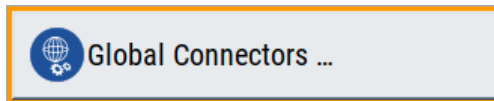

See also chapter "Global Connector Settings" in the user manual.

3.7 TS Player

The "TS Player" application allows you to play stream files for simulation of dedicated transport stream (TS) scenarios. Also, the R&S SMCV100B offers stream libraries containing stream files with a wide range of ready-made signals for testing systems with different transmission parameters. For supported file types, see [Table 3-9](#).

Key features

The key features for playing stream files with "TS Player" application are:

- Support of numerous broadcast transmission standards
- Streaming of high-quality video contents
- Streaming of high-quality audio contents
- Efficient use with dedicated streams

Required options

The equipment layout for processing stream files includes:

- Base unit, including arbitrary waveform generator (64 MSample ARB memory, 60 MHz RF bandwidth)
- Broadcast standard option for the "TS Player" application (R&S SMCVB-Kxxx)

- Enable Broadcast Standards option (R&S SMCVB-K519)
- Optional stream library option (R&S SMCVB-KSxx)

For more information, see data sheet.

To access and download a stream library file

The steps to access a stream library and to download stream library files is analogous as for waveform libraries. See chapter "How to Work with Waveform Libraries" in the R&S SMCV100B user manual.

For information on the content of a stream library, see the user manual of the stream library at:

www.rohde-schwarz.com/manual/smcv100b/ksxx-kvxx-stream-and-waveform-libraries-user-manuals-manuals-gb1_78701-972224.html

To access the "TS Player" application

1. Select "Baseband > DVB-T > Input Signal".
2. Select "Source > TS Player".
3. Select "TS Player" button.

Opens the TS player dialog, where you can load files.

Support in broadcast standard configuration

Various broadcast baseband standards of the R&S SMCV100B support the "TS Player" application. For an overview, see the table below.

Baseband standard	"Source > TS Player"	Baseband standard	"Source > TS Player"
"ATSC/ATSC-M/H"	Yes	"T-DMB/DAB"	Yes
"ATSC 3.0"	Yes	"DVB-S"	Yes
"DTMB"	Yes	"DVB-S2"	Yes
"DVB-T"	Yes	"DRM"	No
"DVB-T2"	Yes	"Audio AM"	No
"ISDB-T"	Yes	"Audio FM"	No

The remote commands required to define these settings are described in [Chapter 5.6, "TSGen Subsystem"](#), on page 72.

Settings:

- [TS Player Settings](#)..... 33
- [Player Output Settings](#)..... 36
- [Seamless Loop Settings](#)..... 39

3.7.1 TS Player Settings

Access:

1. Follow the steps in "[To access the "TS Player" application](#)" on page 32.
2. Select "TS Player > TS-Player".

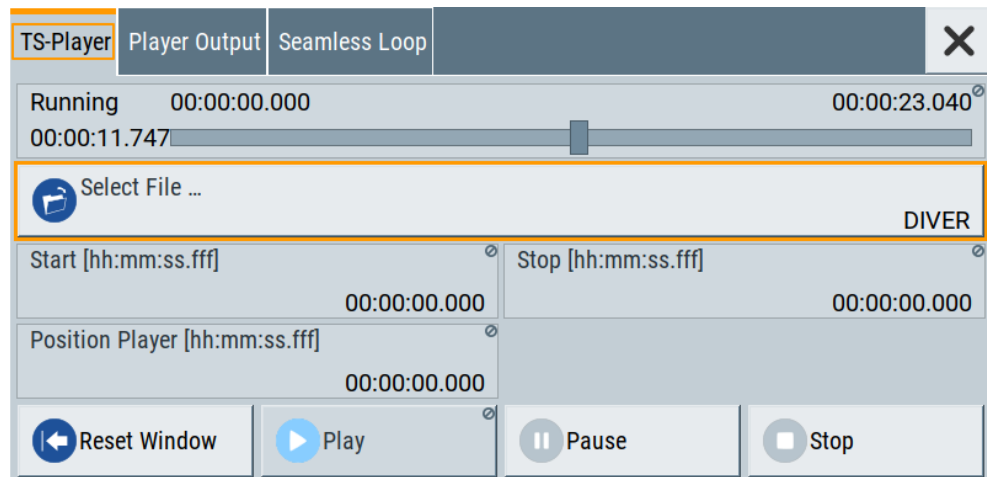

The tab provides settings necessary to configure the general settings of the TS player application.

Settings:

Running/Position Player [hh:mm:ss.fff]	33
Select File	33
Start [hh:mm:ss.fff]	35
Position Player [hh:mm:ss.fff]	35
Stop [hh:mm:ss.fff]	35
Reset Window	35
Play	35
Pause	35
Stop	35

Running/Position Player [hh:mm:ss.fff]

Displays the current position in time, while playing the file.

You can set an individual position via [Position Player \[hh:mm:ss.fff\]](#).

Remote command:

[:TSGen:CONFigure:SEEK:POSition](#) on page 77

Select File

Provides access to the standard "File Select" function of the instrument. The provided navigation possibilities in the dialog are self-explanatory.

See also, chapter "File and Data Management" in the R&S SMCV100B User Manual.

The dialog allows you to select user-defined, predefined and recent files. [Table 3-9](#) lists file extensions of supported files.

Table 3-9: Supported TS player file types

File extension	Stream libraries	Remark	Option
*.atsc_c	ATSC/ATSC & Mobile DTV	Encrypted	R&S SMCVB-KS13
*.dab	T-DMB/DAB	Unencrypted	-
*.dab_c	T-DMB/DAB	Encrypted	R&S SMCVB-KS10
*.dabp_c	DAB+	Encrypted	R&S SMCVB-KS11
*.eti	T-DMB/DAB	Unencrypted	-
*.xeti	T-DMB/DAB	Unencrypted	-
*.emc_c	EMC	Encrypted	R&S SMCVB-KS15
*.isdbt_c	ISDB-T	Encrypted	R&S SMCVB-KS12
*.pcap	-	Captured IPv4 stream for ATSC 3.0 player	-
*.t2mi ¹⁾	-	Unencrypted	-
*.t2mi_c	DVB-T2 MI	Encrypted	R&S SMCVB-KS14
*.t2trp_c	DVB-T2 MI	Encrypted	R&S SMCVB-KS14
*.trp	-	Unencrypted	-
*.trp_c	-	Encrypted Included in various stream libraries	R&S SMCVB-KS12 R&S SMCVB-KS17 R&S SMCVB-KS18 R&S SMCVB-KS19 R&S SMCVB-KS20
*.bin	-	Unencrypted	-
*.ts	-	Unencrypted	-
*.mpg	-	Unencrypted	-
*.t10	-	-	-

¹⁾ For T2MI stream files, the data rate of a T2MI file is determined automatically, if the following applies:

- Data rate is not part of the TRP file header information.
- PCR information is not available.
- T2MI TRP file is not encrypted, that means not of type *.t2mi_c.
- TRP file has the *.t2mi file extension.

Remote command:

:TSGen:CONFIGure:PLAYfile on page 75

:TSGen:READ:PLAYfile:LENGth? on page 79

:TSGen:READ:FMEMory on page 79

Start [hh:mm:ss.fff]

Sets the start position in the loaded player file. Data which chronologically precedes the start position is not replayed by the player.

The entered time stamp must chronologically always precede the entry under [Stop](#).

Remote command:

`:TSGen:CONFigure:SEEK:START` on page 77

Position Player [hh:mm:ss.fff]

Displays the current play position in the file.

Remote command:

`:TSGen:CONFigure:SEEK:POSition` on page 77

Stop [hh:mm:ss.fff]

Sets the end position in the player file. Data which chronologically follows the end position is not replayed by the player.

When the player reaches the "Stop" position, it returns to the "Start" position (continuous play).

The entered time stamp must chronologically always follow the entry under [Play](#).

Remote command:

`:TSGen:CONFigure:SEEK:STOP` on page 77

Reset Window

Resets "Start/Stop/Position Player" parameters.

Remote command:

`:TSGen:CONFigure:SEEK:RESet` on page 77

Play

Plays the selected file.

For supported file types, see [Table 3-9](#).

Remote command:

`:TSGen:CONFigure:COMMand<ch>` on page 74

Pause

Pauses the player.

After pausing, you can resume playing the file by clicking "Play" again.

Remote command:

`:TSGen:CONFigure:COMMand<ch>` on page 74

Stop

Stops the player and returns to the start position.

Remote command:

`:TSGen:CONFigure:COMMand<ch>` on page 74

3.7.2 Player Output Settings

Access:

- ▶ Select "TS Player > Player Output".

The tab provides settings necessary to configure the output of the TS player.

3.7.2.1 General Settings

The tab provides settings necessary to configure general player output properties.

Data Rate.....	36
Orig. Data Rate.....	36
Packet Length.....	37
Nullpacket Stuffing.....	37
Stop Data.....	37

Data Rate

Sets the output data rate of the player.

Note: If "Nullpacket Stuffing > Off", we recommend that you set the output data rate equal to the original data rate.

If you want to use a different data rate, activate "Nullpacket Stuffing". The function ensures that the data stream is replayed in the same way as it was recorded. The time references in the tables of the TS stream are also correct during replay.

Remote command:

:TSGen:CONFigure:TSRate on page 78

Orig. Data Rate

Displays the calculated original TS data rate.

Remote command:

:TSGen:READ:ORIGtsrate on page 79

Packet Length

Requires a *.trp, *.trp_c, *.emc or *.emc_c file loaded into the "TS Player" dialog. *.trp files are previously recorded files.

Displays the packet length of the loaded TS player file.

Remote command:

[:TSGen:CONFigure:TSPacket](#) on page 78

Nullpacket Stuffing

Requires a *.trp, *.trp_c, *.emc or *.emc_c file loaded into the "TS Player" dialog. *.trp files are previously recorded files.

Enables or disables nullpacket stuffing.

The output data rate of the TS player equals the original data rate. The equality ensures that the time references in the tables of the played TS stream are correct during replay.

"On" Activate stuffing, if you need a higher rate than the original data rate. Null packets are inserted into the data stream.

To ensure correct time references in the stream tables, activate program clock reference correction ("PCR, DTS/PTS > On").

"Off" Deactivate stuffing, if you want to use the same data rate as the original data rate.

Remote command:

[:TSGen:CONFigure:STUFFing](#) on page 78

Stop Data

Requires a *.trp, *.trp_c, *.emc or *.emc_c file loaded into the "TS Player" dialog. *.trp files are previously recorded files.

Ensures that a standardized TS data stream is always output at the TS output at the rear of the R&S SMCV100B.

In pause or stop status, the TS generator generates "test packets", which have data and header parts, that can be configured using the [Test TS Packet](#).

Remote command:

[:TSGen:CONFigure:STOPdata](#) on page 78

3.7.2.2 Stuffing Settings

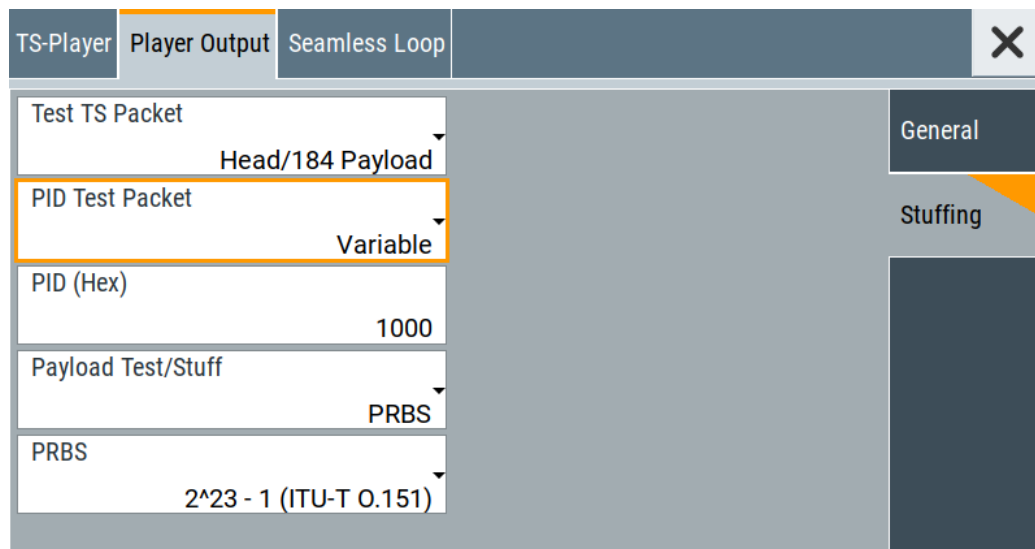

The tab comprises settings necessary to configure stuffing.

Settings

Test TS Packet	38
PID Test Packet	39
PID (Hex)	39
Payload Test/Stuff	39
PRBS	39

Test TS Packet

Specifies the structure of the test transport stream packet that is fed to the modulator.

"Head/184 Payload"

A sync byte (0x47) followed by three header bytes and 184 payload bytes.

"Sync/187 Payload"

A sync byte (0x47) followed by 187 payload bytes.

"Head/200 Payload"

A sync byte (0x47) followed by three header bytes and 200 payload bytes.

"Sync/203 Payload"

A sync byte (0x47) followed) followed by 203 payload bytes.

"Head/204 Payload"

A sync byte (0x47) followed by three header bytes and 204 payload bytes.

"Sync/207 Payload"

A sync byte (0x47) followed) followed by 207 payload bytes.

Remote command:

[:TSGen:CONFigure:TSPacket](#) on page 78

PID Test Packet

If a header is present in the test packet ("Test TS Packet > Head/184 Payload"), you can specify a fixed or variable packet identifier (PID).

- "Null" The header of the test transport stream packets has a fixed setting of null packet header 1FFF (hex).
- "Variable" Uses the header value defined with [PID \(Hex\)](#).

Remote command:

[:TSGen:CONFigure:PIDTestpack](#) on page 75

PID (Hex)

Sets the [PID](#).

If "PID Test Packet > Null", "PID (Hex) = 1FFF" is fixed.

If "PID Test Packet > Variable", you can edit the value.

Remote command:

[:TSGen:CONFigure:PID](#) on page 74

Payload Test/Stuff

Defines the payload area content of the [TS](#) packet.

- "PRBS" [PRBS](#) data in accordance with [ITU-T O.151](#)
See also chapter "Internal Modulation Data" in the R&S SMCV100B User Manual.
- "0x00" Exclusively 00 (hex) data
- "0xFF" Exclusively FF (hex) data

Remote command:

[:TSGen:CONFigure:PAYLoad](#) on page 74

PRBS

Sets the length of the PRBS sequence.

You can select a PRBS 15 or a PRBS 23 sequence as specified by [ITU-T O.151](#).

Remote command:

[:TSGen:CONFigure:PRBS\[:SEquence\]](#) on page 75

3.7.3 Seamless Loop Settings

Displaying the tab requires a *.trp, *.trp_c, *.emc or *.emc_c file loaded into the "TS Player" dialog. *.trp files are previously recorded files.

Access:

- ▶ Select "TS Player > Seamless Loop".

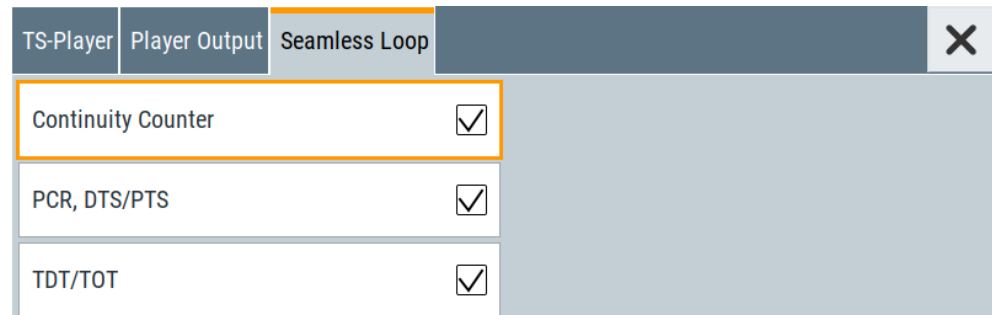

The tab provides settings necessary to configure settings for playing the file in a loop.

Settings:

Continuity Counter.....	40
PCR, DTS/PTS.....	40
TDT/TOT.....	40

Continuity Counter

Activates the correction of the continuity counters in the replayed TS data stream. The correction allows you to decode the stream without interruption when the play file is looping.

Remote command:

:TSGen:CONFigure:SEAMless:CC on page 76

PCR, DTS/PTS

Activates the correction of time stamps in the replayed TS data stream. The correction allows you to decode the stream without interruption when the play file is looping.

If you set "Nullpacket Stuffing = On" and "PCR, DTS/PTS = On", the time stamps in the streams are corrected when nullpackets are inserted into the stream.

Remote command:

:TSGen:CONFigure:SEAMless:PCR on page 76

TDT/TOT

Activates the correction of the time and date table in the replayed TS data stream. The correction allows you to decode the stream without interruption when the play file is looping.

Remote command:

:TSGen:CONFigure:SEAMless:TT on page 76

3.8 Local IP Data Network Settings

Access:

1. Select "Input Signal > General > Source > External".
2. Select "Input Signal > General > Input > IP"
3. Select "Input Signal > IP Channel x > Local IP Data Network".

Board Name		
Hostname smcv100b-565371-IP-Data		
Board Address		
Address Mode Auto (DHCP)	Protocol UDP	Show Connector ...
IP Address 10.214.2.24	Subnet Mask 255.255.252.0	MAC Address 90:b8:21:71:2e

The tab provides access to local IP data settings necessary to configure the board address.

The remote commands necessary to configure local IP data network settings are described in [Chapter 5.7, "BCIP Subsystem"](#), on page 80.

How to: [Chapter 4.1.1, "How to Apply an External IP Input Signal"](#), on page 44

Settings:

Network Status	41
Restart Network	42
Hostname	42
Address Mode	42
IP Address	42
Protocol	43
Subnet Mask	43
Show Connector	43
MAC Address	43

Network Status

Indicates that the instrument is connected to the network.

If the instrument is disconnected, try "Restart Network".

Remote command:

:SYSTem:COMMunicate:BCIP<hw>:NETWork:STATus on page 82

Restart Network

Terminates the network connection of the instrument and sets it up again later. You can use this function to fix network problems.

Note: This function restarts only the connection of the instrument to the network. It does not impact the network itself.

Remote command:

`:SYSTem:COMMunicate:BCIP<hw>:NETWork:REStart` on page 82

Hostname

Displays the hostname.

Displayed is the board name, that is the name of the IP data board of the R&S SMCV100B, e.g. SMCV100B-123456-IP-Data.

Each instrument is delivered with an assigned hostname, a logical name which can be used instead of the IP address. With the default network settings, the IP address is allocated by the DHCP server. This address can change each time the instrument is reconnected. Unlike the IP address, the hostname name does not change.

Note:

This function is password-protected. Unlock the protection level 1 to access it.

We recommend that you do not change the default network settings or the hostname to avoid problems with the network connection.

Remote command:

`:SYSTem:COMMunicate:BCIP<hw>:NETWork:COMMon:HOSTname` on page 81

Address Mode

Selects the mode for assigning the IP address.

"Auto (DHCP)"

Assigns the IP address automatically, provided the network supports **DHCP**.

"Static"

Enables you to assign the IP address manually.

Remote command:

`:SYSTem:COMMunicate:BCIP<hw>:NETWork:IPADdress:MODE` on page 81

IP Address

Displays the IP address of the instrument in the local IP data network.

By default, the R&S SMCV100B is configured to use dynamic TCP/IP configuration and to obtain the whole address information automatically.

If the network does not support DHCP or the attempt does not succeed, the instrument tries to obtain the IP address via Zeroconf (APIPA) protocol. IP addresses assigned via Zeroconf start with the number blocks 169.254.*.*.

Note: An IP address that is assigned via the Zeroconf protocol although the network requires an IP address assigned via the DHCP server can cause network connection failures.

Remote command:

`:SYSTem:COMMunicate:BCIP<hw>:NETWork:IPADdress` on page 81

Protocol

Sets the protocol type of the input IP data.

The current firmware supports **UDP** and **UDP/RTP**.

Remote command:

`:SYSTem:COMMunicate:BCIP<hw>:NETWork:PROToCol` on page 82

Subnet Mask

Displays the bit group of the subnet in the host identifier.

To assign the subnet mask manually, select "Address Mode > Static".

Remote command:

`:SYSTem:COMMunicate:BCIP<hw>:NETWork:IPADdress:SUBNet:MASK`
on page 81

Show Connector

Accesses a dialog that displays the physical location of the selected connector on the front/rear panel of the instrument.

MAC Address

Displays the MAC address, a unique identifier of the network adapter in the R&S SMCV100B.

Remote command:

`:SYSTem:COMMunicate:BCIP<hw>:NETWork:MACaddress` on page 82

4 Performing DVB-T Signal Generation Tasks

This chapter tells you how to configure the R&S SMCV100B to generate signals for simple receiver tests.

- [Configuring the Input Signal](#).....44
- [Monitoring the Input Signal](#)..... 49
- [Calculating the Input Data Rate](#)..... 50

4.1 Configuring the Input Signal

This chapter provides an overview of the different input signals, that the R&S SMCV100B uses as modulation data.

- [How to Apply an External IP Input Signal](#)..... 44
- [How to Apply an External TS Input Signal](#)..... 47
- [How to Generate an Internal TS Signal](#)..... 48

4.1.1 How to Apply an External IP Input Signal

To connect the R&S SMCV100B to local IP data network

1. Connect the IP source to the "IP Data" connector of the R&S SMCV100B.
See chapter "Connecting to IP Data Interface" in the R&S SMCV100B Getting Started user manual.
2. Select "Input Signal > General > Source > External".
3. Select "Input Signal > General > Input > IP".
4. In the "IP Channel x" side tab, click "Local IP Data Network".
By default, the R&S SMCV100B assigns the IP address automatically using [DHCP](#) ("Address Mode > Auto (DHCP)").
5. If "Network Status > Disconnected", try "Restart Network".

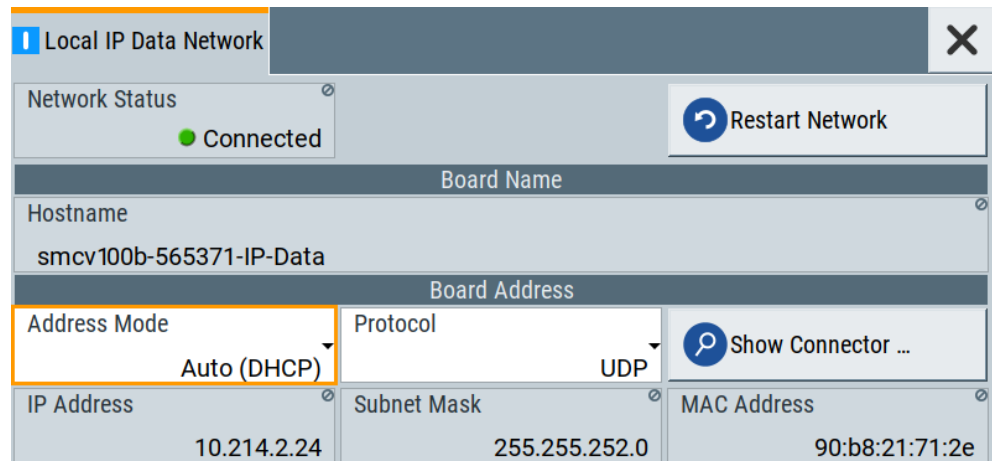

The R&S SMCV100B is connected to the local IP data network.

6. If DHCP does not assign an IP address, assign the IP address manually.
See chapter "How to Assign the IP Address" in the R&S SMCV100B user manual.
7. Specify the protocol type of the input IP data.
The current firmware supports [UDP](#) and [UDP/RTP](#).

To configure an external IP input signal

The R&S SMCV100B is connected to a local IP data network, see ["To connect the R&S SMCV100B to local IP data network"](#) on page 44.

1. Specify general IP input signal properties:
 - a) Select "Input Signal > General > Source > External".
 - b) Select "Input > IP".
 - c) Specify the IP TS Channel, e.g. "IP TS Channel > 1".

The "IP Channel 1" side tab appears, where you can configure the IP connection for channel 1 and channel-independent local IP network settings.

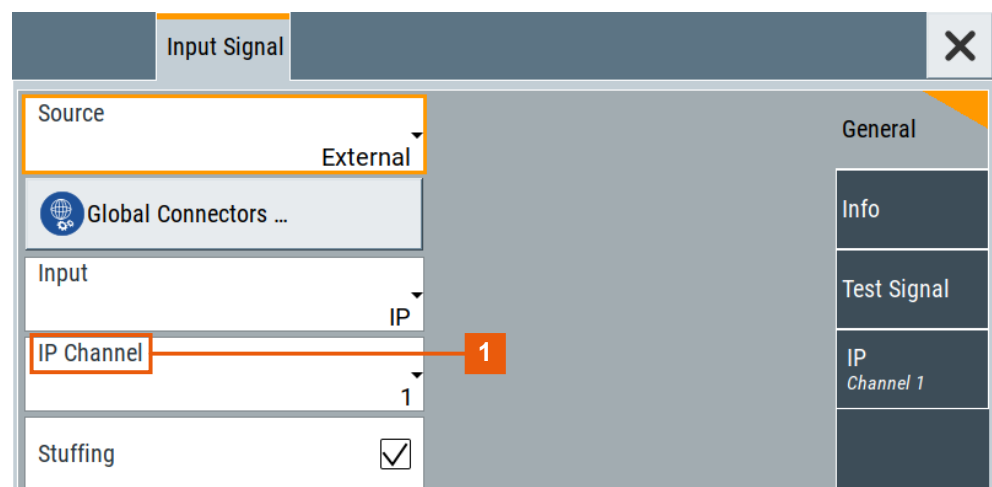

1 = IP channel notation: IP TS Channel

2. Optionally, if supported, activate "Stuffing" to adjust the TS data rate.
3. Specify IP TS channel properties, e.g. for "IP TS Channel > 1":
 - a) Define the input type, e.g. "Type > Multicast".
 - b) Specify the "Multicast Address", that is the destination IPv4 address of the IP connection.
Note: Use the destination address also in the IP data source, e.g. a stream program.
 - c) Specify the port, that is the destination port of the IP connection.
Note: Use the destination port also in the IP data source.
 - d) Specify the **IGMPv3** source address, that is the source IPv4 address of the IP connection.
 A source address different from "0.0.0.0" accepts only data originating from the specified IP address.
 - e) Optionally, to check availability of the "IGMPv3 Source Address", click "Ping Source Address"
 - If "Ping Result > Ping: Successful", the source address is available.
 - If "Ping Result > Ping: Transmit Failed. Destination Host Unreachable", try another address.
 - f) Optionally, specify a name for the IP connection, e.g. "Alias > Service".
 - g) Activate the IP channel, select "Input IP > On".

Input Signal		
Input IP <input checked="" type="checkbox"/>	Alias	General
Type	Service	Info
Multicast	Multicast Address	Test Signal
Port	224.3.2.1	IP Channel 1
6 002	IGMPv3 Source Address	
	123.4.5.6	
Ping Source Address	Local IP Data Network ...	
Ping Result		

The R&S SMCV100B is prepared for receiving IP TS data, that is input at the "IP Data" connector.

Monitor IP data stream properties in the "Info" side tab, see [Chapter 4.2.1, "How to Monitor External IP Input Data"](#), on page 49.

4.1.2 How to Apply an External TS Input Signal

To connect to the external TS input interface

1. Use a double-shielded 75 Ω BNC cable for connection between R&S SMCV100B and the external [MPEG](#) TS data source.
See also Section "Cable selection and electromagnetic interference (EMI)" in the R&S SMCV100B Getting Started user manual.
2. At the R&S SMCV100B, connect the cable to the "User 1" connector.
The connector is on the rear panel of the R&S SMCV100B.
How to: Section "To connect to non-screwable connectors (BNC)" in the R&S SMCV100B Getting Started user manual.

To specify the TS input interface at the R&S SMCV100B

The R&S SMCV100B is [connected](#) to an [MPEG](#) TS data source via the "User 1" connector.

1. Select "Input Signal > General > Source > External".
2. Select "General > Global Connectors".
3. In the "Global Connectors" dialog, configure the "User 1" connector for a TS input signal:
 - a) Select "Direction > Input".
 - b) Select "Signal > TS".

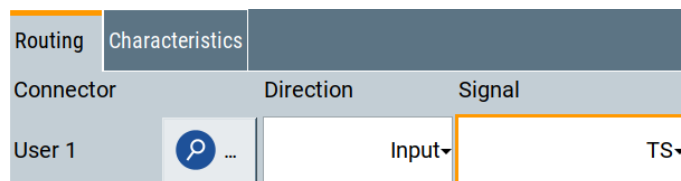

To configure an external TS input signal

The R&S SMCV100B is [prepared](#) for receiving a TS input signal at the "User 1" connector.

1. Specify general TS input signal properties:
 - a) Select "Input Signal > General > Source > External".
 - b) Select "Input > TS IN".
 - c) Specify the format of the input signal:
 - Select "ASI", if you have a source supporting [ASI](#) format.
 - Select "SMPTE 310", if you have a source supporting [SMPTE 310](#) format.
2. Optionally, activate "Stuffing" to adjust the TS data rate.

You can further specify the payload of the stuffing data, see "Test Signal > Payload Test/Stuff."

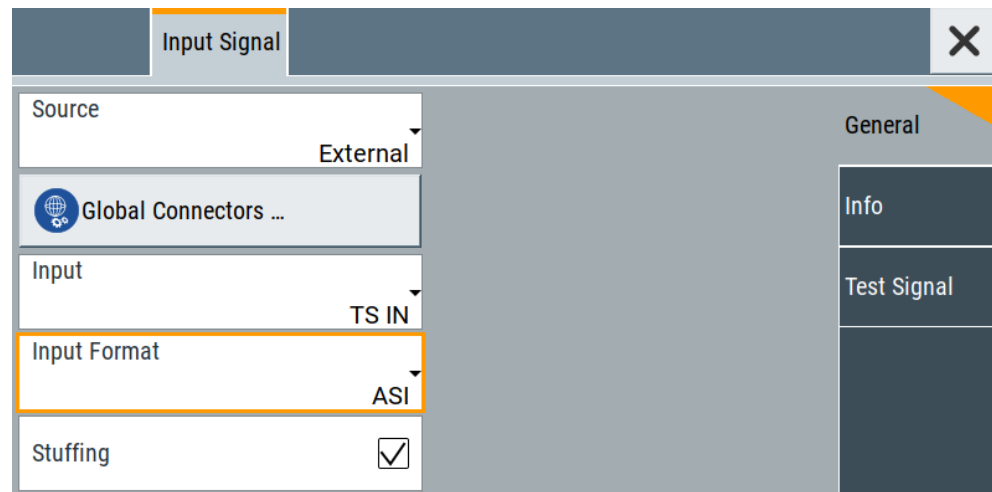

The R&S SMCV100B is prepared for receiving TS data, that is input at the "User 1" connector.

Monitor TS data stream properties in the "Info" side tab, see [Chapter 4.2.2, "How to Monitor an External TS Input Signal"](#), on page 50.

4.1.3 How to Generate an Internal TS Signal

To play a TS file with the "TS Player"

1. Select "Input Signal > Source > TS Player".
The "TS Player" button appears below.
2. Click "TS Player".
The "TS Player" dialog for playing TS data files opens.
3. Click "Play" to play the default file `DIVER.trp`.
Playing the file requires no option.

To play a file of stream library with the "TS Player"

1. Download the
2. Select "Input Signal > Source > TS Player".
The "TS Player" button appears below.
3. Click "TS Player".
The "TS Player" dialog for playing TS data files opens.
4. Click "Play" to play the default file `DIVER.trp`.

Playing the file requires no option.

4.2 Monitoring the Input Signal

This chapter provides an overview of the different input signals, that the R&S SMCV100B uses as modulation data.

- [How to Monitor External IP Input Data](#).....49
- [How to Monitor an External TS Input Signal](#).....50
- [How to Monitor an Internal TS Player Signal](#).....50

4.2.1 How to Monitor External IP Input Data

The R&S SMCV100B receives external IP input data as described in [Chapter 4.1.1, "How to Apply an External IP Input Signal"](#), on page 44.

- ▶ Select "Input Signal > Info"

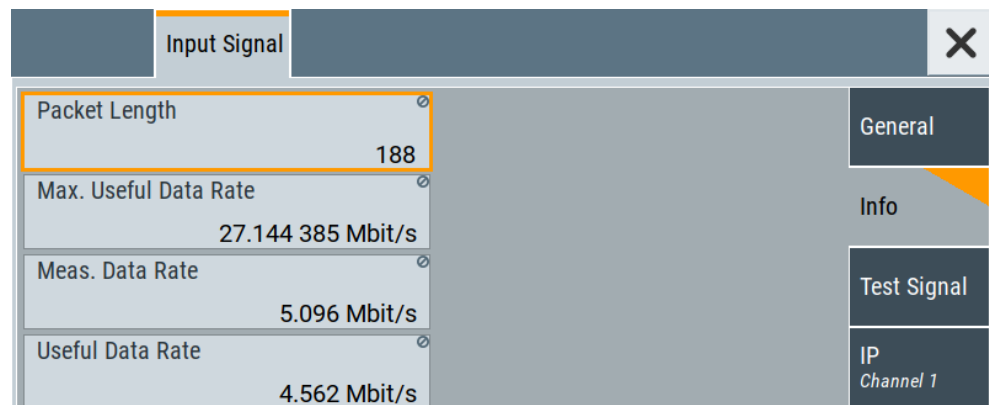

The "Info" side tab displays physical properties of the input IP stream data.

The standard packet length is 188 byte. The maximum useful data rate is specified by the broadcast standard.

The measured data rate is lower and depends on the [TS](#) source settings. The useful data rate is lower than the measured data rate due to null packets present in the transport stream.

If "Stuffing > On", the useful data rate can be lower than the maximum useful data rate.

4.2.2 How to Monitor an External TS Input Signal

The R&S SMCV100B receives external TS input data as described in [Chapter 4.1.2, "How to Apply an External TS Input Signal"](#), on page 47.

- ▶ Select "Input Signal > Info"

Property	Value
Packet Length	188
Max. Useful Data Rate	19.392 659 Mbit/s
Measured Data Rate	13.058 Mbit/s
Useful Data Rate	12.998 Mbit/s

The "Info" side tab displays physical properties of the input TS stream data.

4.2.3 How to Monitor an Internal TS Player Signal

The R&S SMCV100B receives internal TS input data as described in [Chapter 4.1.3, "How to Generate an Internal TS Signal"](#), on page 48.

- ▶ Select "Input Signal > Info"

Property	Value
Max. Useful Data Rate	38.014 706 Mbit/s
Useful Data Rate	21.298 475 Mbit/s

The "Info" side tab displays physical properties of the TS player stream data.

4.3 Calculating the Input Data Rate

The calculation of the input data rate depends on the coding hierarchy, see "[Hierarchy](#)" on page 12.

Input data rate for nonhierarchical coding

$$f_{in} = (987/1207) * CR * (1/(1+GI)) * q * (PL/188) * BW$$

where

f_{in} = input data rate in [Mbit/s]

CR = code rate [1/2, 2/3, 3/4, 5/6, 7/8]

GI = guard interval [1/4, 1/8, 1/16, 1/32, off = 0]

q = bits per carrier constellation (QPSK: q=2, 16QAM: q=4, 64QAM: q=6)

PL = packet length [188, 204]

BW = used bandwidth [MHz]

Input data rate for hierarchical coding

16QAM:

$$f_{in_HP} = (987/1207) * CR_{HP} * (1/(1+GI)) * (4/2) * (PL/188) * BW$$

$$f_{in_LP} = (987/1207) * CR_{LP} * (1/(1+GI)) * (4/2) * (PL/188) * BW$$

64QAM:

$$f_{in_HP} = (987/1207) * CR_{HP} * (1/(1+GI)) * (6/3) * (PL/188) * BW$$

$$f_{in_LP} = (987/1207) * CR_{LP} * (1/(1+GI)) * (12/3) * (PL/188) * BW$$

where

f_{in_HP} = input data rate of high-priority path in [Mbit/s]

f_{in_LP} = input data rate of low-priority path in [Mbit/s]

CR_{HP} = code rate of high-priority path [1/2, 2/3, 3/4, 5/6, 7/8]

CR_{LP} = code rate of low-priority path [1/2, 2/3, 3/4, 5/6, 7/8]

GI = guard interval [1/4, 1/8, 1/16, 1/32, off = 0]

PL = packet length [188, 204]

BW = used bandwidth [MHz]

5 Remote-Control Commands

The following commands are required to generate signals with the DVB-T option in a remote environment. We assume that the R&S SMCV100B has already been set up for remote operation in a network as described in the R&S SMCV100B documentation. A knowledge about the remote control operation and the SCPI command syntax is assumed.



Conventions used in SCPI command descriptions

For a description of the conventions used in the remote command descriptions, see section "Remote-Control Commands" in the R&S SMCV100B user manual.

Common suffixes

The following common suffixes are used in the remote commands:

Suffix	Value range	Description
SOURce<hw>	1	Available baseband signals

Programming examples

This description provides simple programming examples. The purpose of the examples is to present **all** commands for a given task. In real applications, one would rather reduce the examples to an appropriate subset of commands.

The programming examples have been tested with a software tool which provides an environment for the development and execution of remote tests. To keep the example as simple as possible, only the "clean" SCPI syntax elements are reported. Non-executable command lines (e.g. comments) start with two // characters.

At the beginning of the most remote control program, an instrument preset/reset is recommended to set the instrument to a definite state. The commands *RST and SYSTem:PRESet are equivalent for this purpose. *CLS also resets the status registers and clears the output buffer.

The following commands specific to the DVB-T are described here:

- [General Commands](#)..... 53
- [Input Commands](#)..... 55
- [Coding Commands](#)..... 66
- [TPS Commands](#)..... 69
- [Special Commands](#)..... 71
- [TSGen Subsystem](#)..... 72
- [BCIP Subsystem](#)..... 80

5.1 General Commands

Example: Saving current configuration

```
:SOURce1:BB:DVBT:SETTing:STORe "/var/user/my_dvbt"
// Saves the file "my_dvbt.dvbt" in the directory as above.
*RST
:SOURce1:BB:DVBT:SETTing:CATalog?
// my_dvbt
:SOURce1:BB:DVBT:SETTing:LOAD "/var/user/my_dvbt"
:SOURce1:BB:DVBT:HIERarchy?
// A2

:SOURce:1:BB:DVBT:STATe 1
:SOURce1:BB:DVBT:SETTing:DELeTe "my_dvbt"
```

Commands

[:SOURce<hw>]:BB:DVBT:PRESet	53
[:SOURce<hw>]:BB:DVBT:STATe	53
[:SOURce<hw>]:BB:DVBT:SETTing:CATalog?	54
[:SOURce<hw>]:BB:DVBT:SETTing:DELeTe	54
[:SOURce<hw>]:BB:DVBT:SETTing:LOAD	54
[:SOURce<hw>]:BB:DVBT:SETTing:STORe	54
[:SOURce<hw>]:BB:DVBT:HIERarchy	54

[\[:SOURce<hw>\]:BB:DVBT:PRESet](#)

Sets the parameters of the digital standard to their default values (*RST values specified for the commands).

Not affected is the state set with the command `SOURce<hw>:BB:DVBT:STATe`.

Example: See [Example "Saving current configuration"](#) on page 53.

Usage: Event

Manual operation: See ["Set To Default"](#) on page 12

[\[:SOURce<hw>\]:BB:DVBT:STATe <State>](#)

Activates the standard and deactivates all the other digital standards and digital modulation modes in the same path.

Parameters:

<State> 0 | 1 | OFF | ON

*RST: 0

Manual operation: See ["State"](#) on page 12

[[:SOURce<hw>]:BB:DVBT:SETTING:CATalog?

Queries the files with settings in the default directory. Listed are files with the file extension *.dvbt.

Example: See [Example "Saving current configuration"](#) on page 53.

Usage: Query only

Manual operation: See ["Save/Recall"](#) on page 12

[[:SOURce<hw>]:BB:DVBT:SETTING:DELeTe <Delete>

Deletes the selected file from the default or the specified directory. Deleted are files with extension *.dvbt.

Setting parameters:

<Delete> "<filename>"
Filename or complete file path; file extension can be omitted

Example: See [Example "Saving current configuration"](#) on page 53.

Usage: Setting only

Manual operation: See ["Save/Recall"](#) on page 12

[[:SOURce<hw>]:BB:DVBT:SETTING:LOAD <DvbtRecall>

Loads the selected file from the default or the specified directory. Loaded are files with extension *.dvbt.

Parameters:

<DvbtRecall> "<filename>"
Filename or complete file path; file extension can be omitted

Example: See [Example "Saving current configuration"](#) on page 53.

Manual operation: See ["Save/Recall"](#) on page 12

[[:SOURce<hw>]:BB:DVBT:SETTING:STORe <DvbtSave>

Saves the current settings into the selected file; the file extension (*.dvbt) is assigned automatically.

Parameters:

<DvbtSave> "<filename>"

Example: See [Example "Saving current configuration"](#) on page 53.

Manual operation: See ["Save/Recall"](#) on page 12

[[:SOURce<hw>]:BB:DVBT:HIERarchy <Hierarchy>

Selects the coding hierarchy.

Parameters:

<Hierarchy> A4 | A2 | A1 | NONHier
 *RST: NONHier

Example: See [Chapter 5.1, "General Commands"](#), on page 53.

Manual operation: See "[Hierarchy](#)" on page 12

5.2 Input Commands

• General Commands	55
• Info Commands	58
• Test Signal Commands	61
• IP Subsystem	63

5.2.1 General Commands

Example: Configuring general input signal properties

```
*****
// Configure general input signal parameters for hierarchical coding.
*****
:SOURce:1::BB:DVBT:HIERarchy A1
:SOURce:1:BB:DVBT:SOURce:HIGh EXT
:SOURce:1:BB:DVBT:SOURce:LOW?
// Response: TEST
:SOURce:1:BB:DVBT:INPut:HIGh?
// Response: TS
:SOURce:1:BB:DVBT:INPut:FORmat?
// Response: ASI
:SOURce:1:BB:DVBT:STUFFing:HIGh?
// Response: 1

*****
// Configure general input signal parameters for non-hierarchical coding.
*****
:SOURce:1:BB:DVBT:HIERarchy NONHier
:SOURce:1:BB:DVBT:SOURce:HIGh EXT
:SOURce:1:BB:DVBT:INPut:HIGh IP
// IP input requires non-hierarchical coding.
:SOURce:1:BB:DVBT:INPut:TSCHannel:HIGh 1
:SOURce:1:BB:DVBT:STUFFing:HIGh 0

[:SOURce<hw>]:BB:DVBT:SOURce:LOW..... 56
[:SOURce<hw>]:BB:DVBT:SOURce[:HIGh]..... 56
[:SOURce<hw>]:BB:DVBT:INPut:LOW..... 56
[:SOURce<hw>]:BB:DVBT:INPut[:HIGh]..... 56
[:SOURce<hw>]:BB:DVBT:INPut:FORMat:LOW..... 56
```

<code>[[:SOURce<hw>]:BB:DVBT:INPut:FORMat.....</code>	56
<code>[[:SOURce<hw>]:BB:DVBT:INPut:TSCHannel[:HIGH].....</code>	57
<code>[[:SOURce<hw>]:BB:DVBT:STUFfing:LOW.....</code>	57
<code>[[:SOURce<hw>]:BB:DVBT:STUFfing[:HIGH].....</code>	57

`[[:SOURce<hw>]:BB:DVBT:SOURce:LOW <SourceLP>`
`[[:SOURce<hw>]:BB:DVBT:SOURce[:HIGH] <SignalSourceHp>`

Sets the modulation source for the input signal.

Parameters:

`<SignalSourceHp>` TSPlayer | EXTernal | TESTsignal
 *RST: EXTernal

Example: See [Example "Configuring general input signal properties"](#) on page 55.

Manual operation: See " [Source](#) " on page 14

`[[:SOURce<hw>]:BB:DVBT:INPut:LOW <InputLP>`
`[[:SOURce<hw>]:BB:DVBT:INPut[:HIGH] <Input>`

Sets the external input interface.

Parameters:

`<Input>` IP | TS

TS
 Input for serial transport stream data. The signal is input at the "User 1/2" connectors.

IP
 Supported for high priority path (HP) only, i.e. setting requires non-hierarchical coding.
 Input for IP transport stream data. The signal is input at the "IP Data" connector.

*RST: TS

Example: See [Example "Configuring general input signal properties"](#) on page 55.

Manual operation: See " [Input](#) " on page 15

`[[:SOURce<hw>]:BB:DVBT:INPut:FORMat:LOW <InputFormatLP>`
`[[:SOURce<hw>]:BB:DVBT:INPut:FORMat <InputFormat>`

Sets the format of the input signal.

Parameters:

`<InputFormat>` ASI | SMPTE
 *RST: ASI

Example: See [Example "Configuring general input signal properties"](#) on page 55.

Manual operation: See " [Input Format](#) " on page 15

[:SOURce<hw>]:BB:DVBT:INPut:TSCHannel[:HIGH] <TSChannel>

Selects the IP-based transport stream (TS) channel. You can select 1 out of 4 IP TS channels as input at the "IP Data" interface.

To configure a particular channel, see [Chapter 3.2.4, "IP Channel x Settings"](#), on page 20.

Parameters:

<TSChannel> 1 | 2 | 3 | 4
 *RST: 1

Example: See [Example "Configuring general input signal properties"](#) on page 55.

Manual operation: See "[IP TS Channel](#)" on page 15

[:SOURce<hw>]:BB:DVBT:STUFfing:LOW <StuffingLP>
[:SOURce<hw>]:BB:DVBT:STUFfing[:HIGH] <StuffingHP>

Activates stuffing.

Parameters:

<StuffingHP> 0 | 1 | OFF | ON
 *RST: 1

Example: See [Example "Configuring general input signal properties"](#) on page 55.

Manual operation: See "[Stuffing](#)" on page 15

5.2.2 Info Commands

Example: Querying input signal properties

```

:SOURce:1:BB:DVBT:SOURce:HIGH EXT
*****
// Query properties of high priority input signals at TS IN interface.
*****
:SOURce:1:BB:DVBT:INPut:HIGH TS
:SOURce:1:BB:DVBT:PACKetlength:HIGH?
// Response: P188
:SOURce:1:BB:DVBT:USEFulF:RATE:MAX:HIGH?
// Response: 19.392659 MBit/s
:SOURce:1:BB:DVBT:USEFulF:RATE:HIGH?
// Response: 17.654321 MBit/s
:SOURce:1:BB:DVBT:INPut:DATArate:HIGH?
// Response: 18.765432 MBit/s

*****
// Query properties od non-hierarc. coded input signals at IP Data interface.
*****
:SOURce:1:BB:DVBT:HIERarchy NONHier
:SOURce:1:BB:DVBT:INPut:HIGH IP
// You can query input signal properties for one IP TS channel only.
// Query properties for , e.g., IP TS channel 2.
:SOURce:1:BB:DVBT:INPut:TSChannel:HIGH 2
:SOURce:1:BB:DVBT:PACKetlength?
// Response: P188
:SOURce:1:BB:DVBT:USEFulF:RATE:MAX:HIGH?
// Response: 432.109876 MBit/s
:SOURce:1:BB:DVBT:USEFulF:RATE:HIGH?
// Response: 400.000000 MBit/s
:SOURce:1:BB:DVBT:INPut:DATArate:HIGH?
// Response: 399.876543 MBit/s

*****
// Query properties of internal TS player input signals.
*****
:SOURce:1:BB:DVBT:SOURce:LOW TSPL
:SOURce:1:BB:DVBT:SOURce:HIGH?
// Response: TEST
// If you change the low priority input signal source to "EXT"/"TSPL", the high
// priority source changes automatically to test signal and vice versa.
:SOURce:1:BB:DVBT:USEFulF:RATE:MAX:HIGH?
// Response: 19.392659 MBit/s
:SOURce:1:BB:DVBT:USEFulF:RATE?
// Response: 17.654321 MBit/s

```

```

[:SOURce<hw>]:BB:DVBT:PACKetlength:LOW?..... 59
[:SOURce<hw>]:BB:DVBT:PACKetlength[:HIGH]?..... 59
[:SOURce<hw>]:BB:DVBT:USEFul[:RATE]:LOW?..... 59

```

<code>[:SOURce<hw>]:BB:DVBT:USEFul[:RATE]:HIGH]?.....</code>	59
<code>[:SOURce<hw>]:BB:DVBT:USEFul[:RATE]:MAX:LOW?.....</code>	59
<code>[:SOURce<hw>]:BB:DVBT:USEFul[:RATE]:MAX[:HIGH]?.....</code>	59
<code>[:SOURce<hw>]:BB:DVBT[:INPut]:DATarate:LOW?.....</code>	60
<code>[:SOURce<hw>]:BB:DVBT[:INPut]:DATarate[:HIGH]?.....</code>	60

`[:SOURce<hw>]:BB:DVBT:PACKetlength:LOW?`
`[:SOURce<hw>]:BB:DVBT:PACKetlength[:HIGH]?`

Queries the packet length of the external transport stream in bytes.

Return values:

<PacketLengthHP> P208 | P204 | INValid | P188

P188|P204|P208

188/204/208 byte packets specified for serial input and parallel input.

INValid

Packet length does not match the specified length.

*RST: INValid

Example: See [Example "Querying input signal properties"](#) on page 58.

Usage: Query only

Manual operation: See "[Packet Length](#)" on page 17

`[:SOURce<hw>]:BB:DVBT:USEFul[:RATE]:LOW?`
`[:SOURce<hw>]:BB:DVBT:USEFul[:RATE]:HIGH]?`

Displays the data rate of useful data r_{useful} of the external transport stream. The data rate is measured at the input of the installed input interface.

Return values:

<UseDRHP> float
 Range: 0 to 9999999999
 Increment: 1000
 *RST: 0

Example: See [Example "Querying input signal properties"](#) on page 58.

Usage: Query only

Manual operation: See "[Useful Data Rate](#)" on page 18

`[:SOURce<hw>]:BB:DVBT:USEFul[:RATE]:MAX:LOW?`
`[:SOURce<hw>]:BB:DVBT:USEFul[:RATE]:MAX[:HIGH]?`

Displays the maximum data rate, that is derived from the current modulation parameter settings.

The value is the optimal value at the TS input interface, that is necessary for the modulator.

If "Stuffing > On", the value indicates the maximum useful data rate, that is allowed in the transport stream.

If "Stuffing > Off", the value indicates the transport stream input data rate that is required for the transport stream.

Return values:

<MaxUseDRHP> integer
 Range: 0 to 9999999999
 *RST: 0

Example: See [Example "Querying input signal properties"](#) on page 58.

Usage: Query only

Manual operation: See "[Max. Useful Data Rate](#)" on page 18

[:SOURce<hw>]:BB:DVBT[:INPut]:DATarate:LOW?

[:SOURce<hw>]:BB:DVBT[:INPut]:DATarate[:HIGH]?

Queries the measured value of the data rate of one of the following:

- External transport stream including null packets input at "User 1" connector
- External transport stream including null packets input at "IP Data/LAN" connector (TSoverIP)

The value equals the sum of useful data rate r_{meas} and the rate of null packets r_0 :

$$r_{\text{meas}} = r_{\text{meas}} + r_0$$

Return values:

<MeasDRHP> float
 Range: 0 to 9999999999
 Increment: 1000
 *RST: 0

Example: See [Example "Querying input signal properties"](#) on page 58.

Usage: Query only

Manual operation: See "[Measured Data Rate](#)" on page 18

5.2.3 Test Signal Commands

Example: Configure test signal properties

```
:SOURce:1:BB:DVBT:SOURce:HIGH TEST
:SOURce:1:BB:DVBT:TESTsignal:HIGH TTSP
// Sets a test TS packet as test signal of the HP input data stream.

*****
// Alternatively, set more specific test signals with PRBS parts within the
// test packet.
*****
:SOURce:1:BB:DVBT:TESTsignal PBEC
// Inserts the PRBS sequence before the convolutional encoder.
:SOURce:1:BB:DVBT:TESTsignal PAFC
// Inserts the PRBS sequence after the convolutional encoder.

*****
// Configure test signal properties.
*****
:SOURce:1:BB:DVBT:TSPacket H184
:SOURce:1:BB:DVBT:PIDTestpack NULL
:SOURce:1:BB:DVBT:PID?
// "8191" in decimal representation
// "1FFF" in hexadecimal representation
:SOURce:1:BB:DVBT:PIDTestpack VAR
:SOURce:1:BB:DVBT:PID 4607
// corresponds to "11FF" in hexadecimal representation
:SOURce:1:BB:DVBT:PAYLoad PRBS
:SOURce:1:BB:DVBT:PRBS P23_1
```

[:SOURce<hw>]:BB:DVBT:PAYLoad	61
[:SOURce<hw>]:BB:DVBT:PID	62
[:SOURce<hw>]:BB:DVBT:PIDTestpack	62
[:SOURce<hw>]:BB:DVBT:PRBS[:SEQUENCE]	62
[:SOURce<hw>]:BB:DVBT:TESTsignal:LOW	62
[:SOURce<hw>]:BB:DVBT:TESTsignal[:HIGH]	62
[:SOURce<hw>]:BB:DVBT:TSPacket	63

[\[:SOURce<hw>\]:BB:DVBT:PAYLoad <Payload>](#)

Defines the payload area content of the TS packet.

Parameters:

<Payload> HFF | H00 | PRBS
 *RST: PRBS

Example: See [Example "Configure test signal properties"](#) on page 61.

Manual operation: See ["Payload Test/Stuff"](#) on page 20

[:SOURce<hw>]:BB:DVBT:PID <PID>

Sets the [PID](#).

Parameters:

<PID> integer
 Range: #H0000 to #H1FFF
 *RST: #H1FFF

Example: See [Example "Configure test signal properties"](#) on page 61.

Manual operation: See ["PID \(Hex\)"](#) on page 20

[:SOURce<hw>]:BB:DVBT:PIDTestpack <PidTestPacket>

If a header is present in the test packet ("Test TS Packet > Head/184 Payload"), you can specify a fixed or variable packet identifier (PID).

Parameters:

<PidTestPacket> NULL | VARIABLE
 *RST: NULL

Example: See [Example "Configure test signal properties"](#) on page 61.

Manual operation: See ["PID Test Packet"](#) on page 19

[:SOURce<hw>]:BB:DVBT:PRBS[:SEQUENCE] <PRBS>

Sets the length of the PRBS sequence.

You can select a PRBS 15 or a PRBS 23 sequence as specified by [ITU-T O.151](#).

Parameters:

<PRBS> P15_1 | P23_1
 *RST: P23_1

Example: See [Example "Configure test signal properties"](#) on page 61.

Manual operation: See ["PRBS"](#) on page 20

[:SOURce<hw>]:BB:DVBT:TESTsignal:LOW <TestSignalLP>

[:SOURce<hw>]:BB:DVBT:TESTsignal[:HIGH] <TestSignalHP>

Defines the test signal data.

Parameters:

<TestSignalHP> TTSP | PBEC | PAFC

TTSP

Test TS packet with standardized packet data used as modulation data in the transport stream.

PBEC

PRBS before convolutional encoder

Pure pseudo-random bit sequence (PRBS) data used as modulation data with no packet structure. The sequence is inserted before the convolutional encoder. PRBS data conforms with [ITU-T O.151](#) specification.

PAFC

PRBS after convolutional encoder

Pure pseudo-random bit sequence (PRBS) data used as modulation data with no packet structure. The sequence is inserted after the convolutional encoder.

*RST: TTSP

Example: See [Example "Configure test signal properties"](#) on page 61.

Manual operation: See ["Test Signal"](#) on page 16

[:SOURCE<hw>]:BB:DVBT:TSPacket <TSPacket>

Specifies the structure of the test transport stream packet that is fed to the modulator.

Parameters:

<TSPacket> S187 | H184

*RST: H184

Example: See [Example "Configure test signal properties"](#) on page 61.

Manual operation: See ["Test TS Packet"](#) on page 19

5.2.4 IP Subsystem

The `SOURCE:BB:INPUT:IP` subsystem contains the commands for configuring input IP data from a local IP data network.

To configure local IP data network parameters, see [Chapter 5.7, "BCIP Subsystem"](#), on page 80.

Common suffixes

The following common suffixes are used in the `SOURCE:BB:INPUT:IP` remote commands:

Suffix	Value range	Description
IP<ch>	1 to 4	IP channel number

Example: Configure IP channel 2 properties

```
// Use the data from IP channel 2 as input for modulation data.
:SOURCE1:BB:INPUT:IP2:STATE ON
// Specify alias as "Alias 2".
:SOURCE1:BB:INPUT:IP2:ALIAS "Alias 2"
```

```

//*****
// Define Unicast properties.
//*****
:SOURce1:BB:INPut:IP2:TYPe UNI
// Local IP data interface is configured for Unicast reception
:SOURce1:BB:INPut:IP2:PORT 6002

//*****
// Define Multicast properties.
//*****
:SOURce1:BB:INPut:IP2:TYPe MULT
// Local IP data interface is configured for Multicast reception
:SOURce1:BB:INPut:IP2:MULTicast:ADDRes?
// Response: "226.0.0.0"
:SOURce1:BB:INPut:IP2:IGMP:SOURce:ADDRes?
// Response: "0.0.0.0"
:SOURce1:BB:INPut:IP2:IGMP:SOURce:ADDRes "192.168.10.1"
:SOURce1:BB:INPut:IP2:IGMP:SOURce:PING
:SOURce1:BB:INPut:IP2:IGMP:SOURce:RESult?
// Response: "Ping: Successful"

```

Commands

[:SOURce<hw>]:BB:INPut:IP<ch>[:STATe].....	64
[:SOURce<hw>]:BB:INPut:IP<ch>:ALias.....	64
[:SOURce<hw>]:BB:INPut:IP<ch>:PORT.....	65
[:SOURce<hw>]:BB:INPut:IP<ch>:TYPe.....	65
[:SOURce<hw>]:BB:INPut:IP<ch>:MULTicast:ADDRes.....	65
[:SOURce<hw>]:BB:INPut:IP<ch>:IGMP[:SOURce]:ADDRes.....	66
[:SOURce<hw>]:BB:INPut:IP<ch>:IGMP[:SOURce]:PING.....	66
[:SOURce<hw>]:BB:INPut:IP<ch>:IGMP[:SOURce]:RESult?.....	66

[:SOURce<hw>]:BB:INPut:IP<ch>[:STATe] <Alias>

Activates/deactivates the "IP Channel x" as IP input.

Specify the current IP TS Channel with the command

`SOURce1:BB:DigStd:INPut:TSCHannel`. `DigStd` stands for the IP TS Channel in the corresponding broadcast standard.

Parameters:

<Alias> 0 | 1 | OFF | ON
 *RST: 0

Example: See [Example "Configure IP channel 2 properties"](#) on page 63.

Manual operation: See ["Input IP"](#) on page 22

[:SOURce<hw>]:BB:INPut:IP<ch>:ALias <Alias>

Specifies an alias, i.e. name for the IP connection.

Parameters:

<Alias> string

Example: See [Example "Configure IP channel 2 properties"](#) on page 63.

Manual operation: See ["Alias"](#) on page 22

[:SOURce<hw>]:BB:INPut:IP<ch>:PORT <Port>

Sets the port of the input IP data at the "IP Data" connector.

Parameters:

<Port> integer
Range: 0 to 65535
*RST: 6002

Example: See [Example "Configure IP channel 2 properties"](#) on page 63.

Manual operation: See ["Port"](#) on page 23

[:SOURce<hw>]:BB:INPut:IP<ch>:TYPE <Type>

Sets the IP input type.

Parameters:

<Type> UNicast | MULTicast

UNicast

Analyzes all unicast IP packets that arrive at the specified port.
See [\[:SOURce<hw>\]:BB:INPut:IP<ch>:PORT](#) on page 65.

MULTicast

When an IP address is in the multicast address range, an attempt is made to join a multicast group using IGMP. Set multicast address and port.

See:

[\[:SOURce<hw>\]:BB:INPut:IP<ch>:MULTicast:ADDRESS](#)
on page 65

[\[:SOURce<hw>\]:BB:INPut:IP<ch>:PORT](#) on page 65

*RST: UNicast

Example: See [Example "Configure IP channel 2 properties"](#) on page 63.

Manual operation: See ["Type"](#) on page 22

[:SOURce<hw>]:BB:INPut:IP<ch>:MULTicast:ADDRESS

Sets the destination IP address (IPv4) of the IP connection.

Parameters:

<Address> string
Range: 224.0.0.0 to 239.255.255.255

Example: See [Example "Configure IP channel 2 properties"](#) on page 63.

Manual operation: See ["Multicast Address"](#) on page 22

[:SOURce<hw>]:BB:INPut:IP<ch>:IGMP[:SOURce]:ADDReSS

Specifies the IGMP source address of the network.

Parameters:

<Address> string

Example: See [Example "Configure IP channel 2 properties"](#) on page 63.

Manual operation: See ["IGMPv3 Source Address"](#) on page 23

[:SOURce<hw>]:BB:INPut:IP<ch>:IGMP[:SOURce]:PING

Triggers ping of the IGMP source address in the local IP data network. Query the result via `[:SOURce<hw>]:BB:INPut:IP<ch>:IGMP[:SOURce]:RESult?` on page 66.

Example: See [Example "Configure IP channel 2 properties"](#) on page 63.

Usage: Event

Manual operation: See ["Ping Source Address"](#) on page 23

[:SOURce<hw>]:BB:INPut:IP<ch>:IGMP[:SOURce]:RESult?

Queries the result of pinging the IGMP source address.

See `[:SOURce<hw>]:BB:INPut:IP<ch>:IGMP[:SOURce]:PING` on page 66.

Return values:

<PingResult> string
Returns ping messages.

Example: See [Example "Configure IP channel 2 properties"](#) on page 63.

Usage: Query only

Manual operation: See ["Ping Result"](#) on page 23

5.3 Coding Commands

Example: Configure coding properties

```
:SOURce:1:BB:DVBT:HIERarchy?
// Response: NONHierarchical

:SOURce:1:BB:DVBT:CONstel T64
:SOURce:1:BB:DVBT:CHANnel:BANDwidth BW_8
:SOURce:1:BB:DVBT:CHANnel:USED:BANDwidth?
```

```
// Response [Hz]: 7607142.9
:SOURce:1:BB:DVBT:CHANnel:USED:BANDwidth 7607142.7
:SOURce:1:BB:DVBT:CHANnel:BANDwidth?
// Response: BW_V
:SOURce:1:BB:DVBT:FFT:MODE M8K
:SOURce:1:BB:DVBT:GUARd:INTerval G1_32
:SOURce:1:BB:DVBT:DVHState 1
:SOURce:1:BB:DVBT:DVbH:SYMBOL:INTerleaver IND
:SOURce:1:BB:DVBT:RATE:HIGH R5_6

:SOURce:1:BB:DVBT:HIERarchy A1
:SOURce:1:BB:DVBT:RATE:HIGH?
// Response: R5_6
:SOURce:1:BB:DVBT:RATE:LOW R3_4
```

[:SOURce<hw>]:BB:DVBT:CHANnel[:BANDwidth]	67
[:SOURce<hw>]:BB:DVBT:CONStel	67
[:SOURce<hw>]:BB:DVBT:DVbH:SYMBOL[:INTerleaver]	67
[:SOURce<hw>]:BB:DVBT:DVHState	68
[:SOURce<hw>]:BB:DVBT:FFT:MODE	68
[:SOURce<hw>]:BB:DVBT:GUARd:INTerval	68
[:SOURce<hw>]:BB:DVBT:RATE:LOW	68
[:SOURce<hw>]:BB:DVBT:RATE[:HIGH]	68
[:SOURce<hw>]:BB:DVBT:USED[:BANDwidth]	69

[\[:SOURce<hw>\]:BB:DVBT:CHANnel\[:BANDwidth\]](#) <ChannelBW>

Selects the channel bandwidth.

Parameters:

<ChannelBW> BW_Var | BW_8 | BW_7 | BW_5 | BW_6
 *RST: BW_8

Example: See [Example "Configure coding properties"](#) on page 66.

Manual operation: See ["Channel Bandwidth"](#) on page 25

[\[:SOURce<hw>\]:BB:DVBT:CONStel](#) <Constel>

Defines the constellation.

Parameters:

<Constel> T64 | T16 | T4
 *RST: T64

Example: See [Example "Configure coding properties"](#) on page 66.

Manual operation: See ["Constellation"](#) on page 25

[\[:SOURce<hw>\]:BB:DVBT:DVbH:SYMBOL\[:INTerleaver\]](#) <SymbInterleaver>

Sets the symbol interleaver.

Parameters:

<SymbInterleaver> INDepth | NATive
 *RST: NATive

Example: See [Example "Configure coding properties"](#) on page 66.

Manual operation: See "[Symbol Interleaver](#)" on page 26

[:SOURCE<hw>]:BB:DVBT:DVHState <DVHState>

Enables or disables [DVB-H](#).

Parameters:

<DVHState> 0 | 1 | OFF | ON
 *RST: 0

Example: See [Example "Configure coding properties"](#) on page 66.

Manual operation: See "[DVB-H State](#)" on page 26

[:SOURCE<hw>]:BB:DVBT:FFT:MODE <FFTMMode>

Sets the fast fourier transform (FFT) window to determine the number of carriers per OFDM symbol.

To find out the number of carriers for a given FFT window, see [Table 3-3](#).

Parameters:

<FFTMMode> M8K | M4K | M2K
 *RST: M8K

Example: See [Example "Configure coding properties"](#) on page 66.

Manual operation: See "[FFT-Mode](#)" on page 25

[:SOURCE<hw>]:BB:DVBT:GUARD:INTERVAL <Guardint>

Sets the guard interval. The interval is expressed in fractions of the useful part of the OFDM symbol period T_u .

Parameters:

<Guardint> G1_32 | G1_16 | G1 | G1_ | G1_8 | G1_4
 *RST: G1_32

Example: See [Example "Configure coding properties"](#) on page 66.

Manual operation: See "[Guard Interval](#)" on page 26

[:SOURCE<hw>]:BB:DVBT:RATE:LOW <CodeRateLP>

[:SOURCE<hw>]:BB:DVBT:RATE[:HIGH] <CoderateHP>

Sets the code rate.

Parameters:

<CoderateHP> R1_2 | R2_3 | R3_4 | R5_6 | R7_8
 *RST: R3_4

Example: See [Example "Configure coding properties"](#) on page 66.

Manual operation: See [" Code Rate "](#) on page 27

[:SOURce<hw>]:BB:DVBT:USED[:BANDwidth] <UsedBW>

Defines the used bandwidth.

Parameters:

<UsedBW> float
 Range: 1000000 to 10000000
 Increment: 0.1
 *RST: 66562500

Example: See [Example "Configure coding properties"](#) on page 66.

Manual operation: See [" Used Bandwidth "](#) on page 25

5.4 TPS Commands

Example: Configure transmission parameter signaling properties

```
:SOURce:1:BB:DVBT:CELL:ID #H0
:SOURce:1:BB:DVBT:TPSReserved:STATE 1
:SOURce:1:BB:DVBT:TPSReserved:VALue #H0
:SOURce:1:BB:DVBT:HIERarchy A1
```

```
:SOURce:1:BB:DVBT:TIMeslice:HIGH 1
:SOURce:1:BB:DVBT:TIMeslice:LOW 0
:SOURce:1:BB:DVBT:MPEFec:HIGH 0
:SOURce:1:BB:DVBT:MPEFec:LOW 1
```

[:SOURce<hw>]:BB:DVBT:CELL:ID	69
[:SOURce<hw>]:BB:DVBT:MPEFec:LOW	70
[:SOURce<hw>]:BB:DVBT:MPEFec[:HIGH]	70
[:SOURce<hw>]:BB:DVBT:TIMeslice:LOW	70
[:SOURce<hw>]:BB:DVBT:TIMeslice[:HIGH]	70
[:SOURce<hw>]:BB:DVBT:TPSReserved:STATE	70
[:SOURce<hw>]:BB:DVBT:TPSReserved:VALue	71

[:SOURce<hw>]:BB:DVBT:CELL:ID <CellID>

Sets the cell ID in four-digit hexadecimal format.

Parameters:

<CellID> integer
 Range: #H0000 to #HFFFF
 *RST: #H000

Example: See [Example "Configure transmission parameter signaling properties"](#) on page 69.

Manual operation: See ["TPS Cell ID \(Hex\)"](#) on page 27

[:SOURCE<hw>]:BB:DVBT:MPEFec:LOW <MPEFecLP>
[:SOURCE<hw>]:BB:DVBT:MPEFec[:HIGH] <MPEFecHP>

Enables/disables [MPE FEC](#).

If enabled, 1 TPS bit (s49) is used to signal that MPE FEC is used in at least one data stream.

Parameters:

<MPEFecHP> 0 | 1 | OFF | ON
 *RST: 0

Example: See [Example "Configure transmission parameter signaling properties"](#) on page 69.

Manual operation: See ["MPE FEC"](#) on page 29

[:SOURCE<hw>]:BB:DVBT:TIMeslice:LOW <TimeSlicingLP>
[:SOURCE<hw>]:BB:DVBT:TIMeslice[:HIGH] <TimeSlicingHP>

Enables/disables time slicing.

If enabled, 1 TPS bit (s48) is used to signal that at least one data stream with time slicing exists in the multiplex.

Parameters:

<TimeSlicingHP> 0 | 1 | OFF | ON
 *RST: 0

Example: See [Example "Configure transmission parameter signaling properties"](#) on page 69.

Manual operation: See ["Time Slicing"](#) on page 28

[:SOURCE<hw>]:BB:DVBT:TPSReserved:STATE <TPSReserved>

Enables or disables the reserved TPS bits.

Parameters:

<TPSReserved> OFF | ON | 1 | 0
 *RST: OFF

Example: See [Example "Configure transmission parameter signaling properties"](#) on page 69.

Manual operation: See "TPS Reserved State" on page 28

[:SOURCE<hw>]:BB:DVBT:TPSReserved:VALue <ReservedBits>

Sets the reserved bits in one-digit hexadecimal format.

Parameters:

<ReservedBits> integer
 Range: #H0 to #HF
 *RST: #H0

Example: See [Example "Configure transmission parameter signaling properties"](#) on page 69.

Manual operation: See "TPS Reserved Bits (Hex)" on page 28

5.5 Special Commands

Example: Configure special settings

```
*****
// Standard-compliant configuration.
*****
:SOURCE:1:BB:DVBT:SPECIAL:REEDsolomon:HIGH?
// Response: ON
:SOURCE:1:BB:DVBT:SPECIAL:REEDsolomon:LOW?
// Response: ON
:SOURCE:1:BB:DVBT:SPECIAL:SETTings:STATe?
// Response: 0

*****
// Non-standard configuration.
*****
:SOURCE:1:BB:DVBT:SPECIAL:REEDsolomon:HIGH OFF
:SOURCE:1:BB:DVBT:SPECIAL:REEDsolomon:LOW OFF
:SOURCE:1:BB:DVBT:SPECIAL:SETTing:STATe 1

[:SOURCE<hw>]:BB:DVBT[:SPECIAL]:REEDsolomon:LOW..... 71
[:SOURCE<hw>]:BB:DVBT[:SPECIAL]:REEDsolomon[:HIGH]..... 71
[:SOURCE<hw>]:BB:DVBT[:SPECIAL]:SETTing[:STATe]..... 72
```

[:SOURCE<hw>]:BB:DVBT[:SPECIAL]:REEDsolomon:LOW <ReedSolomonLow>

[:SOURCE<hw>]:BB:DVBT[:SPECIAL]:REEDsolomon[:HIGH] <ReedSolomonHigh>

Enables/disables the Reed-Solomon encoder.

Parameters:

<ReedSolomonHigh> OFF | ON | 1 | 0
 *RST: ON

Example: See [Example "Configure special settings"](#) on page 71.

Manual operation: See [" Reed Solomon "](#) on page 30

[:SOURce<hw>]:BB:DVBT[:SPECial]:SETTing[:STATe] <Settings>

Enables/disables special settings.

The setting allows you to switch between standard-compliant and user-defined channel coding.

Parameters:

<Settings> 0 | 1 | OFF | ON
 *RST: 0

Example: See [Example "Configure special settings"](#) on page 71.

Manual operation: See [" Special Settings "](#) on page 30

5.6 TSGen Subsystem

The TSGen subsystem contains the commands for configuring the TS player.

Example: Play a TS player file

```
//*****
// Select a file, e.g. a user-defined setting.
//*****
:TSGen:CONFigure:PLAYfile "/var/user/my_test_player_test.trp"
// Selects the file "my_test_player_test" with extension *.trp.

//*****
// Within the file, define a section, that you want to play.
// You can set start/stop position for a maximum section length of 10 hours.
//*****
:TSGen:CONFigure:SEEK:START 60000 // milliseconds
// Section start is after one minute from the original file start.
// The first minute is ignored.
:TSGen:CONFigure:SEEK:STOP 120000 // milliseconds
// Section stop is after one minute from the original file start.
// The total section length is one minute.

//*****
// Navigate to a certain position within the file/section of the file.
//*****
:TSGen:CONFigure:SEEK:POSition 100000 // milliseconds
// The current player position of file/section of the file is at 1 minute 40 seconds.

//*****
// Reset play-related settings
```



```

//*****
:TSGen:CONFigure:SEEK:RESet

//*****
// Pause, stop, play the file.
//*****
:TSGen:CONFigure:COMMand PAUS
// Pauses playing the file.
:TSGen:CONFigure:COMMand STOP
// Stops playing the file.
:TSGen:CONFigure:COMMand PLAY
// Activates playing the file.

```

Example: Configure and monitor TS player output

```

//*****
// Configure general and stuffing parameters of the TS player output.
//*****
:TSGen:CONFigure:STUFFing ON
:TSGen:CONFigure:STOPdata TTSP
:TSGen:CONFigure:TSPacket H184
//:TSGen:CONFigure:PIDTestpacket VAR
:TSGen:CONFigure:PIDTestpack VAR
:TSGen:CONFigure:PID 8100
// Corresponds to a PID = 1FA4 in hexadecimal format.
:TSGen:CONFigure:PAYLoad PRBS
:TSGen:CONFigure:PRBS:SEQuence P23_1

//*****
// Monitor TS player output data.
//*****
:TSGen:CONFigure:COMMand STOP
// TSPRate can only be changed if player is in stop mode
:TSGen:CONFigure:TSPRate 350E6 // net data rate = 350 MBit/s
:TSGen:CONFigure:COMMand PLAY

:TSGen:CONFigure:PLENght?
// Response: P188 // packet length = 188 byte
:TSGen:READ:ORIGtsrate?
// Response: 5018502 bit/s

```

Example: Configure seamless loop parameters

```

:TSGen:CONFigure:SEAMless:CC ON
:TSGen:CONFigure:SEAMless:PCR OFF
:TSGen:CONFigure:SEAMless:TT ON

```

Commands

:TSGen:CONFigure:COMMand<ch>	74
:TSGen:CONFigure:PAYLoad	74
:TSGen:CONFigure:PID	74
:TSGen:CONFigure:PIDTestpack	75

:TSGen:CONFigure:PLAYfile.....	75
:TSGen:CONFigure:PLENght.....	75
:TSGen:CONFigure:PRBS[:SEQuence].....	75
:TSGen:CONFigure:SEAMless:CC.....	76
:TSGen:CONFigure:SEAMless:PCR.....	76
:TSGen:CONFigure:SEAMless:TT.....	76
:TSGen:CONFigure:SEEK:POSition.....	77
:TSGen:CONFigure:SEEK:RESet.....	77
:TSGen:CONFigure:SEEK:STARt.....	77
:TSGen:CONFigure:SEEK:STOP.....	77
:TSGen:CONFigure:STOPdata.....	78
:TSGen:CONFigure:STUFFing.....	78
:TSGen:CONFigure:TSPacket.....	78
:TSGen:CONFigure:TSRate.....	78
:TSGen:READ:FMEMory.....	79
:TSGen:READ:ORIGtsrate.....	79
:TSGen:READ:PLAYfile:LENGth?.....	79

:TSGen:CONFigure:COMMand<ch>

Triggers playing, pausing and stopping of the TS player file selected with `:TSGen:CONFigure:PLAYfile`.

Setting parameters:

<PlayerStatus> STOP | PLAY | PAUSE
 *RST: STOP

Example: See [Example "Play a TS player file"](#) on page 72.

Usage: Event

Manual operation: See ["Play"](#) on page 35

:TSGen:CONFigure:PAYLoad <PayLoad>

Determines the payload of the test packet. Also influences the payload of the generated stuffing packets while the TS player is running.

Parameters:

<PayLoad> HFF | H00 | PRBS
 *RST: PRBS

Example: See [Example "Configure and monitor TS player output"](#) on page 73.

Manual operation: See ["Payload Test/Stuff"](#) on page 39

:TSGen:CONFigure:PID <PID>

The available values depend on the settings of `:TSGen:CONFigure:PIDTestpack`.

If `:TSGen:CONFigure:PIDTestpack` is set to NULL,
then `:TSGen:CONFigure:PID` is 1FFF (hex).

Otherwise the values are variable.

Parameters:

<PID> integer
Range: 0 to 8191
*RST: 8191

Example: See [Example "Configure and monitor TS player output"](#) on page 73.

Manual operation: See ["PID \(Hex\)"](#) on page 39

:TSGen:CONFigure:PIDTestpack <PIDTestpack>

Sets the PID, if `:TSGen:CONFigure:TSPacket` is H184 | H200 | H204.

Parameters:

<PIDTestpack> VARIable | NULL
*RST: NULL

Example: See [Example "Configure and monitor TS player output"](#) on page 73.

Manual operation: See ["PID Test Packet"](#) on page 39

:TSGen:CONFigure:PLAYfile <PlayFile>

Specifies the file path and filename of the TS player file.

Parameters:

<PlayFile> string

Example: See [Example "Play a TS player file"](#) on page 72.

Manual operation: See ["Select File"](#) on page 33

:TSGen:CONFigure:PLENght <PLength>

Queries the packet length of the loaded file.

Parameters:

<PLength> P188 | P204 | P208 | INV
*RST: INV

Example: See [Example "Configure and monitor TS player output"](#) on page 73.

:TSGen:CONFigure:PRBS[:SEQUence] <PRBS>

Sets the length of the PRBS sequence.

Parameters:

<PRBS> P15_1 | P23_1
 *RST: P23_1

Example: See [Example "Configure and monitor TS player output"](#) on page 73.

Manual operation: See ["PRBS"](#) on page 39

:TSGen:CONFigure:SEAMless:CC <CC>

Activates the correction of the continuity counters in the replayed TS data stream. The correction allows you to decode the stream without interruption when the play file is looping.

Parameters:

<CC> 0 | 1 | OFF | ON
 *RST: 0

Example: See [Example "Configure seamless loop parameters"](#) on page 73.

Manual operation: See ["Continuity Counter"](#) on page 40

:TSGen:CONFigure:SEAMless:PCR <PCR>

Activates the correction of time stamps in the replayed TS data stream. The correction allows you to decode the stream without interruption when the play file is looping.

Parameters:

<PCR> 0 | 1 | OFF | ON
 *RST: 0

Example: See [Example "Configure seamless loop parameters"](#) on page 73.

Manual operation: See ["PCR, DTS/PTS"](#) on page 40

:TSGen:CONFigure:SEAMless:TT <TT>

Activates the correction of the time and date table in the replayed TS data stream. The correction allows you to decode the stream without interruption when the play file is looping.

Parameters:

<TT> 0 | 1 | OFF | ON
 *RST: 0

Example: See [Example "Configure seamless loop parameters"](#) on page 73.

Manual operation: See ["TDT/TOT"](#) on page 40

:TSGen:CONFigure:SEEK:POSition <Position>

Sets the position, that is the current playing time position.

You can select a value in a 10-hour range.

Parameters:

<Position>	float
Range:	0 to 36000000
Increment:	0.1
*RST:	0

Example: See [Example "Play a TS player file"](#) on page 72.

Manual operation: See ["Running/Position Player \[hh:mm:ss.fff\]"](#) on page 33

:TSGen:CONFigure:SEEK:RESet

Resets the following parametets to their default state:

- [:TSGen:CONFigure:SEEK:START](#) on page 77
- [:TSGen:CONFigure:SEEK:STOP](#) on page 77

Example: See [Example "Play a TS player file"](#) on page 72.

Manual operation: See ["Reset Window"](#) on page 35

:TSGen:CONFigure:SEEK:START <Start>

Sets an individual start time.

You can select a value in a 10-hour range.

Parameters:

<Start>	float
Range:	0 to 36000000
Increment:	0.1
*RST:	0

Example: See [Example "Play a TS player file"](#) on page 72.

Manual operation: See ["Start \[hh:mm:ss.fff\]"](#) on page 35

:TSGen:CONFigure:SEEK:STOP <Stop>

Sets an individual stop time.

You can select a value in a 10-hour range.

Parameters:

<Stop>	float
Range:	0 to 36000000
Increment:	0.1
*RST:	23040.2

Example: See [Example "Play a TS player file"](#) on page 72.

Manual operation: See ["Stop \[hh:mm:ss.fff\]"](#) on page 35

:TSGen:CONFigure:STOPdata <StopData>

Ensures that a standardized TS data stream is always output at the TS output at the rear of the R&S SMCV100B.

Parameters:

<StopData> TTSP | NONE
*RST: NONE

Example: See [Example "Configure and monitor TS player output"](#) on page 73.

Manual operation: See ["Stop Data"](#) on page 37

:TSGen:CONFigure:STUFfing <Stuffing>

Enables or disables nullpacket stuffing.

Parameters:

<Stuffing> 0 | 1 | OFF | ON
*RST: 0

Example: See [Example "Configure and monitor TS player output"](#) on page 73.

Manual operation: See ["Nullpacket Stuffing"](#) on page 37

:TSGen:CONFigure:TSPacket <TSPaket>

Sets the structure of the generated test packets in pause or stop status.

Parameters:

<TSPaket> H184 | H200 | H204 | S187 | S203 | S207
S187|S203|S207
A sync byte (0x47) followed by 187/203/207 payload bytes.
H184|H200|H204
A sync byte (0x47) followed by three header bytes and 184/200/204 payload bytes.
*RST: H184

Example: See [Example "Configure and monitor TS player output"](#) on page 73.

Manual operation: See ["Packet Length"](#) on page 37

:TSGen:CONFigure:TSRate <TSRate>

Sets the output data rate of the player.

Parameters:

<TSRate> integer
 Range: 1 to 35E7
 *RST: 5018502

Example: See [Example "Configure and monitor TS player output"](#) on page 73.

Manual operation: See ["Data Rate"](#) on page 36

:TSGen:READ:FMEemory <FMemory>

Queries the file size of the TS player file.

Parameters:

<FMemory> integer
 Range: 0 to 10
 *RST: 0

Example: See [Example "Configure and monitor TS player output"](#) on page 73.

Manual operation: See ["Select File"](#) on page 33

:TSGen:READ:ORIGtsrate <ORIGtsrate>

Displays the calculated original TS data rate.

Parameters:

<ORIGtsrate> integer
 Range: 1 to 350000000
 *RST: 5018502

Example: See [Example "Configure and monitor TS player output"](#) on page 73.

Manual operation: See ["Orig. Data Rate"](#) on page 36

:TSGen:READ:PLAYfile:LENGth?

Queries calculated original loop time.

Return values:

<Length> integer
 Range: 0 to 100
 *RST: 0

Example: See [Example "Configure and monitor TS player output"](#) on page 73.

Usage: Query only

Manual operation: See ["Select File"](#) on page 33

5.7 BCIP Subsystem

The `SYSTEM:COMMunicate:BCIP` subsystem contains the commands for configuring local IP data network parameters.

Common suffixes

The following common suffixes are used in the remote commands:

Suffix	Value range	Description
BCIP<hw>	1	Available local IP LAN interfaces

Example: Retrieving information on local network-related settings

```
//*****
// Monitor IP interface 1 local network status.
//*****
:SYSTEM:COMMunicate:BCIP1:NETWork:STATus?
// Response: "0"
// The instrument is disconnected from the local IP network.
:SYSTEM:COMMunicate:BCIP1:NETWork:REStart
:SYSTEM:COMMunicate:BCIP1:NETWork:STATus?
// Response: "1"

//*****
// Query local IP data network properties.
//*****
:SYSTEM:COMMunicate:BCIP1:NETWork:COMMon:HOSTname?
// Response: "SMCV100B-123456-IP-Data"
:SYSTEM:COMMunicate:BCIP1:NETWork:IPAdDress:MODE STAT
:SYSTEM:COMMunicate:BCIP1:NETWork:IPAdDress "10.113.0.104"
:SYSTEM:COMMunicate:BCIP1:NETWork:IPAdDress:SUBNet:MASK "255.255.252.0"
:SYSTEM:COMMunicate:BCIP1:NETWork:MACAdDress?
// Response: "00 90 B8 21 89 F8"
:SYSTEM:COMMunicate:BCIP1:NETWork:PROTOcol?
// Response: "UDP"
```

Commands

```
:SYSTEM:COMMunicate:BCIP<hw>:NETWork:COMMon:HOSTname..... 81
:SYSTEM:COMMunicate:BCIP<hw>:NETWork:IPAdDress..... 81
:SYSTEM:COMMunicate:BCIP<hw>:NETWork:IPAdDress:MODE..... 81
:SYSTEM:COMMunicate:BCIP<hw>:NETWork:IPAdDress:SUBNet:MASK..... 81
:SYSTEM:COMMunicate:BCIP<hw>:NETWork:MACAdDress..... 82
:SYSTEM:COMMunicate:BCIP<hw>:NETWork:PROTOcol..... 82
:SYSTEM:COMMunicate:BCIP<hw>:NETWork:REStart..... 82
:SYSTEM:COMMunicate:BCIP<hw>:NETWork:STATus..... 82
```

:SYSTem:COMMunicate:BCIP<hw>:NETWork:COMMon:HOSTname <Hostname>

Sets an individual hostname for the vector signal generator.

Note: We recommend that you do not change the hostname to avoid problems with the network connection. If you change the hostname, be sure to use a unique name.

Parameters:

<Hostname> string

Example: See [Example "Retrieving information on local network-related settings"](#) on page 80.

Manual operation: See ["Hostname"](#) on page 42

:SYSTem:COMMunicate:BCIP<hw>:NETWork:IPADdress

Sets the IP address.

Parameters:

<IpAddress> string
 Range: 0.0.0.0 to 255.255.255.255
 *RST: 0.0.0.0

Example: See [Example "Retrieving information on local network-related settings"](#) on page 80.

Manual operation: See ["IP Address"](#) on page 42

:SYSTem:COMMunicate:BCIP<hw>:NETWork:IPADdress:MODE <IPMode>

Selects manual or automatic setting of the IP address.

Parameters:

<IPMode> AUTO | STATic
 *RST: AUTO

Example: See [Example "Retrieving information on local network-related settings"](#) on page 80.

Manual operation: See ["Address Mode"](#) on page 42

:SYSTem:COMMunicate:BCIP<hw>:NETWork:IPADdress:SUBNet:MASK

Sets the subnet mask.

Parameters:

<Mask> string
 Range: 0.0.0.0 to 255.255.255.255
 *RST: 0.0.0.0

Example: See [Example "Retrieving information on local network-related settings"](#) on page 80.

Manual operation: See ["Subnet Mask"](#) on page 43

:SYSTem:COMMunicate:BCIP<hw>:NETWork:MACAddress <MACAddress>

Queries the MAC address of the network adapter.

Parameters:

<MACAddress> string
 Range: 00:00:00:00:00:00 to ff:ff:ff:ff:ff:ff

Example: See [Example "Retrieving information on local network-related settings"](#) on page 80.

Manual operation: See ["MAC Address"](#) on page 43

:SYSTem:COMMunicate:BCIP<hw>:NETWork:PROTocol <Protocol>

Specifies the network protocol.

Parameters:

<Protocol> UDP
 *RST: UDP

Example: See [Example "Retrieving information on local network-related settings"](#) on page 80.

Manual operation: See ["Protocol"](#) on page 43

:SYSTem:COMMunicate:BCIP<hw>:NETWork:REStart

Triggers a restart of the network.

Example: See [Example "Retrieving information on local network-related settings"](#) on page 80.

Usage: Event

Manual operation: See ["Restart Network"](#) on page 42

:SYSTem:COMMunicate:BCIP<hw>:NETWork:STATus <NetworkStatus>

Queries the network connection state.

Parameters:

<NetworkStatus> 0 | 1 | OFF | ON
 *RST: n.a. (no preset. default: 0)

Example: See [Example "Retrieving information on local network-related settings"](#) on page 80.

Manual operation: See ["Network Status"](#) on page 41

Glossary: Abbreviations

A

ASI: Asynchronous Serial Interface

D

DHCP: Dynamic Host Configuration Protocol

DVB-H: Digital Video Broadcast - Handheld

DVB-T: Digital Video Broadcast - Terrestrial

F

FEC: Forward Error Correction

I

IGMP: Internet Group Management Protocol

IGMPv3: Internet Group Management Protocol version 3

M

MAC: Media Access Control

MPE FEC: Multiprotocol encapsulation forward error correction

MPEG: Moving Picture Experts Group

<https://mpeg.chiariglione.org/>

O

OFDM: Orthogonal Frequency-Division Multiplexing

P

PID: Packet Identifier

PRBS: Pseudo-Random Bit Sequence

R

RTP: Real-Time Transport Protocol

S

SFN: Single-frequency Network

SMPTE: Society of Motion Picture and Television Engineers

<https://www.smpte.org/>

T

TCP: Transmission Control Protocol

TPS: Transmission Parameter Signalling

TS: Transport Stream

U

UDP: User Datagram Protocol

V

VSB: Vestigial Sideband Modulation

Glossary: Specifications

E

ETSI EN 300 744: Digital Video Broadcasting (DVB); Framing structure, channel coding and modulation for digital terrestrial television
https://www.etsi.org/deliver/etsi_en/300700_300799/300744/

I

ITU-T O.151: ITU-T Recommendation O.151
<https://www.itu.int/rec/T-REC-O.151-199210-I/en>

List of commands

:SYSTem:COMMunicate:BCIP<hw>:NETWork:COMMon:HOSTname.....	81
:SYSTem:COMMunicate:BCIP<hw>:NETWork:IPADdress.....	81
:SYSTem:COMMunicate:BCIP<hw>:NETWork:IPADdress:MODE.....	81
:SYSTem:COMMunicate:BCIP<hw>:NETWork:IPADdress:SUNet:MASK.....	81
:SYSTem:COMMunicate:BCIP<hw>:NETWork:MACAddress.....	82
:SYSTem:COMMunicate:BCIP<hw>:NETWork:PROToCol.....	82
:SYSTem:COMMunicate:BCIP<hw>:NETWork:REStart.....	82
:SYSTem:COMMunicate:BCIP<hw>:NETWork:STATus.....	82
:TSGen:CONFigure:COMManD<ch>.....	74
:TSGen:CONFigure:PAYLoad.....	74
:TSGen:CONFigure:PID.....	74
:TSGen:CONFigure:PIDTestpack.....	75
:TSGen:CONFigure:PLAYfile.....	75
:TSGen:CONFigure:PLENght.....	75
:TSGen:CONFigure:PRBS[:SEQuence].....	75
:TSGen:CONFigure:SEAMless:CC.....	76
:TSGen:CONFigure:SEAMless:PCR.....	76
:TSGen:CONFigure:SEAMless:TT.....	76
:TSGen:CONFigure:SEEK:POStion.....	77
:TSGen:CONFigure:SEEK:RESet.....	77
:TSGen:CONFigure:SEEK:StARt.....	77
:TSGen:CONFigure:SEEK:StOP.....	77
:TSGen:CONFigure:StOPdata.....	78
:TSGen:CONFigure:StUffing.....	78
:TSGen:CONFigure:TSPacket.....	78
:TSGen:CONFigure:TSRate.....	78
:TSGen:READ:FMEMory.....	79
:TSGen:READ:ORIGtsrate.....	79
:TSGen:READ:PLAYfile:LENGth?.....	79
[:SOURce<hw>]:BB:DVBT:CELL:ID.....	69
[:SOURce<hw>]:BB:DVBT:CHANnel[:BANDwidth].....	67
[:SOURce<hw>]:BB:DVBT:CONStel.....	67
[:SOURce<hw>]:BB:DVBT:DVbH:SYMBol[:INTerleaver].....	67
[:SOURce<hw>]:BB:DVBT:DVHState.....	68
[:SOURce<hw>]:BB:DVBT:FFT:MODE.....	68
[:SOURce<hw>]:BB:DVBT:GUARd:INTErval.....	68
[:SOURce<hw>]:BB:DVBT:HIERarchy.....	54
[:SOURce<hw>]:BB:DVBT:INPut:FORMat.....	56
[:SOURce<hw>]:BB:DVBT:INPut:FORMat:LOW.....	56
[:SOURce<hw>]:BB:DVBT:INPut:LOW.....	56
[:SOURce<hw>]:BB:DVBT:INPut:TSCHannel[:HIGH].....	57
[:SOURce<hw>]:BB:DVBT:INPut[:HIGH].....	56
[:SOURce<hw>]:BB:DVBT:MPEFec:LOW.....	70
[:SOURce<hw>]:BB:DVBT:MPEFec[:HIGH].....	70
[:SOURce<hw>]:BB:DVBT:PACKetlength:LOW?.....	59
[:SOURce<hw>]:BB:DVBT:PACKetlength[:HIGH]?.....	59
[:SOURce<hw>]:BB:DVBT:PAYLoad.....	61

[[:SOURCE<hw>]:BB:DVBT:PID.....	62
[[:SOURCE<hw>]:BB:DVBT:PIDTestpack.....	62
[[:SOURCE<hw>]:BB:DVBT:PRBS[:SEQUENCE].....	62
[[:SOURCE<hw>]:BB:DVBT:PRESet.....	53
[[:SOURCE<hw>]:BB:DVBT:RATE:LOW.....	68
[[:SOURCE<hw>]:BB:DVBT:RATE[:HIGH].....	68
[[:SOURCE<hw>]:BB:DVBT:SETTING:CATalog?.....	54
[[:SOURCE<hw>]:BB:DVBT:SETTING:DElete.....	54
[[:SOURCE<hw>]:BB:DVBT:SETTING:LOAD.....	54
[[:SOURCE<hw>]:BB:DVBT:SETTING:STORe.....	54
[[:SOURCE<hw>]:BB:DVBT:SOURce:LOW.....	56
[[:SOURCE<hw>]:BB:DVBT:SOURce[:HIGH].....	56
[[:SOURCE<hw>]:BB:DVBT:STATe.....	53
[[:SOURCE<hw>]:BB:DVBT:STUFFing:LOW.....	57
[[:SOURCE<hw>]:BB:DVBT:STUFFing[:HIGH].....	57
[[:SOURCE<hw>]:BB:DVBT:TESTsignal:LOW.....	62
[[:SOURCE<hw>]:BB:DVBT:TESTsignal[:HIGH].....	62
[[:SOURCE<hw>]:BB:DVBT:TIMeslice:LOW.....	70
[[:SOURCE<hw>]:BB:DVBT:TIMeslice[:HIGH].....	70
[[:SOURCE<hw>]:BB:DVBT:TPSReserved:STATE.....	70
[[:SOURCE<hw>]:BB:DVBT:TPSReserved:VALue.....	71
[[:SOURCE<hw>]:BB:DVBT:TSPacket.....	63
[[:SOURCE<hw>]:BB:DVBT:USED[:BANDwidth].....	69
[[:SOURCE<hw>]:BB:DVBT:USEFul[:RATE]:LOW?.....	59
[[:SOURCE<hw>]:BB:DVBT:USEFul[:RATE]:MAX:LOW?.....	59
[[:SOURCE<hw>]:BB:DVBT:USEFul[:RATE]:MAX[:HIGH]?.....	59
[[:SOURCE<hw>]:BB:DVBT:USEFul[:RATE][:HIGH]?.....	59
[[:SOURCE<hw>]:BB:DVBT[:INPut]:DATArate:LOW?.....	60
[[:SOURCE<hw>]:BB:DVBT[:INPut]:DATArate[:HIGH]?.....	60
[[:SOURCE<hw>]:BB:DVBT[:SPECial]:REEDsolomon:LOW.....	71
[[:SOURCE<hw>]:BB:DVBT[:SPECial]:REEDsolomon[:HIGH].....	71
[[:SOURCE<hw>]:BB:DVBT[:SPECial]:SETTING[:STATe].....	72
[[:SOURCE<hw>]:BB:INPut:IP<ch>:ALias.....	64
[[:SOURCE<hw>]:BB:INPut:IP<ch>:IGMP[:SOURce]:ADDReSS.....	66
[[:SOURCE<hw>]:BB:INPut:IP<ch>:IGMP[:SOURce]:PING.....	66
[[:SOURCE<hw>]:BB:INPut:IP<ch>:IGMP[:SOURce]:RESult?.....	66
[[:SOURCE<hw>]:BB:INPut:IP<ch>:MULTicast:ADDReSS.....	65
[[:SOURCE<hw>]:BB:INPut:IP<ch>:PORT.....	65
[[:SOURCE<hw>]:BB:INPut:IP<ch>:TYPE.....	65
[[:SOURCE<hw>]:BB:INPut:IP<ch>[:STATe].....	64

Index

A

Application cards	7
Application notes	7

B

Brochures	6
-----------------	---

C

Coding settings	24
Channel bandwidth	25
Code rate	27
Constellation	25
DVB-H state	26
FFT mode	25
Guard interval	26
Hierarchy	12, 24
Symbol interleaver	26
Used bandwidth	25
Conventions	
SCPI commands	52

D

Data sheets	6
Default settings	12
Documentation overview	5

G

Getting started	5
-----------------------	---

H

Help	6
------------	---

I

Input signal settings	13
Alias	22
General settings	13
IGMPv3 source address	23
Input	15
Input format	15
IP channel x	20
IP input	22
IP network data	41
IP TS Channel	15
Local IP data network	23
Maximum useful data rate	18
Measured data rate	18
Multicast address	22
Packet length	17
Payload test/stuff	20
PID	20
PID test packet	19
Ping result	23
Ping source address	23
PLP info	17
Port	23
PRBS	20
Source	14

Stuffing	15
Test signal	16
Test signal settings	19
Test TS packet	19
Type	22
Useful data rate	18
Installation	5
Instrument help	6
Instrument security procedures	6
IP input subsystem	
Remote control commands	63

L

Local IP data	
Remote control commands	80
Local IP data network	
Address mode	42
Hostname	42
IP address	42
MAC address	43
Network status	41
Protocol	43
Restart network	42
Show connector	43
Subnet mask	43

O

Open source acknowledgment (OSA)	7
--	---

R

Release notes	7
Remote control	
IP subsystem	63
Local IP data	80
Programming examples	52
TSGen subsystem	72

S

Safety instructions	6
Save/Recall	12
Security procedures	6
Service manual	6
Set to default	12
Special settings	30
Reed solomon	30
Special settings	30
Standard settings	12
State	12

T

TPS settings	27
MPE FEC	29
Time slicing	28
TPS cell ID	27
TPS reserved bits	28
TPS reserved state	28
TS player	31
Player output settings	36
Supported file types	34

TS player settings	
Continuity counter	40
Data rate	36
General settings	33
Nullpacket stuffing	37
Orig. data rate	36
Packet length	37
Pause	35
Payload test/stuff	39
PCR, DTS/PTS	40
PID	39
PID test packet	39
Play	35
Position player	35
PRBS	39
Reset window	35
Running	33
Seamless loop settings	39
Select file	33
Start	35
Stop	35
Stop data	37
TDT/TOT	40
Test TS packet	38
TSGen subsystem	
Remote control commands	72
U	
User manual	6
W	
White papers	7