

# R&S® NGL200/NGM200 Power Supply Series User Manual



1178873602  
Version 09



This manual describes the following R&S®NGL/NGM models with firmware version 1.00 or higher:

- R&S®NGL201 Single-channel power supply 60W (3638.3376.02)
- R&S®NGL202 Two-channel power supply 120W (3638.3376.03)
- R&S®NGM201 Single-channel power supply 60W (3638.4472.02)
- R&S®NGM202 Two-channel power supply 120W (3638.4472.03)

In addition to the base unit, the following options are described:

- R&S®NGL-B105 Option IEEE-488 (GPIB) Interface (3652.6356.02)
- R&S®NGL-K102 Option Wireless LAN Remote Control (3652.6362.02)
- R&S®NGL-K103 Option Digital I/O (3652.6385.02)
- R&S®NGM-B105 Option IEEE-488 (GPIB) interface (3641.6220.02)
- R&S®NGM-K102 Option Wireless LAN Remote Control (3644.6367.02)
- R&S®NGM-K103 Option Digital I/O (3643.9904.02)
- R&S®NGM-K104 Option Digital Voltmeter (3643.9927.02)
- R&S®NGM-K106 Option Battery Simulation (3636.6626.02)

© 2020 Rohde & Schwarz GmbH & Co. KG

Mühlhofstr. 15, 81671 München, Germany

Phone: +49 89 41 29 - 0

Email: [info@rohde-schwarz.com](mailto:info@rohde-schwarz.com)

Internet: [www.rohde-schwarz.com](http://www.rohde-schwarz.com)

Subject to change – data without tolerance limits is not binding.

R&S® is a registered trademark of Rohde & Schwarz GmbH & Co. KG.

Trade names are trademarks of the owners.

1178.8736.02 | Version 09 | R&S®NGL200/NGM200

Throughout this manual, products from Rohde & Schwarz are indicated without the ® symbol, e.g. R&S®NGL200, R&S®NGM200 are indicated as R&S NGL/NGM.

# Safety Instructions

## Instrucciones de seguridad

## Sicherheitshinweise

## Consignes de sécurité

---

### **WARNING**

#### **Risk of injury and instrument damage**

The instrument must be used in an appropriate manner to prevent electric shock, fire, personal injury or instrument damage.

- Do not open the instrument casing.
  - Read and observe the "Basic Safety Instructions" delivered as printed brochure with the instrument.
  - Read and observe the safety instructions in the following sections. Note that the data sheet may specify additional operating conditions.
  - Keep the "Basic Safety Instructions" and the product documentation in a safe place and pass them on to the subsequent users.
- 

### **ADVERTENCIA**

#### **Riesgo de lesiones y daños en el instrumento**

El instrumento se debe usar de manera adecuada para prevenir descargas eléctricas, incendios, lesiones o daños materiales.

- No abrir la carcasa del instrumento.
  - Lea y cumpla las "Instrucciones de seguridad elementales" suministradas con el instrumento como folleto impreso.
  - Lea y cumpla las instrucciones de seguridad incluidas en las siguientes secciones. Se debe tener en cuenta que las especificaciones técnicas pueden contener condiciones adicionales para su uso.
  - Guarde bien las instrucciones de seguridad elementales, así como la documentación del producto, y entréguelas a usuarios posteriores.
-

---

**⚠️ WARNUNG****Gefahr von Verletzungen und Schäden am Gerät**

Betreiben Sie das Gerät immer ordnungsgemäß, um elektrischen Schlag, Brand, Verletzungen von Personen oder Geräteschäden zu verhindern.

- Öffnen Sie das Gerätegehäuse nicht.
  - Lesen und beachten Sie die "Grundlegenden Sicherheitshinweise", die als gedruckte Broschüre dem Gerät beiliegen.
  - Lesen und beachten Sie die Sicherheitshinweise in den folgenden Abschnitten; möglicherweise enthält das Datenblatt weitere Hinweise zu speziellen Betriebsbedingungen.
  - Bewahren Sie die "Grundlegenden Sicherheitshinweise" und die Produktdokumentation gut auf und geben Sie diese an weitere Benutzer des Produkts weiter.
- 

---

**⚠️ AVERTISSEMENT****Risque de blessures et d'endommagement de l'appareil**

L'appareil doit être utilisé conformément aux prescriptions afin d'éviter les électrocutions, incendies, dommages corporels et matériels.

- N'ouvrez pas le boîtier de l'appareil.
  - Lisez et respectez les "consignes de sécurité fondamentales" fournies avec l'appareil sous forme de brochure imprimée.
  - Lisez et respectez les instructions de sécurité dans les sections suivantes. Il ne faut pas oublier que la fiche technique peut indiquer des conditions d'exploitation supplémentaires.
  - Gardez les consignes de sécurité fondamentales et la documentation produit dans un lieu sûr et transmettez ces documents aux autres utilisateurs.
-

# Contents

<b>1</b>	<b>Documentation Overview.....</b>	<b>9</b>
1.1	Manuals.....	9
1.2	Data Sheet.....	10
1.3	Release Notes, Open Source Acknowledgment.....	10
1.4	Application Notes, Application Cards, Videos.....	10
<b>2</b>	<b>Welcome to R&amp;S NGL/NGM.....</b>	<b>11</b>
<b>3</b>	<b>Important Notes.....</b>	<b>12</b>
3.1	Symbols.....	12
3.2	Ambient Conditions.....	12
3.3	Measurement Categories.....	13
3.4	Mains Voltage.....	13
3.5	Limits.....	14
<b>4</b>	<b>Getting Started.....</b>	<b>15</b>
4.1	Putting into Operation.....	15
4.1.1	Safety.....	16
4.1.2	Intended Operation.....	17
4.1.3	Unpacking and Checking the Instrument.....	19
4.1.4	Setting Up the Instrument.....	19
4.1.4.1	Bench Operation.....	19
4.1.4.2	Rack Mounting.....	20
4.2	Instrument Tour.....	20
4.2.1	Overview of Controls.....	20
4.2.1.1	Front Panel.....	20
4.2.1.2	Rear Panel.....	22
4.2.2	Switching On the Instrument.....	24
4.3	Trying Out the Instrument.....	25
4.3.1	Setting the Output Voltage and Current.....	26
4.3.2	Activating the Channels Output.....	26
4.4	Maintenance and Support.....	27
4.4.1	Maintenance.....	27

4.4.2	Contacting Customer Support.....	28
<b>5</b>	<b>Operating Basics.....</b>	<b>29</b>
<b>5.1</b>	<b>Display Overview.....</b>	<b>29</b>
5.1.1	Status Bar Information.....	29
5.1.2	Channel Display Area.....	32
<b>5.2</b>	<b>Using the Touchscreen.....</b>	<b>33</b>
5.2.1	Using Gestures.....	33
5.2.2	Accessing Functionality in the Home Window.....	33
5.2.2.1	Settings Button.....	34
5.2.2.2	Voltage and Current Inputs.....	35
5.2.2.3	Expand/Collapse Button.....	35
5.2.3	Input Data.....	36
<b>5.3</b>	<b>Front Panel Keys.....</b>	<b>37</b>
5.3.1	Menu Controls.....	37
5.3.1.1	Home Key.....	37
5.3.1.2	Settings Key.....	37
5.3.1.3	User Key.....	40
5.3.2	Navigation Controls.....	40
5.3.3	Output and Channel Controls.....	41
<b>5.4</b>	<b>Power Derating.....</b>	<b>41</b>
<b>5.5</b>	<b>Operation Modes.....</b>	<b>42</b>
<b>6</b>	<b>Instrument Functions.....</b>	<b>44</b>
<b>6.1</b>	<b>Setting the Channels Voltage and Current.....</b>	<b>44</b>
<b>6.2</b>	<b>Activating the Channels Output.....</b>	<b>45</b>
6.2.1	Set Constant Resistance.....	46
6.2.2	Fast Transient Response.....	47
6.2.3	Output.....	48
6.2.3.1	Impedance.....	48
6.2.3.2	Delay.....	49
6.2.3.3	Trigger Events.....	50
6.2.3.4	Output Mode.....	51
<b>6.3</b>	<b>Ranges / Digital Voltmeter (DVM).....</b>	<b>52</b>
<b>6.4</b>	<b>Battery Simulator.....</b>	<b>54</b>

<b>6.5</b>	<b>Protection</b> .....	<b>58</b>
6.5.1	Overcurrent Protection (OCP).....	58
6.5.2	Overvoltage Protection (OVP).....	59
6.5.3	Overpower Protection (OPP).....	60
6.5.4	Safety Limits.....	61
<b>6.6</b>	<b>Trigger / Digital I/O</b> .....	<b>62</b>
<b>6.7</b>	<b>Advanced Features</b> .....	<b>67</b>
6.7.1	Arbitrary.....	67
6.7.2	Ramp.....	70
<b>6.8</b>	<b>User Key</b> .....	<b>71</b>
<b>6.9</b>	<b>Screenshot</b> .....	<b>72</b>
<b>6.10</b>	<b>Data Logging</b> .....	<b>73</b>
<b>6.11</b>	<b>FastLog</b> .....	<b>75</b>
<b>6.12</b>	<b>CSV Settings</b> .....	<b>76</b>
<b>6.13</b>	<b>Graphical View Window</b> .....	<b>78</b>
<b>6.14</b>	<b>File Manager</b> .....	<b>80</b>
<b>6.15</b>	<b>Store and Recall</b> .....	<b>81</b>
<b>6.16</b>	<b>Interfaces</b> .....	<b>83</b>
6.16.1	Network Connection.....	84
6.16.1.1	LAN Connection.....	85
6.16.1.2	Wireless LAN Connection.....	87
6.16.2	USB Connection.....	88
6.16.3	GPIB Address.....	89
<b>6.17</b>	<b>General Instrument Settings</b> .....	<b>90</b>
6.17.1	Licenses Management.....	90
6.17.2	Appearance Settings.....	92
6.17.3	Sound Settings.....	92
6.17.4	Date and Time.....	93
6.17.5	Device Information.....	94
6.17.6	Update Device.....	94
<b>6.18</b>	<b>Device Documentation</b> .....	<b>95</b>
<b>7</b>	<b>Remote Control Commands</b> .....	<b>96</b>
7.1	Common Setting Commands.....	96

<b>7.2</b>	<b>System Settings Commands</b>	<b>99</b>
<b>7.3</b>	<b>Display Commands</b>	<b>101</b>
<b>7.4</b>	<b>Trigger Commands</b>	<b>102</b>
<b>7.5</b>	<b>Configuration Commands</b>	<b>105</b>
7.5.1	Channel Selection	106
7.5.2	Safety Limit Setting	107
7.5.3	Voltage Setting	111
7.5.4	Current Setting	114
7.5.5	Resistance Setting	117
7.5.6	Combined Setting of Voltage and Current Setting	119
7.5.7	Output Setting	120
7.5.8	Range/DVM Setting	126
7.5.9	OCP Setting	129
7.5.10	OVP Setting	136
7.5.11	OPP Setting	139
7.5.12	USB Class Setting	142
<b>7.6</b>	<b>Measurement Commands</b>	<b>142</b>
<b>7.7</b>	<b>Advanced Operating Commands</b>	<b>149</b>
7.7.1	Arbitrary	149
7.7.2	Ramp	155
7.7.3	Digital I/O	156
7.7.4	Battery Simulation	159
<b>7.8</b>	<b>Data and File Management Commands</b>	<b>166</b>
<b>7.9</b>	<b>Status Reporting Commands</b>	<b>175</b>
7.9.1	STATus:OPERation Registers	175
7.9.2	STATus:QUEStionable Registers	177
	<b>Annex</b>	<b>180</b>
<b>A</b>	<b>Additional Basics on Remote Control</b>	<b>180</b>
<b>A.1</b>	<b>Messages and Command Structure</b>	<b>180</b>
A.1.1	Messages	180
A.1.2	SCPI Command Structure	181
<b>A.2</b>	<b>Command Sequence and Synchronization</b>	<b>185</b>
A.2.1	Preventing Overlapping Execution	186



<b>A.3</b>	<b>Status Reporting System.....</b>	<b>186</b>
A.3.1	Structure of a SCPI Status Register.....	186
	<b>List of Commands.....</b>	<b>192</b>
	<b>Index.....</b>	<b>197</b>



# 1 Documentation Overview

This section provides an overview of the R&S NGL/NGM user documentation.

## 1.1 Manuals

You find the documents on the R&S NGL/NGM product page at:

[www.rohde-schwarz.com/product/ngl200](http://www.rohde-schwarz.com/product/ngl200)

[www.rohde-schwarz.com/product/ngm200](http://www.rohde-schwarz.com/product/ngm200)

### Getting Started

Introduces the R&S NGL/NGM power supply series and describes how to set up and start working with the instrument. The printed document is delivered with the instrument.

### User manual

Contains the description of all instrument modes and functions. It also provides an introduction to remote control, a complete description of the remote control commands with programming examples, and information on maintenance and instrument interfaces. Includes the contents of the getting started manual.

The *online version* of the user manual provides the complete contents for immediate display on the internet.

### Basic safety instructions

Contains safety instructions, operating conditions and further important information. The printed document is delivered with the instrument.

### Instrument security procedures manual

Deals with security issues when working with the R&S NGL/NGM in secure areas.

### Service manual

Describes the performance test for checking the rated specifications, module replacement and repair, firmware update, troubleshooting and fault elimination, and contains mechanical drawings and spare part lists. The service manual is available for registered users on the global Rohde & Schwarz information system (GLORIS, <https://gloris.rohde-schwarz.com>).

## 1.2 Data Sheet

The datasheet contains the technical specifications of the R&S NGL/NGM power supply series. It also lists all options with their order numbers and accessories.

See [www.rohde-schwarz.com/brochure-datasheet/ngl200](http://www.rohde-schwarz.com/brochure-datasheet/ngl200)

See [www.rohde-schwarz.com/brochure-datasheet/ngm200](http://www.rohde-schwarz.com/brochure-datasheet/ngm200)

## 1.3 Release Notes, Open Source Acknowledgment

The release notes list new features, improvements and known issues of the current firmware version, and describe the firmware installation. The open source acknowledgment document provides verbatim license texts of the used open source software. It can also be read directly on the instrument.

See [www.rohde-schwarz.com/firmware/ngl200](http://www.rohde-schwarz.com/firmware/ngl200).

See [www.rohde-schwarz.com/firmware/ngm200](http://www.rohde-schwarz.com/firmware/ngm200).

## 1.4 Application Notes, Application Cards, Videos

These documents contain information about possible applications and background information on various topics,

See [www.rohde-schwarz.com/appnotes/ngl](http://www.rohde-schwarz.com/appnotes/ngl).

See [www.rohde-schwarz.com/appnotes/ngm](http://www.rohde-schwarz.com/appnotes/ngm).

## 2 Welcome to R&S NGL/NGM

The one or two-channel power supply series are based on a classical transformer concept with linear regulators. This concept allows the instrument to achieve highest accuracy and lowest residual ripple.

The R&S NGL/NGM power supply series feature galvanically isolated, floating overload and short-circuit proof outputs. When multiple channels are connected in parallel, higher currents can be achieved. When connected in serial, higher voltages are achievable.

Multi-purpose protection functions are available for each channel which you can set separately, such as overcurrent protection (OCP), overvoltage protection (OVP) and overpower protection (OPP). If such a limit is reached, the affected output channel is automatically turned off and an indicator icon (🔴, 🟡, 🟢) blinks on the display. In the case of two-channel power supply (NGL202, NGM202), the overcurrent protection can be linked to the other channel. In this case, the linked channel is turned off when the other channel reaches a limit.

Additionally, the R&S NGL/NGM is protected with overtemperature protection (OTP). This safety feature protects the R&S NGL/NGM from overheating. When the temperature in the power supply exceeds the OTP limit, the channel outputs are automatically cut off.

The Arbitrary function allows a freely definable voltage and current sequences with a timeframe as short as 1 ms. It allows varying the voltage or current during a test sequence, for example to simulate different charging conditions of a battery. With "Ramp" function, the R&S NGL/NGM provides the operating condition to ramp up the supply voltage within a defined timeframe of 10 ms to 10 s.







All R&S NGL/NGM power supplies are equipped with a color TFT display (800 pixels x 480 pixels) and enhanced with touch input capability. The R&S NGL/NGM comes with a USB and LAN (LXI) interface. Equipped with a wireless LAN (WLAN) option, you can establish a network connection wirelessly.

The digital I/O interface installed at the rear panel is activated with an option, it allows a single trigger-in signal to control multi trigger-out signals on the power supply, providing many possibilities to control outputs and associated devices in the event when a trigger occurs.

The user manual contains description of the functionalities that the instrument provides. The latest version is available for download at the product homepage (<http://www.rohde-schwarz.com/product/ngl200> for R&S NGL and <http://www.rohde-schwarz.com/product/ngm200> for R&S NGM) .

## 3 Important Notes

### 3.1 Symbols

	Caution, general danger zone
	Ground
	PE terminal
	ON (supply voltage)
	OFF (supply voltage)
	Ground terminal

### 3.2 Ambient Conditions

The allowed operating temperature ranges from +5 °C to +40 °C (pollution category 2). The maximum relative humidity (without condensation) is at 80 %.

During storage and transport, the temperature must be between -40 °C and +70 °C. In case of condensation during transportation or storage, the instrument requires approximately two hours to dry and reach the appropriate temperature prior to operation. The instrument is designed for use in a clean and dry indoor environment. Do not operate with high dust and humidity levels, if danger of explosion exists or with aggressive chemical agents.

Any operating position may be used; however adequate air circulation must be maintained. For continuous operation, a horizontal or inclined position (integrated stand) is preferable.

Specifications with tolerance data apply after a warm-up period of at least 30 minutes at a temperature of 23 °C (tolerance -3 °C / + 7 °C).

The heat produced inside the instrument is guided to the exterior via temperature-controlled fan. Each channel has multiple temperature sensors which check the heat generation in the instrument and control the fan speed.

It is necessary to ensure that there is sufficient space around the instrument sides for heat exchange. If the temperature inside the instrument increases more than the

allowed limit, overtemperature protection is triggered and the affected outputs are switched off automatically.

---

**⚠ CAUTION****Air circulation**

Do not obstruct the ventilation holes!

---

### 3.3 Measurement Categories

This instrument is designed for supplying power-on circuits that are only indirectly connected to the low voltage mains or not connected at all. The instrument is not intended for measurements within the measurement categories II, III or IV; the maximum potential against earth generated by the user must not exceed 250 V peak in this application.

The following information refers solely to user safety. Other aspects, such as the maximum voltage, are described in the technical data and must also be observed.

The measurement categories refer to transients that are superimposed on the mains voltage. Transients are short, very fast (steep) current and voltage variations which may occur periodically and non-periodically. The level of potential transients increases as the distance to the source of the low voltage installation decreases.

- Measurement CAT IV: Measurements at the source of the low voltage installations (e.g. meters)
- Measurement CAT III: Measurements in building installations (e.g. power distribution installations, power switches, firmly installed sockets, firmly installed engines etc.)
- Measurement CAT II: Measurements on circuits electronically directly connected to the mains (e.g. household appliances, power tools, etc.)
- 0 (instruments without measured measurement category): Other circuits that are not connected directly to the mains

### 3.4 Mains Voltage

The instrument uses 50 Hz / 60 Hz mains voltages ranging from 100 VAC, 115 VAC or 230 VAC (tolerance  $\pm 10\%$ ). Mains voltage must be set correctly by removing the fuse holder and rotating until the correct voltage appears through the window and reinstalling the fuse holder. The input line fuse is accessible externally. Power socket and fuse holder form a single unit.

You need to first disconnect the power cord from the connector before you can safely replace the fuse (as long as the fuse holder is undamaged). Next, the fuse holder must be pried out using a screwdriver. The starting point is a slot next to the contacts. The fuse can then be forced out of its mounting and must be replaced with an identical fuse (see information about the fuse type on the rear panel). The fuse holder is inserted

against the spring pressure until it locks into place. The use of mended fuses or short circuiting the fuse holder is prohibited. Resulting damages are not covered by the warranty.

### **NOTICE**

#### **Safe operation**

If the instrument is not in use, it must be switched off at the mains switch for safety reasons.

## **3.5 Limits**

The R&S NGL/NGM is equipped with a protective overload feature. The protective overload feature prevents damage to the instrument and is intended to protect against a possible electrical shock. The maximum values for the instrument must not be exceeded. The protection limits are listed on the front panel of the R&S NGL/NGM to ensure the safe operation of the instrument.

These protection limits must be adhered to:

Specification	Limits
Maximum output voltage	20.05 VDC
Maximum output current	6.01 A ( $\leq 6$ V) 3.01 A ( $> 6$ V)
Maximum voltage against earth	250 V peak
Maximum counter-voltage (same polarity)	22 V
Maximum reverse voltage (opposite polarity)	0.5 V
Maximum reverse current sink current	3.01 A
Power supply	100 VAC, 115 VAC or 230 VAC (tolerance $\pm 10$ %)
Frequency	50 Hz / 60 Hz
Maximum power output	120 W (NGL202, NGM202), 60 W (NGL201, NGM201)



## 4 Getting Started

### 4.1 Putting into Operation

This chapter describes how to set up the R&S NGL/NGM power supply series for the first time.

---

**⚠ WARNING****Risk of injury due to disregarding safety information**

Observe the information on appropriate operating conditions provided in the data sheet to prevent personal injury or damage to the instrument. Read and observe the basic safety instructions provided with the instrument, in addition to the safety instructions in the following sections. In particular:

- Do not open the instrument casing.
- 

**NOTICE****Risk of instrument damage due to inappropriate operating conditions**

Specific operating conditions are required to ensure accurate measurements and to avoid damage to the instrument. Observe the information on appropriate operating conditions provided in the basic safety instructions and the instrument's data sheet.

---

**NOTICE****Instrument damage caused by electrostatic discharge**

Electrostatic discharge (ESD) can damage the electronic components of the instrument and the device under test (DUT). Electrostatic discharge is most likely to occur when you connect or disconnect a DUT or test fixture to the instrument's test ports. To prevent electrostatic discharge, use a wrist strap and cord and connect yourself to the ground, or use a conductive floor mat and heel strap combination.

---

---

**⚠ WARNING****Risk of radio interference**

This instrument is compliant with Class A of CISPR 32. In a residential environment, this instrument may cause radio interference.

---

**NOTICE****Risk of instrument damage during operation**

An unsuitable operating site or test setup can cause damage to the instrument and the connected devices. Ensure the following operating conditions before you switch on the instrument:

- The instrument is dry and shows no sign of condensation
- The instrument is positioned as described in [Chapter 4.1.4.1, "Bench Operation"](#), on page 19
- The ambient temperature does not exceed the range specified in the data sheet
- Signal levels at the input connectors are all within the specified ranges
- Signal outputs are correctly connected and not overloaded

**EMI impact on measurement results**

Electromagnetic interference (EMI) may affect the measurement results.

To suppress generated electromagnetic interference (EMI):

- Use suitable shielded cables of high quality. For example, use double-shielded RF and LAN cables.
- Always terminate open cable ends.
- Note the EMC classification in the data sheet.

### 4.1.1 Safety

**NOTICE****Recommendations on secure operation**

The R&S NGL/NGM is designed to operate at local workplaces or in secured networks (LAN). It should not be accessible from the internet, because of a potential security risk, e.g. attackers could misuse or damage your device.

Please always install the latest firmware.

It is highly recommended that you work closely with your IT department or system administrator to ensure compliance with your company policies when connecting devices to your company's network.

This instrument was built in compliance with DIN EN 61010-1, safety regulations for electrical instruments, control units and laboratory equipment.

It has been tested and shipped from the plant in safe condition. It is also in compliance with the regulations of the European standard EN 61010-1 and the international standard IEC 61010-1.

To maintain this condition and ensure safe operation, you must observe all instructions and warnings given in this user manual. Casing, chassis and all measuring ports are

connected to a protective earth conductor. The instrument is designed in compliance with the regulations of protection class I.

For safety reasons, the instrument may only be operated with authorized safety sockets. The power cable must be plugged in before signal circuits may be connected.

Never use the product if the power cable is damaged. Check regularly if the power cables are in perfect condition. Choose suitable protective measures and installation types to ensure that the power cable cannot be damaged and that no harm is caused by tripping hazards or from electric shock, for instance.

---

** DANGER****Risk of electric shock**

It is prohibited to disconnect the earthed protective connection inside or outside of the instrument!

---

If it is assumed that a safe operation is no longer possible, the instrument must be shut down and secured against any unintended operation.

Safe operation can no longer be assumed when:

- Instrument shows visible damage
- Instrument includes loose parts
- Instrument no longer functions properly
  - After an extended period of storage under unfavorable conditions (e.g. outdoors or in damp rooms)
  - After rough handling during transport (e.g. packaging that does not meet the minimum requirements by post office, railway or forwarding agency)

---

** DANGER****Exceeding the low voltage protection**

Use insulated wires and not bare wires for the terminal connection.

It is assumed that only qualified and trained personnel service the power supplies and the connected loads.

---

Before switching on the product, it must be ensured that the nominal voltage setting on the product matches the nominal voltage of the AC supply network.

#### 4.1.2 Intended Operation

The instrument is intended only for use by personnel familiar with the potential risks of measuring electrical quantities.

For safety reasons, the instrument may only be connected to properly installed wall outlets. Separating the ground is prohibited.

The power cable must be inserted before signal circuits may be connected.



Use only the power cable included in the delivery package. See "[Delivery package](#)" on page 19.

Before each measurement, measuring cables must be inspected for damage and replaced if necessary. Damaged or worn components can damage the instrument or cause injury.

The instrument may be operated only under the operating conditions and in the positions specified by the manufacturer, without the product's ventilation being obstructed. If the manufacturer's specifications are not observed, this can result in electric shock, fire and/or serious personal injury, and in some cases, death.

Applicable local or national safety regulations and rules for the prevention of accidents must be observed in all work performed.

The instrument is designed for use in the following sectors: Industrial, residential, business and commercial areas and small businesses.

The instrument is designed for indoor use only. Before each measurement, you need to verify at a known source if the instrument functions properly.



To disconnect from the mains, unplug the IEC socket on the back panel.

See [Table 4-1](#) for the general data on the instrument specification. For more information, see the instrument datasheet (P/N: 5216.1057.32).

**Table 4-1: General data on instrument specification**

General data		
Mains nominal voltage	AC 100 V / 115 V / 230 V (±10 %) 50 Hz to 60 Hz	
Maximum power consumption	400 W	
Mains fuses	2 x IEC T4.0H 250 V	
Operating temperature range	+5 °C to +40 °C	
Storage temperature range	-20 °C to +70 °C	
Humidity noncondensing	5 % to 95 %	
Display	TFT 5" 800 pixels x 480 pixels WVGA Touch	
Rack installation	R&S HZN96 rack adapter 2U (P/N: 3638.7813.02)	
Dimensions (W x H x D)	222 mm x 97 mm x 436 mm (8.74" x 3.82" x 17.17")	
Weight	R&S NGL201	7.1 kg (15.65 lb)
	R&S NGM201	7.2 kg (15.87 lb)
	R&S NGL202	7.3 kg (16.09 lb)
	R&S NGM202	7.4 kg (16.31 lb)

### 4.1.3 Unpacking and Checking the Instrument

Unpack the R&S NGL/NGM power supply carefully and check the content of the package.

- Check the equipment for completeness using the delivery note and package contents list for the various items.
- Check the instrument for any damage and loose parts. If there is any damage, immediately contact the carrier who delivered the instrument.



#### Packing material

Retain the original packing material. If the instrument needs to be transported or shipped later, you can use the material to protect the control elements and connectors.

---

#### NOTICE

##### Risk of damage during transportation and shipment

Insufficient protection against mechanical and electrostatic effects during transportation and shipment can damage the instrument.

- Always ensure that sufficient mechanical and electrostatic protections are provided
- When shipping an instrument, the original packaging should be used. If you do not have the original packaging, use sufficient padding to prevent the instrument from moving around inside the box. Pack the instrument in antistatic wrap to protect it from electrostatic charging
- Secure the instrument to prevent any movement and other mechanical effects during transportation

---

#### Delivery package

The package contents contain the following items:

- R&S NGL power supply or R&S NGM power supply
- Four power cables
- One printed Getting Started manual
- One document folder containing a printed Basic Safety Instructions guide

### 4.1.4 Setting Up the Instrument

The R&S NGL/NGM is designed for benchtop and rackmount operation.

#### 4.1.4.1 Bench Operation

On a benchtop, the R&S NGL/NGM power supply can either lie flat or stand on its feet. As shown in [Figure 4-1](#), feet on the bottom can be folded out to set the instrument in an inclined position.

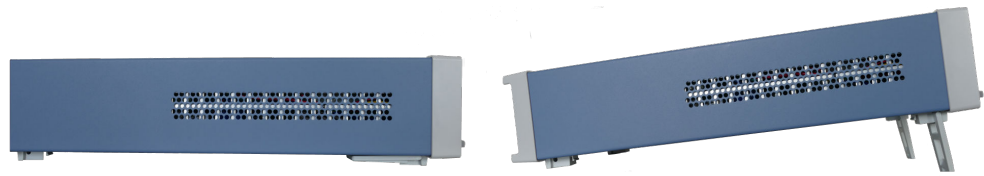

Figure 4-1: Operating positions

## NOTICE

### Positioning of instrument

The instrument must be positioned in a manner that allows you to disconnect the unit from the mains at any time and without restrictions.

#### 4.1.4.2 Rack Mounting

The instrument can be installed in a 19" rack using the rack adapter R&S HZN96 (P/N 3638.7813.02). Proceed according to the installation instructions supplied with the rack adapter.

## NOTICE

### Ambient temperature

Place the R&S NGL/NGM power supply in an area where the ambient temperature is within +5 °C to +40 °C. The R&S NGL/NGM power supply is fan-cooled and must be installed with sufficient space along the sides to ensure free flow of air.

## 4.2 Instrument Tour

This chapter provides an overview of all the controls available in the R&S NGL/NGM models and steps to switch on the instrument for the first time.

- [Overview of Controls](#).....20
- [Switching On the Instrument](#).....24

### 4.2.1 Overview of Controls

#### 4.2.1.1 Front Panel

The front panel of the R&S NGL/NGM is as shown in [Figure 4-2](#). The function keys and navigation controls are located beside the display. The various connectors are located at the right side of the display.

The R&S NGL/NGM has one output channel for NGL201, NGM201 models and two output channels for NGL202, NGM202 models.

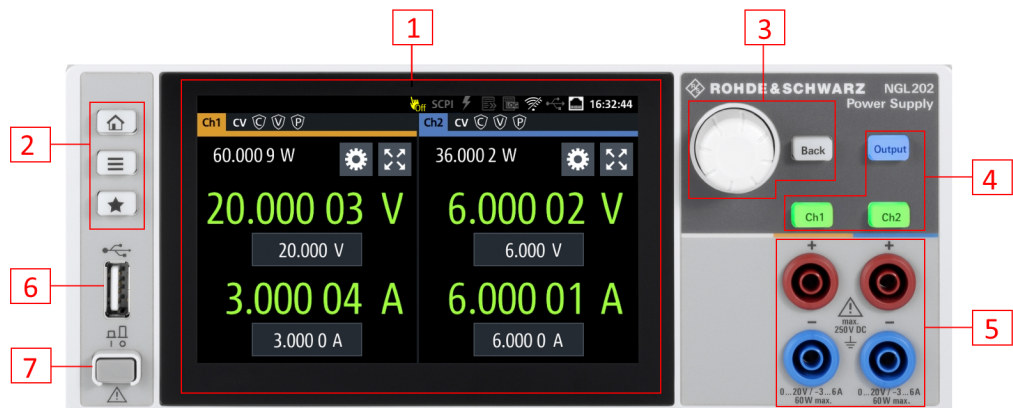

**Figure 4-2: Front panel of R&S NGL/NGM with 2 channels**

- 1 = Display with touch screen
- 2 = Menu control keys
- 3 = Rotary knob and back key
- 4 = Output and channel keys
- 5 = Output terminals (one channel with sense for NGL201, NGM201; two channels for NGL202, NGM202)
- 6 = USB connector
- 7 = Power key

### Display (1)

The display is a color TFT touch screen. Depending on the instrument model, up to two channels are shown on the display. The respective measurement settings and functions are displayed in the individual channel display area. There is a status bar in the device level and channel level, showing the device operating mode and respective channel settings of the instrument.

For a detailed description on-screen layout, see [Chapter 5.1, "Display Overview"](#), on page 29.

### Menu control keys (2)

The menu control keys allow you to access the home window, device/channel menu window and user key in the instrument.

For a detailed description on menu control keys, see [Chapter 5.3.1, "Menu Controls"](#), on page 37.

### Rotary knob and back key (3)

The rotary knob and back key are used for menu navigation and value adjustment in the instrument.

For a detailed description on rotary knob and back key, see section [Chapter 5.3.2, "Navigation Controls"](#), on page 40.

### Output and channel keys (4)

The channel key allows you to select the power supply channel to source or sink power. The output key allows you to enable or disable the output power on the channel key.

Refer to datasheet for the channel voltage/current limits in the source and sink mode.

### Output terminals (5)

Depending on the instrument type, one or two output channels are available to source or sink power.

Both instrument models are equipped with 4 terminals. The NGL201, NGM201 models provide both the output plus the sense connectors at the front panel while the NGL202, NGM202 models provide only output terminals for both channels.

### USB connector (6)

The USB connector is a Type-A connector. You can connect a USB flash drive to this connector to perform a firmware update, store logging data or screen shots.

### Power key (7)

The [Power] key switches the instrument on and off.

#### 4.2.1.2 Rear Panel

Figure 4-3 shows the rear panel of the R&S NGL/NGM with its connectors.

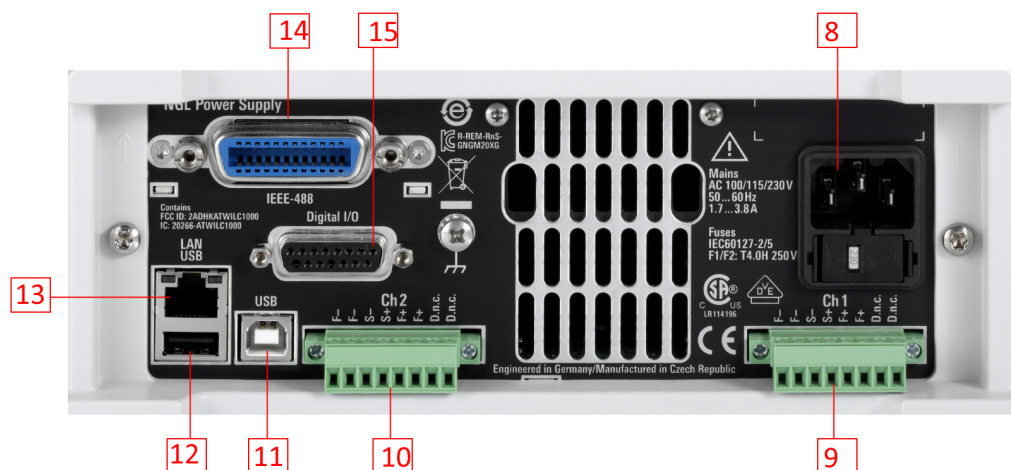

**Figure 4-3: Rear panel of R&S NGL/NGM with 2 channels**

- 8 = AC inlet with fuse holder and voltage selector
- 9 = Channel 1 rear panel connector for NGL202, NGM202 models. The two D.n.c. labels for NGM201 are labeled as DVM+ and DVM-
- 10 = Channel 2 rear panel connector for NGL202, NGM202 models. The two D.n.c. labels for NGM202 are labeled as DVM+ and DVM-
- 11 = USB connector (device)
- 12 = USB connector (host)



- 13 = Ethernet (LAN) connector
- 14 = Optional IEEE-488 (GPIB) interface
- 15 = Digital I/O connector

### AC inlet with fuse holder and voltage selector (8)



#### Main supply cord

Do not use detachable mains supply cord with inadequate rating.

The power cable must be plugged in before signal circuits can be connected. Do not use the product if the power cable is damaged. See [Chapter 4.2.2, "Switching On the Instrument"](#), on page 24 for more information.

The built-in voltage selector selects the mains voltage between 100 V, 115 V and 230 V. All voltage settings are using the same fuse rating.

### Channel connectors (9, 10)

---

#### NOTICE

#### Output terminals

Either the output terminals at the front panel or those at the back panel can be used. Using both terminals at the same time can cause instrument malfunction.

---



#### Digital voltmeter (DVM)

The DVM+ and DVM- pins on the channel connector are available only with R&S NGM power supply series equipped with option R&S NGM-K104 (P/N: 3643.9927.02).

The channel connectors contain both output ("F+", "F-") and sense ("S+", "S-") connections. Connector for "Ch2" is only available in the NGL202, NGM202 models.

#### USB connectors (11, 12)

The USB host connector (Type-A) can be used for mass storage devices or an external mouse like the USB connector at the front panel.

The USB device connector is a Type-B connector for remote control operation.

#### Ethernet connector (13)

10/100 Ethernet port for remote control operation via the local area network.

For a detailed description on the connection setup, see [Chapter 6.16.1.1, "LAN Connection"](#), on page 85.

#### Option IEEE-488 (GPIB) interface (14)

An IEEE-488 (GPIB) interface can be ordered (NGL-B105 or NGM-B105). This interface is not user installable.

### Digital I/O connector (15)

The Digital I/O option (R&S NGL-K103 or R&S NGM-K103) must be installed for this function to be available in the instrument.

The specified voltages are 0 V to 24 V for all output pins and 0 V to 15 V for all input pins.

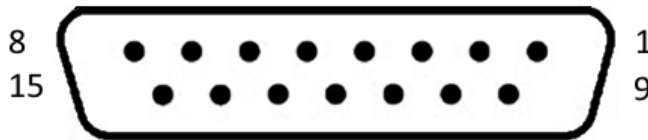

Figure 4-4: Digital I/O connector (female socket front view)

Table 4-2: Digital I/O pin layout

Pin	Signal	Direction	Pin	Signal	Direction
1	*Inhibit Ch1	IN	9	*Inhibit Ch2	IN
2	Ext. Trigger Ch1	IN	10	Ext. Trigger Ch2	IN
3	Digital In1	IN	11	Digital Output Fault	OUT
4	Digital Output Out1	OUT	12	Digital Output Out2	OUT
5 - 8	Gnd	-	13 - 15	Gnd	-

\* The [inhibit signals](#) can be used to turn off the outputs by a digital hardware signal.

Table 4-3: Inhibit signals

Signal name	Pin	Descriptions
Inhibit Ch1	Pin 1 of <a href="#">Digital I/O connector</a>	If the inhibit signal goes active, channel 1 output is turned off. The inhibit signal is low active (inverted logic).
Inhibit Ch2	Pin 9 of <a href="#">Digital I/O connector</a>	If the inhibit signal goes active, channel 2 output is turned off The inhibit signal is low active (inverted logic).

## 4.2.2 Switching On the Instrument

Before switching on the instrument, check that all the instructions in the “Basic Safety Instruction” brochure and safety measures in previous sections are observed. Also, check if the value on the voltage selector corresponds to the mains voltage (100 V, 115 V or 230 V).



### Fuse rating

The R&S NGL/NGM uses the same fuse ratings for all mains voltages.

**To change power fuse / mains voltage setting:**

1. Peel off the yellow label sticker on the AC inlet.
2. Release the latch of the fuse holder which is located at both side of the socket and pull it out.
3. Pull out the removable part of the fuse holder.
4. Turn this removable part until the correct voltage label (100, 115 or 230) is displayed in the window of the holder.
5. Return the fuse holder to its position in the panel.

**To switch on instrument:**

1. Connect the power cable to the AC power connector on the rear panel of the R&S NGL/NGM.
2. Connect the power cable to the socket outlet.
3. Press [Power] key on the front panel.  
The instrument performs a system check, boots the operating system, and starts the R&S NGL/NGM firmware.

By default, all output channels are turned off when the instrument is switched on to prevent connected loads from being damaged unintentionally.

During startup, the R&S NGL/NGM is loaded with the last saved instrument settings from internal memory. See [Chapter 6.15, "Store and Recall"](#), on page 81.

**To switch off instrument:**

1. Press [Power] key.  
All current settings are saved to internal memory and the firmware shuts down.
2. Disconnect the AC power cable from the instrument.

## 4.3 Trying Out the Instrument

This chapter describes some basic functions that you can perform with the R&S NGL/NGM.



### Source and sink current

The R&S NGL/NGM power supply series are 2 quadrant power supplies which may both source and sink current. When the voltage across the output terminal exceeds the set voltage, current flows into the instrument. The default behavior "Auto" can be configured in output menu, see [Chapter 6.2.3.4, "Output Mode"](#), on page 51.

On the display, sink mode is shown as negative current. See also ["CR mode"](#) on page 26.

## 4.3.1 Setting the Output Voltage and Current

1. Press [Home] key.  
The R&S NGL/NGM displays the home window.
2. Select voltage or current parameter in the home window.  
The R&S NGL/NGM displays an on-screen keypad to set the value.
3. Enter the required value.
4. Confirm value with the unit key (V/mV or A/mA).  
See ["Source and sink current"](#) on page 26 for more information on the operating modes supported in different models.

## 4.3.2 Activating the Channels Output

The output voltages can be switched on or off regardless of the instrument's operating mode.

To switch on or off channel output.

1. For the two-channel models, select desired channel key ([Ch1] or [Ch2]) on the front panel.
2. Press [Output] key.  
The R&S NGL/NGM outputs the set voltage level on the output channel terminal.



Depending on the operating mode which the channels are operated in, the following are observed:



### CR mode

CR mode is a special case of sink mode in which the instrument behaves like a constant resistor. Only in this mode, the respective channel keys and display font color in the home window turns cyan.

In "normal" sink mode, the colors are the same as in source mode: green if the current flowing into the R&S NGL/NGM is below the set current and red if the current is limited to the set value. The only visible indication of sink mode is the change of sign of the current readout to "Minus".

Color illuminated on front panel keys and display font color of voltage and current in home window	Operating mode
 Green	Constant voltage mode (CV)
 Red	Constant current mode (CC)
 Cyan	Constant resistance mode (CR) Note: Instrument is operated in sink mode and "Constant Resistance" is activated.

Also, the operating symbol mode (CV, CC or CR) is displayed at the channel status bar of the respective channel.

## 4.4 Maintenance and Support

### 4.4.1 Maintenance

Regular maintenance improves the life span of the instrument, the following chapter provides information on instrument maintenance.

#### Cleaning

Before cleaning the instrument, ensure that it has been switched off and the power cable is disconnected.

Clean the outer case of the instrument at regular intervals, using a soft, lint-free dust cloth.

---

#### **NOTICE**

##### **Instrument damage caused by cleaning agents**

Use a dry, lint-free cloth to clean the product. When cleaning, keep in mind that the casing is not waterproof. Do not use any liquids for cleaning.

Cleaning agents, solvents (thinners, acetone), acids and bases can damage the front panel labeling, plastic parts and display.

---

The display may only be cleaned with an appropriate glass cleaner. Rub the display with a dry, clean and lint-free cloth. Do not allow cleaning fluid to enter the instrument.

## 4.4.2 Contacting Customer Support

### Technical support – where and when you need it

For quick, expert help with any Rohde & Schwarz product, contact our customer support center. A team of highly qualified engineers provides support and works with you to find a solution to your query on any aspect of the operation, programming or applications of Rohde & Schwarz products.

### Contact information

Contact our customer support center at [www.rohde-schwarz.com/support](http://www.rohde-schwarz.com/support), or follow this QR code:

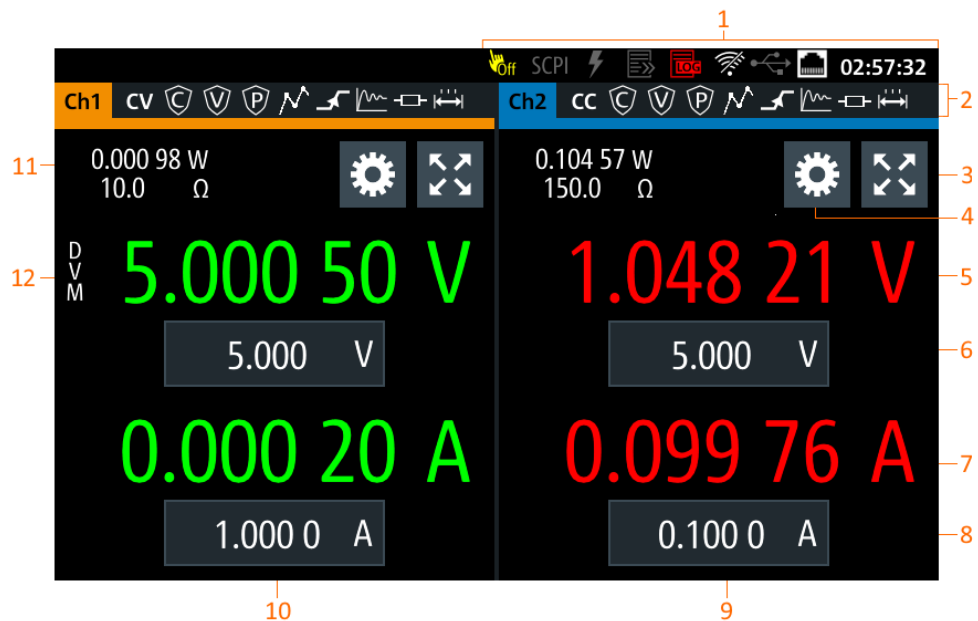

*Figure 4-5: QR code to the Rohde & Schwarz support page*

## 5 Operating Basics

### 5.1 Display Overview

The following displays the home window of R&S NGL/NGM. It shows the output voltage and current level, status bar information and control settings of the instrument.



**Figure 5-1: Home window of R&S NGL/NGM with 2 channels**

- 1 = Device status bar
- 2 = Channel status bar
- 3 = "Expand/Collapse" channel button
- 4 = "Settings" button
- 5 = Measured output voltage
- 6 = Set output voltage
- 7 = Measured output current
- 8 = Set output current limit
- 9 = Channel display area of Ch2
- 10 = Channel display area of Ch1
- 11 = Measured output power and source output resistance/emulated internal impedance
- 12 = DVM function (available only with R&S NGM power supply series)

#### 5.1.1 Status Bar Information

There are two types of status bar. One shows device status information and the other shows the individual channel status information.

## Device status bar





Function	Description
Touchscreen	If touch input is disabled, the icon is displayed and highlighted in yellow. See <a href="#">Chapter 5.3.1.3, "User Key"</a> , on page 40.
SCPI command	If a SCPI command is received successfully, the icon blinks once in white. If an error is in the SCPI error queue, the icon is highlighted in red. If no activity, icon is displayed in gray. See <a href="#">Chapter 7, "Remote Control Commands"</a> , on page 96.
Trigger event	Icon blinks once in white when a trigger event occurs. See <a href="#">Figure 6-18</a> .
Fast log	Fast logging is only visible with NGM models. If active, icon is highlighted in white. If disabled, icon is highlighted in gray. See <a href="#">Chapter 6.11, "FastLog"</a> , on page 75.
Data logging	If data logging is present, the icon is highlighted in white. If an error is present, the icon is highlighted in red. See <a href="#">Chapter 6.10, "Data Logging"</a> , on page 73.
WLAN	Only visible if software option Wireless LAN is active. If connection is present, the icon is highlighted in white. If both WLAN and LAN connection are present, the icon is highlighted with a line cross over. If no connection or WLAN is disabled, the icon is highlighted in gray. See <a href="#">Chapter 6.16.1.2, "Wireless LAN Connection"</a> , on page 87.
USB device interface	If a host command is received in USB interface, the icon is highlighted in white.
LAN interface	If connected, the icon is highlighted in white. If no connection or an error is present in connection, the icon is highlighted in red. See <a href="#">Chapter 6.16, "Interfaces"</a> , on page 83.
Time	Time displays in hh:mm:ss format. See <a href="#">Chapter 6.17.4, "Date and Time"</a> , on page 93.



## Channel status bar



Function	Description
Channel number	Channel number indication.
Operation mode	<p>The R&amp;S NGL/NGM has three operating modes:</p> <ul style="list-style-type: none"> <li>• CV: Constant voltage mode</li> <li>• CC: Constant current mode</li> <li>• CR: Constant resistance mode. The R&amp;S NGL/NGM goes into this mode when operates in sink mode and the "Constant Resistance" mode is activated.</li> </ul> <p>See <a href="#">Chapter 5.5, "Operation Modes"</a>, on page 42.</p>
OCP	<p>If enabled, the icon is highlighted in white.</p> <p>If triggered, the icon blinks.</p> <p>See <a href="#">Chapter 6.5.1, "Overcurrent Protection (OCP)"</a>, on page 58.</p>
OVP	<p>If enabled, the icon is highlighted in white.</p> <p>If triggered, the icon blinks.</p> <p>See <a href="#">Chapter 6.5.2, "Overvoltage Protection (OVP)"</a>, on page 59.</p>
OPP	<p>If enabled, the icon is highlighted in white.</p> <p>If triggered, the icon blinks.</p> <p>See <a href="#">Chapter 6.5.3, "Overpower Protection (OPP)"</a>, on page 60.</p>
Arbitrary mode	<p>If enabled, the icon is highlighted in white.</p> <p>If active, the icon blinks.</p> <p>See <a href="#">Chapter 6.7.1, "Arbitrary"</a>, on page 67.</p>
Ramp mode	<p>If enabled, the icon is highlighted in white.</p> <p>If active, the icon blinks.</p> <p>See <a href="#">Chapter 6.7.2, "Ramp"</a>, on page 70.</p>
"Fast Transient Response"	<p>If enabled, the icon is highlighted in white.</p> <p>The time taken for voltage recovery (<math>\leq 20</math> mV) switches between 30 <math>\mu</math>s and 100 <math>\mu</math>s.</p> <p>See <a href="#">Chapter 6.2.2, "Fast Transient Response"</a>, on page 47.</p>
"Internal Impedance"	<p>If enabled, the icon is highlighted in white.</p>
"Safety Limits"	<p>If enabled, the icon is highlighted in white.</p> <p>See <a href="#">Chapter 6.5.4, "Safety Limits"</a>, on page 61.</p>

Function	Description
"Output Delay" 	If enabled, the icon is highlighted in white. The delay is the time between activation of the output and applying voltage to the output. See <a href="#">Chapter 6.2.3, "Output"</a> , on page 48.
Sense connection 	If sense connection is detected, the icon is highlighted in white.

### 5.1.2 Channel Display Area

The R&S NGL/NGM displays two channels display area (Ch1, Ch2) for NGL202, NGM202 and a single channel display area (Ch1) for NGL201, NGM201. The respective channel settings and functions are displayed for each channel.

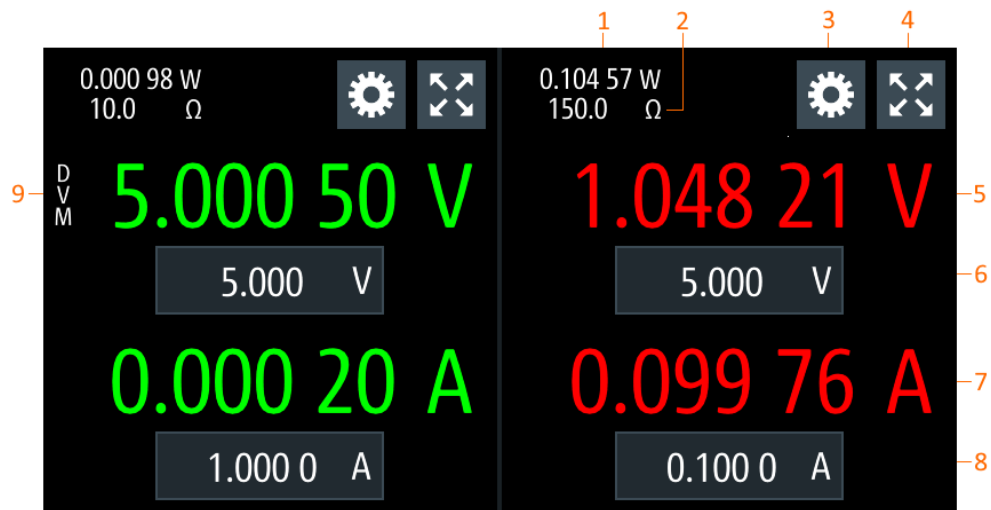

**Figure 5-2: Channel display area for 2-channel model**

- 1 = Output power displays in watt
- 2 = Source output resistance/emulated internal impedance displays in ohms
- 3 = "Settings" button opens instrument device/channel menu window. Long-press on the button opens the [graphical view window](#) for measurements
- 4 = "Expand/Collapse" button toggles between home window and channel overview window
- 5 = Output voltage displays in volt with display resolution of five decimal points
- 6 = Set voltage level with level limit defined in [Safety Limits](#)
- 7 = Output current displays in ampere with display resolution of five decimal points
- 8 = Set current level with level limit defined in [Safety Limits](#)
- 9 = DVM function (available only with R&S NGM power supply series)

#### Operating mode

Different font colors on the screen are used to differentiate the various output status and operating conditions of the instrument. It is easy to know and confirm the different output status and operating conditions of the instrument by looking at the colors.

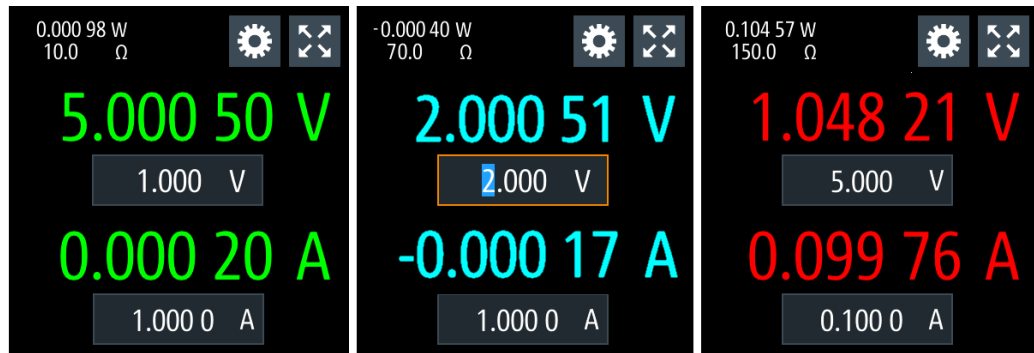

Figure 5-3: Color coding of difference operating conditions

Color	Operating mode	Description
□	DVM mode	Available only with NGM models. Display DVM measurement.
■	Editing mode	A solid blue cursor is shown when an item is selected.
■	CV mode	Active outputs are operated in a constant voltage mode.
■	CC mode	Active outputs are operated in a constant current mode.
■	CR mode	Active outputs are operated in a constant resistance mode. This condition occurs if the set voltage is below the voltage applied externally at the output connectors (sink mode) and constant resistor is switched on in channel menu.

## 5.2 Using the Touchscreen

The R&S NGL/NGM provides a touch-sensitive screen. Touch can be disabled (see [Chapter 6.8, "User Key"](#), on page 71) in the instrument settings. The following illustrates the touchscreen gestures and highlight the different touchscreen features that can be performed on the instrument.

### 5.2.1 Using Gestures



#### Tap

Tap on the screen to select or toggle the value.



#### Swipe up and down

Swipe up to scroll down, swipe down to scroll up in the menu.

### 5.2.2 Accessing Functionality in the Home Window

The following illustrates various ways of accessing functions in the home window.

### 5.2.2.1 Settings Button

The "Settings" button navigates to the device/channel menu window where you can set device or individual channel settings on the instrument.

Long-press on the "Settings" button brings you to the [graphical view window](#) for measurements. For more information, see [Chapter 6.13, "Graphical View Window"](#), on page 78.

1. Select the "Settings" button.  
The R&S NGL/NGM displays device/channel menu window.
2. Select "Device" or respective channel tab ("Channel 1" or "Channel 2") to open the menu.
3. Swipe up or down for the available items in the menu.
4. Select the required items to configure the settings.
5. Select the back arrow key or press [Back] key to close the menu.



Figure 5-4: Navigation on home window > device/channel menu window

### 5.2.2.2 Voltage and Current Inputs

You can directly change the voltage and current level in the respective channel display area.

1. Select the voltage or current field in the channel display area to set value.  
The R&S NGL/NGM displays the on-screen keypad to enter value.
2. Set the required value.  
See [Chapter 5.2.3, "Input Data"](#), on page 36.  
Note: The value is set within the value configured in the "Safety Limits" dialog.
3. Confirm value by selecting a unit key.  
Alternatively, select the enter key  to confirm your value.

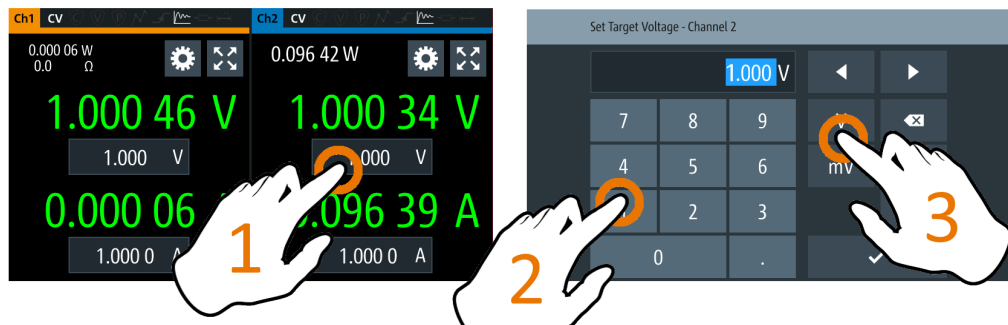

Figure 5-5: Set voltage and current in home window

### 5.2.2.3 Expand/Collapse Button

You can expand the selected channel window by using the "Expand/Collapse" button. The "Expand/Collapse" icon changed when toggled.



1. Select the "Expand/Collapse" button.  
The R&S NGL/NGM expands the selected channel to a full screen displaying the statistics ("Min", "Avg" and "Max" values of power, voltage and current readings, energy calculation and count of samples recorded).
2. To reset the statistics, select the reset button, .
- Note: The statistics provides valid data for up to 365 days of continuous operation, after which the statistics will be reset to zero.
3. Select the "Expand/Collapse" button to revert to the home window.



Figure 5-6: Display of channel overview window

- 1 = Minimum, maximum and average values for power, voltage and current
- 2 = Calculation of energy result
- 3 = Count of samples collected
- 4 = Channel display area of selected channel
- 5 = Digital I/O trigger of selected channel

### 5.2.3 Input Data

The R&S NGL/NGM provides an on-screen keypad for you to enter numerical values. Use the back key  on the on-screen keypad to cancel input of the numerical entries.

1. Select a menu item to enter the numeric value.  
The R&S NGL/NGM displays the on-screen keypad.
2. Enter the required value.
3. Confirm value with the unit key.  
Alternatively, select the enter key  to confirm your value.

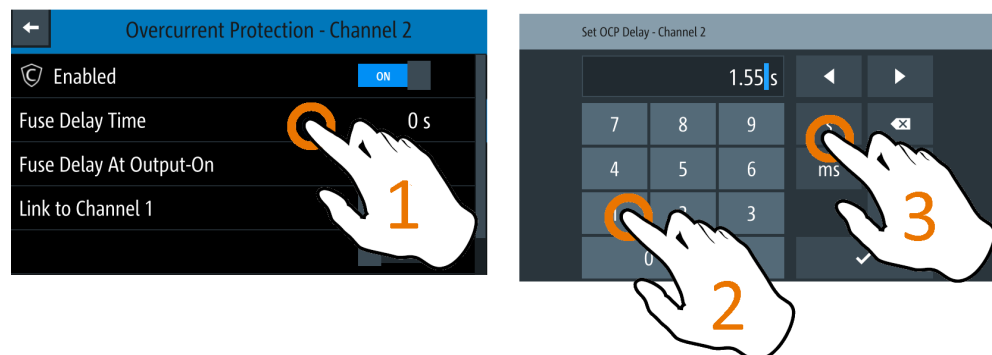



Figure 5-7: Enter numerical value and unit

For alphanumeric input, the on-screen keypad works the same way.

1. Select the "Caps Lock"  key to switch between capital letters and small letters.  
The "Caps Lock" key is highlighted in blue.

2. Select "&123" or "ABC" key to switch between alphabet and numeric input data.

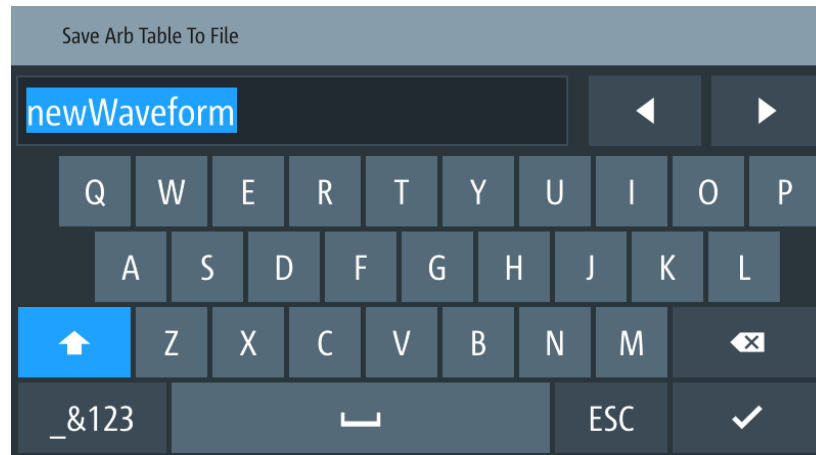

Figure 5-8: Alphanumeric input data

## 5.3 Front Panel Keys

For an overview of the front panel keys, see [Figure 4-2](#).

### 5.3.1 Menu Controls

The menu controls keys provide navigation on the available menus in the instrument.

#### 5.3.1.1 Home Key



The [Home] key navigates to the instrument home window. See the display of the home window in [Figure 5-1](#).

#### 5.3.1.2 Settings Key



The [Settings] key navigates to the device/channel menu window which consists of the "Device" menu and up to two channels ("Channel 1", "Channel 2") menu.

Long-press on the [Settings] key also navigates to the graphical view window. For more information, see [Chapter 6.13, "Graphical View Window"](#), on page 78.

#### Device menu

The "Device" menu provides access to general instrument settings, file arrangement and user key configuration. You can also obtain the instrument information via the menu.

1. Press [Home] key.

The R&S NGL/NGM displays the home window.

2. Select the "Settings" button on the required channel display area.  
Alternatively, press [Settings] key.
3. Select the "Device" tab to access the device menu.

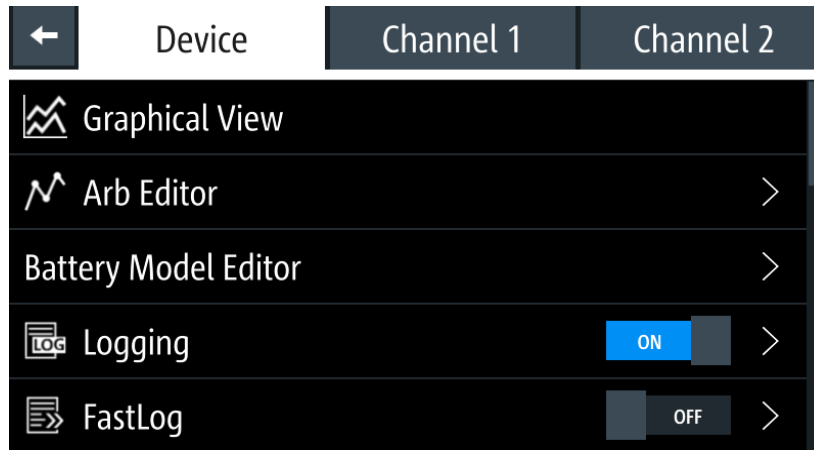

Figure 5-9: Device menu

Menu	Description
"Graphical View"	Graphical display of available data source (e.g. voltage, current, etc.)
"Arb Editor"	Programs the waveform of voltage and current settings for the channel output.
"Battery Model Editor"	Available only with option R&S NGM-K106. Edit new or existing battery model data.
"Logging"	Data logging on the instrument timestamp, voltage, current and power.
"FastLog"	Available only with R&S NGM power supply series. Fast data logging on the instrument timestamp, voltage and current.
"Trigger"	Activates the trigger source for SCPI command (*TRG).
"Digital Output"	Available only with option R&S NGL-K103 or R&S NGM-K103. Configures the output fault, output 1 and output 2.
"File Manager"	File transfer function between instrument internal memory and USB stick.
"Interfaces"	Wireless LAN is available only with option R&S NGL-K102 or R&S NGM-K102. IEEE-488 (GPIB) interface is available only with option R&S NGL-K105 or R&S NGM-K105. Configures the network (WLAN, Wireless LAN), USB interface and GPIB address



Menu	Description
"User Button"	Configures the shortcut key action (e.g. screenshot, trigger, toggle logging, reset statistics, toggle touch).
"Screenshot"	Captures screen image of the instrument.
"CSV Settings"	Configures the file formatting for CSV file.
"Data & Time"	Configures date, time and clock format of the instrument.
"Appearance"	Configures brightness level for screen display and frontpanel keys.
"Sound"	Enables or disables beeper for trigger events (e.g. error, fuse tripped, cc-mode continuous).
"Licenses"	Displays license information and install license options.
"Device Information"	Displays instrument information.
"Update Device"	Performs firmware update on the instrument.
"Save/Recall Device Settings"	File management on the instrument settings. Resets instrument settings with factory default.

### Channel menu

The "Channel 1" or "Channel 2" menu provides access to settings on channel output, channel trigger conditions and output limit settings.

1. Press [Home] key.  
The R&S NGL/NGM displays the home window.
2. Select the "Settings" button on the selected channel display area.  
Alternatively, press [Settings] key to access the required channel menu.
3. Select the "Settings" button on the channel display area.  
Alternatively, press [Settings] key to access the channel menu.



Figure 5-10: Channel 1 menu

Menus	Description
"Output"	Configures the output impedance, output delay time, trigger actions and output mode (sink/source) of the output.
"Arbitrary"	Configures the arbitrary sequence, sequence repeatability response and the sequence ending behavior.
"Ramp"	Configures the ramping time applied on the channel output.
"Battery Simulator"	Available only with option R&S NGM-K106. Activation of the "Battery Simulator" function and edit new battery model data.
"Overcurrent Protection (OCP)"	Configures OCP protection settings ("Blowing Delay", "Initial Delay" and linking channel) for the instrument.
"Overvoltage Protection (OVP)"	Configures OVP protection settings (OVP level) for the instrument.
"Overpower Protection (OPP)"	Configures OPP protection settings (OPP power) for the instrument.
"Ranges / DVM"	The "Ranges" function provides the voltage and current measurement range settings. With correct range settings, it increases the accuracy of measurements.  The DVM is available only with option R&S NGM-K104. It provides an independent digital voltmeter to measure input voltage.
"Constant Resistance"	Configures the resistance used in the sink mode.
"Fast Transient Response"	Enables/Disables the "Fast Transient Response" function on the channel output.
"Safety Limits"	Configures the voltage and current limit of the channel output.

### 5.3.1.3 User Key

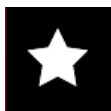

The [\*] key provides a shortcut function to one of the followings:

- screenshot
- trigger
- data logging
- reset statistics
- toggle touchscreen input

The shortcut key is configurable in the "Device" > "User Button" menu. See [Chapter 6.8, "User Key"](#), on page 71.

### 5.3.2 Navigation Controls

Navigation in the menu and setting of values can be done via rotary knob and [Back] key.

### Rotary knob



The rotary knob has several functions:

- Increments (clockwise direction) or decrements (counter-clockwise direction) any kind of numeric value when in editing mode
- Navigates up (clockwise direction) or down (counterclock-wise direction) the menu or menu items when rotated
- When pressed and rotated, the rotary knob navigates along the set voltage or current position in the home window

### [Back] key

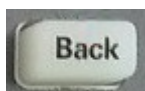

Using the [Back] key, you can do several things:

- Navigate to the previous menu window
- Close or discard changes made on the on-screen keypad
- Close the instrument pop-up messages

## 5.3.3 Output and Channel Controls

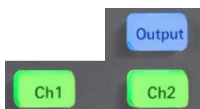

Applicable only for 2-channel models (NGL202, NGM202), these keys control the channel output settings of the instrument.

Function keys	Description
[Ch1], [Ch2]	Selects the respective channel for output.
[Output]	Master output switch - it turns output for all selected channels on or off.

## 5.4 Power Derating

The NGL202, NGM202 models include two identical channels with a continuous voltage range of 0 V to 20.05 V. The instrument provides a source of up to 6.01 A for voltage below 6 V and 3.01 A for voltage range from 6 V to 20 V.

Similar to NGL202, NGM202, the NGL201, NGM201 models provide a single channel with an output power of up to 60 W.

Combination of the set voltage and current limit results in the following output performance graph.

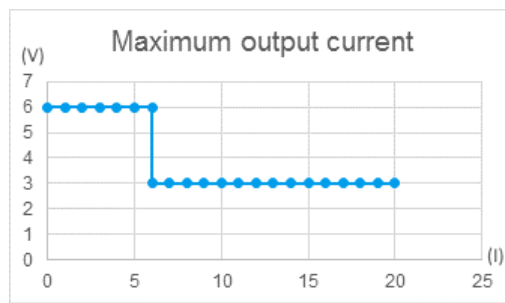

Figure 5-11: Output performance graph

## 5.5 Operation Modes

The R&S NGL/NGM operates in three different modes, i.e. the constant voltage (CV), constant current (CC) and constant resistance (CR). The instrument switches automatically between CV and CC depending on the connected load. When CR is **configured**, the instrument is not switched to CR mode automatically, it will operate in CR mode when sinking but source in CV or CC mode.

### CV mode

Figure 5-12 shows that if the instrument is in the range of voltage regulation, the output voltage  $V_{out}$  remains constant while the current may increase to its maximum value  $I_{max}$  when the connected load is increasing. In CV mode, the font text in the channel display area changes to green.

See Figure 5-3.

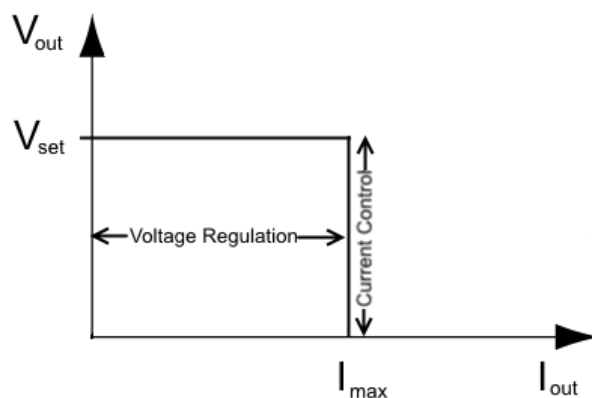

Figure 5-12: Current limit

### CC mode

The current  $I_{max}$  corresponds to the current setting adjustable in the instrument.

If  $I_{out}$  reaches  $I_{max}$ , the instrument switches to CC mode, i.e. the output current remains constant and limited to  $I_{max}$  even if the load increases. Instead, the output voltage  $V_{out}$  decreases to almost zero with a short circuit. In CC mode, the font text in the channel display area changes to red.

See [Figure 5-3](#).

### CR mode

To go into CR mode, the R&S NGL/NGM must operate in sink mode where current flows into the instrument and "Constant Resistance" is enabled.

With "Constant Resistance" enabled and configured, the R&S NGL/NGM can set the resistance in sink mode, this allows the R&S NGL/NGM to behave like an electronic load which is useful in battery test application.

In CR mode, the font text in the channel display area changes to cyan.

See [Figure 5-3](#).

## 6 Instrument Functions

### 6.1 Setting the Channels Voltage and Current

The R&S NGL/NGM comes with the following instrument models:

Models	Channels
NGL201, NGM201	Ch1
NGL202, NGM202	Ch1, Ch2

Toggle the respective channel key ([Ch1], [Ch2] ) on the front panel to select these channels. When a channel is selected, the respective channel key illuminates.



Figure 6-1: Ch2 key illuminates when selected

#### Set output voltage and current



#### Voltage, current settings

If **Arbitrary** function of a selected channel is enabled, the respective channel voltage or current setting is disabled.

The R&S NGL/NGM adjusts the voltage values between 0 V to 20.05 V with a step size of 1 mV and current values between 0 A to 6.01 A with a step size of 0.1 mA.

The setting of current value corresponds to the  $I_{\max}$  of the respective channel. It is advisable to set the current limit before operating the instrument to prevent damage to the load and instrument in the case of malfunction such as a short-circuit.

1. Press [Home] key.  
The R&S NGL/NGM displays the home window.
2. Set voltage or current in the home window.  
The R&S NGL/NGM displays the on-screen keypad to set value.
3. Enter the required voltage or current value.
4. Confirm value with the unit key (V/mV or A/mA).
5. Press the required channel key ([Ch1] or [Ch2]) on the front panel.  
The selected channel key is illuminated. See [Figure 6-1](#).
6. Press the [Output] key on the front panel.  
The R&S NGL/NGM outputs the set voltage of the selected channel and displays the corresponding values in the home window.

For more information on the operation modes, see [Chapter 5.5, "Operation Modes"](#), on page 42.



*Figure 6-2: Voltage and current settings in the instrument*

## 6.2 Activating the Channels Output

The outputs of all the channels (Ch1, Ch2) can be switched on or off by toggling the [Output] key on the front panel.

By default, the output is turned off when the instrument is switched on. The output is also automatically turned off when no channel is selected. This design prevents a connected load from being damaged unintentionally.

1. Press the required channel key.  
Selected channel key (Ch1, Ch2) illuminates.
2. Press [Output] key.  
The R&S NGL/NGM outputs the set voltage of the selected channel.  
Depending on the operating mode, the font text in the channel display area shows green in CV mode, red in CC mode and cyan in CR mode.  
Note: The R&S NGL/NGM goes into CR mode when CR is enabled and the instrument operates in sink mode.  
See [Chapter 5.5, "Operation Modes"](#), on page 42.  
See also [Chapter 5.4, "Power Derating"](#), on page 41.

Multiple outputs can be turned on or off at the same time.



Figure 6-3: Output of Ch2 in CV mode

### 6.2.1 Set Constant Resistance

CR

By enabling the constant resistance (CR) mode, you can operate the R&S NGL/NGM as an electronic load in sink mode. This allows you to perform testing that requires a constant load resistor in your application.

1. Press [Settings] key.  
The R&S NGL/NGM displays the device/channel menu window.
2. Select the required channel tab to apply constant resistance.  
The R&S NGL/NGM displays the selected channel menu.
3. Select the "Constant Resistance" from the menu.  
The R&S NGL/NGM displays the "Constant Resistance" dialog.
4. Activate the "Enabled" menu item.  
When operates in sink mode condition, the R&S NGL/NGM displays the "Constant Resistance" icon on the selected channel status bar information.
5. Set the required resistance.  
The R&S NGL/NGM displays the on-screen keypad to set the value.
6. Confirm value with the unit key (mΩ or Ω).  
The value for "Constant Resistance" is rounded to the nearest 1 Ω or 0.1 Ω, depending on the value.





Figure 6-4: Constant resistance dialog

## 6.2.2 Fast Transient Response



With fast transient response, the R&S NGL/NGM is able to quickly stabilize the output voltage upon a step change in the load current.

Load transient recovery time can be switched between 30  $\mu\text{s}$  ("Fast Transient Response" = "ON") or 100  $\mu\text{s}$  ("Fast Transient Response" = "OFF") for the output voltage to recover and stay within 20 mV of the nominal output voltage follows by a step change in the load current.

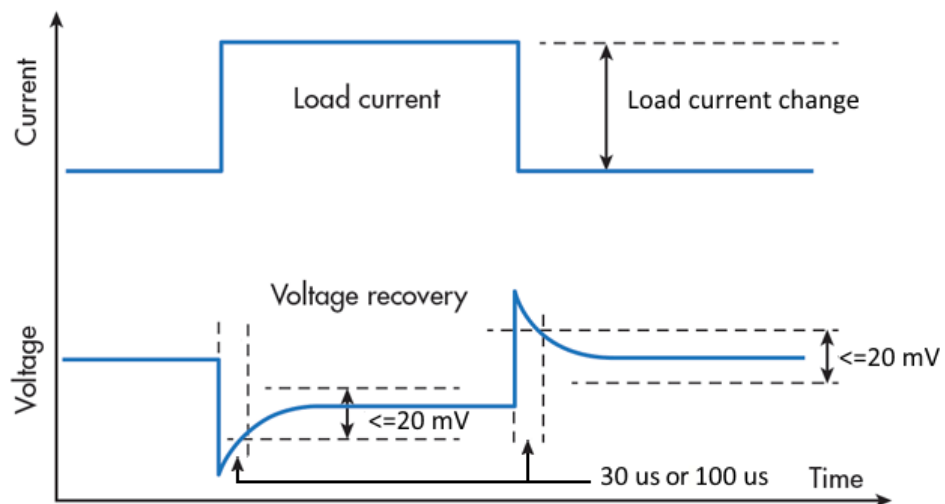

Figure 6-5: Transient response graph

1. Press [Settings] key.  
The R&S NGL/NGM displays the device/channel menu window.
2. Select the required channel tab to apply fast transient response.  
The R&S NGL/NGM displays the selected channel menu.

3. Activate the "Fast Transient Response" from the menu.  
The R&S NGL/NGM applies the fast transient response on the operating condition and displays the "Fast Transient Response" icon on the selected channel status bar information.  
The setting of "Fast Transient Response" affects the output voltage control loop behavior. See [Chapter 6.2.3.1, "Impedance"](#), on page 48.  
If activated, the focus is on control loop speed, which is recommended for resistive loads. Otherwise, the focus is on stability and should be preferred for capacitive or inductive loads.

### 6.2.3 Output



The "Output" menu provides the settings for [output impedance](#), [output delay](#) and [triggers action](#) on the output mode.

1. Press [Settings] key.  
The R&S NGL/NGM displays the device/channel menu window.
2. Select the required channel tab to apply output delay.  
The R&S NGL/NGM displays the selected channel menu.
3. Select the "Output" menu item.  
The R&S NGL/NGM displays the "Output" dialog.

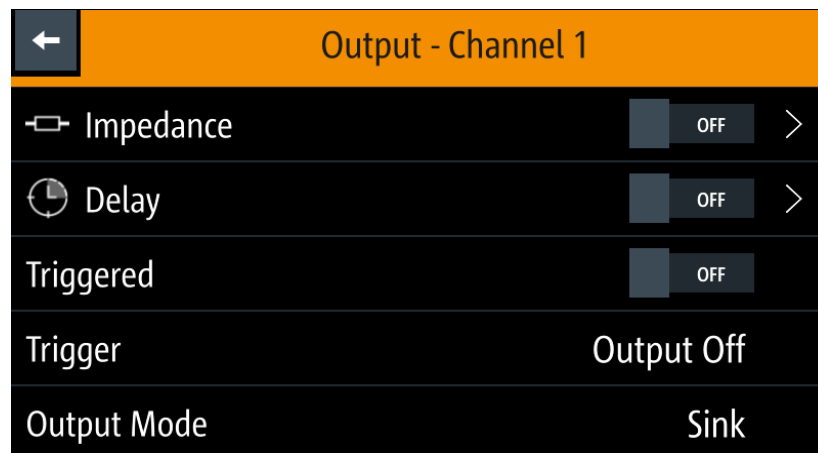

Figure 6-6: Output delay dialog

#### 6.2.3.1 Impedance



The output impedance function is disabled during voltage ramp time of "Ramp" function. See [Chapter 6.7.2, "Ramp"](#), on page 70.

1. Select the "Impedance" menu item to configure the required values.

The R&S NGL/NGM displays the "Output Impedance" dialog.

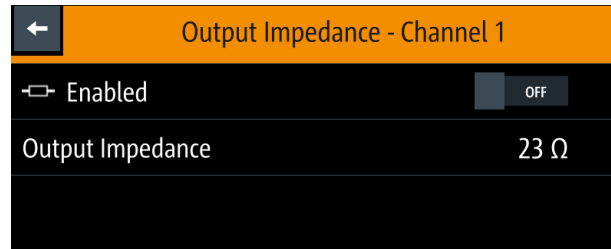

2. Set the required value.  
The R&S NGL/NGM displays the onscreen keypad for entry.
3. Confirm value with the unit keys.

The output impedance control loop depends on the setting "Fast Transient Response". See [Chapter 6.2.2, "Fast Transient Response"](#), on page 47.

The output impedance is only active during CV (constant voltage) operation mode.

### 6.2.3.2 Delay

1. Select the "Delay" menu item to configure the required values.  
The R&S NGL/NGM displays the "Output Delay" dialog.

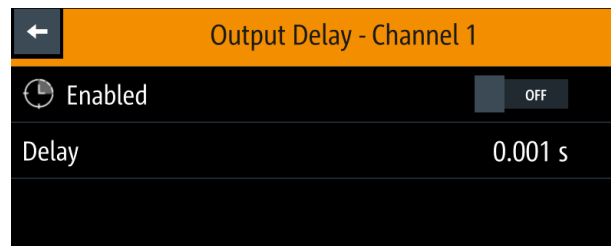

2. Set the required value.  
The R&S NGL/NGM displays the onscreen keypad for entry.
3. Confirm value with the unit keys.

The output delay is the time between the "Output On" event and the available voltage at the output terminals. See [Figure 6-7](#).

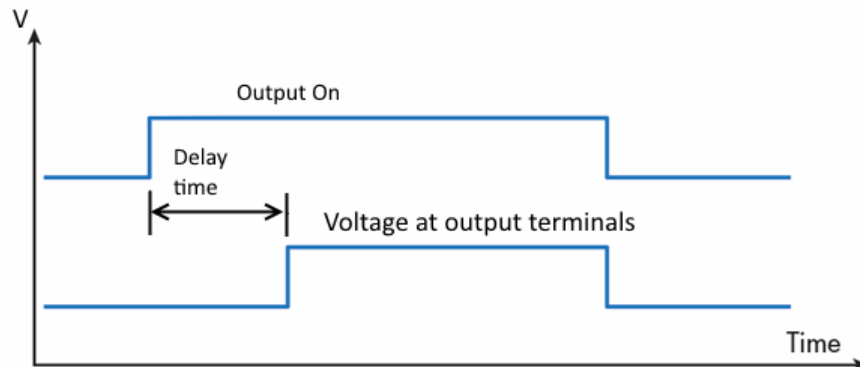

Figure 6-7: Output delay at the output terminals

When the instrument output delay is activated, the front panel of the respective channel key (i.e [Ch1], [Ch2]) blinks in green and a "DELAY" red text is displayed at the channel display area of the respective channel. See [Figure 6-8](#).

These operating behaviors resume to normal after the delay time.

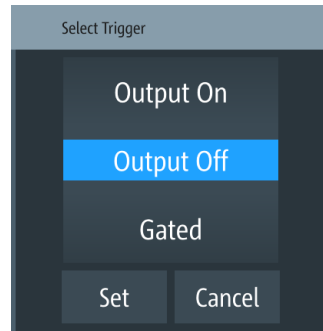

Figure 6-8: Delay text at channel display area

### 6.2.3.3 Trigger Events

1. Select the "Triggered" menu item to activate the trigger event corresponding to the trigger parameters.  
See [Figure 6-18](#).
2. Select the "Trigger" menu item to set the action if a trigger event happens.

The R&S NGL/NGM displays the "Trigger" dialog.



3. Select the required trigger action.
  - "Output On": If triggered, the selected output channel is turned on.
  - "Output Off": If triggered, the selected output channel is turned off.
  - "Gated": If triggered, the selected output channel is gated.
4. Select "Set" to configure the trigger action.

#### 6.2.3.4 Output Mode

1. Select the "Output Mode" menu item to set the output mode. See ["Source and sink current"](#) on page 26.

The R&S NGL/NGM displays the "Output mode" dialog.

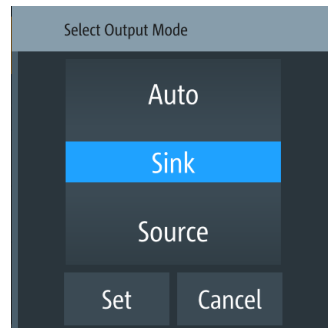

2. Select the required output mode.
  - Auto: Depending on the voltage across the output terminal, the R&S NGL/NGM goes into sink or source mode.
  - Sink : The R&S NGL/NGM goes to sink mode, current flows into the instrument. On display, the current shown negative current.
  - Source: The R&S NGL/NGM goes to source mode, current flows out from the instrument.

**Note:** If "Sink" mode is selected, the source current is limited to 1 mA. Otherwise, if "Source" is selected, the sink current is limited to 1 mA.
3. Select "Set" to configure the trigger condition.

## 6.3 Ranges / Digital Voltmeter (DVM)



### Instrument option

R&S NGM-K104 (P/N: 3643.9927.02) option is required for Digital Voltmeter measurements.

Ranges / Digital Voltmeter (DVM) is only available on NGM devices.



Sense connection has to be connected to the load for better performance.

Equipped with option R&S NGM-K104, the R&S NGM provides an independent digital voltmeter (DVM) to measure input voltage. See the datasheet for the full range of voltages that DVM supported.

Connection for the DVM measurement is wired from the instrument rear panel.

If DVM measurement is activated, the displaying of output voltage is not possible on the same channel. See ["Output terminals"](#) on page 23.

See [Figure 6-9](#) for the wiring example on measuring a voltage source from rear panel connector.

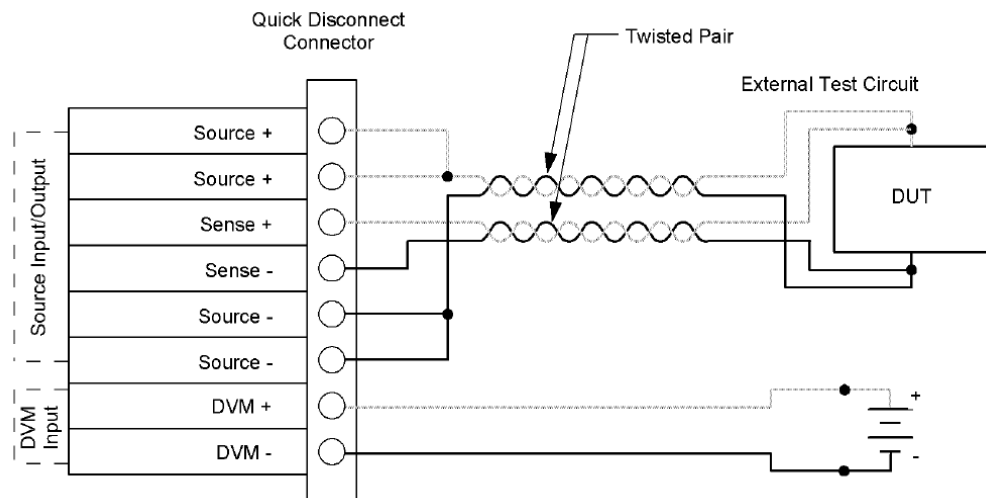

**Figure 6-9: Rear panel four-wire sense and DVM connection**

1. Press [Settings] key.  
The R&S NGL/NGM displays the device/channel menu window.
2. Select the required channel tab to configure DVM function.  
The R&S NGL/NGM displays the selected channel menu.
3. Select the "Ranges / DVM" from the menu.  
The R&S NGL/NGM displays the "Ranges / DVM" dialog.

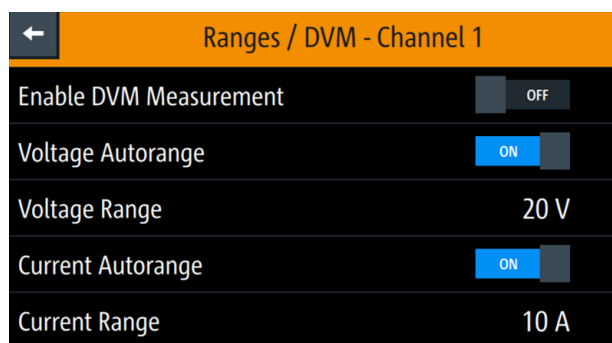

Figure 6-10: Range/DVM dialog

**Note:** The "Voltage Autorange" and "Voltage Range" are not available if DVM is enabled.

4. Activate the "Enable DVM Measurement" menu item.  
The R&S NGL/NGM enables the DVM measurement and displays a DVM text in the channel display area. See [Chapter 5.1.2, "Channel Display Area"](#), on page 32.
5. To configure the voltage range, set "Enable DVM Measurement" to "OFF".  
Select any of the following to configure the voltage and current measurement range.
  - "Voltage Autorange" / "Current Autorange": Best display of voltage or current measurement range
  - "Voltage Range" / "Current Range": See [Table 6-1](#).  
To select the voltage or current range, set the auto range to "OFF".

### Measurement range

Correct setting of voltage and current range increases the accuracy of the voltage/current measurements. Measuring outside the range values may result in invalid measurements with OVERLOAD indicator.

See the datasheet for the measurement accuracy according to the measurement range selected.



It is recommended to set a manual measurement range for very frequent range changes.

Table 6-1: Voltage and current range

Available voltage ranges	
Auto	Instrument selects the best range to display.
5 V	Accuracy from 0 V to 5 V.
20 V	Accuracy from 0 V to 20.05 V.
Available current ranges	
Auto	Instrument selects the best range to display.

10 A	Accuracy from 0 A to 10 A.
1 A	Accuracy from 0 A to 1 A.
100 mA	Accuracy from 0 A to 100 mA.
10 mA	Accuracy from 0 A to 10 mA.

## 6.4 Battery Simulator



### Instrument option

R&S NGM-K106 (P/N: 3636.6626.02) option is required.  
Battery Simulator is only available on NGM devices.



If battery simulator is active, the function [safety limits](#) cannot be used.

Equipped with battery simulator option, the R&S NGM can be used as a battery source in developing products whereby battery is not ready for testing, such as phones and portable devices.

The R&S NGM provides a battery simulator editor to configure the battery model at different states to analyze the products behavior under specific conditions. Different battery state of charge (SoC) can be simulated rapidly without waiting for the charging or discharging process of a normal battery when conducting tests.

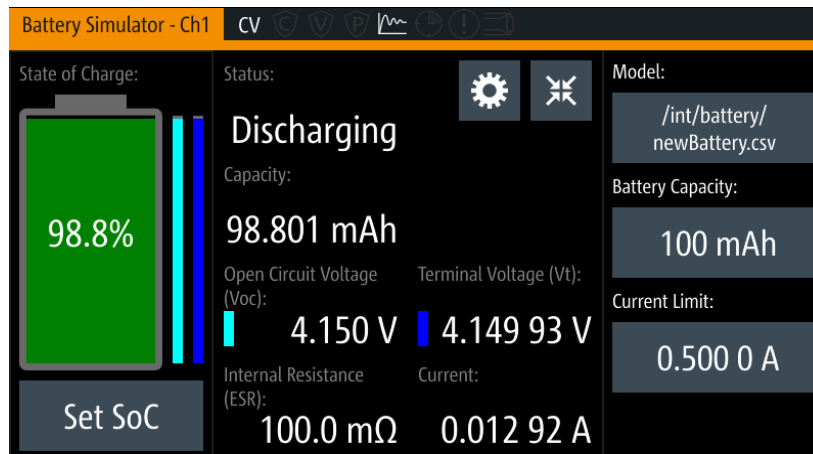
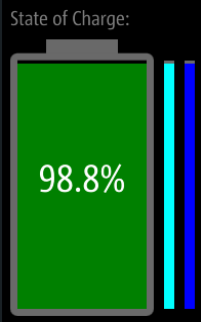
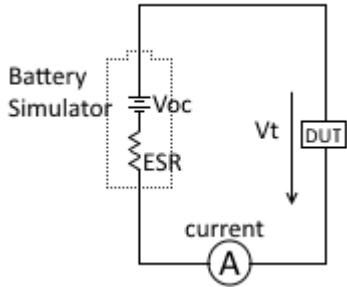

Figure 6-11: Battery simulator for Ch1



Table 6-2: Battery simulator parameters

Battery simulator parameters	Descriptions
	<p>The battery symbol represents the state of charge.</p> <p>The light blue bar indicates the open circuit voltage and the dark blue bar indicates the terminal voltage. The differences between both bars show the voltage drops on internal resistance.</p> <p>Scale: the maximum of both bars are the maximum defined voltage in the battery model and the minimum is the minimal defined voltage.</p> <p>See <a href="#">Figure 6-13</a>.</p>
SoC	State of charge represents the current battery capacity, e.g. 85% SoC represents that 15% of battery capacity is used.
	<p>The open circuit voltage, <math>V_{oc}</math> is the voltage between the battery terminals with no load applied. The <math>V_{oc}</math> depends on the loaded battery model and the current SoC.</p> <p>The internal resistance, ESR (also known as Equivalent Series Resistance) depends on the loaded battery model and current SoC.</p> <p>The terminal voltage, <math>V_t</math> is the voltage between the battery terminals with applied voltage drop over the ESR. Terminal voltage varies with charge or discharge current.</p>
Model	The loaded battery model applied in the battery simulator.
Battery capacity	<p>The storage capacity for the battery:</p> <ul style="list-style-type: none"> <li>• Minimum value: 1 <math>\mu</math>Ah</li> <li>• Maximum value: 100 kAh</li> </ul> <p>Editing a new value here overwrites the current value loaded from the <a href="#">battery model editor</a>.</p>
Current limit	<p>In addition to the resistance of the battery model, current flow can be limited to protect possibly sensitive equipment connected to the device.</p> <p>There are three current limit settings available:</p> <ul style="list-style-type: none"> <li>• SoC &lt; 0 % (the battery is empty)</li> <li>• SoC 0 % to 100 % (the battery is in normal operation mode)</li> <li>• SoC &gt; 100 % (the battery is fully loaded)</li> </ul>

1. Press [Settings] key.  
The R&S NGM displays the device/channel menu window.
2. Select the required channel tab to configure the battery simulator function.  
The R&S NGM displays the selected channel menu.
3. Select the "Battery Simulator" menu item from the menu.  
The R&S NGM displays the "Battery Simulator" dialog.

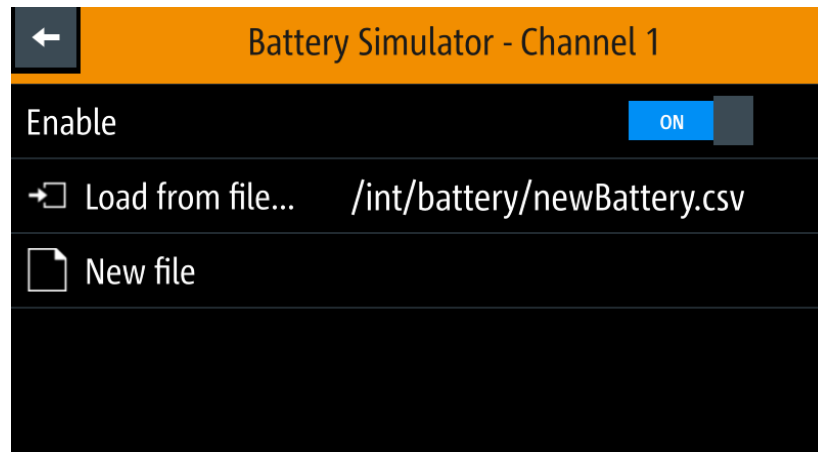
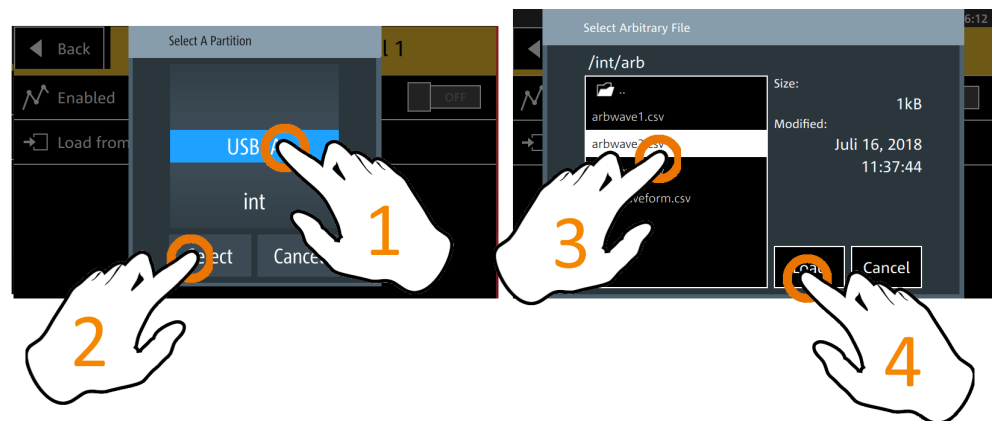



Figure 6-12: Battery simulator dialog

4. Select the "Load from file..." to load the battery model file.  
The R&S NGM opens a dialog to select the source and file location.
5. Select the required source and file location.  
Alternatively, select "New file" to create a new battery model. The R&S NGM opens the [battery model editor dialog](#) to edit the new battery model file.



6. Activate the "Enabled" menu item.  
The R&S NGM enables the battery simulation function.

### Battery model editor

The battery model editor allows you to create and edit battery models with custom behavior. In the editor, the open circuit voltage (Voc) and the equivalent series resistance (ESR) can be defined for different states of charge (SoC) of the battery. Select  to open the list of available battery model files.

State of Charge (SoC)	Open-Circuit Voltage (Voc)	Internal Resistance (ESR)
0 %	3.003 V	0.083 Ω
1 %	3.493 V	0.074 Ω
2 %	3.494 V	0.073 Ω
3 %	3.572 V	0.068 Ω

Figure 6-13: Battery model editor dialog

- Configure the "Battery Model Editor" with the required state of charge (SoC), open-circuit voltage (Voc) and internal resistance (ESR).  
The R&S NGM displays the on-screen keypad for data entry.  
The R&S NGL/NGM displays the on-screen keypad for data entry.  
See also [Table 6-2](#).
- Confirm values with the unit keys.
- Select the or icon to add or remove a row of data from the model.
  - : A new row of data is added to the model. It is initially filled with the data of the currently selected row.
  - : Removes the currently selected row from the model.
- Select "Capacity" and "Initial SoC" to configure the capacity and initial state of charge of the battery.  
The R&S NGM displays the on-screen keypad for data entry.
- Select (existing file) to save the changes made to an existing file or select (new file) to save the table as a new battery model file.  
The R&S NGM displays a popup message to show that the file was saved successfully.

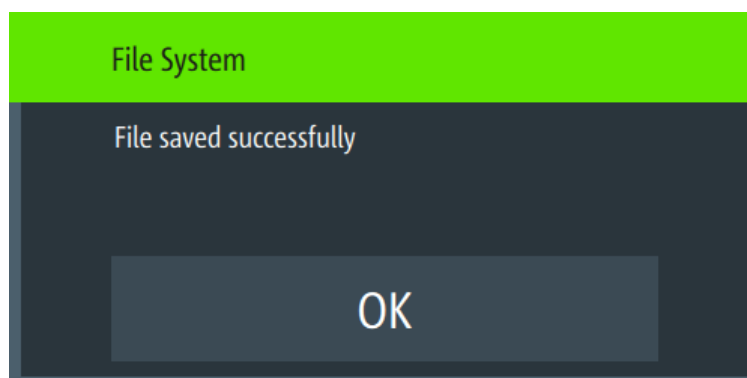

## 6.5 Protection

There are various ways in which the R&S NGL/NGM protects itself and the connected load from damage due to overvoltage, overcurrent and overpower drawn by the load during testing.

1. Press [Settings] key.  
The R&S NGL/NGM displays the device/channel menu window.
2. Select the required channel tab to configure the various protection dialogs.  
The R&S NGL/NGM displays the selected channel menu.

### 6.5.1 Overcurrent Protection (OCP)



When the drawn current exceeds the limit set for the respective channels, an alert is triggered and the affected channels are turned off according to the settings configured in the OCP dialog.

1. Select "Overcurrent Protection (OCP)" from the menu.  
The R&S NGL/NGM displays the OCP dialog.

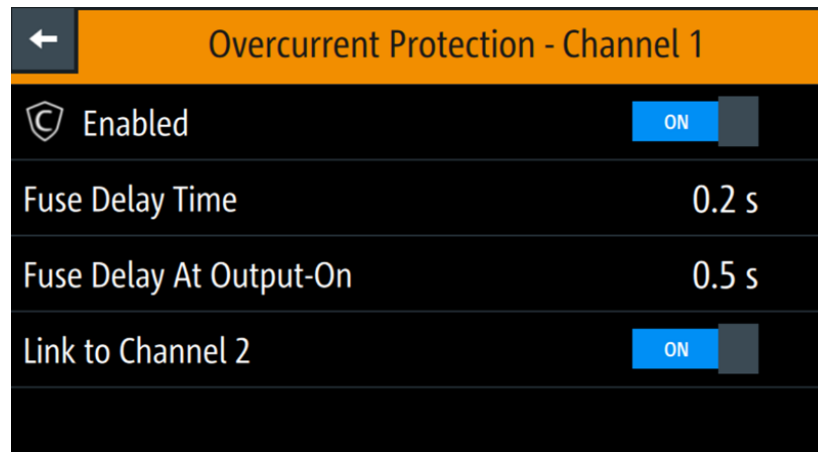

Figure 6-14: Overcurrent protection dialog

2. Activate the "Enabled" menu item.  
The R&S NGL/NGM enables the OCP and displays the OCP icon on the selected channel status bar information.
3. Set the required "Fuse Delay Time" and "Fuse Delay At Output-On".  
The R&S NGL/NGM displays the on-screen keypad to set the values.
  - "Fuse Delay Time": The time taken to turn off the affected channel after OCP is triggered.
  - "Fuse Delay At Output-On": The time taken after channel output is turned on before OCP is put into operation.
4. Confirm value with the unit key (ms or s).
5. Activate the "Link to Channel 2" or "Link to Channel 1" menu item.
  - ON: The linked channel is turned off when an OCP event is triggered.
  - OFF: The linked channel is not affected when an OCP event is triggered.

## 6.5.2 Overvoltage Protection (OVP)



When the output voltage exceeds the limit set for the respective channel, an alert is triggered and the affected channel is turned off according to the settings configured in the OVP dialog.

1. Select "Overvoltage Protection (OVP)" from the menu.  
The R&S NGL/NGM displays the OVP dialog.

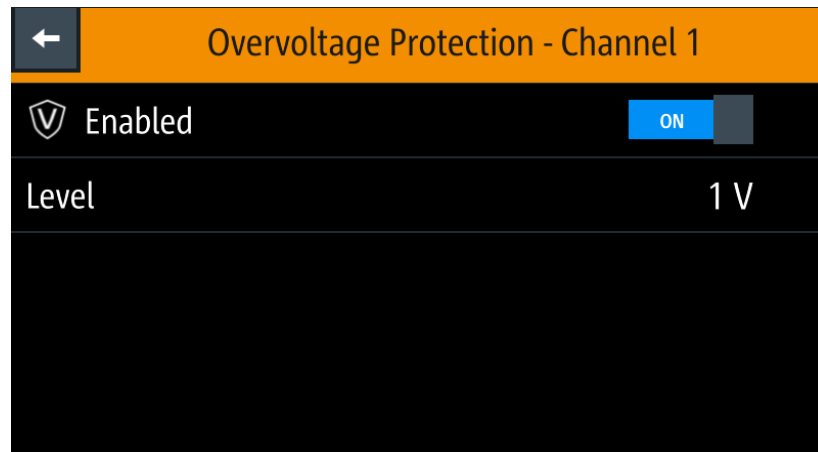

Figure 6-15: Overvoltage protection dialog

2. Activate the "Enabled" menu item.  
The R&S NGL/NGM enables the OVP and displays the OVP icon on the selected channel status bar information.
3. Set the required level for OVP.  
The R&S NGL/NGM displays the on-screen keypad to set the value.
4. Confirm value with the unit key (mV or V).

### 6.5.3 Overpower Protection (OPP)



When the output power exceeds the limit set for the respective channels, an alert is triggered and the affected channels are turned off according to the settings configured in the OPP dialog.

1. Select "Overpower Protection (OPP)" menu item.  
The R&S NGL/NGM displays the OPP dialog.

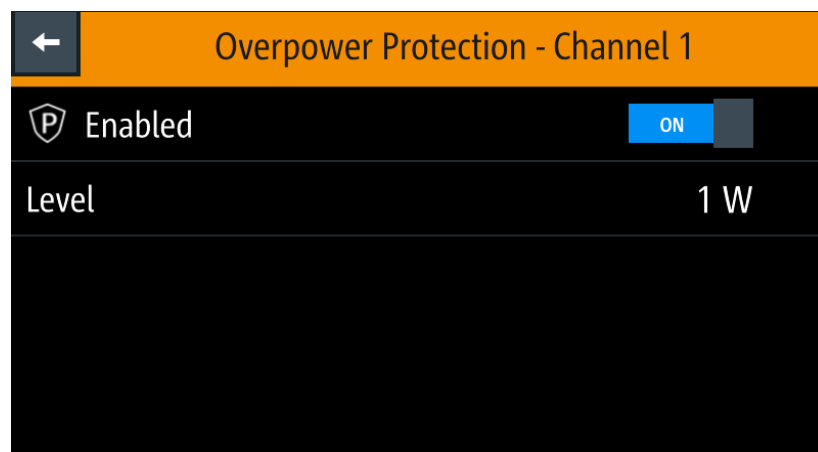

Figure 6-16: Overpower protection dialog

2. Activate the "Enabled" menu item.  
The R&S NGL/NGM enables the OPP and displays the "Overpower Protection (OPP)" icon on the selected channel status bar information.
3. Set the required level for OPP.  
The R&S NGL/NGM displays the on-screen keypad to set the value.
4. Confirm value with the unit key (mW or W).

#### 6.5.4 Safety Limits



With safety limits set in the instrument, the range of the output voltage and/or output current can be limited. The safety limit prevents inadvertently setting values dangerous for the connected DUT.



The "Safety Limits" function is disabled if [Arbitrary](#) function or [Battery Simulator](#) function is in use.

1. Select "Safety Limits" menu item from the menu.  
The R&S NGL/NGM displays the "Safety Limits" dialog.



Figure 6-17: Safety limits dialog

2. Activate the "Enabled" menu item.  
The R&S NGL/NGM limits the set voltage and current level and displays the "Safety Limits" icon on the selected channel status bar information.
3. Set the required minimum and maximum value for voltage and current level.  
The R&S NGL/NGM displays an on-screen keypad to set the value.
4. Confirm value with the unit key.

## 6.6 Trigger / Digital I/O

### CAUTION

#### Digital I/O pins voltage rating

Do not exceed the maximum voltage rating of the Digital I/O pins when supplying voltages to the pins.

The specified voltages are 0 V to 24 V for all output pins and 0 V to 15 V for all input pins.

For more information, see the instrument datasheet (P/N: 5216.1057.32).



#### Instrument option

R&S NGL-K103 (P/N: 3652.6385.02) or R&S NGM-K103 (P/N: 3643.9904.02) option is required for the Digital I/O signals.

Option is not required for "User Button" and "\*TRG" trigger-in signals.

With an optional Digital I/O, you can apply a single trigger-in signal and control multiple trigger-out signals on the instrument. These trigger-out signals can be used to perform function such as triggering the data logger to record instrument when a channel output is active or protection event is used to trigger the digital out pin, which in turn can be used for fuse linking between two instruments.

The trigger system has two latency types: low latency and software latency. While low latency triggers are executed faster, the software latency does not have additional requirements.

The low latency actions are highlighted in bold (blue) and required to have same hardware channel for trigger source and trigger target.

See [Figure 6-18](#) for an overview of the trigger IO system.



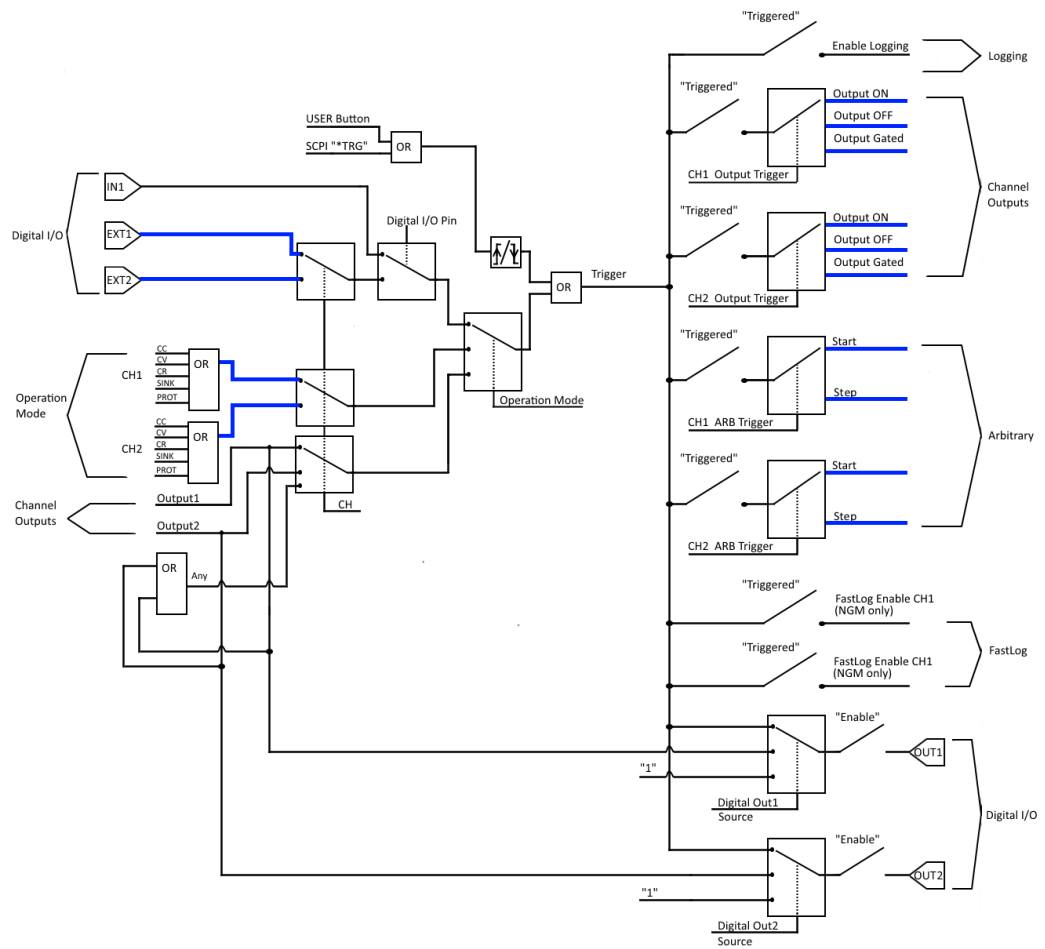

Figure 6-18: Overview of trigger IO system

Table 6-3: Trigger-in signals

Trigger-in parameters	Source	Descriptions
Ext. Trigger Ch1 Ext. Trigger Ch2	Digital In, pin 2 of <a href="#">Digital I/O connector</a> Digital In, pin 10 of <a href="#">Digital I/O connector</a>	If detected, corresponding trigger-out parameters are triggered. The external trigger signal is low active (inverted logic). See <a href="#">Figure 6-18</a> .
Digital I/O In1	Digital In, pin 3 of <a href="#">Digital I/O connector</a>	If detected, corresponding trigger-out parameters are triggered. The Digital I/O In1 signal is low active (inverted logic). See <a href="#">Figure 6-18</a> .
Output channel 1 Output channel 2 Any of the channels	Output	If respective channel output is turned on, corresponding trigger-out parameters are triggered. If "Any" is selected, the corresponding trigger-out parameters are triggered if any of the available channels meet the condition. See <a href="#">Figure 6-18</a> .

Trigger-in parameters	Source	Descriptions
CC, CV, CR, Protection, Sink	Operation Mode	If respective channel <a href="#">operation modes</a> , <a href="#">protection event</a> or sink mode is detected, corresponding trigger-out parameters are triggered. See <a href="#">Figure 6-18</a> .
User button *TRG	<a href="#">User button</a> SCPI command (*TRG) remotely send to instrument	If detected, corresponding trigger-out parameters are triggered. See <a href="#">Figure 6-18</a> .

Table 6-4: Trigger-out signals

Trigger-out parameters	Trigger conditions	Descriptions
Output channel	Output On Output Off Gated	If a trigger is detected, respective channel output of the instrument turns on or off.
Digital Output Fault	CC, CV, CR, Protection and Sink, Output Off	If respective channel <a href="#">operation modes</a> , <a href="#">protection event</a> or sink mode is detected, a trigger signal is sent out at pin 11 of the <a href="#">Digital I/O connector</a> . If "Output Off" is selected, the "fault output" will be active if the output of the selected channel is off. See <a href="#">Figure 6-19</a> .
Digital Output Out1	Trigger-in signal Output On Ch1	If detected, a constant level trigger signal is sent out at pin 4 of the <a href="#">Digital I/O connector</a> . If the pulse option is selected for the signal type, an output pulse of 100 ms trigger signal is sent out instead.
Digital Output Out2	Trigger-in signal Output On Ch2	If detected, a constant level trigger signal is sent out at pin 12 of the <a href="#">Digital I/O connector</a> . If the pulse option is selected, an output pulse of 100 ms trigger signal is sent out instead.
<a href="#">Logging</a>	Trigger-in signal	If detected, the data logger starts recording the instrument.
Arb	Start triggered Stop triggered	If a trigger is detected, respective channel starts generating a complete arbitrary signal or steps through the arbitrary signal for every trigger signal detected.  The step time from the arbitrary signal is ignored in the case when trigger condition is set as "Stop triggered".
<a href="#">FastLog</a>	Trigger-in signal	If detected, the FastLog module is enabled and starts acquiring measurement data.

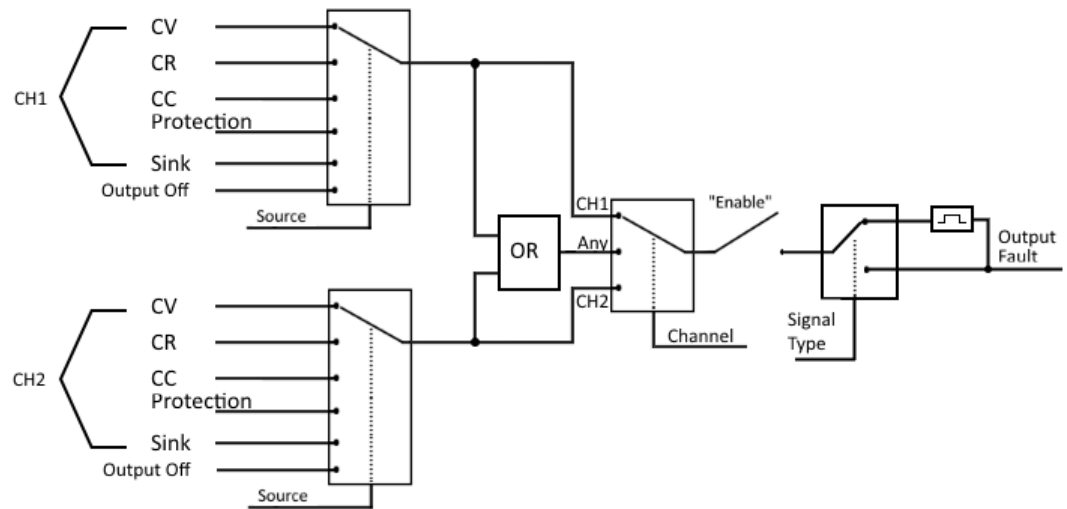

Figure 6-19: Digital output fault signal

### Digital I/O connector

The Digital I/O connector is located below the GPIB connector, see [Chapter 4.2.1.2, "Rear Panel"](#), on page 22.

See [Figure 4-4](#) and [Table 4-2](#) for the Digital I/O connector and pins layout.

1. Press [Settings] key.  
The R&S NGL/NGM displays the device/channel menu window.
2. Select "Trigger" menu item to set the trigger-in parameter.  
The R&S NGL/NGM displays the "Trigger" dialog.

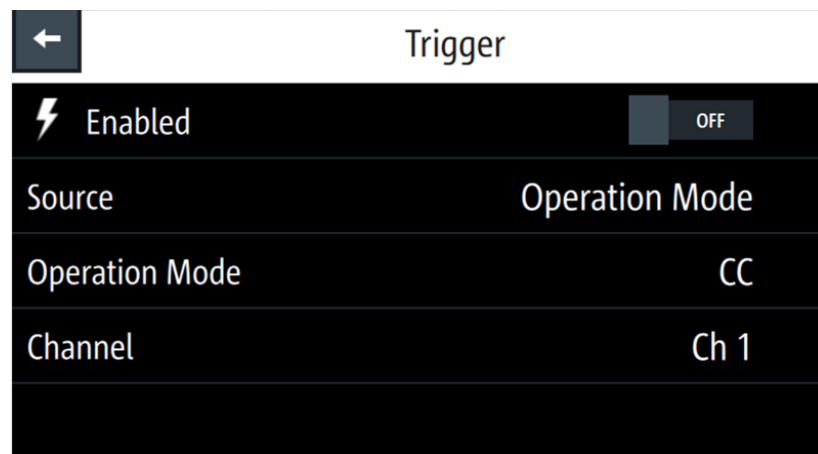



Figure 6-20: An example if Operation Mode is selected as source

3. Select the "Source" to configure the trigger-in parameter.  
See [Figure 6-18](#) for details of the trigger-in parameters.

4. Select "Enable" and set it "On" to enable the trigger-in setting.
5. Select "Back"  to go back to "Device" menu.
6. Select "Digital Output" to configure the trigger-out parameter.  
The R&S NGL/NGM displays the "Digital Output" dialog.

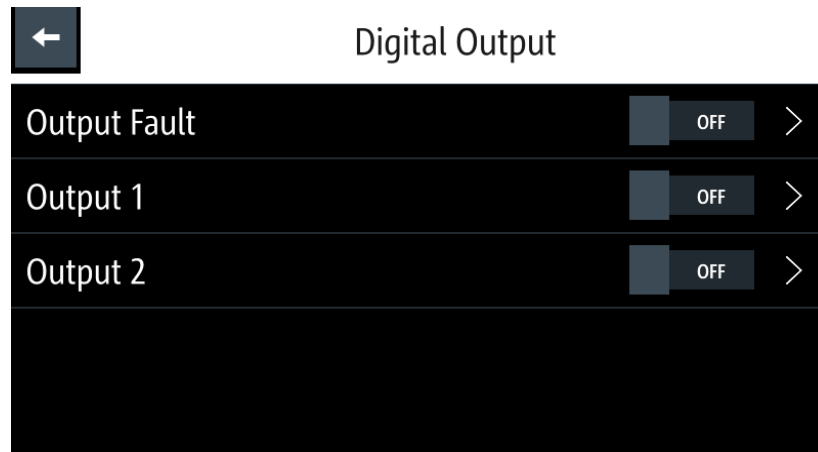



Figure 6-21: Digital Out dialog

7. Depending on your requirements, select the digital output accordingly.  
The two Digital I/O output pins OUT1 and OUT2 can be set directly by the SCPI commands. See [DIO:OUTPut\[:STATe\]](#) on page 158.  
See also [Figure 6-18](#) for details of the trigger-out parameters.
8. Select the respective "Digital Output" menu items and set "On" to enable the trigger-out parameters.
9. Select "Back"  to go back to "Device" menu.
10. If "User Button" is set as a trigger-in signal, select "User Button" menu item.  
The R&S NGL/NGM displays the "User Button" dialog.  
See also [Chapter 6.8, "User Key"](#), on page 71.
11. Select "User Button Action" and set as "Trigger".  
The R&S NGL/NGM generates a trigger-in signal when [user button](#) key is pressed.
12. If "Logging" is set as a trigger-out signal, select "Logging" menu item.  
The R&S NGL/NGM displays the "Logging" dialog.  
See also [Chapter 6.10, "Data Logging"](#), on page 73.
13. Select "Triggered" and set as "On".  
The R&S NGL/NGM starts the data logging of the instrument when a trigger is detected.
14. If "Arbitrary" is set as a trigger-out signal, select "Arbitrary" menu item from the respective channel menu.  
The R&S NGL/NGM displays the "Arbitrary" dialog.  
See also [Chapter 6.7.1, "Arbitrary"](#), on page 67.

15. Depending on your requirement, select "Start triggered" or "Step triggered" menu item and set "On".  
The R&S NGL/NGM starts or steps through the arbitrary signal when a trigger is detected.

## 6.7 Advanced Features



### Arbitrary function

If Arbitrary function of a selected channel is enabled, the respective channel voltage, current setting and safety limit settings are disabled.

See [Chapter 6.1, "Setting the Channels Voltage and Current"](#), on page 44.

The Arbitrary and Ramp are two functions which can be used to control the waveform of voltage and current output.

### 6.7.1 Arbitrary



The Arbitrary function allows you to generate freely programmable waveforms which can be reproduced within the [Safety Limits](#) for voltage and current.

1. Press [Settings] key.  
The R&S NGL/NGM displays the device/channel menu window.
2. Select the required channel tab to configure Arbitrary function.  
The R&S NGL/NGM displays the selected channel menu.
3. Select "Arbitrary" from the menu.  
The R&S NGL/NGM displays the "Arbitrary" dialog.

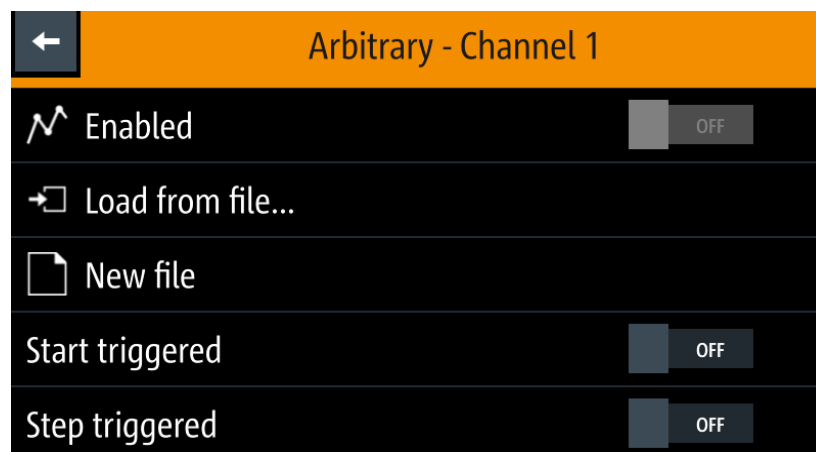

Figure 6-22: Select source and file location

4. Activates the "Enabled" menu item.  
The R&S NGL/NGM enables the Arbitrary function and displays the "Arbitrary" icon on the selected channel status bar information.
5. Select "Load from file.." to load the arbitrary file.
6. Select the required source and file location.  
Alternatively, select "New file" to edit a new arbitrary file. The R&S NGL/NGM opens the [arbitrary editor dialog](#) to edit the arbitrary file.
7. Select "Load" to load the selected file.  
The R&S NGL/NGM loads the selected arbitrary file.



8. Applicable only with R&S NGL-K103 or R&S NGM-K103, Digital Output option.  
See [Chapter 6.6, "Trigger / Digital I/O"](#), on page 62.  
Activate "Start triggered" or "Step triggered" if the arbitrary function is executed under triggered condition.
  - "Start triggered": If triggered, the complete arbitrary function is executed.
  - "Step triggered": If triggered, every arbitrary step needs a trigger signal to execute (step time from "Arb Editor" is ignored).

### Arbitrary editor



#### Interpolation flag

After execution of all repetition cycles, the last interpolation flag is ignored. See [Figure 6-22](#).

The "Arb Editor" dialog allows you to edit the arbitrary profile ("Voltage", "Current", "Time", "Interpolate" status, "Rep." and "End Behavior"). To view or open the list of available arbitrary files, select  to open the arbitrary file.

#	Voltage	Current	Time	Interpolate
1	1.000 V	1.000 0 A	0.001 s	<input checked="" type="checkbox"/>
2	1.588 V	1.000 0 A	0.001 s	<input checked="" type="checkbox"/>
3	1.951 V	1.000 0 A	0.001 s	<input checked="" type="checkbox"/>
4	1.951 V	1.000 0 A	0.001 s	<input checked="" type="checkbox"/>

Figure 6-23: Arbitrary editor dialog

1. Configure the "Arb Editor" with the required voltage, current and duration. The R&S NGL/NGM displays the on-screen keypad for data entry.
2. Confirm values with the unit keys.
3. Select the interpolation checkbox to toggle on/off the interpolation function on the arbitrary data.
4. Select the or icon to add or delete the arbitrary data from the dialog.
  - : A new row of data is added at the end of the table. It is initially filled with the data of the currently selected row.
  - : Removes the currently selected row from the table.
5. Set the "Rep" to configure repetition cycle for the arbitrary data. By default, the repetition cycle is set to infinity.
6. Set the "End Behavior" to handle the way to end the automation of the Arbitrary function.
  - "Off": The output of the selected channel is turned off after performing the Arbitrary function.
  - "Hold": The last voltage and current values remains at the output terminal of the instrument.
7. Select (existing file) or (new file) to save the arbitrary data. The R&S NGL/NGM displays a popup message to show that file saved successfully.

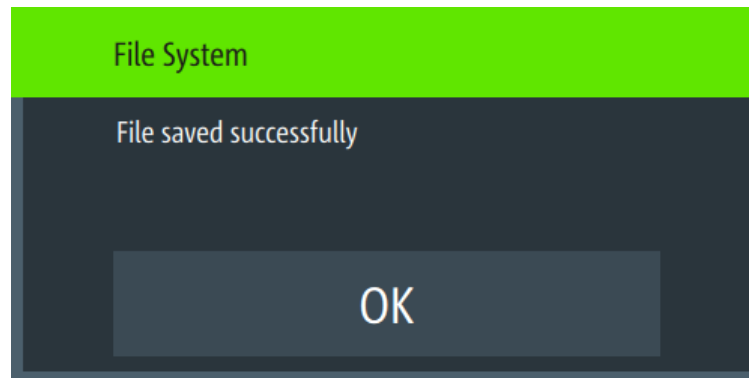

### 6.7.2 Ramp



The Ramp function configures a constant rise of supply voltage within a set time frame. The output voltage can be increased continuously within a 10 ms to 10 s time frame. Each channel has an independent ramp configuration. See [Figure 6-24](#).



#### Internal resistance

The internal resistance control is only applied after the ramp is processed until the configured target value is reached.

See [Chapter 6.2.1, "Set Constant Resistance"](#), on page 46.

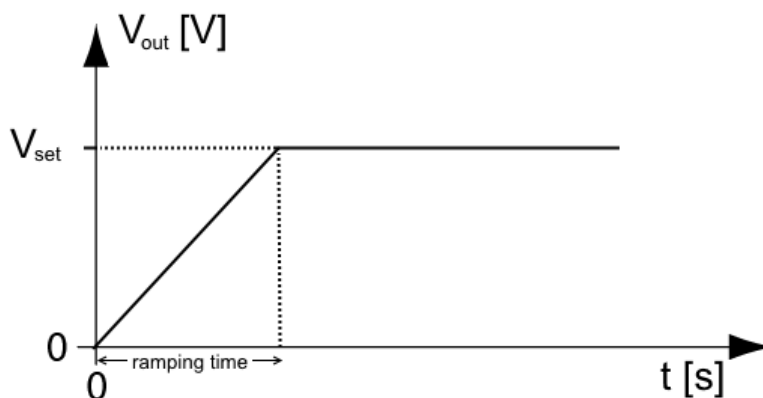

**Figure 6-24: Ramping voltage output**

1. Press [Settings] key.  
The R&S NGL/NGM displays the device/channel menu window.
2. Select the required channel tab to configure Ramp function.  
The R&S NGL/NGM displays the selected channel menu.
3. Select "Ramp" from the menu.  
The R&S NGL/NGM displays the "Ramp" dialog.



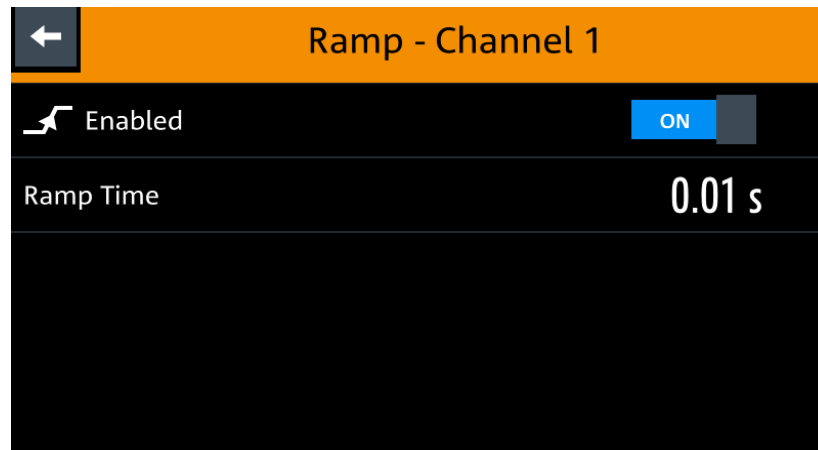

Figure 6-25: Ramp dialog

4. Activate the "Enabled" menu item.  
The R&S NGL/NGM enables the Ramp function and displays the "Ramp" icon on the selected channel status bar information.
5. Set the required "Ramp Time".  
The R&S NGL/NGM displays the on-screen keypad to set the value.
6. Confirm value with the unit key.

## 6.8 User Key



The R&S NGL/NGM allows you to configure the user action for one of the following functions:

- Screenshot image from instrument
  - Instrument trigger function
  - Data logging
  - Reset statistic (see index 1, 2, 3 of [Figure 5-6](#))
  - Enable/Disable touchscreen function
1. Press [Settings] key.  
The R&S NGL/NGM displays the device/channel menu window.
  2. Select the "Device" menu tab to configure user action.  
The R&S NGL/NGM displays the device menu.
  3. Select "User Button" from the menu.  
Alternatively, long-press on the [\*] key to configure the user button action.  
The R&S NGL/NGM displays the "User Button" dialog.

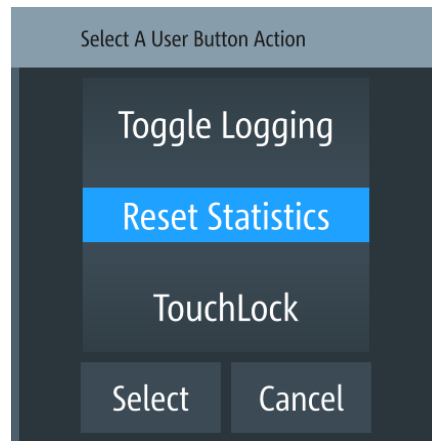

**Figure 6-26: User button action**

4. Select the "User Button Action" to configure the user action.  
The R&S NGL/NGM displays a dialog to configure the user action.
5. Select the required user action.
  - "Screenshot": Capture the current screen image of the instrument
  - "Trigger": User key is used to activate the instrument trigger function
  - "Toggle Logging": Enable/Disable the data logger function
  - "Reset Statistics": Reset sample count, energy result, power, voltage and current values
  - "TouchLock": Enable/Disable the touchscreen function of the instrument
6. Select "Select" to confirm the action.

## 6.9 Screenshot



With screenshot, you can capture image easily from the instrument. The images can be stored in the USB stick or internal memory of the instrument. By default, the screen images are stored in the USB device under the target folder.

1. Press [Settings] key.  
The R&S NGL/NGM displays the device/channel menu window.
2. Select the "Device" tab to configure screenshot file location.  
The R&S NGL/NGM displays the device menu.
3. Select "Screenshot" from the menu.  
The R&S NGL/NGM displays the "Screenshot" dialog.

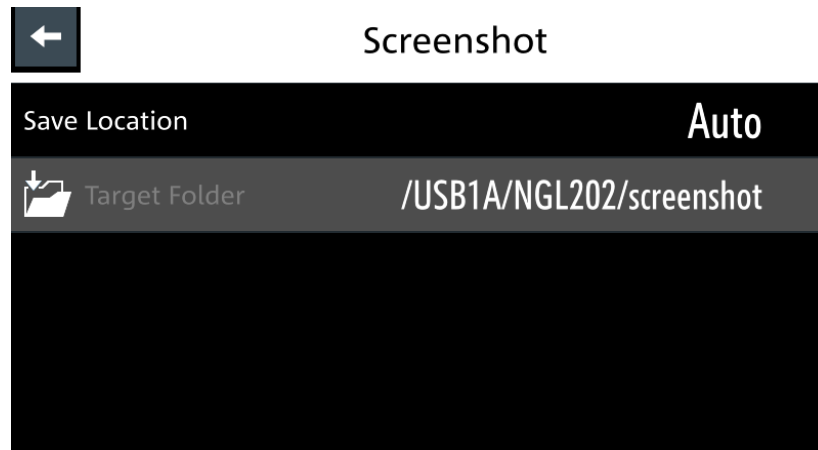

Figure 6-27: Screenshot dialog

4. Select the "Save Location" to configure the screenshot file location.
  - "Auto": Target folder is set to default file location:
    - With USB stick detected:
      - /USB1A/NGL202/screenshot for NGL model
      - /USB1A/NGM202/screenshot for NGM model
    - Without USB stick detected:
      - /int/screenshot
  - "Manual": Choice of target folder.
5. Select the required save location.

## 6.10 Data Logging



When data logging is activated, the R&S NGL/NGM records the voltage, current and power data and stores it in the predefined target folder. The measurement data can be stored on the USB stick or in the instrument internal memory location.

1. Press [Settings] key.  
The R&S NGL/NGM displays the device/channel menu window.
2. Select the "Device" tab to configure data logger.  
The R&S NGL/NGM displays the device menu.
3. Select "Logging" menu item from the menu.  
The R&S NGL/NGM displays the "Logging" dialog.

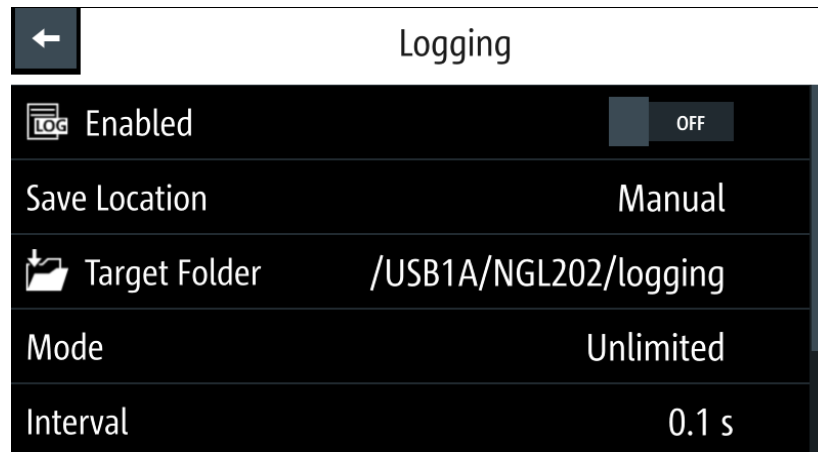

4. Select the "Save Location" menu item to select the predefined target folder for data logger.
  - "Auto": "Target Folder" is auto-selected.  
If no USB stick is detected, "Target Folder" is set to internal memory ("int") partition. By default, "USB1A" partition is selected.
  - "Manual": Choice of "Target Folder".  
Selection is possible only if USB stick is detected.

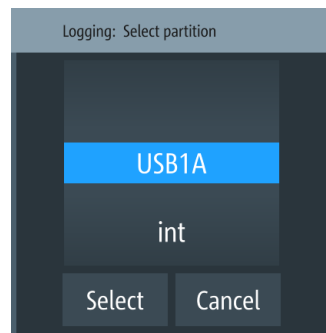

**Figure 6-28: Target folder dialog**

5. Set the required "Target Folder".
6. Select "Mode" to set logging duration.
  - "Duration": Time taken for data logging with duration and time interval setting.
  - "Span": Time taken for data logging with start time, time interval and duration setting
  - "Unlimited": Data logging with time interval setting. The data logging continuous until function is deactivated.
  - "Count": Data logging with number of counts and time interval setting
7. Depending on the selected mode, configure the required settings for the data logging duration.
8. Activate the "Enabled" menu item.

The R&S NGL/NGM activates the logging and disables the settings for file saved location and logging mode settings.

9. Applicable only with R&S NGL-K103, activate the "Triggered" menu item if data logging is required under triggered conditions.  
If activated, the R&S NGL/NGM executes the data logging if a trigger event occurs. See [Figure 6-18](#) and [Figure 6-26](#).
10. Configure the "CSV Settings".  
See [Chapter 6.12, "CSV Settings"](#), on page 76.

## 6.11 FastLog



Available only with the NGM models.

A USB stick with a minimum of 10MB/s continuous write speed is recommended for data storage.

The FastLog can write the measurement data (voltage/current) either to the USB device or to a SCPI client. In SCPI mode the client is required to be connected to the R&S NGM before "FastLog" is enabled

"FastLog" is a much faster data logging for voltage and current measurements. This fast logging features the benefit to capture short peak changes in voltage and/or current measurements which is particularly useful in the measuring of low energy device, e.g. IoT products.

Refer to the data specification for the maximum data logging and resolution for NGM models.

1. Press [Settings] key.  
The R&S NGM displays the device/channel menu window.
2. Select the required channel tab to configure "FastLog" function.  
The R&S NGM displays the selected channel menu.
3. Select "FastLog" menu item from the menu.  
The R&S NGM displays the "FastLog" dialog.

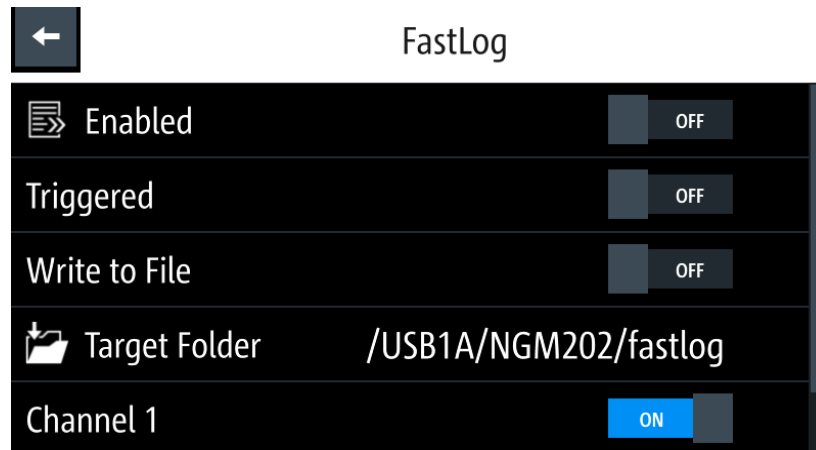

4. Select "Enabled" to activate the "FastLog" function.  
The R&S NGM starts the fast logging and displays the "Fast Logging" icon at the device status bar information.
5. Select "Triggered" to "ON" if you want "FastLog" to be enabled by a trigger event.
6. Select "Write to USB" if you want to save the measurements data to a binary file. The file is saved to the directory specified in the "Target Folder". The R&S NGM creates a file for each channel and logs the measurement data to the binary file.
7. Select "Write to SCPI" to transfer the data to a SCPI client.  
Note: It is possible to select a sample rate of 500 kS/s on both channels at the same time.  
If "FastLog" on one channel is activated at 500 kS/s, the other channel is blocked. If both channels are to be activated by a trigger, it is checked whether the sum of the sample rates > 500 kS/s. If this is the case, the operation is aborted with an error message and none of the channels are switched on.

## 6.12 CSV Settings



A CSV file stores tabular data (numbers and text) in plain text. Each line of the file is a data record and each record consists of one or more fields, separated by a file delimiter. The "CSV Settings" provides you ways to format the fields that are stored in the data logging. See [Figure 6-29](#).

#Device	NGM202						
#Calibration Ch1	factory						
#Calibration Ch2	factory						
Timestamp	U1[V]	I1[A]	P1[W]	U2[V]	I2[A]	P2[W]	
52:53.2	1.00E+00	-7.23E-05	-7.23E-05	1.00E+00	-3.58E-05	-3.58E-05	
52:53.3	1.00E+00	-7.55E-05	-7.55E-05	1.00E+00	-2.88E-05	-2.88E-05	
52:53.4	1.00E+00	-7.42E-05	-7.42E-05	1.00E+00	-2.62E-05	-2.62E-05	
52:53.5	1.00E+00	-7.42E-05	-7.42E-05	1.00E+00	-2.88E-05	-2.88E-05	
52:53.6	1.00E+00	-7.23E-05	-7.23E-05	1.00E+00	-2.05E-05	-2.05E-05	
52:53.7	1.00E+00	-6.46E-05	-6.46E-05	1.00E+00	-2.94E-05	-2.94E-05	
52:53.8	1.00E+00	-7.10E-05	-7.10E-05	1.00E+00	-3.46E-05	-3.46E-05	
52:53.9	1.00E+00	-7.55E-05	-7.55E-05	1.00E+00	-3.71E-05	-3.71E-05	
52:54.0	1.00E+00	-8.06E-05	-8.06E-05	1.00E+00	-3.20E-05	-3.20E-05	
52:54.1	1.00E+00	-6.98E-05	-6.97E-05	1.00E+00	-2.94E-05	-2.94E-05	
52:54.2	1.00E+00	-6.85E-05	-6.85E-05	1.00E+00	-3.46E-05	-3.46E-05	
52:54.3	1.00E+00	-6.14E-05	-6.14E-05	1.00E+00	-3.58E-05	-3.58E-05	
52:54.4	1.00E+00	-6.27E-05	-6.27E-05	1.00E+00	-3.07E-05	-3.07E-05	
52:54.5	1.00E+00	-7.68E-05	-7.68E-05	1.00E+00	-2.94E-05	-2.94E-05	
52:54.6	1.00E+00	-7.94E-05	-7.93E-05	1.00E+00	-2.88E-05	-2.88E-05	
52:54.7	1.00E+00	-7.30E-05	-7.29E-05	1.00E+00	-3.33E-05	-3.33E-05	
52:54.8	1.00E+00	-6.98E-05	-6.97E-05	1.00E+00	-2.75E-05	-2.75E-05	
52:54.9	1.00E+00	-7.30E-05	-7.29E-05	1.00E+00	-2.50E-05	-2.50E-05	
52:55.0	1.00E+00	-7.23E-05	-7.23E-05	1.00E+00	-3.90E-05	-3.90E-05	

Figure 6-29: Sample of data logging

- Select "CSV Settings" from "Device" menu.  
The R&S NGL/NGM displays the "CSV Settings" dialog.

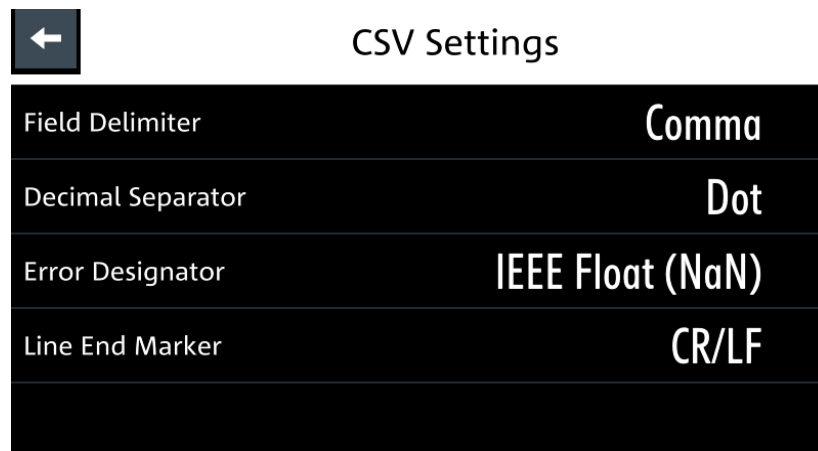

Figure 6-30: CSV settings dialog

- Set the required CSV parameters.  
The R&S NGL/NGM displays the respective dialog to set the CSV parameters.  
See [Table 6-5](#).
- Select "Set" to confirm the value.

Table 6-5: CSV settings

CSV settings	Selective fields in the dialog
"Field Delimiter"	"Comma", "Semicolon"
"Decimal Separator"	"Dot", "Comma"

CSV settings	Selective fields in the dialog
"Error Designator"	"IEE Float (NaN)", "Empty"
"Line End Marker"	"CR/LF", "LF"

## 6.13 Graphical View Window



The graphical view measurement is a time-based measurement that allows you to visualize measurements on available data sources.

The graph illustrated below shows the output of voltage "U1" 0.9 V, current "I1" 90 mA at channel 1 with output power of "P1" 81 mW from 39 seconds ago. Each measurement trace is represented with an individual color.

The time-based scale is fixed with a time duration display up to the last 60 seconds.

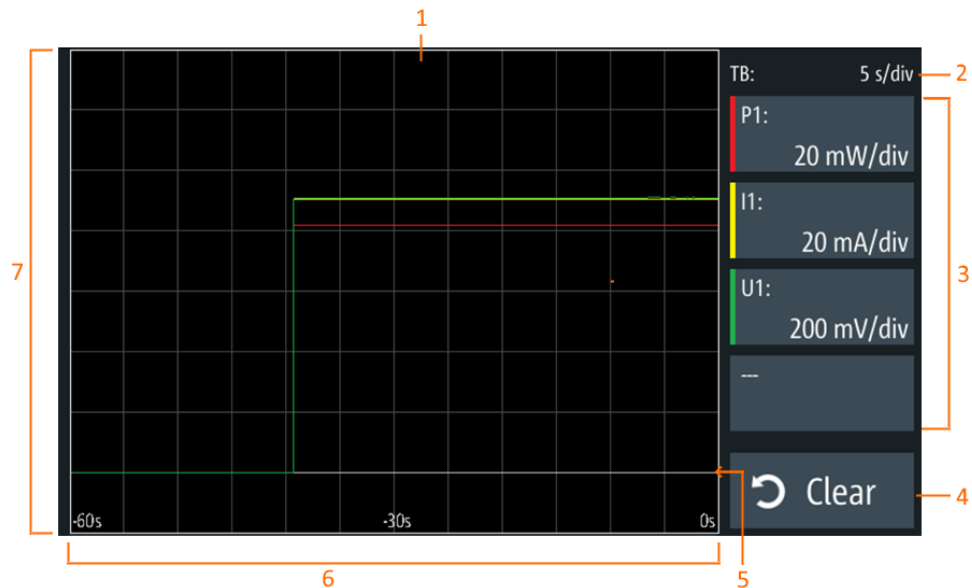

**Figure 6-31: Graphical view window**

- 1 = Display window for measurement
- 2 = Time axis scale fixed at 5 s/div
- 3 = Configuration slot for measurement
- 4 = Reset measurements in display window
- 5 = Zero-origin of the graph
- 6 = Time axis
- 7 = Measurement axis

1. Long-press on the [Settings] key or the "Settings" button in [Chapter 5.1.2, "Channel Display Area"](#), on page 32.  
The R&S NGL/NGM displays the graphical view window. See [Figure 6-31](#).
2. Alternatively, press [Settings] > device menu > "Graphical View" to access graphical view window.



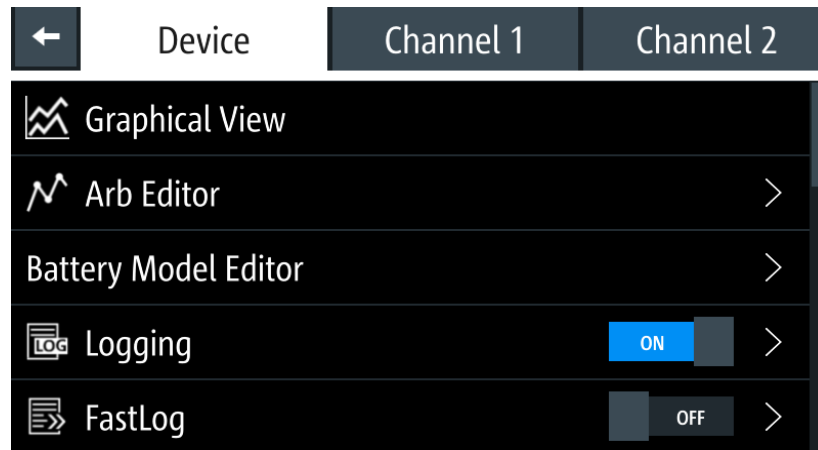
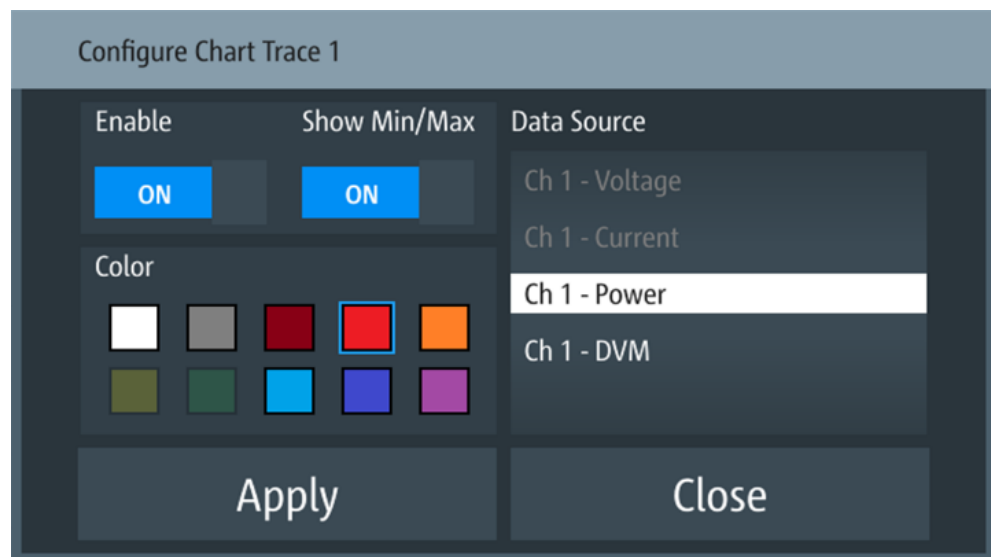
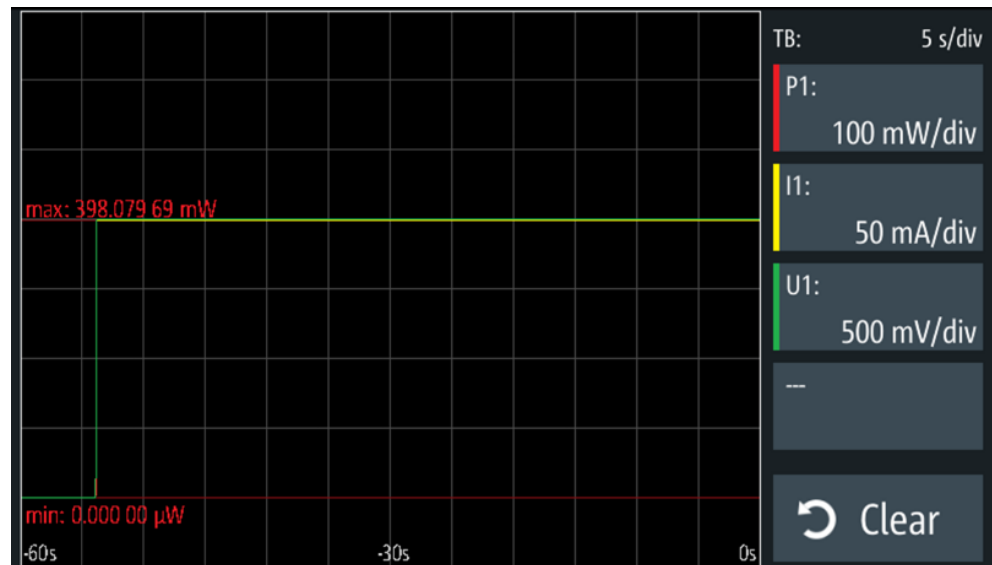

Figure 6-32: Device menu

3. Select any of the configuration slots to configure the measurement parameters.  
Note: For NGM models only, the DVM measurement must be enabled in the respective channels for the measurement to be available in the configuration dialog.  
The R&S NGL/NGM displays the configuration dialog.



4. Select the available "Data Source" for configuration.  
The dimmed "Data Source" is in use and is not configurable.
5. Set "Enable" to activate the selected "Data Source" for measurement.
6. Select the available "Color" to configure the "Data Source" measurement trace.
7. Set "Show Min/Max" to "ON" to display the minimum and maximum value of the selected "Data Source".



8. Select "Apply" to confirm the configuration.
9. Select "Close" to exit configuration dialog.

## 6.14 File Manager



The "File Manager" provides file transfer functions between USB stick and internal memory of the instrument. You can copy and delete files in both USB stick and internal memory of the instrument.

1. Press [Settings] key.  
The R&S NGL/NGM displays the device/channel menu window.
2. Select the "Device" tab to configure file settings for store and recall function.  
The R&S NGL/NGM displays the device menu.
3. Select "File Manager" from the menu.  
The R&S NGL/NGM displays the file manager dialog.

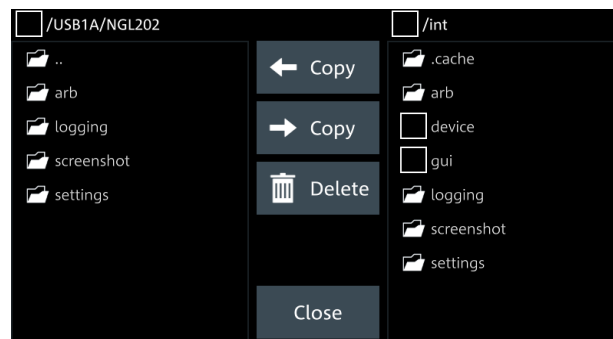

Figure 6-33: File manager dialog

4. Select the file that you want to copy or delete.
5. Select the required action in the file manager dialog.  
See [Table 6-6](#).
6. To view the selected file information, long-press on the selected filename in the file manager dialog.  
A pop-up message box is displayed with the file information.

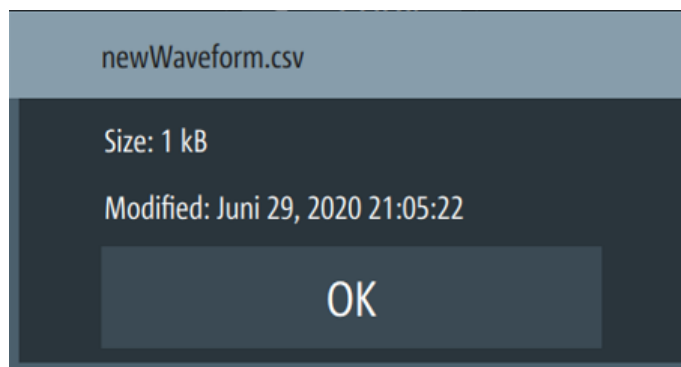

Figure 6-34: File information

Table 6-6: File manager action

Action	Description
	Copy from internal memory to USB.
	Copy from USB to internal memory.
	Delete the selected file.

## 6.15 Store and Recall



Upon power-up, the instrument loads the last stored settings from internal memory location. Auto saved parameters are also applied during startup.

The R&S NGL/NGM output states of all channels (Ch1, Ch2) are disabled when the recall function is activated.



### Auto saved instrument settings

Auto saved of the instrument settings is applied when any of the following parameters are changed:

- [Chapter 6.17, "General Instrument Settings"](#), on page 90
- USB connection mode
- Ethernet settings



In addition of the auto saved instrument settings, the following instrument settings are stored or recalled in the internal memory:

- [Set voltage and current level](#)
- [Settings in the Protection Function, Safety Limits](#)
- [Arbitrary settings, Ramp settings](#)
- [User button key function](#)
- [Data Logging settings](#)
- [GPIB Address](#)

1. Press [Settings] key.  
The R&S NGL/NGM displays the device/channel menu window.
2. Select the "Device" tab to configure file settings for store and recall function.  
The R&S NGL/NGM displays the device menu.
3. Select "Save/Recall Device Settings".  
The R&S NGL/NGM loads the "Save/Recall Device Settings" dialog.

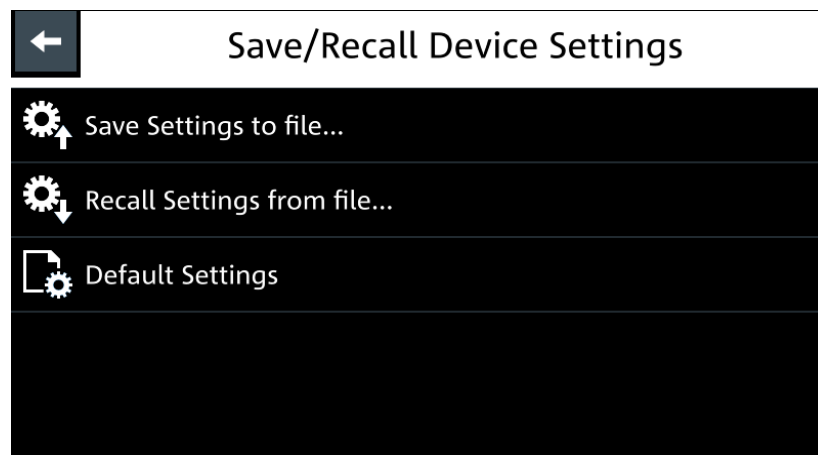

*Figure 6-35: Save/Recall device settings dialog*

4. Select "Save Settings to file..." to save current instrument settings.  
The R&S NGL/NGM opens a dialog to select source and file location.  
You can save to existing file or create a file for saving.
5. Set the source and file location.  
The R&S NGL/NGM saves the current instrument settings.
6. Similar, you can select "Recall Settings from file..." to load instrument settings.  
The R&S NGL/NGM opens a dialog to select source and file location.
7. Set the source and file location.  
The R&S NGL/NGM resets the instrument with the loaded instrument settings.

To reset the instrument settings to factory default:

1. Select "Default Settings" from the "Save/Recall Device Settings" dialog.

The R&S NGL/NGM displays a popup message.

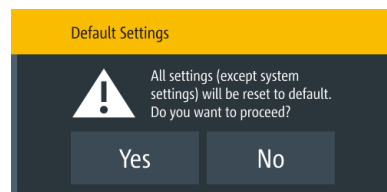

2. Select "Yes" to overwrite instrument settings to factory default.  
The R&S NGL/NGM resets current instrument settings to factory default.
3. The R&S NGL/NGM displays a popup message to show that all settings are reset to factory default.

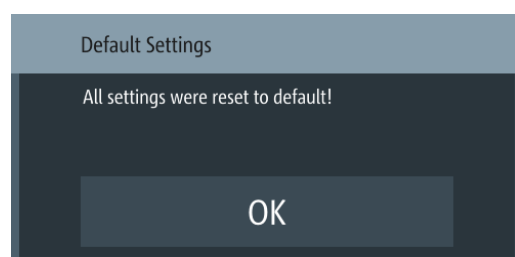

## 6.16 Interfaces

There are various of ways how the R&S NGL/NGM can be remotely accessed and controlled.

1. Press [Settings] key.  
The R&S NGL/NGM displays the device/channel menu window.
2. Select the "Device" tab to configure network connection.  
The R&S NGL/NGM displays the device menu.
3. Select "Interfaces".  
The R&S NGL/NGM displays the "Interfaces" dialog.

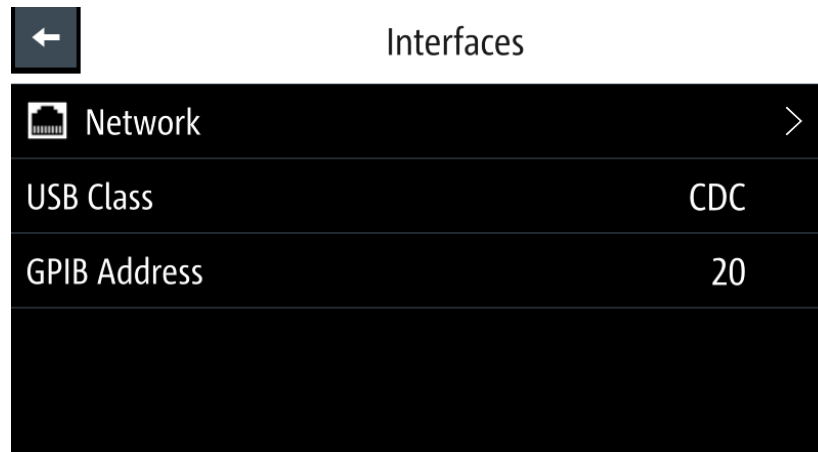

Figure 6-36: Interfaces dialog

4. Select the connected interface ([Network](#), [USB Class](#) or [GPIB Address](#)) to configure the necessary parameters required.
  - [Network Connection](#).....84
  - [USB Connection](#).....88
  - [GPIB Address](#)..... 89

### 6.16.1 Network Connection



There are two methods to establish a local area network (LAN) connection with the R&S NGL/NGM for remote control operation.

- [LAN](#)
- [Wireless LAN](#)

1. Select "Network" from the [Figure 6-36](#).  
The R&S NGL/NGM displays the "Network" dialog.

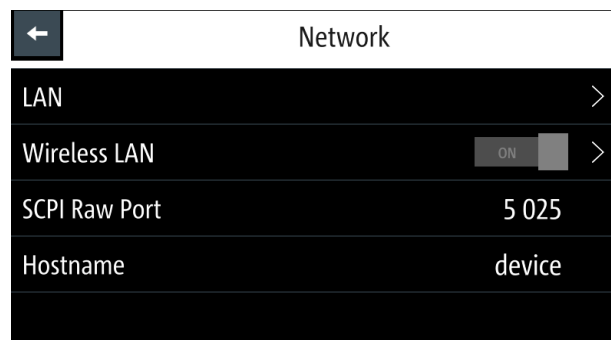

Figure 6-37: Network dialog

2. Set the required "SCPI Raw Port" and "Hostname".

The R&S NGL/NGM displays the on-screen keypad to enter the port number and hostname.

- "SCPI Raw Port": A port number used to open a raw TCP/IP connection to send raw SCPI commands to the instrument
- "Hostname": The name assigned to the instrument used to identify it in the network

When the connection is available, the network icon is highlighted in white on the device status bar information.

#### 6.16.1.1 LAN Connection

The R&S NGL/NGM is equipped with a network interface and can be connected to an Ethernet LAN (local area network). A LAN connection is necessary for remote control of the instrument, and for access from a computer using a web browser.

---

### NOTICE

#### Risk of network failure

Before connecting the instrument to the network or configuring the network, consult your network administrator. Errors may affect the entire network.

---



To establish a network connection, connect a commercial RJ-45 cable to the LAN port of the instrument and to a PC or network switch.

Depending on the network capacities, the TCP/IP address information for the instrument can be obtained in different ways.

- If the network supports dynamic TCP/IP configuration using the Dynamic Host Configuration Protocol (DHCP), and a DHCP server is available, all address information can be assigned automatically.
- Otherwise, the address must be set manually. Automatic Private IP Addressing (APIPA) is not supported.

By default, the instrument is configured to use dynamic TCP/IP configuration and obtain all address information automatically. This means that it is safe to establish a physical connection to the LAN without any previous instrument configuration.

---

### NOTICE

#### Risk of network errors

Connection errors can affect the entire network. If your network does not support DHCP, or if you choose to disable dynamic TCP/IP configuration, you must assign valid address information before connecting the instrument to the LAN. Contact your network administrator to obtain a valid IP address.

---

1. Connect the LAN cable to the LAN connector at the rear panel of the instrument.
2. Select "LAN" to set LAN connection.  
The R&S NGL/NGM displays the "LAN" dialog.  
Note: The "MAC Address" is fixed.

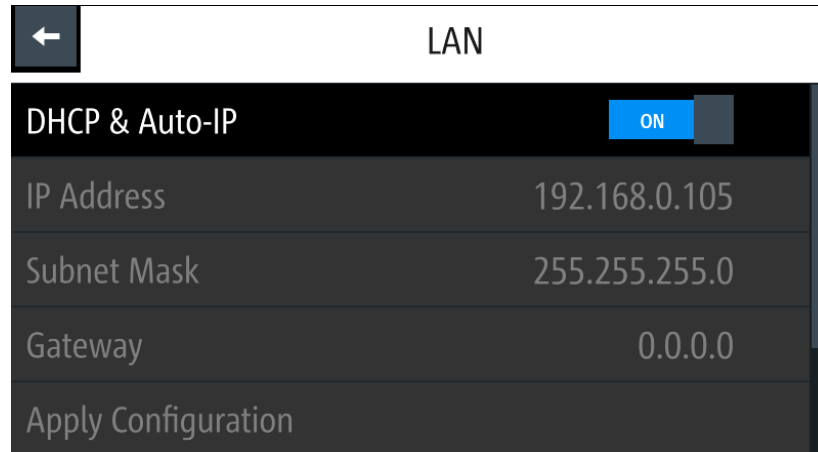

Figure 6-38: Ethernet settings dialog

3. Set the "DHCP & Auto-IP".
  - "ON": Enables DHCP for automatic network parameter distribution and shows the values of the IP Address. By default, the instrument is configured to use dynamic configuration and obtain all address information automatically.
  - "OFF": If the network does not support dynamic host configuration protocol (DHCP). The addresses must be set manually.
4. Set the required DHCP mode.  
If DHCP mode is set "OFF", the following "Ethernet Settings" are required.
5. Configure the "IP Address", "Subnet Mask" and "Gateway".  
The R&S NGL/NGM displays the IP dialog for configuration.

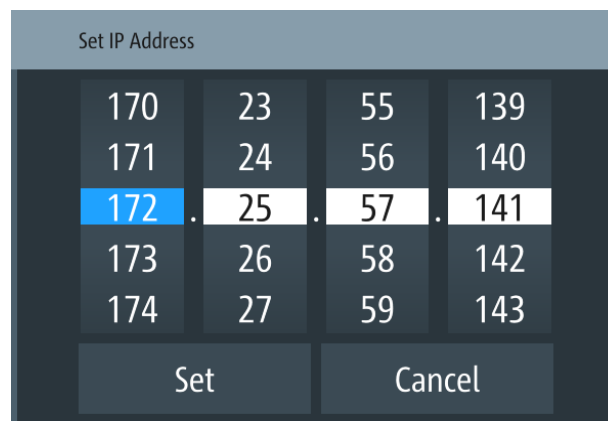

Figure 6-39: IP dialog

6. Set the required IP addresses for "IP Address", "Subnet Mask" and "Gateway"



7. Select "Set" to confirm the value.
8. Select "Apply Configuration" to apply the changes.

### 6.16.1.2 Wireless LAN Connection

#### **WARNING**

##### **Risk of RF exposure**

When WLAN is active, a minimum separation distance of 20 cm from front panel of the instrument must be observed at all times.

When WLAN is active, no operation of antenna or transmitter should be co-located with the instrument.



##### **Wi-Fi transmitter performance**

Frequency range: 2412 MHz to 2472 MHz

Power: 19.5 dBm typical



##### **Instrument option**

R&S NGL-K102 (P/N: 3652.6362.02) or R&S NGM-K102 (P/N: 3644.6367.02) option is required to connect the R&S NGL/NGM to a network via wireless LAN connection.

An alternative to connection in local area network is wireless LAN connection. With the presence of an authenticated Wi-Fi signal, the R&S NGL/NGM automatically connects to a network and navigation can be made via the web browser according to the WLAN IEEE 802.11 b/g/n standards.

1. Select "Wireless LAN" to set LAN connection.  
The R&S NGL/NGM displays the "Wireless LAN Settings" dialog.

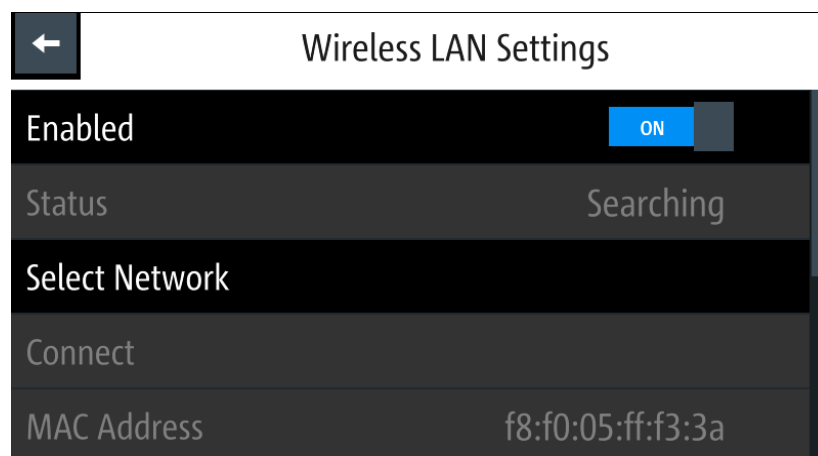
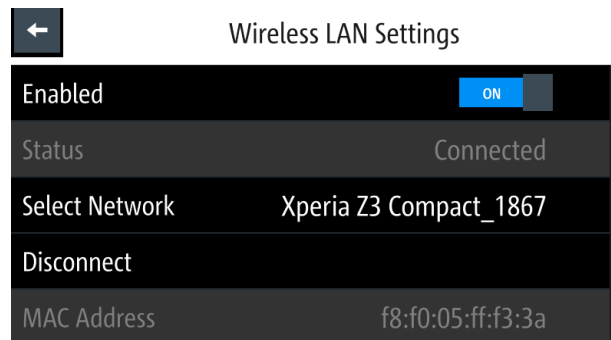

Figure 6-40: WLAN settings dialog

2. Select "Enable" menu item to set "On" to enable wireless LAN.  
The R&S NGL/NGM began searching available WiFi network and the "Status" shows "Searching".
3. Select the "Select Network" to connect the required WiFi network.  
If connection is successful, the "Status" shows "Connected". See [Figure 6-41](#).  
When the connection is alive, the WLAN icon turns white on the device status bar.  
See ["Device status bar"](#) on page 30.



*Figure 6-41: WLAN connected*

4. To disconnect, select the Disconnect in the "Wireless LAN settings" dialog.

## 6.16.2 USB Connection



### Change of USB class

If a change in "USB Class" is detected (i.e. from "TMC" to "CDC" or vice versa), the rebooting of instrument is necessary to load the correct USB driver.

- A popup message is displayed: "A reboot of the device is required for this setting to take effect."

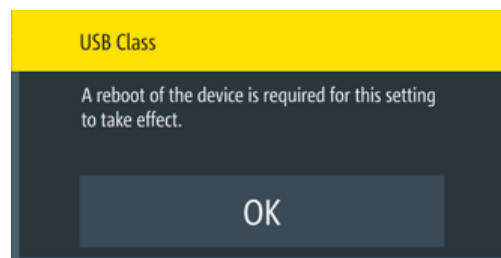

Alternatively, connect a USB cable to the USB port (see [Figure 4-2](#)) and PC for a USB connection. The R&S NGL/NGM supports USB CDC and USB TMC connection.

1. Select "USB Class" from the "Network Connections" dialog.  
The R&S NGL/NGM displays the USB class dialog to select the USB connection.

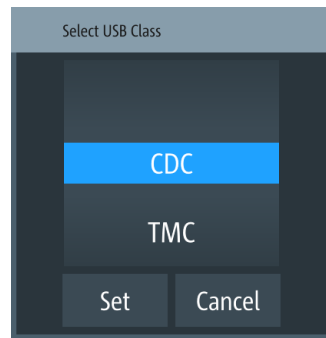

Figure 6-42: USB dialog

2. Set the USB class.
3. Select "Set" to confirm the selection.

### 6.16.3 GPIB Address



#### Instrument option

R&S NGL-B105 (P/N: 3652.6356.02) or R&S NGM-B105 (P/N: 3641.6220.02) option needs to be installed for the remote command of R&S NGL/NGM via GPIB interface.

The GPIB interface, sometimes called the General Purpose Interface Bus (GPIB), is a general purpose digital interface system that can be used to transfer data between two or more devices. Some of its key features are:

- Up to 15 instruments can be connected
- The total cable length is restricted to a maximum of 15 m; the cable length between two instruments should not exceed 2m
- A wired "OR"-connection is used if several instruments are connected in parallel

To be able to control the instrument via the GPIB bus, the instrument and the controller must be linked by a GPIB bus cable. A GPIB bus card, the card drivers and the program libraries for the programming language must be provided in the controller. The controller must address the instrument with the GPIB instrument address.

#### GPIB instrument address

To operate the instrument via remote control, it must be addressed using the GPIB address. The default remote control address is factory-set at 20, the addresses of 0 through 30 are allowed.

The GPIB address is maintained after a reset of the instrument settings.

1. Select "GPIB Address" from the [Figure 6-36](#).  
The R&S NGL/NGM displays an on-screen keypad to set the value.



2. Enter the required value.
3. Confirm value with the enter key .

## 6.17 General Instrument Settings

The following chapters provide the general instrument information and utilities services in "Device" menu.

1. Press [Settings] key.  
The R&S NGL/NGM displays the device/channel menu window.
2. Select the "Device" tab.  
The R&S NGL/NGM displays the device menu.

### 6.17.1 Licenses Management

Options are enabled by entering a registered license key code.

You may choose to install from an XML file on USB or by manually entering the key code.

- ▶ Select "Licenses" to install license key code.  
The R&S NGL/NGM displays the license dialog.
  - "Active": Options that are currently active in the instrument
  - "Inactive": Options that are currently not active in the instrument
  - "Deactivation": Options that are expired or removed in the instrument

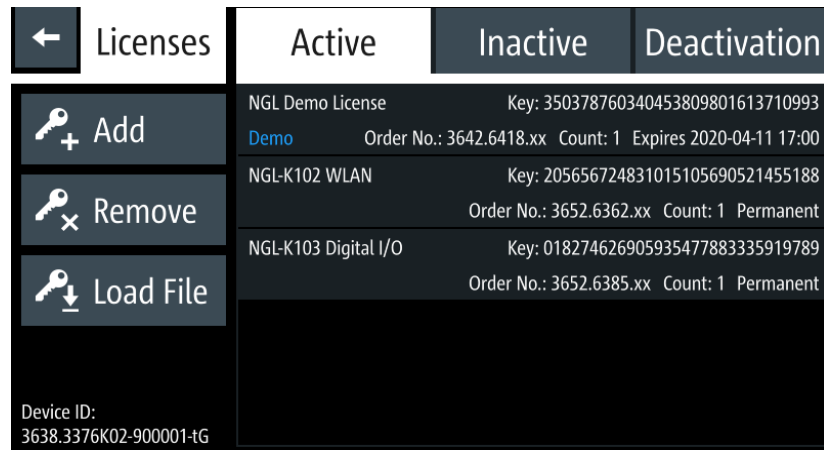

Figure 6-43: License dialog

**To install an XML file, proceed as follows:**

1. Copy the XML file containing the registered key code into the USB flash drive.
2. Connect the USB flash drive to the USB port of the instrument.
3. Select "Load File" to load the license file from the USB stick.
4. Select the license file to install in the instrument.  
The R&S NGL/NGM install the license option accordingly.  
If the installation is successful, the option is displayed in the "Active" window.

**To manually enter the key code, proceed as follows:**

1. Select "Add" key to invoke the license key on-screen keyboard.

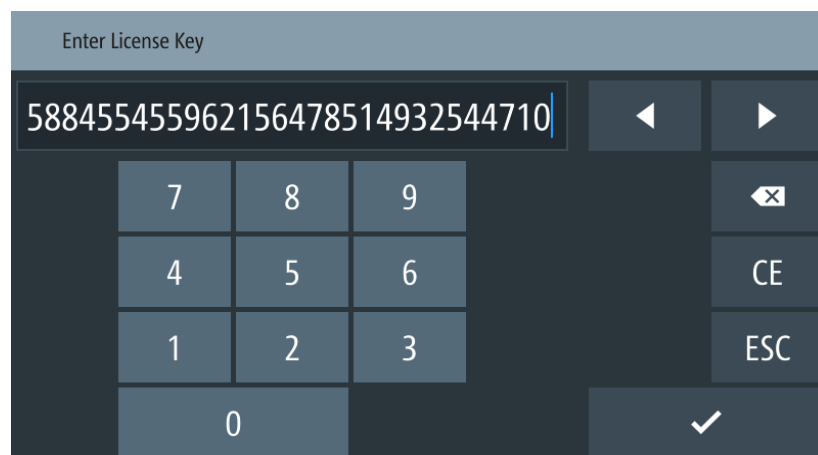



Figure 6-44: License key on-screen keyboard

2. Enter the key code (30-digit number) of the option in the entry box.
3. Confirm entries with the enter key .

If the correct key code is entered, the R&S NGL/NGM popup a message "Device-key is installed" and the option is displayed in the "Active" window.

4. To remove the option, select "Remove" from the license dialog.  
The R&S NGL/NGM displays the license key on-screen keyboard. See [Figure 6-44](#).
5. Enter the key code (30-digit number) of the option in the entry box.
6. Confirm entries with the enter key .  
If the correct key code is entered, the R&S NGL/NGM popup a message "Device-key is removed" and the option is displayed in the "Deactivation" window.

### 6.17.2 Appearance Settings



- ▶ Select the "Appearance" to set display and key brightness.  
The R&S NGL/NGM displays the appearance dialog.



Figure 6-45: Appearance dialog

### 6.17.3 Sound Settings



1. Select the "Sound Settings" to set sound settings.  
The R&S NGL/NGM displays the sound settings dialog.

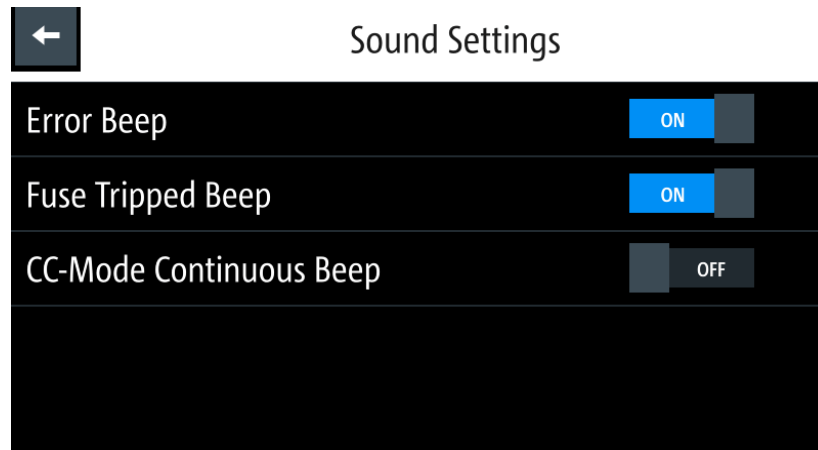

Figure 6-46: Sound settings dialog

2. Select the required fields to set alert.
  - "Error Beep": A single beep alert when error occurs.
  - "Fuse Tripped Beep": A single beep alert when a fuse tripped occurs. See [Chapter 6.5, "Protection"](#), on page 58.
  - "CC-Mode Continuous Beep": A continuous beep sound alert when the selected output channel goes into CC mode. See ["CC mode"](#) on page 42.

#### 6.17.4 Date and Time



The time is regarded as UTC. There is no timezone selectable.



1. Select the "Date & Time" to set date and time format. The R&S NGL/NGM displays the date and time dialog.

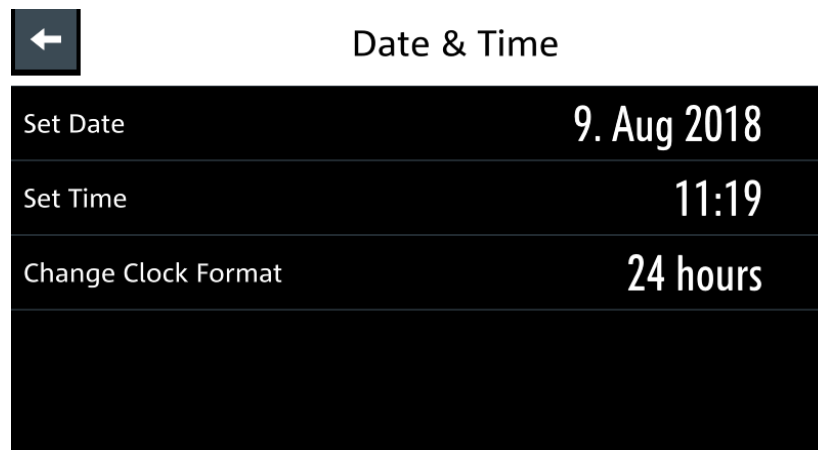

Figure 6-47: Date and time setting dialog

2. Select the required field to configure.  
The R&S NGL/NGM reset the instrument date and time accordingly.

### 6.17.5 Device Information



General instrument information of R&S NGL/NGM.

- ▶ Select the "Instrument Information" to display the device information.  
The R&S NGL/NGM displays the device information dialog.

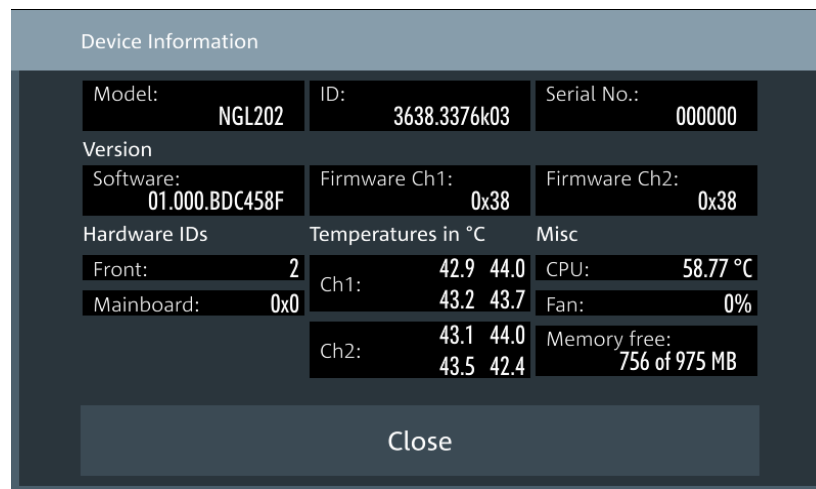

Figure 6-48: Device information dialog

Device information	Description
Model	Model of the instrument.
ID	Instrument orderable part number.
Serial No.	Unique identification number for the instrument.
Version	Software version that is installed in the instrument.
Hardware IDs	Unique serial number of the front and mainboard of the instrument.
Temperatures	Temperature in degrees measured in both Ch1 and Ch2. If the temperature exceeded the specification, "Over Temperature Protection" (OTP) is triggered and the respective output channel is turned off.
Misc	Temperature measures for CPU. Fan speed and memory capacity in the instrument.

### 6.17.6 Update Device





Latest instrument firmware is available in the R&S NGL/NGM product homepage.

1. Select the "Update Device" to update instrument firmware.  
The R&S NGL/NGM displays the update device dialog.

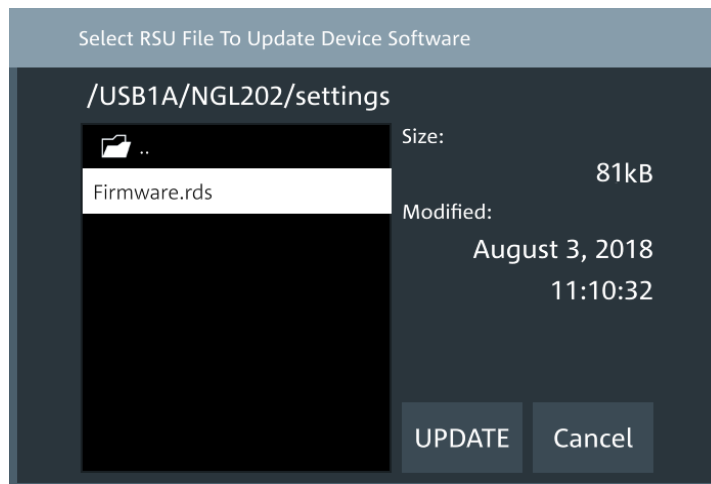

*Figure 6-49: Update device dialog*

2. Select the source and file location to update instrument firmware.
3. Select "UPDATE" to update the instrument firmware.  
The R&S NGL/NGM updates the instrument firmware accordingly.

## 6.18 Device Documentation

You can retrieve the R&S NGL/NGM Open Source Acknowledgment documentation from the instrument documentation folder `/int/documentation`.

1. Go to "File Manager" menu.  
The R&S NGL/NGM displays the file manager dialog.  
For more information, see [Chapter 6.14, "File Manager"](#), on page 80.
2. Select the documentation folder in the file manager dialog.  
The R&S NGL/NGM displays the available files in the documentation folder.
3. Select the file you want to copy from the documentation folder.

## 7 Remote Control Commands

This chapter provides the description of all remote commands available for the R&S NGL/NGM series. The commands are sorted according to the menu structure of the instrument. A list of commands in alphabetical order is given in the "List of Command"s at the end of this documentation.

For more information on [Messages and Command Structure](#), [Messages and Command Structure](#) and [Structure of a SCPI Status Register](#), see the "Annex" at the end of this documentation.

### 7.1 Common Setting Commands

Common commands are described in the IEEE 488.2 (IEC 625-2) standard. These commands have the same effect and are employed in the same way on different devices. The headers of these commands consist of "\*" followed by three letters.

Many common commands are related to the Status Reporting System.

*CLS.....	96
*ESE.....	96
*ESR?.....	97
*IDN?.....	97
*OPC.....	97
*OPT?.....	97
*RST.....	97
*SRE.....	98
*STB?.....	98
*TRG.....	98
*TST?.....	98
*WAI.....	98

---

#### \*CLS

Clear status

Sets the status byte (STB), the standard event register (ESR) and the `EVENT` part of the `QUESTIONABLE` and the `OPERATION` registers to zero. The command does not alter the mask and transition parts of the registers. It clears the output buffer.

**Usage:**                      Setting only

---

#### \*ESE <Value>

Event status enable

Sets the event status enable register to the specified value. The query returns the contents of the event status enable register in decimal form.

**Parameters:**

<Value>                      Range:      0 to 255

---

**\*ESR?**

Event status read

Returns the contents of the event status register in decimal form and then sets the register to zero.

**Return values:**

<Contents>                      Range:      0 to 255

**Usage:**                      Query only

---

**\*IDN?**

Identification

Returns the instrument identification.

**Return values:**

<ID>                      "Rohde&Schwarz,<device type>,<part number>/<serial number>,<firmware version>"

**Usage:**                      Query only

---

**\*OPC**

Operation complete

Sets bit 0 in the event status register when all preceding commands have been executed. This bit can be used to initiate a service request. The query writes a "1" into the output buffer when all preceding commands have been executed, which is useful for command synchronization.

---

**\*OPT?**

Option identification query

Queries the options included in the instrument. For a list of all available options and their description, refer to the data sheet.

**Usage:**                      Query only

---

**\*RST**

Reset

Sets the instrument to a defined default status. The default settings are indicated in the description of commands.

**Usage:**                      Setting only

---

**\*SRE** <Contents>

Service request enable

Sets the service request enable register to the indicated value. This command determines under which conditions a service request is triggered.

**Parameters:**

<Contents>                      Contents of the service request enable register in decimal form.  
    Bit 6 (MSS mask bit) is always 0.  
    Range:        0 to 255

---

**\*STB?**

Status byte query

Reads the contents of the status byte in decimal form.

**Usage:**                      Query only

---

**\*TRG**

Recall

Triggers all actions waiting for a trigger event. In particular, \*TRG generates a manual trigger signal. This common command complements the commands of the TRIGger subsystem.

**Usage:**                      Event

---

**\*TST?**

Self-test query

Initiates self-tests of the instrument and returns an error code.

**Return values:**

<ErrorCode>                      **integer > 0 (in decimal format)**  
    An error occurred.  
    **0**  
    No errors occurred.

**Usage:**                      Query only

---

**\*WAI**

Wait to continue

Prevents servicing of the subsequent commands until all preceding commands have been executed and all signals have settled (see also command synchronization and [\\*OPC](#)).

**Usage:**                      Event

## 7.2 System Settings Commands

The `SYSTem` subsystem contains the commands for general functions, which do not affect signal generation directly.

<code>SYSTem:BEEPer:CURRent:STATe</code> .....	99
<code>SYSTem:BEEPer:PROTection:STATe</code> .....	99
<code>SYSTem:BEEPer:PROTection[:IMMEDIATE]</code> .....	99
<code>SYSTem:BEEPer:STATe</code> .....	100
<code>SYSTem:LOCal</code> .....	100
<code>SYSTem:REMOte</code> .....	100
<code>SYSTem:RWLock</code> .....	100
<code>SYSTem:KEY:BRIGhtness</code> .....	100
<code>SYSTem:DATE</code> .....	101
<code>SYSTem:TIME</code> .....	101

---

### `SYSTem:BEEPer:CURRent:STATe` <arg0>

Enables or disables beep sound for "current control" alert.

#### Parameters:

<arg0>	<b>1</b>	Enables the "Current control" beep sound, a continuous beep sound alert when the selected output channel goes into CC mode.
	<b>0</b>	Disables the "Current control" beep sound.

---

### `SYSTem:BEEPer:PROTection:STATe` <arg0>

Enables or disables beep sound for "protection" alert.

#### Parameters:

<arg0>	<b>1</b>	Enables the "protection" beep sound, a single beep alert when a fuse tripped occurs.
	<b>0</b>	Disables the "protection" beep sound.

---

### `SYSTem:BEEPer:PROTection[:IMMEDIATE]`

Return a single "protection" beep sound immediately.

**Usage:** Event

---

**SYSTem:BEEPer:STATe** <Mode>

**SYSTem:BEEPer:STATe?**

Sets or queries the beeper tone.

**Parameters:**

<Mode>                    **1**  
Control beeper is activated.

**0**  
Control beeper is deactivated.

**Example:**                `SYSTem:BEEPer:STATe 1`  
The front panel control beeper is activated.

**Example:**                `SYSTem:BEEPer:STATe?`  
Queries the state of the front panel control beeper. Returns "0" for deactivated (OFF) and "1" for activated (ON) control beeper.

---

**SYSTem:LOCAl**

Sets the system to front panel control. The front panel control is unlocked. If the front panel control was locked with the SCPI command `SYSTem:RWLock`, the message box of the locked front panel on the instrument display will be disappeared.

**Usage:**                    Setting only

---

**SYSTem:REMote**

Sets the system to remote state. The front panel control is locked. By pushing the soft-key button [\*] key, the front panel control will be activated.

**Usage:**                    Setting only

---

**SYSTem:RWLock**

Sets the system to remote state. The front panel control is locked and a message box is shown on the instrument display. You are only able to unlock the front panel control via SCPI command `SYSTem:LOCAl`.

**Usage:**                    Setting only

---

**SYSTem:KEY:BRIGhtness** <brightness>

**SYSTem:KEY:BRIGhtness?**

Sets or queries the front panel key brightness.

**Parameters:**

<brightness>                Sets the key brightness.

                              Range:     0.0 to 1.0

                              Increment: 0.1

                              \*RST:     1.0

**Example:**                `SYSTem:KEY:BRIGhtness 1.0`  
                               `SYSTem:KEY:BRIGhtness? -> 1.0`  
                               Returns key brightness value: 1.0.

**SYSTem:DATE** <year>, <month>, <day>  
**SYSTem:DATE?**

Sets or queries the system date.

**Parameters:**

<year>                    Sets year of the date.  
 <month>                   Sets month of the date.  
 <day>                      Sets day of the date.

**Example:**                `SYSTem:DATE 2018, 10, 15`  
                               `SYSTem:DATE? -> 2018, 10, 15`  
                               Returns the system date.

**SYSTem:TIME** <hh>, <mm>, <ss>  
**SYSTem:TIME?**

Sets or queries the system time.

**Parameters:**

<hh>                        Sets the hours of the system time.  
 <mm>                        Sets the minutes of the system time.  
 <ss>                        Sets the seconds of the system time.

**Example:**                `SYSTem:TIME 12, 30, 59`  
                               `SYSTem:TIME? -> 12, 30, 59`  
                               Returns system time.

## 7.3 Display Commands

The `DISPlay` subsystem contains the commands for display functions, which do not affect signal generation directly.

<code>DISPlay:BRIGhtness</code> .....	101
<code>DISPlay[:WINDow]:TEXT:CLEar</code> .....	102
<code>DISPlay[:WINDow]:TEXT[:DATA]</code> .....	102

**DISPlay:BRIGhtness** <brightness>  
**DISPlay:BRIGhtness?**

Sets or queries the display brightness.

**Parameters:**

<brightness>            Displays brightness for the instrument.  
 Range:            0.0 to 1.0  
 Increment:       0.1  
 \*RST:            0.8

**Example:**

DISPlay:BRIGhtness 0.5  
 DISPlay:BRIGhtness? -> 0.5  
 Returns the display brightness value.

**DISPlay[:WINDow]:TEXT:CLEar**

Clears the text message box on the front display.

**Usage:**                    Setting only

**DISPlay[:WINDow]:TEXT[:DATA] <string>**

Displays a text message box on the front display.

**Setting parameters:**

<string>                    Text message for display.

**Example:**                DISPlay:TEXT "Instrument Test"

**Usage:**                    Setting only

## 7.4 Trigger Commands

The TRIGger subsystem contains the commands for signal triggering.

TRIGger[:STATe].....	102
TRIGger[:SEQuence][:IMMediate]:SOURce.....	103
TRIGger[:SEQuence][:IMMediate]:SOURce:DIO:CHANnel.....	103
TRIGger[:SEQuence][:IMMediate]:SOURce:DIO:PIN.....	104
TRIGger[:SEQuence][:IMMediate]:SOURce:OMODE.....	104
TRIGger[:SEQuence][:IMMediate]:SOURce:OMODE:CHANnel.....	105
TRIGger[:SEQuence][:IMMediate]:SOURce:OUTPut:CHANnel.....	105

**TRIGger[:STATe] <arg0>**

Enables or disables the trigger system.

Upon being triggered, the selected trigger source [TRIGger\[:SEQuence\]\[:IMMediate\]:SOURce](#) on page 103 becomes active.

See [Figure 6-18](#).

**Setting parameters:**

<arg0>                    **1**  
 Enables the trigger system.



**0**

Disables the trigger system.

---

**TRIGger[:SEquence][:IMMediate]:SOURce <arg0>**  
**TRIGger[:SEquence][:IMMediate]:SOURce? <arg0>**

Sets or queries the trigger source.

See [Figure 6-18](#).

**Parameters for setting and query:**

<arg0>                   OUTPut | OMODe | DIO

**OUTPut**

Trigger source is from the output channel (Ch1, Ch2).

**OMODE**

Trigger source is from the different modes (CC, CR, CV, Sink, OVP, OCP, OPP and OTP) detected from the output channel (Ch1, Ch2).

**DIO**

Trigger source is from DIO connector at the instrument rear panel.

**Example:**

TRIG:SOUR OMOD

Trigger source "Operation Modes" is selected for monitoring.

---

**TRIGger[:SEquence][:IMMediate]:SOURce:DIO:CHANnel <arg0>**  
**TRIGger[:SEquence][:IMMediate]:SOURce:DIO:CHANnel? <arg0>**

Sets or queries the device channel for trigger source "Digital In Channel".

See [Figure 6-18](#).

Note: This setting is only available if DIO pin is set to "EXT". See [TRIGger\[:SEquence\]\[:IMMediate\]:SOURce:DIO:PIN](#) on page 104.

**Parameters for setting and query:**

<arg0>                   OUT1 | OUTP1 | OUTPut1 | OUT2 | OUTP2 | OUTPut2 | ANY

**OUT1 | OUTP1 | OUTPut1**

Ch1 is selected as the device channel for trigger source.

**OUT2 | OUTP2 | OUTPut2**

Ch2 is selected as the device channel for trigger source.

**ANY**

Any of the available channel which meets the condition sets as the trigger source.

**Example:**

TRIG:SOUR:DIO:CHAN 1

Ch1 is selected as the device channel for trigger source "Digital In Channel".

---

```
TRIGger[:SEquence][:IMMediate]:SOURce:DIO:PIN <arg0>
TRIGger[:SEquence][:IMMediate]:SOURce:DIO:PIN? <arg0>
```

Sets or queries the DIO pin to trigger on for trigger source "Digital In Channel".

See [Figure 6-18](#).

**Parameters for setting and query:**

<arg0> IN | EXT

**IN**

Pin 3 of DIO connector is monitored.

**EXT**

Pin 2 (Ch1) and Pin 10 (Ch2) of DIO connector is monitored.

**Example:**

```
TRIG:SOUR:DIO:PIN IN
```

Pin 3 of DIO connector is monitored for trigger source "Digital In Channel".

---

```
TRIGger[:SEquence][:IMMediate]:SOURce:OMODE <arg0>
TRIGger[:SEquence][:IMMediate]:SOURce:OMODE? <arg0>
```

Sets or queries the operation mode to trigger on for trigger source "operation mode"

See [Figure 6-18](#).

**Parameters for setting and query:**

<arg0> CC | CV | CR | SINK | PROTection

**CC**

If respective channel operation mode is detected in CC mode, corresponding trigger-out parameters are triggered.

**CV**

If respective channel operation mode is detected in CV mode, corresponding trigger-out parameters are triggered.

**CR**

If respective channel operation mode is detected in CR mode, corresponding trigger-out parameters are triggered.

**SINK**

If respective channel operation mode is detected in sink mode, corresponding trigger-out parameters are triggered.

**PROTection**

If respective channel operation mode is detected in protection mode (OVP, OCP, OPP OTP), corresponding trigger-out parameters are triggered.

**Example:**

```
TRIG:SOUR OMOD
```

```
TRIG:SOUR:OMOD:CHAN OUT1
```

```
TRIG:SOUR:OMOD CV
```

If CV mode is detected on Ch1, a trigger event is activated to corresponding trigger-out parameters.

---

```
TRIGger[:SEquence][:IMMediate]:SOURce:OMODE:CHANnel <arg0>
TRIGger[:SEquence][:IMMediate]:SOURce:OMODE:CHANnel? <arg0>
```

Sets or queries the device channel for trigger source "Operation Modes".

See [Figure 6-18](#).

**Parameters for setting and query:**

<arg0>                   OUT1 | OUTP1 | OUTPut1 | OUT2 | OUTP2 | OUTPut2 | ANY

**OUT1 | OUTP1 | OUTPut1**

Ch1 is selected as the device channel for trigger source.

**OUT2 | OUTP2 | OUTPut2**

Ch2 is selected as the device channel for trigger source.

**ANY**

Any of the available channel which meets the condition sets as the trigger source.

**Example:**

```
TRIG:SOUR:OMOD:CHAN 1
```

Ch1 is selected as the device channel for trigger source "Operation Modes".

---

```
TRIGger[:SEquence][:IMMediate]:SOURce:OUTPut:CHANnel <arg0>
TRIGger[:SEquence][:IMMediate]:SOURce:OUTPut:CHANnel? <arg0>
```

Sets or queries the device channel for trigger source "Output".

See [Figure 6-18](#).

**Parameters for setting and query:**

<arg0>                   OUT1 | OUTP1 | OUTPut1 | OUT2 | OUTP2 | OUTPut2 | ANY

**OUT1 | OUTP1 | OUTPut1**

Ch1 is selected as the device channel for trigger source.

**OUT2 | OUTP2 | OUTPut2**

Ch2 is selected as the device channel for trigger source.

**ANY**

Any of the available channel which meets the condition sets as the trigger source.

**Example:**

```
TRIG:SOUR:OUTP:CHAN 1
```

Ch1 is selected as the device channel for trigger source "Output".

## 7.5 Configuration Commands

The following subsystems contain the commands for channel selection, voltage and current settings for the instrument.

### 7.5.1 Channel Selection

The `INSTRument:Select` subsystem contains the commands for selecting the output channels.

Each channel of the power supply is considered as separate "instrument", which is required by the SCPI standard. Therefore, the SCPI commands use the `INSTRument` node to select a channel.



You can only address the number of channels the instrument is equipped with, e.g. a maximum of two channels for the NGL202, NGM202 or one channel for the NGL201, NGM201.



You can address the channel by using the channel list command syntax. For more information, see "[Syntax for Channel List Commands](#)" on page 183.

#### Example: Selecting a channel

You can select a channel either with an `OUTput` parameter, or just by the channel number. This example lists all ways how you can select and query a selected channel.

```
// *****
// Select a channel
// *****
// selects channel 1
INST OUT1
// queries the channel selection
INST?
// response: "OUT1"
// *****
// Select a channel by its number
// *****
// selects channel number 1
INST:NSEL 1
// queries number of the channel selection
INST:NSEL?
// response: 1
```

<code>INSTRument:NSElect</code> .....	106
<code>INSTRument[:SElect]</code> .....	107

---

**INSTRument:NSElect** <channel>

**INSTRument:NSElect?**

Selects or queries the channel by number.

**Setting parameters:**

<channel>            1 | 2  
                           Range:     1 to 2

**Example:**            See [Example "Selecting a channel"](#) on page 106.

---

**INSTRument[:SElect] <channel>**

**INSTRument[:SElect]?**

Selects or queries the channel by keyword.

**Setting parameters:**

<channel>           OUT1 | OUTP1 | OUTPut1 | 1 | OUT2 | OUTP2 | OUTPut2 | 2

**OUT1 | OUTP1 | OUTPut1 | 1**

Selects Channel 1 (Ch1)

**OUT2 | OUTP2 | OUTPut2 | 2**

Selects Channel 2 (Ch2)

Range:       1 to 2

**Example:**           See [Example "Selecting a channel"](#) on page 106.

## 7.5.2 Safety Limit Setting

The `SOURCE:ALIM` subsystem contains the commands for setting the safety limits of the output channels.

**Example: Configuring the output voltage**

This example contains all commands to configure and query the output voltage.

```
// *****
// Select the channel
// *****
INST OUT1
// *****
// Set upper or lower voltage safety limit
// *****
//sets the safety limits to enable
ALIM 1
//queries the safety limits state
ALIM?
//response: "1"
//sets the safety limits for the upper voltage
VOLT:ALIM 15
//queries the safety limits for the upper voltage
VOLT:ALIM?
//reponse: "15.000"
//sets the safety limits for the lower voltage
VOLT:ALIM:LOW 0
//queries the safety limits for the lower voltage
VOLT:ALIM:LOW?
//reponse: "0.000"
//sets the safety limits for the upper current
CURR:ALIM 3
//queries the safety limits for the upper current
CURR:ALIM?
//reponse: "3.000"
//sets the safety limits for the lower current
CURR:ALIM:LOW 0
//queries the safety limits for the lower current
CURR:ALIM:LOW?
//reponse: "0.000"
```

[SOURce:]ALIMit[:STATe].....	108
[SOURce:]VOLTage[:LEVel][:IMMediate]:ALIMit:LOWer.....	109
[SOURce:]VOLTage[:LEVel][:IMMediate]:ALIMit:UPPer.....	109
[SOURce:]CURRent[:LEVel][:IMMediate]:ALIMit:LOWer.....	110
[SOURce:]CURRent[:LEVel][:IMMediate]:ALIMit:UPPer.....	110

---

**[SOURce:]ALIMit[:STATe] <state>**  
**[SOURce:]ALIMit[:STATe]? [<Channel list>]**

Sets or queries the safety limit state.

**Parameters:**

<state>

**1**

Activates the safety limit.

**0**

Deactivates the safety limit.

**Parameters for setting and query:**

&lt;Channel list&gt;      &lt;list&gt;

**Example:**

ALIM 1, (@1)

Activates the safety limit state at channel 1

**Example:**See [Example "Configuring the output voltage"](#) on page 112.**[SOURce:]VOLTage[:LEVel][:IMMEDIATE]:ALIMit:LOWer** <voltage>**[SOURce:]VOLTage[:LEVel][:IMMEDIATE]:ALIMit:LOWer?** [<Channel list>]

Sets or queries the lower safety limit for voltage.

**Setting parameters:**

&lt;voltage&gt;      &lt;numeric value&gt; | MIN | MINimum | MAX | MAXimum | &lt;list&gt;

**<numeric value>**

Numeric value for safety limit.

**MIN | MINimum**

Min value for lower safety limit.

**MAX | MAXimum**

Max value for lower safety limit.

Range:      0.000E+00 to 2.050E+01

Increment: 0.001

\*RST:      0.000E+00

**Parameters for setting and query:**

&lt;Channel list&gt;      &lt;list&gt;

**Example:**

VOLT:ALIM:LOW? (@1)

Queries the lower safety limit for volatage at channel 1

**Example:**See [Example "Configuring the output voltage"](#) on page 112.**[SOURce:]VOLTage[:LEVel][:IMMEDIATE]:ALIMit[:UPPer]** <voltage>**[SOURce:]VOLTage[:LEVel][:IMMEDIATE]:ALIMit[:UPPer]?** [<Channel list>]

Sets or queries the upper safety limit for voltage.

**Setting parameters:**

&lt;voltage&gt;      &lt;numeric value&gt; | MIN | MINimum | MAX | MAXimum | &lt;list&gt;

**<numeric value>**

Numeric value for upper safety limit.

**MIN | MINimum**

Min value for upper safety limit.

**MAX | MAXimum**

Max value for upper safety limit.

Range:      0.000E+00 to 2.050E+01

Increment: 0.001

\*RST: 2.050E+01

**Parameters for setting and query:**

<Channel list> <list>

**Example:**

VOLT:ALIM:UPP? (@1)

Queries the upper safety limit for voltage at channel 1.

**Example:**

See [Example "Configuring the output voltage"](#) on page 112.

[SOURce:]CURRENT[:LEVel][:IMMEDIATE]:ALIMit:LOWer <current>

[SOURce:]CURRENT[:LEVel][:IMMEDIATE]:ALIMit:LOWer? [<Channel list>]

Sets or queries the lower safety limit for current.

**Setting parameters:**

<current> <numeric value> | MIN | MINimum | MAX | MAXimum | <list>

**<numeric value>**

Numeric value for lower safety limit.

**MIN | MINimum**

Min value for lower safety limit.

**MAX | MAXimum**

Max value for lower safety limit.

Range: For up to 6V: 0.001E+00 to 3.010E+00. For above 6V: 0.001E+00 to 6.010E+00

Increment: 0.001

\*RST: 0.001E+00

**Parameters for setting and query:**

<Channel list> <list>

**Example:**

CURR:ALIM:LOW? (@1)

Queries the lower safety limit for current at channel 1.

**Example:**

See [Example "Configuring the current output"](#) on page 115.

[SOURce:]CURRENT[:LEVel][:IMMEDIATE]:ALIMit[:UPPer] <current>

[SOURce:]CURRENT[:LEVel][:IMMEDIATE]:ALIMit[:UPPer]? [<Channel list>]

Sets or queries the upper safety limit for current.

**Setting parameters:**

<current> <numeric value> | MIN | MINimum | MAX | MAXimum | <list>

**<numeric value>**

Numeric value for upper safety limit.

**MIN | MINimum**

Min value for upper safety limit.

**MAX | MAXimum**

Max value for upper safety limit.

Range: For up to 6V: 0.001E+00 to 3.010E+00. For above 6V: 0.001E+00 to 6.010E+00



Increment: 0.001  
\*RST: 6.010E+00

**Parameters for setting and query:**

<Channel list>      <list>

**Example:**            CURR:ALIM:UPP? (@1)  
Queries the upper safety limit for current at channel 1.

**Example:**            See [Example "Configuring the current output"](#) on page 115.

### 7.5.3 Voltage Setting

The SOURce:VOLTage subsystem contains the commands for setting the voltage of the output channels. The default unit is V.

**Example: Configuring the output voltage**

This example contains all commands to configure and query the output voltage.

```
// *****
// Select the channel
// *****
INST OUT1
// *****
// Set upper or lower voltage safety limit
// *****
//sets the safety limits to enable
ALIM 1
//queries the safety limits state
ALIM?
//response: "1"
//sets the safety limits for the upper voltage
VOLT:ALIM 15
//queries the safety limits for the upper voltage
VOLT:ALIM?
//response: "15.000"
//sets the safety limits for the lower voltage
VOLT:ALIM:LOW 0
//queries the safety limits for the lower voltage
VOLT:ALIM:LOW?
//response: "0.000"
// *****
// Set the voltage value
// *****
// selects a channel and sets the voltage
VOLT 10
// sets the voltage to maximum or minimum respectively
VOLT MAX
VOLT MIN
// queries the output voltage of a channel
VOLT?
// response: "10.000"
// *****
// Query the range of the voltage values
// *****
// queries the upper and lower limit of the output voltage
VOLT? MIN
// response: "0.000"
VOLT? MAX
// response: "20.050"
// *****
// Increase or decrease the voltage stepwise
// *****
// selects the output channel, sets the step width
// and increases the voltage in the selected channel
// from 4 Volts
```

```

INST OUT1
VOLT:STEP 4
VOLT UP
// decreases the voltage in the selected channel
// from 4 Volts
VOLT DOWN
// queries the voltage step size
VOLT:STEP?
// response: "4.000"

```

[\[SOURce:\]VOLTage\[:LEVel\]\[:IMMediate\]\[:AMPLitude\]](#)..... 113

[\[SOURce:\]VOLTage\[:LEVel\]\[:IMMediate\]:STEP\[:INCRement\]](#)..... 114

---

**[SOURce:]VOLTage[:LEVel][:IMMediate][:AMPLitude]** <voltage>  
**[SOURce:]VOLTage[:LEVel][:IMMediate][:AMPLitude]?** [<Channel list>]

Sets or queries the voltage value of the selected channel.

**Parameters:**

<voltage>                    <numeric value> | MIN | MINimum | MAX | MAXimum | UP |  
DOWN | <list>

**<numeric value>**

Numeric value in V.

**MIN | MINimum**

Minimum voltage at 0.000 V.

**MAX | MAXimum**

Maximum voltage at 20.050 V.

**UP**

Increases voltage by a defined step size. See [\[SOURce:\]VOLTage\[:LEVel\]\[:IMMediate\]:STEP\[:INCRement\]](#) on page 114.

**DOWN**

Decreases voltage by a defined step size. See [\[SOURce:\]VOLTage\[:LEVel\]\[:IMMediate\]:STEP\[:INCRement\]](#) on page 114.

Range:        0.000 to 20.05

Default unit: V

**Parameters for setting and query:**

<Channel list>            <list>

**Example:**

VOLT? (@1)

Queries the voltage at channel 1.

**Example:**

See [Example "Configuring the output voltage"](#) on page 112.

---

```
[SOURce:]VOLTage[:LEVel][:IMMediate]:STEP[:INCRement] <stepsize>
[SOURce:]VOLTage[:LEVel][:IMMediate]:STEP[:INCRement]? [<Optional default
step query>]
```

Sets or queries the incremental step size for the [VOLT UP](#) | [VOLT DOWN](#) command.

**Setting parameters:**

<stepsize>                    <numeric value> | DEF | DEFault

**<numeric value>**

Step value in V.

**DEF | DEFault**

Default value of stepsize.

Range:        0.001 to 5.000

Increment:   0.001

\*RST:        0.100

Default unit: V

**Parameters for setting and query:**

<stepsize>                    DEF | DEFault

Queries the default voltage step size.

**Example:**

```
INST OUT1
VOLT:STEP 0.001
VOLT:STEP DEF
VOLT:STEP? DEF -> 0.10
```

Returns the default stepsize voltage.

See also [Example "Configuring the output voltage"](#) on page 112.

## 7.5.4 Current Setting

The `SOURce:CURRent` subsystem contains the commands for setting the current limit of the output channels. The default unit is A.

**Example: Configuring the current output**

```
// *****
// Select the channel
// *****
INST OUT1
// *****
// Set upper or lower current safety limit
// *****
//sets the safety limits to enable
ALIM 1
//queries the safety limits state
ALIM?
//response: "1"
//sets the safety limits for the upper current
CURR:ALIM 3
//queries the safety limits for the upper current
CURR:ALIM?
//reponse: "3.000"
//sets the safety limits for the lower current
CURR:ALIM LOW 0.001
//queries the safety limits for the lower current
CURR:ALIM:LOW?
//response: "0.001"
// *****
// Set the current value
// *****
// selects a channel and sets the current
CURR 2
// queries the current of the selected channel
CURR?
// response: 2.000
// *****
// Query the range of the current values
// *****
// queries the upper and lower limit of the current
CURR? MIN
// response: 0.001
CURR? MAX
// response: 3.000
// *****
// Increase or decrease the current stepwise
// *****
// selects the output channel, sets the step width
// and decreases the current in the selected channel
// by the set 1 Ampere
INST OUT1
CURR:STEP 1
CURR DOWN
// increases the current in the selected channel
// by the set 1 Ampere
```

```
CURR UP
// queries the current step size
CURR:STEP?
// response: 1.000
```

[SOURce:]CURRent[:LEVel][:IMMediate]:STEP[:INCRement]..... 116  
 [SOURce:]CURRent[:LEVel][:IMMediate]:AMPLitude]..... 116

---

**[SOURce:]CURRent[:LEVel][:IMMediate]:STEP[:INCRement] <stepsize>**  
**[SOURce:]CURRent[:LEVel][:IMMediate]:STEP[:INCRement]? [<Optional default step query>]**

Sets or queries the incremental step size for the [CURR UP](#) | [CURR DOWN](#) command.

**Setting parameters:**

<stepsize>            <numeric value> | DEF | DEFault  
                           **<numeric value>**  
                           Step value in A.  
                           **DEF | DEFault**  
                           Default value of stepsize.  
                           Range:        0.0001 to 2.000  
                           Increment: 0.0001  
                           \*RST:        0.010  
                           Default unit: A

**Parameters for setting and query:**

<Optional default step DEF | DEFault  
 query>                Queries the default voltage step size.

**Example:**

```
INST OUT1
CURR:STEP 0.005
CURR:STEP DEF
VOLT:STEP? DEF -> 0.1000E+00
Returns the default stepsize for current.
See Example "Configuring the current output" on page 115.
```

---

**[SOURce:]CURRent[:LEVel][:IMMediate]:AMPLitude] <current>**  
**[SOURce:]CURRent[:LEVel][:IMMediate]:AMPLitude]? [<Channel list>]**

Sets or queries the current value of the selected channel.

**Parameters:**

<current>            <numeric value> | MIN | MINimum | MAX | MAXimum | UP |  
                           DOWN | <list>  
                           **<numeric value>**  
                           Numeric value in the range of 0.000 to 6.010.  
                           **MIN | MINimum**  
                           Minimum current at 0.010 A.

**MAX | MAXimum**

Depending on the set voltage level, the maximum set current is 6.010 A.

For voltage range from 0 V to 6 V, maximum set current is 6.01 A.

For voltage > 6 V, maximum set current is 3.01 A.

**UP**

Increases current by a defined step size. See [\[SOURCE:\]CURRENT\[:LEVEL\]\[:IMMEDIATE\]:STEP\[:INCREMENT\]](#) on page 116.

**DOWN**

Decreases current by a defined step size. See [\[SOURCE:\]CURRENT\[:LEVEL\]\[:IMMEDIATE\]:STEP\[:INCREMENT\]](#) on page 116.

**Parameters for setting and query:**

<Channel list>      <list>

**Example:**            CURR? (@1)  
Queries the current at channel 1.

**Example:**            See [Example "Configuring the current output"](#) on page 115.

## 7.5.5 Resistance Setting

The SOURCE:RESistance subsystem contains the commands for setting the resistance limit of the output channels. The default unit is ohms.

**Example: Configuring the resistance limit**

```
// *****
// Select the channel
// *****
INST OUT1
// *****
// Set the resistance value
// *****
// selects a channel and sets the resistance
RES 10
// queries the resistance of the selected channel
RES?
// response: 10.000
// *****
// Query the range of the resistance values
// *****
// queries the upper and lower limit of the resistance
RES? MIN
// response: 0.000
RES? MAX
// response: 10000
// *****
// Activate the constant resistance mode
// *****
// selects a channel and activate the constant resistance mode
RES:STAT 1
// queries the constant resistance mode
RES:STAT?
// response: 1
```

[SOURCE:]RESistance[:LEVel][:IMMediate][:AMPLitude].....	118
[SOURCE:]RESistance:STATe.....	119

**[SOURCE:]RESistance[:LEVel][:IMMediate][:AMPLitude] <resistance>**  
**[SOURCE:]RESistance[:LEVel][:IMMediate][:AMPLitude]? [<Channel list>]**

Sets or queries the constant resistance target value.

**Parameters:**

<resistance>                    <numeric value> | MIN | MINimum | MAX | MAXimum | UP |  
                                       DOWN | <list>

**<numeric value>**  
 Numeric value in the range of 0.000 ohm to 10000 ohms.

**MIN | MINimum**  
 Minimum resistance at 0.000 ohm.

**MAX | MAXimum**  
 Maximum resistance at 10000 ohms.

**UP**  
 Increases resistance by a defined step size.



**DOWN**

Decreases resistance by a defined step size.

Increment: 0.1 ohms

Default unit: ohms

**Parameters for setting and query:**

<Channel list>      <list>

**Example:**

RES? (@1)

Queries the constant resistance target value at channel 1.

**Example:**

See [Example "Configuring the resistance limit"](#) on page 118.

**[SOURce:]RESistance:STATe <state>**

**[SOURce:]RESistance:STATe? [<Channel list>]**

Sets or queries the constant resistance mode.

**Parameters:**

<state>

**0**

Deactivates constant resistance mode.

**1**

Activates constant resistance mode.

**Parameters for setting and query:**

<Channel list>      <list>

**Example:**

RES:STAT? (@1)

Queries the constant resistance mode at channel 1.

**Example:**

See [Example "Configuring the resistance limit"](#) on page 118

## 7.5.6 Combined Setting of Voltage and Current Setting

The `APPLY` subsystem provides a command that enables you to set the current and voltage of a channel in one step.



The combined voltage and current setting command takes approximately 100 ms, i.e. longer than the setting of a single value.

**APPLY <voltage> [,<current>][,<output>]**

Sets or queries the voltage and current value of the selected channel.

**Parameters:**

<voltage>

<numeric value> | MIN | MINimum | MAX | MAXimum | DEF | DEFault

**<numeric value>**

Numeric value for voltage in the range of 0.000 to 20.050.

**MIN | MINimum**

Min voltage at 0.000 V.

**MAX | MAXimum**

Max value for voltage at 20.050V.

**DEF | DEFault**

Default voltage.

\*RST: 1.000

Default unit: V

<current>

<numeric value> | MIN | MINimum | MAX | MAXimum | DEFault

**<numeric value>**

Numeric value for current in the range of 0.000 to 6.010.

**MIN | MINimum**

Min current at 0.000 A.

**MAX | MAXimum**

Max value for current at 6.010 A.

**DEF | DEFault**

Numeric value for current.

\*RST: 1.000

Default unit: A

<output>

OUT1 | OUTP1 | OUTPut1 | OUT2 | OUTP2 | OUTPut2

**OUT1 | OUTP1 | OUTPut1**

Selects output for channel 1.

**OUT2 | OUTP2 | OUTPut2**

Selects output for channel 2.

**Example:**

```
INST OUT1
```

```
APPL 6, 2
```

Sets 6 V and 2 A to output of channel 1.

```
APPL? -> 6.000, 2.000
```

Queries the voltage and current of the selected channel.

**READ? [<Channel list>]**

Queries the currently voltage-current measurement pair and returns them separated by comma.

**Parameters:**

<Channel list> <list>

**Example:**

```
READ? -> 1.001080E+00,1.004224E-02
```

**Example:**

```
READ? (@1)
```

Queries the voltage-current measurement pair at channel 1.

**Usage:**

Query only

## 7.5.7 Output Setting

The `OUTPut` subsystem contains the commands for activating the output channels.

**Example: Activating the channels**

You can activate a selected channel and turn on or off the outputs either individually or all outputs simultaneously. This example lists all ways how you can activate and query the outputs.

```
// *****
// Activate a channel
// *****
INST OUT1
// activates the selected channel
OUTP:SEL 1
// activates channel 1 and its output
OUTP 1
// queries the output state
OUTP?
// response: 1
// *****
// Turn on all selected channels simultaneously
// *****
// selects channels 1 and 2
// sets the voltage and current values for both channels
// activates both channels
INST:OUT1
VOLT 12
CURR 0.1
OUTP:SEL 1
INST:OUT2
VOLT 12
CURR 0.2
OUTP:SEL 1
// turns on the output of both channels
OUTP:GEN 1
```

<a href="#">OUTPut:GENeral[:STATe]</a> .....	122
<a href="#">OUTPut[:STATe]</a> .....	122
<a href="#">OUTPut:DELay:DUration</a> .....	122
<a href="#">OUTPut:DELay[:STATe]</a> .....	123
<a href="#">OUTPut:FTResponse</a> .....	123
<a href="#">OUTPut:IMPedance</a> .....	124
<a href="#">OUTPut:IMPedance:STATe</a> .....	124
<a href="#">OUTPut:MODE</a> .....	125
<a href="#">OUTPut:SElect</a> .....	125
<a href="#">OUTPut:TRIGgered</a> .....	126
<a href="#">OUTPut:TRIGgered[:STATe]</a> .....	126
<a href="#">OUTPut:TRIGgered:BEHavior</a> .....	126

---

**OUTPut:GENeral[:STATe]** <state>

**OUTPut:GENeral[:STATe]?**

Sets or queries all previous selected channels simultaneously

**Parameters:**

<state>                    **0**  
                                      Switches off previous selected channels simultaneously.

**1**  
                                      Switches on previous selected channels simultaneously.

**Example:**                    See [Example "Activating the channels"](#) on page 121

---

**OUTPut[:STATe]** <state>

**OUTPut[:STATe]?** [<Channel list>]

Sets or queries the output state of the previous selected channels.

**Parameters:**

<state>                    **0**  
                                      Switches off previous selected channels.

**1**  
                                      Switches on previous selected channels.

**Parameters for setting and query:**

<Channel list>            <list>

**Example:**                    OUTP? (@1)  
                                      Queries the output state at channel 1.

**Example:**                    See [Example "Activating the channels"](#) on page 121

---

**OUTPut:DELay:DURation** <duration>

**OUTPut:DELay:DURation?** [<Channel list>]

Sets or queries the duration for output delay.

**Parameters:**

<duration>                <numeric value> | MIN | MINimum | MAX | MAXimum | <list>

**<numeric value>**  
                                      Numeric value of the duration in seconds.

**MIN | MINimum**  
                                      Minimum value of the duration at 0.001 seconds.

**MAX | MAXimum**  
                                      Maximum value of the duration at 10.00 seconds.

                                     Range:        0.001 to 10.00

                                     \*RST:        0.001

                                     Default unit: s

**Parameters for setting and query:**

<Channel list>            <list>

**Example:**            `OUTPut:DElay:DURation 1`  
                   `OUTPut:DElay:DURation? -> 1`  
 Returns output delay of 1 s.

**Example:**            `OUTPut:DElay:DURation? (@1)`  
 Returns output delay at channel 1.

**OUTPut:DElay[:STATe] <state>**  
**OUTPut:DElay[:STATe]? [<Channel list>]**

Sets or queries the output delay state for the selected channel.

**Parameters:**

**<state>**                **0**  
 Deactivates output delay for the selected channel.  
**1**  
 Activates output delay for the selected channel.

**Parameters for setting and query:**

**<Channel list>**        **<list>**

**Example:**            `OUTPut:DElay 1`  
                   `OUTPut:DElay? -> 1`  
 Returns output delay state as on.

**Example:**            `OUTPut:DElay? (@1)`  
 Returns output delay state at channel 1.

**OUTPut:FTResponse <state>**  
**OUTPut:FTResponse? [<Channel list>]**

Sets or queries the fast transient response state.

**Parameters:**

**<state>**                **0**  
 Deactivates fast transient response.  
**1**  
 Activates fast transient response.

**Parameters for setting and query:**

**<Channel list>**        **<list>**

**Example:**            `OUTPut:FTResponse 1`  
                   `OUTPut:FTResponse? -> 1`  
 Returns fast transient response state as on.

**Example:**            `OUTPut:FTR? (@1)`  
 Returns fast transient response state at channel 1.

---

**OUTPut:IMPedance** <resistance>

**OUTPut:IMPedance?** [<Channel list>]

Sets or queries source impedance for the signal specified in ohms.

**Parameters:**

<arg0>                    <numeric value> | MIN | MINimum | MAX | MAXimum | DEF | DEFault | <list>

**<numeric value>**

Numeric value of the impedance ohm.

**MIN | MINimum**

Minimum value of the impedance at -0.05 ohms.

**MAX | MAXimum**

Maximum value of the impedance at 100 ohms.

**DEF**

Default value of the impedance at 0 ohms.

\*RST:            0

Default unit: ohm

**Parameters for setting and query:**

<Channel list>            <list>

**Example:**

OUTPut:IMPedance 1

OUTPut:IMPedance? -> 1

Returns output impedance of 1 ohm.

**Example:**

OUTPut:IMPedance? (@1)

Returns output impedance at channel 1.

---

**OUTPut:IMPedance:STATe** <state>

**OUTPut:IMPedance:STATe?** [<Channel list>]

Sets or queries the impedance target for the selected channel.

**Parameters:**

<state>

**0**

Deactivates output impedance for the selected channel.

**1**

Activates output impedance for the selected channel.

**Parameters for setting and query:**

<Channel list>            <list>

**Example:**

OUTPut:IMPedance 1

OUTPut:IMPedance:STAT? -> 1

Returns output impedance state as on.

**Example:**

OUTPut:IMPedance:STAT? (@1)

Returns output impedance state at channel 1.

---

**OUTPut:MODE** <arg0>[, <Channel list>]

**OUTPut:MODE?** [<Channel list>]

Sets or queries the output mode.

The R&S NGL/NGM power supply series are 2 quadrant power supplies which either source or sink current.

**Parameters:**

<arg0>                    AUTO | SINK | SOURce | <list>

**AUTO**

If operates in auto mode, the R&S NGL/NGM goes into sink or source mode depending on the voltage across the output terminal. If voltage across the output terminal exceeds the set voltage, current flows into the instrument, e.g. the instrument is now operating in sink mode; vv if voltage across output terminal is below set voltage, instrument operates as a source mode.

**SINK**

If operates in sink mode, current flows into the instrument. On display, current is shown as negative current.

**SOURce**

If operates in source mode, current flows out from the instrument.

**Parameters for setting and query:**

<Channel list>            <list>

**Example:**                OUTPut:MOD? (@1)  
Queries output mode at channel 1.

**Example:**                OUTPut:MOD AUTO, (@1)  
Set output mode to "AUTO" at channel 1.

---

**OUTPut:SElect** <state>

**OUTPut:SElect?** [<Channel list>]

Sets or queries the output state of selected channel.

**Parameters:**

<state>                    **0**  
Deactivates the selected channel.  
**1**  
Activates the selected channel.  
\*RST:                    0

**Parameters for setting and query:**

<Channel list>            <list>

**Example:**                See [Example "Activating the channels"](#) on page 121

**Example:**                OUTPut:SEL? (@1)  
Queries output state at channel 1.

---

**OUTPut:TRIGgered** <arg0>  
**OUTPut:TRIGgered[:STATe]** <arg0>[, <Channel list>]  
**OUTPut:TRIGgered[:STATe]?** [<Channel list>]

Enables or disables the triggered event for output.

**Setting parameters:**

<arg0>                    **1**  
                                  Trigger is enabled.  
                                  **0**  
                                  Trigger is disabled.

**Parameters for setting and query:**

<Channel list>            <list>

**Example:**                `OUTP:TRIG 1`  
 When a trigger event occurs, respective channel output is triggered.  
 See [OUTPut:TRIGgered:BEHavior](#) on page 126.

**Example:**                `OUTPut:TRIG? (@1)`  
 Queries trigger event for output at channel 1.

---

**OUTPut:TRIGgered:BEHavior** <arg0>[, <Channel list>]  
**OUTPut:TRIGgered:BEHavior?** [<Channel list>]

Sets or queries output behavior when a trigger event occurs.

**Setting parameters:**

<arg0>                    `ON | OFF | GATed | <list>`  
                                  **ON**  
                                  Output is set on when a trigger event occurs.  
                                  **OFF**  
                                  Output is set off when a trigger event occurs.  
                                  **GATed**  
                                  Output is set gated when a trigger event occurs.

**Parameters for setting and query:**

<Channel list>            <list>

**Example:**                `OUTP:TRIG:STAT 1`  
                                  `OUTP:TRIG:BEH ON`

**Example:**                `OUTPut:TRIG:BEH? (@1)`  
 Queries output behavior of trigger event at channel 1.

### 7.5.8 Range/DVM Setting



The DVM and range settings are available only with R&S NGM power supply series equipped with R&S NGM-K104 (P/N: 3643.9927.02).



The `SOUR:VOLT:DVM` contains commands for activating the DVM function.

The `SENSE:CURR:RANG` and `SENSE:VOLT:RANG` contains commands for setting the voltage range and current range of the measurements.

All these commands require `*OPC?` at the end of the command execution.

<code>[SOURce:]VOLTage:DVM[:STATe]</code> .....	127
<code>SENSe:CURRent:RANGe:AUTO</code> .....	127
<code>SENSe:CURRent:RANGe[:UPPer]</code> .....	128
<code>SENSe:VOLTage:RANGe:AUTO</code> .....	128
<code>SENSe:VOLTage:RANGe[:UPPer]</code> .....	128

---

**`[SOURce:]VOLTage:DVM[:STATe]` <arg0>[, <Channel list>]**

**`[SOURce:]VOLTage:DVM[:STATe]?` [<Channel list>]**

Sets or queries digital voltmeter measurements.

**Parameters:**

<arg0>	<b>1</b> Enables digital voltmeter measurement.
	<b>0</b> Disables digital voltmeter measurement.

**Parameters for setting and query:**

<Channel list>      <list>

**Example:**            `VOLT:DVM 1`  
                          `MEAS:VOLT:DVM? -> 1.000E+00`  
 Enables and returns digital voltmeter measurement.

**Example:**            `VOLT:DVM? (@1)`  
 Queries DVM state at channel 1.

**Usage:**              Asynchronous command

---

**`SENSe:CURRent:RANGe:AUTO` <arg0>[, <Channel list>]**

**`SENSe:CURRent:RANGe:AUTO?` [<Channel list>]**

Sets or queries auto range for current measurement accuracy.

**Parameters:**

<arg0>	<b>1</b> Enables auto range for current.
	<b>0</b> Disables auto range for current.

**Parameters for setting and query:**

<Channel list>      <list>

**Example:**            `SENS:CURR:RANG:AUTO 1`  
 Enables auto range for current.

**Example:** `SENS:CURR:RANG:AUTO? (@1)`  
 Queries auto range state for current measurement accuracy at channel 1.

---

**SENSe:CURRent:RANGe[:UPPer] <arg0>[, <Channel list>]**  
**SENSe:CURRent:RANGe[:UPPer]? [<Channel list>]**

Sets or queries the current range for measurement. There is a selection of 10 A, 1 A, 100 mA and 10 mA range.

**Parameters:**

<arg0> Defines the current range for measurement (10 A, 1 A, 100 mA and 10 mA).  
 Default unit: A

**Parameters for setting and query:**

<Channel list> <list>

**Example:** `SENS:CURR:RANG 10`  
 Sets the instrument to the 10 A measurement accuracy.  
 Refers to datasheet for the measurement accuracy in the 10 A range.

**Example:** `SENS:CURR:RANG? (@1)`  
 Queries current range for measurement at channel 1.

---

**SENSe:VOLTage:RANGe:AUTO <arg0>[, <Channel list>]**  
**SENSe:VOLTage:RANGe:AUTO? [<Channel list>]**

Sets or queries auto range for voltage measurement accuracy.

**Parameters:**

<arg0> **1**  
 Enables auto range for voltage.  
**0**  
 Disables auto range for voltage.

**Parameters for setting and query:**

<Channel list> <list>

**Example:** `SENS:VOLT:RANG:AUTO 1`  
 Enables auto range for voltage.

**Example:** `SENS:VOLT:RANG:AUTO? (@1)`  
 Queries auto range state for voltage measurement accuracy at channel 1.

---

**SENSe:VOLTage:RANGe[:UPPer] <arg0>[, <Channel list>]**  
**SENSe:VOLTage:RANGe[:UPPer]? [<Channel list>]**

Sets or queries the voltage range for measurement. There is a selection of 20 V and 5 V range.

**Parameters:**

<arg0> Defines the voltage range for measurement (20 V and 5 V).  
Default unit: V

**Parameters for setting and query:**

<Channel list> <list>

**Example:**

```
SENS:VOLT:RANG 20
```

Sets the instrument to the 20 V measurement accuracy.  
Refers to datasheet for the measurement accuracy in the 20 V range.

**Example:**

```
SENS:VOLT:RANG? (@1)
```

Queries voltage range for measurement at channel 1.

### 7.5.9 OCP Setting

The `CURRENT:PROTECTION` subsystem contains the commands for overcurrent protection parameters such as activating fuses and setting fuse parameters of the output channels. The default unit is A.



The delay function of the fuses takes effect when the corresponding channel is activated (Output On).

**Example: Configuring the overcurrent protection**

This example contains all commands to configure and query the fuse states and settings.

```
// *****
// Configuring the overcurrent protection
// *****
INST OUT1
// selects a channel and activates the overcurrent protection
CURR:PROT 1
// queries the state of the overcurrent protection in the selected channel
CURR:PROT?
// response: 1
// *****
// Set a delay time for the overcurrent protection. The delay time
// takes effect when the channel output is turned on.
// *****
// sets 50 ms delay for the overcurrent protection
CURR:PROT:DEL 50
// queries the currently set delay time of the overcurrent protection
// in the selected channel
CURR:PROT:DEL?
// response: 50
// sets the delay time to maximum, minimum respectively
CURR:PROT:DEL MAX
```

```

CURR:PROT:DEL MIN
// *****
// Query the range of the overcurrent protection delay time
// *****
// queries the upper and lower limit of the
// overcurrent protection delay time in ms
CURR:PROT:DEL? MIN
// response: 0
CURR:PROT:DEL? MAX
// response: 10000
// *****
// Set a initial delay time for the overcurrent protection. During
// the timeframe, overcurrent protection tripping is inhibited.
// *****
// sets 100 ms for the initial overcurrent protection delay
CURR:PROT:DEL:INIT 100
// queries the currently set initial overcurrent protection delay
// in the selected channel
CURR:PROT:DEL:INIT?
// response: 100
// sets the initial overcurrent protection delay to maximum, minimum respectively
CURR:PROT:DEL:INIT MAX
CURR:PROT:DEL:INIT MIN
// *****
// Query the range of the overcurrent protection delay time
// *****
// queries the upper and lower limit of the
// overcurrent protection delay time in ms
CURR:PROT:DEL:INIT? MIN
// response: 10
CURR:PROT:DEL:INIT? MAX
// response: 60000
// *****
// Query a tripped overcurrent protection
// *****
INST OUT1
//queries whether the OCP in channel 1 has tripped
CURR:PROT:TRIP?
//response: 1 OCP is tripped
//response: 0 OCP is not tripped
//resets a tripped OCP in the selected channel
CURR:PROT:CLear
// *****
// Link the electronic overcurrent protection of the channels logically
// *****
INST OUT1
// links the overcurrent protection of channel 1 with channel 2
CURR:PROT:LINK 2
// queries the combined overcurrent protection of the selected channel
CURR:PROT:LINK?2

```

```
// *****
// Unlink linked overcurrent protection
// *****
// queries the combined overcurrent protection of the selected channel
CURR:PROT:UNLink 2
CURR:PROT:LINK?2
```

[SOURce:]CURRent:PROTection:CLEar.....	131
[SOURce:]CURRent:PROTection:DELAy:INITial.....	131
[SOURce:]CURRent:PROTection:DELAy.....	132
[SOURce:]CURRent:PROTection:LINK.....	132
[SOURce:]CURRent:PROTection:TRIPped?.....	133
[SOURce:]CURRent:PROTection:UNLink.....	133
[SOURce:]CURRent:PROTection[:STATe].....	133
FUSE:DELAy:INITial.....	134
FUSE:DELAy[:BLOWing].....	134
FUSE:LINK.....	135
FUSE:TRIPped?.....	135
FUSE:UNLink.....	135
FUSE[:STATe].....	135

---

#### [SOURce:]CURRent:PROTection:CLEar [<Channel list>]

Resets the OCP state of the selected channel. If an OCP event has occurred before, the reset also erases the message on the display.

#### Setting parameters:

<Channel list>      <list>

**Example:**            CURR:PROT:CLE (@1)  
Resets OCP state at channel 1.

**Example:**            See [Example "Configuring the overcurrent protection"](#)  
on page 129.

**Usage:**              Setting only

---

#### [SOURce:]CURRent:PROTection:DELAy:INITial <duration>

#### [SOURce:]CURRent:PROTection:DELAy:INITial? [<Channel list>]

Sets or queries the initial fuse delay time once output turns on.

#### Parameters:

<duration>            <numeric value> | MIN | MINimum | MAX | MAXimum | <list>

#### <numeric value>

Numeric value for initial fuse delay.

#### MIN | MINimum

Min value for initial fuse delay.

#### MAX | MAXimum

Max value for initial fuse delay.

Range:            0.00 to 60.00

\*RST: 0  
Default unit: s

**Parameters for setting and query:**

<Channel list> <list>

**Example:** CURR:PROT:DEL:INIT? (@1)  
Queries initial fuse delay time at channel 1.

**Example:** See [Example "Configuring the overcurrent protection"](#) on page 129.

**[SOURCE:]CURRENT:PROTECTION:DELAY <New value for voltage>[, <Channel list>]**

**[SOURCE:]CURRENT:PROTECTION:DELAY? [<Channel list>]**

Sets or queries the fuse delay time.

**Parameters:**

<duration> <numeric value> | MIN | MINimum | MAX | MAXimum

**<numeric value>**

Numeric value for the initial fuse delay.

**MIN | MINimum**

Min value for initial fuse delay.

**MAX | MAXimum**

Max value for initial fuse delay.

Range: 0.00 to 10.00

\*RST: 0

Default unit: s

**Parameters for setting and query:**

<Channel list> <list>

**Example:** CURR:PROT:DLEAY 1, (@1)  
Sets initial fuse delay 1 s at channel 1.

**Example:** See [Example "Configuring the overcurrent protection"](#) on page 129.

**[SOURCE:]CURRENT:PROTECTION:LINK <arg0>**

**[SOURCE:]CURRENT:PROTECTION:LINK? <arg0>**

Sets or queries the fuses of several selected channels (fuse linking).

**Parameters for setting and query:**

<arg0> 1 | 2

**Example:** INST OUT1::CURRENT:PROTECTION:LINK 2  
Channel 2 is linked with channel 1  
INST OUT1::CURRENT:PROTECTION:LINK?2  
Returns 1 if channel 1 is linked with channel 2

**Example:** See [Example "Configuring the overcurrent protection"](#) on page 129.

---

**[SOURce:]CURRent:PROTection:TRIPped? [<Channel list>]**

Queries the OCP state of the selected channel.

**Query parameters:**

<Channel list>      <list>

**Example:**            CURR:PROT:TRIP?  
Response 1, the OCP is tripped.  
Response 0, the OCP is not tripped.

**Example:**            CURR:PROT:TRIP? (@1)  
Queries OCP state at channel 1.

**Example:**            See [Example "Configuring the overcurrent protection"](#)  
on page 129.

**Usage:**              Query only

---

**[SOURce:]CURRent:PROTection:UNLink <arg0>**

Unlink fuse linking from the other channel (Ch1 or Ch2).

**Parameters for setting and query:**

<arg0>                1 | 2

**Example:**            CURR:PROT:UNL 1  
Fuse linking is unlinked from channel 1

**Example:**            See [Example "Configuring the overcurrent protection"](#)  
on page 129.

**Usage:**              Setting only

---

**[SOURce:]CURRent:PROTection[:STATe] <arg0>[, <Channel list>]  
[SOURce:]CURRent:PROTection[:STATe]? [<Channel list>]**

Sets or queries the OCP state.

**Parameters:**

<arg0>                1  
                          Activates the OCP state.  
                          0  
                          deactivates the OCP state.

**Parameters for setting and query:**

<Channel list>      <list>

**Example:**            CURR:PROT 1  
Activates the OCP.

**Example:**            CURR:PROT? (@1)  
Queries OCP state at channel 1.

**Example:**            See [Example "Configuring the overcurrent protection"](#)  
on page 129.

---

**FUSE:DELay:INITial** <delay>

**FUSE:DELay:INITial?** [<Channel list>]

Sets or queries initial delay time for the fuse to take effect.

**Parameters:**

<delay>                    <numeric value> | MIN | MINimum | MAX | MAXimum | <list>

**<numeric value>**

Numeric value for linitial fuse delay.

**MIN | MINimum**

Min value for lowe linitial fuse delay.

**MAX | MAXimum**

Max value for linitial fuse delay.

Range:            0.00 to 60.00

\*RST:            0

Default unit: s

**Parameters for setting and query:**

<Channel list>            <list>

**Example:**

FUSE:DEL:INIT? (@1)

Queries initial fuse delay time at channel 1.

**Example:**

For alternative command, see [Example "Configuring the over-current protection"](#) on page 129.

---

**FUSE:DELay[:BLOWing]** <delay>

**FUSE:DELay[:BLOWing]?** [<Channel list>]

Sets or queries delay time for the fuse to take effect.

**Parameters:**

<delay>                    <numeric value> | MIN | MINimum | MAX | MAXimum | <list>

**<numeric value>**

Numeric value for the linitial fuse delay.

**MIN | MINimum**

Min value for linitial fuse delay.

**MAX | MAXimum**

Max value for linitial fuse delay.

Range:            0.00 to 10.00

\*RST:            0

Default unit: s

**Parameters for setting and query:**

<Channel list>            <list>

**Example:**

FUSE:DEL? (@1)

Queries fuse delay time at channel 1.

**Example:**

For alternative command, see [Example "Configuring the over-current protection"](#) on page 129.



---

**FUSE:LINK** <arg0>

**FUSE:LINK?** <arg0>

Sets or queries the fuses of several selected channels (fuse linking).

**Parameters for setting and query:**

<arg0>                    1 | 2

**Example:**

INST OUT1; :FUSE:LINK 2

Channel 2 is linked with channel 1

INST OUT1; :FUSE:LINK?2

Return 1 if channel 1 is linked with channel 2

**Example:**

For alternative command, See [Example "Configuring the over-current protection"](#) on page 129.

---

**FUSE:TRIPped?** [<Channel list>]

Queries the status if fuse has tripped in the selected channel.

**Parameters:**

<Channel list>            <list>

**Example:**

FUSE:TRIP? (@1)

Queries fuse tripped status at channel 1.

**Example:**

For alternative command, see [Example "Configuring the over-current protection"](#) on page 129

**Usage:**

Query only

---

**FUSE:UNLink** <channel>

Dissolves linked fuses.

**Parameters:**

<channel>                    1 | 2

**Example:**

For alternative command, see [Example "Configuring the over-current protection"](#) on page 129

**Usage:**

Setting only

---

**FUSE[:STATe]** <state>

**FUSE[:STATe]?** [<Channel list>]

Sets or queries the fuse function in the selected channel.

**Parameters:**

<state>                    **1**  
                                  Fuse function is activated.  
                                  **0**  
                                  Fuse function is not activated.

**Parameters for setting and query:**

<Channel list>      <list>

**Example:**            FUSE? (@1)  
Queries fuse state at channel 1.

**Example:**            For alternative command, see [Example "Configuring the over-current protection"](#) on page 129

### 7.5.10 OVP Setting

The `VOLTage:PROTection` subsystem contains the commands for setting the over-voltage protection parameters for the output channels. The default unit is V.

**Example: Configuring the overvoltage protection**

```

// *****
// Set the overvoltage protection value
// *****
INST OUT1
//activates the OVP of the previous selected channel
VOLT:PROT 1
// selects a channel and sets the OVP
VOLT:PROT:LEV 5
// queries the output overvoltage value of a channel
VOLT:PROT:LEV?
// response: 5
// queries the OVP state of the previous selected channel
VOLT:PROT?
// response: 1
// sets the overvoltage protection to maximum,
// or minimum respectively
VOLT:PROT:LEV MAX
VOLT:PROT:LEV MIN
// *****
// Query the range of the overvoltage protection values
// *****
// queries the upper and lower limit
VOLT:PROT:LEV? MIN
// response: 0.001
VOLT:PROT:LEV? MAX
// response: 20.050
// *****
// Query a tripped overvoltage protection
// *****
INST OUT1
// queries whether the OVP in channel 1 has tripped
VOLT:PROT:TRIP?
// response: 1 OVP is tripped
// response: 0 OVP is not tripped
// resets a tripped OVP in the selected channel
VOLT:PROT:CLEAr
// *****
// Set the overvoltage protection mode
// *****
INST OUT1
// sets OVP protected mode for channel 1
VOLT:PROT:MODE PROT
// queries the OVP mode
VOLT:PROT:MODE PROT?
// response: "protected"

```

[SOURce:]VOLTage:PROTection[:STATe].....	138
[SOURce:]VOLTage:PROTection:CLEar.....	138
[SOURce:]VOLTage:PROTection:LEVel.....	138
[SOURce:]VOLTage:PROTection:TRIPped?.....	139

---

**[SOURce:]VOLTage:PROTection[:STATe] <state>**  
**[SOURce:]VOLTage:PROTection[:STATe]? [<Channel list>]**

Sets or queries the OVP state of the previous selected channel.

**Parameters:**

<state>                    **0**  
                               OPP is deactivated  
                               **1**  
                               OPP is activated

**Parameters for setting and query:**

<Channel list>        <list>

**Example:**                VOLT:PROT? (@1)  
                               Queries OVP state at channel 1.

**Example:**                See [Example "Configuring the overvoltage protection"](#)  
                               on page 137.

---

**[SOURce:]VOLTage:PROTection:CLEar [<Channel list>]**

Resets the OVP state of the selected channel. If an OVP event has occurred before, the reset also erases the message on the display.

**Setting parameters:**

<Channel list>        <list>

**Example:**                VOLT:PROT:CLEAR (@1)  
                               Resets OVP state at channel 1.

**Example:**                See [Example "Configuring the overvoltage protection"](#)  
                               on page 137.

**Usage:**                    Setting only

---

**[SOURce:]VOLTage:PROTection:LEVel <voltage>**  
**[SOURce:]VOLTage:PROTection:LEVel? [<Channel list>]**

Sets or queries the overvoltage protection value of the selected channel.

**Parameters:**

<voltage>                <numeric value> | MIN | MINimum | MAX | MAXimum | DEF |  
                               DEFault | <list>  
                               **<numeric value>**  
                               Numeric value for the overvoltage protection value in V.  
                               **MIN | MINimum**  
                               Minimum value for the overvoltage protection value at 0.001 V.

**MAX | MAXimum**

Maximum value for the overvoltage protection value at 20.05 V.

**DEF | DEFault**

Default value of the overvoltage protection level at 20.05 V.

Range: 0.001 to 20.05

\*RST: 20.05

Default unit: V

**Parameters for setting and query:**

<Channel list> <list>

**Example:**

VOLT:PROT:LEV? (@1)

Queries overvoltage protection value at channel 1.

**Example:**

See [Example "Configuring the overvoltage protection"](#) on page 137.

**[SOURce:]VOLTage:PROTection:TRIPped? [<Channel list>]**

Queries the OVP state of the selected channel.

**Parameters:**

<Channel list> <list>

**Example:**

VOLT:PROT:TRIP?

Response 1, the OVP is tripped.

Response 0, the OVP is not tripped.

**Example:**

VOLT:PROT:TRIP? (@1)

Queries OVP state at channel 1.

**Example:**

See [Example "Configuring the overvoltage protection"](#) on page 137.

**Usage:**

Query only

### 7.5.11 OPP Setting

The POWer:PROTection subsystem contains the commands for setting the over-power protection parameters for the output channels. The default unit is W.

**Example: Configuring the overpower protection**

```
// *****
// Set the overpower protection value
// *****
INST OUT1
//activates the OPP of the previous selected channel
POW:PROT 1
// selects a channel and sets the OPP
POW:PROT:LEV 5
// queries the output overvoltage value of a channel
POW:PROT:LEV?
// response: 5
// queries the OPP state of the previous selected channel
POW:PROT?
// response: 1
// sets the overvoltage protection to maximum,
// or minimum respectively
POW:PROT:LEV MAX
POW:PROT:LEV MIN
// *****
// Query the range of the overpower protection values
// *****
// queries the upper and lower limit
POW:PROT:LEV? MIN
// reponse: 0.0
POW:PROT:LEV? MAX
// reponse: 6.535050E+01
// *****
// Query a tripped overpower protection
// *****
INST OUT1
// queries whether the OPP in channel 1 has tripped
POW:PROT:TRIP?
// response: 1 OPP is tripped
// response: 0 OPP is not tripped
// resets a tripped OPP in the selected channel
POW:PROT:CLEAr
```

[SOURce:]POWer:PROTection[:STATe].....	140
[SOURce:]POWer:PROTection:CLEAr.....	141
[SOURce:]POWer:PROTection:LEVel.....	141
[SOURce:]POWer:PROTection:TRIPped?.....	142

---

**[SOURce:]POWer:PROTection[:STATe] <state>**  
**[SOURce:]POWer:PROTection[:STATe]? [<Channel list>]**

Sets or queries the OPP state of the previous selected channel.

**Parameters:**

<state>

**0**  
OPP is deactivated

**1**  
OPP is activated

**Parameters for setting and query:**

<Channel list>      <list>

**Example:**            POW:PROT? (@1)  
Queries OPP state at channel 1.

**Example:**            See [Example "Configuring the overpower protection"](#)  
on page 140.

**[SOURce:]POWER:PROTection:CLEar** [<Channel list>]

Resets the OPP state of the selected channel. If an OPP event has occurred before, the reset also erases the message on the display.

**Setting parameters:**

<Channel list>      <list>

**Example:**            POW:PROT:CLE (@1)  
Resets OPP state at channel 1.

**Example:**            See [Example "Configuring the overpower protection"](#)  
on page 140.

**Usage:**              Setting only

**[SOURce:]POWER:PROTection:LEVel** <power>  
**[SOURce:]POWER:PROTection:LEVel?** [<Channel list>]

Sets or queries the overvoltage protection value of the selected channel.

**Parameters:**

<power>              <numeric value> | MIN | MINimum | MAX | MAXimum | DEF |  
DEFault | <list>

**<numeric value>**

Numeric value of the power protection level in watts.

**MIN | MINimum**

Minimum value of the power protection level at 0.00 W.

**MAX | MAXimum**

Maximum value of the power protection level at 6.535050E+01 W.

**DEF | DEFault**

Default value of the power protection level at 6.535050E+01 W.

Range:              0.00 to 6.535050E+01

\*RST:              6.535050E+01

Default unit: W

**Parameters for setting and query:**

&lt;Channel list&gt; &lt;list&gt;

**Example:** POW:PROT:LEV? (@1)  
Queries OPP value at channel 1.

**[SOURce:]POWER:PROTection:TRIPped? [<Channel list>]**

Queries the OPP state of the selected channel.

**Parameters:**

&lt;Channel list&gt; &lt;list&gt;

**Example:** POW:PROT:TRIP?  
Response 1, the OPP is tripped.  
Response 0, the OPP is not tripped.

**Example:** POW:PROT:TRIP? (@1)  
Queries OPP state at channel 1.

**Example:** See [Example "Configuring the overvoltage protection"](#) on page 137.

**Usage:** Query only

## 7.5.12 USB Class Setting

The `InterFace` subsystem contains the commands for changes made on the USB class.

**INTerfaces:USB:CLASs <arg0>**

Sets or queries the USB class.

**Parameters:**

<arg0> CDC | TMC  
**CDC**  
USB CDC connection.  
**TMC**  
USB TMC connection.

## 7.6 Measurement Commands

The `MEASure` subsystem provides commands to query the voltage and current values of a channel.

<a href="#">MEASure[:SCALar]:ENERgy?</a> .....	143
<a href="#">MEASure[:SCALar]:ENERgy:RESet</a> .....	143
<a href="#">MEASure[:SCALar]:ENERgy:STATe</a> .....	144
<a href="#">MEASure[:SCALar]:ENERgy:UNIT</a> .....	144



MEASure[:SCALar]:STATistic:COUNT?	144
MEASure[:SCALar]:STATistic:RESet	145
MEASure[:SCALar]:STATistic:RESet	145
MEASure[:SCALar]:CURRent[:DC]?	145
MEASure[:SCALar]:CURRent[:DC]:AVG?	145
MEASure[:SCALar]:CURRent[:DC]:MAX?	145
MEASure[:SCALar]:CURRent[:DC]:MIN?	145
MEASure[:SCALar]:CURRent[:DC]:STATistic?	146
MEASure[:SCALar]:POWer?	146
MEASure[:SCALar]:POWer:AVG?	146
MEASure[:SCALar][:POWer]:AVG?	146
MEASure[:SCALar]:POWer:MAX?	146
MEASure[:SCALar][:POWer]:MAX?	146
MEASure[:SCALar]:POWer:MIN?	147
MEASure[:SCALar][:POWer]:MIN?	147
MEASure[:SCALar]:POWer:STATistic?	147
MEASure[:SCALar]:VOLTage[:DC]?	147
MEASure[:SCALar]:VOLTage[:DC]:AVG?	147
MEASure[:SCALar]:VOLTage[:DC]:MAX?	147
MEASure[:SCALar]:VOLTage[:DC]:MIN?	148
MEASure[:SCALar]:VOLTage[:DC]:STATistic?	148
MEASure:VOLTage:DVM?	148

---

#### MEASure[:SCALar]:ENERgy? [<Channel list>]

Queries the measured accumulated energy value of the previous selected channel.

##### Parameters:

<Channel list>            <list>

**Example:**                MEAS:ENER? -> 5.382E+00 (value in Wh)

**Example:**                MEAS:ENER? (@1)  
Queries the measured accumulated energy value at channel 1.

**Usage:**                    Query only

---

#### MEASure[:SCALar]:ENERgy:RESet [<Channel list>]

Resets the energy counter for the selected channel.

##### Parameters:

<Channel list>            <list>

**Example:**                MEAS:ENER:RES (@1)  
Resets the energy counter at channel 1.

**Usage:**                    Setting only

---

**MEASure[:SCALar]:ENERgy:STATe <state>**

**MEASure[:SCALar]:ENERgy:STATe? [<Channel list>]**

Sets or queries the energy counter state for the selected channel.

**Parameters:**

**<state>**                     **1**  
 Activates the energy counter.

**0**  
 Deactivates the energy counter.

**Parameters for setting and query:**

**<Channel list>**           **<list>**

**Example:**                   INST OUT1  
 MEAS:ENER:STAT ON  
 MEAS:ENER:STAT?  
 MEAS:ENER:STAT? -> 1  
 Energy counter of Ch1 is enabled.

**Example:**                   MEAS:ENER:STAT? (@1)  
 Queries the energy counter state at channel 1.

---

**MEASure[:SCALar]:ENERgy:UNIT <arg0>**

**MEASure[:SCALar]:ENERgy:UNIT?**

Sets or queries the measured unit for energy.

**Setting parameters:**

**<arg0>**                     WS | WH

**WS**  
 Energy express as Watt per second.

**WH**  
 Energy express as Watt per hour.

**Example:**                   MEAS:ENER:UNIT WH

---

**MEASure[:SCALar]:STATistic:COUNt? [<Channel list>]**

Queries the number of measurements.

**Parameters:**

**<Channel list>**           **<list>**

**Example:**                   MEAS:STAT:COUN? (@1)  
 Queries the number of measurements at channel 1.

**Usage:**                     Query only

---

**MEASure[:SCALar]:STATistic:RESet** [<Channel list>]**MEASure[:SCALar]:STATistic:RESet**

Resets the minimum, maximum and average statistics values for voltage, current, and power.

Additionally this command resets the measured energy.

**Example:**                    `MEAS:STAT:RES (@1)`  
Resets all the statistic values at channel 1.

---

**MEASure[:SCALar]:CURRent[:DC]?** [<Channel list>]

Queries the currently measured current of the selected channel.

**Parameters:**

<Channel list>            <list>

**Example:**                    `MEAS:CURR? -> 1.000E +00`

**Example:**                    `MEAS:CURR? (@1)`  
Queries the currently measured current at channel 1.

**Usage:**                      Query only

---

**MEASure[:SCALar]:CURRent[:DC]:AVG?** [<Channel list>]

Queries the average measured output current.

**Parameters:**

<Channel list>            <list>

**Example:**                    `MEAS:CURR:DC:AVG? (@1)`  
Queries the average measured output current at channel 1.

**Usage:**                      Query only

---

**MEASure[:SCALar]:CURRent[:DC]:MAX?** [<Channel list>]

Queries the maximum measured output current.

**Parameters:**

<Channel list>            <list>

**Example:**                    `MEAS:CURR:DC:MAX? (@1)`  
Queries the madimum measured output current at channel 1.

**Usage:**                      Query only

---

**MEASure[:SCALar]:CURRent[:DC]:MIN?** [<Channel list>]

Queries the minimum measured output current.

**Parameters:**

<Channel list>            <list>

**Example:** MEAS:CURR:DC:MIN? (@1)  
Queries the minimum measured output current at channel 1.

**Usage:** Query only

**MEASure[:SCALar]:CURRent[:DC]:STATistic? [<Channel list>]**

Queries the current statistics of the selected channel.

**Parameters:**

<Channel list> <list>

**Example:** INST:NSEL 1  
MEAS:CURR:DC:STAT?  
Queries the current statistics at channel 1.

**Example:** MEAS:CURR:DC:STAT? (@1)  
Queries the current statistics at channel 1.

**Usage:** Query only

**MEASure[:SCALar]:POWER? [<Channel list>]**

Queries the currently emitted power of the selected channel.

**Parameters:**

<Channel list> <list>

**Example:** MEAS:POW? -> 3.00E+00

**Example:** MEAS:POW? (@1)  
Queries the currently supplied power at channel 1.

**Usage:** Query only

**MEASure[:SCALar]:POWER:AVG? [<Channel list>]**

**MEASure[:SCALar][:POWER]:AVG?**

Queries the average measured output power.

**Example:** MEAS:POW:AVG? (@1)  
Queries the average measured output power at channel 1.

**Usage:** Query only

**MEASure[:SCALar]:POWER:MAX? [<Channel list>]**

**MEASure[:SCALar][:POWER]:MAX?**

Queries the maximum measured output power.

**Example:** MEAS:POW:MAX? (@1)  
Queries the maximum measured output power at channel 1.

**Usage:** Query only

---

**MEASure[:SCALar]:POWer:MIN?** [<Channel list>]**MEASure[:SCALar][:POWer]:MIN?**

Queries the minimum measured output power.

**Example:**                   MEAS:POW:MIN? (@1)  
Queries the minimum measured output power at channel 1.

**Usage:**                    Query only

---

**MEASure[:SCALar]:POWer:STATistic?** [<Channel list>]

Queries the power statistics of the selected channel.

**Parameters:**

<Channel list>            <list>

**Example:**                   INST:NSEL 1  
MEAS:CURR:DC:STAT?  
Queries the power statistics at channel 1.

**Example:**                   MEAS:POW:STAT? (@1)  
Queries the power statistics at channel 1.

**Usage:**                    Query only

---

**MEASure[:SCALar][:VOLTage][:DC]?** [<Channel list>]

Queries the currently measured voltage of the selected channel.

**Parameters:**

<Channel list>            <list>

**Example:**                   MEAS:VOLT? -> 1.000E+00

**Example:**                   MEAS:VOLT? (@1)  
Queries the currently measured voltage at channel 1.

**Usage:**                    Query only

---

**MEASure[:SCALar][:VOLTage][:DC]:AVG?** [<Channel list>]

Queries the average measured output voltage.

**Parameters:**

<Channel list>            <list>

**Example:**                   MEAS:VOLT:AVG? (@1)  
Queries the average measured output voltage at channel 1.

**Usage:**                    Query only

---

**MEASure[:SCALar][:VOLTage][:DC]:MAX?** [<Channel list>]

Queries the maximum measured output voltage.

**Parameters:**

&lt;Channel list&gt; &lt;list&gt;

**Example:**

MEAS:VOLT:MAX? (@1)

Queries the maximum measured output voltage at channel 1.

**Usage:**

Query only

**MEASure[:SCALar][:VOLTage][:DC]:MIN? [<Channel list>]**

Queries the minimum measured output voltage.

**Parameters:**

&lt;Channel list&gt; &lt;list&gt;

**Example:**

MEAS:VOLT:MIN? (@1)

Queries the minimum measured output voltage at channel 1.

**Usage:**

Query only

**MEASure[:SCALar][:VOLTage][:DC]:STATistic? [<Channel list>]**

Queries the voltage statistics of the selected channel.

**Parameters:**

&lt;Channel list&gt; &lt;list&gt;

**Example:**

INST:NSEL 1

MEAS:STAT?

Queries the voltage statistics at channel 1.

**Example:**

MEAS:VOLT:STAT? (@1)

Queries the voltage statistics at channel 1.

**Usage:**

Query only

**MEASure:VOLTage:DVM? [<Channel list>]**

Queries the voltmeter measurement (if DVM is enabled).

The DVM is available only with R&S NGM power supply series equipped with R&S NGM-K104 (P/N: 3643.9927.02).

**Query parameters:**

&lt;Channel list&gt; &lt;list&gt;

**Example:**

MEAS:VOLT:DVM? -&gt; 3.00E+00

**Example:**

MEAS:VOLT:DVM? (@1)

Queries the voltmeter measurement at channel 1.

**Usage:**

Query only

## 7.7 Advanced Operating Commands

The following shows the subsystem that contains the commands for configuring the arbitrary function, ramp and Digital I/O function.

### 7.7.1 Arbitrary

The `ARBitrary` subsystem contains the commands for configuring an arbitrary sequence for the output channels.

**Example: Configuring an arbitrary sequence**

This programming example generates an arbitrary sequence for a selected channel. The sequence starts at 1 V and 1 A for 1 sec, and both values are incremented each second by 1. The generated arbitrary waveform is transferred to Ch1. When activated, the R&S NGL/NGM provides the arbitrary waveform at the output of the selected channel, and repeats it 10 times.

```
// *****
// Define and start the arbitrary sequence
// *****
// selects channel 1
INST OUT1
// defines the sequence, i.e. starting at 1V, 1A for 1sec,
// and increments the voltage and current each second by 1
ARB:DATA 1,1,1,0,2,2,1,0,3,3,1,0
// sets the repetition rate
ARB:REP 10
// ARB:REP? queries the set number of repetitions
//sets the arbitrary endpoint behavior, when the arbitrary function is finished
ARB:BEH:END HOLD
//ARB:BEH:END? queries the arbitrary endpoint behavior
// transfers the arbitrary points to channel
ARB:TRAN 1
//Enable the arbitrary sequence
ARB 1
// starts the sequence in channel 1
// ARB 0 stops the sequence in the selected channel
//turns on the output
OUTP ON
// *****
// Save and recall an arbitrary sequence
// *****
//sets the filename "01.CSV" and storage location for arbitrary function
ARB:FNAM "01.CSV", INT
// saves the sequence into the internal memory
ARB:SAVE
// loads a previously saved sequence from the internal memory
ARB:LOAD
INST OUT1
// clears the arbitrary table data for the selected channel
ARB:CLEAR
```

ARbitrary[:STATe].....	151
ARbitrary:BEHavior:END.....	151
ARbitrary:CLEar.....	152
ARbitrary:DATA.....	152
ARbitrary:FNAME.....	152
ARbitrary:LOAD.....	153
ARbitrary:REPetitions.....	153
ARbitrary:RESTore.....	153



ARbitrary:SAVE.....	153
ARbitrary:START.....	154
ARbitrary:STOP.....	154
ARbitrary:TRANsfer.....	154
ARbitrary:TRIGgered:MODE.....	154
ARbitrary:TRIGgered[:STATe].....	155

---

**ARbitrary[:STATe]** <state>

**ARbitrary[:STATe]?** [<Channel list>]

Sets or queries the arbitrary function for the previous selected channel.

**Parameters:**

<state>                    **1**  
 Arbitrary function is activated.

**0**  
 Arbitrary function is deactivated.

\*RST:                    0

**Parameters for setting and query:**

<Channel list>            <list>

**Example:**                ARB ON  
 ARB? -> 1  
 Arbitrary function of Ch1 is activated.

**Example:**                ARB ON, (@1)  
 ARB? (@1)  
 Sets and queries the state of arbitrary function at channel 1.

**Example:**                See [Example "Configuring an arbitrary sequence"](#) on page 150.

---

**ARbitrary:BEHavior:END** <state>

**ARbitrary:BEHavior:END?**

Sets or queries the arbitrary endpoint behavior, when arbitrary function is finished.

**Parameters:**

<state>                    HOLD | OFF

**OFF**  
 If the arbitrary function is finished, the respective channel is deactivated automatically.

**HOLD**  
 If the arbitrary function is finished, the last arbitrary point of the user-defined arbitrary list is held.

\*RST:                    OFF

**Example:**                See [Example "Configuring an arbitrary sequence"](#) on page 150.

---

**ARbitrary:CLEar**

Clears the current arbitrary table data for the selected channel.

**Example:** See [Example "Configuring an arbitrary sequence"](#) on page 150.

**Usage:** Event

---

**ARbitrary:DATA <data>**

Sets or queries the arbitrary points for the previous selected channel. Max. 4096 arbitrary points can be defined. The dwell time between 2 arbitrary points is specified from 1 ms to 20 days.

**Parameters:**

<data> voltage1, current1, time1, interpolation mode1, voltage2, current2, time2, interpolation mode2, ...

Voltage and current settings depending on the instrument type. If the interpolation mode is sets to 1, it indicates that the mode is activated. If the interpolation mode is sets to 0, it indicates that the mode is not activated.

**Example:**

```
INST OUT1
```

```
ARB:DATA 10,1,0.5,0
```

Defines one arbitrary point with: Voltage1 = 10 V and Current1 = 1 A, Time1 = 500 ms and Interpolation mode1 = 0 (disabled).

```
ARB:DATA? -> 10.000, 1.000, 0.50, 1
```

Returns defined arbitrary points for the previous selected channel.

**Example:** See [Example "Configuring an arbitrary sequence"](#) on page 150.

---

**ARbitrary:FNAME <filename>[,<location>]****ARbitrary:FNAME? [<location>]**

Sets or queries the file name and storage location for the arbitrary function.

**Parameters for setting and query:**

<filename> Filename of the arbitrary function.

<location> INT | EXT | DEF

**INT**

Internal memory

**EXT**

USB stick

**DEF**

Internal memory

**Example:**

```
ARB:FNAME "01.CSV"
```

```
ARB:FNAME? INT -> "01.CSV"
```

---

**ARbitrary:LOAD**

Loads an arbitrary table from a file (filename specified with `ARB:FNAME`)

**Example:**

```

INST OUT1
ARB:DATA 10,1,0.5,0
ARB:REP 10
ARB:FNAME "ARB03.CSV",INT
ARB:SAVE
ARB:LOAD

```

Loads an arbitrary data from filename `ARB03.CSV`.

**Usage:** Event

---

**ARbitrary:REPetitions <repetition\_rate>****ARbitrary:REPetitions?**

Sets or queries the repetition rate of the defined arbitrary waveform for the previous selected channel. Up to 65535 repetitions are possible. If the repetition rate „0“ is selected the arbitrary waveform of the previous selected channel is repeated infinitely.

**Parameters:**

repetition\_rate      Range:      0 to 65535  
The "0" indicates infinite repetition.

**Example:**

```

INST OUT1
ARB:REP 10
ARB:REP? -> 10

```

The returned repetition rate of the Ch1 arbitrary waveform is 10.

---

**ARbitrary:REStore**

Loads an arbitrary table from a file (filename specified with `ARB:FNAME`)

**Example:**

```

INST OUT1
ARB:DATA 10,1,0.5,0
ARB:REP 10
ARB:FNAME "ARB03.CSV",INT
ARB:SAVE
ARB:REST

```

Restores an arbitrary data from filename `ARB03.CSV`.

**Usage:** Event

---

**ARbitrary:SAVE**

Saves the current arbitrary table to a file (filename specified with `ARB:FNAME`).

**Example:**

```
INST OUT1
ARB:DATA 10,1,0.5,0
ARB:REP 10
ARB:FNAM "ARB03.CSV",INT
ARB:SAVE
```

Saves a predefined arbitrary data to a filename ARB03.CSV in the internal memory location.

**Usage:** Event

### ARbitrary:START

Enables arbitrary for selected channel.

Command is same as `ARB:STAT 1`.

**Usage:** Event

See [Example "Configuring an arbitrary sequence"](#) on page 150.

### ARbitrary:STOP

Disables arbitrary for selected channel.

Command is same as `ARB:STAT 0`.

**Usage:** Event

See [Example "Configuring an arbitrary sequence"](#) on page 150.

### ARbitrary:TRANSfer <channel>

Transfers the defined arbitrary table to the selected channel.

**Parameters:**

<channel> 1 | 2

**Example:** See [Example "Configuring an arbitrary sequence"](#) on page 150.

**Usage:** Setting only

### ARbitrary:TRIGgered:MODE <mode>

#### ARbitrary:TRIGgered:MODE?

Sets or queries the arbitrary trigger mode of the previous selected channel.

**Parameters:**

<mode> SINGLE | RUN

**SINGLE**

A trigger event starts only with one arbitrary sequence.

**RUN**

A trigger event starts the whole arbitrary sequences (with all repetitions).

---

**ARbitrary:TRIGgered[:STATe] <state>**  
**ARbitrary:TRIGgered[:STATe]?**

Sets or queries the arbitrary trigger mode.

**Parameters:**

<state>                    **0**  
                                  OFF - Trigger input is deactivated.  
                                  **1**  
                                  ON - Trigger input is activated.

**Example:**

```
INST OUT1
ARB:TRIG ON
ARB:TRIG? -> 1
Activates the Ch1 trigger mode for arbitrary function.
```

## 7.7.2 Ramp

The `VOLTage:RAMP` subsystem contains the commands for configuring the ramp function for the output channels.

[SOURce:]VOLTage:RAMP[:STATe]..... 155  
 [SOURce:]VOLTage:RAMP:DURation..... 156

---

**[SOURce:]VOLTage:RAMP[:STATe] <state>**  
**[SOURce:]VOLTage:RAMP[:STATe]? [<Channel list>]**

Sets or queries the state of ramp function for the previous selected channel.

**Parameters:**

<state>                    **0**  
                                  EasyRamp function is deactivated.  
                                  **1**  
                                  EasyRamp function is activated.  
                                  \*RST:        0

**Parameters for setting and query:**

<Channel list>        <list>

**Example:**

```
INST OUT1
VOLT:RAMP ON
VOLT:RAMP? -> 1
EasyRamp function of Ch1 is activated
```

**Example:**

```
VOLT:RAMP ON, (@1)
VOLT:RAMP? (@1)
Sets and queries the state of ramp function at channel 1.
```

**[SOURce:]VOLTage:RAMP:DURation <duration>**  
**[SOURce:]VOLTage:RAMP:DURation? [<Channel list>]**

Sets or queries the duration of the voltage ramp.

**Parameters:**

<duration>                    <numeric value> | MIN | MINimum | MAX | MAXimum | DEF | DEFault | <list>

**<numeric value>**

Duration of the ramp function in seconds.

**MIN | MINimum**

Minimum duration of the ramp function at 0.00 s.

**MAX | MAXimum**

Minimum duration of the ramp function at 10 s.

**DEF | DEFault**

Default duration of the ramp function at 0.01 s.

Range:            0.01 to 10.00

\*RST:            0.01

Default unit: s

**Parameters for setting and query:**

<Channel list>            <list>

**Example:**

VOLT:RAMP:DUR 4

VOLT:RAMP:DUR? -> 4

Duration of the ramp function is set at 4 s.

**Example:**

VOLT:RAMP:DUR 4, (@1)

VOLT:RAMP:DUR? (@1)

Sets and queries the duration of ramp function at channel 1.

### 7.7.3 Digital I/O

The DIO subsystem contains the commands for configuring a Digital I/O function for the output channels.

DIO:FAULt:CHANnel.....	156
DIO:FAULt:SOURce.....	157
DIO:FAULt[:STATe].....	157
DIO:FAULt:SIGNal.....	158
DIO:OUTPut:SOURce.....	158
DIO:OUTPut[:STATe].....	158
DIO:OUTPut:SIGNal.....	159

**DIO:FAULt:CHANnel <arg0>**

**DIO:FAULt:CHANnel?**

Sets or queries channel selection for the digital output fault source.

See "operation modes" in [Figure 6-18](#).

**Parameters:**

<arg0>                   OUT1 | OUTP1 | OUTPut1 | OUT2 | OUTP2 | OUTPut2 | ANY  
**OUT1 | OUTP1 | OUTPut1**  
 Ch1 is selected as the device channel for digital output fault source.  
**OUT2 | OUTP2 | OUTPut2**  
 Ch2 is selected as the device channel for digital output fault source.  
**ANY**  
 Any of the available channel which meets the condition sets as the digital output fault source.

**Example:**

DIO:FAUL:CHAN 1  
 Sets channel 1 as the output fault source.

**DIO:FAULt:SOURce** <arg0>  
**DIO:FAULt:SOURce?**

Sets or queries the "operation modes" of the digital output fault source

See "operation modes" in [Figure 6-18](#).

**Parameters:**

<arg0>                   CC | CV | CR | SINK | PROTection | OUTPut  
 If "OUTPut" is selected, the "fault output" will be active if the output of the selected channel is off.

**Example:**

DIO:FAUL:SOUR PROT  
 Sets the "operation modes" of the digital output fault source as protection. If any of the protection modes (OCP, OCP, PPP, OTP and Sense) of the digital output fault source is active, a trigger event is triggered to the trigger-out signals on the instrument.

**DIO:FAULt[:STATe]** <arg0>  
**DIO:FAULt[:STATe]?**

Sets or queries the digital output fault.

See "operation modes" in [Figure 6-18](#)

**Parameters:**

<arg0>                   **1**  
 Enables digital output fault.  
**0**  
 Disables digital output fault.

**Example:**

DIO:FAUL 1  
 Enables the digital output fault.

---

**DIO:FAULt:SIGNal** <arg0>

Select digital output fault signal type.

**Parameters:**

<arg0>                    CONStant | PULSe

**CONStant**

An constant level trigger signal is sent out

**PULSe**

An output pulse of 100 ms trigger signal is sent out

---

**DIO:OUTPut:SOURce** <arg0>, <arg1>**DIO:OUTPut:SOURce?** <arg0>

Sets or queries the digital output source.

See "operation modes" in [Figure 6-18](#).

**Parameters:**

<arg1>                    OUTPut | TRIGger | FORCed

**OUTPut**

Selected channel output is used as the digital output source.

**TRIGger**

Selected channel external trigger signal is used as the digital output source.

**FORCed**

Selected output is forced to high level and can be switched by [DIO:OUTPut\[:STATe\]](#) on page 158 command.

---

**Parameters for setting and query:**

<arg0>                    1 | 2

Channel selection for the digital output source.

**Example:**

```
DIO:OUTP:SOUR 1, OUTP
```

Channel 1 output is used as the digital output source.

**Example:**

```
DIO:OUTPut 1,0
```

```
DIO:OUTPut:SOURce 1, FORC
```

```
DIO:OUTPut 1,1
```

Digital I/O pin OUT1 is set to a "high" level

---

**DIO:OUTPut[:STATe]** <arg0>, <arg1>**DIO:OUTPut[:STATe]?** <arg0>

Sets or queries the digital output channel selection.

**Parameters:**

<arg1>                    1 | 0

Enables or disables the digital output state.



**Parameters for setting and query:**

<arg0>                    **1 | 2**  
Channel selection for the digital output source.

**Example:**                `DIO:OUTP 1, 1`  
Enables channel 1 as the digital output source.

**DIO:OUTPut:SIGNal** <arg0>, <arg1>

**DIO:OUTPut:SIGNal?** <arg0>

Select digital output signal type.

**Parameters:**

<arg1>                    **CONStant | PULSe**

**CONStant**

An constant level trigger signal is sent out

**PULSe**

An output pulse of 100 ms trigger signal is sent out

**Parameters for setting and query:**

<arg0>                    Channel number.

**Example:**                `DIO:OUTP:SIGN? 1`  
Returns signal type at digital output for channel 1.

## 7.7.4 Battery Simulation



Available only with R&S NGM power supply series.

The `BATT` subsystem contains the commands for configuring the battery simulator and battery model function for the output channels.

<code>BATTery:SIMulator:CAPacity?</code> .....	160
<code>BATTery:SIMulator:CAPacity:LIMit</code> .....	160
<code>BATTery:SIMulator:CURRent?</code> .....	160
<code>BATTery:SIMulator:CURRent:LIMit?</code> .....	160
<code>BATTery:SIMulator:CURRent:LIMit:EOC</code> .....	161
<code>BATTery:SIMulator:CURRent:LIMit:EOD</code> .....	161
<code>BATTery:SIMulator:CURRent:LIMit:REGular</code> .....	161
<code>BATTery:SIMulator:RESistance?</code> .....	161
<code>BATTery:SIMulator:SOC</code> .....	161
<code>BATTery:SIMulator:TVOLTage?</code> .....	162
<code>BATTery:SIMulator:VOC?</code> .....	162
<code>BATTery:SIMulator:VOC:EMPTY?</code> .....	162
<code>BATTery:SIMulator:VOC:FULL?</code> .....	162
<code>BATTery:SIMulator[:ENABLE]</code> .....	163
<code>BATTery:STATus?</code> .....	163
<code>BATTery:MODEL:CURRent:LIMit:EOC</code> .....	163

BATTeRy:MODeL:CURReNt:LIMit:EOD.....	164
BATTeRy:MODeL:CURReNt:LIMit:REGular.....	164
BATTeRy:MODeL:CAPacity.....	164
BATTeRy:MODeL:CLEar.....	164
BATTeRy:MODeL:DATA.....	164
BATTeRy:MODeL:FNAME.....	165
BATTeRy:MODeL:ISOC.....	165
BATTeRy:MODeL:LOAD.....	165
BATTeRy:MODeL:SAVE.....	166
BATTeRy:MODeL:TRANsfer.....	166

---

### BATTeRy:SIMulatoR:CAPacity?

Queries the remaining battery capacity from the specific channel.

**Example:**           INST:NSEL 1  
                   BATT:SIM:CAP?  
                   Return the remaining battery capacity for channel 1.

**Usage:**             Query only

---

### BATTeRy:SIMulatoR:CAPacity:LIMit <arg0> BATTeRy:SIMulatoR:CAPacity:LIMit?

Sets or queries the full battery capacity for the specific channel.

**Parameters:**

<arg0>               Defines the full battery capacity.

**Example:**           INST:NSEL 1  
                   BATT:SIM:CAP:LIM 100  
                   Defines 100 % full battery capacity for channel 1 battery simulator.

---

### BATTeRy:SIMulatoR:CURReNt?

Queries the current (A) of battery simulator from the specific channel.

**Example:**           INST:NSEL 1  
                   BATT:SIM:CURR?  
                   Returns current from channel 1 battery simulator.

**Usage:**             Query only

---

### BATTeRy:SIMulatoR:CURReNt:LIMit?

Queries the current limit from specific channel.

**Example:**           INST:NSEL 1  
                   BATT:SIM:CURR:LIM?  
                   Return channel 1 of battery simulator current limit.

**Usage:**             Query only

---

**BATTeRY:SIMuLator:CURRent:LIMit:EOC <arg0>**  
**BATTeRY:SIMuLator:CURRent:LIMit:EOC?**

Sets or queries the current limit at end-of-charge.

**Parameters:**

<arg0> Sets the current limit at end-of-charge.

**Example:**

INST:NSEL 1

BATT:SIM:CURR:LIM:EOC?

Returns current limit at end-of-charge for channel 1.

---

**BATTeRY:SIMuLator:CURRent:LIMit:EOD <arg0>**  
**BATTeRY:SIMuLator:CURRent:LIMit:EOD?**

Sets or queries the current limit at end-of-discharge.

**Parameters:**

<arg0> Sets the current limit at end-of-discharge.

**Example:**

INST:NSEL 1

BATT:SIM:CURR:LIM:EOD?

Returns current limit at end-of-discharge for channel 1.

---

**BATTeRY:SIMuLator:CURRent:LIMit:REGular <arg0>**  
**BATTeRY:SIMuLator:CURRent:LIMit:REGular?**

Sets or queries the current limit at regular charge level.

**Parameters:**

<arg0> Sets the current limit at regular charge level.

**Example:**

INST:NSEL 1

BATT:SIM:CURR:LIM:REG?

Returns current limit at regular charge level for channel 1.

---

**BATTeRY:SIMuLator:RESistance?**

Queries the battery simulator internal resistance (ESR).

**Example:**

INST:NSEL 1

BATT:SIMU:RES?

Queries channel 1 of battery simulator internal resistance.

**Usage:**

Query only

---

**BATTeRY:SIMuLator:SOC <arg0>**  
**BATTeRY:SIMuLator:SOC?**

Sets or queries the state of charge (SoC) of the battery simulator.

**Parameters:**

<arg0> Sets SoC values.

**Example:**

```
INST:NSEL 1
BATT1SIM:SOC 20
Sets the channel 1 Soc to 20 %.
```

---

**BATTery:SIMulator:TVOLTage?**

Queries the terminal voltage (Vt) of the specific channel.

**Example:**

```
INST:NSEL 1
BATT:SIM:TVOL?
Returns channel 1 terminal voltage of battery simulator.
```

**Usage:**

Query only

---

**BATTery:SIMulator:VOC?**

Queries the open circuit voltage (Voc) of the specific channel.

**Example:**

```
INST:NSEL 1
BATT:SIM:VOC?
Returns the channel 1 open circuit voltage of battery simulator.
```

**Usage:**

Query only

---

**BATTery:SIMulator:VOC:EMPTY?**

Queries the open circuit voltage (Voc) for empty SoC, i.e SoC = 0 %.

**Example:**

```
INST:NSEL 1
BATT:SIM:VOC:EMPT?
Returns the channel 1 Voc of an empty charge battery.
```

**Usage:**

Query only

---

**BATTery:SIMulator:VOC:FULL?**

Queries the open circuit voltage (Voc) for full SoC, i.e SoC = 100 %.

**Example:**

```
INST:NSEL 1
BATT:SIM:VOC:FULL?
Returns 1 if channel 1 battery simulator is fully charge.
```

**Usage:**

Query only

---

**BATTery:SIMulator[:ENABLE] <arg0>[, <Channel list>]**  
**BATTery:SIMulator[:ENABLE]? [<Channel list>]**

Sets or queries the specific channel of the battery simulator state.

**Parameters:**

<arg0>                    **1**  
                               Enables the battery simulator state.

**0**  
                               Disables the battery simulator state.

**Parameters for setting and query:**

<Channel list>        <list>

**Example:**                INST:NSEL 1  
                               BATT:SIM 1  
                               Enables the battery simulator state for channel 1.

**Example:**                BATT:SIM 1, (@1)  
                               Enables the battery simulator state at channel 1.

---

**BATTery:STATUS? [<Channel list>]**

Queries the status of the battery (idle, charging or discharging).

**Parameters:**

<Channel list>        <list>

**Example:**                INST:NSEL 1  
                               BATT:STAT?  
                               Returns the status of the battery simulator from channel 1.

**Example:**                BATT:STAT? (@1)  
                               Queries the status of battery simulator at channel 1.

**Usage:**                    Query only

---

**BATTery:MODEl:CURRent:LIMit:EOC <arg0>**  
**BATTery:MODEl:CURRent:LIMit:EOC?**

Sets or queries the current limit of the battery model at end-of-charge.

**Parameters:**

<arg0>                    Sets the current limit of the battery model at end-of-charge.

**Example:**                INST:NSEL 1  
                               BATT:MODEl:CURR:LIM:EOC?  
                               Returns current limit of the battery model at end-of-charge for channel 1.

---

**BATTeRY:MODeL:CURRent:LIMit:EOD <arg0>**  
**BATTeRY:MODeL:CURRent:LIMit:EOD?**

Sets or queries the current limit of the battery model at end-of-discharge.

**Parameters:**

<arg0> Sets the current limit of the battery model at end-of-discharge.

**Example:**

```
INST:NSEL 1
```

```
BATT:MODeL:CURR:LIM:EOD?
```

Returns current limit of the battery model at end-of-discharge for channel 1.

---

**BATTeRY:MODeL:CURRent:LIMit:REGular <arg0>**  
**BATTeRY:MODeL:CURRent:LIMit:REGular?**

Sets or queries the current limit of the battery model at regular charge level.

**Parameters:**

<arg0>

**Example:**

```
INST:NSEL 1
```

```
BATT:MODeL:CURR:LIM:REG?
```

Returns current limit of the battery model at regular charge level for channel 1.

---

**BATTeRY:MODeL:CAPacity <arg0>**  
**BATTeRY:MODeL:CAPacity?**

Sets or queries the battery model capacity.

**Parameters:**

<arg0> Sets the battery model capacity.

**Example:**

```
INST:NSEL 1
```

```
BATT:MODeL:CAP 50
```

Sets battery model storage capacity as 50 for channel 1.

---

**BATTeRY:MODeL:CLEar**

Clears the current battery model.

**Example:**

```
INST:NSEL 1
```

```
BATT:MOD:CLE
```

Clear the current battery model for channel 1.

**Usage:**

Event

---

**BATTeRY:MODeL:DATA {<arg0>, <arg1>, <arg2>}...**  
**BATTeRY:MODeL:DATA?**

Sets or queries the battery model data.

**Parameters:**

- <arg0> Sets the value for battery state of charge (SoC).  
 <arg1> Sets the value for battery open-circuit voltage (Voc).  
 <arg2> Sets the value for battery internal resistance (ESR).

**Example:** `BATT:MOD:DATA 0,0.0,2.0,100,5.0,2.0`

Sets the battery model data.

**BATTery:MODEl:FNAME** <Filename>[,<Partition>]

**BATTery:MODEl:FNAME?** <>[,<>]

Sets or queries a filename for the battery model.

**Parameters for setting and query:**

<Filename> Filename for the battery model.

<Partition> INT | EXT | DEF  
 Selects partition for file storage.

**INT**

Internal memory used for file storage

**EXT**

USB stick used for file storage

**DEF**

Default storage partition is set to internal memory.

**Example:** `BATT:MOD:FNAME "NewBattery.csv",INT`  
 Sets the battery model filename to "NewBattery.csv" (internal memory).

**BATTery:MODEl:ISOC** <State\_of\_charge>

**BATTery:MODEl:ISOC?**

Sets or queries the initial state of charge (SoC) of the battery model.

**Parameters:**

<State\_of\_charge> Initial state of charge (SoC) for the battery model.

**Example:** `INST:NSEL 1`  
`BATT:MOD:ISOC 50`  
 Initial state of charge is set to 50 % for channel 1.

**BATTery:MODEl:LOAD** <filename>

Loads a battery model for editing.

**Example:** `BATT:MOD:LOAD`  
 Loads the current battery model to a file.

**Usage:** Event

---

**BATTery:MODEl:SAVE**

Saves the current battery model to a file

**Example:**            `BATT:MOD:SAVE`  
Saves the current battery model to a file.

**Usage:**            Event

---

**BATTery:MODEl:TRANSfer <channel>**

Transfers the loaded battery model into the channel.

**Parameters:**

<channel>            1 | 2

**Example:**            `BATT:MOD:TRAN 1`  
Transfers the current battery model to a channel 1.

**Usage:**            Setting only

---

## 7.8 Data and File Management Commands



The `FLOG` subsystem is available only with R&S NGM power supply series.

The `DATA` and `HCOPY` subsystem contain commands for managing the files in the instrument and external USB stick.

The `LOG` and `FLOG` subsystem contain the commands for managing the data logging of the instrument.



**Example: Configuring fastlog for scpi target**

```
// *****
// Configuring fastlog for scpi target
// *****
*RST
:FLOG:STATE 0
:STATus:OPERation:ENABLE 8192 //EnableSummary = true, bit 13
:STATus:OPERation:PTRansition 8192 // Enable Positive Transition, Summary bit 13
:STATus:OPERation:NTRansition 0
:STATus:OPERation:INST:ENABLE 7
:STATus:OPERation:INST:PTRansition 7
:STATus:OPERation:INST:NTRansition 0
:STATus:OPERation:INST:ISUM1:ENABLE 4096 // FastLogDataAvailable bit 12
//Enable Positive Transition, FastLogDataAvailable bit 12
:STATus:OPERation:INST:ISUM1:PTRansition 4096
:STATus:OPERation:INST:ISUM1:NTRansition 0
// Clear event registers
:STATus:OPERation:EVENT?
:STATus:OPERation:INST:EVENT?
:STATus:OPERation:INST:ISUM1:EVENT?
:FLOG:TARGet SCPI
:FLOG:SRate S250k //initialize scpi target with sample rate 250 kS/s
*OPC?
:FLOG:STATE 1 // start fastlog
// receive data once 'FastLogDataAvailable' is available
Loop
    StatusByte = *STB?
    if (StatusByte.IsOPERationStatus) //bit 7
    {
        OperationRegister = :STATus:OPERation:EVENT?
        if (OperationRegister.IsSummary) //bit 13
        {
            InstRegister = :STATus:OPERation:INST:EVENT?
            if(InstRegister.Channell) // bit 1
            {
                InstSumRegister = :STATus:OPERation:INST:ISUM1:EVENT?
                if(InstRegister.FastLogDataAvailable) //bit 12
                {
                    // scpiBinaryData : format "#<digits_of_length><length><binary_data>"
                    byte[] scpiBinaryData = :FLOG:DATA?
                    float[] raw = convertScpiBinaryDataToFloatArray(ScpiBinaryData)
                    float[] voltage = raw[0,2,4,...]
                    float[] current = raw[1,3,5,...]
                    // do work
                }
            }
        }
    }
}
```

DATA:DATA?	168
DATA:DELeTe	168
DATA:LIST?	169
DATA:POINts?	169
FLOG:DATA?	169
FLOG:SRATe	170
FLOG:TRIGgered	170
FLOG:FILE:DURation	170
FLOG:FILE:TPARtition	171
FLOG:TARGet	171
FLOG[:STATe]	171
HCOPy:DATA?	171
HCOPy:SIZE:X?	171
HCOPy:SIZE:Y?	172
LOG[:STATe]	172
LOG:COUNT	172
LOG:DURation	173
LOG:FNAME?	173
LOG:INTerval	173
LOG:MODE	174
LOG:STIMe	174
LOG:TRIGgered	175

---

#### DATA:DATA? <filepath>

Returns the logging file data of the selected file.

If manual trigger mode (trigger via TRIG function) is used, the logging function has to be activated. Without activating the logging function in the manual trigger mode, the instrument is not able to save a logging file internally or on the USB stick.

#### Parameters:

<filepath>                      Filepath of the logging file data.

#### Example:

```
DATA:DATA?
"/int/logging/log-20201203T095013.965.csv" ->
#Device,NGL201
#Calibration Ch1,factory
Timestamp,U1[V],I1[A],P1[W]
09:50:14.078,2.0003,0.00007,0.00013
09:50:14.177,2.0003,0.00007,0.00014
09:50:14.278,2.0003,0.00007,0.00014
09:50:14.376,2.0003,0.00008,0.00016
09:50:14.477,2.0003,0.00008,0.00015
09:50:14.575,2.0003,0.00008,0.00017
```

**Usage:**                      Query only

---

#### DATA:DELeTe <filepath>

Deletes the specified file from memory.

**Setting parameters:**

<filepath> Filepath of the file.

**Example:**

```
DATA:DEL
"/int/logging/log-20201203T095013.965.csv"
Deletes internal logging file 'log-20201203T095013.965.csv'
```

**Usage:**

Setting only

---

**DATA:LIST?**

Queries all files in internal memory ('/int/') and external memory ('/USB').

**Example:**

```
DATA:LIST? -> "/USB1/NGL201/logging/
log-20201203T101025.829.csv", "/int/arb/
newWaveform.csv", "/int/logging/log-20201203T101129.818.csv"
```

**Usage:**

Query only

---

**DATA:POINTS? <filepath>**

Queries the number of measurements from the selected logging file.

If manual trigger mode (trigger via TRIG function) is used, the logging function has to be activated. Without activating the logging function in the manual trigger mode, the instrument is not able to save a logging file internally or on the USB stick.

**Parameters:**

<filepath> Filepath of the logging file data.

**Example:**

```
DATA:POIN?
"/USB1/NGL201/logging/log-20201203T101025.829.csv"
-> 5
Returns 5 log files counts from "/USB1/NGL201/logging/
log-20201203T101025.829.csv".
```

**Usage:**

Query only

---

**FLOG:DATA?**

Queries FastLog data as a block.

The block is returned in the binary format starting in the sequence of voltage followed by current measurements, i.e. V, I, V, I, ....

The R&S NGL/NGM accepts the line message EOI and/or the ASCII character NL (0Ah) as an indication that data transmission has been completed

The binary data stream must be concluded with EOI or NL or EOI followed by NL. If the data stream is not concluded with either EOI or NL, the R&S NGL/NGM will wait for additional data. In the case of a binary data transmission, the R&S NGL/NGM ignores the bit combination NL (0Ah) within the data stream.

The binary data block has the following structure:

#<LengthofLength><Length><block\_data>

Example: #234<block\_data>

- <LengthofLength> specifies how many positions the subsequent length specification occupies ("2" in the example)
- <Length> specifies the number of subsequent bytes ("34" in the example)
- <binary block data> specifies the binary block data of the specified length

To configure fastlog for scpi target, see [Example "Configuring fastlog for scpi target"](#) on page 167.

**Example:** `FLOG:DATA?`  
Returns the binary format of fastLog data from channel 1.

**Usage:** Query only

**FLOG:SRATe** <samplerate>

Sets or queries the sample rate of the FastLog function.

**Parameters:**  
<samplerate> S500k | S250k | S50k | S10k | S1k | S100

**Example:** `FLOG:SRAT S500K`  
Set Ch1 FastLog writes sample rate at 500K samples/sec.

**FLOG:TRIGgered** <arg0>

**FLOG:TRIGgered?**

Sets or queries the triggered state of FastLog.

See [Figure 6-18](#).

**Parameters:**  
<arg0> **1**  
Activates the FastLog state.  
**0**  
Deactivates the FastLog state.

**Example:** `FLOG:TRIG 1`  
Ch1 FastLog triggered state is activated. In the event if a trigger signal is detected from the various input digital sources, a trigger event is sent to activate the FastLog function.

**FLOG:FILE:DURation** <arg0>

**FLOG:FILE:DURation?**

Sets or queries the file write duration.

**Setting parameters:**  
<duration> Sets file write duration.

**Example:** `FLOG:FILE:DUR 2`  
Sets file writes duration for Ch1 to 2 seconds.

---

#### **FLOG:FILE:TPARTition** <arg0>

Selects the external partition to which the data is written into.

#### **Parameters:**

<arg0> Defines the external path partition to which the data is written in the USB stick.

**Example:** `FLOG:FILE:TPAR "/USB1A/NGM202"`

---

#### **FLOG:TARGET** <arg0>

Chose the target the data shall be written to.

#### **Parameters:**

<arg0> SCPI | USB

#### **SCPI**

Transfer data to SCPI client.

The sum of all sample rates have to be smaller or equal to 500 kS/s.

#### **USB**

Saves data to a binary file which is saved to the directory specified in the "Target Folder".

---

#### **FLOG[:STATE]** <arg0>

#### **FLOG[:STATE]?**

Sets or queries the FastLog state.

#### **Parameters:**

<arg0> **1**  
Enables the FastLog state.

**0**

Disables the FastLog state.

**Example:** `FLOG 1`  
Activates the Ch1 FastLog state.

---

#### **HCOPY:DATA?**

Returns the actual display content (screenshot).

**Usage:** Query only

---

#### **HCOPY:SIZE:X?**

Returns the horizontal dimension of the screenshots.

**Usage:** Query only

---

### HCOPY:SIZE:Y?

Returns the vertical dimension of the screenshots.

**Usage:** Query only

---

### LOG[:STATe] <state>

#### LOG[:STATe]?

Sets or queries the data logging state.

#### Parameters:

<state>                    **1**  
Data logging function is enabled.

**0**  
Data logging function is disabled.

\*RST:                    0

**Example:**                LOG ON  
                              LOG? -> 1  
                              Data logging function is activated.

---

### LOG:COUNt <count>

#### LOG:COUNt? [<Return min or max>]

Sets, queries the number of measurement values to be captured.

#### Setting parameters:

<count>                    <numeric value> | MIN | MAX

**<numeric value>**  
Number of measurement values to be captured is set in the range of 1 to 10000000.

**MIN**  
Minimum number of measurement values to be captured is set at 1.

**MAX**  
Maximum number of measurement values to be captured is set at 10000000.

#### Parameters for setting and query:

<count>                    MIN | MINimum | MAX | MAXimum  
Returns the number of measurement values.

**Example:**                LOG:COUN MAX  
                              LOG:COUN? MAX -> 10000000

---

**LOG:DURation** <span>

**LOG:DURation?** [<Return min or max>]

Sets or queries the duration of the data logging.

**Setting parameters:**

<span> <numeric value> | MIN | MAX

**<numeric value>**

Duration of the data logging captured in the range of 0 s to  $3.49 \cdot 10^5$  s.

**MIN**

Minimum duration of the data logging captured at 0 s.

**MAX**

Maximum duration of the data logging captured at  $3.49 \cdot 10^5$  s.

Default unit: s

**Parameters for setting and query:**

<span> MIN | MINimum | MAX | MAXimum

Returns the duration of the data logging.

**Example:**

LOG:DUR MAX

LOG:DUR? MAX -> 349000

---

**LOG:FNAME?**

Queries the filename and storage location for the data logging.

**Example:**

LOG 0

LOG:FNAME? -> ""

LOG 1

LOG:FNAME? -> "/int/logging/log-20190318T1141853.407.csv"

Enables the data logging and queries the data log filename.

**Usage:**

Query only

---

**LOG:INTERval** <interval>

**LOG:INTERval?** [<Return min or max>]

Sets or queries the data logging measurement interval. The measurement interval describes the time between the recorded measurements.

**Setting parameters:**

<interval> <numeric value> | MIN | MAX

**<numeric value>**

Measurement interval in the range of 0.1 s to 600 s.

**MIN**

Minimum measurement interval is set at 0.1 s.

**MAX**

Maximum measurement interval is set at 600 s.

Default unit: s

**Parameters for setting and query:**

<interval> MIN | MINimum | MAX | MAXimum  
Returns the measurement interval.

**Example:** LOG:INT 10  
LOG:INT? -> 10

**LOG:MODE** <mode>

**LOG:MODE?**

Sets or queries the data logging mode.

**Parameters:**

<mode> UNLimited | COUNT | DURation | SPAN

**UNLimited**

Infinite data capture.

**COUNT**

Number of measurement values to be captured.

**DURation**

Duration of the measurement values capture.

**SPAN**

Interval of the measurement values capture.

**Example:** LOG:MODE DUR  
LOG:MODE? -> DUR

**LOG:STIME** <Year>, <Month>, <Day>, <Hour>, <Minute>, <Second>

**LOG:STIME?**

Sets or queries the start time of the data logging function.

**Parameters:**

<Year> Sets the year for the data logging function.

**Setting parameters:**

<Month> Sets the month for the data logging function.

<Day> Sets the day for the data logging function.

<Hour> Sets the hour for the data logging function.

<Minute> Sets the minute for the data logging function.

<Second> Sets the second for the data logging function.

**Example:** LOG:STIM 2018,08,18,08,18,18  
LOG:STIM? -> 2018,08,18,08,18,18



---

**LOG:TRIGgered** <state>

**LOG:TRIGgered?**

Sets or queries the state for manual trigger logging function.

**Parameters:**

<state>                    **0**  
                                  Manual trigger function is disabled.

**1**  
                                  Manual trigger function is enabled.

**Example:**                LOG:TRIG ON  
                                  LOG:TRIG? -> 1

## 7.9 Status Reporting Commands

The status reporting system stores all information on the present operating state of the instrument, and on errors which have occurred. This information is stored in the status registers and in the error queue. The `STATUS:OPERation` and `STATUS:QUESTionable` subsystems contains commands to control the status reporting structure of the instrument.

See [Chapter A.3.1, "Structure of a SCPI Status Register"](#), on page 186.

### 7.9.1 STATUS:OPERation Registers

The commands of the `STATUS:OPERation` subsystem control the status reporting structures of the `STATUS:OPERation` register.

The suffix at <Channel> selects the instrument channel. the range is <1...2>.

<code>STATUS:OPERation:INSTrument:CONDition?</code> .....	175
<code>STATUS:OPERation:INSTrument:ISUMmary&lt;Channel&gt;:CONDition?</code> .....	175
<code>STATUS:OPERation:INSTrument:ENABle</code> .....	176
<code>STATUS:OPERation:INSTrument:ISUMmary&lt;Channel&gt;:ENABle</code> .....	176
<code>STATUS:OPERation:INSTrument[:EVENT]?</code> .....	176
<code>STATUS:OPERation:INSTrument:ISUMmary&lt;Channel&gt;[:EVENT]?</code> .....	176
<code>STATUS:OPERation:INSTrument:NTRansition</code> .....	176
<code>STATUS:OPERation:INSTrument:ISUMmary&lt;Channel&gt;:NTRansition</code> .....	176
<code>STATUS:OPERation:INSTrument:PTRansition</code> .....	177
<code>STATUS:OPERation:INSTrument:ISUMmary&lt;Channel&gt;:PTRansition</code> .....	177

---

**STATUS:OPERation:INSTrument:CONDition?**

**STATUS:OPERation:INSTrument:ISUMmary<Channel>:CONDition?** <Condition>

Returns the contents of the `CONDition` part of the status register to check for operation instrument or measurement states. Reading the `CONDition` registers does not delete the contents.

**Suffix:**  
 <Channel> 1..n

**Return values:**  
 <Condition> Condition bits in decimal representation.  
 Range: 1 to 65535

**Usage:** Query only

**STATus:OPERation:INSTRument:ENABLE <arg0>**  
**STATus:OPERation:INSTRument:ENABLE?**  
**STATus:OPERation:INSTRument:ISUMmary<Channel>:ENABLE <arg0>**  
**STATus:OPERation:INSTRument:ISUMmary<Channel>:ENABLE?**

Controls or queries the ENABLE part of the STATus:OPERation register. The ENABLE defines which events in the EVENT part of the status register are forwarded to the OPERation summary bit (bit 7) of the status byte. The status byte can be used to create a service request.

**Suffix:**  
 <Channel> 1..n

**Parameters:**  
 <Enable> Range: 1 to 65535  
 Increment: 1

**Example:** STATus:OPERation:INSTRument:ISUMmary1:ENABLE?  
 Reads the enable register for the Standard Operation Register group

**STATus:OPERation:INSTRument[:EVENT]?**  
**STATus:OPERation:INSTRument:ISUMmary<Channel>[:EVENT]?**

Returns the contents of the EVENT part of the status register to check whether an event has occurred since the last reading. Reading an EVENT register deletes its contents.

**Suffix:**  
 <Channel> 1..n

**Return values:**  
 <Event> Range: 1 to 65535

**Usage:** Query only

**STATus:OPERation:INSTRument:NTRansition <NegativePosition>**  
**STATus:OPERation:INSTRument:NTRansition?**  
**STATus:OPERation:INSTRument:ISUMmary<Channel>:NTRansition <arg0>**  
**STATus:OPERation:INSTRument:ISUMmary<Channel>:NTRansition?**

Sets or queries the negative transition filter. Setting a bit in the negative transition filter shall cause a 1 to 0 transition in the corresponding bit of the associated condition register to cause a 1 to be written in the associated bit of the corresponding event register.

**Suffix:**

&lt;Channel&gt; 1..n

**Parameters:**

&lt;NegativeTransition&gt; Range: 1 to 65535

**Example:**

```

STATus:OPERation:INSTRument:ISUMmary1:
NTRansition?
Query for negative transition.

```

**STATus:OPERation:INSTRument:PTRansition** <PositiveTransition>**STATus:OPERation:INSTRument:PTRansition?****STATus:OPERation:INSTRument:ISUMmary<Channel>:PTRansition** <arg0>**STATus:OPERation:INSTRument:ISUMmary<Channel>:PTRansition?**

Sets or queries the positive transition filter. Setting a bit in the positive transition filter shall cause a 0 to 1 transition in the corresponding bit of the associated condition register to cause a 1 to be written in the associated bit of the corresponding event register.

**Suffix:**

&lt;Channel&gt; 1..n

**Parameters:**

&lt;PositiveTransition&gt; Range: 1 to 65535

**Example:**

```

STATus:OPERation:INSTRument:ISUMmary1:
PTRansition?
Query for positive transition.

```

## 7.9.2 STATus:QUEStionable Registers

The commands of the `STATus:QUEStionable` subsystem control the status reporting structures of the `STATus:QUEStionable` registers:

The suffix <n> at Channel selects the instrument. The range is <1...2>.

<code>STATus:QUEStionable:INSTRument:CONDition?</code> .....	178
<code>STATus:QUEStionable:INSTRument:ISUMmary&lt;Channel&gt;:CONDition?</code> .....	178
<code>STATus:QUEStionable:INSTRument:ENABLE</code> .....	178
<code>STATus:QUEStionable:INSTRument:ISUMmary&lt;Channel&gt;:ENABLE</code> .....	178
<code>STATus:QUEStionable:INSTRument[:EVENT]?</code> .....	178
<code>STATus:QUEStionable:INSTRument:ISUMmary&lt;Channel&gt;[:EVENT]?</code> .....	178
<code>STATus:QUEStionable:INSTRument:NTRansition</code> .....	179
<code>STATus:QUEStionable:INSTRument:ISUMmary&lt;Channel&gt;:NTRansition</code> .....	179
<code>STATus:QUEStionable:INSTRument:PTRansition</code> .....	179
<code>STATus:QUEStionable:INSTRument:ISUMmary&lt;Channel&gt;:PTRansition</code> .....	179

**STATus:QUESTIONable:INSTrument:CONDition?****STATus:QUESTIONable:INSTrument:ISUMmary<Channel>:CONDition?** <Condition>

Returns the contents of the CONDition part of the status register to check for questionable instrument or measurement states. Reading the CONDition registers does not delete the contents.

**Suffix:**

&lt;Channel&gt; 1..n

**Return values:**

&lt;Condition&gt; Condition bits in decimal representation

Range: 0 to 65535

**Usage:**

Query only

**STATus:QUESTIONable:INSTrument:ENABle** <arg0>**STATus:QUESTIONable:INSTrument:ENABle?****STATus:QUESTIONable:INSTrument:ISUMmary<Channel>:ENABle** <Enable\_Value>**STATus:QUESTIONable:INSTrument:ISUMmary<Channel>:ENABle?**

Sets or queries the enable mask that allows true conditions in the EVENT part to be reported in the summary bit.

If a bit in the ENABle part is 1, and the corresponding EVENT bit is true, a positive transition occurs in the summary bit. This transition is reported to the next higher level.

**Suffix:**

&lt;Channel&gt; 1..n

**Parameters:**

&lt;Enable\_Value&gt; Bit mask in decimal representation

Range: 0 to 65535

**Example:**

```
STATus:QUESTIONable:INSTrument:ISUMmary1:
ENABle?
```

Queries the event register for the Standard QUESTIONable Register group.

**STATus:QUESTIONable:INSTrument[:EVENT]?****STATus:QUESTIONable:INSTrument:ISUMmary<Channel>[:EVENT]?**

Returns the contents of the EVENT part of the status register to check whether an event has occurred since the last reading. Reading an EVENT register deletes its contents.

**Suffix:**

&lt;Channel&gt; 1..n

**Return values:**

&lt;Event&gt; Event bits in decimal representation

Range: 0 to 65535

**Usage:**

Query only

---

**STATus:QUESTionable:INSTrument:NTRansition** <arg0>

**STATus:QUESTionable:INSTrument:NTRansition?**

**STATus:QUESTionable:INSTrument:ISUMmary<Channel>:NTRansition**  
<NegativeTransition>

**STATus:QUESTionable:INSTrument:ISUMmary<Channel>:NTRansition?**

Sets or queries the negative transition filter. Setting a bit in the negative transition filter shall cause a 1 to 0 transition in the corresponding bit of the associated condition register to cause a 1 to be written in the associated bit of the corresponding event register.

**Suffix:**

<Channel>                    1..n

**Parameters:**

<NegativeTransition> Range:        1 to 65535

**Example:**

STATus:QUESTionable:INSTrument:ISUMmary1:  
NTRansition?

Query for negative transition.

---

**STATus:QUESTionable:INSTrument:PTRansition** <arg0>

**STATus:QUESTionable:INSTrument:PTRansition?**

**STATus:QUESTionable:INSTrument:ISUMmary<Channel>:PTRansition**  
<PositiveTransition>

**STATus:QUESTionable:INSTrument:ISUMmary<Channel>:PTRansition?**

Sets or queries the positive transition filter. Setting a bit in the positive transition filter shall cause a 0 to 1 transition in the corresponding bit of the associated condition register to cause a 1 to be written in the associated bit of the corresponding event register.

**Suffix:**

<Channel>                    1..n

**Parameters:**

<PositiveTransition> Range:        1 to 65535

**Example:**

STATus:QUESTionable:INSTrument:ISUMmary1:  
PTRansition?

Query for positive transition.

# Annex

## A Additional Basics on Remote Control

### A.1 Messages and Command Structure

#### A.1.1 Messages

Instrument messages are employed in the same way for all interfaces, if not indicated otherwise in the description.

- Structure and syntax of the instrument messages: [Chapter A.1.2, "SCPI Command Structure"](#), on page 181
- Detailed description of all messages: [Chapter 7, "Remote Control Commands"](#), on page 96

There are different types of instrument messages:

- Commands
- Instrument responses

#### Commands

Commands (program messages) are messages which the controller sends to the instrument. They operate the instrument functions and request information. The commands are subdivided according to two criteria:

#### Effects on the instrument:

- Setting commands cause instrument settings such as a reset of the instrument or setting the output voltage.
- Queries return data for remote control, e.g. for identification of the instrument or polling a parameter value. Queries are formed by appending a question mark to the command header.

#### Applied standards:

- The function and syntax of the common commands are precisely defined in standard IEEE 488.2. If implemented, they are used identically on all instruments. They refer to functions such as management of the standardized status registers, reset and self-test.
- Instrument control commands refer to functions depending on the features of the instrument such as voltage settings. Many of these commands have also been standardized by the SCPI committee. These commands are marked as "SCPI compliant" in the command reference chapters. Commands without this SCPI label

are device-specific, however, their syntax follows SCPI rules as permitted by the standard.

### Instrument responses

Instrument responses (response messages and service requests) are messages which the instrument sends to the controller after a query. They can contain measurement results, instrument settings and information on the instrument status.

### GPIB Interface Messages

Interface messages are transmitted to the instrument on the data lines with the attention line (ATN) being active (LOW). They are used for communication between the controller and the instrument and can only be sent by a PC which has the function of a GPIB bus controller. GPIB interface messages can be further subdivided into:

- **Universal commands** act on all instruments connected to the GPIB bus without previous addressing; universal commands are encoded in the range 10 through 1F hex. They affect all instruments connected to the bus and do not require addressing.
- **Addressed commands** only act on instruments previously addressed as listeners; addressed commands are encoded in the range 00 through 0F hex. They only affect instruments addressed as listeners.

## A.1.2 SCPI Command Structure

SCPI commands consist of a so-called header and, usually, one or more parameters. The header and the parameters are separated by a whitespace. The headers can consist of several mnemonics (keywords). Queries are formed by appending a question mark directly to the header. The commands can be either device-specific or device-independent (common commands). Common and device-specific commands differ in their syntax.

### Syntax for Common Commands

Common (= device-independent) commands consist of a header preceded by an asterisk (\*) and possibly one or more parameters.

*Table A-1: Examples of Common Commands*

Command	Command Name	Description
*RST	Reset	Resets the instrument.
*ESE	Event Status Enable	Sets the bits of the event status enable registers.
*ESR?	Event Status Query	Queries the content of the event status register.
*IDN?	Identification Query	Queries the instrument identification string.

### Syntax for Device-Specific Commands

For demonstration purposes only, assume the existence of the following commands for this section:

- MEASure:CURRent[:DC]?
- MEASure:VOLTage[:DC]?
- FUSE[:STATe] {0 | 1}
- FUSE[:STATe]?

### Long and short form

The mnemonics feature a long form and a short form. The short form is marked by uppercase letters, the long form corresponds to the complete word. You can enter either the short form or the long form; other abbreviations are not permitted.

#### Example:

MEASure:CURRent? is equivalent to MEAS:CURR?



### Case-insensitivity

Uppercase and lowercase notation only serves to distinguish the two forms in the manual, the instrument itself is case-insensitive.

### Optional mnemonics

Some command systems permit inserting or omitting certain mnemonics in the header. These mnemonics are marked by square brackets. The instrument must recognize the long command to comply with the SCPI standard. Some commands are shortened by these optional mnemonics.

#### Example:

FUSE[:STATe] { ON }

FUSE:STAT ON is equivalent to FUSE ON



## Special characters

**Table A-2: Special characters**

	<p>A vertical stroke in parameter definitions indicates alternative possibilities in the sense of "or". The effect of the command differs, depending on the used parameter.</p> <p>Example:</p> <ul style="list-style-type: none"> <li>• FUSE:LINK {1   2   3}</li> <li>• FUSE:LINK 1 sets the fuse link CH1 for the selected channel FUSE:LINK 2 sets the fuse link of CH2 for the selected channel</li> </ul>
[ ]	<p>Mnemonics in square brackets are optional and can be inserted into the header or be omitted.</p> <p>Example:</p> <ul style="list-style-type: none"> <li>• FUSE[:STATe] { ON }</li> <li>• FUSE:STAT ON is equivalent to FUSE ON</li> </ul>
{ }	<p>Parameters in curly brackets are optional and can be inserted once or several times, or be omitted.</p> <p>Example:</p> <ul style="list-style-type: none"> <li>• VOLTage[:LEVel][:IMMediate][:AMPLitude] {&lt;voltage&gt;   MIN   MAX   UP   DOWN }</li> </ul> <p>The following are valid commands:</p> <ul style="list-style-type: none"> <li>- VOLT MAX</li> <li>- VOLT MIN VOLT 10</li> </ul>

## Syntax for Channel List Commands

For demonstration purposes only, assume the existence of the following commands for this section:

- VOLT? (@2)
- OUTP (@2)
- VOLT? (@1,3)
- VOLT? (@1:4)
- VOLT 5, (@1:4)

When adding a channel list parameter to a query, there must be a space character between the query indicator (?) and the channel list parameter. Otherwise an error -103, invalid separator occurs.

**Table A-3: Special characters**

@	<p>The "@" sign in parameter definitions indicates in the sense of "at", this is part of the channel list command syntax.</p> <p>Example:</p> <ul style="list-style-type: none"> <li>• VOLT? (@2) queries the voltage at CH2</li> <li>• OUTP 1, (@3) turns on the output at CH3</li> </ul>
,	<p>The comma sign in parameter definitions indicates in the sense of separator for additional channels definition.</p> <p>Example:</p> <ul style="list-style-type: none"> <li>• VOLT? (@1,3) queries the voltage at CH1 and CH3</li> <li>• VOLT? (@1,3,4) is equivalent to queries the voltage at CH1, CH3 and CH4</li> </ul>
:	<p>The colon sign in parameter definitions indicates the definition of of channel range for additional channel definition.</p> <p>Example:</p> <ul style="list-style-type: none"> <li>• VOLTage? (@1:3) queries the voltage at CH1, CH2, CH3</li> <li>• VOLTage 5, (@1:3) configures CH1, CH2 and CH3 to 5 V</li> </ul>

### SCPI Parameters

Many commands are supplemented by a parameter or a list of parameters. The parameters must be separated from the header by a whitespace (ASCII code 0 to 9, 11 to 32 decimal, e.g. blank).

Allowed parameters are:

- Numeric values
- Special numeric values
- Boolean parameters
- Text
- Character strings
- Block data

The required parameters and the allowed value range are specified in the command description.

### Numeric values

You can enter numeric values in the following form. Values exceeding the resolution of the instrument are rounded up or down.

#### Example:

```
VOLT 10V = VOLT 10
```

```
VOLT 100mV = VOLT 0.1
```

### Special numeric values

The text listed below are interpreted as special numeric values. In the case of a query, the numeric value is provided.

- MIN / MAX
- MINimum and MAXimum denote the minimum and maximum value.

#### Example:

```
VOLT:PROT? MAX
```

Returns the maximum numeric value.

### Boolean parameters

Boolean parameters represent two states:

- **On** (logically true), is represented by "On" or the numeric value "1"
- **Off** (logically false), is represented by "Off" or the numeric value "0"

The instrument returns the numerical value when queried.

**Example:**

```
OUTP:STAT ON
```

```
OUTP:STAT?
```

```
Response: 1
```

**Overview of Syntax Elements**

The following table provides an overview of the syntax elements:

**Table A-4: Syntax Elements**

:	A colon separates the mnemonics of a command.
,	A comma separates several parameters of a command.
?	A question mark forms a query.
*	An asterisk marks a common command.
"	Quotation marks introduce a string and terminate it.
	A whitespace (ASCII-Code 0 to 9, 11 to 32 decimal, e.g. blank) separates the header from the parameters.

**Responses to Queries**

You can query each setting command by adding a question mark. According to SCPI, the responses to queries are partly subject to stricter rules than in the standard IEEE 488.2.

- The requested parameter is transmitted without a header.  

```
VOLTage:PROTection:MODE?
```

```
Response: "measured"
```
- Maximum values, minimum values and all other quantities that are requested via a special text parameter are returned as numeric values.  

```
VOLT:PROT? MAX
```

```
Response: 32.500
```
- Boolean values are returned as 0 (for Off) and 1 (for On).  

```
OUTPut:STATe?
```

```
Response: 1
```

## A.2 Command Sequence and Synchronization

A sequential command finishes the execution before the next command is starting. To make sure that commands are actually carried out in a certain order, each command must be sent in a separate command line.



As a rule, send commands and queries in different program messages.

## A.2.1 Preventing Overlapping Execution

Table A-5: Synchronization using \*OPC, \*OPC? and \*WAI

Command	Action	Programming the controller
*OPC	Sets the Operation Complete bit in the ESR after all previous commands have been executed.	<ul style="list-style-type: none"> <li>Setting bit 0 in the ESE</li> <li>Setting bit 5 in the SRE</li> <li>Waiting for service request (SRQ)</li> </ul>
*OPC?	Stops command processing until 1 is returned. It occurs after the Operation Complete bit has been set in the ESR. This bit indicates that the previous setting has been completed.	Sending *OPC? directly after the command whose processing should be terminated before other commands can be executed.
*WAI	Stops further command processing until all commands have been executed before *WAI.	Sending *WAI directly after the command whose processing should be terminated before other commands are executed

To prevent an overlapping execution of commands the commands \*OPC, \*OPC? or \*WAI can be used. All three commands cause a certain action only to be carried out after the hardware has been set. The controller can be forced to wait for the corresponding action.



The R&S NGL/NGM series does not support parallel processing of remote commands. If OPC? returns a "1", the device is able to process new commands.

## A.3 Status Reporting System

The status reporting system stores all information on the current operating state of the instrument and errors which have occurred. This information is stored in the status registers and in the error queue. You can query both via RS-232, USB, GPIB or LAN interface (STATus... commands).

### A.3.1 Structure of a SCPI Status Register

Each standard SCPI register consists of 2 or 3 parts (Event, Condition and Enable register). Each part has a width of 16 bits and has different functions. The individual bits are independent of each other, i.e. each hardware status is assigned a bit number which is valid for all 2 or 3 parts. Bit 15 (the most significant bit) is set to zero for all parts. Thus the controller can process contents of the register parts as positive integers.

STATus:QUESTionable:INSTrument:ISUMmary1 exists as often as device channels are available (e.g. NGL201 = 2 channels = 2 status register). Accordingly, the description text of the channel information changes in [Figure A-1](#) (e.g. instrument 1 = channel 1, instrument 2 = channel 2 etc.).



Depending on the value of the read register, you can draw conclusions on the current status of the device. For example, when the unit operates in constant voltage, the result of the returned ISUM register is a decimal "2" which corresponds the binary value of "0000000000000010".

Any part of a status register system can be read by query commands. A decimal value is returned and represents the bit pattern of the requested register. Each SCPI register is 16 bits wide and has various functions. The individual bits are independent, i.e. each hardware status is assigned to a bit number.

Bits 9 to 12 are still "free" resp. unused (always return a "0"). Certain areas of the registers are not used. The SCPI standard defines only the "basic functions". Some devices offer an advanced functionality.

Each channel of the power supply is considered as separate "instrument" (SCPI standard definition). Therefore, e.g. the register `STATus:QUEStionable:INSTRument:ISUMmary` of the NGL202 or NGM202 is also present two times (Isummary1 - Isummary2).

**Description of the status register parts**

The SCPI standard provides two different status registers:

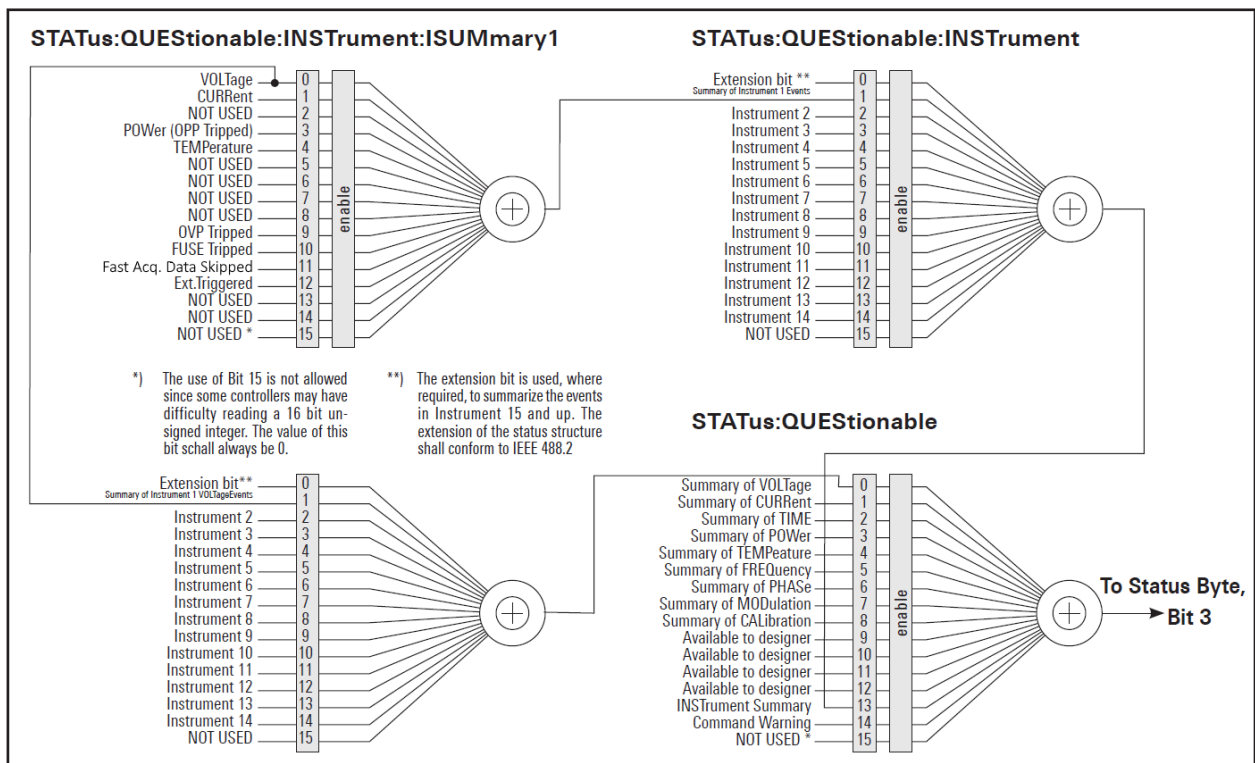

Figure A-1: Structure of the status:QUEStionable register

**CONDition**

- The CONDition register queries the actual state of the instrument. If you want to query the constant voltage or current mode, you have to use the CONDition register.



The CONDition register delivers a "1" (first bit set) in constant current mode (CC) and a "2" (second bit set) in constant voltage mode (CV).

If the correct channel is selected and the red LED of the channel button lights up (CC mode), the query of the CONDition register must deliver a "1".

**Example:**

```
STAT:QUES:ISUM1:COND?
```

**EVENT**

- The EVENT status register is set (1) until it is queried. After reading (query), the EVENT status register is set to zero.



The description of registers is only used for general explanation. Due to the complexity, we recommend the general accessible SCPI standard document for more detailed information.

For further description of the status register, see [Chapter 7.9, "Status Reporting Commands"](#), on page 175.

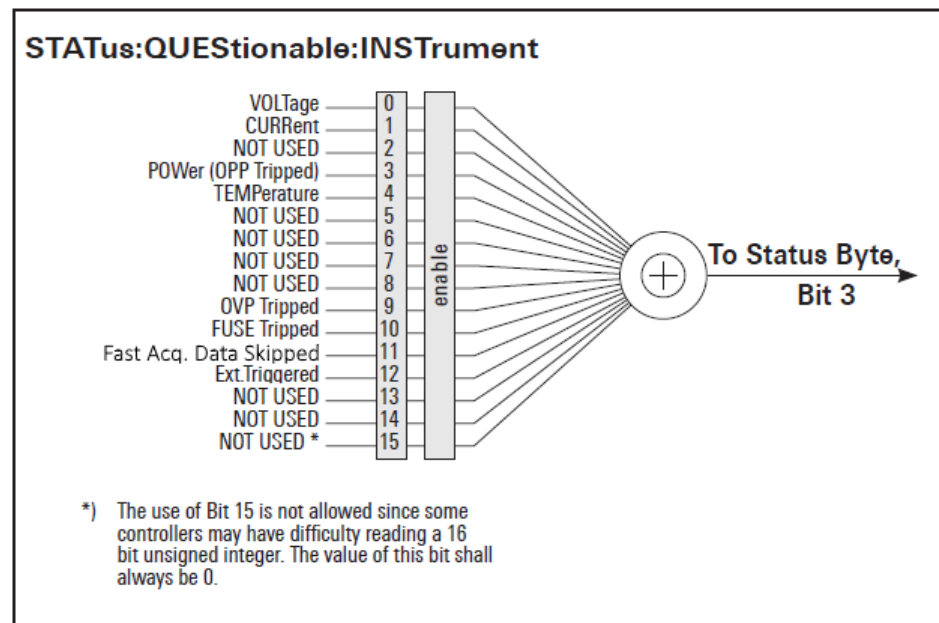

Figure A-2: Structure of the status:QUESTIONABLE:INSTRUMENT register

### Event Status Register (ESR) and Event Status Enable Register (ESE)

The ESR is defined in IEEE 488.2. It can be compared with the `EVENT` part of an SCPI register. The event status register can be read out using the command `*ESR?`. The ESE corresponds to the `ENABLE` part of an SCPI register. If a bit is set in the ESE and the associated bit in the ESR changes from 0 to 1, the ESB bit in the STB is set. The ESE register can be set using the command `*ESE` and read using the command `*ESE?`.

### STATus:OPERation Register

In the `CONDition` part, this register contains information on which actions the instrument is being executing or, in the `EVENT` part, information on which actions the instrument has executed since the last reading. It can be read using the commands `STATus:OPERation:CONDition?` or `STATus:OPERation[:EVENT]?`.

Bit No.	Meaning
0	<b>CALibrating</b> This bit is set as long as the instrument is performing a calibration.
1 to 3	Not used
4	<b>MEASuring</b> This bit is set on event new measurement available.
5 to 9	Not used
10	<b>Logging</b> This bit is set as long as "Logging" is enabled
11	Not used
12	<b>FastLog</b> This bit is set once "FastLog" data is available
13 to 14	Not used
15	This bit is always 0

### STATus:QUEStionable Register

This register contains information about different states which can occur. It can be read using the commands `STATus:QUEStionable:CONDition?` and `STATus:QUEStionable[:EVENT]?`. See [Figure A-1](#).

**Table A-6: Bits of the STATus:QUEStionable register**

Bit No.	Meaning
0	<b>Voltage</b> This bit is set while the instrument is in constant current mode (CC). The voltage is regulated and the current is constant.
1	<b>Current</b> This bit is set while the instrument is in constant voltage mode (CV). The current is variable and the voltage is constant.

Bit No.	Meaning
2	<b>Not used</b>
3	<b>POWER (OPP Tripped)</b> This bit is set if an over power protection has tripped.
4	<b>Temperature overrange</b> This bit is set if an over temperature occurs.
5 to 8	<b>Not used</b>
9	<b>OVP Tripped</b> This bit is set if the over voltage protection has tripped.
10	<b>Fuse Tripped</b> This bit is set if the fuse protection has tripped.
11	<b>Fast Acq. Data Skipped</b>
12	<b>Ext. Triggered</b>
13	<b>Sense Connection</b>
14	<b>Not used</b>
15	This bit is always 0

### Query of an instrument status

Each part of any status register can be read using queries.

There are two types of commands:

- The common commands `*ESR?`, `*IDN?`, `*STB?` query the higher-level registers.
- The commands of the `STATus` system query the SCPI registers  
(`STATus:QUESTIONable`)

The returned value is always a decimal number that represents the bit pattern of the queried register. This number is evaluated by the controller program.

### Decimal representation of a bit pattern (binary weights)

The STB and ESR registers contain 8 bits, the status registers 16 bits. The contents of a status register are specified and transferred as a single decimal number. To make this possible, each bit is assigned a weighted value. The decimal number is calculated as the sum of the weighted values of all bits in the register that are set to 1.

Bits									
Weight	1	2	4	8	16	32	64	128	...

Figure A-3: Decimal representation of a bit pattern



### Error Queue

Each error state in the instrument leads to an entry in the error queue. The entries of the error queue are detailed plain text error messages. You can look them up in the error log or via remote control using `SYSTem:ERRor[:NEXT]?`. Each call of `SYSTem:ERRor[:NEXT]?` provides one entry from the error queue. If no error messages are stored, the instrument responds with 0, "No error".

# List of Commands

[SOURce:]ALIMit[:STATe].....	108
[SOURce:]CURRent:PROTection:CLEar.....	131
[SOURce:]CURRent:PROTection:DELay.....	132
[SOURce:]CURRent:PROTection:DELay:INITial.....	131
[SOURce:]CURRent:PROTection:LINK.....	132
[SOURce:]CURRent:PROTection:TRIPped?.....	133
[SOURce:]CURRent:PROTection:UNLink.....	133
[SOURce:]CURRent:PROTection[:STATe].....	133
[SOURce:]CURRent[:LEVel][:IMMediate]:ALIMit:LOWer.....	110
[SOURce:]CURRent[:LEVel][:IMMediate]:ALIMit:UPPer.....	110
[SOURce:]CURRent[:LEVel][:IMMediate]:STEP[:INCRement].....	116
[SOURce:]CURRent[:LEVel][:IMMediate]:AMPLitude.....	116
[SOURce:]POWER:PROTection:CLEar.....	141
[SOURce:]POWER:PROTection:LEVel.....	141
[SOURce:]POWER:PROTection:TRIPped?.....	142
[SOURce:]POWER:PROTection[:STATe].....	140
[SOURce:]RESistance:STATe.....	119
[SOURce:]RESistance[:LEVel][:IMMediate]:AMPLitude.....	118
[SOURce:]VOLTage:DVM[:STATe].....	127
[SOURce:]VOLTage:PROTection:CLEar.....	138
[SOURce:]VOLTage:PROTection:LEVel.....	138
[SOURce:]VOLTage:PROTection:TRIPped?.....	139
[SOURce:]VOLTage:PROTection[:STATe].....	138
[SOURce:]VOLTage:RAMP:DURation.....	156
[SOURce:]VOLTage:RAMP[:STATe].....	155
[SOURce:]VOLTage[:LEVel][:IMMediate]:ALIMit:LOWer.....	109
[SOURce:]VOLTage[:LEVel][:IMMediate]:ALIMit:UPPer.....	109
[SOURce:]VOLTage[:LEVel][:IMMediate]:STEP[:INCRement].....	114
[SOURce:]VOLTage[:LEVel][:IMMediate]:AMPLitude.....	113
*CLS.....	96
*ESE.....	96
*ESR?.....	97
*IDN?.....	97
*OPC.....	97
*OPT?.....	97
*RST.....	97
*SRE.....	98
*STB?.....	98
*TRG.....	98
*TST?.....	98
*WAI.....	98
APPLY.....	119
ARBitrary:BEHavior:END.....	151
ARBitrary:CLEar.....	152
ARBitrary:DATA.....	152
ARBitrary:FNAME.....	152
ARBitrary:LOAD.....	153

ARbitrary:REPetitions.....	153
ARbitrary:REStore.....	153
ARbitrary:SAVE.....	153
ARbitrary:StARt.....	154
ARbitrary:StOP.....	154
ARbitrary:TRANsfer.....	154
ARbitrary:TRIGgered:MODE.....	154
ARbitrary:TRIGgered[:StAte].....	155
ARbitrary[:StAte].....	151
BATtery:MODEl:CAPacity.....	164
BATtery:MODEl:CLear.....	164
BATtery:MODEl:CURRent:LIMit:EOC.....	163
BATtery:MODEl:CURRent:LIMit:EOD.....	164
BATtery:MODEl:CURRent:LIMit:REGular.....	164
BATtery:MODEl:DATA.....	164
BATtery:MODEl:FNAME.....	165
BATtery:MODEl:ISOC.....	165
BATtery:MODEl:LOAD.....	165
BATtery:MODEl:SAVE.....	166
BATtery:MODEl:TRANsfer.....	166
BATtery:SIMulator:CAPacity:LIMit.....	160
BATtery:SIMulator:CAPacity?.....	160
BATtery:SIMulator:CURRent:LIMit:EOC.....	161
BATtery:SIMulator:CURRent:LIMit:EOD.....	161
BATtery:SIMulator:CURRent:LIMit:REGular.....	161
BATtery:SIMulator:CURRent:LIMit?.....	160
BATtery:SIMulator:CURRent?.....	160
BATtery:SIMulator:RESistance?.....	161
BATtery:SIMulator:SOC.....	161
BATtery:SIMulator:TVOLtage?.....	162
BATtery:SIMulator:VOC:EMPTy?.....	162
BATtery:SIMulator:VOC:FULL?.....	162
BATtery:SIMulator:VOC?.....	162
BATtery:SIMulator[:ENABle].....	163
BATtery:StAtus?.....	163
DATA:DATA?.....	168
DATA:DELeTe.....	168
DATA:LISt?.....	169
DATA:POINts?.....	169
DIO:FAULt:CHANnel.....	156
DIO:FAULt:SIGNal.....	158
DIO:FAULt:SOURce.....	157
DIO:FAULt[:StAte].....	157
DIO:OUTPut:SIGNal.....	159
DIO:OUTPut:SOURce.....	158
DIO:OUTPut[:StAte].....	158
DISPlay:BRIGhtness.....	101
DISPlay[:WINDow]:TEXT:CLear.....	102
DISPlay[:WINDow]:TEXT[:DATA].....	102
FLOG:DATA?.....	169

FLOG:FILE:DURation.....	170
FLOG:FILE:TPARTition.....	171
FLOG:SRATe.....	170
FLOG:TARGet.....	171
FLOG:TRIGgered.....	170
FLOG[:STATe].....	171
FUSE:DELay:INITial.....	134
FUSE:DELay[:BLOWing].....	134
FUSE:LINK.....	135
FUSE:TRIPped?.....	135
FUSE:UNLink.....	135
FUSE[:STATe].....	135
HCOPy:DATA?.....	171
HCOPy:SIZE:X?.....	171
HCOPy:SIZE:Y?.....	172
INSTrument:NSElect.....	106
INSTrument[:SElect].....	107
INTerfaces:USB:CLASs.....	142
LOG:COUnT.....	172
LOG:DURation.....	173
LOG:FNAME?.....	173
LOG:INTerval.....	173
LOG:MODE.....	174
LOG:STIme.....	174
LOG:TRIGgered.....	175
LOG[:STATe].....	172
MEASure:VOLTag:e:DVM?.....	148
MEASure[:SCALar]:CURRent[:DC]:AVG?.....	145
MEASure[:SCALar]:CURRent[:DC]:MAX?.....	145
MEASure[:SCALar]:CURRent[:DC]:MIN?.....	145
MEASure[:SCALar]:CURRent[:DC]:STATistic?.....	146
MEASure[:SCALar]:CURRent[:DC]?.....	145
MEASure[:SCALar]:ENERgy:RESet.....	143
MEASure[:SCALar]:ENERgy:STATe.....	144
MEASure[:SCALar]:ENERgy:UNIT.....	144
MEASure[:SCALar]:ENERgy?.....	143
MEASure[:SCALar]:POWer:AVG?.....	146
MEASure[:SCALar]:POWer:MAX?.....	146
MEASure[:SCALar]:POWer:MIN?.....	147
MEASure[:SCALar]:POWer:STATistic?.....	147
MEASure[:SCALar]:POWer?.....	146
MEASure[:SCALar]:STATistic:COUnT?.....	144
MEASure[:SCALar]:STATistic:RESet.....	145
MEASure[:SCALar]:STATistic:RESet.....	145
MEASure[:SCALar][:POWer]:AVG?.....	146
MEASure[:SCALar][:POWer]:MAX?.....	146
MEASure[:SCALar][:POWer]:MIN?.....	147
MEASure[:SCALar][:VOLTag:e][:DC]:AVG?.....	147
MEASure[:SCALar][:VOLTag:e][:DC]:MAX?.....	147
MEASure[:SCALar][:VOLTag:e][:DC]:MIN?.....	148

MEASure[:SCALar][:VOLTage][:DC]:STATistic?	148
MEASure[:SCALar][:VOLTage][:DC]?	147
OUTPut:DELay:DURation	122
OUTPut:DELay[:STATe]	123
OUTPut:FTResponse	123
OUTPut:GENeral[:STATe]	122
OUTPut:IMPedance	124
OUTPut:IMPedance:STATe	124
OUTPut:MODE	125
OUTPut:SELect	125
OUTPut:TRIGgered	126
OUTPut:TRIGgered:BEHavior	126
OUTPut:TRIGgered[:STATe]	126
OUTPut[:STATe]	122
READ?	120
SENSe:CURRent:RANGe:AUTO	127
SENSe:CURRent:RANGe[:UPPer]	128
SENSe:VOLTage:RANGe:AUTO	128
SENSe:VOLTage:RANGe[:UPPer]	128
STATus:OPERation:INSTrument:CONDition?	175
STATus:OPERation:INSTrument:ENABle	176
STATus:OPERation:INSTrument:ISUMmary<Channel>:CONDition?	175
STATus:OPERation:INSTrument:ISUMmary<Channel>:ENABle	176
STATus:OPERation:INSTrument:ISUMmary<Channel>:NTRansition	176
STATus:OPERation:INSTrument:ISUMmary<Channel>:PTRansition	177
STATus:OPERation:INSTrument:ISUMmary<Channel>[:EVENT]?	176
STATus:OPERation:INSTrument:NTRansition	176
STATus:OPERation:INSTrument:PTRansition	177
STATus:OPERation:INSTrument[:EVENT]?	176
STATus:QUEStionable:INSTrument:CONDition?	178
STATus:QUEStionable:INSTrument:ENABle	178
STATus:QUEStionable:INSTrument:ISUMmary<Channel>:CONDition?	178
STATus:QUEStionable:INSTrument:ISUMmary<Channel>:ENABle	178
STATus:QUEStionable:INSTrument:ISUMmary<Channel>:NTRansition	179
STATus:QUEStionable:INSTrument:ISUMmary<Channel>:PTRansition	179
STATus:QUEStionable:INSTrument:ISUMmary<Channel>[:EVENT]?	178
STATus:QUEStionable:INSTrument:NTRansition	179
STATus:QUEStionable:INSTrument:PTRansition	179
STATus:QUEStionable:INSTrument[:EVENT]?	178
SYSTem:BEEPer:CURRent:STATe	99
SYSTem:BEEPer:PROTection:STATe	99
SYSTem:BEEPer:PROTection[:IMMEdiate]	99
SYSTem:BEEPer:STATe	100
SYSTem:DATE	101
SYSTem:KEY:BRIGhtness	100
SYSTem:LOCal	100
SYSTem:REMote	100
SYSTem:RWLock	100
SYSTem:TIME	101
TRIGger[:SEQuence][:IMMEdiate]:SOURce	103

TRIGger[:SEQuence][:IMMediate]:SOURce:DIO:CHANnel.....	103
TRIGger[:SEQuence][:IMMediate]:SOURce:DIO:PIN.....	104
TRIGger[:SEQuence][:IMMediate]:SOURce:OMODE.....	104
TRIGger[:SEQuence][:IMMediate]:SOURce:OMODE:CHANnel.....	105
TRIGger[:SEQuence][:IMMediate]:SOURce:OUTPut:CHANnel.....	105
TRIGger[:STATe].....	102

# Index

## A

Activate channel output .....	45
Activating the channels output .....	26
Advanced features	
Arbitrary .....	67
Ramp .....	67
Advanced operating commands	
Arbitrary .....	149
Battery Simulation .....	159
Digital I/O .....	156
Ramp .....	155
Alert beep .....	92
Arbitrary .....	67

## B

Battery simulator .....	54
Battery model editor .....	56

## C

Channel display area	
Operating mode .....	32
Clear status	
Remote .....	96
Command sequence	
Remote .....	98
Command sequence and synchronization .....	185
Configuration commands	
Channel selection .....	106
Combined setting of voltage and current setting .....	119
Current setting .....	114
OCP setting .....	129
OPP setting .....	139
Output setting .....	120
OVP setting .....	136
Range/DVM setting .....	126
Resistance setting .....	117
Safety limit setting .....	107
USB class setting .....	142
Voltage setting .....	111
Constant resistance .....	46
CSV settings .....	76
Customer support .....	28

## D

Data logging .....	73
CSV settings .....	73
Date .....	93
Default values	
Remote .....	97
Delivery package contents .....	19
Device documentation .....	95
Device/Channel menu window .....	37
Digital I/O .....	62
Digital voltmeter .....	52
Measurement ranges .....	53
Display brightness .....	92
Display overview .....	29
Channel display area .....	32
Status bar information .....	29
Documentation overview .....	9

DVM .....	52
-----------	----

## E

Electrostatic discharge .....	15
ESD .....	15
Event status enable register (ESE)	
Remote .....	96
Event status register (ESR)	
Remote .....	97

## F

Factory default settings .....	81
Fast transient response .....	47
FastLog .....	75
File manager	
Copy .....	80
Delete .....	80
Front panel	
Display .....	21
Menu control keys .....	21
Output and channel keys .....	22
Output terminals .....	22
Power key .....	22
Rotary knob and back keys .....	21
USB connector .....	22
Front panel keys .....	37
Menu controls .....	37
Navigation controls .....	40
Output and channel controls .....	41
Settings key .....	37

## G

General instrument settings .....	90
Appearance settings .....	92
Data and time .....	93
Device information .....	94
Licenses management .....	90
Sound settings .....	92
Update device .....	94
Getting Started .....	9
Graphical view window .....	78

## I

Identification	
Remote .....	97
Important notes	
Ambient conditions .....	12
Limits .....	14
Mains voltage .....	13
Measurement categories .....	13
Symbols .....	12
Instrument tour .....	20
Overview of controls .....	20
switching on NGL/NGM .....	24
Intended operation .....	17
Interfaces .....	83

## K

Key brightness .....	92
----------------------	----

**M**

Maintenance	
Cleaning	27
Menu	
Channel menu	39
Device menu	37
Menu controls	37
Home key	37
Settings key	37
User key	40
Message and command structure	
Messages	180
SCPI command structure	181
Mode	
Operation modes	42

**N**

Navigation controls	40
Back key	41
Rotary knob	41
Network	
GPIB	89
LAN	85
USB	88
Wireless LAN	87
Network connection	84

**O**

Open source acknowledgment (OSA)	10
Operation complete	
Remote	97
Operation modes	
Constant current (CC)	42
Constant resistance (CR)	43
Constant voltage (CV)	42
Options	
Identification (remote)	97
Output	48
Delay	49
Impedance	48
Output delay	49
Output mode	51
Trigger events	50
Output and channel controls	41
Overcurrent protection	58
Overpower protection	60
Overview of controls	
Front panel	20
Rear panel	22
Overvoltage protection	59

**P**

Power derating	41
Protection	
Fuse linking	58
Overcurrent protection	58
Overpower protection	58
Overvoltage protection	58
Safety limits	58
Putting into operation	15
Intended operation	17
Safety	16
Unpacking and checking the instrument	19

**R**

Ramp	70
Ranges	52
Rear panel	
AC inlet with fuse holder	23
Channel connectors	23
Digital I/O connector	24
Ethernet connector	23
IEEE-488 (GPIB) interface	23
USB connectors	23
Voltage selector	23
Recall	81
Release notes	10
Remote control commands	96
Advanced operating commands	149
Common setting commands	96
Configuration commands	105
Data and file management commands	166
Display commands	101
Measurement commands	142
Status reporting commands	175
System settings commands	99
Trigger commands	102
Reset values	
Remote	97

**S**

Safety	16
Safety instructions	9
Safety limits	61
Save	81
Screenshot	72
Selecting channels	44
Self-test	
Remote	98
Service request enable register (SRE)	
Remote	98
Set voltage and current	44
Setting the output voltage and current limit	26
Setting up the instrument	19
Bench operation	19
Rack mounting	20
Status bar information	
Channel status bar	31
Device status bar	30
Status byte	
Remote	96, 98
Status reporting system	186
Structure of a SCPI status register	186

**T**

Time	93
Trigger	62
Trigger IO system	63
Trigger-in signals	63
Trigger-out signals	64
Trying out the instrument	
Activating the channels output	25
Setting the output voltage and current limit	25

**U**

Unpacking and checking the instrument	19
User button key	71



User manual .....	9
Using the touchscreen .....	33
Accessing functionality using shortcuts .....	35
Accessing functionality using the settings button .....	33
Expand/Collapse button .....	35
Input data .....	36
Using gestures .....	33

**W**

Wait	
Remote .....	98
Welcome to R&S NGL/NGM .....	11