

Component Checklist

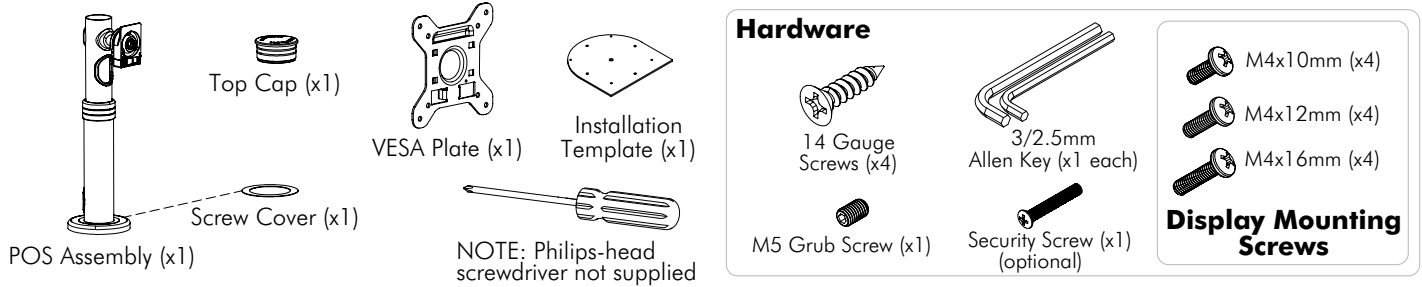

IMPORTANT INFORMATION:

! IMPORTANT - Install Spacedec POS Height Adjustable as per Installation Instructions.

- ! This product supports a maximum load of 20kg (44lbs).
- ! This product supports VESA mounting hole configurations: 75x75mm and 100x100mm.
- ! The height adjustment range (from desk level to the centre of the screen) 330-450mm (12.99"-17.72").
- ! The minimum thickness of the mounting surface is 15mm (0.59") when using the manufacturer supplied Hardware.
- ! The manufacturer accepts no responsibility for incorrect installation.

Mounting Options

Your SD-POS-HA offers 355° of Rotation. This can also be limited to suit a specific application. The direction in which you mount SD-POS-HA will determine where the 5° gap in rotation is located, and how you choose to limit the rotation.

Rotation Options
0° Rotation (Fixed)
0-90° Rotation
0-180° Rotation
0-270° Rotation
0-355° Rotation

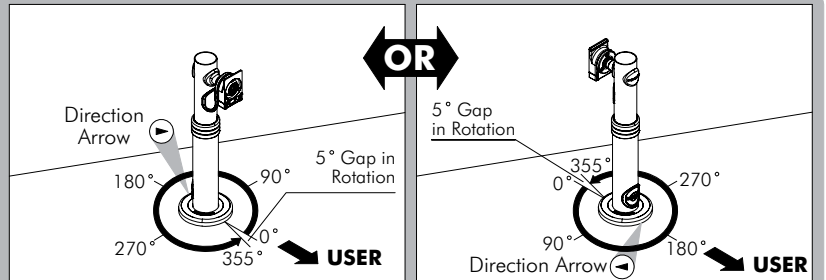

Step 1. Check Components

Check you have received all parts against the component checklist and Hardware above.

Step 2. Limit Rotation

- Determine the degree of rotation you require (refer to Mounting Options above).
 - To limit the rotation, use the 2.5mm Allen Key to insert the supplied M5 Grub Screw into your chosen Locking Hole until it sits flush with the Base Plate.
- NOTE: If you want the full 355° rotation, you do NOT need to install a grub screw.**

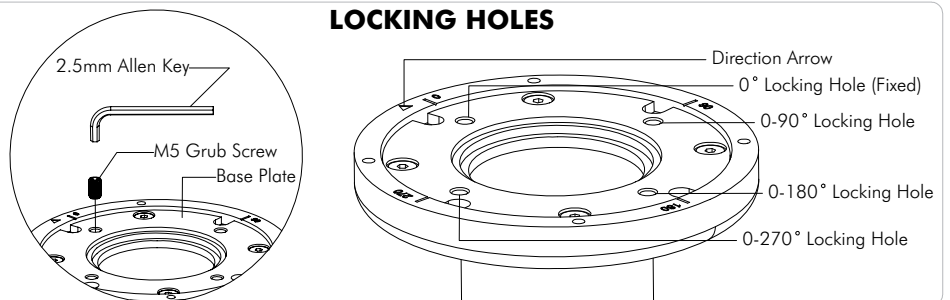

Step 3. Locate and Secure your POS Height Adjustable

- Position the Installation Template in the desired location on your work surface. Ensure the straight edge sits perpendicular with the User's line of sight. Mark the center points of each of the required holes onto the work surface with a pencil.
- Drill 4 x 3mm (0.12") Pilot Holes to a depth of 15mm (0.59"). Use a 45mm (1.75") hole saw to drill the Cable Access Hole in the work surface.
- Reposition SD-POS-HA with the "Direction Arrow" pointing in the direction required for your chosen rotation. Secure the SD-POS-HA to the work surface using the supplied 14 Gauge Screws (x4).

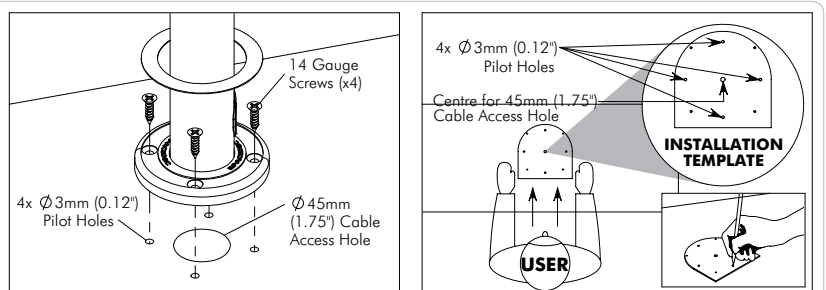

Step 4. Attach Screw Cover

Remove the paper backing from the Screw Cover and adhere to the base as shown.

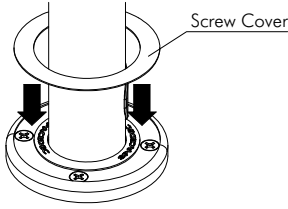

Step 5. (Optional) Install Monitor Security Cable

- Loop the Security Cable (Kensington or similar) around the internal post of the POS Assembly.
- Feed the other end of the cable through the POS Assembly and out the Cable Management Hole.
- After you have attached the monitor (As directed in Step 9) install the lock to the monitor as per the manufacturer guidelines.

Note: Security Cable Not Included

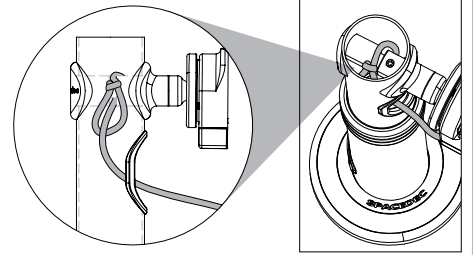

Step 6. Install Top Cap

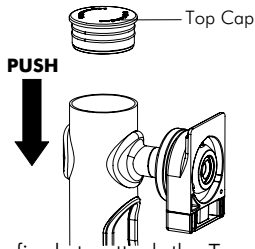

Push down firmly to attach the Top Cap.

Step 7. Adjust Pole Height

- Loosen Hand Grip.
- Set to desired Height.
- Tighten Hand Grip to lock pole at desired height.

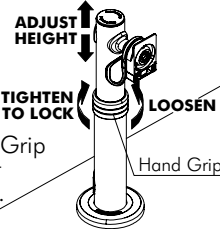

Step 8. Install Monitor Cables

Option 1:

Prior to attaching your monitor, install the monitor cables.

Run them through the Front Cable Access Port, down the pole and out of the Cable Access Hole in the work surface.

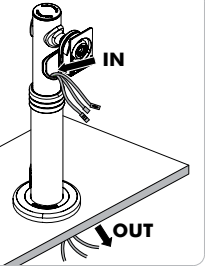

Step 8. Install Monitor Cables

Option 2: When you do not want to route the cables below the work surface.

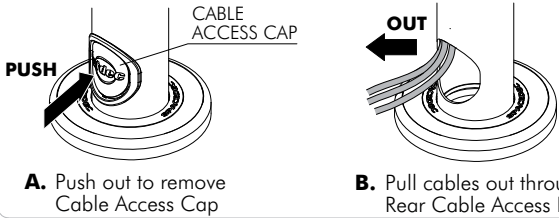

Step 9. Attach the VESA Plate to your Display

There are two mounting hole configurations:

- 75 x 75mm
- 100 x 100mm

Choose appropriate Mounting Screws from the Hardware supplied to suit your Display.

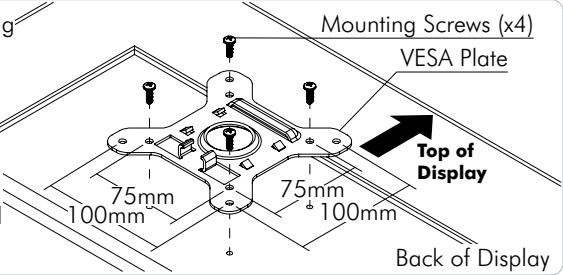

Step 10. Attach your Display to the POS Assembly

Hook the top of the VESA plate onto the Quickshift Mount.

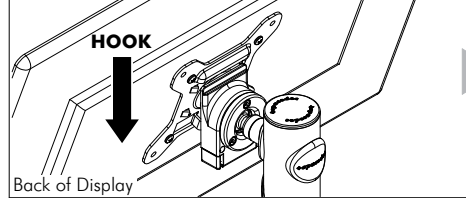

Press and hold the Release Buttons. Gently push bottom of VESA Plate into Quickshift Mount. Release Buttons to lock in place.

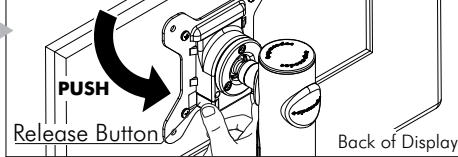

Insert the Security Screw, and tighten using a Phillips-head Screwdriver

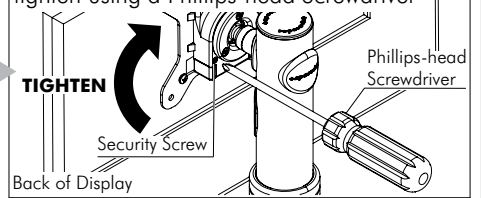

Step 11. Adjust the VESA Ball Mount

Position your Display to the desired viewing angle using the 40° angular movement allowed by the VESA Ball Mount.

If the display does not hold its position, or is too resistant, adjust the Tension Plate located at the rear of the VESA Ball Mount.

To make any adjustments, use the 3mm Allen Key supplied. Apply half a turn at a time to each screw on the Tension Plate to adjust evenly.

Check the display, and the adjust again if necessary.

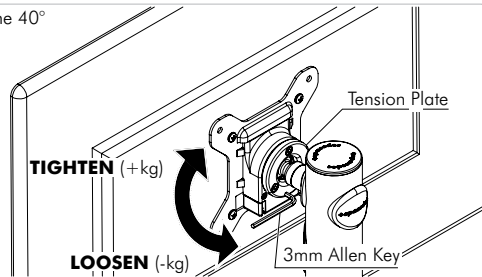

Advanced Security Installation

These Installation Instructions secure the SD-POS-HA using the provided fasteners from the above work surface.

For advanced Security Installation from below the work surface. Please refer to the *Advanced Security Installation Addendum*.

Installation Complete

