



SH963  
Digital Projector  
User Manual



# Table of contents

## Important safety

### instructions ..... 3

### Overview ..... 6

Shipping contents ..... 6

Remote control batteries ..... 7

Remote control operation ..... 7

Projector features ..... 8

Projector exterior view ..... 9

Controls and functions ..... 10

Control panel ..... 10

Remote control ..... 11

### Positioning your projector. 12

Choosing a location ..... 12

Obtaining a preferred projected image size ..... 13

Projection dimensions ..... 14

Shifting the projection lens ..... 16

### Connecting to video

### equipment ..... 17

Preparations ..... 17

Connecting HDMI devices ..... 17

Connecting component-video devices ... 18

Connecting video devices ..... 18

Connecting a computer ..... 19

Connecting a monitor ..... 19

### Using the projector ..... 20

Turning the projector on ..... 20

Selecting an input source ..... 21

Using the menus ..... 22

Securing the projector ..... 22

Using a security cable lock ..... 22

Utilizing the password function ..... 23

Adjusting the projected image ..... 25

Adjusting the projection angle ..... 25

Auto-adjusting the image ..... 25

Fine-tuning the image size and clarity ..... 25

Correcting picture distortion ..... 26

Using the preset and user modes ..... 27

Fine-tuning the picture quality ..... 29

Advanced picture quality controls ..... 30

Selecting the aspect ratio ..... 33

Hiding the image ..... 35

Freezing the image ..... 35

Adjusting the sound ..... 36

Setting the lamp mode ..... 36

Controlling the projector through a

LAN environment ..... 37

Operating in a high altitude environment ..... 40

Displaying more than one image source simultaneously ..... 41

Turning the projector off ..... 42

On-Screen Display (OSD) menus ..... 43

### Additional information ..... 52

Care of the projector ..... 52

Lamp information ..... 53

Getting to know the lamp hour ..... 53

Extending lamp life ..... 53

Timing of replacing the lamp ..... 54

Replacing the lamp ..... 54

Indicators ..... 57

Troubleshooting ..... 58

Specifications ..... 59

### Warranty and Copyright

### information ..... 63

Thank you for your purchase of this quality BenQ projector! It has been designed to provide you with an enjoyable home theater viewing experience. For the best results, please read this manual through carefully as it is your guide through the control menus and operation.

# Important safety instructions

Your projector is designed and tested to meet the latest standards for safety of information technology equipment. However, to ensure safe use of this product, it is important that you follow the instructions mentioned in this manual and marked on the product.

1. Please read this user manual before you operate your projector. Keep this manual in a safe place for future reference.

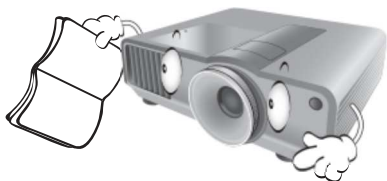

2. Always place the projector on a level, horizontal surface during operation.

- Do not place the projector on an unstable cart, stand, or table as it may fall and be damaged;
- Do not place inflammables near the projector;
- Do not use if tilted at an angle of more than 10 degrees left to right, nor at angle of more than 15 degrees front to back.

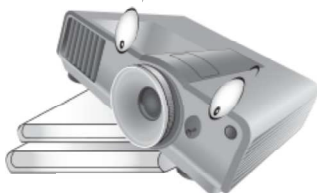

3. Do not store the projector on end vertically. Doing so may cause the projector to fall over, causing injury or resulting in damage.

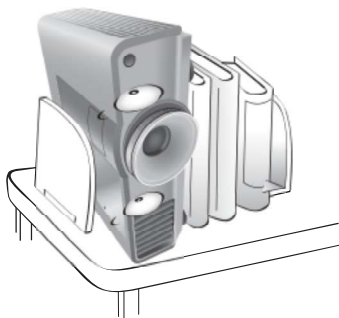

4. Do not place the projector in any of the following environments:

- space that is poorly ventilated or confined. Allow at least 50 cm clearance from walls and free flow of air around the projector;
- locations where temperatures may become excessively high, such as the inside of a car with all windows closed;
- locations where excessive humidity, dust, or cigarette smoke may contaminate optical components, shorten the projector's lifespan and darken the screen;

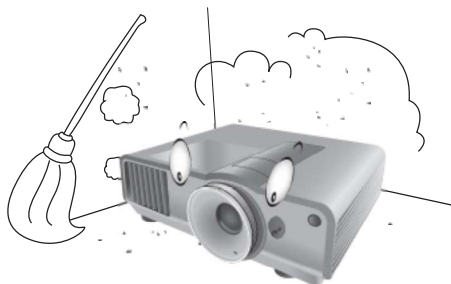

- locations near fire alarms;
- locations with an ambient temperature above 35°C/95°F;
- locations where altitude is higher than 1500 meters/4920 feet above sea level.

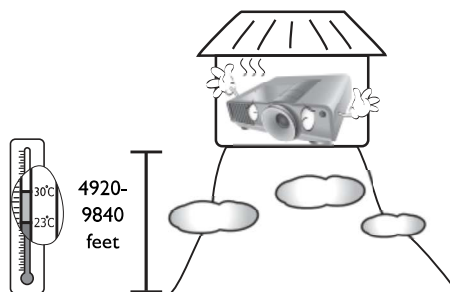

- 5. Do not block the vents holes while the projector is on (even in standby mode):
  - Do not cover the projector with any item;
  - Do not place the projector on a blanket, bedding or any other soft surface.

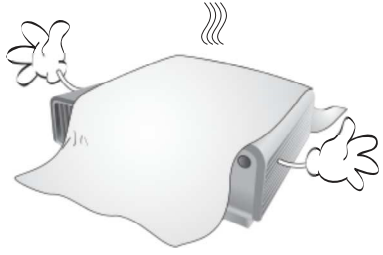

- 9. Do not look straight into the projector lens during operation. It may harm your sight.

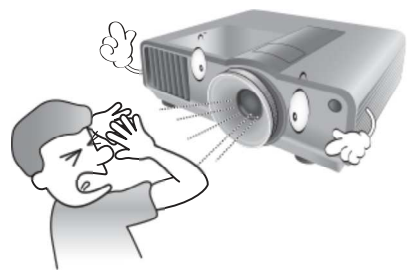

- 6. In areas where the mains power supply voltage may fluctuate by  $\pm 10$  volts, it is recommended that you connect your projector through a power stabilizer, surge protector or uninterruptible power supply (UPS) as appropriate to your situation.



- 10. Do not operate the projector lamp beyond the rated lamp life. Excessive operation of lamps beyond the rated life could cause a lamp to break on rare occasions.



- 7. Do not step on the projector or place any objects upon it.

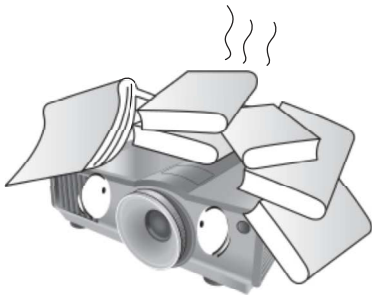

- 11. The lamp becomes extremely hot during operation. Allow the projector to cool for approximately 45 minutes prior to removing the lamp assembly for replacement.



- 8. Do not place liquids near or on the projector. Liquids spilled into the projector will void your warranty. If the projector does become wet, disconnect it from the power point and call BenQ to have the projector repaired.

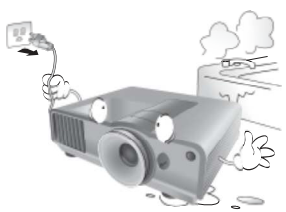

- 12. This projector is capable of displaying inverted images for ceiling mount installation. Use only BenQ's Ceiling Mount Kit for mounting.



- 13. Never attempt to replace the lamp assembly until the projector has cooled down and is unplugged from the power supply.



- 14. When you think service or repair is required, take the projector only to a suitably qualified technician.



- 15. Do not attempt to disassemble this projector. There are dangerous high voltages inside which may cause death if you should come into contact with live parts. The only user serviceable part is the lamp which has its own removable cover. See page 54.

Under no circumstances should you ever undo or remove any other covers. Refer servicing only to suitably qualified professional service personnel.



**⚠ Notice**

**Please keep the original packing for possible future shipment. If you need to pack your projector after use, adjust the projection lens to an appropriate position, put the lens cushion around the lens, and fit the lens cushion and projector cushion together to prevent damage during transportation.**

### Moisture condensation

Never operate the projector immediately after moving it from a cold location to a hot location. When the projector is exposed to such a change in temperature, moisture may condense on the crucial internal parts. To prevent the projector from possible damage, do not use the projector for at least 2 hours when there is a sudden change in temperature.

### Avoid volatile liquids

Do not use volatile liquids, such as insecticide or certain types of cleaner, near the projector. Do not have rubber or plastic products touching the projector for a long time. They will leave marks on the finish. If cleaning with a chemically treated cloth, be sure to follow the cleaning product's safety instructions.

### Disposal

This product contains the following materials which are harmful to human bodies and environment.

- Lead, which is contained in solder.
- Mercury, which is used in the lamp.

To dispose of the product or used lamps, consult your local environment authorities for regulations.

# Overview

## Shipping contents

Carefully unpack and verify that you have the items below. Some of the items may not be available depending on your region of purchase. Please check with your place of purchase.

 Some of the accessories may vary from region to region.

**The warranty card is only supplied in some specific regions. Please consult your dealer for detailed information.**

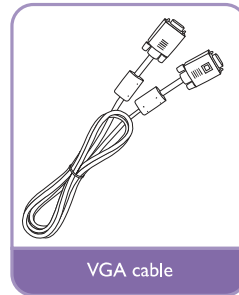
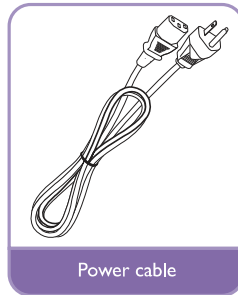

# Remote control batteries

1. To open the battery cover, turn the remote control over to view its back, push on the finger grip on the cover and slide it up in the direction of the arrow as illustrated. The cover will slide off.
2. Remove any existing batteries (if necessary) and install two new AAA batteries observing the battery polarities as indicated in the base of the battery compartment. Positive (+) goes to positive and negative (-) goes to negative.
3. Refit the cover by aligning it with the case and sliding it back up into position. Stop when it clicks into place.

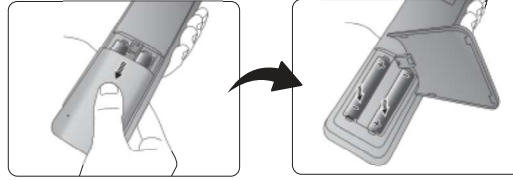

## Notes on handling batteries

- Do not mix old batteries with new ones, or mix different types of batteries.
- Avoid leaving the remote control and batteries in an excessive hot or humid environment like the kitchen, bathroom, sauna, sunroom, or in a closed car.
- Dispose of used batteries according to the battery manufacturer's instructions and local environment regulations for your region.
- If the remote control will not be used for an extended period of time, remove the batteries to avoid damage to the control from possible battery leakage.

# Remote control operation

- Make sure that there is nothing positioned between the remote control and the infrared (IR) sensors on the projector that might obstruct the IR beam from the remote control reaching the projector.
- The effective range of the remote control is up to 8 meters, and at an angle within 30 degrees of the IR beam. Always aim straight at the projector, however most screens will also reflect the IR beam to the projector.

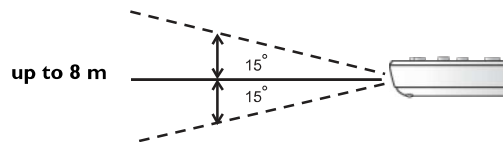

## ⚠ Ceiling mounting the projector

We want you to have a pleasant experience using your BenQ projector, so we need to bring this safety matter to your attention to prevent damage to person and property.

If you intend to mount your projector on the ceiling, we strongly recommend that you use a proper fitting BenQ projector ceiling mount kit and that you ensure it is securely and safely installed.

If you use a non-BenQ brand projector ceiling mount kit, there is a safety risk that the projector may fall from the ceiling due to an improper attachment through the use of the wrong gauge or length screws.

You can purchase a BenQ projector ceiling mount kit from the place you purchased your BenQ projector. BenQ recommends that you also purchase a separate Kensington lock compatible security cable and attach it securely to both the Kensington lock slot on the projector and the base of the ceiling mount bracket. This will perform the secondary role of restraining the projector should its attachment to the mounting bracket become loose.

# Projector features

- **Full HD compatible**

The projector is compatible with Standard Definition TV (SDTV) 480i, 480p, 576i, 576p, and High Definition TV (HDTV) 720p, 1080i and 1080p formats, with the 1080p format providing a true 1:1 image reproduction.
- **High picture quality**

The projector provides excellent picture quality due to its high resolution, excellent home theater brightness, super high contrast ratio, vivid color and rich gray-scale reproduction.
- **High brightness**

The projector features super high brightness to achieve excellent picture quality in ambient light conditions, outperforming ordinary projectors.
- **Vivid color reproduction**

The projector features a 6-segment color wheel to produce realistic color depth and range unattainable with lesser segment color wheels.
- **Rich gray-scale**

When viewed in a darkened environment, the automatic gamma control provides excellent gray-scale display which reveals details in shadows and in night or darkened scenes.
- **Intuitive lens shift**

The intuitive control over lens shift lever provides flexibility in setting-up your projector.
- **Wide variety of inputs and video formats**

The projector supports a wide variety of inputs for connection to your video and PC equipment, including component video, composite video, HDMI, PC, and an output trigger for connection to automated screen and environment lighting systems.
- **Professional calibration control**

To reach a higher standard of performance, the projector incorporates Expert Mode settings in its OSD menus, which requires professional calibration service from authorized installers.
- **Panamorph lenses compatible**

The projector is compatible with Panamorph lenses that allow you to convert 16:9 projectors to 2.35:1 aspect ratio.



# Projector exterior view

## Front and upper side view



1. Control panel (See "Control panel" on page 10 for details.)
2. Lamp cover
3. Vent (heated air exhaust)
4. Projection lens
5. Kensington lock slot
6. Vent (cold air intake)
7. Front IR sensor
8. Lens shift lever

## Rear view

See "Connecting to video equipment" on page 17 for connection details.

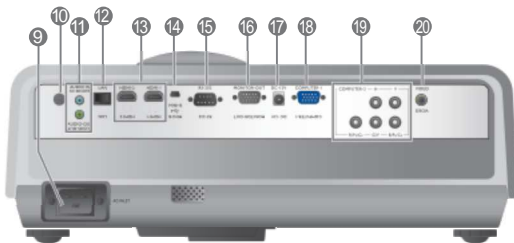

9. AC Power cable inlet
10. Rear IR sensor
11. Audio input jack  
Audio output jack
12. RJ45 LAN input jack
13. HDMI port
14. Mini B type USB port
15. RS-232 control port  
Used to interface with a PC or home theater control/automation system.
16. RGB signal output jack
17. 12VDC output terminal  
Used to trigger external devices such as an electric screen or light control, etc. Consult your dealer for how to connect these devices.
18. RGB (PC)/Component video (YPbPr/YCbCr) signal input jack
19. Component Video inputs (BNC)/RGBHV 5 BNCs for connecting either RGB or component (YPbPr),SD or HD video signals
20. Video input jack

## Under view

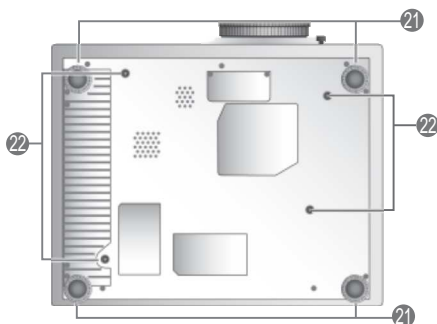

21. Adjustable feet
22. Ceiling mount holes

# Controls and functions

## Control panel



- 1. Focus ring**  
Adjusts the focus of the projected image.
- 2. Zoom ring**  
Adjusts the size of the projected image.
- 3. TEMPERATURE warning light**  
Lights up or flashes if the projector's temperature becomes too high.
- 4. POWER indicator light**  
Lights up or flashes when the projector is operating.
- 5. MODE**  
Sequentially selects a predefined picture setting available for each input.
- 6. ⏻ POWER**  
Performs the same action as **POWER** on the remote control.  
Toggles the projector between standby and on.
- 7. Arrow/Keystone keys (Left ◀/▷, Up ▲/▼, Right ▶/◀, Down▼/▲)**  
Moves the current On-Screen Display (OSD) menu selection in the direction of the arrow being pressed when the OSD menu is activated.  
Manually corrects distorted pictures resulting from an angled projection.
- 8. MENU/EXIT**  
Toggles the On-Screen Display (OSD) menu on and off.  
Goes back to previous OSD menus, exits and saves any changes made using the On-Screen Display (OSD) menu.
- 9. ENTER**  
Enacts the selected On-Screen Display (OSD) menu item.
- 10. ECO BLANK**  
Used to hide the screen image.
- 11. LAMP indicator light 1, 2**  
Lights up or flashes when the projector lamp has developed a problem.
- 12. ASPECT**  
Selects the display aspect ratio.
- 13. AUTO**  
Automatically determines the best picture timings for the displayed image.
- 14. SOURCE**  
Performs the same action as the source selection keys on the remote control.  
Switches sequentially through input sources.

# Remote control

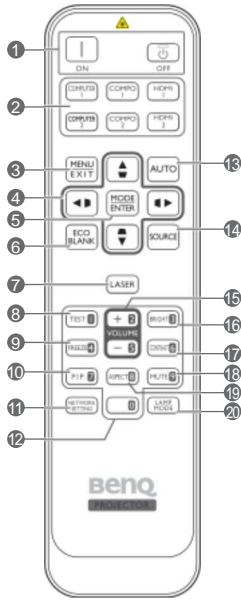

1. **Power ON/OFF**  
Toggles the projector between standby mode and on.
2. **Source selection keys**  
Selects an input source for display.
3. **MENU/EXIT**  
Turns on the On-Screen Display (OSD) menu. Goes back to previous OSD menu, exits and saves menu settings.
4. **Arrow/Keystone keys (Left ◀/▷, Up ▲/◻, Right ▶/◻, Down ▼/◻)**  
Moves the current On-Screen Display (OSD) menu selection in the direction of the arrow being pressed when the OSD menu is activated. Manually corrects distorted pictures resulting from an angled projection.
5. **MODE/ENTER**  
Activates the selected On-Screen Display (OSD) menu item.  
Depending upon the input signal in use, selects an available picture mode.
6. **ECO BLANK**  
Used to hide the screen image.
7. **LASER**  
Emits visible laser pointer light for presentation purposes.

8. **TEST**  
Displays the test pattern.
  9. **FREEZE**  
Freezes the projected image.
  10. **PIP**  
Displays the Picture In Picture (PIP) windows.
  11. **NETWORK SETTING**  
Enters network settings directly.
  12. **Numeric buttons**  
Enters numbers in network settings.
- ☞ **Numeric buttons 1, 2, 3, 4 cannot be pressed when asked to enter password.**

13. **AUTO**  
Automatically determines the best picture timings for the displayed image.
14. **SOURCE**  
Selects an input source for display.
15. **VOLUME+/VOLUME-**  
Adjusts the sound level.
16. **BRIGHTNESS**  
Adjusts brightness.
17. **CONTRAST**  
Adjusts contrast.
18. **MUTE**  
Toggles projector audio between on and off.
19. **ASPECT**  
Selects the display aspect ratio.
20. **LAMP MODE**  
Selects a preferred lamp mode.

## Operating the LASER pointer

The Laser Pointer is a presentation aid for professionals. It emits red colored light when you press it and the indicator lights up red.

Avoid Exposure  
Laser radiation is emitted from this aperture



The laser pointer is not a toy. Parents should be mindful of the dangers of laser energy and keep this remote control out of the reach of children.

⚠ **Do not look into the laser light window or shine the laser light beam on yourself or others. See the warning messages on the back of the remote control prior to using it.**

# Positioning your projector

## Choosing a location

Your projector is designed to be installed in one of four possible installation locations.

Your room layout or personal preference will dictate which installation location you select. Take into consideration the size and position of your screen, the location of a suitable power outlet, as well as the location and distance between the projector and the rest of your equipment.

### 1. Floor Front:

Select this location with the projector placed near the floor in front of the screen. This is the most common way to position the projector for quick setup and portability.

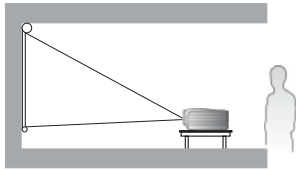

### 2. Ceiling Front:

Select this location with the projector suspended from the ceiling in front of the screen.

Purchase the BenQ Projector Ceiling Mount Kit from your dealer to mount your projector on the ceiling.

**\*Set Ceiling Front after you turn the projector on.**

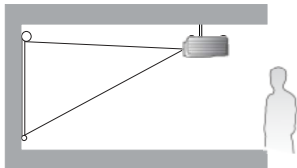

### 3. Floor Rear:

Select this location with the projector placed near the floor behind the screen.

Note that a special rear projection screen is required.

**\*Set Floor Rear after you turn the projector on.**

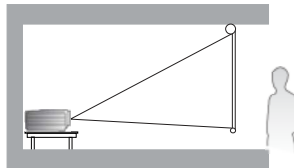

### 4. Ceiling Rear:

Select this location with the projector suspended from the ceiling behind the screen.

Note that a special rear projection screen and the BenQ Projector Ceiling Mount Kit are required for this installation location.

**\*Set Ceiling Rear after you turn the projector on.**

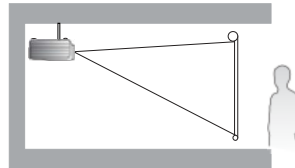

**\*To set the projector position:**

1. Press **MENU/EXIT** and then press **◀/▶** until the **System Setup** menu is highlighted.
2. Press **▲/▼** to highlight **Projector Position** and press **◀/▶** until the correct position is selected.

# Obtaining a preferred projected image size

The distance from the projector lens to the screen, the zoom setting, and the video format each factors in the projected image size.

This projector is equipped with a movable lens. See ["Shifting the projection lens" on page 16](#) for details. You can see the diagrams on pages [14](#) and [15](#) for the vertical offset values in the dimension tables that are measured when the lens is shifted fully up or down.

If you are using a 120-inch, 4:3-aspect-ratio screen, please refer to ["The screen aspect ratio is 4:3 and the projected picture is 4:3"](#). The average projection distance is 494 cm.

If you have a 16:9-aspect-ratio screen and your measured projection distance was 4.5 m (450 cm), please refer to ["The screen aspect ratio is 16:9 and the projected picture is 16:9"](#). The closest match in the ["Average"](#) column is 449 cm. Looking across this row shows that a 100-inch screen is required.

Checking the min and max projection distance values in the columns of ["Projection distance <D> \[cm\]" on page 14](#) indicates that the 4.5 m measured projection distance will also fit the 90 and 110-inch size screens. The projector can be adjusted (using the zoom control) to display on these different screen sizes at the projection distance. Be aware that these different screens have different vertical offset values.

If you place the projector in a different position (to that recommended), you will have to tilt it down or up to center the image on the screen. In these situations, some image distortion will occur. Use the Keystone function to correct the distortion. See ["Correcting picture distortion" on page 26](#) for details.

## Projection dimensions

### Installation for a 16:9 ratio screen

#### Floor Installation

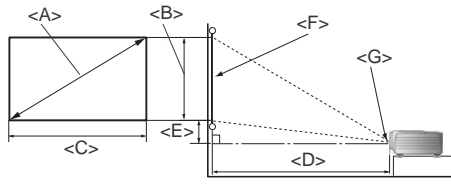

<F>: Screen      <G>: Center of lens

#### Ceiling Installation

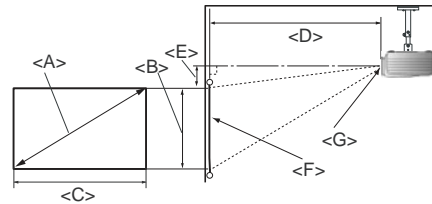

<F>: Screen      <G>: Center of lens

#### ■ The screen aspect ratio is 16:9 and the projected picture is 16:9

Screen dimensions			Projection distance <D> [cm]			Lowest/Highest lens position <E> [cm]
Diagonal <A> [inch (mm)]	Height <B> [cm]	Width <C> [cm]	Min distance (with max zoom)	Average	Max distance (with min zoom)	
30 (762)	37	66	108	135	162	4.7
40 (1016)	50	89	144	180	215	6
50 (1270)	62	111	180	224	269	8
60 (1524)	75	133	215	269	323	9
70 (1778)	87	155	251	314	377	11
80 (2032)	100	177	287	359	431	12
90 (2286)	112	199	323	404	485	14
100 (2540)	125	221	359	449	539	16
110 (2794)	137	243	495	494	592	17
120 (3048)	149	266	431	539	646	19
130 (3302)	162	288	467	583	700	20
140 (3556)	174	310	503	628	754	22
150 (3810)	187	332	539	673	808	23
160 (4064)	199	354	575	718	862	25
170 (4318)	212	376	610	763	916	26
180 (4572)	224	398	646	808	969	28
190 (4826)	237	421	682	853	1023	30
200 (5080)	249	443	718	898	1077	31
250 (6350)	311	553	898	1122	1346	39
300 (7620)	374	664	1077	1346	1616	47

☞ The above numbers are approximate and may be slightly different from the actual measurements. Only the recommended screen sizes are listed. If your screen size is not in the table above, please contact your dealer for assistance.

## Installation for a 4:3 ratio screen

The illustrations and table below are provided for those users who already have 4:3 aspect ratio screens or intend to purchase 4:3 aspect ratio screens to view 4:3 ratio projected images.

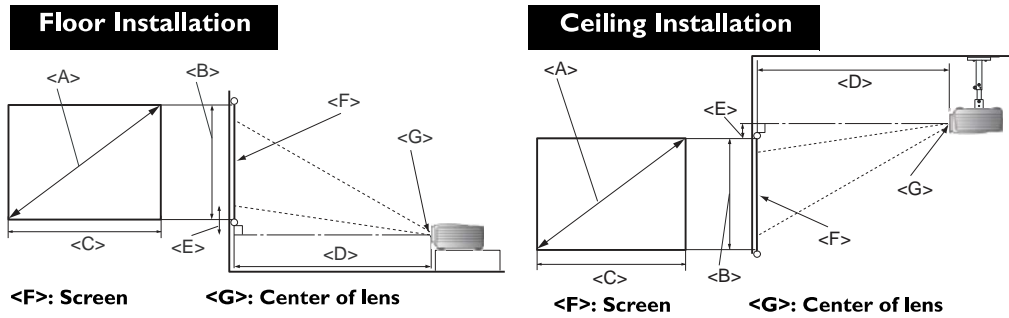

### ■ The screen aspect ratio is 4:3 and the projected picture is 4:3

Screen dimensions			Projection distance <D> [cm]			Lowest/ Highest lens position <E> [cm]	Image height <H> [cm]
Diagonal <A> [inch (mm)]	Height <B> [cm]	Width <C> [cm]	Min distance (with max zoom)	Average	Max distance (with min zoom)		
30 (762)	46	61	99	124	148	4.3	34.3
40 (1016)	61	81	132	165	198	5.7	45.7
50 (1270)	76	102	165	206	247	7.1	57.2
60 (1524)	91	122	198	247	297	8.6	68.6
70 (1778)	107	142	231	288	346	10.0	80.0
80 (2032)	122	163	264	330	395	11.4	91.4
90 (2286)	137	183	297	371	445	12.9	102.9
100 (2540)	152	203	330	412	494	14.3	114.3
110 (2794)	168	224	363	453	544	15.7	125.7
120 (3048)	183	244	395	494	593	17.1	137.2
130 (3302)	198	264	428	536	643	18.6	148.6
140 (3556)	213	284	461	577	692	20.0	160.0
150 (3810)	229	305	494	618	742	21.4	171.5
160 (4064)	244	325	527	659	791	22.9	182.9
170 (4318)	259	345	560	700	840	24.3	194.3
180 (4572)	274	366	593	742	890	25.7	205.7
190 (4826)	290	386	626	783	939	27.1	217.2
200 (5080)	305	406	659	824	989	28.6	228.6
250 (6350)	381	508	824	1030	1236	35.7	285.8
300 (7620)	457	610	989	1236	1483	42.9	342.9

The above numbers are approximate and may be slightly different from the actual measurements. Only the recommended screen sizes are listed. If your screen size is not in the table above, please contact your dealer for assistance.

## Shifting the projection lens

The lens shift control provides flexibility for installing your projector. It allows the projector to be positioned off the center of the screen.

The lens shift is expressed as a percentage of the projected image height or width. It is measured as an offset from the projected image's vertical or horizontal center. You can use the lever to shift the projection lens in any direction within the allowable range depending on your desired image position.

### To use the lens shift lever:

1. Release the lever by turning it counterclockwise.
2. Move the lever to adjust the projected image position.
3. Lock the lever by turning it clockwise.

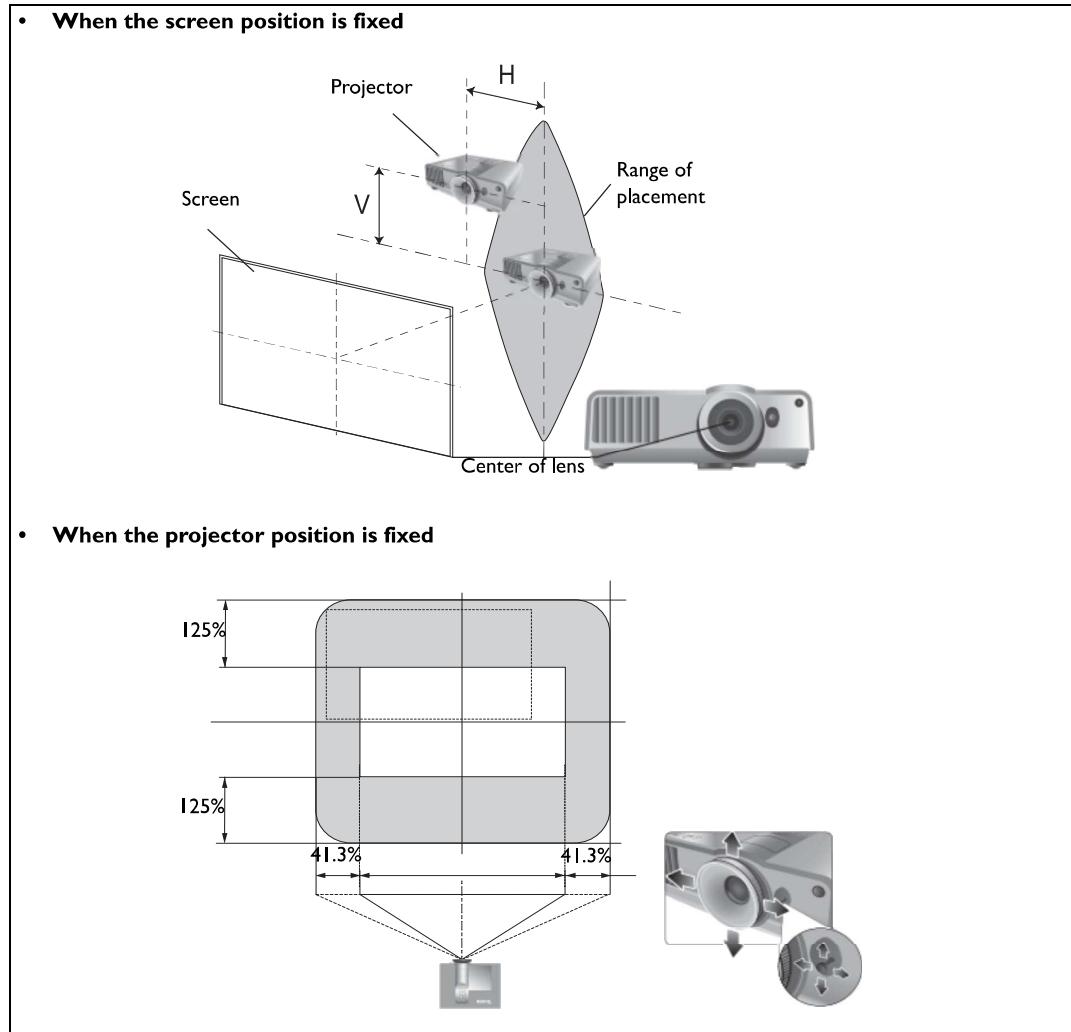









- **Please do not over-tighten the lever.**
- **Lens shift adjustment will not result in a degraded picture quality. In the unlikely event that the image distortion is produced, see ["Adjusting the projected image"](#) on page 25 for details.**



# Connecting to video equipment

You can connect the projector to any type of video equipment, such as a VCR, DVD player, digital tuner, cable or satellite decoder, video game console or digital camera. You can also connect it to a desktop or laptop PC or Apple Macintosh system. You can also connect the projector to a source device using just one of the connecting methods, however each provides a different level of video quality. The method you choose will most likely depend upon the availability of matching terminals on both the projector and the Video source device as described below:

Terminal name	Terminal appearance	Reference	Picture quality
HDMI		"Connecting HDMI devices" on page 17	 Best
Component Video		"Connecting component-video devices" on page 18	 Better
Video		"Connecting video devices" on page 18	 Normal
Computer (D-SUB)		"Connecting a computer" on page 19	 Better

## Preparations

**When connecting a signal source to the projector, be sure to:**

1. Turn off all equipment before making any connections.
2. Use only the correct type cables for each source with proper type plugs.
3. Ensure that all cable plugs are firmly fitted to the equipment jacks.

 **Note that all cables shown in the following connection diagrams may not be supplied with the projector (See "Shipping contents" on page 6 for details). Most cables are commercially available from electronics stores.**

## Connecting HDMI devices

HDMI (High-Definition Multimedia Interface) supports uncompressed video data transmission between compatible devices like DTV tuners, DVD players and displays over a single cable. It provides pure digital viewing and listening experience. You should use an HDMI cable when making connection between the projector and HDMI devices.

HDMI device: DVD player, digital tuner, etc.



HDMI cable

 **To make sure you select a correct input source type for the HDMI signal, see "HDMI Format" on page 50 for details.**



## Connecting component-video devices

Be sure to match the corresponding colors between the cables and the terminals. The BNC type component video jacks are provided for connection to video output devices. The audio connections are provided for informational purposes only. You can also connect the separate audio cable to a suitable audio amplifier.

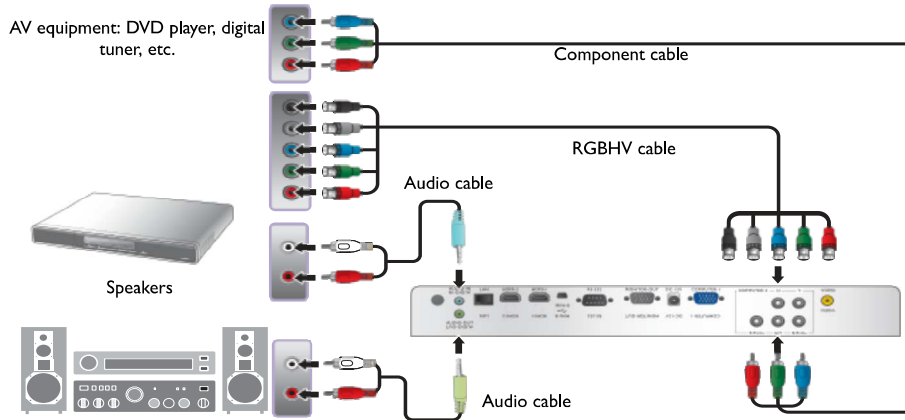

## Connecting video devices

The audio connections are provided for informational purposes only. You can also connect the separate audio cable to a suitable audio amplifier.

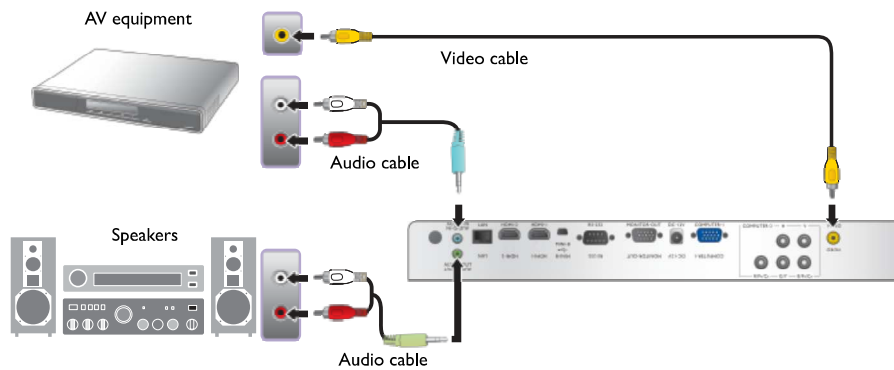

- If you have already made a Component Video connection between the projector and the video source device, you need not connect to this device again using a composite Video connection as this makes an unnecessary second connection of poorer picture quality.
- If the selected video image is not displayed after the projector is turned on and the correct video source has been selected, please check that the video source device is turned on and operating correctly. Also check that the signal cables have been connected correctly.

## Connecting a computer

Connect the projector to a computer with a VGA cable.

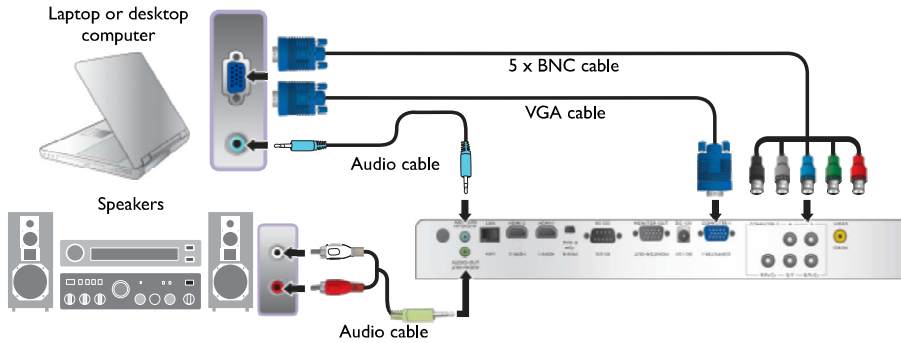

- ☞ Many laptops do not turn on their external video ports when connected to a projector. Usually a key combination like Fn + F3 or CRT/LCD key turns the external display on/off. Locate a function key labeled CRT/LCD or a function key with a monitor symbol on the laptop. Press Fn and the labeled function key simultaneously. Refer to your laptop's documentation to discover your laptop's key combination.

## Connecting a monitor

If you want to view your presentation close-up on a monitor as well as on the screen and the **MONITOR OUT** jack is available on your projector, you can connect the **MONITOR OUT** signal output jack on the projector.

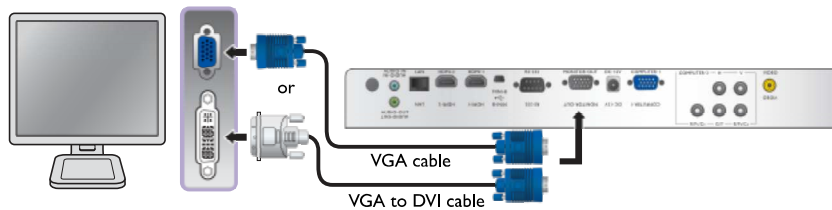

- ☞ • The **MONITOR OUT** only works when an appropriate D-Sub input is made to the PC jack.
- If you wish to use this connection method when the projector is in standby mode, make sure the Standby Monitor Out function is turned on in the Advanced Setup menu. See "[Standby Monitor Out](#)" on page 49 for details.

# Using the projector

## Preparations

1. Plug in and turn all of the connected equipment on.
2. If not already in, plug the supplied power cable into the AC inlet on the rear of the projector.
3. Plug the power cable into a wall power outlet and turn the wall switch on.



⚠ Please use the original accessories (e.g. power cable) only with the device to avoid possible dangers such as electric shock and fire.

## Turning the projector on

### Follow the steps below

1. Make sure the Power light is orange after power has been applied.
2. Press **POWER** on the projector or **ON** on the remote control to start the projector. As soon as the lamp lights up, a "Power On Tone" will be heard.

To turn off the ring tone, see ["Turning off the Power On/Off Ring Tone" on page 36](#) for details.

3. The fans will start operating, and a start-up image will be displayed on the screen for a few seconds while it warms up.

👉 The projector will not respond to further commands while it is warming up.



4. If you are prompted for a password, press the arrow keys to enter a six-digit password. See ["Utilizing the password function" on page 23](#) for details.
5. Press one of the Source keys on the remote control, or press **SOURCE** on the projector repeatedly until your desired signal is selected. See ["Selecting an input source" on page 21](#) for details.
6. If the horizontal frequency of the input source exceeds the range of the projector, the message "No Signal" will be displayed on the screen. This message will remain on-screen until you change the input source to an appropriate one.

👉 If you attempt to re-start the projector shortly after shutdown, the fans may run for a few minutes to cool down. Press  Power again to start the projector after the fans stop and the Power indicator light turns orange.

# Selecting an input source

The projector can be connected to multiple equipment at the same time. When the projector is first turned on, it will attempt to reconnect with the input source which was in use when the projector was last shut down.

## To select the video source:

- **Using the remote control or projector**

Press one of the **Source** keys on the remote control, or press **SOURCE** repeatedly until your desired signal is selected.

- **Using the OSD menu**

1. Press **MENU/EXIT** and then press **◀/▶** until the **System Setup** menu is highlighted.
2. Press **▼** to highlight **Input Source** and press **ENTER**. The source selection bar is displayed.
3. Press **▲/▼** repeatedly until your desired signal is selected and press **ENTER**.

Once detected, the selected source information will be displayed on the screen for seconds. If there are multiple pieces of equipment connected to the projector, you can go back to the source selection bar again to search for other signals.

- If you want the projector to automatically search for the signals, select **On** in the **System Setup > Quick Auto Search** menu.
- If you want to use the PIP function, see "[Displaying more than one image source simultaneously](#)" on page 41 for details.

## Changing Color Space

In the unlikely event that you connect the projector to a **DVD player** via the projector's **HDMI** input and the projected picture displays wrong colors, please change the color space to **YUV**.

1. Press **MENU/EXIT** and then press **◀/▶** until the **Display** menu is highlighted.
2. Press **▼** to highlight **Color Space Conversion** and press **◀/▶** to select a suitable color space.

 This function is only available when the **HDMI** input port is in use.

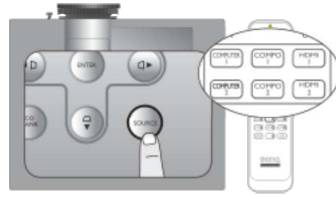

**NOTE:** When automatically searching for a valid input source, the projector cycles through the available signals following the sequence from top to bottom as the source selection bar shows.

# Using the menus

The projector is equipped with multilingual On-Screen Display (OSD) menus for making various adjustments and settings.

Below is the overview of the OSD menu.



To use the OSD menus, please set the OSD menu to your familiar language.

1. Press **MENU/EXIT** to turn the OSD menu on.
3. Press **▼** to highlight **Language** and press **◀/▶** to select a preferred language.



2. Use **◀/▶** to highlight the **System Setup** menu.
4. Press **MENU/EXIT** twice\* to leave and save the settings.



\*The first press leads you back to the main menu and the second press closes the OSD menu.

## Securing the projector

### Using a security cable lock

The projector has to be installed in a safe place to prevent theft. Otherwise, purchase a lock, such as the Kensington lock, to secure the projector. You can locate a Kensington lock slot on the projector. See item 5 on page 9 for details.

A Kensington security cable lock is usually a combination of key(s) and the lock. Refer to the lock's documentation for finding out how to use it.

## Utilizing the password function

For security purposes and to help prevent unauthorized use, the projector includes an option for setting up password security. The password can be set through the On-Screen Display (OSD) menu. Once the password is set and this function is selected, the projector is password-protected. Users who do not know the correct password can not use the projector.

**!** You will be inconvenienced if you activate the password functionality and subsequently forget the password. Print out this manual (if necessary) and write the password you used in this manual, and keep the manual in a safe place for later recall.

### Setting a password

**!** Once a password has been set and activated, the projector cannot be used unless the correct password is entered every time the projector is started.

1. Press **MENU/EXIT** and then press **◀/▶** until the **Advanced Setup** menu is highlighted.
2. Press **▼** to highlight **Password** and press **ENTER**. The **Password** page is displayed.
3. Highlight **Password** and press **◀/▶** to select **On**. The **Input Password** page is displayed.
4. As the picture indicates, the four arrow keys (**▲**, **▶**, **▼**, **◀**) respectively picture represent 4 digits (1, 2, 3, 4). According to the password you desire to set, press the arrow keys on the remote control or projector to enter six digits for the password.



If the function is used for the first time, enter the default password (1, 1, 1, 1, 1, 1) of the projector by pressing the arrow key **▲** six times.

Once the password is set, the OSD menu returns to the **Password** page.

**IMPORTANT:** The digits being input will be displayed as asterisks on-screen. Write your selected password down here in this manual in advance or right after the password is entered so that it is available to you should you ever forget it.

Password: \_ \_ \_ \_ \_ \_

5. To leave the OSD menu, press **MENU/EXIT**.

### If you forget the password

If the password function is activated, you will be asked to enter the six-digit password every time you turn on the projector. If you enter the wrong password, the password error message is displayed lasting for three seconds, and the Input Password page follows. You can retry by entering another six-digit password, or if you did not record the password in this manual, and you absolutely do not remember it, you can use the password recall procedure. See ["Entering the password recall procedure"](#) on page 24 for details.

If you enter an incorrect password 5 times in succession, the projector will automatically shut down in a short time.

## Entering the password recall procedure

1. Make sure the **Input Password** page is displayed on screen. Press **MODE**. The projector will display a coded number on the screen.
2. Write down the number and turn off your projector.
3. Seek help from the local BenQ service center to decode the number. You may be required to provide proof of purchase documentation to verify that you are an authorized user of the projector.

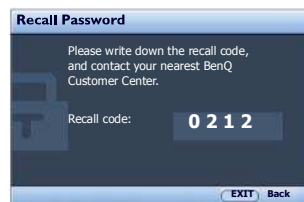

## Changing the password

1. Press **MENU/EXIT** and then press **◀/▶** until the **Advanced Setup** menu is highlighted.
2. Press **▲/▼** to highlight **Password** and press **ENTER**. The **Password** page is displayed.
3. Highlight **Change Password** and press **ENTER**. The **Input Current Password** page is displayed.
4. Enter the old password.
  - If the password is correct, the message "**Input New Password**" is displayed.
  - If the password is incorrect, the password error message is displayed lasting for three seconds, and the message "**Input Current Password**" is displayed for your retry. You can press **MENU/EXIT** to cancel the change or try another password.

5. Enter a new password.

**IMPORTANT:** The digits being input will be displayed as asterisks on-screen. Write your selected password down here in this manual in advance or right after the password is entered so that it is available to you should you ever forget it.

Password: \_ \_ \_ \_ \_

Keep this manual in a safe place.

6. Confirm the new password by re-entering the new password.
7. You have successfully assigned a new password to the projector. Remember to enter the new password next time the projector is started.
8. To leave the OSD menu, press **MENU/EXIT**.

## Disabling the password function

To disable password protection, go back to the **Advanced Setup > Password > Password** menu. Highlight **Password** and select Off by pressing **◀/▶**. The message "**Input Password**" is displayed. Enter the current password.

- If the password is correct, the OSD menu returns to the **Password** page with "**Off**" shown in the row of **Password**. You will not have to enter the password next time when turning on the projector.
- If the password is incorrect, the password error message is displayed lasting for three seconds, and the message "**Input Password**" is displayed for your retry. You can press **MENU/EXIT** to cancel the change or try another password.

**Note that though the password function is disabled, you need to keep the old password in hand should you ever need to re-activate the password function by entering the old password.**



# Adjusting the projected image

## Adjusting the projection angle

There are four adjuster feet on the bottom of the projector. These can be used if necessary to change the projection angle. Screw the feet in or out as appropriate to aim and level the projection angle.



If the screen and the projector are not perpendicular to each other, the projected image becomes vertical trapezoidal. To correct this problem, see "Correcting picture distortion" on page 26 for details.

## Auto-adjusting the image

In some cases, you may need to optimize the picture quality. To do this, press AUTO. Within 3 seconds, the built-in Intelligent Auto Adjustment function will re-adjust the values of Frequency and Clock to provide the best picture quality.

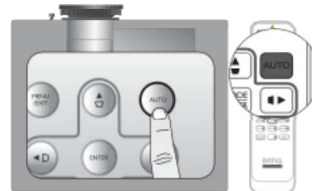

The current source information will be displayed in the corner of the screen for 3 seconds.

This function is only available when a PC signal (analog RGB) is selected.

## Fine-tuning the image size and clarity

1. Adjust the projected picture to the size that you need using the zoom ring.
2. Sharpen the picture by rotating the focus ring.

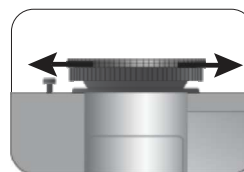
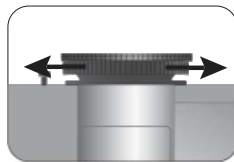

## Correcting picture distortion

Keystoning occurs when the projector is not perpendicular to the screen and is where the projected picture displays visible as a trapezoid shape like either of the following:

- Two parallel sides (left and right, or top and bottom) but is noticeably wider on either side.
- No parallel sides.

**To correct the picture's shape, you can perform the following steps.**

1. Adjust the projection angle. Move the projector to be in front of the center of the screen with the center of the lens level with the screen.
2. If the picture is still distorted, or the projector is unable to be positioned as described above, you will need to manually correct the picture.

- **Using the remote control or projector**

- i. Press one of the Arrow/Keystone keys (Left ◀/▷, Up ▲/▣, Right ▶/◻, Down ▼/◼) to display the Keystone page.
- ii. See step iv below for further operation.

- **Using the OSD menu**

- i. Press **MENU/EXIT** and then press ◀/▶ until the **Display** menu is highlighted.
- ii. Press ▼ to highlight **Keystone** and press **ENTER**. The **Keystone** page is displayed.
- iii. Highlight **2D Keystone** and press **ENTER**. The keystone correction page is displayed.
- iv. Press the key whose keystone icon is opposite to the shape of the projected picture. Continue pressing the same key or press the other keys until you are satisfied with the shape. The values on the lower portion of the page change while pressing. When the values reach their maximum or minimum with repeated key presses, the picture's shape will stop changing. You will not be able to change the picture further in that direction.

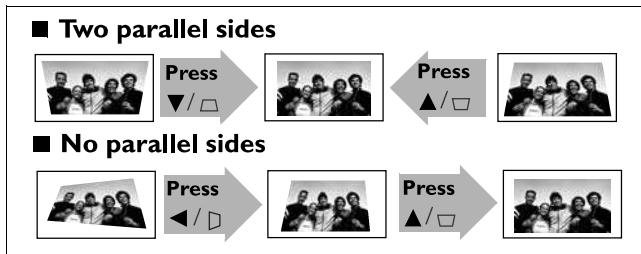

# Using the preset and user modes

## Selecting a preset mode

The projector is preset with several pre-defined picture modes so that you can choose one to suit your operating environment and input source picture type.

### To select a picture mode that suits your need:

- Press **MODE** repeatedly until your desired mode is selected.
  - **Using the OSD menu**
1. Press **MENU/EXIT** and then press ◀/▶ until the **Picture -- Basic** menu is highlighted.
  2. Press ▼ to highlight **Picture Mode**.
  3. Press ◀/▶ until your desired mode is selected.

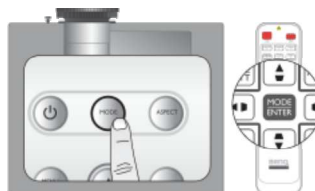

**These modes consist of preset values suitable for various projection situations as described below:**

- **Cinema:** Is appropriate for playing colorful movies, video clips from digital cameras or DVs through the PC input for best viewing in a blackened (little light) environment.
- **Dynamic:** Maximizes the brightness of the projected image. This mode is suitable for environments where extra-high brightness is required, such as using the projector in well lit rooms.
- **Presentation:** Is designed for presentations. The brightness is emphasized in this mode to match PC and notebook coloring.
- **sRGB:** Maximizes the purity of RGB colors to provide true-to-life images regardless of brightness setting. It is most suitable for viewing photos taken with an sRGB compatible and properly calibrated camera, and for viewing PC graphic and drawing applications such as AutoCAD.
- **User 1/User 2:** Recalls the customized settings. See ["Setting the User 1/User 2 mode" on page 28](#) for details.

## Fine-tuning the selected picture mode

The pre-defined picture mode settings can be altered via the available items shown in the **Picture -- Basic** and **Picture -- Advanced** menus.

### To fine-tune the picture mode:

1. Press **MENU/EXIT** and then press ◀/▶ until the **Picture -- Basic** or **Picture -- Advanced** menu is highlighted.
2. Press ▼ to highlight the item you want to adjust and press ◀/▶ to set your desired value. Your selection is automatically stored in the projector and associated with that input source.  
See ["Fine-tuning the picture quality" on page 29](#) and ["Advanced picture quality controls" on page 30](#) for details.

**Each time you change the picture mode, the projector also changes the setting to the one which was last set for that particular picture mode on that particular input. If you change the input source, the most recently used picture mode and settings for that input and resolution will be restored.**

## Setting the User 1/User 2 mode

There are two user-definable modes if the current available picture modes are not suitable for your need. You can use one of the picture modes (except the selected User mode) as a starting point and customize the settings.

1. In the **Picture -- Basic** menu, highlight **Picture Mode** and press ◀/▶ to select **User 1** or **User 2** mode.
2. Press ▼ to highlight **Load Settings From**.

 This function is only available when **User 1** or **User 2** mode is selected up in the **Picture Mode** sub-menu item.

3. Press **ENTER** to display the **Load Settings From** page.
4. Press ▼ to highlight a picture mode that is closest to your need and press **ENTER**.
5. Press ▼ to select a sub-menu item to be changed and adjust the value with ◀/▶. See "[Fine-tuning the picture quality](#)" on page 29 and "[Advanced picture quality controls](#)" on page 30 for details.
6. When all settings have been done, press **MENU/EXIT** to save and leave the settings.

## Renaming user modes

You can change User 1 and User 2 to the names easy to be identified or understood by the users of this projector. The new name can be up to 12 characters including English letters (A-Z, a-z), digits (0-9), and space (\_).

### To rename user modes:

1. In the **Picture -- Basic** menu, highlight **Rename User Mode** and press **ENTER** to display the **Rename User Mode** page.
2. Press ▲/▼ to highlight the item you want to rename and press **ENTER**. The first letter will be highlighted by a white box.
3. Press ▲/▼ to select the first character.
4. Press ▶ to move along until the new name is set and press **ENTER** to confirm.
5. Repeat steps 2-4 if you want to change the other names.

## Resetting the picture mode

All of the adjustments you've done in the **Picture -- Basic** and **Picture -- Advanced** menus can be returned to the factory preset values with a key press on the highlight of **Reset**.

### To reset the picture mode to the preset factory values:

1. In the **Picture -- Basic** menu, highlight **Picture Mode** and press ◀/▶ to select the picture mode (including **User 1** or **User 2**) you want to reset.
2. Press ▼ to highlight **Reset Picture Settings** and press **ENTER**. The confirmation message is displayed.
3. Press ◀/▶ to highlight **Reset** and press **ENTER**. The picture mode will return to the factory preset settings.
4. Repeat steps 1-3 if you want to reset other picture modes.

-  • The following settings will still remain: **Color Temperature**, **Color Temperature User\_ Fine Tuning**, **Gamma Selection**, **Film Mode**, **3D Comb Filter**.
- Do not confuse the **Reset Picture Settings** function here with the **Reset All Settings** in the **Advanced Setup** menu. The **Reset All Settings** function returns most of the settings to the factory preset values system wide. See "[Reset All Settings](#)" on page 50 for details.

# Fine-tuning the picture quality

No matter what picture mode you have selected, you are able to fine-tune those settings to fit every presentation purpose. Those adjustments will be saved to the preset mode you are at when you exit the OSD menu.

## Adjusting Brightness

Highlight **Brightness** in the **Picture -- Basic** menu and adjust the values by pressing ◀/▶ on the projector or remote control.



The higher the value, the brighter the picture. And the lower the setting, the darker the picture. Adjust this control so the black areas of the picture appear just as black and that detail in the dark areas is visible.

## Adjusting Contrast

Highlight **Contrast** in the **Picture -- Basic** menu and adjust the values by pressing ◀/▶ on the projector or remote control.



The higher the value, the greater the contrast. Use this to set the peak white level after you have previously adjusted the Brightness setting to suit your selected input and viewing environment.

## Adjusting Color

Highlight **Color** in the **Picture -- Basic** menu and adjust the values by pressing ◀/▶ on the projector or remote control.

Lower setting produces less saturated colors; setting to the minimum value makes the image black and white. If the setting is too high, colors on the image will be overpowering, which makes the image unrealistic.

## Adjusting Tint

Highlight **Tint** and adjust the values by pressing ◀/▶ on the projector or remote control.

The higher the value, the more reddish the picture becomes. The lower the value, the more greenish the picture becomes.

## Adjusting Sharpness

Highlight **Sharpness** and adjust the values by pressing ◀/▶ on the projector or remote control.



The higher the value, the sharper the picture becomes. The lower the value, the softer the picture becomes.

The **Brightness, Contrast** functions can also be accessible by pressing **BRIGHTNESS, CONTRAST** on the remote control to display the adjustment bar and then you can press ◀/▶ to adjust the values.



# Advanced picture quality controls

There are more advanced functions in the **Picture -- Advanced** menu to be adjusted to your preference. To save the settings, just press **MENU/EXIT** to leave the OSD menu.

## Setting Black Level

Highlight **Black Level** and press ◀/▶ on the projector or remote control to select **0 IRE** or **7.5 IRE**.

The grayscale video signal is measured in IRE units. In some areas which use NTSC TV standard, the grayscale is measured from 7.5 IRE (black) to 100 IRE (white); however, in other areas where PAL equipment or Japanese NTSC standards are used, the grayscale is measured from 0 IRE (black) to 100 IRE (white). We suggest that you check the input source to see if it is with 0 IRE or 7.5 IRE, then select accordingly.

## Controlling image clarity

You may have static or noisy projected pictures.

### To achieve better picture clarity:

1. Highlight **Clarity Control** and press **ENTER** on the projector or remote control to display the **Clarity Control** page.
2. Press ▲/▼ to select the item you want to adjust and press ◀/▶ to set the desired value.
  - **Noise Reduction:** Reduces electrical image noise caused by different media players. The higher the setting, the less the noise.
  - **Detail Enhancement:** Sharpens the image. The higher the setting, the more details the image reveals.
  - **Luma Transmission** (Luminance Transmission Improvement): Enhances picture brightness. The higher the setting, the more distinct the effect.
  - **Chroma Transmission** (Chroma Transmission Improvement): Reduces color smear. The higher the setting, the more distinct the effect.

## Selecting a color temperature\*

Highlight **Color Temperature** and select a preferred setting by pressing ◀/▶ on the projector or remote control.

### There are several color temperature settings available.

1. **Lamp Native:** With the lamp's original color temperature and higher brightness. This setting is suitable for environments where high brightness is required, such as projecting pictures in well lit rooms.
2. **Warm:** Makes pictures appear reddish white.
3. **Normal:** Maintains normal colorings for white.
4. **Cool:** Makes pictures appear bluish white.
5. **User 1/User 2/User 3:** Recalls the settings customized in the **Color Temperature User\_ Fine Tuning** menu. See "[Setting a preferred color temperature](#)" on page 31 for details.

#### \*About color temperatures:

There are many different shades that are considered to be "white" for various purposes. One of the common methods of representing white color is known as the "color temperature". A white color with a low color temperature appears to be reddish white. A white color with a high color temperature appears to have more blue in it.

## Setting a preferred color temperature

To set a preferred color temperature:

1. Highlight **Color Temperature** and select **User 1**, **User 2**, or **User 3** by pressing ◀/▶ on the projector or remote control.
2. Press ▼ to highlight **Color Temperature User\_ Fine Tuning** and press ENTER. The **Color Temperature User\_ Fine Tuning** page is displayed.

 The menu name "User\_" corresponds with the setting selected in **Color Temperature**.

3. Press ▲/▼ to highlight the item you want to change and adjust the values by pressing ◀/▶.
  - **Red Gain/Green Gain/Blue Gain:** Adjusts the contrast levels of Red, Green, and Blue.
  - **Red Offset/Green Offset/Blue Offset:** Adjusts the brightness levels of Red, Green, and Blue.
4. To save and leave the settings, press **MENU/EXIT**.

## Selecting a Gamma setting

Highlight **Gamma Selection** and select a preferred setting by pressing ◀/▶ on the projector or remote control.

**Gamma refers to the relationship between input source and picture brightness.**

- Gamma 1/2/3  
Select these values according to your preference.
- Gamma 4  
Increases the average brightness of the picture. Best for a lit environment, meeting room or family room.
- Gamma 5/6  
Best for viewing movies in a darkened environment.
- Gamma 7/8  
Best for viewing movies which are mostly composed of dark scenes.

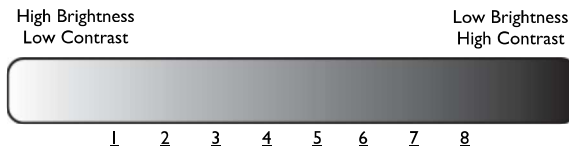

## Adjusting Brilliant Color

This feature utilizes a new color-processing algorithm and system level enhancements to enable higher brightness while providing truer, more vibrant colors in picture. When set to **"Off"**, **Brilliant Color** is disabled.

## Color Management

In most installation situations, color management will not be necessary, such as in classroom, meeting room, or lounge room situations where lights remain on, or where building external windows allow daylight into the room.

Only in permanent installations with controlled lighting levels such as boardrooms, lecture theaters, or home theaters, should color management be considered. Color management provides fine color control adjustment to allow for more accurate color reproduction, should you require it.

Proper color management can only be achieved under controlled and reproducible viewing conditions. You will need to use a colorimeter (color light meter), and provide a set of suitable source images to measure color reproduction. These tools are not provided with the projector; however, your projector supplier should be able to provide you with suitable guidance, or even an experienced professional installer.

The **3D Color Management** provides six sets (RGBCMY) of colors to be adjusted to favorite colors. When you select each color, you can independently adjust its color range and saturation according to your preference.

### To adjust and store the settings:

1. In the **Picture -- Advanced** menu, highlight **3D Color Management** and press **ENTER**. The **3D Color Management** page is displayed.
2. Highlight **Primary Color** and press **◀/▶** to select a color from among **Red, Yellow, Green, Cyan, Blue, and Magenta**.
3. Press **▼** to highlight **Range** and press **◀/▶** to select the color range you wish to make adjustment. The bigger the range, the more proportions of its two adjacent colors the color contains.

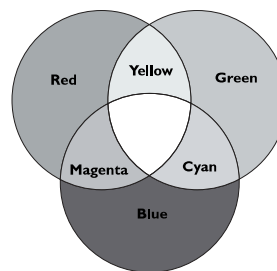

Please refer to the illustration to the right for how the colors relate to each other. For example, if you select **Red** and set its range at 0, only pure red is selected. Increasing its range will include both the red color close to yellow and red color close to magenta.

Press **▼** to highlight **Saturation** and adjust the color saturation level by pressing **◀/▶**.

If you select **Red** and set its range at 0, only the saturation of the pure red will be affected.



**Saturation is the amount of that color in a video picture. Lower settings produce less saturated colors; a setting of "0" removes that color from the image entirely. If the saturation is too high, that color will be overpowering and unrealistic.**

4. To leave and save the settings, press **MENU/EXIT**.

## Setting Film Mode

This feature helps improve picture quality when projecting video image from a film-sourced DVD.



## Setting 3D Comb Filter

This feature separates composite signal to Y (brightness) signal and C (color) signal, and can help produce clearer and sharper images with correct colors in place.

 This function is only available when a Video signal is selected

## Selecting the aspect ratio

The "aspect ratio" is the ratio of the image width to the image height. Digital TV is usually in 16:9 ratio, which is the default for this projector, and most analog TV signals and DVDs are in 4:3 ratio.

With the advent of digital signal processing, digital display devices like this projector can dynamically stretch and scale the image output to a different aspect than that of the image input source. Images can be stretched in a linear manner so the whole of the image is stretched equally, or non-linearly, which distorts the image.

**To change the projected picture ratio (no matter what aspect the source is):**

- **Using the control button**

1. Press **ASPECT** to show the current setting.
2. Press **ASPECT** repeatedly to select an aspect ratio to suit the format of the video signal and your display requirements.

- **Using the OSD menu**

1. Press **MENU/EXIT** and then press ◀/▶ until the **Display** menu is highlighted.
2. Press ▼ to highlight **Aspect Ratio**.
3. Press ◀/▶ to select an aspect ratio to suit the format of the video signal and your display requirements.



## About the aspect ratio

1. **Anamorphic (ANA):** Scales an image so that it is displayed in the center of the screen with a 16:9 aspect ratio. This setting stretches and resizes linearly, except that it treats the vertical and horizontal dimensions independently. It stretches the height of the source image until it reaches the full projected height, and stretches the width of the source image until it reaches the full projected width. This may alter the projected aspect, depending upon the original aspect of the source image. Anamorphic is most suitable for images which are already in a 16:9 aspect, like high definition TV, as it displays them without aspect alteration.
2. **4:3:** Scales a picture so that it is displayed in the center of the screen with a 4:3 aspect ratio. This is most suitable for 4:3 pictures like computer monitors, standard definition TV and 4:3 aspect DVD movies, as it displays them without aspect alteration.

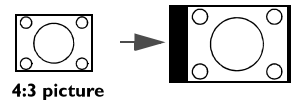
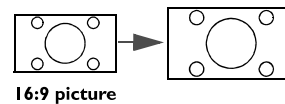

3. **Letter Box (LB)**: Scales a picture to fit the projector's native resolution in its horizontal width and resize the picture's height to the 3/4 of the projection width. This may produce a picture greater in height than can be displayed, so part of the picture is lost (not displayed) along the top and bottom edges of the projection. This is suitable for the display of movies which are presented in letter box format (with black bars on the top and bottom).

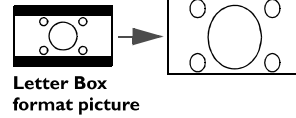
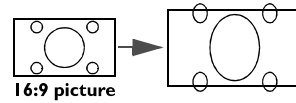

4. **Wide**: Stretches the picture horizontally in a non-linear manner, that is, the edges of the picture are stretched more than the center of the picture to prevent distortion of the central part of the picture. This is suitable for occasions where you want to stretch the width of a 4:3 aspect picture to the width of a 16:9 aspect screen. It does not alter the height. Some widescreen movies have been produced with their width squashed down to the width of a 4:3 aspect, and are best viewed when restretched back to their original width using this setting.

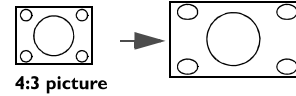

5. **Real**: This setting displays the image in a one-to-one pixel mapping without alteration or resize in the center of the projection. This is most suitable for use with PC source inputs.

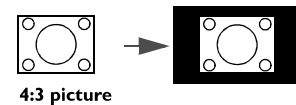

- The black portions are inactive areas and the white portions are active areas.
- OSD menus can be displayed on those unused black areas.

### Using Panamorph lenses (optional)

Panamorph lenses allow you to convert 16:9 projectors to the full 2.35:1 aspect ratio of most motion pictures, showing the best movies without letterbox bars at top and bottom of images while increasing resolution by 33% and brightness by 20%.

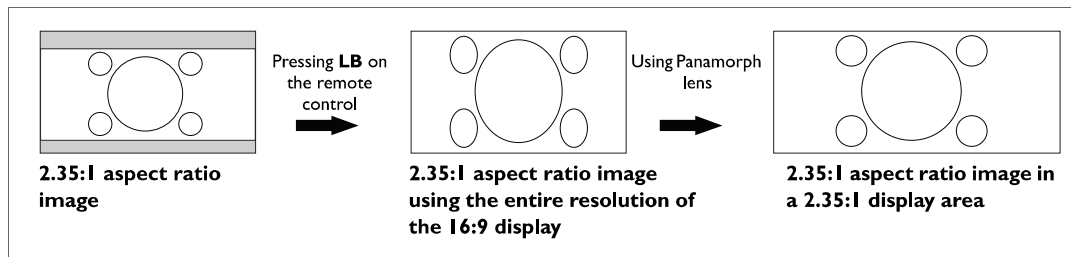

You may need a 2.35:1 screen to display the 2.35:1 images. For more information, please go to [www.panamorph.com](http://www.panamorph.com) or contact the place you purchased the projector.

## Hiding the image

In order to draw the audience's full attention to the presenter, you can use **ECO BLANK** to hide the screen image. When this function is activated with an audio input connected, the audio can still be heard.

You can set the blank time in the **Display > Blank Timer** menu to let the projector return the image automatically after a period of time when there is no action taken on the blank screen. The length of time can be set from 5 to 30 minutes in 5-minute increments.

If the preset time spans are not suitable for your personation, select **Disable**.

No matter **Blank Timer** is activated or not, you can press any key on the projector or remote control to restore the picture.

 Once **ECO BLANK** is pressed, the projector lamp enters **Dual-Reliable** mode automatically.

## Freezing the image

Press **FREEZE** on the remote control to freeze the image. The word "FREEZE" will be displayed in the upper left corner of the screen. To release the function, press any key on the projector or remote control.

Even if an image is frozen on the screen, the pictures are running on the video or other device. If the connected devices have active audio output, you will still hear the audio even though the image is frozen onscreen.



# Adjusting the sound

The sound adjustments made as below will have an effect on the projector speaker(s). Be sure you have made a correct connection to the projector audio input. See "[Connecting to video equipment](#)" on [page 17](#) for how the audio input is connected.

## Muting the sound

### To temporarily turn off the sound:

1. Press **MENU/EXIT** to open the OSD menu and press ◀/▶ to highlight the **Advanced Setup** menu.
2. Press ▼ to highlight **Audio Settings** and press **ENTER**. The **Audio Settings** page is displayed.
3. Highlight **Mute** and press ◀/▶ to select **On**.

☞ If available, you can also press **MUTE** on the remote control to toggle projector audio between on and off.

## Adjusting the sound level

### To adjust the sound level, press **VOLUME+/VOLUME-** on the remote control, or:

1. Repeat steps 1-2 above.
2. Press ▼ to highlight **Volume** and press ◀/▶ to select a desired sound level.

## Turning off the Power On/Off Ring Tone

### To turn off the ring tone:

1. Repeat steps 1-2 above.
2. Press ▼ to highlight **Power On/Off Ring Tone** and press ◀/▶ to select **Off**.

☞ The only way to change **Power On/Off Ring Tone** is setting **On** or **Off** here. Setting the sound mute or changing the sound level will not affect the **Power On/Off Ring Tone**.

# Setting the lamp mode

This projector is capable of dual-lamp projection and provides several lamp modes for different purposes:

Lamp mode	User Benefit	Suitable environment
<b>Dual-Brightest</b> (Two lamps are used in normal mode)	<ul style="list-style-type: none"> <li>• Delivering super-bright and clear images</li> <li>• Suitable for high-ambient-light environments</li> <li>• Allowing continuous and non-stop operation under critical situations</li> </ul>	Large, well lit meeting rooms or auditoriums
<b>Dual-Reliable</b> (Two lamps are used in economic mode)	<ul style="list-style-type: none"> <li>• Extending the lamp life</li> <li>• Allowing continuous and non-stop operation under critical situations</li> </ul>	Mid-large boardrooms
<b>Single-Alternative</b> (The lamp with shorter operating hours is selected automatically and used in normal mode)	<ul style="list-style-type: none"> <li>• Extending the total operation time</li> <li>• Reducing lamp replacement frequency</li> </ul>	Normal sized rooms
<b>Single-Eco</b> (The lamp with shorter operating hours is selected automatically and used in economic mode)	<ul style="list-style-type: none"> <li>• Extending the lamp life</li> <li>• Extending the total operation time</li> <li>• Reducing lamp replacement frequency</li> </ul>	Small to normal sized rooms

You can perform the following steps to choose a lamp mode according to your preference.

1. Press **MENU/EXIT** and then press ◀/▶ until the **Advanced Setup** menu is highlighted.
2. Press ▼ to highlight **Lamp Settings** and press **ENTER**.
3. Press ▼ to highlight **Lamp Mode** and press **ENTER**.
4. Press ▼ to highlight your preferred lamp mode and press **ENTER**.
5. A confirmation message displays. Highlight **Yes** and press **ENTER**.

- If one lamp fails, the projector enters **Single-Alternative** mode automatically. **Dual-Brightest**, **Dual-Reliable** and **Single-Eco** settings are not available.
- After switching from **Dual-Brightest/Dual-Reliable** mode to **Single-Alternative/Single-Eco** mode or vice versa, wait for **90** seconds before you can adjust the lamp mode again.
- A slight variation in the picture brightness and colors may be observed during the very short time of switching lamp modes.

## Controlling the projector through a LAN environment

**LAN Control Settings** allow you to manage the projector from a computer using a web browser when the computer and the projector are properly connected to the same local area network.

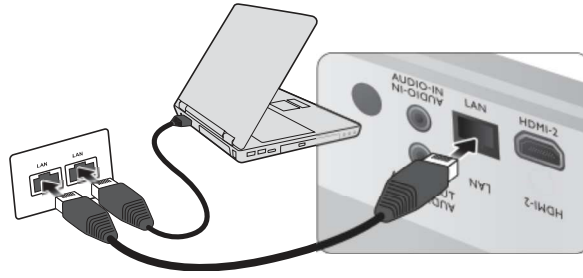

### Configuring the LAN Control Settings

#### If you are in a DHCP environment:

1. Take a RJ45 cable and connect one end to the RJ45 LAN input jack of the projector and the other end to the RJ45 port.
2. Press **MENU/EXIT** and then press **◀/▶** until the **Advanced Setup** menu is highlighted.
3. Press **▼** to highlight **LAN Control Settings** and press **ENTER**. The **LAN Control Settings** page is displayed.
4. Press **▼** to highlight **Control By** and press **◀/▶** to select **RJ45**.
5. Press **▼** to highlight **DHCP** and press **◀/▶** to select **On**.
6. Press **▼** to highlight **AMX Device Discovery** and press **◀/▶** to select **On** or **Off**. When **AMX Device Discovery** is **On**, the projector can be detected by AMX controller.
7. Press **▼** to highlight **Apply** and press **ENTER**.
8. Please wait for around 15 - 20 seconds, and then re-enter the **LAN Control Settings** page.
9. The **Projector IP Address**, **Subnet Mask**, **Default Gateway**, and **DNS Server** settings will be displayed. Note down the IP address displayed in the **Projector IP Address** row.

☞ If the **Projector IP Address** still does not display, contact your **ITS administrator**.

#### If you are in a non-DHCP environment:

1. Repeat steps 1-4 above.
2. Press **▼** to highlight **DHCP** and press **◀/▶** to select **Off**.
3. Contact your ITS administrator for information on the **Projector IP Address**, **Subnet Mask**, **Default Gateway**, and **DNS Server** settings.
4. Press **▼** to select the item you want to modify and press **ENTER**.
5. Press **◀/▶** to move the cursor and then press **▲/▼** to enter the value.
6. To save the setting, press **ENTER**. If you do not want to save the setting, press **MENU/EXIT**.
7. Press **▼** to highlight **AMX Device Discovery** and press **◀/▶** to select **On** or **Off**.
8. Press **▼** to highlight **Apply** and press **ENTER**.

## Controlling the projector remotely through a web browser

Once you have the correct IP address for the projector and the projector is on or in standby mode, you can use any computer that is on the same local area network to control the projector.

1. Enter the address of the projector in the address bar of your browser and click Go.



2. The remote network operation page opens. This page allows you to operate the projector as if you were using the remote control or control panel on the projector.



<b>i</b>	<ul style="list-style-type: none"> <li>• Menu (Exit)</li> <li>• Auto</li> <li><input type="checkbox"/> ▲ (□)</li> <li><input type="checkbox"/> ◀ (▷)</li> </ul>	<ul style="list-style-type: none"> <li>• Blank</li> <li>• Source</li> <li><input type="checkbox"/> ▼ (△)</li> <li><input type="checkbox"/> ▶ (◁)</li> </ul>	<p>See <a href="#">"Remote control"</a> on page 11 for details.</p>
	<ul style="list-style-type: none"> <li>• Enter</li> </ul>	<p>Activates the selected On-Screen Display (OSD) menu item.</p>	
<b>ii</b>	<p>To switch input source, click on your desired signal.</p> <p> <b>The source list varies according to the connectors available on the projector. "Video 1" stands for the Video signal.</b></p>		

The tools page allows you to manage the projector, configure the LANcontrol settings and secure access of remote network operation on this projector.

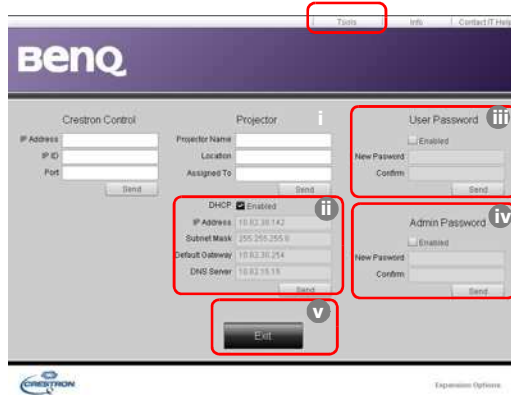

- i. You can name the projector, keep track of its location and the person in charge of it.
- ii. You can adjust the **LAN Control Settings**.
- iii. Once set, access to the remote network operation on this projector has been password-protected.
- iv. Once set, access to the tools page has been password-protected.

After making the adjustments, press the **Send** button and the data will be saved in the projector.

- v. Press **Exit** to go back to the remote network operation page.

Please pay attention to the limitation of input length (including space and other punctuation keys) in the list blow:

Category Item	Input Length	Maximum Number of Characters
Crestron Control	IP Address	16
	IP ID	4
	Port	5
Projector	Projector Name	32
	Location	32
	Assigned To	32
Network Configuration	DHCP (Enabled)	(N/A)
	IP Address	16
	Subnet Mask	16
	Default Gateway	16
	DNS Server	16
User Password	Enabled	(N/A)
	New Password	26
	Confirm	26
Admin Password	Enabled	(N/A)
	New Password	26
	Confirm	26

The info page displays the information and status of this projector.

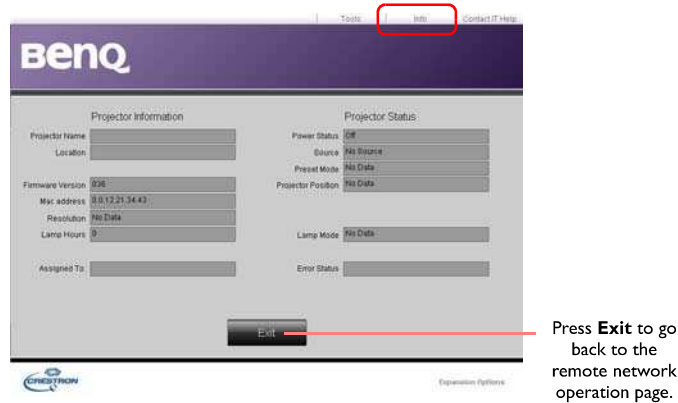

For more information, visit <http://www.crestron.com> & [www.crestron.com/getroomview](http://www.crestron.com/getroomview).

## Operating in a high altitude environment

We recommend that you activate **High Altitude Mode** when your environment is higher than 1500 meters (around 4920 feet) above sea level, or whenever the projector will be used for extended periods of time (>10 hours) without shutdown.

### To activate High Altitude Mode:

1. Press **MENU/EXIT** and then press **◀/▶** until the **Advanced Setup** menu is highlighted.
2. Press **▼** to highlight **High Altitude Mode**.
3. Press **◀/▶** to select **On**. A confirmation message is displayed.
4. Highlight **Yes** and press **ENTER**.

**Operation under High Altitude Mode may cause a higher decibel operating noise level because of increased fan speed necessary to improve overall system cooling and performance.**

**If you use this projector under other extreme conditions excluding the above, it may display auto shut-down symptoms, which is designed to protect your projector from over-heating. In cases like this, you should switch to High Altitude Mode to solve these symptoms. However, this is not to state that this projector can operate under any and all harsh or extreme conditions.**



# Displaying more than one image source simultaneously

Your projector is capable of displaying pictures simultaneously from two input sources, which can be used to enhance your presentation in an interesting way. Ensure the signals you want to display are correctly connected to the projector.

## To display the PIP window:

1. Press **MENU/EXIT** and then press ◀/▶ until the **Display** menu is highlighted.
2. Press ▼ to highlight **PIP** and press **ENTER**. The **PIP** page is displayed.
3. Highlight **PIP** and press ◀/▶ to select **On**.

The projector will select two currently active signals to display and the last viewed picture will be displayed on the big screen as a main source.

The PIP function is effective at below source combinations.

	Source 2
Source 1	CVBS
HDMI 1/2	√
Component 1/2	√
Computer 1/2	√

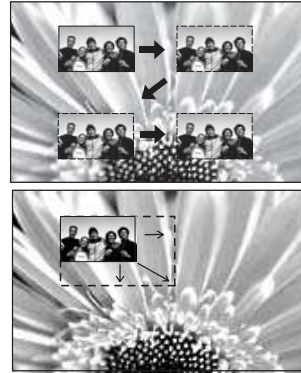

4. To change the **Main Source** or **Second Source**, press ▼ to highlight **Main Source** or **Second Source** and press **ENTER**. The source selection bar is displayed.
5. Use ▲/▼ to highlight the source you want to display for the main (bigger) or second (smaller) window, and press **ENTER** to save the setting and go back to the **PIP** page.
6. To make OSD settings to one of the two sources (main or second), highlight **Active Window** and press ◀/▶ to select the source you want to make adjustments.

☞ The settings made on the OSD menu will only take effect on the active window. The following OSD menu function cannot work on the active windows for the PIP: **Quick Auto Search**.

7. To change the position of the smaller picture, highlight **Position** and press ◀/▶ repeatedly until a suitable position is selected.
8. To resize the small picture, highlight **Size** and press ◀/▶ to set the PIP size among **Small** or **Large**.
9. To save the settings and leave the OSD menu, press **MENU/EXIT**.

# Turning the projector off

To turn the projector off, press **POWER** (⏻) on the projector or **OFF** (⏻) on the remote control and a warning message appears.

Press **POWER/OFF** (⏻) again.

- The Power indicator light flashes orange and the fans run for about two minutes to cool the lamp. The projector will not respond to any commands until the cooling process is complete.
- Then, the Power indicator light is a steady orange once the cooling process has finished and fans stop.
- If the projector will not be used for an extended period, unplug the power cable from the power outlet.
- To protect the lamp, the projector will not respond to any commands during the cooling process.
- ☞ • **Actual lamp life may vary due to different environmental conditions and usage.**
- **If you attempt to re-start the projector shortly after shutdown, the fans may run for a few minutes to cool down. Press (⏻) Power/ON again to start the projector after the fans stop and the Power indicator light turns orange.**

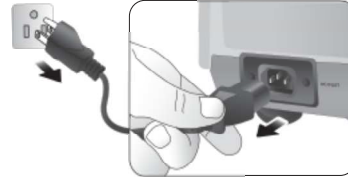
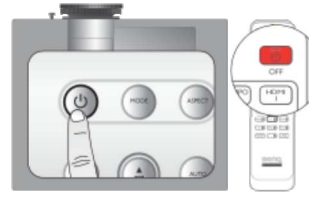

# On-Screen Display (OSD) menus

## On-Screen Display (OSD) structure

Please note that the on-screen display (OSD) menus vary according to the signal type selected.

Main menu	Sub-menu	Options
	Picture Mode	Cinema/Dynamic/Presentation/sRGB/User 1/User 2
	Load Settings From	
Picture -- Basic	Brightness	0-100
	Contrast	0-100
	Color	0-100
	Tint	-20-+20
	Sharpness	0-8
	Reset Picture Settings	Reset/Cancel
	Rename User Mode	Reset/Cancel
	Black Level	0 IRE/7.5 IRE
Clarity Control	Noise Reduction	0/1/2/3
	Detail Enhancement	0-5
	Luma Transmission	0/1/2
	Chroma Transmission	0/1/2
Color Temperature	Lamp Native/Warm/Normal/Cool/User 1/ User 2/User 3	
Picture -- Advanced	Red Gain	0-100
	Green Gain	0-100
	Blue Gain	0-100
	Red Offset	0-100
	Green Offset	0-100
	Blue Offset	0-100
Gamma Selection	1-8	
Brilliant Color	On/Off	
3D Color Management	Primary Color	Red/Yellow/Green/Cyan/Blue/Magenta
	Range	0-100
	Saturation	0-100
Film Mode	On/Off	
3D Comb Filter	On/Off	

Main menu	Sub-menu	Options	
Display	Aspect Ratio	Anamorphic/4:3/Letter Box/Wide/Real	
	Keystone	2D Keystone	
	Position		
	Overscan Adjustment	0/1/2/3	
	Color Space Conversion	Auto/RGB/YUV	
	PIP	PIP	On/Off
		Main Source	HDMI 1/HDMI 2/Video/Component 1/Component 2/Computer 1/Computer 2
		Second Source	
		Active Window	Main/PIP
		Position	Top-Right/Bottom-Left/Bottom-Right/Top-Left
		Size	Large/Small
	PC & Component YPbPr Tuning	H. Size	-15 ~ +15
		Phase	-15 ~ +15
		Auto	
	Blank Timer	Disable/5 min/10 min/15 min/20 min/25 min/30 min	
Test Pattern			
System Setup	Language	English / Français / Deutsch / Italiano / Español / Русский / 繁體中文 / 简体中文 / 日本語 / 한국어 / Svenska / Nederlands / Türkçe / Čeština / Português / ភាសាខ្មែរ / Polski	
	Splash Screen	BenQ/Blue/Black	
	Projector Position	Floor Front/Ceiling Front/Floor Rear/Ceiling Rear	
	Background Color	Black/Purple/Blue	
	Menu Settings	Menu Display Time	5 sec/10 sec/15 sec/20 sec/25 sec/30 sec
		Menu Position	Center/Top-Left/Top-Right/Bottom-Right/Bottom-Left
		Reminder Message	On/Off
		Direct Power On	On/Off
	Operation Settings	Signal Power On	On/Off
		Auto Power Off	Disable/5 min/10 min/15 min/20 min/25 min/30 min
		Sleep Timer	Disable/30 min/60 min/90 min/120 min/150 min/180 min
	Input Source	HDMI 1/HDMI 2/Video/Component 1/Component 2/Computer 1/Computer 2	
	Quick Auto Search	On/Off	
	Closed Caption	Closed Caption Enable	On/Off
		Caption Version	CC1/CC2/CC3/CC4
Standby Monitor Out	On/Off		

Main menu	Sub-menu	Options	
<b>Advanced Setup</b>	<b>Lamp Settings</b>	<b>Lamp Mode</b>	Dual-Brightest/Dual-Reliable/Single-Alternative/Single-Eco
		<b>Reset Lamp #1 Timer</b>	Reset/Cancel
		<b>Reset Lamp #2 Timer</b>	Reset/Cancel
		<b>Equivalent Lamp #1 Hour</b>	
		<b>Equivalent Lamp #2 Hour</b>	
	<b>HDMI Settings</b>	<b>HDMI Format</b>	<b>Auto</b>
			<b>PC Signal</b>
			<b>Video Signal</b>
	<b>Baud Rate</b>		2400/4800/9600/14400/19200/38400/57600/115200
	<b>High Altitude Mode</b>		On/Off
	<b>Audio Settings</b>	<b>SRS (surround sound)</b>	On/Off
		<b>Mute</b>	On/Off
		<b>Volume</b>	0-10
		<b>Treble</b>	0-10
		<b>Bass</b>	0-10
		<b>Power On/Off Ring Tone</b>	On/Off
	<b>Password</b>	<b>Password</b>	On/Off
		<b>Change Password</b>	(inputs current password)
	<b>LAN Control Settings</b>	<b>Control By</b>	RS232/RJ45
		<b>DHCP</b>	On/Off
		<b>Projector IP Address</b>	
		<b>Subnet Mask</b>	
<b>Default Gateway</b>			
<b>DNS Server</b>			
<b>AMX Device Discovery</b>		On/Off	
<b>Apply</b>		Enter	
<b>Reset All Settings</b>		Reset/Cancel	
<b>Expert Mode</b>		(inputs current password)	
<b>Information</b>	<b>Source</b>		
	<b>Picture Mode</b>		
	<b>Resolution</b>		
	<b>Lamp Mode</b>		
	<b>Equivalent Lamp #1 Hour</b>		
	<b>Equivalent Lamp #2 Hour</b>		
	<b>Firmware Version</b>		

Note that the menu items are available when the projector detects at least one valid signal. If there is no equipment connected to the projector or no signal detected, limited menu items are accessible.





## Picture -- Basic menu

Function	Description
<b>Picture Mode</b>	Pre-defined picture modes are provided so you can optimize your projector picture set-up to suit your program type. See <a href="#">"Selecting a preset mode" on page 27</a> for details.
<b>Load Settings From</b>	Selects a preset mode that most suits your need for the picture quality and further fine-tune the picture based on the selections listed below. See <a href="#">"Setting the User 1/User 2 mode" on page 28</a> for details.
<b>Brightness</b>	Adjusts the brightness of the picture. See <a href="#">"Adjusting Brightness" on page 29</a> for details.
<b>Contrast</b>	Adjusts the degree of difference between dark and light in the picture. See <a href="#">"Adjusting Contrast" on page 29</a> for details.
<b>Color</b>	Adjusts the color saturation level -- the amount of each color in a video picture. See <a href="#">"Adjusting Color" on page 29</a> for details.
<b>Tint</b>	Adjusts the red and green color tones of the picture. See <a href="#">"Adjusting Tint" on page 29</a> for details.
<b>Sharpness</b>	Adjusts the picture to make it look sharper or softer. See <a href="#">"Adjusting Sharpness" on page 29</a> for details.
<b>Reset Picture Settings</b>	Returns all settings in the <b>Picture -- Basic</b> and <b>Picture -- Advanced</b> menus to the factory preset values. See <a href="#">"Resetting the picture mode" on page 28</a> for details.
<b>Rename User Mode</b>	Renames <b>User 1</b> , <b>User 2</b> , or <b>sRGB</b> . See <a href="#">"Renaming user modes" on page 28</a> for details.

## Picture -- Advanced menu

Function	Description
<b>Black Level</b>	Sets the picture grayscale as <b>0 IRE</b> or <b>7.5 IRE</b> . See <a href="#">"Setting Black Level" on page 30</a> for details.
<b>Clarity Control</b>	Adjusts the picture clarity. See <a href="#">"Controlling image clarity" on page 30</a> for details.
<b>Color Temperature</b>	There are several color temperature settings available. See <a href="#">"Selecting a color temperature*" on page 30</a> for details.
<b>Color Temperature User_ Fine Tuning</b>	See <a href="#">"Setting a preferred color temperature" on page 31</a> for details.
<b>Gamma Selection</b>	See <a href="#">"Selecting a Gamma setting" on page 31</a> for details.
<b>Brilliant Color</b>	See <a href="#">"Adjusting Brilliant Color" on page 31</a> for details.
<b>3D Color Management</b>	See <a href="#">"Color Management" on page 32</a> for details.
<b>Film Mode</b>	See <a href="#">"Setting Film Mode" on page 32</a> for details.
<b>3D Comb Filter</b>	See <a href="#">"Setting 3D Comb Filter" on page 33</a> for details.



## Display menu

Function	Description
<b>Aspect Ratio</b>	There are several options to set the picture's aspect ratio depending on your input source. See " <a href="#">Selecting the aspect ratio</a> " on page 33 for details.
<b>Keystone</b>	Corrects any keystone of the picture. See " <a href="#">Correcting picture distortion</a> " on page 26 for details.
<b>Position</b>	Displays the position adjustment page. To move the projected picture, use the directional arrow keys. The values shown on the lower position of the page change with every key press you made until they reach their maximum or minimum. They will return to their factory preset values whenever the projector is re-started.  <b>This function is only available when the Component 1, Component 2, or PC signal is selected.</b>
<b>Overscan Adjustment</b>	Conceals the poor picture quality in the four edges. You can also manually press ◀/▶ to decide how much to be concealed. Setting 0 means the picture is 100% displayed. The greater the value, the more portion of the picture is concealed while the screen remains filled and geometrically accurate.
<b>Color Space Conversion</b>	See " <a href="#">Changing Color Space</a> " on page 21 for details.
<b>PIP</b>	Turns the PIP window on or off and makes related adjustments. See " <a href="#">Displaying more than one image source simultaneously</a> " on page 41 for details.
<b>PC &amp; Component YPbPr Tuning</b>	<p><b>H. Size</b> Adjusts the horizontal width of the picture.</p> <p><b>Phase</b> Adjusts the clock phase to reduce picture distortion.</p> <p><b>Auto</b> Adjusts the phase, and frequency automatically</p>  <p> <b>These functions are only available when the Component 1, Component 2, or PC signal is selected.</b></p>
<b>Blank Timer</b>	Sets the image blank time when the Blank feature is activated, once elapsed the image will return to the screen. See " <a href="#">Hiding the image</a> " on page 35 for details.
<b>Test Pattern</b>	Press <b>ENTER</b> to display the grid test pattern. It helps you adjust the image size and focus and check that the projected image is free of distortion.  <b>The function is only available when the projector detects no input signal.</b>



## System Setup menu

Function	Description
<b>Language</b>	Sets the language for the On-Screen Display (OSD) menus. See <a href="#">"Using the menus" on page 22</a> for details.
<b>Splash Screen</b>	Allows you to select which logo screen will be displayed during projector start-up. You can choose <b>BenQ</b> logo screen, <b>Blue</b> screen or <b>Black</b> screen.
<b>Projector Position</b>	The projector can be installed on a ceiling or behind a screen, or with one or more mirrors. See <a href="#">"Choosing a location" on page 12</a> for details.
<b>Background Color</b>	Allows you to choose the color of the background screen that will be displayed when there is no input source detected.
<b>Menu Settings</b>	<p><b>Menu Display Time</b> Sets the length of time the OSD will remain active after your last key press. The range is from 5 to 30 seconds in 5-second increments.</p> <p><b>Menu Position</b> Sets the On-Screen Display (OSD) menu position.</p> <p><b>Reminder Message</b> Sets whether to display the OSD messages about the status of detecting signals.</p>
<b>Operation Settings</b>	<p><b>Direct Power On</b> Sets whether to turn the projector directly on without pressing the <b>POWER</b> key on the projector or <b>ON</b> on the remote control when the projector is plugged in.</p> <p><b>Signal Power On</b> Sets whether to turn the projector directly on without pressing the <b>POWER</b> key on the projector or <b>ON</b> on the remote control when the projector is in standby mode and the signal is feed through the VGA cable.</p> <p><b>Auto Power Off</b> Prevents unnecessary projection when no signal is detected for a long time. See <a href="#">"Setting Auto Power Off" on page 53</a> for details.</p> <p><b>Sleep Timer</b> Sets the auto-shutdown timer. The timer can be set to a value between 30 minutes and 3 hours.</p>
<b>Input Source</b>	Selects an input source to be projected. See <a href="#">"Selecting an input source" on page 21</a> for details.
<b>Quick Auto Search</b>	Sets whether the projector searches automatically for input sources. If the source scan is <b>On</b> , the projector will scan for input sources until it acquires a signal. If the function is not activated, the projector selects the last used input source.



<p><b>Closed Caption</b></p>	<p><b>Closed Caption Enable</b>  Activates the function by selecting <b>On</b> when the selected input signal carries closed captions.</p> <ul style="list-style-type: none"> <li>• <b>Captions:</b> An on-screen display of the dialogue, narration, and sound effects of TV programs and videos that are closed captioned (usually marked as "CC" in TV listings).</li> </ul> <p><b>Caption Version</b>  Selects a preferred closed captioning mode. To view captions, select CC1, CC2, CC3, or CC4 (CC1 displays captions in the primary language in your area).</p> <p> <b>These functions are only available when the Video signal is selected.</b></p>
<p><b>Standby Monitor Out</b></p>	<p>Selecting <b>On</b> enables the function. The projector can output a VGA signal when it is in standby mode and the <b>PC</b> jack is correctly connected to devices. See <a href="#">"Connecting a monitor" on page 19</a> for how to make the connection.</p> <p> <b>Enabling this function slightly increases the standby power consumption.</b></p>

## Advanced Setup menu

Function	Description
<b>Lamp Settings</b>	<p><b>Lamp Mode</b> Selects the projector lamp power among Dual-Brightest, Dual-Reliable and Single-Alternative modes. See <a href="#">"Setting the lamp mode" on page 36</a> for details.</p> <p><b>Reset Lamp #1 Timer/Reset Lamp #2 Timer</b> Once the lamp is renewed, select <b>Reset</b> to return the lamp timer to "0". See <a href="#">"Resetting the lamp timer" on page 56</a> for details.</p> <p><b>Equivalent Lamp #1 Hour /Equivalent Lamp #2 Hour</b> Shows the lamp hour information. See <a href="#">"Getting to know the lamp hour" on page 53</a> for details.</p>
<b>HDMI Format</b>	<p>Selects an input source type for the HDMI signal. <b>Auto</b> is the default and recommended setting. You can also manually select the source type. The different source types carry different standards for the brightness level.</p> <p> <b>This function is only available when the HDMI signal is selected.</b></p>
<b>Baud Rate</b>	Selects a baud rate that is identical with your computer's so that you can connect the projector using a suitable RS-232 cable and update or download the projector's firmware. This function is intended for qualified service personnel.
<b>High Altitude Mode</b>	A mode for operation in areas like high altitude or high temperature. See <a href="#">"Controlling the projector through a LAN environment" on page 37</a> for details.
<b>Audio Settings</b>	See <a href="#">"Adjusting the sound" on page 36</a> for details.
<b>Password</b>	<p><b>Password</b> Limits use of the projector to only those who know the correct password. See <a href="#">"Utilizing the password function" on page 23</a> for details.</p> <p><b>Change Password</b> You will be asked to enter the current password before changing to a new one. See <a href="#">"Utilizing the password function" on page 23</a> for details.</p>
<b>LAN Control Settings</b>	See <a href="#">"Controlling the projector through a LAN environment" on page 37</a> for details.
<b>Reset All Settings</b>	<p>Returns all settings to the factory preset values.</p> <p> <b>The following settings will still remain: names of user modes, Keystone, Language, Projector Position, High Altitude Mode, Password, and Expert Mode.</b></p>
<b>Expert Mode</b>	<p>The <b>Expert Mode</b> menu is password protected and only accessible by authorized calibrators. The ISF (Imaging Science Foundation) has developed carefully crafted, industry-recognized standards for optimal video performance and has implemented a training program for technicians and installers to use these standards to obtain optimal picture quality from BenQ video display devices. Accordingly, we recommend that setup and calibration be performed by an ISF certified installation technician.</p> <p> <b>For more information, please go to <a href="http://www.imagingscience.com">www.imagingscience.com</a> or contact the place you purchased the projector.</b></p>

## Information menu

This menu shows you the current operating status of the projector.

 **Some picture adjustments are available only when certain input sources are in use. Unavailable adjustments are not shown on the screen.**

Function	Description
<b>Source</b>	Shows the current signal source.
<b>Picture Mode</b>	Shows the selected mode in the <b>Picture -- Basic &gt; Picture Mode</b> menu.
<b>Resolution</b>	Shows the native resolution of the input signal.
<b>Lamp Mode</b>	Shows the selected lamp mode in the <b>Advanced Setup &gt; Lamp Mode</b> menu.
<b>Equivalent Lamp #1 Hour</b>	Shows the total lamp time used.
<b>Equivalent Lamp #2 Hour</b>	
<b>Firmware Version</b>	Shows the current firmware version

# Additional information

## Care of the projector

Your projector needs little maintenance. The only thing you have to do on a regular basis is keep the lens clean. Never remove any parts of the projector except the lamp. Contact your dealer or local customer service center if the projector fails to operate as expected.

### Cleaning the lens

Clean the lens whenever you notice dirt or dust on the surface. Before you attempt to clean the lens, turn the projector off, unplug the power cable, and leave it several minutes to cool completely.

1. Use a canister of compressed air to remove dust. (Available from building hardware or photographic suppliers.)
2. If there is stubborn dirt or smudge marks, use a proper photographic lens brush or moisten a clean soft lens cloth with lens cleaner to gently wipe the lens surface.
3. Never use any type of abrasive pad, alkaline/acid cleaner, scouring powder, or volatile solvent, such as alcohol, benzene, thinner or insecticide. Using such materials or maintaining prolonged contact with rubber or vinyl materials may result in damage to the projector surface and cabinet material.

 **Never touch the lens with your finger or rub the lens with abrasive materials. Even paper towels can damage the lens coating. Only ever use a proper photographic lens brush, cloth, and cleaning solution. Do not attempt to clean the lens while the projector is switched on or is still hot from previous use. Be sure to turn off the projector and let it cool down completely before cleaning the lens.**

### Cleaning the projector case

Before you attempt to clean the case, turn the projector off, unplug the power cable, and leave it several minutes to cool completely.

1. To remove dirt or dust, wipe the case with a soft, dry, lint-free cloth.
2. To remove stubborn dirt or stains, moisten a soft cloth with water and a neutral detergent. Then wipe the case.

 **Never use wax, alcohol, benzene, thinner or other chemical detergents. These can damage the case.**

### Storing the projector

If you need to store the projector for an extended time, please:

1. Make sure the temperature and humidity of the storage area are within the recommended range for the projector. Please refer to the Spec. page in this manual or consult your dealer about the range.
2. Retract the adjuster feet.
3. Remove the batteries from the remote control.
4. Pack the projector in its original packing or equivalent.

### Transporting the projector

It is recommended that you ship the projector with its original packing or equivalent.

# Lamp information

## Getting to know the lamp hour

When the projector is in operation, the duration (in hours) of lamp usage is automatically calculated by the built-in timer.

### To obtain the lamp hour information:

1. Press **MENU/EXIT** and then press **◀/▶** until the **Advanced Setup** menu is highlighted.
2. Press **▼** to highlight **Lamp Settings** and press **ENTER**. The **Lamp Settings** page is displayed.
3. The lamp hour information is shown in the row of **Equivalent Lamp #1 Hour /Equivalent Lamp #2 Hour**.
4. To leave the menu, press **MENU/EXIT**.

## Extending lamp life

The projection lamp is a consumable item. To keep the lamp life as long as possible, you can do the following settings via the OSD menu.

- **Setting Lamp Mode as Dual-Reliable**

Using **Dual-Reliable** mode reduces system noise and power consumption. If the **Dual-Reliable** mode is selected, the light output will be reduced and result in darker projected pictures.

Setting the projector in **Dual-Reliable** mode also extends the lamp life. To set **Dual-Reliable** mode, go to the **Advanced Setup > Lamp Settings > Lamp Mode** menu and press **ENTER**. Press **▼** to select **Dual-Reliable** and press **ENTER**.

- **Setting Auto Power Off**

This function allows the projector to turn off automatically if no input source is detected after a set period of time.

To set **Auto Power Off**, go to the **System Setup > Auto Power Off** menu and press **◀/▶** to select a time period. The time period can be set from 5 to 30 minutes in 5-minute increments. If the preset time lengths are not suitable for your presentation, select **Disable**. The projector will not automatically shut down in a certain time period.

- **Single-Eco**

Using **Single-Eco** will help extend the lamp life, total operation time, and reduce lamp replacement frequency.



To enable **Single-Eco** mode, go to the **Advanced Setup > Lamp Settings > Lamp Mode** menu and press **ENTER**. Press **▼** to select **Single-Eco** and press **ENTER**.

## Timing of replacing the lamp

When the Lamp indicator lights up red or a message appears suggesting it is time to replace the lamp, please install a new lamp or consult your dealer. An old lamp may cause a malfunction in the projector and in some instances the lamp may explode. Go to <http://lamp.BenQ.com> for a replacement lamp.

The Lamp indicator light and Temperature warning light will light up if the lamp becomes too hot. Turn the power off and let the projector cool for 45 minutes. If the Lamp or Temp indicator still lights up after turning the power back on, please contact your dealer. See "Indicators" on page 57 for details.

The following Lamp warning displays will remind you to change the lamp.

Status	Message
<p>Install a new lamp for optimal performance. If the projector is normally run with <b>Dual-Reliable</b> selected (See "<a href="#">Getting to know the lamp hour</a>" on page 53), you may continue to operate the projector until the next hour lamp warning appears.</p> <p>Press <b>ENTER</b> to dismiss the message.</p>	
<p>It is strongly recommended that you replace the lamp at this age. The lamp is a consumable item. The lamp brightness diminishes with use. This is normal lamp behavior. You can replace the lamp whenever you notice that the brightness level has significantly diminished.</p> <p>Press <b>ENTER</b> to dismiss the message.</p>	
<p>The lamp <b>MUST</b> be replaced before the projector will operate normally.</p> <p>Press <b>ENTER</b> to dismiss the message.</p>	

☞ "XXXX" shown in the above messages are numbers that vary depending on different models.

## Replacing the lamp



- To reduce the risk of electrical shock, always turn the projector off and disconnect the power cable before changing the lamp.
- To reduce the risk of severe burns, allow the projector to cool for at least 45 minutes before replacing the lamp.
- To reduce the risk of injuries to fingers and damage to internal components, use caution when removing lamp glass that has shattered into sharp pieces.
- To reduce the risk of injuries to fingers and/or compromising image quality by touching the lens, do not touch the empty lamp compartment when the lamp is removed.
- This lamp contains mercury. Consult your local hazardous waste regulations to dispose of this lamp in a proper manner.

1. Turn the power off and disconnect the projector from the power outlet. Turn off all connected equipment and disconnect all other cables. See ["Turning the projector off" on page 42](#) for details.
2. Loosen the screw on the lamp cover.

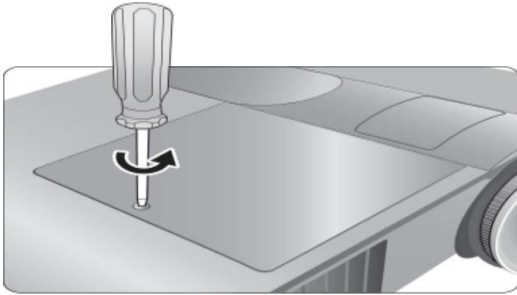

3. Remove the lamp cover.

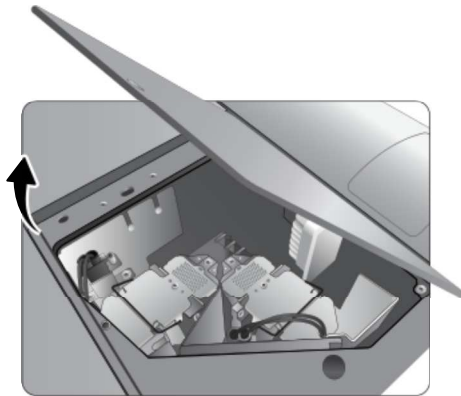

4. Identify the lamp you want to replace by looking at the top of the lamp.

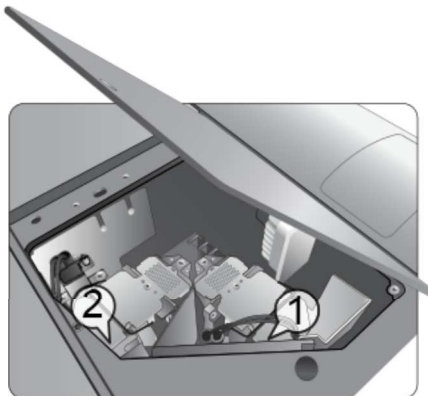

5. Loosen the screw that hold the lamp to the projector. Disconnect the lamp connector from the projector.



6. Lift the handle so that it is perpendicular to the lamp. Use the handle to slowly pull the lamp out of the projector.

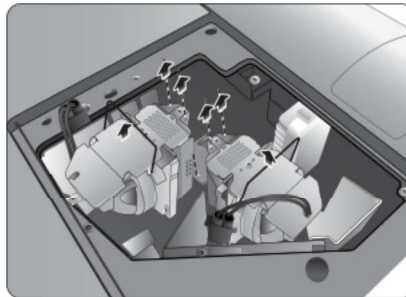

#### Notes

- **Pulling it too quickly may cause the lamp to break and scatter broken glass in the projector. To reduce the risk of injuries to fingers and damage to internal components, use caution when removing lamp glass that has shattered.**
- **Do not place the lamp in locations where water might splash on it, children can reach it, near or above heat sources, or near flammable materials.**
- **Do not insert your hand into the projector when the lamp is removed. If you touch the optical components inside, it could cause blurred images.**

7. Insert the replacement lamp. Make sure it is pushed fully and firmly in place.
10. Replace the lamp cover.

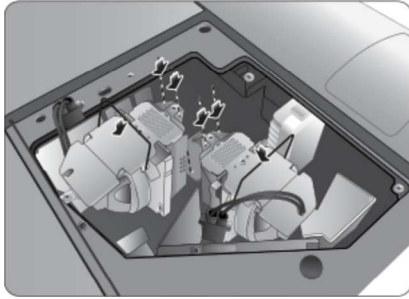

8. Tighten the screw securing the lamp box. Reconnect the lamp connector.
9. Ensure the handle is fully locked in place.

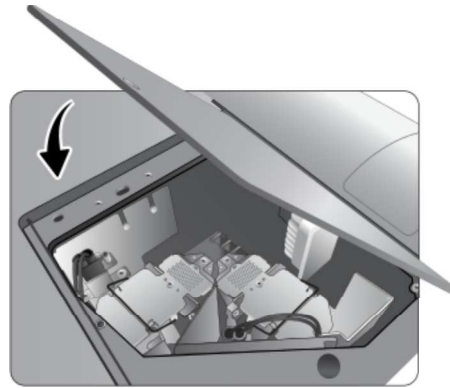
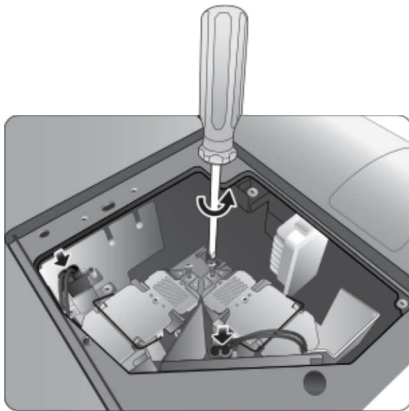

11. Tighten the screws on the lamp cover.
12. Reapply power and turn the projector back on.

#### Notes

- Please be careful to not over-tighten the screws.
- Loose screws may cause a bad connection, which could result in malfunction.

### Resetting the lamp timer

 Do not reset the lamp timer if the lamp has not been replaced as this could cause damage.

1. After the start-up logo, press **MENU/EXIT** and then press **◀/▶** until the **Advanced Setup** menu is highlighted.
2. Press **▼** to highlight **Lamp Settings** and press **ENTER**. The **Lamp Settings** page is displayed.
3. Highlight **Reset Lamp #1 Timer/Reset Lamp #2 Timer** and press **ENTER**. A warning message is displayed asking if you want to reset the lamp timer. Highlight **Reset** and press **ENTER**. The lamp time will be reset to "0".



# Indicators

Light				Status
POWER	TEMP	LAMP1	LAMP2	
<b>Power events</b>				
Orange	Off	Off	Off	Stand-by mode.
Green Flashing	Off	Off	Off	Powering up.
Green	Off	Off	Off	Normal operation.
Orange Flashing	Off	Off	Off	Normal power-down cooling.
<b>Lamp events</b>				
Off	Off	Red	Off	Lamp 1 error in normal operation
Off	Off	Off	Red	Lamp 2 error in normal operation
Off	Off	Red	Red	Both lamps fail
Orange	Off	Red	Off	Lamp is not lit up
<b>Thermal events</b>				
Off	Red	Off	Off	Fan 1 error (T Blower Fan 1 speed is $\pm 25\%$ outside the desired speed)
Off	Red	Red	Off	Fan 2 error (Outlet Power Fan speed is $\pm 25\%$ outside the desired speed)
Off	Red	Green	Off	Fan 3 error (Lamp R Fan speed is $\pm 25\%$ outside the desired speed)
Off	Red	Orange	Off	Fan 4 error (Lamp T Fan speed is $\pm 25\%$ outside the desired speed)
Orange	Red	Red	Off	Temperature 1 error (exceeding temperature limit)
Orange	Red	Green	Off	Temperature 2 error (exceeding temperature limit)
Off	Orange	Red	Off	Fans do not rotate in the process of powering up

# Troubleshooting

Problem	Cause	Remedy
The projector does not turn on.	There is no power from the power cable.	Plug the power cable into the AC inlet on the rear of the projector, and plug the power cable into to the power outlet. If the power outlet has a switch, make sure that it is switched on. (See page 20.)
	Attempting to turn the projector on again during the cooling process.	Wait until the cooling down process has completed.
	The lamp cover is not securely attached.	Correctly attach the lamp cover. (See page 54.)
No picture.	The video source is not turned on or connected correctly.	Turn the video source on and check that the signal cable is connected correctly. (See page 17.)
	The projector is not correctly connected to the input source device.	Check the connection. (See page 17.)
	The input source has not been correctly selected.	Select the correct input source with the Source keys on the remote control or <b>SOURCE</b> on the projector. (See page 21.)
Image is unstable.	The connection cables are not securely connected to the projector or the signal source.	Correctly connect the cables to the appropriate terminals. (See page 17.)
Picture is blurred.	The projection lens is not correctly focused.	Adjust the focus of the lens using the focus ring. (See page 25.)
	The projector and the screen are not aligned properly.	Adjust the projection angle and direction as well as the height of this projector if necessary. (See page 25.)
Remote control does not work correctly.	The batteries are out of power.	Replace both of the batteries with new ones. (See page 7.)
	There is an obstacle between the remote control and the projector.	Remove the obstacle. (See page 7.)
	You are too far away from the projector.	Stand within 8 meters (26.2 feet) of the projector. (See page 7.)

# Specifications

 All specifications are subject to change without notice.

## ■ Optical

Projection system	Single-chip DLP™ system.
DMD chip	0.65" DLP (1920 x 1080)
Lens	F = 2.48 to 2.81, f = 24.1 to 36.15 mm
Projection screen size	30" to 300"
Lamp	350W x 2

## ■ Electrical

Compatibility	PC: 640 x 480 to 1920 x 1200 Video: NTSC, PAL, SECAM, YPbPr (480i/480p/576i/576p/720p/1080i/1080p), HDTV (720p/1080i/1080p) Typ. = 60% NTSC (Target Color Gamut = HDTV Rec. 709)
Color Space	

## ■ Terminals

Input	Analog RGB: D-Sub 15-pin (female) x 1 HDMI (V. 1.3) x 2 Component Video in 5BNC x 1 Component Video (Y/CB/CR, Y/PB/PR) x 1 (shared with RGB input) Composite Video x 1 Audio in x 1
Output	12VDC (Max. 0.5 A) Analog RGB: D-Sub 15-pin (female) x 1 Audio out x 1 Speaker: 10W x 1
Control	Serial Connector: RS232 9 pin (male) Mini B type USB x 1 IR receiver x 2 LAN x 1

## ■ General characteristics

Projector weight	≤ 13 kg (28.66 lbs)
Power	VAC 100-240V, 10 A, 50-60Hz
Power consumption	Max. 1023 W; Standby < 0.5 W
Operating temperature	0 °C to 40 °C (without condensation)
Operating humidity	10% - 90% (without condensation)

■ Dimensions

443 mm x 354.7 mm x 167 mm (W x D x H)

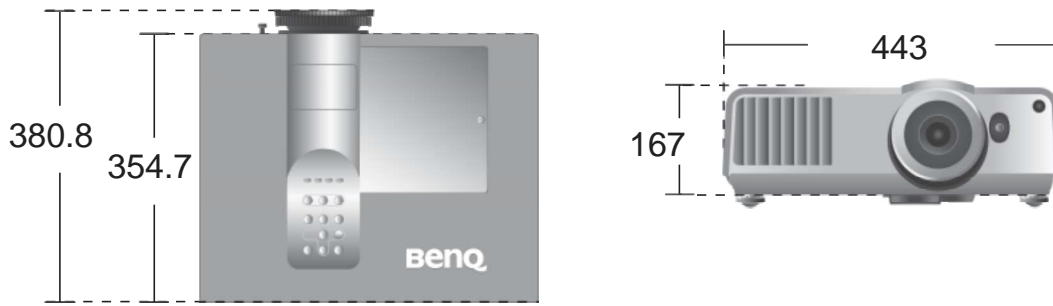

■ Ceiling mount installation

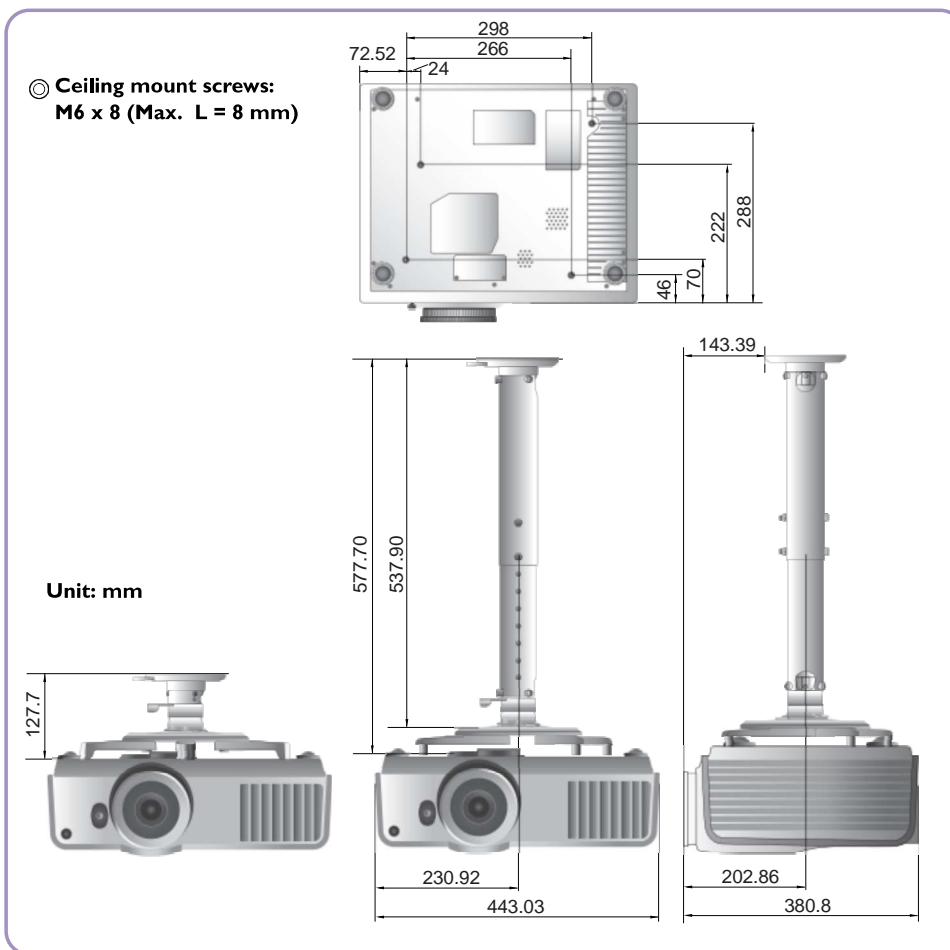

## ■ Timing chart

### Supported timing for PC input

Format	Resolution	Refresh rate (Hz)	H. Frequency (KHz)	Pixel Frequency (MHz)
640 × 480	640 × 480	59.94	31.469	25.175
		72.809	37.861	31.5
		75	37.5	31.5
		85.008	43.269	36
720 × 400	720 × 400	70.087	31.469	28.3221
800 × 600	800 × 600	60.317	37.879	40
		72.188	48.077	50
		75	46.875	49.5
		85.061	53.674	56.25
1024 × 768	1024 × 768	60.004	48.363	65
		70.069	56.476	75
		75.029	60.023	78.75
		84.997	68.667	94.5
1280 × 720	1280 × 720	60.00	45.00	74.25
*1024 × 576	Notebook Timing	60	35.82	46.996
*1024 × 600	Notebook Timing	64.995	41.467	51.419
1280 × 720	1280 × 720	60	45	74.25
1280 × 768	1280 × 768	59.87	47.776	79.5
1280 × 800	1280 × 800	59.81	49.702	83.5
		74.934	62.795	106.5
		84.88	71.554	122.5
1280 × 1024	1280 × 1024	60.02	63.981	108
		75.025	79.976	135
		85.024	91.146	157.5
1280 × 960	1280 × 960	60	60	108
		85.002	85.938	148.5
1360 × 768	1360 × 768	60.015	47.712	85.5
1440 × 900	1440 × 900	59.887	55.935	106.5
1400 × 1050	1400 × 1050	59.978	65.317	121.75
1600 × 1200	1600 × 1200	60	75	162
1680 × 1050	1680 × 1050	59.954	65.29	146.25
1920 × 1080 (VESA)	1920 × 1080	59.963	67.158	173
640 × 480@67Hz (MAC13)	640 × 480@67Hz	66.667	35	30.24
832 × 624@75Hz (MAC16)	832 × 624@75Hz	74.546	49.722	57.28
1024 × 768@75Hz (MAC19)	1024 × 768@75Hz	74.93	60.241	80
1152 × 870@75Hz (MAC21)	1152 × 870@75Hz	75.06	68.68	100

 \* Only for the PC (analog RGB) inputs

**Supported timing for HDMI (HDCP) input**

Format	Resolution	Refresh rate (Hz)	H. Freq. (KHz)	Pixel Freq. (MHz)
480i	720 x 480	59.94	15.734	27
480p	720 x 480	59.94	31.469	27
576i	720 x 576	50	15.625	27
576p	720 x 576	50	31.25	27
720/50p	1280 x 720	50	37.5	74.25
720/60p	1280 x 720	60	45	74.25
1080/50i	1920 x 1080	50	28.125	74.25
1080/60i	1920 x 1080	60	33.75	74.25
1080/24P	1920 x 1080	24	27	74.25
1080/25P	1920 x 1080	25	28.125	74.25
1080/30P	1920 x 1080	30	33.75	74.25
1080/50P	1920 x 1080	50	56.25	148.5
1080/60P	1920 x 1080	60	67.5	148.5

**Supported timing for EDTV and HDTV (via Component inputs)**

Format	Resolution	Refresh rate (Hz)	H. Freq. (KHz)	Pixel Freq. (MHz)
480i	720 x 480	59.94	15.734	13.5
480p	720 x 480	59.94	31.469	27
576i	720 x 576	50	15.625	13.5
576p	720 x 576	50	31.25	27
720/50p	1280 x 720	50	37.5	74.25
720/60p	1280 x 720	60	45	74.25
1080/50i	1920 x 1080	50	28.125	74.25
1080/60i	1920 x 1080	60	33.75	74.25
1080/24P	1920 x 1080	24	27	74.25
1080/25P	1920 x 1080	25	28.125	74.25
1080/30P	1920 x 1080	30	33.75	74.25
1080/50P	1920 x 1080	50	56.25	148.5
1080/60P	1920 x 1080	60	67.5	148.5

**Supported timing for Video input**

Format	Resolution	Refresh rate (Hz)	H. Freq. (KHz)	Pixel Freq. (MHz)
NTSC M/J	-	60	15.734	3.58
NTSC 4.43	-	60	15.734	4.43
PAL-B/D/G/H/I/N	-	50	15.625	4.43
PAL M	-	60	15.734	3.58
PAL Nc	-	50	15.625	3.58
PAL 60	-	60	15.734	4.43
SECAM	-	50	15.625	4.25/4.41

# Warranty and Copyright information

## Warranty

BenQ warrants this product against any defects in material and workmanship, under normal usage and storage.

Proof of purchase date will be required with any warranty claim. In the event this product is found to be defective within the warranty period, BenQ's only obligation and your exclusive remedy shall be replacement of any defective parts (labor included). To obtain warranty service, immediately notify the dealer from which you purchased the product of any defects.

Important: The above warranty shall be void if the customer fails to operate the product in accordance with BenQ's written instructions, especially the ambient humidity must be in-between 10% and 90%, temperature in-between 0°C and 35°C, altitude lower than 3000 meters, and avoiding to operate the projector in a dusty environment. This warranty gives you specific legal rights, and you may have other rights which vary from country to country.

For other information, please visit [www.BenQ.com](http://www.BenQ.com).

## Copyright

Copyright © 2012 by BenQ Corporation. All rights reserved. No part of this publication may be reproduced, transmitted, transcribed, stored in a retrieval system or translated into any language or computer language, in any form or by any means, electronic, mechanical, magnetic, optical, chemical, manual or otherwise, without the prior written permission of BenQ Corporation.

All trademarks and registered trademarks are the property of their respective owners.

## Disclaimer

BenQ Corporation makes no representations or warranties, either expressed or implied, with respect to the contents hereof and specifically disclaims any warranties, merchantability or fitness for any particular purpose. Further, BenQ Corporation reserves the right to revise this publication and to make changes from time to time in the contents hereof without obligation of BenQ Corporation to notify any person of such revision or changes.

\*DLP, Digital Micromirror Device and DMD are trademarks of Texas Instruments. Others are copyrights of their respective companies or organizations.

## Patents

This BenQ projector is covered by the following patents:

U.S. patents 6,837,608; 7,275,834; 7,181,318. TW patents 202690; 205470; I228635; I259932.

China patents ( 中国发明专利 ) ZL01143168.7; ZL03119907.0; ZL200510051609.2



is a trademark of SRS Labs, Inc. WOW HD technology is incorporated under license from SRS

Labs, Inc.

WOW HD™ significantly improves the playback quality of audio, delivering a dynamic 3D entertainment experience with deep, rich bass and high frequency clarity for crisp detail.