

The contents of this publication are the copyright of the publisher and may not be reproduced (even extracts) unless prior written permission is granted. Every care has been taken to ensure the accuracy of the information contained in this publication but no liability can be accepted for any loss or damage whether direct, indirect or consequential arising out of the use of the information contained herein.

Le contenu de cette publication est soumis au copyright de l'éditeur et sa reproduction, même partielle, est interdite sans autorisation écrite préalable. Le plus grand soin a été apporté à l'exactitude des informations données dans cette publication mais SKF décline toute responsabilité pour les pertes ou dommages directs ou indirects découlant de l'utilisation du contenu du présent document.

Nachdruck, auch auszugsweise, nur mit unserer vorherigen schriftlichen Genehmigung gestattet. Die Angaben in dieser Druckschrift wurden mit größter Sorgfalt auf ihre Richtigkeit hin überprüft. Trotzdem kann keine Haftung für Verluste oder Schäden irgendwelcher Art übernommen werden, die sich mittelbar oder unmittelbar aus der Verwendung der hier enthaltenen Informationen ergeben.

El contenido de esta publicación es propiedad de los editores y no puede reproducirse (incluso parcialmente) sin autorización previa por escrito. Se ha tenido el máximo cuidado para garantizar la exactitud de la información contenida en esta publicación, pero no se acepta ninguna responsabilidad por pérdidas o daños, ya sean directos, indirectos o consecuentes, que se produzcan como resultado del uso de dicha información.

La riproduzione, anche parziale, del contenuto di questa pubblicazione è consentita soltanto previa autorizzazione scritta della SKF. Nella stesura è stata dedicata la massima attenzione al fine di assicurare l'accuratezza dei dati, tuttavia non si possono accettare responsabilità per eventuali errori od omissioni, nonché per danni o perdite diretti o indiretti derivanti dall'uso delle informazioni qui contenute.

O conteúdo desta publicação é de direito autoral do editor e não pode ser reproduzido (nem mesmo parcialmente), a não ser com permissão prévia por escrito. Todo cuidado foi tomado para assegurar a precisão das informações contidas nesta publicação, mas nenhuma responsabilidade pode ser aceita por qualquer perda ou dano, seja direto, indireto ou consequente, como resultado do uso das informações aqui contidas.

本出版物内容的著作权归出版者所有且未经事先书面许可不得被复制（甚至引用）。我们已采取了一切注意措施以确定本出版物包含的信息准确无误，但我们不对因使用此等信息而产生的任何损失或损害承担任何责任，不论此等责任是直接、间接或附随性的。

Содержание этой публикации является собственностью издателя и не может быть воспроизведено (даже частично) без предварительного письменного разрешения. Несмотря на то, что были приняты все меры по обеспечению точности информации, содержащейся в настоящем издании, издатель не несет ответственности за любой ущерб, прямой или косвенный, вытекающий из использования вышеуказанной информации.



SKF Maintenance Products

© SKF is a registered trademark of the SKF Group.
© SKF Group 2015/03

www.mapro.skf.com
www.skf.com/mount

MP5260

SKF



SKF TMFT 36

Instructions for use
Mode d'emploi
Bedienungsanleitung
Instrucciones de uso

Manuale d'istruzioni
Instruções de uso
使用说明书
Инструкция по эксплуатации

! TMBA G11W ! ! ! ! ! MP5260

! ! BANG !

BANG ! BANG !

! !



4,5,6 7,8 7,8

CLICK !

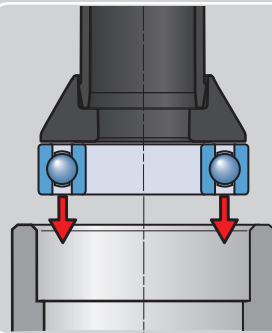

CLICK !

! !

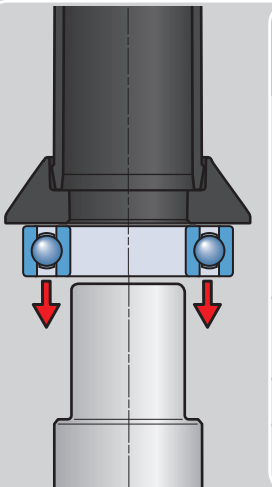

A 				B 				C 								
A10-26	A10-30	A12-28	A12-37	A15-32	B20-42	B25-47	B25-52	B30-55	B35-62	B35-72	C40-68	C40-90	C45-C85	C45-100	C50-80	C50-110
618.	61803		61805	61804	61806	61807	61808	61809	61810	61811						
619..		61903	61902	61904	61905	61906		61907	61908	61910	61909				61911	
NU 4..											NU406		NU407		NU408	NU409
NJ 4..											NJ406		NJ407		NJ408	NJ409
CARB®														C4908V	C4910V	
											C6910V	C6909V		C6912V		C6911V



A 				B 				C 				
A10-26	A12-28	A15-32	A17-35	B20-42	B25-47	B30-55	B35-62	C40-68	C45-75	C50-80	C55-90	
60..				6004								
160..			16004									
982..			98204									
618..	61800	61801	61802	61803	61804	61805	61806	61807	61808	61809	61810	61811
619..	61900	61901	61902	61903	61904	61905	61906	61907	61908	61909	61910	61911
63...				63004								
NU 4..									NU406	NU407	NU408	NU409
NJ 4..									NJ406	NJ407	NJ408	NJ409
32...				32004								
CARB®									C4908		C4910	
											C6910	
											C6910	

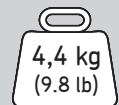

TMFT 36

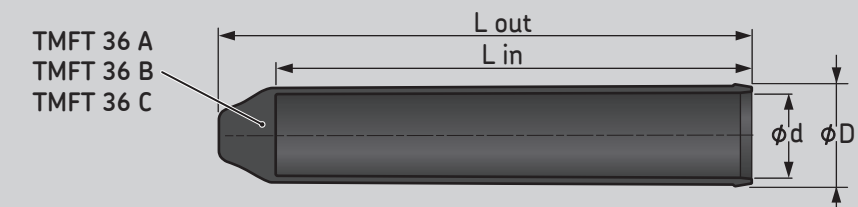
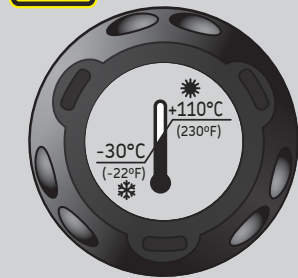
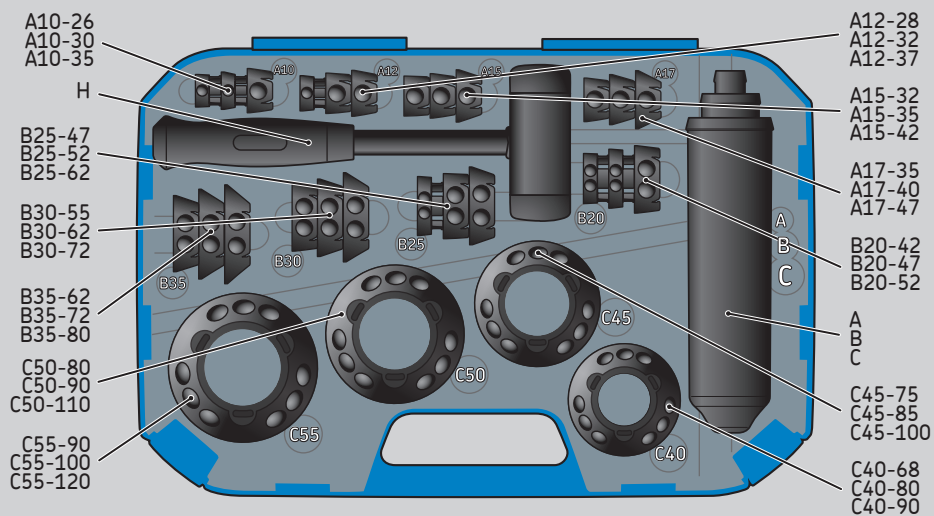
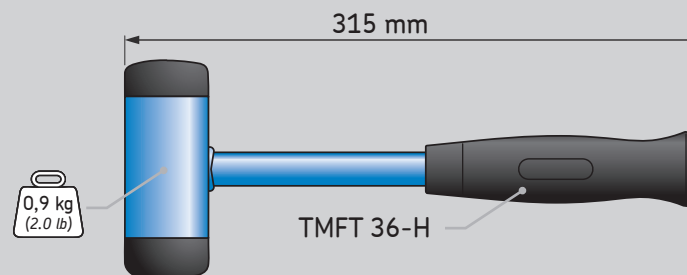
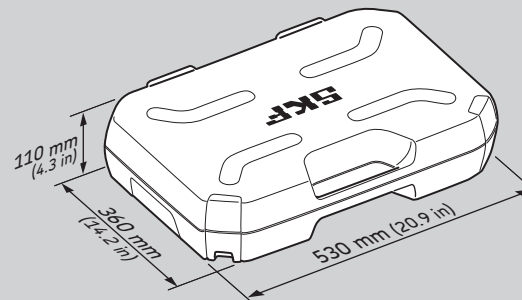

	D		d		L out		L in	
	mm	in	mm	in	mm	in	mm	in
TMFT 36 A	25	1.0	18	0.7	228	9.0	210	8.3
TMFT 36 B	45	1.7	37	1.4	235	9.3	210	8.3
TMFT 36 C	66	2.6	57	2.2	245	9.6	215	8.4

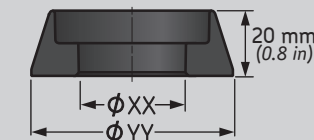

TMFT 36 C45-100 = TMFT 36 C45-10
 TMFT 36 C50-110 = TMFT 36 C50-11
 TMFT 36 C55-100 = TMFT 36 C55-10
 TMFT 36 C55-120 = TMFT 36 C55-12

TMFT 36 ..	TMFT 36 ..	TMFT 36 ..	TMFT 36 ..	TMFT 36 ..	TMFT 36 ..
A10-26	A15-32	B20-42	B30-55	C40-68	C50-80
A10-30	A15-35	B20-47	B30-62	C40-80	C50-90
A10-35	A15-42	B20-52	B30-72	C40-90	C50-110
A12-28	A17-35	B25-47	B35-62	C45-75	C55-90
A12-32	A17-40	B25-52	B35-72	C45-85	C55-100
A12-37	A17-47	B25-62	B35-80	C45-100	C55-120
A XX-YY		B XX-YY		C XX-YY	