

SKF TMMK 20-50

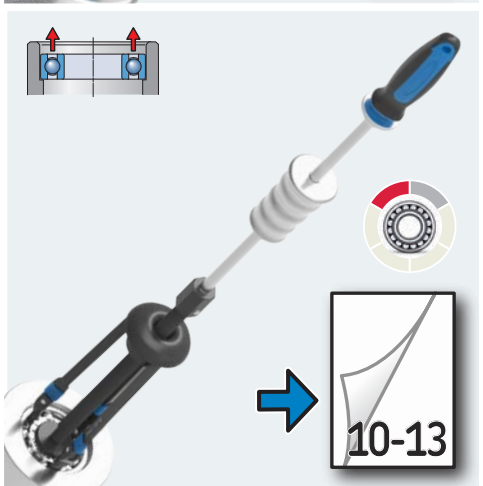

Instructions for use
Mode d'emploi
Bedienungsanleitung
Instrucciones de uso

Manuale d'istruzioni
Instruções de uso
使用说明书
Инструкция по эксплуатации

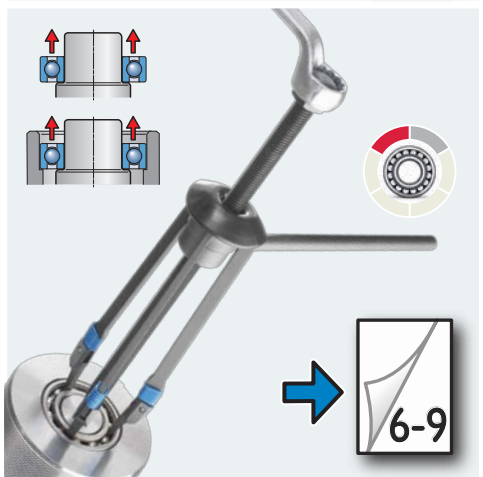
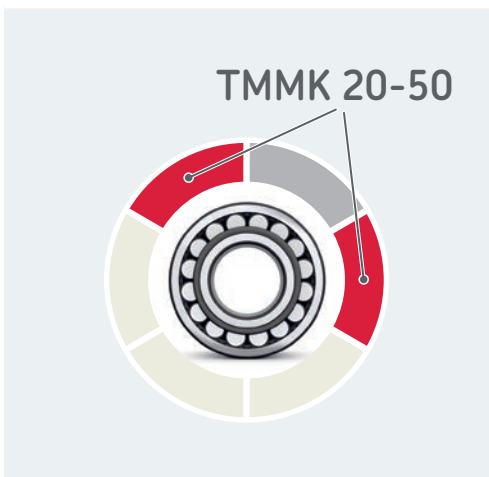
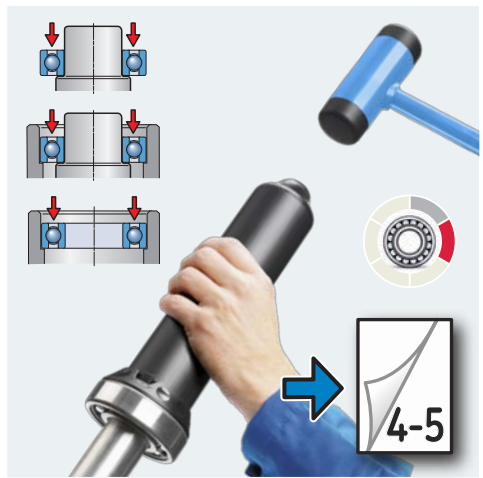
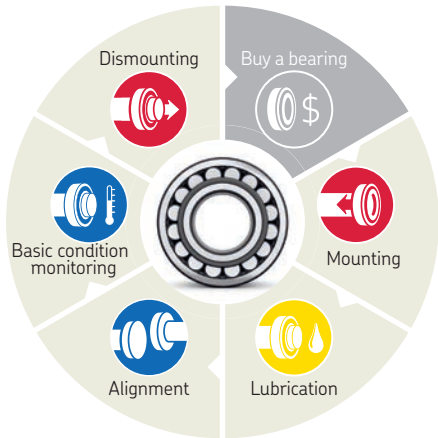

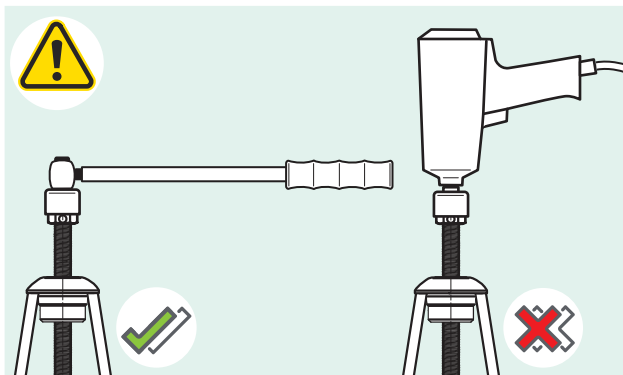
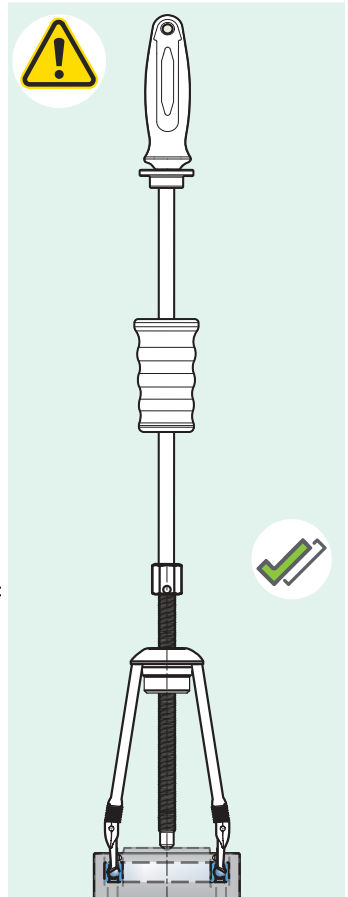
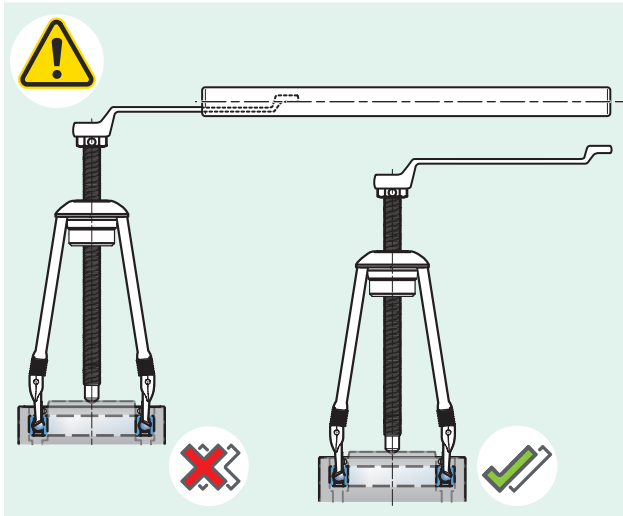
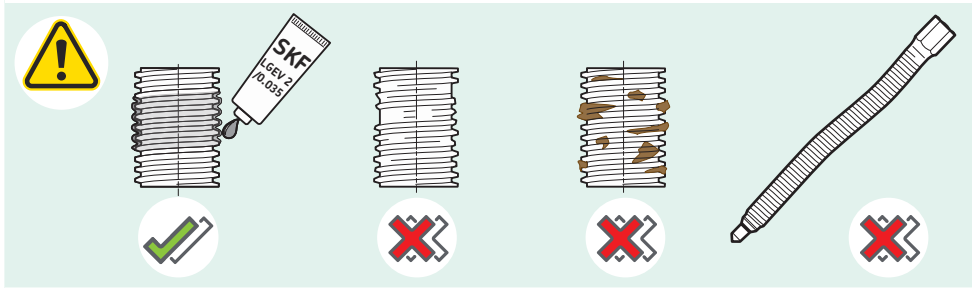
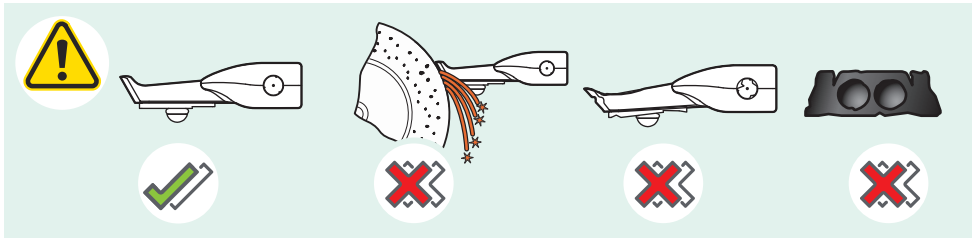

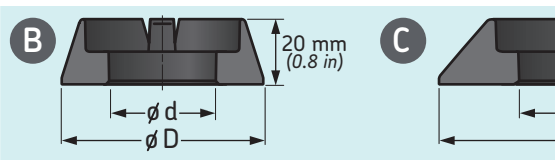
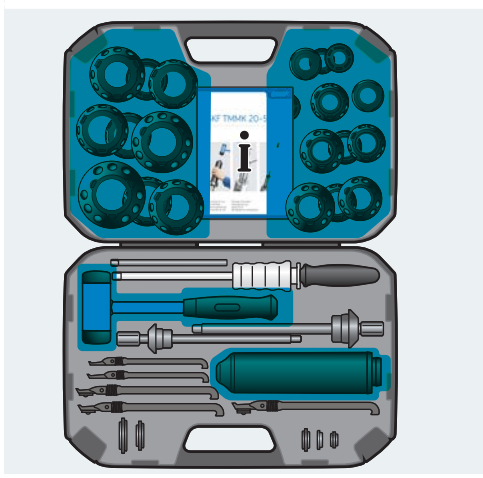
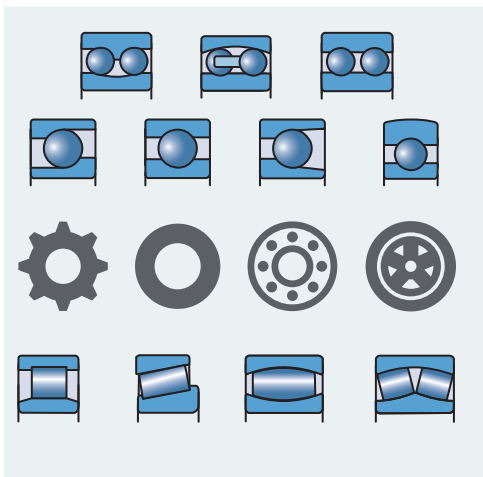
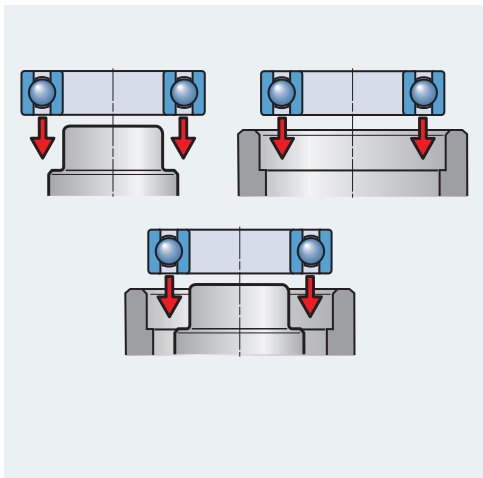

	d		D		60..	6
	mm	in	mm	in		
TMFT 36 B20-42	20	0.8	42	1.6	6004	
TMFT 36 B20-47	20	0.8	47	1.8		6
TMFT 36 B20-52	20	0.8	52	2.0		
TMFT 36 B25-47	25	1.0	47	1.9	6005	6
TMFT 36 B25-52	25	1.0	52	2.0		6
TMFT 36 B25-62	25	1.0	62	2.4		
TMFT 36 B30-55	30	1.2	55	2.2	6006	6
TMFT 36 B30-62	30	1.2	62	2.4		6
TMFT 36 B30-72	30	1.2	72	2.8		
TMFT 36 B35-62	35	1.4	62	2.4	6007	
TMFT 36 B35-72	35	1.4	72	2.8		6
TMFT 36 B35-80	35	1.4	80	3.1		

	d		D		60..	6
	mm	in	mm	in		
TMFT 36 C40-68	40	1.6	68	2.7	6008	
TMFT 36 C40-80	40	1.6	80	3.1		6
TMFT 36 C40-90	40	1.6	90	3.5		
TMFT 36 C45-75	45	1.8	75	2.9	6009	
TMFT 36 C45-85	45	1.8	85	3.3		6
TMFT 36 C45-100	45	1.8	100	3.9		
TMFT 36 C50-80	50	2.0	80	3.1	6010	
TMFT 36 C50-90	50	2.0	90	3.5		6
TMFT 36 C50-110	50	2.0	110	4.3		

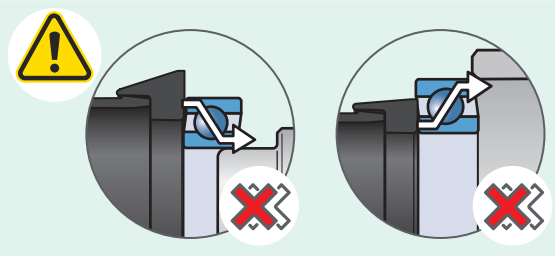

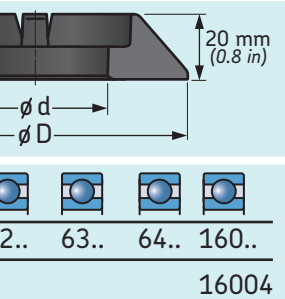

2..	63..	64..	160..
16004			
204			
6304			
2/22	16005		
205	63/22		
	6305	6403	
2/28	16006		
206	63/28		
	6306	6404	
16007			

207			
6307	6405		

2..	63..	64..	160..
16008			

208			
6308	6406		
16009			

209			
6309	6407		
16010			

210			
6310	6408		



1

???

	d	D	mm in	60..	62..	63..	64..	160..
TMTF 36 B10-42	20	48	42 1.6	6004				16004
TMTF 36 B20-47	20	58	47 1.8	6204				6304
TMTF 36 B20-52	20	68	52 2.0					6305
TMTF 36 B25-47	25	57	47 1.9	6005	6202			16005
TMTF 36 B25-52	25	57	52 2.0	6205	6302			6305
TMTF 36 B25-62	25	67	62 2.4					6305
TMTF 36 B30-56	30	55	52 2.0	6006	6208			16006
TMTF 36 B30-62	30	62	62 2.4	6206	6304			6306
TMTF 36 B30-72	30	72	72 2.8					6306
TMTF 36 B35-62	35	62	62 2.4	6007	6207			16007
TMTF 36 B35-67	35	67	67 2.6					6307
TMTF 36 B35-72	35	72	72 2.8					6307

???

2

CLICK!

3

BANG!

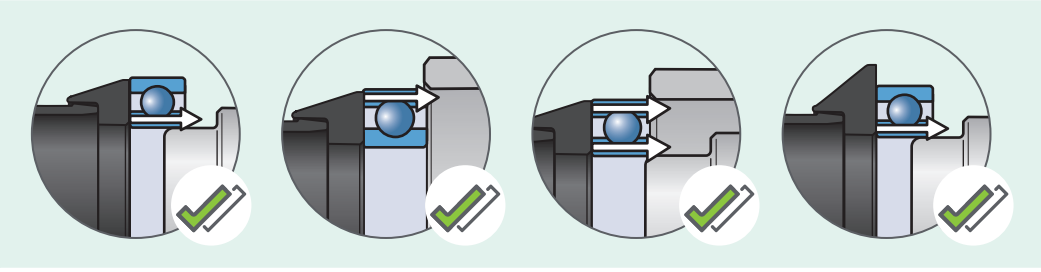

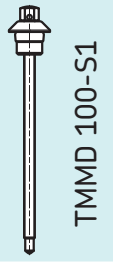
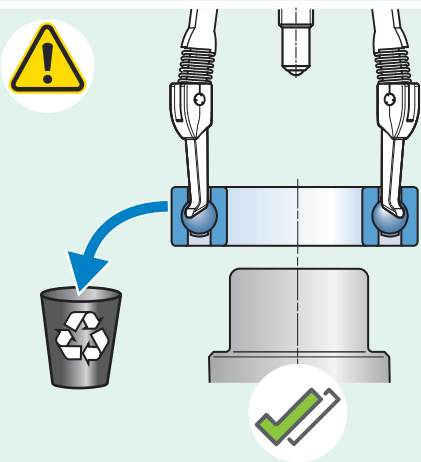
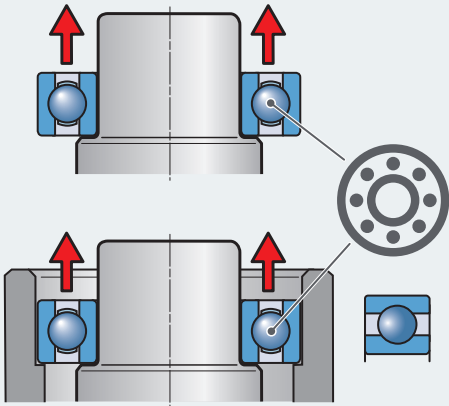

TMMMD 100-A2



TMMMD 100-A3



TMMMD 100-A4

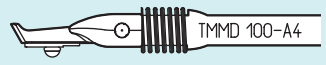

TMMMD 100-A5

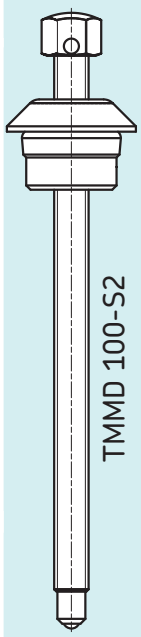
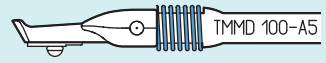

TMMMD 100-A6

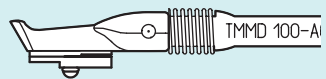



60..	62..	63..	64..	160..
6004	6201			
6005	6202			
6006	6203			
6007	6204	6300		16011
6008	6205	6301		
6009	62/22	6302		
6010				
	6206	6303		
	62/28	6304		
6011		63/22		
6012				
6013				
	6207	6305		
	6208	63/28		
6014	6209	6306	6403	
6015				
6016	6210	6307		
6017	6211			
6018		6308	6404	
6019			6405	
6020				
	6212		6406	
	6213			
	6214	6309	6407	
	6215	6310		
	6216			
	6217			
	6218	6311	6408	
		6312	6409	
		6313	6410	

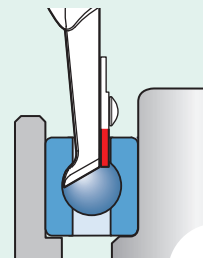
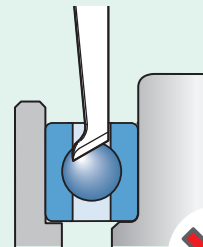
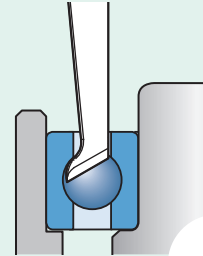
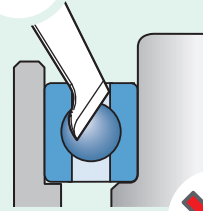

1 ? ? ?

	60.	62.	63.	64.	160.	161.
	6000	6200			16000	16100
	6001				16001	16101
	6002				16002	16102
	6003				16003	16103
TMMD 100-A1	6004	6301				
	6005	6302				
	6006	6303				
TMMD 100-A3	6007	6304	6300			16011
	6008	6305	6301			
	6009	6302	6302			
	6010					
TMMD 100-A4		6306	6303			
		6028	6304			
	6011					
	6012					
	6013					
TMMD 100-A5		6307	6305			
		6308	6306			
		6309	6307			
	6014	6210	6307			
	6015	6211				
	6016					
	6017	6211				
	6018		6308	6404		
	6019					
	6020					
		6212				
		6213				
		6214	631			
		6215	631			
		6216	631			
		6217	631			
		6218	631			
		6219	631			
		6220	631			

6-7

2 A4 / A5 / A6

x3

6-7

3 I

5 II ~120°

6 II

7 III

9

10

11

4

I

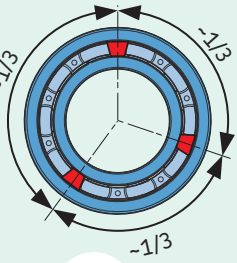
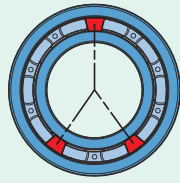
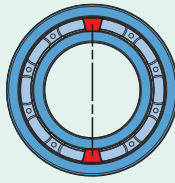
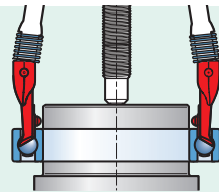

8

III

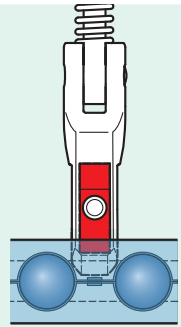
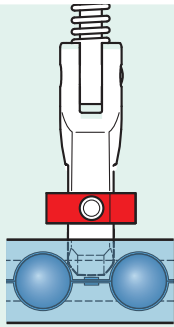
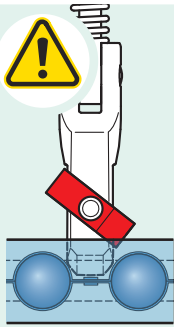

12

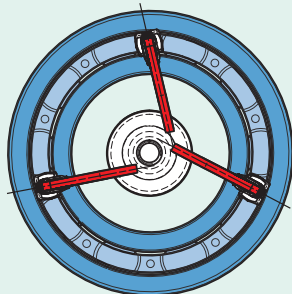
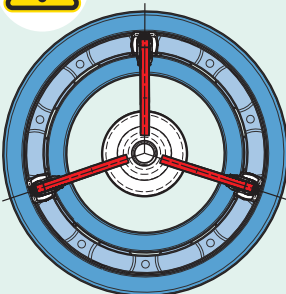

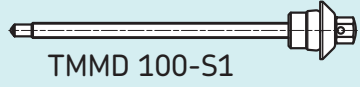
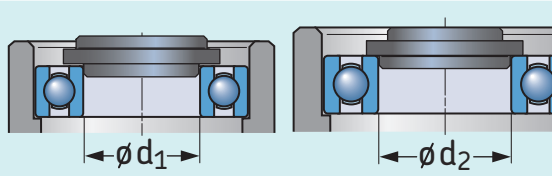
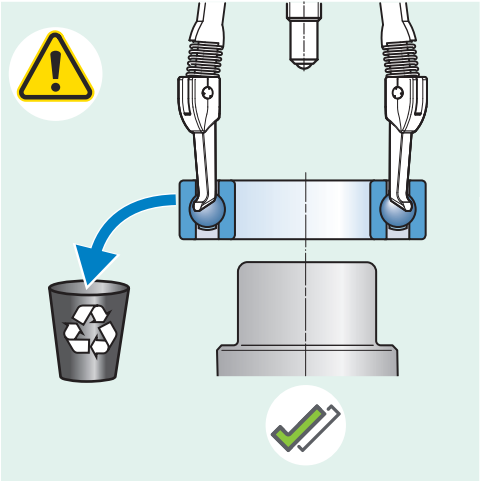
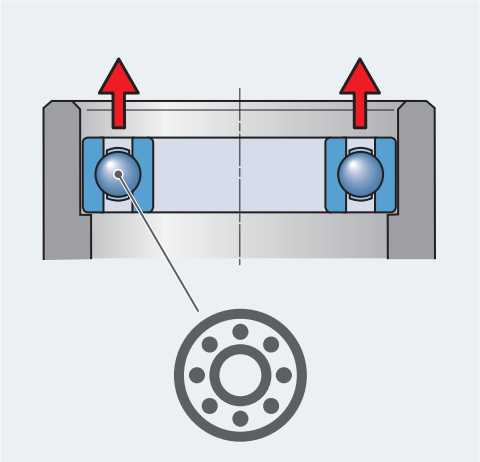

TMMD 100-S1

TMMD 100

TMMD 100

TMMD 100



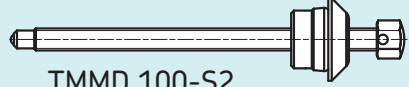





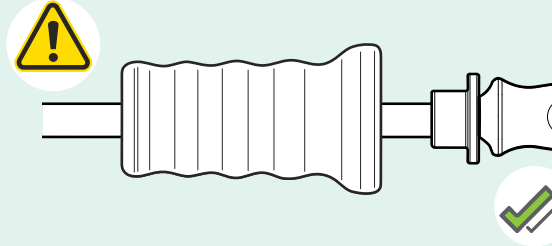

TMMD 100

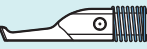

TMMD 100-S2

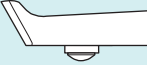
TMMD 100

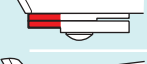

											
		d ₁	d ₂	d ₁	d ₁	d ₂	d ₁	d ₂	d ₁	d ₂	
	mm	20	22	25	28	30	35	40	45	50	
	in	0.8	0.9	1.0	1.1	1.2	1.4	1.6	1.8	2.0	
-A2		6004		6005		6006					
-A3		6204	62/22	6205				6007	6008	6009 6010	
-A4		6304				62/28 6206					
		63/22									
-A5				6305	63/28		6207 6208				
						6306				6209	
								6307		6210	
-A6		6404		6405				6308			
						6406					
								6407		6309 6310	
								6408		6409	
										6410	

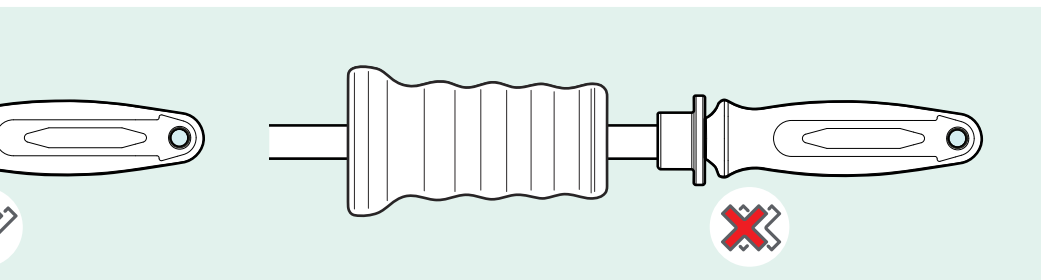

1

? ? ?

	d1	d2	d1	d2	d1	d2	d1	d2
	mm		mm		mm		mm	
	20	22	25	30	35	40	45	50
	0.8	0.9	1.0	1.2	1.4	1.6	1.8	2.0
TMMD 100-A2	6004	6204	6005	6205	6006	6206	6007	6207
TMMD 100-S1								
TMMD 100-A3	6304	6322	6205	6205	6306	6306	6007	6009
TMMD 100-A4	6304	6322	6205	6205	6306	6306	6007	6009
TMMD 100-A5	6305	6328	6306	6306	6207	6208	6207	6208
TMMD 100-S2	6404	6405	6307	6210				
TMMD 100-A6								

2 A4/A5/A6

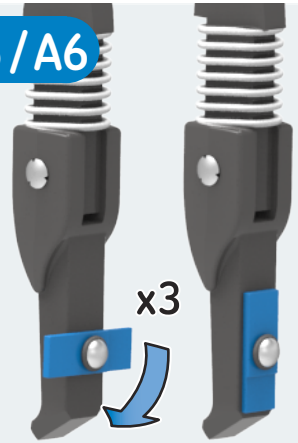
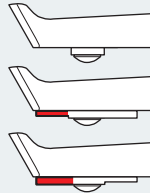

6



7

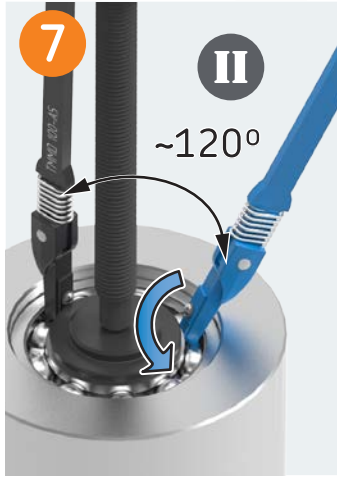

8

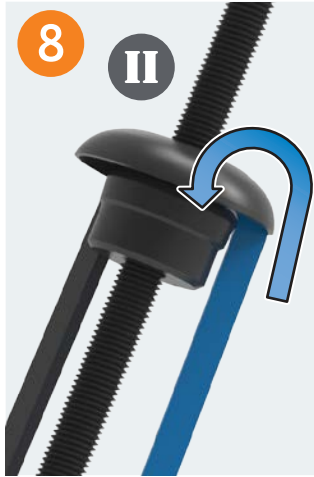

9



10



11



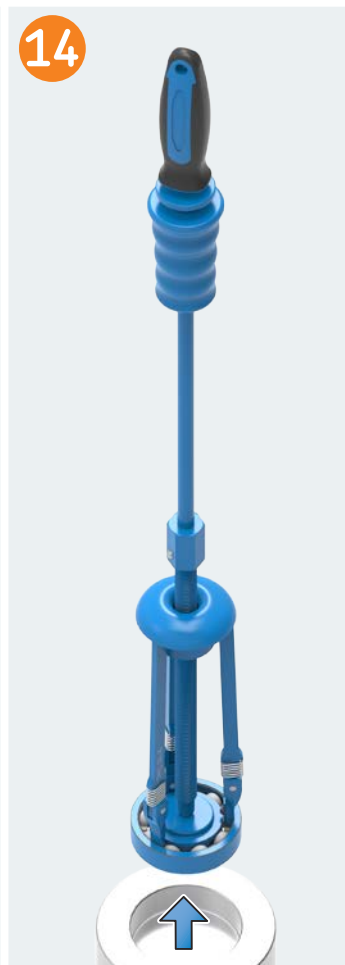
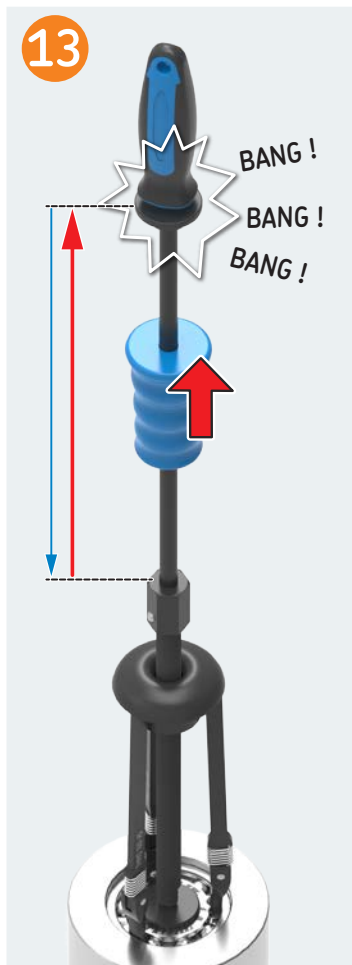
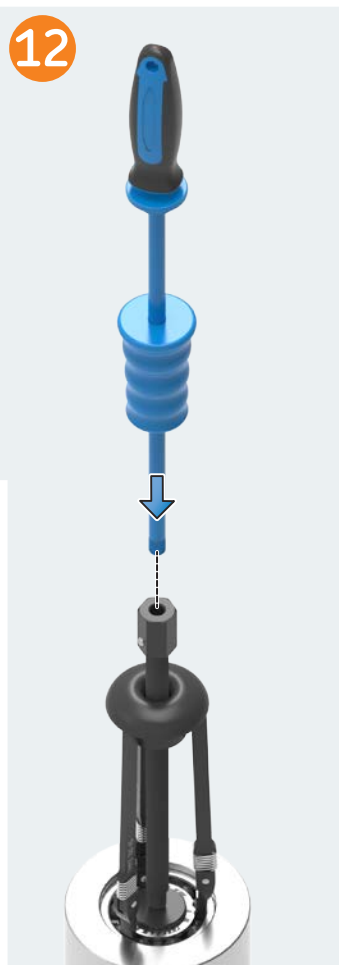
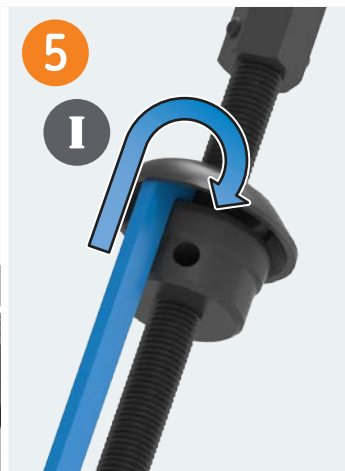

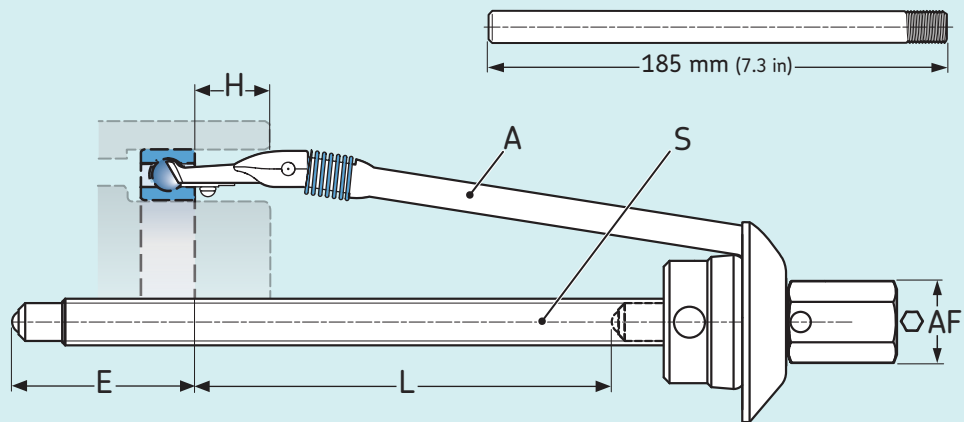

S	A	L		H		E		AF	
		mm	in	mm	in	mm	in	mm	in
TMMD 100-S1	TMMD 100-A2	135	5.3	16	0.6	79	3.1	19	3/4
	TMMD 100-A3	137	5.4	23	0.9	77	3.0		
TMMD 100-S2	TMMD 100-A4	162	6.4	26	1.0	52	2.0	24	1
	TMMD 100-A5	167	6.6	52	2.0	49	1.9		
	TMMD 100-A6	170	6.7	100	3.9	49	1.9		

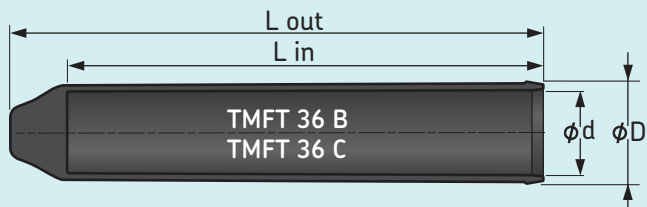

	d		D		L _{in}		L _{out}	
	mm	in	mm	in	mm	in	mm	in
TMFT 36 B	37	1.4	45	1.7	210	8.3	235	9.3
TMFT 36 C	57	2.2	66	2.6	215	8.4	245	9.6

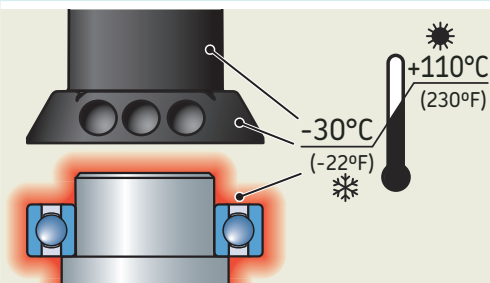
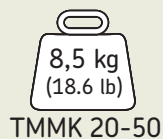

TDTC 1/C

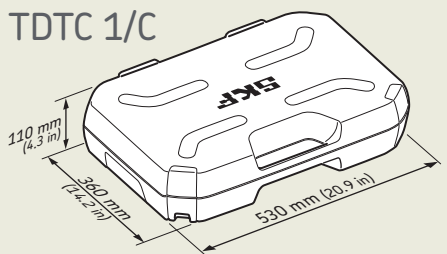

TMMX 210

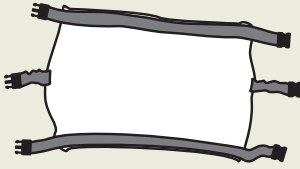

LGEV 2/0.035

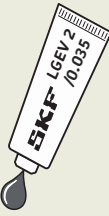

TMFT 36 B20-42 TMFT 36 B25-47
 TMFT 36 B20-47 TMFT 36 B25-52
 TMFT 36 B20-52 TMFT 36 B25-62
 TMFT 36 B30-55 TMFT 36 B35-62
 TMFT 36 B30-62 TMFT 36 B35-72
 TMFT 36 B30-72 TMFT 36 B35-80

TMMD 100-A2

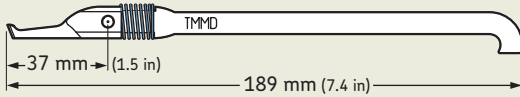

TMFT 36 C40-68 TMFT 36 C50-80
 TMFT 36 C40-80 TMFT 36 C50-90
 TMFT 36 C40-90 TMFT 36 C50-110
 TMFT 36 C45-75
 TMFT 36 C45-85
 TMFT 36 C45-100

TMMD 100-A3

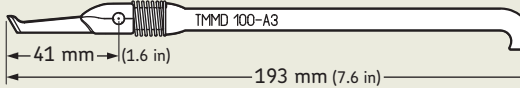

TMMD 100-A4

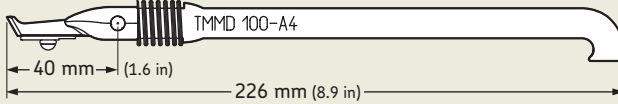

TMMD 100-A5

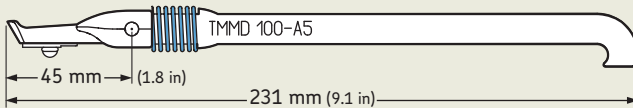

TMMD 100-A6

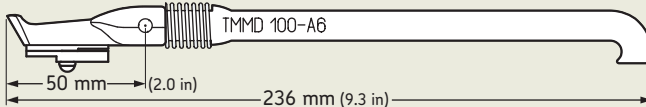

TMIP S1

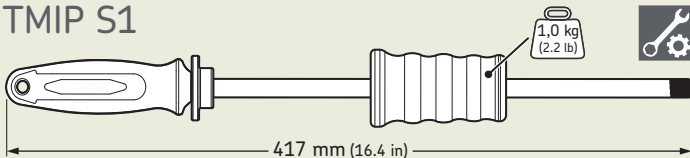

TMFT 36-H

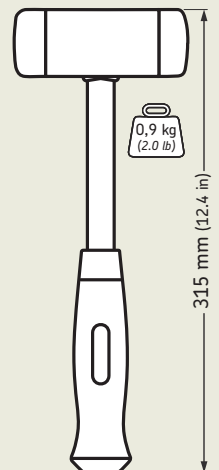

The contents of this publication are the copyright of the publisher and may not be reproduced (even extracts) unless prior written permission is granted. Every care has been taken to ensure the accuracy of the information contained in this publication but no liability can be accepted for any loss or damage whether direct, indirect or consequential arising out of the use of the information contained herein.

Le contenu de cette publication est soumis au copyright de l'éditeur et sa reproduction, même partielle, est interdite sans autorisation écrite préalable. Le plus grand soin a été apporté à l'exactitude des informations données dans cette publication mais SKF décline toute responsabilité pour les pertes ou dommages directs ou indirects découlant de l'utilisation du contenu du présent document.

Nachdruck, auch auszugsweise, nur mit unserer vorherigen schriftlichen Genehmigung gestattet. Die Angaben in dieser Druckschrift wurden mit größter Sorgfalt auf ihre Richtigkeit hin überprüft. Trotzdem kann keine Haftung für Verluste oder Schäden irgendwelcher Art übernommen werden, die sich mittelbar oder unmittelbar aus der Verwendung der hier enthaltenen Informationen ergeben.

El contenido de esta publicación es propiedad de los editores y no puede reproducirse (incluso parcialmente) sin autorización previa por escrito. Se ha tenido el máximo cuidado para garantizar la exactitud de la información contenida en esta publicación, pero no se acepta ninguna responsabilidad por pérdidas o daños, ya sean directos, indirectos o consecuentes, que se produzcan como resultado del uso de dicha información.

La riproduzione, anche parziale, del contenuto di questa pubblicazione è consentita soltanto previa autorizzazione scritta della SKF. Nella stesura è stata dedicata la massima attenzione al fine di assicurare l'accuratezza dei dati, tuttavia non si possono accettare responsabilità per eventuali errori od omissioni, nonché per danni o perdite diretti o indiretti derivanti dall'uso delle informazioni qui contenute.

O conteúdo desta publicação é de direito autoral do editor e não pode ser reproduzido (nem mesmo parcialmente), a não ser com permissão prévia por escrito. Todo cuidado foi tomado para assegurar a precisão das informações contidas nesta publicação, mas nenhuma responsabilidade pode ser aceita por qualquer perda ou dano, seja direto, indireto ou consequente como resultado do uso das informações aqui contidas.

本出版物内容的著作权归出版者所有且未经事先书面许可不得被复制（甚至引用）。我们已采取了一切注意措施以确定本出版物包含的信息准确无误，但我们不对因使用此等信息而产生的任何损失或损害承担任何责任，不论此等责任是直接、间接或附随性的。

Содержание этой публикации является собственностью издателя и не может быть воспроизведено (даже частично) без предварительного письменного разрешения. Несмотря на то, что были приняты все меры по обеспечению точности информации, содержащейся в настоящем издании, издатель не несет ответственности за любой ущерб, прямой или косвенный, вытекающий из использования вышеуказанной информации.



skf.com | mapro.skf.com | skf.com/mount

© SKF is a registered trademark of the SKF Group.

© SKF Group 2016

MP5444 · 2016/11