

SMART Board MX (V2) series interactive displays

USER GUIDE

SBID-MX255-V2 | SBID-MX265-V2 | SBID-MX275-V2 | SBID-MX286-V2 | SBID-MX255-V2-PW | SBID MX265-V2-PW |
SBID-MX275-V2-PW | SBID-MX286-V2-PW

Was this document helpful?
smarttech.com/docfeedback/171554

SMART[®]



Learn more

This guide and other resources for SMART Board MX (V2) and MX (V2) Pro series interactive displays are available in the Support section of the SMART website (smarttech.com/support). Scan this QR code to view these resources on your mobile device.

Trademark notice

SMART Board, smarttech, the SMART logo and all SMART taglines are trademarks or registered trademarks of SMART Technologies ULC in the U.S. and/or other countries. All third-party product and company names may be trademarks of their respective owners.

Copyright notice

© 2021 SMART Technologies ULC. All rights reserved. No part of this publication may be reproduced, transmitted, transcribed, stored in a retrieval system or translated into any language in any form by any means without the prior written consent of SMART Technologies ULC. Information in this manual is subject to change without notice and does not represent a commitment on the part of SMART.

This product and/or use thereof is covered by one or more of the following U.S. patents:

www.smarttech.com/patents

January 20, 2021

Important information

NOTE

Refer to the *SMART Board MX (V2) and MX (V2) Pro series interactive displays installation and maintenance guide* (smarttech.com/kb/171555) for important information about installing and maintaining the display.

WARNING

- Do not open or disassemble the display. You risk electrical shock from the high voltage inside the casing. Opening the casing also voids the warranty.
- Do not stand (or allow children to stand) on a chair to touch the surface of the display.
- To reduce the risk of fire or electric shock, do not expose the display to rain or moisture.
- Do not insert objects inside the cabinet ventilation holes, because they could touch dangerous voltage points and cause electric shock, fire or product damage which may not be covered by the warranty.
- Do not place heavy objects on the power cable. Damage to the cable could cause shock, fire or product damage which may not be covered by the warranty.
- If the glass is broken, do not touch the liquid crystal. To prevent injury, handle glass fragments with care when disposing of them.
- Disconnect all of the display's power cables from the wall outlet and seek assistance from qualified service personnel if any of the following occur:
 - The power cable or plug is damaged
 - Liquid is spilled into the display
 - Objects fall into the display
 - The display is dropped
 - Structural damage, such as cracking, occurs
 - The display behaves unexpectedly when you follow operating instructions
- Before inserting or removing an OPS from the display, turn off the display using the switch at the back of the display. See [Open Pluggable Slot computer \(OPS\) disclaimer](#) for more information.

ENERGY STAR®



ENERGY STAR is the government-backed symbol for energy efficiency, providing simple, credible, and unbiased information that consumers and businesses rely on to make well-informed decisions. ENERGY STAR-certified products are the simple choice for energy efficiency, making it

easy for consumers and businesses to make purchases that save them money and protect the environment. The U.S. EPA ensures that each product that earns the label is independently certified to deliver the quality, performance, and savings that users have come to expect.

As shipped, your display delivers ENERGY STAR performance and savings. However, changing some settings may increase energy consumption beyond the limits required for ENERGY STAR certification. For example, increased brightness and contrast will increase power consumption.

Please consider the environment when you choose non-ENERGY STAR settings.

Federal Communication Commission interference statement

FCC

Suppliers Declaration of Conformity

47 CFR § 2.1077 Compliance Information

Unique Identifier: IDX55-2, IDX65-2, IDX75-2, IDX86-2

Responsible Party – U.S. Contact Information

SMART Technologies Inc.

2401 4th Ave., 3rd Floor

Seattle, WA 98121

compliance@smarttech.com

This device complies with Part 15 of the FCC Rules. Operation is subject to the following two conditions:

1. This device may not cause harmful interference, and
2. this device must accept any interference received, including interference that may cause undesired operation.

Important information

NOTE

This equipment has been tested and found to comply with the limits for a Class A digital device, pursuant to part 15 of the FCC Rules. These limits are designed to provide reasonable protection against harmful interference when the equipment is operated in a commercial environment. This equipment generates, uses, and can radiate radio frequency energy and, if not installed and used in accordance with the instruction manual, may cause harmful interference to radio communications. Operation of this equipment in a residential area is likely to cause harmful interference in which case the user will be required to correct the interference at his own expense.

CAUTION

Any changes or modifications not expressly approved by the party responsible for compliance could void the user's authority to operate this equipment.

Restriction

Operations in the 5.15-5.25GHz band are restricted to indoor usage only.

IEEE 802.11b or 802.11g operation of this product in the USA is firmware limited to channels 1 through 13.

CAUTION

- i. the device for operation in the band 5150-5250 MHz is only for indoor use to reduce the potential for harmful interference to co-channel mobile satellite systems;
- ii. the maximum antenna gain permitted for devices in the bands 5250-5350 MHz and 5470-5725 MHz shall comply with the e.i.r.p. limit; and
- iii. the maximum antenna gain permitted for devices in the band 5725-5825 MHz shall comply with the e.i.r.p. limits specified for point-to-point and non point-to-point operation as appropriate.
- iv. Users should also be advised that high-power radars are allocated as primary users (i.e., priority users) of the bands 5250-5350 MHz and 5650-5850 MHz and that these radars could cause interference and/or damage to LE-LAN devices.

Radiation exposure statement

This equipment complies with FCC radiation exposure limits set forth for an uncontrolled environment. This equipment should be installed and operated with minimum distance of 20 cm between the antenna of this device and all nearby persons. This transmitter must not be co-located or operated in conjunction with any other antenna or transmitter.

Innovation, Science and Economic Development Canada statement

This device complies with RSS-247 of the Innovation, Science and Economic Development Canada Rules. Operation is subject to the following two conditions:

1. This device may not cause harmful interference, and
2. this device must accept any interference received, including interference that may cause undesired operation.

Radiation exposure statement

This equipment complies with ISED radiation exposure limits set forth for an uncontrolled environment. This equipment should be installed and operated with minimum distance of 20 cm between the antenna of this device and all nearby persons. This transmitter must not be co-located or operated in conjunction with any other antenna or transmitter.

Innovation, Science et Développement économique Déclaration du Canada

Cet appareil est conforme à la norme ISED CNR-247 pour les appareils radio agréés. Son fonctionnement est soumis aux deux conditions suivantes:

1. le dispositif ne doit pas produire de brouillage préjudiciable, et
2. ce dispositif doit accepter tout brouillage reçu, y compris un brouillage susceptible de provoquer un fonctionnement indésirable.

ADVERTISSEMENT

- i. les dispositifs fonctionnant dans la bande 5 150-5 250 MHz sont réservés uniquement pour une utilisation à l'intérieur afin de réduire les risques de brouillage préjudiciable aux systèmes de satellites mobiles utilisant les mêmes canaux;
- ii. le gain maximal d'antenne permis pour les dispositifs utilisant les bandes 5 250-5 350 MHz et 5 470-5 725 MHz doit se conformer à la limite de p.i.r.e.;
- iii. le gain maximal d'antenne permis (pour les dispositifs utilisant la bande 5 725-5 825 MHz) doit se conformer à la limite de p.i.r.e. spécifiée pour l'exploitation point à point et non point à point, selon le cas.
- iv. De plus, les utilisateurs devraient aussi être avisés que les utilisateurs de radars de haute puissance sont désignés utilisateurs principaux (c.-à-d., qu'ils ont la priorité) pour les bandes 5 250-5 350 MHz et 5 650-5 850 MHz et que ces radars pourraient causer du brouillage et/ou des dommages aux dispositifs LAN-EL.

Déclaration d'exposition aux radiations

Important information

Cet équipement est conforme aux limites d'exposition aux rayonnements ISED établies pour un environnement non contrôlé. Cet équipement doit être installé et utilisé avec un minimum de 20 cm de distance entre la source de rayonnement et votre corps. Cet émetteur ne doit pas être co-implantés ou exploités conjointement avec une autre antenne ou émetteur.

EU declaration of conformity

Hereby SMART Technologies ULC declares that the radio equipment type Interactive displays model SBID-MX255-V2, SBID-MX265-V2, SBID-MX275-V2, SBID-MX286-V2 are in compliance with Directive 2014/53/EU.

WARNING

Operation of this equipment in a residential environment this equipment may could cause radio interference.

The full text of the EU declaration of conformity is available at the following internet address: smarttech.com/compliance

The frequency band and the maximum transmitted power in EU are listed below:

Transmitting Band (MHz)	Maximum Transmit Power EIRP (dBm)
2402-2483.5	19
5150-5350	23
5470-5725	23

Restrictions in

AT/BE/BG/CZ/DK/EE/FR/DE/IS/IE/IT/EL/ES/CY/LV/LI/LT/LU/HU/MT
NL/NO/PL/PT/RO/SI/SK/TR/FI/SE/CH/UK/HR—5150MHz-
5350MHz is for indoor use only

CAUTION: EXPOSURE TO RADIO FREQUENCY RADIATION

This equipment complies with EU radiation exposure limits set forth for an uncontrolled environment. This equipment should be installed and operated with minimum distance 20 cm between the radiator and your body.

Contents

- Important information 3**

- Chapter 1: Welcome viii**
 - About this guide viii
 - About the display ix
 - Identifying your specific model xii
 - Accessories xiii
 - More information xiv

- Chapter 2: Using basic features xv**
 - Waking up the display and putting it back to sleep xv
 - Using the Home button xvi
 - Using the front control panel xvi
 - Using the remote control xvii
 - Using touch xix
 - Writing, drawing, and erasing xxi
 - Adjusting the volume xxiii
 - Freezing or hiding the screen xxiii

- Chapter 3: Using the iQ apps xxv**
 - Using the Apps Library xxv
 - Using the Files Library xxvi
 - Using kapp Whiteboard xxvi
 - Using SMART Notebook Player xxvi
 - Using Browser xxvii
 - Using Screen Share xxvii
 - Using Input xxvii
 - Using screenshots xxvii
 - Installing third-party apps xxviii
 - Cleaning up the display xxix

- Chapter 4: Connecting computers and other devices xxx**
 - Installing and using SMART software xxx
 - Connecting room computers and guest laptops xxxii
 - Connecting a SMART OPS PC module xxxv

Contents

Connecting USB drives, peripherals, and other devices	xxxvi
Chapter 5: Troubleshooting	xxxviii
The display isn't turning on	xxxviii
The screen is blank or there's a problem with the image on the screen	xxxix
There's no sound or there's a problem with the sound	xl
Touch isn't working as expected	xli
The pens and erasers aren't working as expected	xlii
iQ apps aren't working as expected	xlii
SMART software on connected computers isn't working as expected	xliii
The SMART PCM8 OPS PC isn't working as expected	xliii
Contacting your reseller for additional support	xliv

Chapter 1

Welcome

About this guide	viii
About the display	ix
Touch	ix
Writing, drawing, and erasing	ix
iQ experience	x
Display	x
Audio	x
Network connectivity	x
Room computers and guest laptops	xi
Accessory slot	xi
Front control panel	xi
Front connector panel	xi
Ambient light sensor	xi
Power status light	xii
Remote control and IR sensor	xii
Identifying your specific model	xii
Accessories	xiii
SMART OPS PC module	xiii
SBA-100 projection audio system	xiii
Stands	xiv
USB extenders	xiv
More information	xiv

This chapter introduces the SMART Board® MX (V2) and MX (V2) Pro series interactive displays.

About this guide

This guide explains how to use a SMART Board MX (V2) or MX (V2) Pro series interactive display.

This guide is intended for individuals who use displays in their organizations. Other documentation and resources are available for those who install and maintain displays (see *More information* on page xiv).

About the display

The SMART Board MX (V2) or MX (V2) Pro interactive display with iQ is the hub of your classroom.

The display includes an extensive set of features and components:

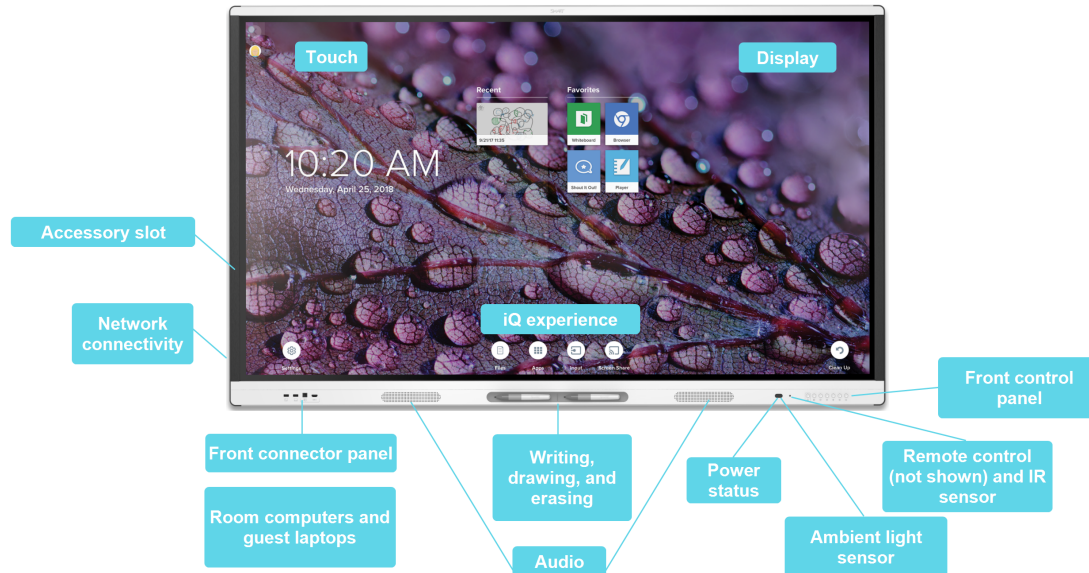

Touch

You can do everything on the display that you can do at your computer—open and close applications, meet with others, create new documents or edit existing ones, visit websites, play and manipulate videos, and so on—by touching the display’s surface.

You can use an array of gestures within applications, including panning, scaling, rotating, and zooming in and out.

For more information, see *Using touch* on page xix.

Writing, drawing, and erasing

The display comes with two pens, which you can use to write or draw on the screen.

Use your fist or palm to erase digital ink on the screen.

With Object Awareness™, the display responds automatically to the tool or object you’re using, whether it’s a pen, finger, or palm. The display’s Simultaneous Tool Differentiation technologies allow two people to write independently and simultaneously.

For more information, see *Writing, drawing, and erasing* on page xxi.

iQ experience

The display's iQ experience provides one-touch access to collaborative tools, including a whiteboard, wireless screen sharing, and a web browser. With minimal network integration, there's no need for wires, cables, or manual software and firmware updates.

Tap the **Home**  button on the display's front control panel or the remote control to open the Home screen. From the Home screen, you can open the iQ apps, switch inputs, and adjust settings.

For more information about the Home screen, see *Using the Home button* on page xvi.

For more information about the iQ apps, see *Chapter 3: Using the iQ apps* on page xxv.

Display

The 4K ultra-high-definition LCD display provides optimal image clarity and wide viewing angles.

The size of the display varies by model:

Models	Size (diagonal)
SBID-MX255-V2 / SBID-MX255-V2-PW	55"
SBID-MX265-V2 / SBID-MX265-V2-PW	65"
SBID-MX275-V2 / SBID-MX275-V2-PW	75"
SBID-MX286-V2 / SBID-MX286-V2-PW	86"

Audio

The display includes two 15 W integrated speakers, which are designed to provide sound at the front of a room.

Network connectivity

The display requires a network connection for downloading software and firmware updates, and a number of the iQ apps require a network connection as well.

You can connect to a network using Wi-Fi or the RJ45 LAN jack on the display:

- Wi-Fi supports both 2.4 and 5 GHz bands.
- The two RJ45 jacks allow you to connect the display and an external device, such as a computer, to a Ethernet network.

Room computers and guest laptops

You can connect room computers and guest laptops and use the display to view and interact with them.

The display comes with SMART software that you can install on connected computers to take full advantage of the display's features while using the connected computers.

For more information, see *Chapter 4: Connecting computers and other devices* on page xxx.

Accessory slot

You can install an OPS-compatible device, such as a SMART OPS PC module, in the accessory slot. The PCM8 series of SMART OPS PC modules provides a complete Windows 10 Pro installation.

For more information on the SMART PCM8 series OPS PC, see *SMART OPS PC module* on page xiii.

CAUTION

The accessory slot's maximum available power is 60 W. The slot is not a limited power source. To reduce the risk of fire, make sure that accessories connecting to the slot satisfy the fire enclosure requirements of IEC 60950-1 and/or IEC 62368-1.

Front control panel

The front control panel contains buttons for turning the display on and off, controlling the volume, freezing and unfreezing the screen, and showing and hiding a screen shade.

For more information about the front control panel, see *Using the front control panel* on page xvi.

Front connector panel

The front connector panel includes connectors for USB peripherals and a computer or other input source.

For more information about the convenience panel, see *Connecting room computers and guest laptops* on page xxxii.

Ambient light sensor

The ambient light sensor is located in the bottom-right corner of the display's frame.

The ambient light sensor detects the brightness of the room and adjusts the screen's brightness accordingly.

Power status light

The power status is located in the bottom-right corner of the display's frame.

The power status light indicates the display's status.

Power status light	Display status
Red	Standby mode
Green	Normal operating mode

Remote control and IR sensor

You can use the remote control to turn the display on and off, adjust display settings, and so on.

The IR sensor for the remote control is located in the bottom-right corner of the display's frame.

For more information about the remote control, see *Using the remote control* on page xvii.

Identifying your specific model

SMART offers several models of the SMART Board MX (V2) and MX (V2) Pro series interactive display. For help identifying your model, see the label on the left side of the display.

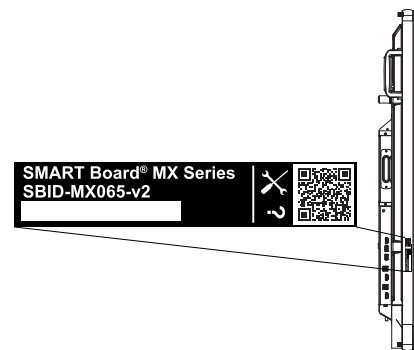

Model	Screen size (approximate)
SBID-MX255-V2	55" (140 cm)
SBID-MX265-V2	65" (165 cm)
SBID-MX275-V2	75" (190 cm)
SBID-MX286-V2	86" (218 cm)
SBID-MX255-V2-PW	55" (140 cm)

Model	Screen size (approximate)
SBID-MX265-V2-PW	65" (165 cm)
SBID-MX275-V2-PW	75" (190 cm)
SBID-MX286-V2-PW	86" (218 cm)

Accessories

Accessories for the display include:

- SMART OPS PC module
- SBA-100 projection audio system
- Stands
- USB extenders

NOTE

For more information about these and other accessories, see smarttech.com/accessories.

SMART OPS PC module

SMART Open Pluggable Specification (OPS) PC modules provide a hassle-free Windows® 10 Pro installation based on eighth generation Intel® Core™ processors and are designed specifically to work with a SMART display. Available in two standard configurations, all OPS PC modules in the PCM8 series are WHQL certified and fully licensed with Windows 10 Pro. Install the OPS PC module in a display's OPS slot to provide a complete 4K UHD Windows 10 installation at your fingertips, without the need for an external PC or additional cables.

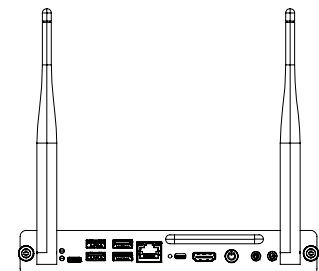

Install familiar Windows applications, such as SMART Notebook®, SMART TeamWorks™, and SMART Meeting Pro® software, and access the internet directly through your display's network connection. Upgrades and service for the OPS PC module are easy to perform without removing the display from its mounting.

SBA-100 projection audio system

 For education models only

The SBA-100 projection audio system consists of two 14 W speakers designed for wall-mounted displays. You can control volume using the display's front control panel or the volume controls on a connected computer.

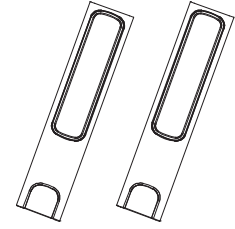

Stands

If you want to move the display from place to place, you can install it on a SMART mobile stand. If you are installing the display on a wall that cannot support the display's full weight, you can install the display on a SMART floor stand.

USB extenders

As noted in the display's specifications, there is a maximum length for USB cable connections between the display and computer.

When using USB 2.0, the cable should be no longer than 16' (5 m).

When using USB 3.0, the cable should be no longer than 9' (3 m).

Use one of the following USB extenders if you need a longer USB connection:

Extender	Specifications
USB-XT	smarttech.com/kb/119318
CAT5-XT-1100	smarttech.com/kb/170202

NOTES

- To extend touch using the SMART CAT 5 USB extender (CAT5-XT-1100) use a touch USB connector associated with an HDMI 1, HDMI 2, or VGA input. The extender will not function correctly if used to extend touch associated with the HDMI 3 input on the front of the display.
- For more information about extending USB connections, see [USB cable extenders](#).

More information

In addition to this guide, SMART provides other documents for the display in the Support section of the SMART website (smarttech.com/support). Scan the QR code on the cover of this guide to view links to SMART Board MX (V2) and MX (V2) Pro series interactive display documents and other support resources.

Chapter 2

Using basic features

Waking up the display and putting it back to sleep	xv
Using the Home button	xvi
Using the front control panel	xvi
Using the remote control	xvii
Using touch	xix
Writing, drawing, and erasing	xxi
Writing and drawing in digital ink	xxi
Using the SMART Ink dynamic (floating) toolbar	xxii
Changing a pen's default color, thickness, and other properties	xxii
Erasing digital ink	xxii
Adjusting the volume	xxiii
Freezing or hiding the screen	xxiii
Freezing the screen	xxiii
Showing and hiding the screen shade	xxiv

This chapter explains how to wake the display when it's asleep, how to view connected computers' input and how to interact with the display.

Waking up the display and putting it back to sleep

To wake the display, press the **Power** button  on the front control panel or remote control.

To return the display to a partial sleeping state, press the **Power** button  on the front control panel or remote control.

NOTE

Touch is not available right after waking up the display or turning it on. Wait a few seconds and then the display will respond to touch.

For information about turning the display off, see *SMART Board MX-V2 series interactive displays installation and maintenance guide* (smarttech.com/kb/171555).

Using the Home button

You can use the Home screen to open and use iQ apps, view the input of connected computers, and more. You can also change the background and personalize other features of the Home screen. To learn more about the Home screen, see [Understanding the Home screen](#).

The Input screen shows thumbnails of connected computers and allows you to switch among inputs.

You can return to the Home screen or the Input screen at any time by following the instructions below.

To show the Home screen or the Input screen

Tap the **Home** button  on the front control panel.

OR

Press the **Home** button  on the remote control.

Using the front control panel

The front control panel contains buttons for returning to the iQ Home screen, switching the input source, showing and hiding a screen shade, controlling the volume, freezing and unfreezing the screen, and turning the display on and off.

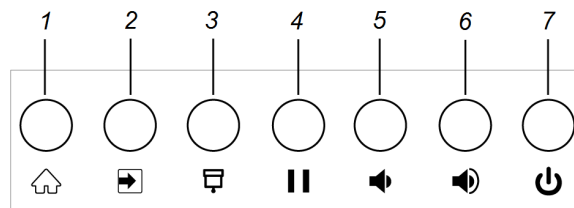

No.	Name	Procedure
1	Home	Press to return to the iQ Home screen (see <i>Using the Home button</i> above).
2	Input select	Press to switch input source (see <i>Viewing a connected computer's input</i> on page xxxiii).
3	Screen shade	Press to hide screen contents behind a screen shade (see <i>Freezing or hiding the screen</i> on page xxiii).
4	Freeze	Press to freeze and unfreeze the screen (see <i>Freezing the screen</i> on page xxiii).

No.	Name	Procedure
5	Volume decrease	Press to turn down the volume (see <i>Adjusting the volume</i> on page xxiii).
6	Volume increase	Press to turn up the volume (see <i>Adjusting the volume</i> on page xxiii).
7	Power	Press to wake the display (see <i>Waking up the display and putting it back to sleep</i> on page xv). Press again to enter Sleep mode (see <i>Waking up the display and putting it back to sleep</i> on page xv).

Using the remote control

The display comes with one of two infrared remote control models. These models are similar, except one has a button screen sharing button.

Use the infrared remote control to turn the display on or off, change the input source, change the volume, access the display's iQ apps, and more. You can also use the remote control to open the on-screen menus and change the display's settings.

IMPORTANT

- Do not subject the remote control to strong shock.
- Keep the remote control away from liquids. If it gets wet, wipe it dry immediately.
- Do not expose the remote control to heat or steam.
- Do not open any part of the remote control other than the battery compartment.

The image and table below list the remote control's functions.

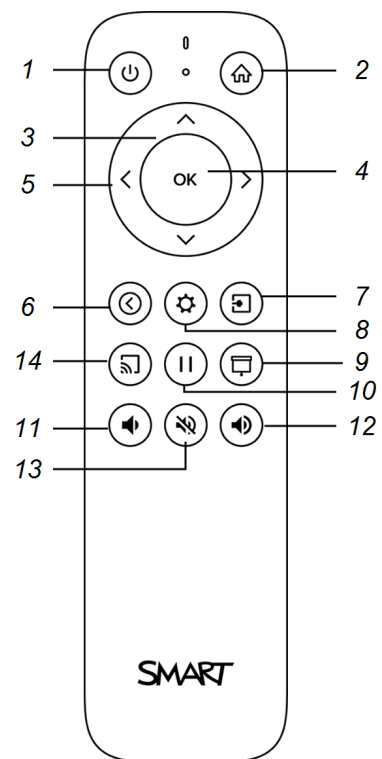
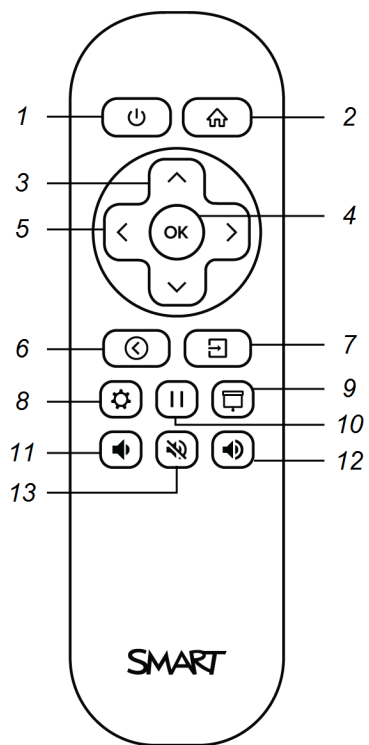

No.	Name	Procedure
1	Power	<ul style="list-style-type: none">Press to enter or exit Standby mode (see <i>Waking up the display and putting it back to sleep</i> on page xv). <hr/> <p>NOTE</p> <p>Touch is not available right after waking up the display or turning it on. Wait a few seconds and then the display will respond to touch.</p> <ul style="list-style-type: none">Press and hold for four seconds to turn off the display.
2	Home	Open the iQ Home screen (see <i>Using the Home button</i> on page xvi).
3	Up and down buttons	Select a menu option in the settings.
4	OK	Select menu option in the settings.
5	Left and right buttons	Change the value of the selected setting.
6	Back	Go one step back in the navigation history.
7	Input	Switch input sources (see <i>Viewing a connected computer's input</i> on page xxxiii).
8	Settings	Open display settings.
9	Screen shade	Hide screen contents behind a screen shade (see <i>Showing and hiding the screen shade</i> on page xxiv).
10	Freeze frame	Freeze and unfreeze the screen (see page xxiii).
11	Volume increase	Increase the volume (see <i>Adjusting the volume</i> on page xxiii).
12	Volume decrease	Decrease the volume (see <i>Adjusting the volume</i> on page xxiii).
13	Volume mute	Mute the volume (see <i>Adjusting the volume</i> on page xxiii).
14	Share screen	Open the Screen Share app (see Sharing your device's screen to the display).
		<hr/> <p>NOTE</p> <p>This button is not available on all remote control models.</p>

Using touch

You can do everything on the display that you can do at your computer—open and close applications, meet with others, create new documents or edit existing ones, visit websites, play and manipulate videos, and so on—by touching the display's surface.

You can use a variety of gestures within applications, including panning, scaling, rotating, and zooming in and out.

The display's support for up to 20 simultaneous interaction points enables you and other users to interact with objects on the screen at the same time.

NOTE

Not all gestures work in all applications. Refer to an application's documentation to learn which gestures it supports.

Pan (one finger)

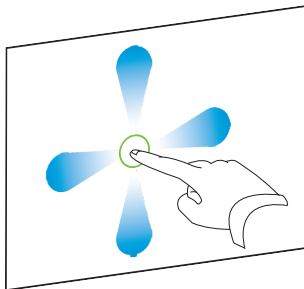

Pan (two fingers) / scroll

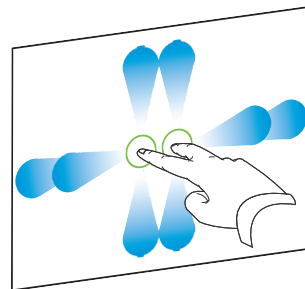

Pinch to zoom in / scale (enlarge)

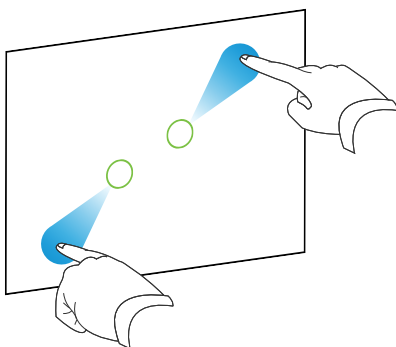

Pinch to zoom out / scale (reduce)

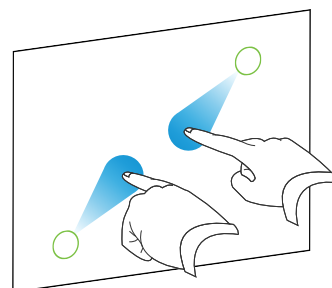

Rotate

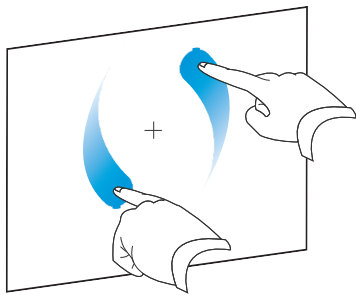

Flick

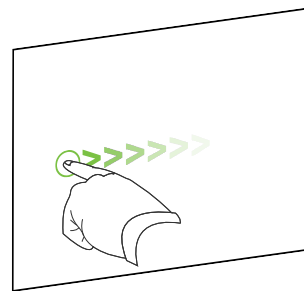

Erase with palm

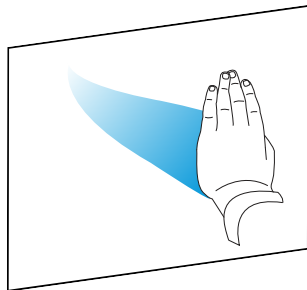

Erase with fist

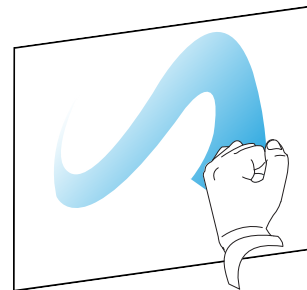

Writing, drawing, and erasing

The display includes two pens, which you can use to write or draw in digital ink. You can erase digital ink using gestures or the eraser tool in the apps.

Writing and drawing in digital ink

To write or draw in digital ink

1. Pick up one of the display's pens.
2. Use the pen to write or draw in digital ink.

Using the SMART Ink® dynamic (floating) toolbar

When you start drawing on the screen while viewing a connected computer's input, the SMART Ink® dynamic (floating) toolbar for SMART Ink appears on the screen. You can use this toolbar to temporarily change the pen's color, thickness, or other properties, you can also access SMART Ink's tools, such as screen capture, spotlight, screen shade, and so on.

To learn more about SMART Ink and its toolbar, visit the [SMART Ink support page](#). Here are a few quick links to get you started:

- [Turning SMART Ink on or off](#)
- [Opening the dynamic \(floating\) toolbar](#)
- [Closing \(hiding\) the toolbar](#)
- [Using SMART Ink presentation tools](#)



Changing a pen's default color, thickness, and other properties

You can change a pen's color, thickness, and other properties temporarily using the SMART Ink dynamic (floating) toolbar when you're viewing a connected computer's input.

To change the pen's default color, thickness, and other properties, see [Changing pen, eraser, and button settings](#).

Erasing digital ink

You can erase digital ink from the screen using your palm or fist:

To erase digital ink

Move your fist or palm over the digital ink you want to erase.



Adjusting the volume

Use the buttons on the front control panel or the remote control to increase, decrease, or mute the display's volume.



NOTE

See *There's no sound or there's a problem with the sound* on page xi if you encounter issues with the display's sound.

To turn the volume up or down

Press the **Volume Up**  or **Volume Down**  button on the front control panel or the remote control.

NOTES

- Press and hold the **Volume Down**  button to rapidly decrease the volume.
 - When you press the **Volume Up**  or **Volume Down**  button on the front control panel or the remote control, you can use the on-screen slider to adjust the volume.
-

To mute the volume

Press the remote control's **Mute**  button.

Freezing or hiding the screen

You can temporarily freeze or hide the contents on the screen using the display's freeze and screen shade features.

Freezing the screen

You can temporarily freeze the screen by pressing the **Freeze**  button on the front control panel or remote control. This is particularly useful when you want to pause a video, an animation, or other moving images.

NOTE

Freezing the screen does not pause applications that are running on the connected computer. It simply freezes the display of those applications.

TIP

You can write or draw over the screen while it is frozen (see *Writing, drawing, and erasing* on page xxi). If the iQ experience is enabled, you can then save the screenshot of your writing or drawing to the Files Library (see [Using the iQ experience Files Library](#)).

To unfreeze the screen, press the **Freeze**  button again.

Showing and hiding the screen shade

You can temporarily hide the contents of the screen behind a virtual screen shade by pressing the **Screen Shade**  button on the front control panel or remote control.

To remove the screen shade and reveal the screen contents, press the **Screen Shade**  button again.

Chapter 3

Using the iQ apps

The display comes with the following iQ apps:

- SMART Notebook Player
- Browser
- Input
- Screen Share
- kapp Whiteboard

You can use these apps along with the Files Library and Apps Library to deliver lessons in a classroom or coordinate meetings and other collaborative activities.

NOTE

Some apps, such as Screen Share, require a properly configured network connection. If you're experiencing issues with these apps, contact your IT administrator to make sure the network and display have been properly configured.

Using the Apps Library

The Apps Library contains the Browser, SMART Notebook Player, and kapp Whiteboard apps. You can also add apps from the web and SMART's app store or install third-party apps.

NOTE

SMART Notebook Player is available on education models only.

To open the Apps Library

From the Home screen, tap **Apps Library** .

To learn how to use the other features of Apps Library, see [Adding and managing apps in the iQ experience](#).

Using the Files Library

The Files Library contains kapp Whiteboard sessions, whiteboards, SMART Notebook files that have been shared with the display, PDFs, and screenshots. If a USB drive is connected to the display, the files on the USB drive are also available in the Files Library. Although these files can be viewed on the display, they are not saved on the display.

NOTE

SMART Notebook Player is available on education models only.

To open Files Library

From the Home screen, tap **Files Library** .

To learn how to use the other features of Files Library, see [Using the iQ experience Files Library](#).

Using kapp Whiteboard

For Pro models only

Use the kapp Whiteboard to write and erase notes on the display just as you do on a traditional dry erase board. You can also save your notes for later and share them using the SMART kapp® app. The kapp Whiteboard app is the default whiteboard for enterprise models.

To learn how to write, draw, and erase in kapp Whiteboard, see *Writing, drawing, and erasing* on page xxi.

To learn how to use the other features of kapp Whiteboard, see [Using the kapp Whiteboard](#).

Using SMART Notebook Player

For education models only

Use SMART Notebook Player to open, view, and interact with SMART Notebook software files. Notebook Player makes it easy to present SMART Notebook files and play SMART lab™ activities on the display. SMART Notebook Player is also the default whiteboard for education models.

You can install the Notebook Player app on your iOS and Android devices to view and control SMART Notebook files from the device.

To learn more about SMART Notebook Player, see [Using the Player app to deliver lessons](#).

Using Browser

You can use Browser to view web sites on the display.

To learn more about Browser, see [Browsing the internet on your display](#).

Using Screen Share

You can share the screens from computers and mobile devices on the display wirelessly using Screen Share.

Screen Share supports:

- Chromebook™ laptops, using the Chrome™ browser
- Windows computers, using Miracast¹, Chrome browser, or AirParrot
- Mac computers and iOS devices, using AirPlay
- Android™ devices, using Cast Screen

You can also download the SMART Screen Share app for Chromebooks, Windows computers, Mac computers, iOS devices, and Android devices.

To learn how to use the other features of Screen Share, see [Sharing your device's screen to the display](#).

Using Input

You can use the connectors the display to connect a room computer, guest laptops, and other input sources.

To learn how to connect computers to the display and view their video output, see [Viewing a connected computer's screen](#).

Using screenshots

When using the Browser or Screen Share apps, you can write or draw on a screenshot and save it to the Files Library.

¹Windows 10 operating system only

To learn more about screenshots, see [Writing and drawing over content and saving as screenshots in the iQ experience](#).

Installing third-party apps

You can install third-party apps from the Google Play Store using SMART Remote Management.

To learn more about installing third-party apps, see [Adding and managing apps in the iQ experience](#).

Cleaning up the display

After you've finished using the display, tap **Clean Up**  on the Home screen to clean up the display for the next user.

- For education models:
 - Saves the whiteboard to the Files Library
 - Saves the SMART Notebook file to the Files Library
 - Erases the whiteboard
- For enterprise models, saves the kapp Whiteboard to the Files Library (if saving to the Library is enabled in Settings)
- Resets Browser (clears the browser history, cache, cookies and closes all open tabs, and opens a new tab)
- Removes all tiles under Recent
- Closes all applications, including third-party apps.

To learn more, see [About the iQ experience and navigating the Home screen](#).

Chapter 4

Connecting computers and other devices

Installing and using SMART software	xxx
Downloading and installing SMART software	xxxi
Using SMART software	xxxii
Connecting room computers and guest laptops	xxxii
Viewing a connected computer's input	xxxiii
Setting a connected computer's resolution and refresh rate	xxxiii
Connecting USB drives, peripherals, and other devices	xxxiv
Troubleshooting connected computers	xxxv
Connecting a SMART OPS PC module	xxxv
Viewing the OPS PC module input	xxxv
Connecting external displays	xxxv
Connecting USB drives, peripherals, and other devices	xxxvi

WARNING

Ensure that any cables that cross the floor to the display are properly bundled and marked to avoid a trip hazard.

Installing and using SMART software

The display comes with the following software, which you can install on connected computers:

Software	Description	Notes
SMART Learning Suite	A suite of desktop and online software that combines lesson delivery, activities, assessments, and collaborative workspaces. Includes SMART Notebook software and SMART Learning Suite Online.	Education models only. SMART Notebook basic version also available.
SMART Meeting Pro	Software that enables you to capture ideas in a virtually unlimited interactive workspace.	Pro models only.

Software	Description	Notes
SMART Product Drivers	Software that enables the computer to detect input from the display.	Included with SMART Learning Suite
SMART Ink	Software that enables you to write and draw in digital ink over applications, files, folders, websites, and any other open window.	Included with SMART Learning Suite

TIP

You can purchase additional licenses or subscriptions to SMART software to install on other computers.

The following software is also available but sold separately:

Software	Description	Licensing details
SMART TeamWorks room edition	Software that simplifies meetings and facilitates deeper, more natural interaction with on-site and remote participants.	1-year subscription ¹
SMART Remote Management	Cloud-based mobile device management software for remotely maintaining, supporting, controlling, and securing the display and your other devices	3-year subscription ²

Contact your authorized SMART reseller (smarttech.com/where) for information about purchasing SMART software.

Downloading and installing SMART software

You can download SMART software from smarttech.com/downloads and install it following the instructions in [Installing and maintaining SMART Notebook](#), [Downloading and installing SMART TeamWorks](#), or [Installing and maintaining SMART Meeting Pro](#).

¹Pro models only.

²Subscription terms may vary in some regions.

Using SMART software

For information about using SMART software, see the following pages in the Support section of the SMART website:

- [SMART Notebook](#)
- [SMART Learning Suite Online](#)
- [SMART Learning Suite](#)
- [SMART TeamWorks](#)
- [SMART Meeting Pro](#)
- [SMART Product Drivers](#)
- [SMART Ink](#)
- [SMART Remote Management](#)

Connecting room computers and guest laptops

You can connect room computers and guest laptops to the display and view and interact with their inputs.

Side and bottom connector panel

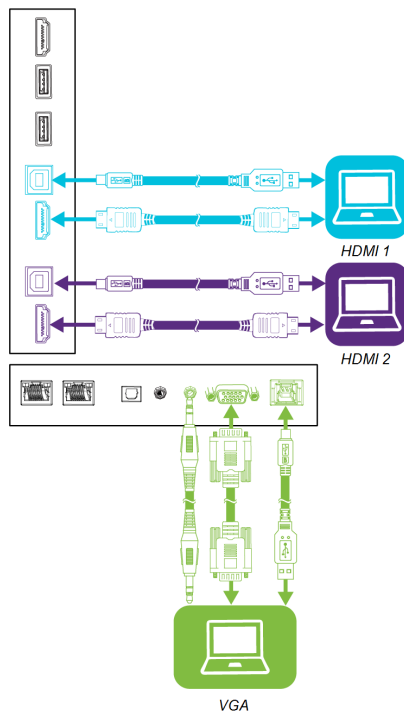

Front connector panel

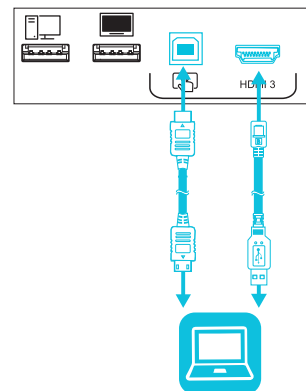

NOTES

- Install SMART software on any computers you connect to the display (see *Installing and using SMART software* on page xxx).
- Your organization's installers might have connected cables to the display and run the cables behind a wall or under the floor to a desk or table where you can place your computer.

Viewing a connected computer's input

To view a connected computer's input

1. Connect the computer to the display.
2. Press the **Input**  button on the front control panel or the remote control.

The display shows thumbnails of the devices that are connected to the display's inputs:

NOTE

A thumbnail with **Touch enabled**  indicates a USB cable is connected between the display and device and touch is available.

- A gray thumbnail indicates no device is connected to an input.
 - A black thumbnail indicates a device is connected to an input but is in Standby mode.
 - A thumbnail showing a preview screen indicates an active device is connected to an input.
3. Tap the computer's thumbnail.

Setting a connected computer's resolution and refresh rate

The following table presents the recommend resolutions and refresh rates for the display's HDMI 1, HDMI 2, and HDMI 3 input sources:

Resolution	Input source aspect ratio	Mode	Refresh rate
3840 × 2160	16:9	UHD / 2160p	59.94 Hz / 60 Hz 50 Hz 29.97 Hz / 30 Hz 25 Hz 23.98 Hz / 24 Hz

Resolution	Input source aspect ratio	Mode	Refresh rate
1920 × 1080	16:9	FHD / 1080p	59.94 Hz / 60 Hz 50 Hz 29.97 Hz / 30 Hz 25 Hz 23.98 Hz / 24 Hz
1360 × 768	16:9	HD	60.015 Hz
1366 × 768	16:9	HD	60.015 Hz
1280 × 720	16:9	HD / 720p	59.94 Hz / 60 Hz 50 Hz 29.97 Hz / 30 Hz 25 Hz 23.98 Hz / 24 Hz
720 × 480	16:9	480p (DVD Player)	60 Hz

The following table presents the recommend resolutions and refresh rates for the display's VGA input source:

Resolution	Input source aspect ratio	Mode	Refresh rate
1920 × 1080	16:9	[N/A]	60.000 Hz
1600 × 1200	4:3	[N/A]	60.000 Hz
1360 × 768	16:9	[N/A]	60.015 Hz
1280 × 1024	5:4	SXGA 60	60.020 Hz
1024 × 768	4:3	XGA 60 XGA 70 XGA 75	60.004 Hz 70.069 Hz 75.029 Hz
800 × 600	4:3	SVGA 60 SVGA 72 SVGA 75	60.317 Hz 72.188 Hz 75.000 Hz
640 × 480	4:3	VGA 60	59.940 Hz

If possible, set any connected computers to these resolutions and refresh rates. See the connected computers' operating system documentation for instructions.

Connecting USB drives, peripherals, and other devices

You can use USB drives, peripherals, and other devices with a computer connected to the display using the USB receptacles on the display.

For more information, see *Connecting USB drives, peripherals, and other devices* on the next page.

Troubleshooting connected computers

For troubleshooting information for connected computers, see *Chapter 5: Troubleshooting* on page xxxviii.

Connecting a SMART OPS PC module

If your organization has purchased a SMART OPS PC module, you or your organization's installers can install the OPS PC module in the display's accessory slot following the OPS PC module's installation instructions (smarttech.com/kb/171544). You can then view the OPS PC module's input on the display.

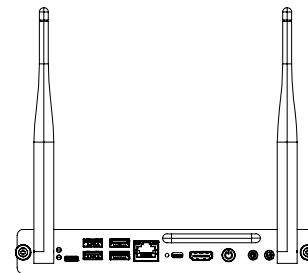

For more information about the PCM8 series of SMART OPS PC modules, see *SMART OPS PC module* on page xiii.

CAUTION

Do not install the OPS PC module or remove it from the accessory slot while the display is turned on. Ensure the power switch on the back of the display beside the AC power inlet is in the OFF (O) position.

TIP

You can install the SMART software that is included with the display on the OPS PC. For more information on installing software, see *Installing and using SMART software* on page xxx.

Viewing the OPS PC module input

To view the OPS PC module input

1. Press the **Input**  button on the front control panel or the remote control.

The input selection menu appears.

2. Tap the OPS PC module input.

Connecting external displays

You can connect an external display to duplicate or extend the OPS PC module's desktop.

For more information, see the *SMART Board MX (V2) and MX (V2) Pro series interactive displays installation and maintenance guide* (smarttech.com/kb/171555).

Connecting USB drives, peripherals, and other devices

The display includes the following USB Type A receptacles. You can connect USB drives, peripherals (such as keyboards), and other devices to these connectors and use the devices with the iQ experience, connected computers, and devices installed in the accessory slot (such as the SMART PCM8 series OPS PC).

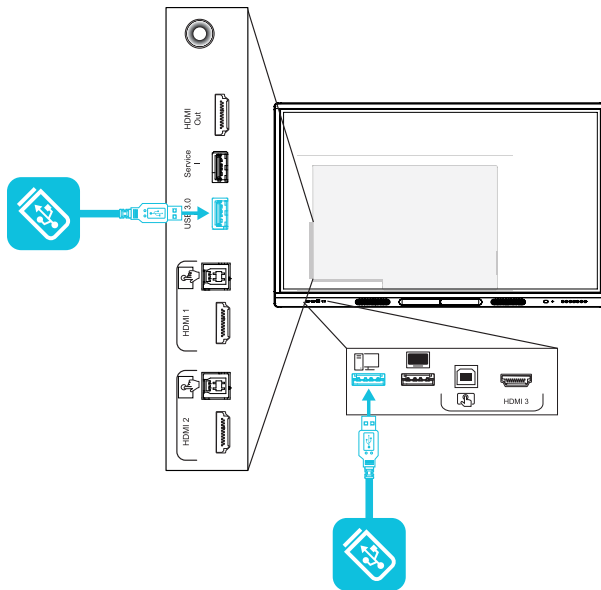

The following table shows which USB 3.0 Type-A receptacles you can use with each input source and the supported USB speed:

Input source	USB 3.0 Type-A receptacle on the side connector panel	USB 2.0 Type-A receptacle on the front connector panel
iQ	✓ (SuperSpeed)	✓ (Hi-Speed)
HDMI 1	✓ (SuperSpeed)	✓ (Hi-Speed)
HDMI 2	✓ (SuperSpeed)	✓ (Hi-Speed)
HDMI 3	✓ (SuperSpeed)	✓ (Hi-Speed)
VGA	✓ (SuperSpeed)	✓ (Hi-Speed)
Accessory slot	✓ (SuperSpeed)	✓ (Hi-Speed)
OPS PC	✓ (SuperSpeed)	✓ (Hi-Speed)

NOTE

If a SMART OPS PC module is installed in the accessory slot, you can connect USB drives, peripherals, and other devices to the USB 2.0 Type-A, USB 3.0 Type-B, and USB Type-C receptacles on the OPS PC module to access those devices from the OPS PC module input.

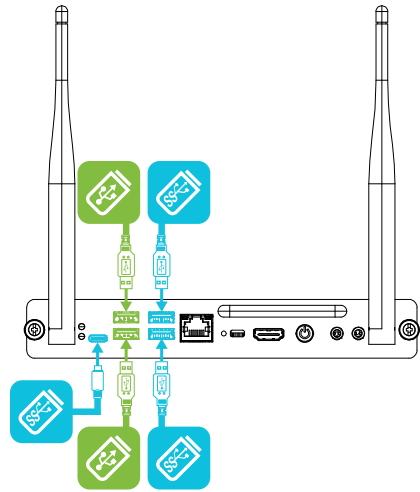

Chapter 5

Troubleshooting

The display isn't turning on	xxxviii
The screen is blank or there's a problem with the image on the screen	xxxix
There's no sound or there's a problem with the sound	xl
Touch isn't working as expected	xli
The pens and erasers aren't working as expected	xlii
iQ apps aren't working as expected	xlii
SMART software on connected computers isn't working as expected	xliii
The SMART PCM8 OPS PC isn't working as expected	xliii
Contacting your reseller for additional support	xliv

This section explains how to resolve a variety of common issues with the display and SMART PCM8 OPS PC (if installed). If your specific symptoms aren't covered below or the solutions to the symptoms don't work, refer to the SMART knowledge base for additional troubleshooting information

community.smarttech.com/s/topic/0TO0P000000Xt5yWAC/mx-series

The display isn't turning on



Symptom	Troubleshooting steps
The power light isn't lit.	<ul style="list-style-type: none">Make sure the power cable is securely fastened to the power outlet and the display. <hr/> <p>NOTE</p> <p>If the power cable is connected to a power bar, make sure the power bar is securely fastened to the power outlet and turned on.</p> <ul style="list-style-type: none">Make sure the switch beside the AC power inlet is in the ON (I) position.Make sure the power outlet is working by testing it with a different device.Make sure the power cable is working by testing it with a different device.
The power light is lit, but the screen is blank.	<ul style="list-style-type: none">Press the Power button on the front of the display or on the remote control.If the power status light is green, press Home button  on the front control panel or remote control, or switch to a different input source.Restart the display.Determine if the problem is with the video.

The screen is blank or there's a problem with the image on the screen

NOTE

If the issue occurs on the Home screen, the issue may be with the display. See *Contacting your reseller for additional support* on page xlv.

If the issue doesn't occur on the Home screen, examine the connected computers or devices.

Symptom	Troubleshooting steps
The screen is blank.	<ul style="list-style-type: none">• Make sure the screen is working by pressing the Home button  on the front control panel or the remote control to open the Home screen.• Make sure any connected computers are on and not in Sleep mode.• Restart the display and any connected computers.• Replace the video cables connecting any computers to the display to determine if the issue is with the cables.
A computer is connected to the display, but only a connection message appears on the screen.	<ul style="list-style-type: none">• Make sure the computer is connected to the currently selected input.• If the currently selected input is a computer, make sure the computer is not in Sleep mode.
The image on the screen is distorted. OR There are lines, snow or, other visual noise on the screen. OR The image is flickering or flashing. OR The image is dim.	<ul style="list-style-type: none">• Press the Home button  on the front control panel or the remote control to open the Home screen. If it appears correctly, the issue is with the video input.• Switch to a different input and then back to the first input.• Make sure any connected computers are on and not in Sleep mode.• Restart the display and any connected computers.• Set any connected computers' resolution and refresh rate to values that the display supports. <i>See Setting a connected computer's resolution and refresh rate on page xxxiii.</i>• Replace the video cables that connect any computers to the display to determine if the issue is with the cables.
There are bright spots on the screen.	<ul style="list-style-type: none">• Press the Home button  on the front control panel or the remote control to open the Home screen. If it appears correctly, the issue is with the video input.• Take a photograph of the screen and send it to SMART support. If SMART support determines that the issue is with the screen and the display is under warranty, you may be eligible for a replacement.
Colors don't appear correctly.	<ul style="list-style-type: none">• Be aware that if two or more displays are mounted side-by-side, there could be minor differences in colors across the displays. This issue is not unique to SMART products.• If the screen is completely lacking one color on the screen or the color problems occur on the Home screen, see <i>Contacting your reseller for additional support</i> on page xlv.• If you're using a VGA video input, use a different cable or connect a different source to see if the issue is with the cable or input source.

Symptom	Troubleshooting steps
The image is cut off or shifted to the left or right.	<ul style="list-style-type: none"> Adjust any connected computers' video settings, particularly zoom, crop, and underscan. See the computer's operating system documentation. If any connected computers' desktops are entirely black, change them to dark gray or a different color. If any connected computers' desktops are extended across multiple screens, duplicate the desktops across the screens or set the display as the only screen.
The image doesn't fill the entire screen.	<ul style="list-style-type: none"> Adjust any connected computers' video settings, particularly overscan. See the computer's operating system documentation. Make sure the connected computer's video connector is configured to output a supported video signal. See No video display output from a laptop.
A persistent image appears on the display.	See Image persistence or burn in on LCD displays .

There's no sound or there's a problem with the sound

Symptom	Troubleshooting steps
There's no sound. OR There is sound, but the volume is low. OR The sound is distorted or muffled.	<ul style="list-style-type: none"> If you're using an external audio system, make sure it is turned on. Make sure the cables connecting the display to the computer are securely fastened. <hr/> <p>NOTES</p> <ul style="list-style-type: none"> The display's stereo 3.5 mm in connector works with the VGA input only. Connecting an audio cable to the display's stereo 3.5 mm out connector disables the internal speakers. If you're using the display's S/PDIF out connector to connect a sound bar or receiver for external speakers, see the <i>SMART Board MX (V2) and MX (V2) Pro series interactive displays installation and maintenance guide</i> (smarttech.com/kb/171555). <hr/> <ul style="list-style-type: none"> If you're using the display's stereo 3.5 mm out connector, adjust the volume on the display and the connected computer and make sure neither are muted. If you're using the display's S/PDIF out connector, adjust the volume on the external audio system and make sure the audio system isn't muted. Adjust the display's audio settings. If you're using the integrated speakers, set the volume for the computer and any running applications to 80%, and then adjust the display's volume. <p>OR</p> <p>If you're using an external audio system, set the volume for the computer, any running applications and the display to 80%, and then adjust the external audio system's volume.</p>
There is a whine or buzzing sound coming from the back of the display.	<ul style="list-style-type: none"> Be aware that these sounds are normal. All displays emit some electrical noise. Such sounds may be more noticeable with some displays than with others. However, if you hear noise from the front of the display, further investigation is required. Connect all devices to the same power outlet or power bar.

Touch isn't working as expected

Symptom	Troubleshooting steps
The display doesn't respond to touch.	<ul style="list-style-type: none">• Touch is not available right after waking up the display or turning it on. Wait a few seconds and then the display will respond to touch.• Make sure SMART Product Drivers 12.14 or later are installed and running on any connected computers.• Make sure the USB cable between the display and the computer doesn't exceed the supported maximum cable length. See <i>Connecting room computers and guest laptops</i> on page xxxii.• Make sure any connected computers have detected the display's USB connection and SMART Product Drivers 12.14 or later is installed.• On Windows computers, open Device Manager and make sure there is no red X or yellow explanation mark (!) over the display's icon.• On Mac computers, open System Information and make sure there are no error messages in the display's row.• For Mac computers with macOS Mojave, see How to resolve issues with installing and using SMART Learning Suite software on macOS Mojave.
The display responds to touch intermittently. OR When you touch the screen, the pointer doesn't appear in the correct place.	<ul style="list-style-type: none">• Make sure jewelry or clothing doesn't touch the board when erasing the ink.• When erasing, make sure the palm or fist is flat on the screen.• Touch is not available right after waking up the display or turning it on. Wait a few seconds and then the display will respond to touch.• Restart the display.• Confirm with the installers that the computer is connected to the display with only a single cable.• Make sure SMART Product Drivers and SMART Ink are installed and running on any connected computers. Orient the display. See Orienting your SMART interactive product using SMART Product Drivers 12.• Remove infrared sources, such as incandescent or arc lights, desk lamps, and infrared audio devices, or move the display to another location in the room.• Remove any USB extenders to help isolate the USB cable.• Update the firmware.

The pens and erasers aren't working as expected

Symptom	Troubleshooting steps
The display doesn't respond to touch or writing with a pen.	<ul style="list-style-type: none">• Touch is not available right after waking up the display or turning it on. Wait a few seconds and then the display will respond to touch.• Make sure any connected computers have detected the display's USB connection and SMART Product Drivers 12.14 or later is installed.• On Windows computers, open Device Manager and make sure there is no red X or yellow explanation mark (!) over the display's icon.• On Mac computers, open System Information and make sure there are no error messages in the display's row.• Reinstall or update SMART Product Drivers and SMART Ink on any connected computers.• Make sure SMART Product Drivers is version 12.14 or later.
The display responds to touch but not to writing with a pen.	<ul style="list-style-type: none">• Reinstall or update SMART Product Drivers and SMART Ink on any connected computers.
When you write on the screen, the ink appears in the wrong place. OR Writing is intermittent. OR Ink disappears as you write.	<ul style="list-style-type: none">• Make sure you are using a SMART Board MX (V2) interactive display pen.• Restart the display.• Confirm with the installers that the computer is connected to the display with only a single cable.• Make sure SMART Product Drivers and SMART Ink are installed and running on any connected computers.• Make sure the pen nib is not worn. Replacement pens are available from the Store for SMART Parts (see smarttech.com/Support/PartsStore).• Make sure SMART Product Drivers and SMART Ink are installed and running on any connected computers. Orient the display. See Orienting your SMART interactive product using SMART Product Drivers 12.• Remove infrared sources, such as incandescent or arc lights, desk lamps, and infrared audio devices, or move the display to another location in the room.• Update the firmware.
You can't write or draw in Microsoft Office.	<ul style="list-style-type: none">• Make sure Microsoft Office 2013 or later is installed.• Reinstall or update SMART Product Drivers and SMART Ink.

iQ apps aren't working as expected

Symptom	Troubleshooting steps
iQ apps aren't working as expected.	See Troubleshooting the iQ experience .

SMART software on connected computers isn't working as expected

Symptom	Troubleshooting steps
SMART Notebook software isn't working as expected.	See Troubleshooting SMART Notebook .
SMART Learning Suite Online isn't working as expected.	See Troubleshooting common issues in SMART Learning Suite Online .
SMART TeamWorks software isn't working as expected.	See Troubleshooting SMART TeamWorks .
SMART Meeting Pro software isn't working as expected.	See Basic troubleshooting for SMART Meeting Pro .
SMART Ink isn't working as expected.	See Troubleshooting SMART Ink .
SMART Product Drivers isn't working as expected.	See Troubleshooting SMART Product Drivers .

The SMART PCM8 OPS PC isn't working as expected

Symptom	Troubleshooting steps
The on-screen keyboard isn't visible.	<ul style="list-style-type: none">• Enable the on-screen keyboard:<ol style="list-style-type: none">a. Select Start > Settings. The <i>Settings</i> window appears.b. Tap Ease of Access, and then tap Keyboard.c. Enable Use the On-Screen Keyboard.For more information, see Use the On-Screen Keyboard (OSK) to type.• Enable tablet mode:<p>Tap the notification icon  in the bottom-right corner of the screen and then select Tablet mode.</p>For more information, see Turn tablet mode on or off.
Windows 10 or the OPS PC module is unresponsive.	<ul style="list-style-type: none">• Restart the OPS PC module:<ol style="list-style-type: none">a. Press and hold the power button on the OPS PC module.b. Wait two minutes.c. Press the power button to turn on the OPS PC module.• If restarting the OPS PC module doesn't resolve the issue, contact SMART support.
There is an issue with Bluetooth.	See Fix Bluetooth problems in Windows 10: FAQ .
There is an issue with the network connection.	See Fix network connection issues in Windows .

Contacting your reseller for additional support

If an issue you're experiencing with the display persists or isn't covered in this chapter or the knowledge base, contact your authorized SMART reseller (smarttech.com/where) for support.

Your reseller might ask you for the display's serial number. The serial number is on a label located on the left side of the display (pictured).

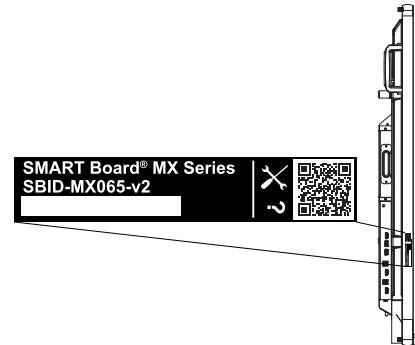

TIPS

- Scan the QR code on the label to view the SMART Board MX (V2) or MX (V2) Pro series interactive display support pages on the SMART website.
 - You can also find the serial number in the iQ settings. Refer to the *SMART Board MX (V2) and MX (V2) Pro series interactive displays installation and maintenance guide* (smarttech.com/kb/171555) for more information.
-

SMART TECHNOLOGIES

smarttech.com/support

smarttech.com/contactsupport

smarttech.com/kb/171554