

# SMART Board MX (V2) series interactive displays

## INSTALLATION AND MAINTENANCE

SBID-MX265-V2 | SBID-MX275-V2 | SBID-MX286-V2

Was this document helpful?  
[smarttech.com/docfeedback/171555](https://smarttech.com/docfeedback/171555)

**SMART**<sup>®</sup>



## Learn more

This guide and other resources for SMART Board MX (V2) series interactive displays are available in the Support section of the SMART website ([smarttech.com/support](http://smarttech.com/support)). Scan this QR code to view these resources on your mobile device.

### **Trademark notice**

SMART Board, smarttech, the SMART logo and all SMART taglines are trademarks or registered trademarks of SMART Technologies ULC in the U.S. and/or other countries. All third-party product and company names may be trademarks of their respective owners.

### **Copyright notice**

© 2019 SMART Technologies ULC. All rights reserved. No part of this publication may be reproduced, transmitted, transcribed, stored in a retrieval system or translated into any language in any form by any means without the prior written consent of SMART Technologies ULC. Information in this manual is subject to change without notice and does not represent a commitment on the part of SMART.

This product and/or use thereof is covered by one or more of the following U.S. patents:

[www.smarttech.com/patents](http://www.smarttech.com/patents)

October 15, 2019

# Important information

---

## **IMPORTANT**

There are critical software updates for the display that you need to install to ensure the display is fully functional and provides the best experience. Connect the display to a wired or wireless network with Internet access to automatically download and apply these updates as well as future updates.

---

## **WARNING**

- Failure to follow the installation instructions included with the display could result in injury and product damage which may not be covered by the warranty.
  - Do not open or disassemble the display. You risk electrical shock from the high voltage inside the casing. Opening the casing also voids the warranty.
  - Do not stand (or allow children to stand) on a chair to touch the surface of the display. Rather, mount the product at the appropriate height.
  - To reduce the risk of fire or electric shock, do not expose the display to rain or moisture.
  - If the display requires replacement parts, make sure the service technician uses replacement parts specified by SMART Technologies or parts with the same characteristics as the original.
  - Ensure that any cables that cross the floor to the display are properly bundled and marked to avoid a trip hazard.
  - Do not insert objects inside the cabinet ventilation holes, because they could touch dangerous voltage points and cause electric shock, fire or product damage which may not be covered by the warranty.
  - Do not place heavy objects on the power cable. Damage to the cable could cause shock, fire or product damage which may not be covered by the warranty.
  - Use only extension cords and outlets that can fully accommodate the display's polarized plug.
  - Use the power cable provided with the display. If a power cable is not supplied, contact your supplier. Use only power cables that match the AC voltage of the power outlet and that comply with your country's safety standards.
-

## IMPORTANT INFORMATION

---

- If the glass is broken, do not touch the liquid crystal. To prevent injury, handle glass fragments with care when disposing of them.
  - Do not move or mount the display by connecting rope or wire to its handles. The display is heavy, and failure of the rope, wire or handle could lead to injury.
  - Use only VESA®-approved mounts if using a mount other than the one supplied with the display..
  - Disconnect all of the display's power cables from the wall outlet and seek assistance from qualified service personnel if any of the following occur:
    - The power cable or plug is damaged
    - Liquid is spilled into the display
    - Objects fall into the display
    - The display is dropped
    - Structural damage, such as cracking, occurs
    - The display behaves unexpectedly when you follow operating instructions
  - Before inserting or removing an OPS from the display, turn off the display using the switch at the back of the display. See [Open Pluggable Slot computer \(OPS\) disclaimer](#) for more information.
- 

### CAUTION

- Turn off the display before cleaning its screen. Otherwise, you may scramble the desktop icons or inadvertently activate applications when you wipe the screen.
- Avoid setting up and using the display in an area with excessive levels of dust, humidity, and smoke.
- Make sure an electrical socket is near the display and remains easily accessible during use.
- The display should be used only with European TN and TT power distribution systems.

It is not suitable for older, IT-type power distribution systems found in some European countries. This system (IT-type) is widely used isolated from earth, in some installations in France, with impedance to earth, at 230/400V, and in Norway, with voltage limiter, neutral not distributed, at 230V line-to-line.

Contact qualified personnel if you're uncertain of the type of power system available where you're installing the display.

---

## IMPORTANT INFORMATION

- The accessory slot's maximum available power is 60 W. The slot is not a limited power source. To reduce the risk of fire, make sure that accessories connecting to the slot satisfy the fire enclosure requirements of IEC 60950-1 or IEC 62368-1.
- You must connect the USB cable that came with the display to a computer that has a USB compliant interface and that bears the USB logo. In addition, the USB source computer must be compliant with IEC 60950-1 and/or IEC 62368-1. The source computer must be CE marked and carry safety certification marks for Canada and USA. This is for operating safety and to avoid damage to the display.

### IMPORTANT

- The following are the normal operating power requirements for the display, including speakers:

Model	Power requirements
SBID-MX265-V2	100V to 240V AC, 50 Hz to 60 Hz, 109 W max
SBID-MX275-V2	100V to 240V AC, 50 Hz to 60 Hz, 120 W max
SBID-MX286-V2	100V to 240V AC, 50 Hz to 60 Hz, 189 W max

- For additional requirements and other information, refer to the display's specifications (see *More information* on page 8).

## ENERGY STAR®



ENERGY STAR is the government-backed symbol for energy efficiency, providing simple, credible, and unbiased information that consumers and businesses rely on to make well-informed decisions. ENERGY STAR-certified products are the simple choice for energy efficiency, making it easy for consumers and businesses to make purchases that save them money and protect the environment. The U.S. EPA ensures that each product that earns the label is independently certified to deliver the quality, performance, and savings that users have come to expect.

As shipped, your display delivers ENERGY STAR performance and savings. However, changing some settings may increase energy consumption beyond the limits required for ENERGY STAR certification. For example, increased brightness and contrast will increase power consumption.

Please consider the environment when you choose non-ENERGY STAR settings.

# Federal Communication Commission interference statement

## FCC

### Suppliers Declaration of Conformity

#### 47 CFR § 2.1077 Compliance Information

Unique Identifier: SBID-7075, ID7075-1, ID7075-2, ID7086-1, ID7086-2

#### Responsible Party – U.S. Contact Information

SMART Technologies Inc.

2401 4th Ave., 3rd Floor

Seattle, WA 98121

[compliance@smarttech.com](mailto:compliance@smarttech.com)

This device complies with Part 15 of the FCC Rules. Operation is subject to the following two conditions:

1. This device may not cause harmful interference, and
2. this device must accept any interference received, including interference that may cause undesired operation.

---

## NOTE

This equipment has been tested and found to comply with the limits for a Class A digital device, pursuant to part 15 of the FCC Rules. These limits are designed to provide reasonable protection against harmful interference when the equipment is operated in a commercial environment. This equipment generates, uses, and can radiate radio frequency energy and, if not installed and used in accordance with the instruction manual, may cause harmful interference to radio communications. Operation of this equipment in a residential area is likely to cause harmful interference in which case the user will be required to correct the interference at his own expense.

---

## CAUTION

Any changes or modifications not expressly approved by the party responsible for compliance could void the user's authority to operate this equipment.

---

## Restriction

Operations in the 5.15-5.25GHz band are restricted to indoor usage only.

IEEE 802.11b or 802.11g operation of this product in the USA is firmware limited to channels 1 through 13.

---

## CAUTION

- i. the device for operation in the band 5150-5250 MHz is only for indoor use to reduce the potential for harmful interference to co-channel mobile satellite systems;
- ii. the maximum antenna gain permitted for devices in the bands 5250-5350 MHz and 5470-5725 MHz shall comply with the e.i.r.p. limit; and
- iii. the maximum antenna gain permitted for devices in the band 5725-5825 MHz shall comply with the e.i.r.p. limits specified for point-to-point and non point-to-point operation as appropriate.
- iv. Users should also be advised that high-power radars are allocated as primary users (i.e., priority users) of the bands 5250-5350 MHz and 5650-5850 MHz and that these radars could cause interference and/or damage to LE-LAN devices.

---

## Radiation exposure statement

This equipment complies with FCC radiation exposure limits set forth for an uncontrolled environment. This equipment should be installed and operated with minimum distance of 20 cm between the antenna of this device and all nearby persons. This transmitter must not be co-located or operated in conjunction with any other antenna or transmitter.

## IMPORTANT INFORMATION

# Innovation, Science and Economic Development Canada statement

This device complies with RSS-247 of the Innovation, Science and Economic Development Canada Rules. Operation is subject to the following two conditions:

1. This device may not cause harmful interference, and
2. this device must accept any interference received, including interference that may cause undesired operation.

### Radiation exposure statement

This equipment complies with ISED radiation exposure limits set forth for an uncontrolled environment. This equipment should be installed and operated with minimum distance of 20 cm between the antenna of this device and all nearby persons. This transmitter must not be co-located or operated in conjunction with any other antenna or transmitter.

# Innovation, Science et Développement économique Déclaration du Canada

Cet appareil est conforme à la norme ISED CNR-247 pour les appareils radio agréés. Son fonctionnement est soumis aux deux conditions suivantes:

1. le dispositif ne doit pas produire de brouillage préjudiciable, et
2. ce dispositif doit accepter tout brouillage reçu, y compris un brouillage susceptible de provoquer un fonctionnement indésirable.

---

### **AVERTISSEMENT**

- i. les dispositifs fonctionnant dans la bande 5 150-5 250 MHz sont réservés uniquement pour une utilisation à l'intérieur afin de réduire les risques de brouillage préjudiciable aux systèmes de satellites mobiles utilisant les mêmes canaux;
- ii. le gain maximal d'antenne permis pour les dispositifs utilisant les bandes 5 250-5 350 MHz et 5 470-5 725 MHz doit se conformer à la limite de p.i.r.e.;
- iii. le gain maximal d'antenne permis (pour les dispositifs utilisant la bande 5 725-5 825 MHz) doit se conformer à la limite de p.i.r.e. spécifiée pour l'exploitation point à point et non point à point, selon le cas.
- iv. De plus, les utilisateurs devraient aussi être avisés que les utilisateurs de radars de haute puissance sont désignés utilisateurs principaux (c.-à-d., qu'ils ont la priorité) pour les bandes 5 250-5 350 MHz et 5 650-5 850 MHz et que ces radars pourraient causer du brouillage et/ou des dommages aux dispositifs LAN-EL.

---

### Déclaration d'exposition aux radiations

Cet équipement est conforme aux limites d'exposition aux rayonnements ISED établies pour un environnement non contrôlé. Cet équipement doit être installé et utilisé avec un minimum de 20 cm de distance entre la source de rayonnement et votre corps. Cet émetteur ne doit pas être co-implantés ou exploités conjointement avec une autre antenne ou émetteur.

## EU declaration of conformity

Hereby SMART Technologies ULC declares that the radio equipment type Interactive displays model SBID-MX265-V2, SBID-MX275-V2, SBID-MX286-V2 are in compliance with Directive 2014/53/EU.

## IMPORTANT INFORMATION

---

### **WARNING**

Operation of this equipment in a residential environment this equipment may could cause radio interference.

---

The full text of the EU declaration of conformity is available at the following internet address: [smarttech.com/compliance](https://smarttech.com/compliance)

The frequency band and the maximum transmitted power in EU are listed below:

Transmitting Band (MHz)	Maximum Transmit Power EIRP (dBm)
2402-2483.5	19
5150-5350	23
5470-5725	23

### **Restrictions in**

AT/BE/BG/CZ/DK/EE/FR/DE/IS/IE/IT/EL/ES/CY/LV/LI/LT/LU/HU/MTNL/NO/PL/PT/RO/SI/SK/TR/FI/SE/CH/UK/HR—5150MHz-5350MHZ is for indoor use only

---

### **CAUTION: EXPOSURE TO RADIO FREQUENCY RADIATION**

This equipment complies with EU radiation exposure limits set forth for an uncontrolled environment. This equipment should be installed and operated with minimum distance 20 cm between the radiator and your body.

---



# Contents

<b>Important information</b> .....	<b>i</b>
ENERGY STAR .....	iii
Federal Communication Commission interference statement .....	iv
Innovation, Science and Economic Development Canada statement .....	v
Innovation, Science et Développement économique Déclaration du Canada .....	v
EU declaration of conformity .....	v
<b>Chapter 1: Welcome</b> .....	<b>1</b>
About this guide .....	1
About the display .....	2
Identifying your specific model .....	5
Accessories .....	6
More information .....	8
<b>Chapter 2: Installing the display</b> .....	<b>9</b>
Moving the display to the installation site .....	9
Installing the display on a wall .....	11
Installing the display on a stand .....	17
Connecting to a network .....	18
Connecting power and turning on the display for the first time .....	19
<b>Chapter 3: Connecting computers and other devices</b> .....	<b>21</b>
Installing SMART software .....	22
Connecting room computers and guest laptops .....	22
Connecting a SMART OPS PC module .....	26
Connecting other devices .....	27
Connector diagrams .....	30
<b>Chapter 4: Maintaining the display</b> .....	<b>35</b>
Turning off, turning on, and resetting the display .....	35
Cleaning and maintaining hardware .....	36
Updating system software .....	40
<b>Chapter 5: Troubleshooting</b> .....	<b>43</b>
The display isn't turning on .....	43
The screen is blank or there's a problem with the image on the screen .....	44
There's no sound or there's a problem with the sound .....	45
Touch isn't working as expected .....	46
The pens and erasers aren't working as expected .....	47

## CONTENTS

iQ apps aren't working as expected .....	47
SMART software on connected computers isn't working as expected .....	47
The SMART PCM8 OPS PC isn't working as expected .....	48
Contacting your reseller for additional support .....	48
<b>Appendix A: Adjusting iQ settings .....</b>	<b>51</b>
Network settings .....	51
Personalization .....	52
Application settings .....	52
System settings .....	54
<b>Appendix B: Managing the display using RS-232 .....</b>	<b>59</b>
Configuring the computer's serial interface settings .....	60
Power states .....	61
Commands and responses .....	61
Power state commands .....	63
Input commands .....	64
Brightness commands .....	64
Freeze commands .....	64
Screen shade commands .....	64
Volume commands .....	65
Mute commands .....	65
Firmware version commands .....	65
Serial number commands .....	65
Part number commands .....	66
Resolving issues with managing the display using RS-232 .....	66
<b>Appendix C: Hardware environmental compliance .....</b>	<b>67</b>
Waste Electrical and Electronic Equipment and Battery regulations (WEEE and Battery Directives) .....	67
Batteries .....	67
More information .....	67

## Chapter 1

# Welcome

About this guide .....	1
About the display .....	2
Touch .....	2
Writing, drawing, and erasing .....	2
iQ experience .....	3
Display .....	3
Audio .....	3
Network connectivity .....	3
Room computers and guest laptops .....	4
Accessory slot .....	4
Front control panel .....	4
Front connector panel .....	4
Ambient light sensor .....	5
Power status light .....	5
Remote control and IR sensor .....	5
Identifying your specific model .....	5
Accessories .....	6
SMART OPS PC module .....	6
SBA-100 projection audio system .....	7
SMART Audio 400 classroom amplification system .....	7
Stands .....	7
USB extenders .....	7
More information .....	8

---

This chapter introduces the SMART Board® MX (V2) series interactive displays.

## About this guide

This guide explains how to install and maintain a SMART Board MX (V2) interactive display. It includes the following information:

- How to install the display
- How to connect power and devices
- How to turn on the display for the first time and configure the iQ experience

- How to maintain the display for years of use
- How to troubleshoot issues with the display

In addition, this guide includes information on the display's settings and remote management support.

This guide is intended for those who install and maintain displays in their organizations. Other documentation and resources are available for those who use displays (see *More information* on page 8).

## About the display

The SMART Board MX (V2) interactive display with iQ is the hub of your classroom.

The display includes an extensive set of features and components:

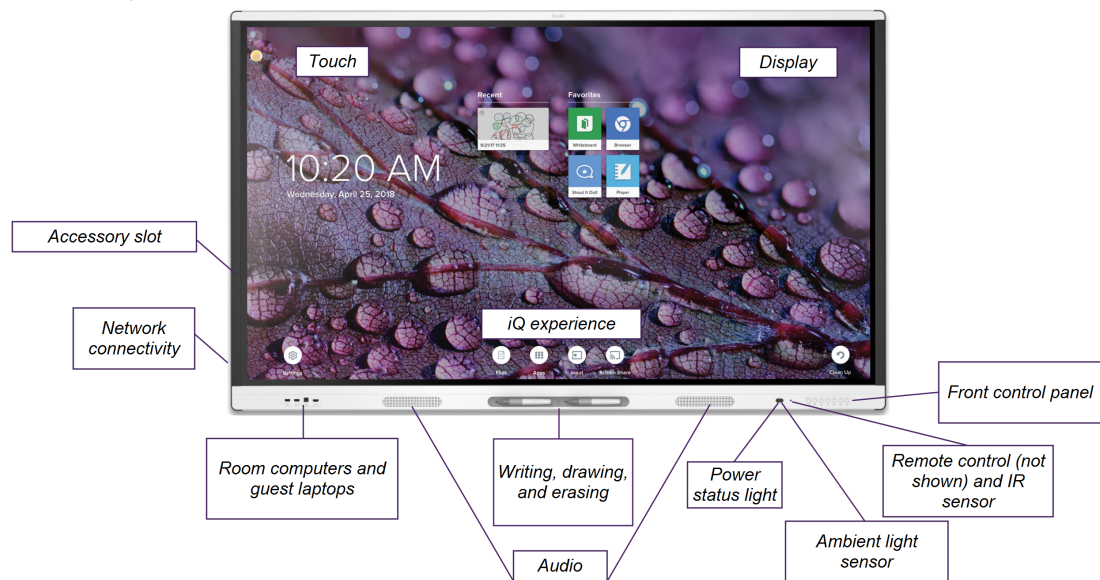

### Touch

You can do everything on the display that you can do at your computer—open and close applications, meet with others, create new documents or edit existing ones, visit websites, play and manipulate videos, and so on—by touching the display's surface.

You can use an array of gestures within applications, including panning, scaling, rotating, and zooming in and out.

### Writing, drawing, and erasing

The display comes with two pens, which you can use to write or draw on the screen.

Use your fist or palm to erase digital ink on the screen.

With Object Awareness™, the display responds automatically to the tool or object you're using, whether it's a pen, finger, or palm. The display's Simultaneous Tool Differentiation technologies allow two people to write independently and simultaneously.

## iQ experience

The display's iQ experience provides one-touch access to collaborative tools, including a whiteboard, wireless screen sharing, and a web browser. With minimal network integration, there's no need for wires, cables, or manual software and firmware updates.

Tap the **Home**  button on the display's front control panel or the remote control to open the Home screen. From the Home screen, you can open the iQ apps, switch inputs, and adjust settings.

## Display

The 4K ultra-high-definition LCD display provides optimal image clarity and wide viewing angles.

The size of the display varies by model:

Models	Size (diagonal)
SBID-MX265-V2	65"
SBID-MX275-V2	75"
SBID-MX286-V2	86"

## Audio

The display includes two 15 W integrated speakers, which are designed to provide sound at the front of a room.

---

### TIP

You might want to connect an external audio system if you're providing sound in a larger space (see *Connecting an external audio system* on page 29).

---

## Network connectivity

The display requires a network connection for downloading software and firmware updates, and a number of the iQ apps require a network connection as well.

You can connect to a network using Wi-Fi or the RJ45 LAN jack on the display:

- Wi-Fi supports both 2.4 and 5 GHz bands.
- The two RJ45 jacks allow you to connect the display and an external device, such as a computer, to an Ethernet network.

For more information, see *Connecting to a network* on page 18.

## Room computers and guest laptops

You can connect room computers and guest laptops and use the display to view and interact with them.

The display comes with SMART software that you can install on connected computers to take full advantage of the display's features while using the connected computers.

For more information, see *Chapter 3: Connecting computers and other devices* on page 21.

## Accessory slot

You can install an OPS-compatible device, such as a SMART OPC PC module, in the accessory slot. The PCM8 series of SMART OPS PC modules provides a complete Windows 10 Pro solution.

For more information on the SMART PCM8 series OPS PC, see *SMART OPS PC module* on page 6.

---

### CAUTION

The accessory slot's maximum available power is 60 W. The slot is not a limited power source. To reduce the risk of fire, make sure that accessories connecting to the slot satisfy the fire enclosure requirements of IEC 60950-1 and/or IEC 62368-1.

---

## Front control panel

The front control panel contains buttons for turning the display on and off, controlling the volume, freezing and unfreezing the screen, and showing and hiding a screen shade.

For more information about the front control panel, see the *SMART Board MX (V2) series interactive displays user guide* ([smarttech.com/kb/171554](https://smarttech.com/kb/171554)).

## Front connector panel

The front connector panel includes connectors for USB peripherals and a computer or other input source.

## Ambient light sensor

The ambient light sensor is located in the bottom-right corner of the display's frame.

The ambient light sensor detects the brightness of the room and adjusts the screen's brightness accordingly.

You can enable or disable this feature (see *Auto Brightness* on page 55).

## Power status light

The power status is located in the bottom-right corner of the display's frame.

The power status light indicates the display's status.

Power status light	Display status
Red	Standby mode
Green	Normal operating mode

## Remote control and IR sensor

You can use the remote control to turn the display on and off, adjust display settings, and so on.

The IR sensor for the remote control is located in the bottom-right corner of the display's frame.

For more information about the remote control, see the *SMART Board MX (V2) series interactive displays user guide* ([smarttech.com/kb/171554](http://smarttech.com/kb/171554)).

## Identifying your specific model

SMART offers several models of the SMART Board MX (V2) series interactive display.

For help identifying your model, see the label on the left side of the display.

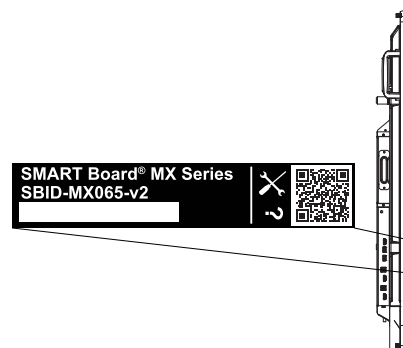

Model	Screen size (approximate)
SBID-MX265-V2	65" (165 cm)
SBID-MX275-V2	75" (190 cm)
SBID-MX286-V2	86" (218 cm)

Refer to the specifications for detailed technical information for your model, including product dimensions and weights (see *More information* on page 8).

## Accessories

Accessories for the display include:

- SMART OPC PC module
- SBA-100 projection audio system
- SMART Audio 400 classroom amplification system
- Stands
- USB extenders

---

### NOTE

For more information on these and other accessories, see [smarttech.com/accessories](http://smarttech.com/accessories).

---

### SMART OPS PC module

SMART Open Pluggable Specification (OPS) PC modules provide a hassle-free Windows® 10 Pro solution based on eighth generation Intel® Core™ processors and are designed specifically to work with a SMART display. Available in two standard configurations, all OPS PC modules in the PCM8 series are WHQL certified and fully licensed with Windows 10 Pro out of the box. Install the OPS PC module in a display's OPS slot to provide a complete 4K UHD Windows 10 solution at your fingertips, without the need for an external PC or additional cables.

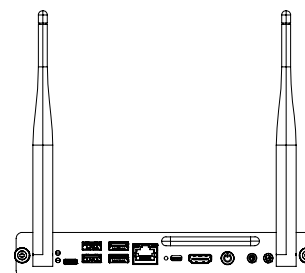

Install familiar Windows software applications, such as SMART Notebook® collaborative learning software, SMART Meeting Pro® software, and SMART TeamWorks™ software, and access the internet directly through your display's network connection. Upgrades and service for the OPS PC module can be easily performed without removing the display from its mounting.



## SBA-100 projection audio system

The SBA-100 projection audio system consists of two 14 W speakers and is intended for wall-mounted displays. You can control volume using the display's front control panel or the digital volume controls in a connected computer's operating system.

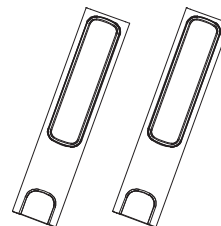

## SMART Audio 400 classroom amplification system

The SMART Audio 400 classroom amplification system provides high-quality audio amplification. The system comes with a teacher microphone and optional student microphone. Multiple speaker options are available, including wall- and ceiling-mounted speakers. The amplifier receives audio signals from the microphones and translates them into crystal-clear sound through the speakers.

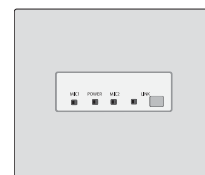

## Stands

If you want to move the display from place to place, you can install it on a SMART mobile stand. Alternatively, if you are installing the display on a wall that cannot support the display's full weight, you can install the display on a SMART floor stand.

## USB extenders

As noted in the display's specifications, there is a maximum length for USB cable connections between the display and computer.

When using USB 2.0, the cable should be no longer than 16' (5 m).

When using USB 3.0, the cable should be no longer than 9' (3 m).

Use one of the following USB extenders if you need a longer USB connection:

Extender	Specifications
USB-XT	<a href="http://smarttech.com/kb/119318">smarttech.com/kb/119318</a>
CAT5-XT-1100	<a href="http://smarttech.com/kb/170202">smarttech.com/kb/170202</a>

### NOTE

For more information on extending USB connections, see [USB cable extenders](#).

## More information

In addition to this guide, SMART provides other documents for the display in the Support section of the SMART website ([smarttech.com/support](https://smarttech.com/support)). Scan the QR code on the cover of this guide to view links to SMART Board MX (V2) series interactive display documents and other support resources.

## Chapter 2

# Installing the display

Moving the display to the installation site .....	9
Using transportation aides .....	10
Accommodating doorways, hallways and elevators .....	10
Dealing with cracked, chipped or shattered glass .....	11
Saving the original packaging .....	11
Installing the display on a wall .....	11
Choosing a location .....	12
Choosing a height .....	14
Assessing the wall .....	14
Selecting mounting hardware .....	14
Selecting a wall mount .....	14
Mounting the display .....	15
Installing the display on a stand .....	17
Using SMART mobile stands .....	18
Using a third-party stand .....	18
Connecting to a network .....	18
Connecting power and turning on the display for the first time .....	19

---

SMART recommends that only trained installers install the display.

This chapter is for installers. Installers should read this information along with the installation instructions included with the display before they install the display.

---

### **WARNING**

Improper installation of the display can result in injury and product damage.

---

## Moving the display to the installation site

After your organization receives the display, you need to move it to the place where you plan to install it.

On occasion, you might also need to move the display to another location after initially installing it.

---

**!** **IMPORTANT**

- Move the display at your own risk. SMART cannot accept liability for damages or injury that occur during the display's transportation.
- When moving the display
  - Follow local safety regulations and standards.
  - Keep the display in its original packaging, including the pallet.
  - Move the display so that its top frame faces up.
  - Have at least two people move the display.

---

**TIP**

Display packaging may be labeled to indicate which side is the front. Look for "FRONT" on the packaging to help orient the box during transportation.

---

## Using transportation aides

You can use the following aides to move the display:

- Cart
- Furniture dolly
- Mechanical lift

## Accommodating doorways, hallways and elevators

In some situations, you might need to remove the display from its packaging to move it through narrow doorways or hallways or on to an elevator. In these situations, SMART recommends that you keep the foam pieces on the bottom corners of the display. These foam pieces protect the display if you need to set it down during transportation.

You might also need to rotate the display so that its top frame faces to the side. You can do this during transportation, but when you install the display, it must be in landscape orientation (with the top frame facing up).

## Dealing with cracked, chipped or shattered glass

The display contains safety-tempered glass. Although this glass is heat-strengthened to help withstand impacts, the glass can crack, chip or shatter if struck with enough force. (Safety glass is designed to break into small pieces rather than sharp shards if it is broken.) Temperature changes can cause a minor crack or chip to become worse, possibly causing the glass to shatter. See the knowledge base article, [Shattered glass on an interactive display](#), for information about conditions that can cause the display's glass to shatter even when it's not in use.

If the display's glass is cracked or chipped, have it professionally inspected and repaired at a SMART authorized repair center. If the display's glass shatters, carefully clean up the area and have the display repaired or replaced.

---

### CAUTION

For safety and to prevent further damage, do not continue to install or use the display if its glass is cracked, chipped or shattered.

---

## Saving the original packaging

Save the original packaging to repack the display with as much of the original packaging as possible in case you need to move the display after you initially install it. This packaging was designed to provide the best possible protection against shock and vibration.

---

### CAUTION

Move the display only in the original packaging or replacement packaging purchased from your authorized SMART reseller. Moving the display without correct packaging can lead to product damage and voids the warranty.

---

### NOTE

If the original packaging isn't available, you can purchase the same packaging directly from your authorized SMART reseller ([smarttech.com/where](http://smarttech.com/where)).

---

## Installing the display on a wall

Typically, you install the display on a wall in a classroom or meeting space.

## Choosing a location

A display is typically installed at the room's focal point, such as at the front of a classroom or meeting space.

Selecting an appropriate location for the display is crucial for ensuring the best possible experience with the product. Consider the following factors as you choose a location:

Factor	Considerations
Room setup	<ul style="list-style-type: none"><li>• The location allows users, including those in wheelchairs, access to the display. Refer to local regulations regarding accessibility.</li><li>• The location allows for multiple users to access the display at the same time.</li><li>• The location accommodates room traffic patterns, and there are no tripping hazards.</li><li>• The display is not installed where it could be hit by a door or gate.</li><li>• There are no nearby heat sources directed at the display like a radiator or heat vent.</li><li>• There are no nearby shelving units, desks or other furniture that has doors or drawers that could hit the display.</li><li>• Furniture, wall décor and other room features, such as light switches and thermostats, do not block the display and are not blocked by it. (You might be able to move some of these room features to accommodate the display.)</li></ul>
Power and other connections	<ul style="list-style-type: none"><li>• The location is close to<ul style="list-style-type: none"><li>◦ A power outlet</li><li>◦ A network outlet (if you plan to use a wired network connection)</li><li>◦ A room computer (if you plan to connect a room computer)</li><li>◦ External audio systems and other devices that you want to connect to the display</li></ul></li></ul> <hr/> <p><b>NOTES</b></p> <ul style="list-style-type: none"><li>◦ If the location is not near a power outlet, consult an electrician for the power setup you need.</li><li>◦ Determine if you'll need additional equipment, such as power bars, additional cables, or cable extenders.</li></ul> <hr/> <ul style="list-style-type: none"><li>• The location is not where the mains power supply enters the building.</li></ul>

Factor	Considerations
<p>Visibility</p>	<p>The display's screen is clearly visible to all users in the room. SMART recommends users sit within a 178° viewing area:</p> <div data-bbox="630 386 1247 688" data-label="Diagram"> </div> <hr/> <p><b>NOTE</b></p> <p>The viewing area depends on the display's resolution and a variety of other factors. For more information, see the knowledge base article, <a href="#">Recommended viewing distances and viewing angles for SMART Board interactive flat panels</a>.</p>
<p>Lighting</p>	<p>The location is not near bright light sources, such as windows or strong overhead lighting.</p> <p>Light sources can cause glare on the display's screen, reducing its visibility.</p> <hr/> <p><b>TIP</b></p> <p>To reduce light interference, install blinds or shades on windows or skylights and install switches to dim or turn off any lights shining directly on the display's screen. Keep in mind that sunlight can come through windows at different angles at different times of the year.</p>
<p>Acoustics</p>	<p>The room has good acoustics (see <a href="#">Configuring your SMART Board MX (V2) for the best audio performance</a>).</p>
<p>Environment and ventilation</p>	<ul style="list-style-type: none"> <li>• The location meets the environmental requirements in the display's specifications (see <i>More information</i> on page 8).</li> <li>• The display isn't subjected to strong vibrations or dust.</li> <li>• Ventilation systems don't blow air directly on the display.</li> <li>• There is adequate ventilation or air conditioning around the display so that heat can flow away from it and the mounting equipment. SMART recommends at least 2" (5 cm) of space on all sides of the display for proper airflow.</li> <li>• If you plan to install the display in a recessed area, there is at least 4" (10 cm) of space between the display and the recessed walls to enable ventilation and cooling.</li> </ul>

## Choosing a height

Consider the general height of the user community when you choose the height for the display.

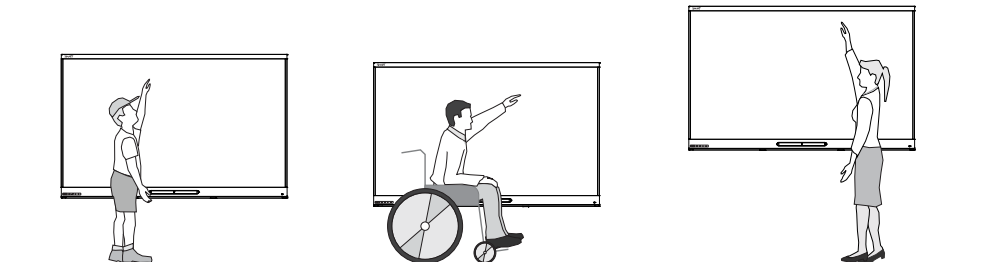

SMART recommends that you mount the display so that its top is 6' 5" (1.9 m) from the floor.

---

### NOTE

If participants will be sitting at a steep angle (such as in a lecture hall), you may have to adjust the installation height or angle.

---

## Assessing the wall

Be sure the wall you're installing the display on can support the weight of the display and mounting equipment. If the wall can't support the weight of the display and mounting equipment, consider using a SMART wall stand to transfer some of the weight from the wall to the floor (see [smarttech.com/accessories](https://www.smarttech.com/accessories)).

---

### NOTE

Refer to the display's specifications for its weight (see *More information* on page 8).

---

In some situations, you may need to request an engineering analysis to determine if the wall can support the display.

## Selecting mounting hardware

The mounting hardware required for installation varies according to the type of wall onto which the display is being mounted.

Refer to *Installation best practices for SMART products* ([smarttech.com/kb/171035](https://www.smarttech.com/kb/171035)) for the mounting hardware required for the display.

## Selecting a wall mount

It is always best to mount the display on a wall. If the wall can't support the display's weight, you



can use additional hardware to transfer some of the weight to the floor.

The display includes a pre-attached wall bracket which can be used to mount the display to the wall. See the *SBID-MX265-V2, MX275-V2 and MX286-V2 installation instructions* ([smarttech.com/kb/171282](http://smarttech.com/kb/171282)).

Contact your authorized SMART reseller ([smarttech.com/where](http://smarttech.com/where)) for information on SMART's mounting options.

If you choose a third-party option rather than one of SMART's mounting options, be sure the wall mount can accommodate the display's dimensions and support the display's weight as well as the weight of any attached accessories.

## Mounting the display

Mount the display following the included installation instructions. In addition, consider the following:

The electrical and mechanical components of a display are designed to work properly when the display is mounted in the orientation described in its installation instructions. Mounting the display in a different orientation can cause malfunctions and will void the display's warranty.

There are a number of potential hazards of mounting a display in a non-standard orientation or angle:

- Mounting a display horizontally (like a table top) can cause the glass to sag, damaging the display or interfering with the display's touch system.
- Non-standard orientation can affect ventilation, creating hotspots in equipment, premature failures and, in displays that use projectors, exploding projector bulbs.





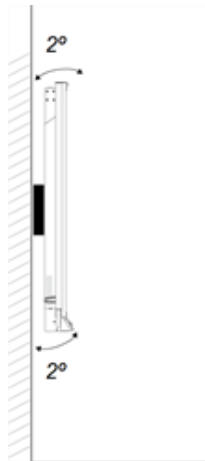



**INSTALLING THE DISPLAY**

- Mount the display vertically ( $90^\circ$  relative to the floor plus or minus  $2^\circ$  for tolerance) and in landscape orientation. SMART doesn't support mounting the display at other angles or in portrait orientation.



- Use the included wall mount. Optionally, use a VESA-approved mounting plate that is rated for the display's weight and size.

- If you're not using the included bolts to fasten the wall mount to the display, see the following table.

<b>SMART Board MX265-V2</b>	Minimum M8 length	14 mm + x mm where x is the combined thickness of the wall mount and washer	
	Maximum M8 bolt length	18 mm + x mm where x is the combined thickness of the wall mount and washer	
	Fasten force	97.36–177.01 in-lb. (11–20 N·m)	
			<p> <b>CAUTION</b></p> <p>Do not over-tighten the bolts.</p>
<b>SMART Board MX275-V2</b>	Minimum M8 length	18 mm + x mm where x is the combined thickness of the wall mount and washer	
	Maximum M8 bolt length	30 mm + x mm where x is the combined thickness of the wall bracket and washer	
	Fasten force	97.36–177.01 in-lb. (11–20 N·m)	
			<p> <b>CAUTION</b></p> <p>Do not over-tighten the bolts.</p>
<b>SMART Board MX286-V2</b>	Minimum M8 length	14 mm + x mm where x is the combined thickness of the wall mount and washer	
	Maximum M8 bolt length	30 mm + x mm where x is the combined thickness of the wall mount and washer	
	Fasten force	97.36–177.01 in-lb. (11–20 N·m)	
			<p> <b>CAUTION</b></p> <p>Do not over-tighten the bolts.</p>

## Installing the display on a stand

If you want to move the display from place to place or if it's not possible to install the display on a wall, you can install it on a stand.

## Using SMART mobile stands

SMART mobile stands are designed for SMART interactive displays. They are height-adjustable. Some models include integrated speakers, a locking cabinet to secure equipment, and casters that swivel and lock for easy movement.

For more information about SMART mobile stands, see [smarttech.com/accessories](http://smarttech.com/accessories).

## Using a third-party stand

For information on selecting and using a third-party stand, see [Installing your SMART Board MX \(V2\) on a stand](#).

## Connecting to a network

Before connecting the display, your organization's network administrators need to configure the network to allow users to update the display's firmware automatically and use all the features of the iQ experience. See [Configuring your organization's network for a SMART display with the iQ experience](#).

The display requires a network and internet connection for downloading software and firmware updates, and a number of the iQ apps require a network connection as well. You can connect to a network using a Wi-Fi connection or one of the RJ45 jacks on the display (pictured).

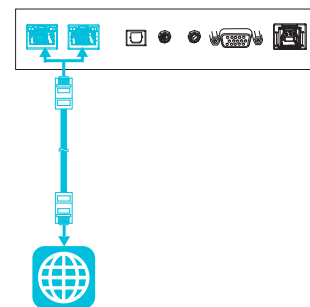

### TIP

If you're using one of the display's RJ45 jacks to connect to a network, you can connect the other RJ45 jack to a computer to provide network access for the computer (pictured). This is particularly useful if there is only one wired network connection in the room. (Network access is available when the display is on or in Standby mode but not when it's in Power Save mode.)

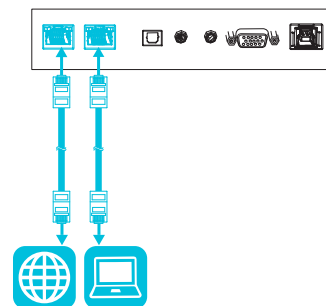

## Connecting power and turning on the display for the first time

The final step in installing and configuring the display is to connect power and turn it on. When you first turn on the display, a setup wizard appears. Follow the steps in the wizard to complete the setup of the display.

### To connect the display to power

Connect the supplied [power cable](#) from the AC power inlet on the back of the display to a power outlet.

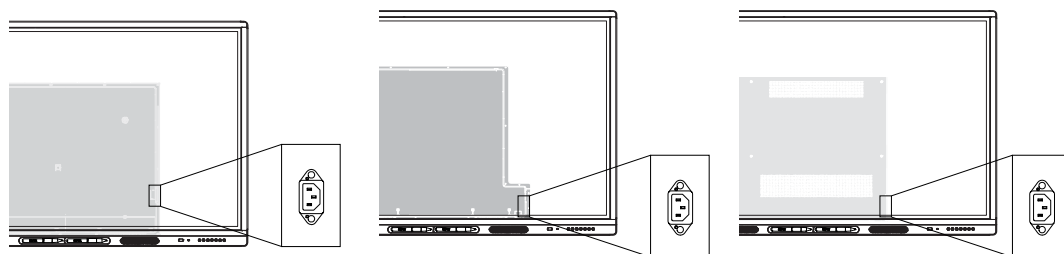

SBID-MX265-V2

SBID-MX275-V2

SBID-MX286-V2

---

### NOTE

Refer to the display's specifications for power requirements and power consumption information (see *More information* on page 8).

---

### To turn on and set up the display for the first time

---

#### **!** IMPORTANT

Install the OPS PC before you turn the display on.

---

### NOTES

- Touch is not available right after waking up the display or turning it on. Wait a few seconds and then the display will respond to touch.
  - If a USB drive connected to the display's service port, do not remove the USB drive. The USB drive contains an important firmware update.
-

CHAPTER 2  
INSTALLING THE DISPLAY

1. Flick the switch beside the AC power inlet to the ON (I) position.

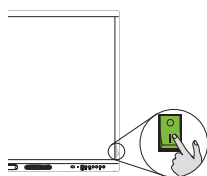

SBID-MX265-V2

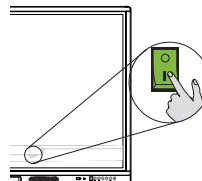

SBID-MX275-V2

SBID-MX286-V2

2. Press the **Power** button  on the front control panel or remote control
3. Select your preferred language, and then tap **Next**.
4. Select your country, and then tap **Next**.
5. Select your time zone, and then tap **Next**.
6. Set the date, and then tap **Next**.
7. Set the time, and then tap **Next**.
8. Name the display, and then tap **Next**.
9. If the display isn't using a wired network connection, select a wireless network, and then tap **Next**.

---

 **IMPORTANT**

The display needs an internet connection for downloading and installing important updates. Ask the network administrator to confirm that the network has been correctly configured for the iQ experience. For more information about network configuration, see [Connecting a SMART display with the iQ experience to a network](#).

10. Select the apps you want to appear in the Apps Library, and then tap **Next**.

---

**TIP**

To change which apps appear in the Apps Library, see *Launcher* on page 53.

11. Tap **Finish**.

The *Welcome* screen appears.

OR

The display downloads and applies updates for the firmware and system software.

## Chapter 3

# Connecting computers and other devices

Installing SMART software .....	22
Connecting room computers and guest laptops .....	22
Viewing a connected computer's input .....	24
Setting a connected computer's resolution and refresh rate .....	24
Connecting USB drives, peripherals, and other devices .....	25
Troubleshooting connected computers .....	25
Connecting a SMART OPS PC module .....	26
Viewing the OPS PC module input .....	26
Connecting external displays .....	26
Connecting other devices .....	27
Connecting USB drives, peripherals, and other devices .....	27
Connecting an external display .....	28
Connecting an external audio system .....	29
Connecting room control systems .....	29
Connector diagrams .....	30
Connector panel .....	30
Front connector panel .....	31
SMART PCM8 series OPS PC (optional) .....	32

---

### **WARNING**

Ensure that any cables that cross the floor to the display are properly bundled and marked to avoid a trip hazard.

---

## Installing SMART software

The display comes with the following software, which you can install on connected computers:

Software	Description	Licensing details
SMART Learning Suite	A suite of desktop and online software that combines lesson delivery, activities, assessments, and collaborative workspaces and includes SMART Notebook software and SMART Learning Suite Online.	1-year subscription <sup>1</sup>
SMART Product Drivers	Software that enables the computer to detect input from the display.	Included with SMART Learning Suite
SMART Ink	Software that enables you to write and draw in digital ink over applications, files, folders, websites, and any other open window.	Included with SMART Learning Suite

### TIP

You can purchase additional licenses or subscriptions to SMART software to install on other computers.

The following software is also available but sold separately:

Software	Description
SMART Remote Management	Cloud-based mobile device management software for remotely maintaining, supporting, controlling, and securing the display and your other devices

Contact your authorized SMART reseller ([smarttech.com/where](http://smarttech.com/where)) for information about purchasing SMART software.

You can download SMART software from [smarttech.com/downloads](http://smarttech.com/downloads) and install it following the instructions in [Installing and maintaining SMART Notebook](#).

## Connecting room computers and guest laptops

You can connect cables for room computers and guest laptops. By installing cables in advance, you make use of connectors that might not be accessible after the display is wall-mounted. You can then run the cables across floors or behind walls as needed.

---

<sup>1</sup>SMART Notebook basic version also available.



Side and bottom connector panel

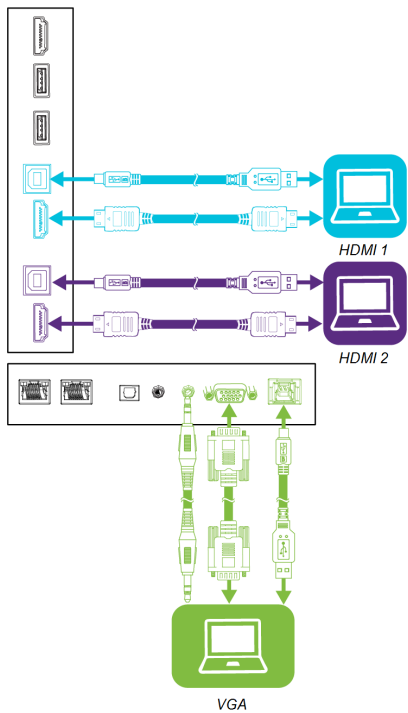

Front connector panel

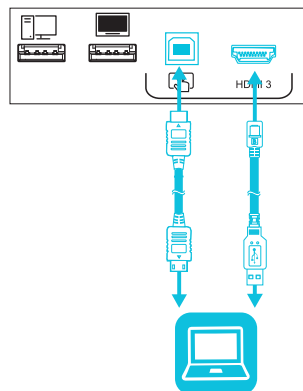

**NOTES**

Install SMART software on any computers you connect to the display (see *Installing SMART software* on the previous page).

## Viewing a connected computer's input

### To view a connected computer's input

1. Connect the computer to the display.
2. Press the **Input**  button on the front control panel or the remote control.

The display shows thumbnails of the devices that are connected to the display's inputs:

#### NOTE

A thumbnail with **Touch enabled**  indicates a USB cable is connected between the display and device and touch is available.

- A gray thumbnail indicates no device is connected to an input.
  - A black thumbnail indicates a device is connected to an input but is in Sleep mode.
  - A thumbnail showing a preview screen indicates an active device is connected to an input.
3. Tap the computer's thumbnail.

## Setting a connected computer's resolution and refresh rate

The following table presents the recommend resolutions and refresh rates for the display's HDMI 1, HDMI 2, and HDMI 3 input sources:

Resolution	Input source aspect ratio	Mode	Refresh rate
3840 × 2160	16:9	UHD / 2160p	59.94 Hz / 60 Hz 50 Hz 29.97 Hz / 30 Hz 25 Hz 23.98 Hz / 24 Hz
1920 × 1080	16:9	FHD / 1080p	59.94 Hz / 60 Hz 50 Hz 29.97 Hz / 30 Hz 25 Hz 23.98 Hz / 24 Hz
1360 × 768	16:9	HD	60.015 Hz
1366 × 768	16:9	HD	60.015 Hz

Resolution	Input source aspect ratio	Mode	Refresh rate
1280 × 720	16:9	HD / 720p	59.94 Hz / 60 Hz 50 Hz 29.97 Hz / 30 Hz 25 Hz 23.98 Hz / 24 Hz
720 × 480	16:9	480p (DVD Player)	60 Hz

The following table presents the recommend resolutions and refresh rates for the display's VGA input source:

Resolution	Input source aspect ratio	Mode	Refresh rate
1920 × 1080	16:9	[N/A]	60.000 Hz
1600 × 1200	4:3	[N/A]	60.000 Hz
1360 × 768	16:9	[N/A]	60.015 Hz
1280 × 1024	5:4	SXGA 60	60.020 Hz
1024 × 768	4:3	XGA 60 XGA 70 XGA 75	60.004 Hz 70.069 Hz 75.029 Hz
800 × 600	4:3	SVGA 60 SVGA 72 SVGA 75	60.317 Hz 72.188 Hz 75.000 Hz
640 × 480	4:3	VGA 60	59.940 Hz

If possible, set any connected computers to these resolutions and refresh rates. See the connected computers' operating system documentation for instructions.

## Connecting USB drives, peripherals, and other devices

You can use USB drives, peripherals, and other devices with a computer connected to the display using the USB receptacles on the display.

For more information, see *Connecting USB drives, peripherals, and other devices* on page 27.

## Troubleshooting connected computers

For troubleshooting information for connected computers, see *Chapter 5: Troubleshooting* on page 43.

## Connecting a SMART OPS PC module

If your organization has purchased a SMART OPS PC module, you or your organization's installers can install the OPS PC module in the accessory slot of the SMART Board MX (V2) series interactive display following the OPS PC module's installation instructions ([smarttech.com/kb/171544](http://smarttech.com/kb/171544)). You can then view the OPS PC module's input on the display.

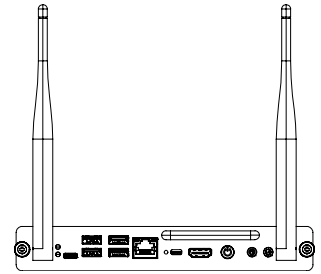

For more information about the PCM8 series of SMART OPS PC modules, see *SMART OPS PC module* on page 6.

---

### CAUTION

Do not install the OPS PC module or remove it from the accessory slot while the display is turned on.

---

### TIP

You can install the SMART software that is included with the display on the OPS PC. For more information on installing software, see *Installing SMART software* on page 22.

---

## Viewing the OPS PC module input

### To view the OPS PC module input

1. Press the **Input**  button on the front control panel or the remote control.  
The input selection menu appears.
2. Tap the OPS PC module input.

## Connecting external displays

You can connect an external display to duplicate or extend the OPS PC module's desktop.

For more information, see *Connecting an external display* on page 28.

## Connecting other devices

In addition to computers, you can connect the following devices to the display:

- USB drives, peripherals, and other devices
- External displays
- External audio systems
- Room control systems

### Connecting USB drives, peripherals, and other devices

The display includes the following USB Type A receptacles. You can connect USB drives, peripherals (such as keyboards), and other devices to these connectors and use the devices with the iQ experience, connected computers, and devices installed in the accessory slot (such as the SMART PCM8 series OPS PC).

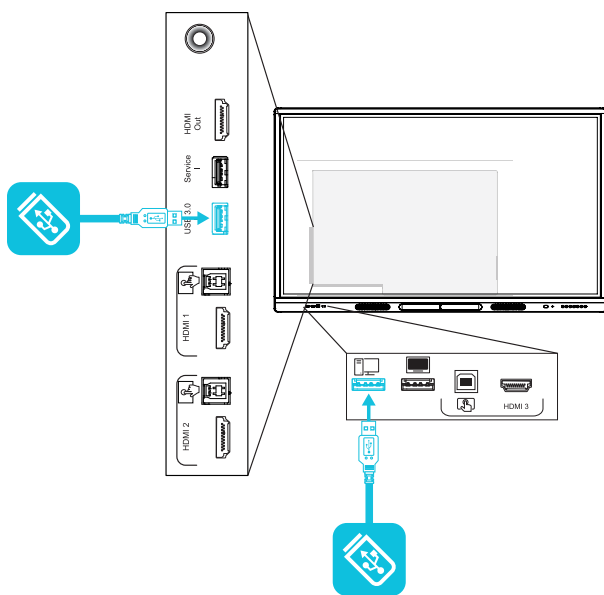

The following table shows which USB 3.0 Type-A receptacles you can use with each input source and the supported USB speed:

Input source	USB 3.0 Type-A receptacle on the side connector panel	USB 2.0 Type-A receptacle on the front connector panel
iQ	✓ (SuperSpeed)	✓ (Hi-Speed)
HDMI 1	✓ (SuperSpeed)	✓ (Hi-Speed)

Input source	USB 3.0 Type-A receptacle on the side connector panel	USB 2.0 Type-A receptacle on the front connector panel
HDMI 2	✓ (SuperSpeed)	✓ (Hi-Speed)
HDMI 3	✓ (SuperSpeed)	✓ (Hi-Speed)
VGA	✓ (SuperSpeed)	✓ (Hi-Speed)
Accessory slot	✓ (SuperSpeed)	✓ (Hi-Speed)
OPS PC	✓ (SuperSpeed)	✓ (Hi-Speed)

**NOTE**

If a SMART OPS PC module is installed in the accessory slot, you can connect USB drives, peripherals, and other devices to the USB 2.0 Type-A, USB 3.0 Type-B, and USB Type-C receptacles on the OPS PC module to access those devices from the OPC PC module input.

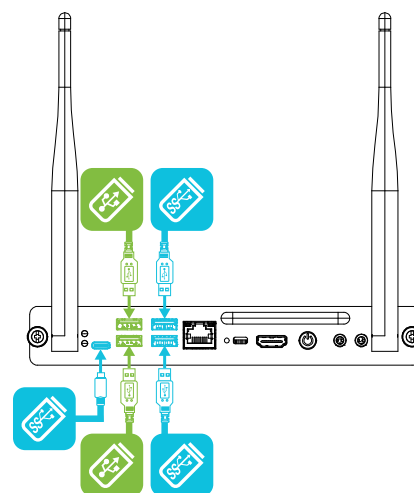

### Connecting an external display

You can connect an external display using the HDMI 2.0 out connector on the connector panel (pictured). The external display will show the same image. This is useful when you're using the display in an auditorium or other large space where it would be beneficial to have a second display.

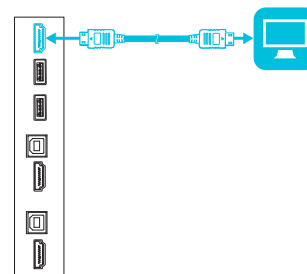

**! IMPORTANT**

If the connected external display doesn't support HDCP, the image on the external display is limited to 480p resolution. For full resolution output, connect a display that supports HDCP.

**TIP**

If a SMART OPS PC module is installed in the accessory slot, you can connect an external display to the HDMI 1.4 out connector on the OPS PC module rather than the one on the display. Doing so allows you to either duplicate or extend the OPS PC module's desktop to the external display.

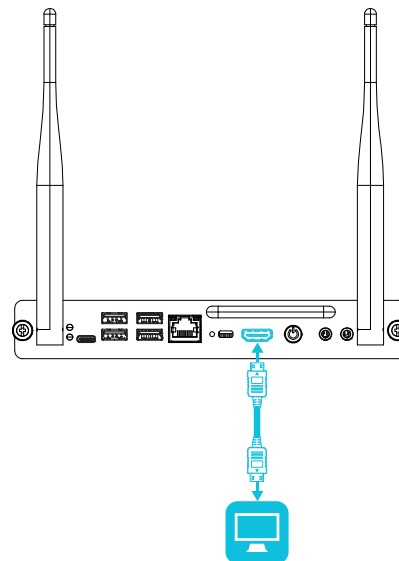

### Connecting an external audio system

The display includes two speakers, which are designed to provide sound at the front of a room. You might want to connect the SBA-100 projection audio system (see *SBA-100 projection audio system* on page 7) or a third-party external audio system if you're providing sound in a larger space. You can connect an external audio system to the display using the stereo 3.5 mm out connector (pictured). This disables the display's internal speakers. Alternatively, you can connect an external audio system directly to a room computer.

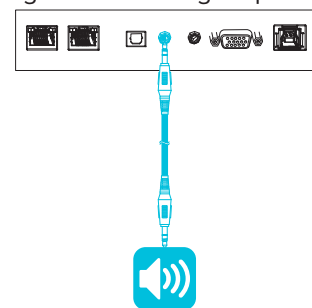

In addition to the stereo 3.5 mm out connector, the display provides a Sony/Philips Digital Interface (S/PDIF) out connector (pictured). S/PDIF is a digital audio transmission medium. You need an audio system that has an S/PDIF input to decode this connection to analog. Most external sound bars include a S/PDIF connector.

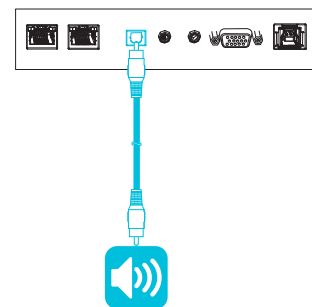

### Connecting room control systems

A room control system enables users to control a room's lighting, audio system and, possibly, the

display. Some installations may require you to integrate the display with a room control system.

You can use the display's RS-232 connector to connect a third-party external control system to the display (see *Appendix B: Managing the display using RS-232* on page 59).

**NOTE**

Displays are not compatible with centralized remote control systems, such as a universal remote control.

## Connector diagrams

### Connector panel

The following diagram and table present the connectors on the display's connector panel:

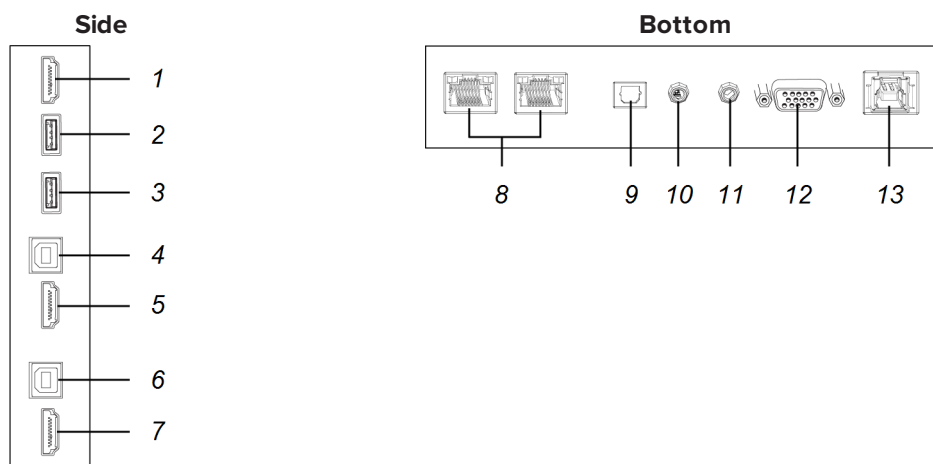

No.	Connector	Connects to	Notes
1	HDMI 2.0 out	External display	See <i>Connecting an external display</i> on page 28 and <a href="#">HDMI cables and connectors</a> .
2	USB 2.0 Type-A	[N/A]	This connector is a service port.
3	USB 3.0 Type-A	Supported USB drives, peripherals, and other devices	See <i>Connecting USB drives, peripherals, and other devices</i> on page 27 and <a href="#">USB cables and connectors</a> .



No.	Connector	Connects to	Notes
4	USB 3.0 Type-B	HDMI 1 input (touch)	See page 22 and <a href="#">USB cables and connectors</a> .
5	HDMI 2.0 in	HDMI 1 input (video and audio)	See page 22 and <a href="#">HDMI cables and connectors</a> .
6	USB 3.0 Type-B	HDMI 2 input (touch)	See page 22 and <a href="#">USB cables and connectors</a> .
7	HDMI 2.0 in	HDMI 2 input (video and audio)	See page 22 and <a href="#">HDMI cables and connectors</a> .
8	RJ45 (×2)	Network	See page 18 and <a href="#">Ethernet (network) cables and connectors</a> .
9	S/PDIF out	Digital audio output	See page 29 and <a href="#">Digital audio cables and connectors</a> .
10	Stereo 3.5 mm out	External audio system	See page 29 and <a href="#">Analog audio cables and connectors</a> .
11	Stereo 3.5 mm in	VGA input (audio)	See page 22 and <a href="#">Analog audio cables and connectors</a> .
12	VGA in	VGA input (video)	See page 22 and <a href="#">VGA cables and connectors</a> .
13	USB 3.0 Type-B	VGA input (touch)	See page 22 and <a href="#">USB cables and connectors</a> .

## Front connector panel

The following diagram and table present the connectors on the display's front connector panel:

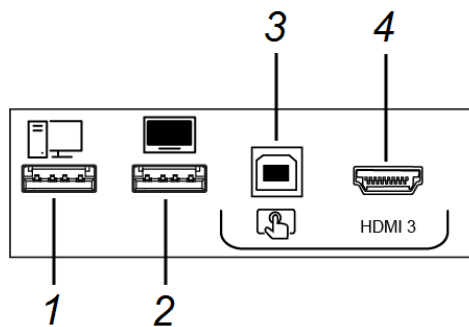

No.	Name	Procedure
1	USB 2.0 Type-A connector	Connect USB drives and other devices that you want to use with the currently selected input source.
2	USB 2.0 Type-A connector	Connect a USB drive to update the display's firmware.
3	USB 2.0 Type-B connector	Connect a USB cable to the display and computer to provide touch control of the computer connected to HDMI 3.
4	HDMI 3 input connector	Connect a computer or other input source to the display (see page 22).

### SMART PCM8 series OPS PC (optional)

The following diagram and table present the connectors on the optional SMART OPS PC module:

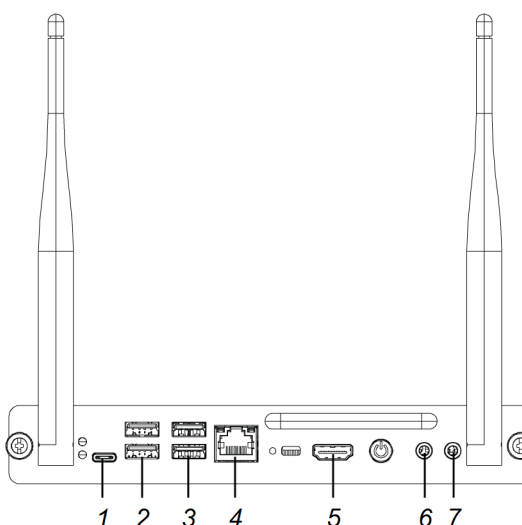

No.	Connector	Connects to	Notes
1	USB Type-C	Supported USB drives, peripherals, and other devices	See <i>Connecting USB drives, peripherals, and other devices</i> on page 27 and <a href="#">USB cables and connectors</a> .
2	USB 2.0 Type-A (×2)	Supported USB drives, peripherals, and other devices	See <i>Connecting USB drives, peripherals, and other devices</i> on page 27 and <a href="#">USB cables and connectors</a> .

CHAPTER 3  
CONNECTING COMPUTERS AND OTHER DEVICES

No.	Connector	Connects to	Notes
3	USB 3.0 Type-A (×2)	Supported USB drives, peripherals, and other devices	See <i>Connecting USB drives, peripherals, and other devices</i> on page 27 and <a href="#">USB cables and connectors</a> .
4	RJ45	[N/A]	The OPS PC module uses the display's network connection (if available), so you typically don't need to connect the OPS PC module directly to a network.
5	HDMI out	External display	See <i>Connecting an external display</i> on page 28 and <a href="#">HDMI cables and connectors</a> .
6	Stereo 3.5 mm out	External speakers or headphones	[N/A]
7	Stereo 3.5 mm in	Microphone	[N/A]



## Chapter 4

# Maintaining the display

Turning off, turning on, and resetting the display .....	35
Cleaning and maintaining hardware .....	36
Checking the display installation .....	36
Cleaning the screen .....	37
Cleaning the touch sensors .....	37
Maintaining ventilation .....	38
Preventing condensation .....	38
Replacing the pens .....	38
Removing and transporting the display .....	39
Updating system software .....	40
Applying an automatic system software update manually .....	40
Updating system software manually .....	41

---

With proper maintenance, the display will provide years of use.

## Turning off, turning on, and resetting the display

---

In most situations, you can put the display to sleep when not using it following the instructions in the *SMART Board MX (V2) series interactive displays user guide* ([smarttech.com/kb/171554](http://smarttech.com/kb/171554)).

In some situations, such as when you transport the display or clean its screen, you need to turn off the display for a period of time. You can turn it back on after.

You can also reset the display.

### To turn the display off

1. Press the **Power** button  on the front control panel or the remote control for four seconds.  
A slider appears on the screen.
2. Move the slider to the right.

3. Flick the switch beside the AC power inlet to the OFF (O) position.

---

**NOTE**

Wait at least 30 seconds before turning the display back on.

---

**To turn the display back on**

---

**NOTE**

Touch is not available right after waking up the display or turning it on. Wait a few seconds and then the display will respond to touch.

---

1. Flick the switch beside the AC power inlet to the ON (I) position.
2. Press the **Power** button  on the front control panel or the remote control.

**To reset the display**

Press and hold the **Power** button  on the front control panel or the remote control for 10 seconds.

The display resets.

## Cleaning and maintaining hardware

### Checking the display installation

Inspect the display installation frequently to ensure that it remains securely installed.

- Check the mounting location for signs of damage or weakness that can occur over time.
- Check for loose screws, gaps, distortions or other issues that could occur with the mounting hardware.

If you find an issue, contact a trained installer.

## Cleaning the screen

Follow these instructions to clean the screen without damaging its anti-glare coating or other product components.

---

### CAUTION

- Do not use permanent or dry-erase markers on the screen. If dry-erase markers are used on the screen, remove the ink as soon as possible with a lint-free, non-abrasive cloth.
- Do not rub the screen with dense or rough material.
- Do not apply pressure to the screen.
- Do not use cleaning solutions or glass cleaners on the screen, because they can deteriorate or discolor the screen.

---

### To clean the screen

1. Turn off any connected computers.
2. Turn off the display (see *Turning off, turning on, and resetting the display* on page 35).
3. Wipe the screen with a lint-free, non-abrasive cloth.

---

### NOTE

Alternatively, you can use a damp cloth with a drop of dish soap.

---

## Cleaning the touch sensors

The display uses infrared (IR) transmitters and sensors around the display's perimeter between the screen and the frame. Dust buildup on the protective plastic can impair touch performance. Inspect these areas for dust and clean them every week.

---

### CAUTION

- Do not use compressed air to clean the sensors or borders.
  - Do not use water or cleaning agents to clean the touch sensors.
  - Do not apply too much pressure when cleaning the display because you can damage the plastic.
-

### To clean the IR transmitters and sensors

1. With a clean lint-free, non-abrasive cloth, gently wipe the plastic between the screen and the frame around the perimeter of the display's screen.
2. If dirt still remains, use 50% isopropyl alcohol (IPS) to clean the protective plastic between the screen and the frame.

## Maintaining ventilation

The display requires proper ventilation. Dust buildup in the ventilation holes compromises cooling and can lead to product failure.

- Clean accessible ventilation holes monthly with a dry cloth.
- Use a vacuum cleaner with a narrow hose end fitting to clear the back ventilation holes regularly. You might have to remove the display from the wall.

For more information on removing the display, see *Removing and transporting the display* on the facing page.

---

### CAUTION

Avoid setting up or using the display in an area with excessive levels of dust, humidity, or smoke.

---

## Preventing condensation

If the display has been moved from a colder environment to a warmer environment (for example, from storage to the installation site), let the display sit for a few hours so that it can acclimate to the new temperature. Failing to do so can cause humidity to build up in the space between the front glass and the LCD.

If condensation appears under the screen after you turn on the display, select an active video source and leave the display on for 48 hours. If the condensation doesn't dissipate, contact SMART Support if the display is still under warranty.

If there is enough moisture between the layers to cause the moisture to drip and run, remove power immediately and contact SMART Support if the display is still under warranty.

## Replacing the pens

To prevent damage to the display's anti-glare surface, replace a pen if its nib becomes worn. You can purchase replacement pens from the Store for SMART Parts (see [smarttech.com/Support/PartsStore](https://smarttech.com/Support/PartsStore)).



## NOTE

For pen part numbers, refer to the service parts diagrams.

---

## Removing and transporting the display

If the display is wall mounted, you might need to remove it from its current location and transport it to another location on occasion.

To remove the display safely, use two or more trained installers.

---

### **WARNING**

- Do not attempt to move the display by yourself. The display is very heavy.
  - Do not move the display by connecting a rope or wire to the handles on the back. The display can fall and cause injury and product damage.
- 

### **IMPORTANT**

Follow any documentation included with the third-party mounting hardware.

---

### To remove the display

1. Turn off connected computers.
2. Turn off the display by pressing and holding the **Power** button  on the front control panel for four seconds.
3. Flick the switch on the back of the display to the OFF (O) position.
4. Remove all accessible cables, connectors and antennae.
5. Remove any modules from the accessory slot.

6. Lift the display from its mounting location and insert it into its original shipping box.

---

 **WARNING**

Do not place the display on a sloping or unstable cart, stand or table. The display could fall, resulting in injury and severe product damage.

---

 **CAUTION**

Do not leave the display face up, face down or upside down for an extended period. This could cause permanent damage to the screen.

---

7. Remove the mounting brackets.

### To transport the display

See *Moving the display to the installation site* on page 9.

## Updating system software

When the display is connected to the Internet, it updates its system software automatically.

When a system software update is available, the display downloads the update in the background then waits for four hours of inactivity. When that happens, the display shows a two-minute countdown before beginning the update. The countdown can be interrupted at any time. The update begins when the countdown finishes. The display shows a blank screen for four minutes. When the update is complete, the display shows the Home screen.

When the update is installing, touch, the front control panel and remote control will not respond.

---

### NOTE

You can configure your organization's network to allow or prevent automatic system software updates (see [Connecting to a network](#)).

---

## Applying an automatic system software update manually

If the display has downloaded the system software update but hasn't yet applied the update, you can start the update process manually from Settings.

### To apply an automatic iQ system software update manually

1. From the Home screen, tap **Settings** .
2. Scroll to **Auto Update**.
3. Under *Check for Updates Now*, tap **Apply Update Now**.

### Updating system software manually

You can download system software updates at [smarttech.com/downloads](https://smarttech.com/downloads) and update your display using a USB drive.



## Chapter 5

# Troubleshooting

The display isn't turning on .....	43
The screen is blank or there's a problem with the image on the screen .....	44
There's no sound or there's a problem with the sound .....	45
Touch isn't working as expected .....	46
The pens and erasers aren't working as expected .....	47
iQ apps aren't working as expected .....	47
SMART software on connected computers isn't working as expected .....	47
The SMART PCM8 OPS PC isn't working as expected .....	48
Contacting your reseller for additional support .....	48

This section explains how to resolve a variety of common issues with the display and SMART PCM8 OPS PC (if installed). If your specific symptoms aren't covered below or the solutions to the symptoms don't work, refer to the SMART knowledge base for additional troubleshooting information

[community.smarttech.com/s/topic/0TO0P000000Xt5yWAC/mx-series](https://community.smarttech.com/s/topic/0TO0P000000Xt5yWAC/mx-series)

## The display isn't turning on

Symptom	Troubleshooting steps
The power light isn't lit.	<ul style="list-style-type: none"> <li>Make sure the power cable is securely fastened to the power outlet and the display.</li> </ul> <hr/> <p><b>NOTE</b></p> <p>If the power cable is connected to a power bar, make sure the power bar is securely fastened to the power outlet and turned on.</p> <hr/> <ul style="list-style-type: none"> <li>Make sure the switch beside the AC power inlet is in the ON (I) position.</li> <li>Make sure the power outlet is working by testing it with a different device.</li> <li>Make sure the power cable is working by testing it with a different device.</li> </ul>
The power light is lit, but the screen is blank.	<ul style="list-style-type: none"> <li>Determine if the problem is with the video.</li> <li>Restart the display.</li> </ul> <p>See <i>Turning off, turning on, and resetting the display</i> on page 35.</p>

## The screen is blank or there's a problem with the image on the screen

### NOTE

If the issue occurs on the Home screen, the issue may be with the display. See *Contacting your reseller for additional support* on page 48.

If the issue doesn't occur on the Home screen, examine the connected computers or devices.

Symptom	Troubleshooting steps
The screen is blank.	<ul style="list-style-type: none"><li>• Make sure any connected computers are on and not in Standby mode.</li><li>• Restart the display and any connected computers. <i>See Turning off, turning on, and resetting the display</i> on page 35.</li><li>• Replace the video cables connecting any computers to the display to determine if the issue is with the cables.</li></ul>
A computer is connected to the display, but only a connection message appears on the screen.	<ul style="list-style-type: none"><li>• Make sure the computer is connected to the currently selected input.</li><li>• If the currently selected input is a computer, make sure the computer is awake.</li></ul>
The image on the screen is distorted. OR There are lines, snow or other visual noise on the screen. OR The image is flickering or flashing. OR The image is dim.	<ul style="list-style-type: none"><li>• Switch to a different input and then back to the first input.</li><li>• Make sure any connected computers are on and not in Standby mode.</li><li>• Set any connected computers' resolution and refresh rate to values that the display supports. <i>See Setting a connected computer's resolution and refresh rate</i> on page 24.</li><li>• Restart the display and any connected computers. <i>See Turning off, turning on, and resetting the display</i> on page 35.</li><li>• Replace the video cables connecting any computers to the display to determine if the issue is with the cables.</li></ul>
There are bright spots on the screen.	<ul style="list-style-type: none"><li>• Take a photograph of the screen and send it to SMART support. If SMART support determines that the issue is with the screen and the display is under warranty, you may be eligible for a replacement.</li></ul>
Colors don't appear correctly.	<ul style="list-style-type: none"><li>• Be aware that if two or more displays are mounted side-by-side, there could be minor differences in colors across the displays. This issue is not unique to SMART products.</li><li>• If the screen is completely lacking one color on the screen or the color problems occur on the Home screen, see <i>Contacting your reseller for additional support</i> on page 48.</li><li>• If you're using a VGA video input, use a different cable or connect a different source to see if the issue is with the cable or input source.</li></ul>

Symptom	Troubleshooting steps
The image is cut off or shifted to the left or right.	<ul style="list-style-type: none"> <li>Adjust any connected computers' video settings, particularly zoom, crop, and underscan. See the computer's operating system documentation.</li> <li>If any connected computers' desktops are entirely black, change them to dark gray or a different color.</li> <li>If any connected computers' desktops are extended across multiple screens, duplicate the desktops across the screens or set the display as the only screen.</li> </ul>
The image doesn't fill the entire screen.	<ul style="list-style-type: none"> <li>Adjust any connected computers' video settings, particularly overscan. See the computer's operating system documentation.</li> <li>Make sure the connected computer's video connector is configured to output a supported video signal. See <a href="#">No video display output from a laptop</a>.</li> </ul>
A persistent image appears on the display.	See <a href="#">Image persistence or burn in on LCD displays</a> .

## There's no sound or there's a problem with the sound

Symptom	Troubleshooting steps
There's no sound. OR There is sound, but the volume is low. OR The sound is distorted or muffled.	<ul style="list-style-type: none"> <li>If you're using an external audio system, make sure it is turned on.</li> <li>Make sure the cables connecting the display to the computer are securely fastened.</li> </ul> <hr/> <p><b>NOTES</b></p> <ul style="list-style-type: none"> <li>The display's stereo 3.5 mm in connector works with the VGA input only.</li> <li>Connecting an audio cable to the display's stereo 3.5 mm out connector disables the internal speakers.</li> <li>If you're using the display's S/PDIF out connector to connect a sound bar or receiver for external speakers, see <i>Connecting an external audio system</i> on page 29.</li> </ul> <hr/> <ul style="list-style-type: none"> <li>If you're using the display's stereo 3.5 mm out connector, adjust the volume on the display and the connected computer and make sure neither are muted.</li> <li>If you're using the display's S/PDIF out connector, adjust the volume on the external audio system and make sure the audio system isn't muted.</li> <li>Adjust the display's audio settings. See <i>Appendix A: Adjusting iQ settings</i> on page 51.</li> <li>If you're using the integrated speakers, set the volume for the computer and any running applications to 80%, and then adjust the display's volume.</li> </ul> <p>OR</p> <p>If you're using an external audio system, set the volume for the computer, any running applications and the display to 80%, and then adjust the external audio system's volume.</p>

Symptom	Troubleshooting steps
There is a whine or buzzing sound coming from the back of the display.	<ul style="list-style-type: none"><li>• Be aware that these sounds are normal. All displays emit some electrical noise. Such sounds may be more noticeable with some displays than with others. However, if you hear noise from the front of the display, further investigation is required.</li><li>• Connect all devices to the same power outlet or power bar.</li></ul>

## Touch isn't working as expected

Symptom	Troubleshooting steps
The display doesn't respond to touch.	<ul style="list-style-type: none"><li>• Make sure <a href="#">SMART Product Drivers 12.14</a> or later are installed and running on any connected computers.</li><li>• Make sure the USB cable between the display and the computer doesn't exceed the supported maximum cable length. See <i>Connecting room computers and guest laptops</i> on page 22.</li><li>• Make sure any connected computers have detected the display's USB connection and <a href="#">SMART Product Drivers 12.14</a> or later is installed.</li><li>• On Windows computers, open Device Manager and make sure there is no red X or yellow explanation mark (!) over the display's icon.</li><li>• On Mac computers, open System Information and make sure there are no error messages in the display's row.</li><li>• For Mac computers with macOS Mojave, see <a href="#">How to resolve issues with installing and using SMART Learning Suite software on macOS Mojave</a>.</li></ul>
The display responds to touch intermittently. OR When you touch the screen, the pointer doesn't appear in the correct place.	<ul style="list-style-type: none"><li>• Restart the display. <i>See <a href="#">Turning off, turning on, and resetting the display</a> on page 35.</i></li><li>• Confirm with the installers that the computer is connected to the display with only a single cable.</li><li>• Remove infrared sources, such as incandescent or arc lights, desk lamps, and infrared audio devices, or move the display to another location in the room.</li><li>• Remove any USB extenders to help isolate the USB cable.</li><li>• <a href="#">Update the firmware</a>.</li></ul>



## The pens and erasers aren't working as expected

Symptom	Troubleshooting steps
The display doesn't respond to touch or writing with a pen.	<ul style="list-style-type: none"><li>• Make sure any connected computers have detected the display's USB connection and <a href="#">SMART Product Drivers 12.14</a> or later is installed.</li><li>• On Windows computers, open Device Manager and make sure there is no red X or yellow explanation mark (!) over the display's icon.</li><li>• On Mac computers, open System Information and make sure there are no error messages in the display's row.</li><li>• Reinstall or update <a href="#">SMART Product Drivers and SMART Ink</a> on any connected computers.</li><li>• Make sure SMART Product Drivers is 12.14 or later.</li></ul>
The display responds to touch but not to writing with a pen.	<ul style="list-style-type: none"><li>• Reinstall or update <a href="#">SMART Product Drivers and SMART Ink</a> on any connected computers.</li><li>• Make sure SMART Product Drivers is 12.14 or later.</li></ul>
When you write on the screen, the ink appears in the wrong place. OR Writing is intermittent. OR Ink disappears as you write.	<ul style="list-style-type: none"><li>• Restart the display. <i>See <a href="#">Turning off, turning on, and resetting the display</a> on page 35.</i></li><li>• Confirm with the installers that the computer is connected to the display with only a single cable.</li><li>• Make sure <a href="#">SMART Product Drivers and SMART Ink</a> are installed and running on any connected computers.</li><li>• Remove infrared sources, such as incandescent or arc lights, desk lamps, and infrared audio devices, or move the display to another location in the room.</li><li>• <a href="#">Update the firmware.</a></li></ul>
You can't write or draw in Microsoft Office.	<ul style="list-style-type: none"><li>• Make sure Microsoft Office 2013 or later is installed.</li><li>• Reinstall or update <a href="#">SMART Product Drivers and SMART Ink</a>.</li></ul>

## iQ apps aren't working as expected

Symptom	Troubleshooting steps
iQ apps aren't working as expected.	See <a href="#">Troubleshooting the iQ experience</a> .

## SMART software on connected computers isn't working as expected

Symptom	Troubleshooting steps
SMART Notebook software isn't working as expected.	See <a href="#">Troubleshooting SMART Notebook</a> .

Symptom	Troubleshooting steps
SMART Learning Suite Online isn't working as expected.	See <a href="#">Troubleshooting common issues in SMART Learning Suite Online</a> .
SMART Ink isn't working as expected.	See <a href="#">Troubleshooting SMART Ink</a> .
SMART Product Drivers isn't working as expected.	See <a href="#">Troubleshooting SMART Product Drivers</a> .

## The SMART PCM8 OPS PC isn't working as expected

Symptom	Troubleshooting steps
The on-screen keyboard isn't visible.	<ul style="list-style-type: none"><li>• Enable the on-screen keyboard:<ol style="list-style-type: none"><li>a. Select <b>Start &gt; Settings</b>. The <i>Settings</i> window appears.</li><li>b. Tap <b>Ease of Access</b>, and then tap <b>Keyboard</b>.</li><li>c. Enable <b>Use the On-Screen Keyboard</b>.</li></ol>For more information, see <a href="#">Use the On-Screen Keyboard (OSK) to type</a>.</li><li>• Enable tablet mode:<p>Tap the notification icon  in the bottom-right corner of the screen and then select <b>Tablet mode</b>.</p>For more information, see <a href="#">Turn tablet mode on or off</a>.</li></ul>
Windows 10 or the OPS PC module are unresponsive.	<ul style="list-style-type: none"><li>• Restart the OPS PC module:<ol style="list-style-type: none"><li>a. Press and hold the power button on the OPS PC module.</li><li>b. Wait two minutes.</li><li>c. Press the power button to turn on the OPS PC module.</li></ol></li><li>• If restarting the OPS PC module doesn't resolve the issue, contact SMART support.</li></ul>
There is an issue with Bluetooth.	See <a href="#">Fix Bluetooth problems in Windows 10: FAQ</a> .
There is an issue with the network connection.	See <a href="#">Fix network connection issues in Windows</a> .

## Contacting your reseller for additional support

If an issue you're experiencing with the display persists or isn't covered in this chapter or the knowledge base, contact your authorized SMART reseller ([smarttech.com/where](http://smarttech.com/where)) for support.

CHAPTER 5  
**TROUBLESHOOTING**

Your reseller might ask you for the display's serial number. The serial number is on a label located on the left side of the display (pictured).

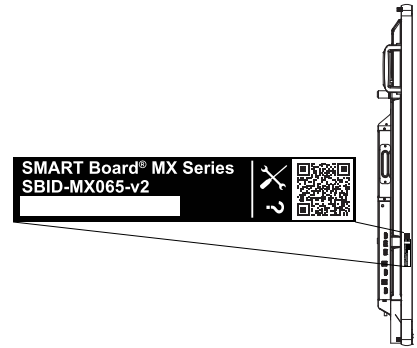

---

**TIPS**

- Scan the QR code on the label to view the SMART Board MX (V2) series interactive display support pages on the SMART website.
  - You can also find the serial number in the iQ settings (see *Appendix A: Adjusting iQ settings* on page 51).
-



## Appendix A

# Adjusting iQ settings

Network settings .....	51
Personalization .....	52
Application settings .....	52
System settings .....	54

You can access settings using the  icon on the Home screen.

### NOTE

Settings can be set at the user level or system wide. If a setting can be selected at the user level, the setting changes depending on which user is signed in. If the setting can be selected at the system level, all users have the same setting. See the settings for more information.

## Network settings

Option	Values	Function	Notes	User or system setting
• Wi-Fi	[N/A]	Shows which wireless network the display is connected to.	Turn on Wi-Fi to discover networks.	System
• [Wi-Fi network name]	[N/A]	Shows information about the wireless network the display is connected to.	[N/A]	System
• Wi-Fi MAC address	[N/A]	Shows MAC address for the network the display is connected to.	[N/A]	System
• Wi-Fi IP address	[N/A]	Shows IP address for the network the display is connected to.	[N/A]	System
▶ <b>SMART iQ Ethernet</b>				
• Static IP	[N/A]	Shows information about the network the display is connected to.	[N/A]	System

APPENDIX A  
ADJUSTING IQ SETTINGS

Option	Values	Function	Notes	User or system setting
<ul style="list-style-type: none"><li>Proxy</li></ul>	[N/A]	Shows information about the network the display is connected to.	[N/A]	System
<ul style="list-style-type: none"><li>MAC address</li></ul>	[N/A]	Shows information about the network the display is connected to.	[N/A]	System
<ul style="list-style-type: none"><li>Bluetooth</li></ul>	[N/A]	Shows information about the display's Bluetooth	[N/A]	System
<b>▶ SMART Cloud</b>				
<ul style="list-style-type: none"><li>SMART Cloud Status</li></ul>	[Status]	Shows the status of SMART Cloud	[N/A]	System
<ul style="list-style-type: none"><li>Service Region</li></ul>	[N/A]	Shows the service region	[N/A]	System

## Personalization

### NOTE

If iQ is disabled, Personalization settings are not available.

Option	Values	Function	Notes	User or system setting
<ul style="list-style-type: none"><li>Wallpaper</li></ul>	[Wallpapers]	Select the wallpaper that appears in the background.	<ul style="list-style-type: none"><li>1920 × 1080 images work best</li><li>The display supports .png and .jpg file formats</li><li>See <a href="#">Changing the display's wallpaper</a>.</li></ul>	User

## Application settings

### NOTE

If iQ is disabled, Application settings are not available.

APPENDIX A  
**ADJUSTING IQ SETTINGS**

Option	Values	Function	Notes	User or system setting
<b>▶ Launcher</b>				
• SMART Notebook Player	On Off	Enables or disables SMART Notebook Player in the Apps Library	[N/A]	User
• Browser	On Off	Enables or disables Browser in the Apps Library	[N/A]	User
• Screen Share	On Off	Enables or disables Screen Share in the Apps Library	[N/A]	User
<b>▶ SMART Whiteboard</b>				
• Whiteboard Storage	[N/A]	[N/A]	[N/A]	User
• Library	On Off	Enables or disables saving kapp Whiteboard sessions	[N/A]	User
• Save Whiteboards in Library	For 1 week For 1 Month Indefinitely	Sets how long kapp Whiteboard sessions are saved	[N/A]	User
<b>• Mobile App</b>				
• Saving Whiteboards	On Off	Enables or disables the Capture function in the SMART kapp app	If this option is off, the QR code is not visible. The SMART kapp app is unable to connect to the display and your mobile device is unable to save snapshots of the display in the app.	User
• Sharing Whiteboards	On Off	Enables or disables the Invite function on the SMART kapp app	If this option is off, you're unable to invite people to your session.	User
<b>• Annotation</b>				
• Enable annotation layers	On Off	Enables or disables annotations on the Browser and Screen Share app	[N/A]	User
<b>▶ Screen Share</b>				
• Require Permission	On Off	Enables or disables automatic connection from a device sharing its screen.	[N/A]	System
• AirPlay	On Off	Enables or disables the AirPlay protocol.	AirPlay is enabled by default.	System

APPENDIX A  
ADJUSTING IQ SETTINGS

Option	Values	Function	Notes	User or system setting
<ul style="list-style-type: none"> <li>Google Cast</li> </ul>	On Off	Enables or disables the Google Cast protocol.	Google Cast is enabled by default.	System
<ul style="list-style-type: none"> <li>Miracast</li> </ul>	On Off	Enables or disables the Miracast protocol.	Miracast is enabled by default.	System
<ul style="list-style-type: none"> <li>Performance Logging</li> </ul>	On Off	SMART Support may ask users to enable Performance Logging to help diagnose issues.	Performance Logging is disabled by default.	System
<ul style="list-style-type: none"> <li>Miracast Connection Handling</li> </ul>	On Off	When enabled, the display disconnects from the network when a device shares its screen using Miracast.	SMART recommends enabling this setting for areas with high network saturation or busy networks.  <b>! IMPORTANT</b>  When this is enabled, devices using AirPlay and GoogleCast can't connect.	System
<ul style="list-style-type: none"> <li>Reset Screen Share</li> </ul>	[N/A]	Closes and restarts the Screen Share app and its discovery services	You can restart Screen Share as a troubleshooting step if a mobile device or computer can't find or connect to the display.	System

## System settings

Option	Values	Function	Notes	User or system setting
<p>▸ <b>Display</b></p> <ul style="list-style-type: none"> <li>Screen Adjustment</li> </ul>				



APPENDIX A  
ADJUSTING IQ SETTINGS

Option	Values	Function	Notes	User or system setting
<ul style="list-style-type: none"> <li>Brightness</li> </ul>	0–100	Sets the overall brightness of the image	<p><b>NOTE</b></p> <p>If Auto Brightness is enabled and the brightness slider is moved quickly left or right, the image on the screen flickers. This will be fixed in a future system software release.</p>	System
<ul style="list-style-type: none"> <li>Auto Brightness</li> </ul>	On On	Enables or disables the automatic adjustment of image brightness depending on the ambient light level	[N/A]	System
<ul style="list-style-type: none"> <li>HDMI Output</li> </ul>				
<ul style="list-style-type: none"> <li>Default resolution</li> </ul>	Auto 4K60 1080p60 720p60 640x480p60	Sets the HDMI out resolution	[N/A]	System
<p>▶ <b>Date &amp; Time</b></p>				
<ul style="list-style-type: none"> <li>Automatic Date &amp; Time</li> </ul>	On Off	Sets the display's date and time automatically	Configure the network to allow Network Time Protocol (NTP) requests to internet time servers. See <a href="#">Connecting to a network</a> .	System
<ul style="list-style-type: none"> <li>Date</li> </ul>	[N/A]	Sets the display's date	Disable <b>Automatic date &amp; time</b> to set the date manually.	System

APPENDIX A  
**ADJUSTING IQ SETTINGS**

Option	Values	Function	Notes	User or system setting
• Time	[N/A]	Sets the display's time	Disable <b>Automatic date &amp; time</b> to set the time manually.	System
• 24 Hour Time	On Off	Shows the display's time using the 24-hour clock	[N/A]	User
• Time Zone	[N/A]	Sets the display's time zone	[N/A]	System
• Language	[Languages]	Sets the language for the settings menu	[N/A]	User
• Country	[Countries]	Sets the display's country	[N/A]	System
<b>▶ Diagnostics</b>				
• Factory Reset	[N/A]	Resets all options to their default values	Only administrators should reset the display.	[N/A]
• Save Log File	[N/A]	Copy diagnostic logs to a USB drive	[N/A]	[N/A]
• Improve the Experience	On Off	Sends usage statistics and error reports to SMART	[N/A]	User
• Support ID	[Support ID]	Shows the support ID associated with the display	[N/A]	[N/A]
<b>▶ Security</b>				
• Lock Down Settings	[N/A]	Lock down the display's settings using a certificate on a USB drive.	See <a href="#">Locking down the Settings app</a> for more information.	System
• Install certificates	[N/A]	Install certificates to connect to a network	[N/A]	System
<b>• Clean up</b>				
• Clean Up Policy	Disabled Manually reset with the <b>Clean Up</b> button in the launcher 1 hour 2 hours 3 hours 1 day	Sets how often the display cleans up	[N/A]	User

APPENDIX A  
**ADJUSTING IQ SETTINGS**

Option	Values	Function	Notes	User or system setting
<ul style="list-style-type: none"> <li>Clean Up the whiteboard</li> </ul>	[N/A]	Saves the Whiteboard session to the Library and erases the Whiteboard	[N/A]	User
<ul style="list-style-type: none"> <li>Clean Up the browser</li> </ul>	[N/A]	Closes the browser tabs and clears the history, cache and cookies	[N/A]	User
<ul style="list-style-type: none"> <li>Clean Up other applications</li> </ul>	[N/A]	Closes open applications	[N/A]	User
<b>▶ Auto Update</b>				
<ul style="list-style-type: none"> <li>Updates Channel</li> </ul>	Stable Channel Beta Channel	Sets which iQ system software updates the display receives	When switching from the Beta channel to the Stable channel, a factory reset occurs. See page 56 for more information about factory reset.  For more information about the Beta Channel, see <a href="#">Switching to the Beta channel.</a>	System
<ul style="list-style-type: none"> <li>Check for Updates Now</li> </ul>	[N/A]	Checks for updates to the system software  <b>NOTE</b>  The display must be connected to the internet to check for system software updates or a USB drive with the system software update file is connected to the display.	If an update is available, the text changes to <b>Apply update now.</b>	[N/A]
<b>▶ About</b>				
<ul style="list-style-type: none"> <li>Board Name</li> </ul>	[N/A]	Select a name for your display	[N/A]	System
<ul style="list-style-type: none"> <li>Help</li> </ul>	[N/A]	Shows the SMART support site	[N/A]	[N/A]
<ul style="list-style-type: none"> <li>Send Feedback</li> </ul>	[N/A]	Send feature request to SMART	[N/A]	[N/A]
<ul style="list-style-type: none"> <li>Board Details</li> </ul>	[N/A]	[N/A]	[N/A]	[N/A]
<ul style="list-style-type: none"> <li>Build Number</li> </ul>	[N/A]	Shows the iQ system software's version number	[N/A]	[N/A]
<ul style="list-style-type: none"> <li>Serial Number</li> </ul>	[N/A]	Shows the display's serial number	[N/A]	[N/A]

APPENDIX A  
**ADJUSTING IQ SETTINGS**

Option	Values	Function	Notes	User or system setting
• Firmware Details	[N/A]	[N/A]	[N/A]	[N/A]
• Touch controller version	[N/A]	Shows the display's touch controller version	[N/A]	[N/A]
• Scaler version	[N/A]	Shows the display's scaler version	[N/A]	[N/A]
• Legal Information	[N/A]	[N/A]	[N/A]	[N/A]
• End User License Agreement	[N/A]	Shows the SMART end user license agreement	[N/A]	[N/A]
• Open Source Licenses	[N/A]	Shows the open source licenses	[N/A]	[N/A]
• SMART Intellectual Property	[N/A]	Shows the SMART intellectual property information	[N/A]	[N/A]

## Appendix B

# Managing the display using RS-232

Configuring the computer's serial interface settings .....	60
Power states .....	61
Commands and responses .....	61
Power state commands .....	63
Input commands .....	64
Brightness commands .....	64
Freeze commands .....	64
Screen shade commands .....	64
Volume commands .....	65
Mute commands .....	65
Firmware version commands .....	65
Serial number commands .....	65
Part number commands .....	66
Resolving issues with managing the display using RS-232 .....	66

You can connect an RS-232 cable from a computer's serial output to the display's RS-232 in connector to remotely select video inputs, turn the display on or off, and get information about the display's current settings, such as volume and power state.

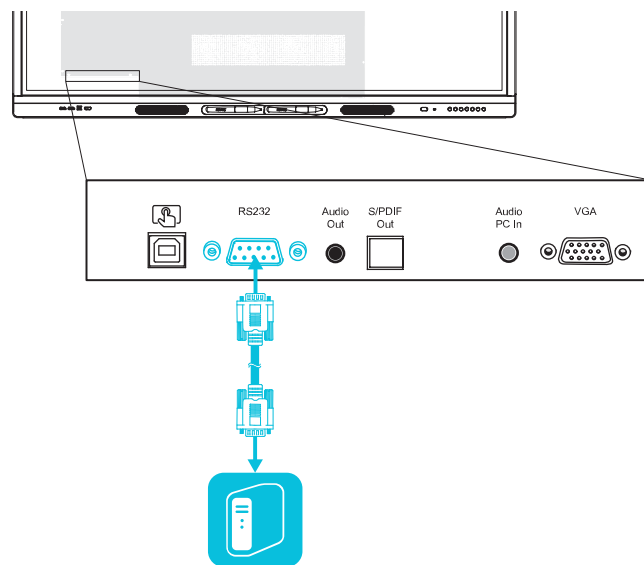

---

**!** **IMPORTANT**

Use only a standard RS-232 cable. Do not use a null modem cable. Null modem cables typically have ends of the same type.

---

**TIP**

SMART also offers SMART Remote Management cloud-based device-management software, which you can use to manage SMART Board interactive displays with iQ and devices running Windows, Chrome™ OS, Android™, and iOS operating systems. For more information, see [SMART Remote Management](#).

---

## Configuring the computer's serial interface settings

Configure the computer's serial interface before sending commands to the display.

### To configure the computer's serial interface

1. Turn on the display.
2. Turn on the computer, and then start the serial communications program or terminal emulation program.
3. Activate local echo.
4. Configure the serial interface settings using the following values, and then press ENTER.

<b>Baud rate</b>	19200
<b>Data length</b>	8
<b>Parity bit</b>	None
<b>Stop bit</b>	1

A command prompt (>) appears on the following line, and the display can now accept commands from the computer.

---



**NOTE**

If no message appears or an error message appears, the serial interface isn't configured correctly. Repeat steps 3 and 4.

---

## Power states

The display has six power states:

Power state	Description
ON	The display is in normal operating mode.
READY	The screen is off, but the display is ready to turn on when the following occurs: <ul style="list-style-type: none"><li>• A user presses the <b>Power</b> button  on the convenience panel or the remote control.</li><li>• You send the <code>set powerstate=on</code> command.</li></ul>
STANDBY	The screen is off, and the display is in a low power state. The display enters READY or ON state when the following occurs: <ul style="list-style-type: none"><li>• A user presses the <b>Power</b> button  on the front control panel or the remote control.</li><li>• You send the <code>set powerstate=standby</code> command.</li></ul>
POWERSAVE	The screen is off, and the display is a very low power state. The display enters READY or ON state when the following occurs: <ul style="list-style-type: none"><li>• A user presses the <b>Power</b> button  on the front control panel or the remote control.</li><li>• You send the <code>set powerstate=powersave</code> command.</li></ul>
UPDATEON	The display is updating firmware. Do not turn off the display.
UPDATEREADY	The display is updating firmware while the screen is off. Do not turn off the display.

With the exception of `get powerstate` and `set powerstate`, commands are available only when the display is in READY or ON power state.

## Commands and responses

To access display information or to adjust display settings using the room control system, type commands after the command prompt (`>`) and wait for the response from the display.

### CORRECT

```
>get volume
volume=55
>
```

If you type a command that the room control system doesn't recognize, you will receive an invalid command response.

In the example below, the user used `--50` instead of `-50`.

**INCORRECT**

```
>set volume=-50
invalid cmd: setvolume=-50
>
```

---

**NOTES**

- Use ASCII formatted commands.
  - Commands aren't case-sensitive and extra spacing is ignored.
  - You can use the BACKSPACE key when typing commands.
  - Review each entry carefully before you press ENTER.
  - Don't send another command until you receive the response and the next command prompt.
- 

**To retrieve a setting's current value**

Use a `get` command.

This example shows how to get the volume:

```
>get volume
volume=55
>
```

**To assign a value to a setting**

Use a `set` command.

This example sets the volume to 65:

```
>set volume=65
volume=65
>
```



### To increase or decrease the value of a setting

Use the set command to increase or decrease the value by a designated number.

This example increases the volume by 5:

```
>set volume+5  
volume=70  
>
```

This example decreases the volume by 15:

```
>set volume-15  
volume=55  
>
```

## Power state commands

Get command	Set command	Response
get powerstate	<p>set powerstate[Value] Where [Value] is one of the following:</p> <ul style="list-style-type: none"><li>• =on</li><li>• =ready</li><li>• =standby</li><li>• =powersave</li></ul> <hr/> <p><b>NOTE</b></p> <p>If the display is in UPDATEON or UPDATEREADY state, it might not change power states after receiving the command.</p>	<p>powerstate=[Value] Where [Value] is one of the following:</p> <ul style="list-style-type: none"><li>• on</li><li>• ready</li><li>• standby</li><li>• powersave</li><li>• updateon</li><li>• updateready</li></ul>

## Input commands

Get command	Set command	Response
get input	set input[Value] Where [Value] is one of the following: <ul style="list-style-type: none"> <li>• =hdmi1</li> <li>• =hdmi2</li> <li>• =hdmi3</li> <li>• =vga1</li> <li>• =ops1</li> </ul>	input=[Value] Where [Value] is one of the following: <ul style="list-style-type: none"> <li>• hdmi1</li> <li>• hdmi2</li> <li>• hdmi3</li> <li>• vga1</li> <li>• ops1</li> <li>• none</li> </ul>

## Brightness commands

Get command	Set command	Response
get brightness	set brightness[Value] Where [Value] is one of the following: <ul style="list-style-type: none"> <li>• +[Value]</li> <li>• -[Value]</li> <li>• =[5-100]</li> </ul>	brightness=[Value] Where [Value] is a number between 5 and 100

## Freeze commands

Get command	Set command	Response
get videofreeze	set videofreeze[Value] Where [Value] is one of the following: <ul style="list-style-type: none"> <li>• =on</li> <li>• =off</li> </ul>	videofreeze=[Value] Where [Value] is one of the following: <ul style="list-style-type: none"> <li>• on</li> <li>• off</li> </ul>

## Screen shade commands

Get command	Set command	Response
get screenshade	set screenshade[Value] Where [Value] is one of the following: <ul style="list-style-type: none"> <li>• =on</li> <li>• =off</li> </ul>	screenshade=[Value] Where [Value] is one of the following: <ul style="list-style-type: none"> <li>• on</li> <li>• off</li> </ul>

## Volume commands

Get command	Set command	Response
get volume	set volume[Value] Where [Value] is one of the following: <ul style="list-style-type: none"><li>• +[Value]</li><li>• -[Value]</li><li>• =[0-100]</li></ul>	volume=[Value] Where [Value] is a number between 0 and 100

## Mute commands

Get command	Set command	Response
get mute	set mute[Value] Where [Value] is one of the following: <ul style="list-style-type: none"><li>• =on</li><li>• =off</li></ul>	mute=[Value] Where [Value] is one of the following: <ul style="list-style-type: none"><li>• on</li><li>• off</li></ul>

## Firmware version commands

Get command	Response
get fwversion	fwversion=[Value] Where [Value] is the firmware version.

## Serial number commands

Get command	Response
get serialnum	serialnum=[Value] Where [Value] is the serial number.

## Part number commands

Get command	Response
get partnum	partnum=[Value] Where [Value] is the part number, including the revision.

## Resolving issues with managing the display using RS-232

The following table presents common issues with managing the display using RS-232 and explains how to resolve them:

Symptom	Troubleshooting steps
Managing the display using RS-232 isn't working as expected.	<ul style="list-style-type: none"><li>• Make sure all the cable connections are secure.</li><li>• Restart the display and the remote management system. <i>See Turning off, turning on, and resetting the display on page 35.</i></li><li>• Configure the serial interface settings. <i>See Configuring the computer's serial interface settings on page 60.</i></li></ul>
You're experiencing other issues with managing the display using RS-232, or the previous steps don't resolve the issue.	<i>See Chapter 5: Troubleshooting on page 43.</i>

## Appendix C

# Hardware environmental compliance

SMART Technologies supports global efforts to ensure that electronic equipment is manufactured, sold and disposed of in a safe and environmentally friendly manner.

## Waste Electrical and Electronic Equipment and Battery regulations (WEEE and Battery Directives)

Electrical and electronic equipment and batteries contain substances that can be harmful to the environment and to human health. The crossed-out wheeled bin symbol indicates that products should be disposed of in the appropriate recycling stream and not as regular waste. See [smarttech.com/compliance](https://smarttech.com/compliance) for more information. 

## Batteries

The remote control contains alkaline batteries. The display and the OPS PC contain CR2032 coin cells. Recycle or dispose of batteries properly.

### Perchlorate material

The display and OPS PC coin cells contain perchlorate material. Special handling may apply. See [dtsc.ca.gov/hazardouswaste/perchlorate](https://dtsc.ca.gov/hazardouswaste/perchlorate).

## More information

See [smarttech.com/compliance](https://smarttech.com/compliance) for more information.





**SMART TECHNOLOGIES**

[smarttech.com/support](https://smarttech.com/support)

[smarttech.com/contactsupport](https://smarttech.com/contactsupport)

[smarttech.com/kb/171555](https://smarttech.com/kb/171555)