

# SMART Board® M600 series

Interactive whiteboard

**User's guide**

*For models M680, M685, M680V and M685V*

**SMART**®

# Product registration

If you register your SMART product, we'll notify you of new features and software upgrades.

Register online at [smarttech.com/registration](http://smarttech.com/registration).

Keep the following information available in case you need to contact SMART Support.

Serial number:

---

Date of purchase:

---

#### **FCC warning**

This equipment has been tested and found to comply with the limits for a Class A digital device, pursuant to Part 15 of the FCC Rules. These limits are designed to provide reasonable protection against harmful interference when the equipment is operated in a commercial environment. This equipment generates, uses and can radiate radio frequency energy and, if not installed and used in accordance with the manufacturer's instructions, may cause harmful interference to radio communications. Operation of this equipment in a residential area is likely to cause harmful interference in which case the user will be required to correct the interference at his own expense.

#### **Trademark notice**

SMART Board, SMART Notebook, DVIT, SMART Ink, smarttech, the SMART logo and all SMART taglines are trademarks or registered trademarks of SMART Technologies ULC in the U.S. and/or other countries. Microsoft and Windows are either registered trademarks or trademarks of Microsoft Corporation in the U.S. and/or other countries. Mac is a trademark of Apple Inc., registered in the U.S. and other countries. All other third-party product and company names may be trademarks of their respective owners.

#### **Copyright notice**

© 2013 SMART Technologies ULC. All rights reserved. No part of this publication may be reproduced, transmitted, transcribed, stored in a retrieval system or translated into any language in any form by any means without the prior written consent of SMART Technologies ULC. Information in this manual is subject to change without notice and does not represent a commitment on the part of SMART.

This product and/or use thereof covered by one or more of the following U.S. patents: [smarttech.com/patents](http://smarttech.com/patents). Contents are subject to change without notice.

09/2013

# Important information

Before you install and use your SMART Board® M600 series interactive whiteboard, read and understand the safety warnings and precautions in this user's guide and the included warnings document. The included warnings document describes the safe and correct operation of your SMART Board interactive whiteboard and its accessories, helping you to prevent injuries and equipment damage.



## **NOTE**

In this document, the term “interactive whiteboard” refers to your interactive whiteboard and its accessories and options.



# Contents

<b>Important information</b> .....	<b>i</b>
<b>Chapter 1: Introducing your SMART Board M600 series interactive whiteboard</b> .....	<b>1</b>
Introduction .....	1
Features .....	2
Computer requirements .....	2
How does your SMART Board interactive whiteboard work? .....	3
Installation tips .....	4
Accessories and replacement parts .....	5
<b>Chapter 2: Connecting your interactive whiteboard to a computer</b> .....	<b>7</b>
Overview .....	7
Installing SMART Product Drivers .....	8
Calibrating your interactive whiteboard .....	8
Orienting your interactive whiteboard .....	9
<b>Chapter 3: Using your interactive whiteboard</b> .....	<b>11</b>
Using the Pen Tray .....	12
Using the Floating Tools toolbar .....	14
Using gestures, dual touch and dual write .....	15
Updating your SMART software .....	19
<b>Chapter 4: Maintenance and troubleshooting</b> .....	<b>21</b>
Tips for trouble-free performance .....	21
Cleaning your interactive whiteboard .....	22
General troubleshooting .....	23
Transporting your interactive whiteboard .....	29
Contacting SMART Support .....	29
<b>Appendix A: Hardware environmental compliance</b> .....	<b>31</b>
Waste Electrical and Electronic Equipment and Battery regulations (WEEE and Battery Directives) .....	31
Batteries .....	31
<b>Index</b> .....	<b>33</b>



## Chapter 1

# Introducing your SMART Board M600 series interactive whiteboard

Introduction .....	1
Features .....	2
Feature highlights .....	2
Pen tray .....	2
DViT technology .....	2
Multitouch gestures .....	2
Dual touch and dual write .....	2
Durable surface .....	2
Computer requirements .....	2
How does your SMART Board interactive whiteboard work? .....	3
Windows and Mac computers .....	3
Installation tips .....	4
Extending your USB cable .....	4
Avoiding electromagnetic interference (EMI) .....	5
Accessories and replacement parts .....	5

---

## Introduction

Your SMART product is a wall-mounted, front projection interactive whiteboard. It enables you to do everything that you can do at your computer—open and close applications, scroll through files, teach collaborative lessons, create new documents or edit existing ones, visit websites, play video clips and more—by touching the interactive surface with your finger or the included pen. When you connect your interactive whiteboard to a computer and a projector, your computer image displays on the interactive surface. You can write over any application in digital ink, and then save these notes to a file in SMART Notebook™ collaborative learning software for future reference and distribution.

Your SMART Board M600 series interactive whiteboard is a full-speed USB 2.0 device with an external power supply. Your interactive whiteboard receives power from a wall outlet through the included country-specific power supply and cable.

## CHAPTER 1

Introducing your SMART Board M600 series interactive whiteboard

# Features

Your SMART Board M600 series interactive whiteboard is durable and reliable. It features a rugged, hardened interactive surface, two damage-resistant pens and SMART's proprietary DVIT® (Digital Vision Touch) technology. The SMART Board M680 interactive whiteboard measures 195.6 cm (77") diagonally and has a 4:3 aspect ratio, while the M685 interactive whiteboard measures 221 cm (87") diagonally and has a 16:10 aspect ratio.

## Feature highlights

### Pen tray

The pen tray connects to the interactive whiteboard and holds the two included pens. It features color select buttons to change digital ink colors. The on-screen keyboard, the right-click and the orient features are also accessible with pen tray buttons.

SMART Board M680V and M685V interactive whiteboards feature a durable pen ledge that holds the two included pens.

### DViT technology

Four digital cameras, one in each of the interactive whiteboard's corners, track the position of your finger or the pen as it moves across the interactive surface.

### Multitouch gestures

Your interactive whiteboard supports multitouch gestures (Windows® and Mac only). You can use two fingers to resize an object on a page, to zoom in and out, to rotate an object and more.

### Dual touch and dual write

Your interactive whiteboard supports dual touch (Windows and Mac only). Two users can use their fingers to simultaneously perform mouse functions or write on the interactive whiteboard.

### Durable surface

The interactive surface is scratch-resistant, dent-resistant and optimized for projection.

# Computer requirements

To successfully power your interactive whiteboard and run SMART Product Drivers, your computer must meet certain minimum requirements. For a complete list of computer requirements, go to [smarttech.com/downloads](http://smarttech.com/downloads) and browse to the latest SMART Notebook software release notes applicable to your operating system.



## How does your SMART Board interactive whiteboard work?

Your interactive whiteboard functions as an input device for your computer, enabling you to work in any application on your connected computer. You need two additional components to use your interactive whiteboard: a computer and a digital projector. These components work together as follows:

- Your computer runs an application and sends the image to your projector.
- Your projector casts the image onto your interactive whiteboard.
- Your interactive whiteboard detects contact with its screen and sends each contact point to the connected computer.

Use the pen tray buttons to select different tools. For example, press the left-click button so that when you touch your interactive whiteboard's surface, the touch of your finger becomes a mouse click and you can control your computer from your interactive whiteboard. When you pick up a pen and press one of the color buttons, digital ink appears, enabling you to write over your desktop or any open application.

When you install SMART Product Drivers, a Floating Tools toolbar appears on your desktop. You can change pen settings such as the transparency, color and width of the ink. You can then save your notes to a file in SMART Notebook software. You can also customize other tools, such as the width of the eraser tool you use to erase your notes.

### Windows and Mac computers

SMART Notebook collaborative learning software includes SMART Ink™ and SMART Product Drivers. SMART Ink works with SMART Product Drivers to enable you to write on your screen in digital ink using your interactive product's pen or your finger.

SMART Ink starts automatically when you start your computer, and the SMART Ink toolbar appears in the title bar of each open window on your computer.



#### NOTE

SMART Notebook software doesn't display the SMART Ink toolbar because it includes its own ink tools that you can use to write directly in your file.

You can press **SMART Ink** ▼ to select ink properties and to perform common tasks such as capturing your notes.

## CHAPTER 1

Introducing your SMART Board M600 series interactive whiteboard

SMART Ink includes SMART Ink Notes which enable you to write in digital ink anywhere on your desktop. When you write outside of the open windows on your computer, a SMART Ink Note appears and you can write inside the note.

SMART Ink also includes the SMART Ink Document Viewer, which enables you to view your PDF files and to write over them in digital ink.

For more information on using SMART Ink, see the *SMART Ink user's guide* ([smarttech.com/kb/170191](http://smarttech.com/kb/170191)).

## Installation tips

For the installation instructions for your SMART Board M600 series interactive whiteboard, see the *SMART Board M600 series interactive whiteboard installation guide* ([smarttech.com/kb/170429](http://smarttech.com/kb/170429)). If you purchased a floor stand, wall-mount or an interactive whiteboard system that includes a projector or other components, refer to the installation documents included with those components.

The optimal mounting height is 196 cm (77") from the floor to the center of the installation brackets. However, consider the general height of your user community when you choose a location for wall-mounting your interactive whiteboard and adjust accordingly.

Ensure that you use the correct mounting hardware for your wall type. You can also order the SMART Board interactive whiteboard [hardware kit](#) (Part No. 1020342) from your authorized SMART reseller.

## Extending your USB cable

The USB cable included with your SMART Board M600 series interactive whiteboard is within the limit defined by the USB standard for maximum length. Your interactive whiteboard includes a 5 m (16') USB cable.



### IMPORTANT

The combined USB cables connected from your interactive whiteboard to your computer should not exceed 5 m (16' 5").

However, if this cable isn't long enough to reach from your computer to your interactive whiteboard, you can use a bus-powered hub, such as the active USB extension cable (Part No. USB-XT) to extend your USB connection.

## CHAPTER 1

Introducing your SMART Board M600 series interactive whiteboard

### Avoiding electromagnetic interference (EMI)

You can take some precautions to prevent EMI to your interactive whiteboard:

- Don't route USB cables parallel to power cables.
- Cross USB cables over power cables at a 90° angle to reduce the risk of interference on the USB cables.
- Don't route USB cables close to common sources of EMI, such as electric motors or fluorescent lighting ballasts.
- Don't bend USB cables sharply.
- Don't use USB plug adapters or passive USB wall plates.

### Accessories and replacement parts

For a full list of items that you can order for your SMART Board M600 series interactive whiteboard, go to [smarttech.com/accessories](http://smarttech.com/accessories).

Contact your authorized SMART reseller ([smarttech.com/wheretobuy](http://smarttech.com/wheretobuy)) to order accessories and standard replacement parts for your SMART Board M600 series interactive whiteboard.



## Chapter 2

# Connecting your interactive whiteboard to a computer

Overview .....	7
Matching your computer's resolution to your projector's resolution .....	7
Installing SMART Product Drivers .....	8
Calibrating your interactive whiteboard .....	8
Orienting your interactive whiteboard .....	9

---

## Overview

Your SMART Board M600 series interactive whiteboard's USB interface enables you to connect your interactive whiteboard to your computer. The included USB cable provides a digital signal from your computer to your interactive whiteboard, and the included power supply provides power to the interactive whiteboard.

### Matching your computer's resolution to your projector's resolution

Ensure that the resolution settings for your projector and computer match. If your computer's resolution doesn't match the projector's native resolution, the image doesn't properly fill the interactive surface and can shimmer or appear distorted.

Set the projector to its optimal image resolution by following the instructions included with your projector, and then set your computer's resolution to match. If you need help changing your computer's resolution, see the instructions included with your operating system.

You might need to adjust your computer's refresh rate to obtain the best results. Set the computer to an initial refresh rate of 60 Hz, and then adjust this rate up or down to determine the ideal refresh rate. For more information on changing your computer's refresh rate, see the instructions included with your operating system.

## Installing SMART Product Drivers

You can install SMART Product Drivers on any computer that meets certain minimum operating specifications by using the software installation DVD included with your SMART product or by downloading it from [smarttech.com/downloads](http://smarttech.com/downloads).

### IMPORTANT

You must install the latest version of SMART Product Drivers on your Windows or Mac computer in order to write in digital ink and to use touch on the interactive whiteboard's surface.

For a complete list of computer requirements, go to [smarttech.com/downloads](http://smarttech.com/downloads) and browse to the latest SMART Notebook release notes applicable to your operating system.

## Calibrating your interactive whiteboard

Digital cameras in the corners of the interactive whiteboard track the position of the pens and your finger on the interactive surface, and then send the information to the SMART software, which interprets this information as mouse clicks, digital ink or ink removal in the appropriate location.

If you haven't used your interactive whiteboard before, you must perform a calibration. This process ensures that the cameras accurately track your finger and the pens on the interactive surface. If the system detects incorrect calibration parameters, a warning bubble may also appear recommending that you perform a calibration.

### To calibrate your interactive whiteboard

1. The first time you connect your interactive whiteboard, press the **Please calibrate the SMART Board interactive whiteboard** pop-up bubble that appears in the bottom right corner of your screen.

If the pop-up doesn't appear, click the SMART software icon in the Windows notification area or Mac Dock and select **SMART Settings > SMART Hardware Settings > Advanced > Calibrate**.

## CHAPTER 2

Connecting your interactive whiteboard to a computer

The calibration window opens.

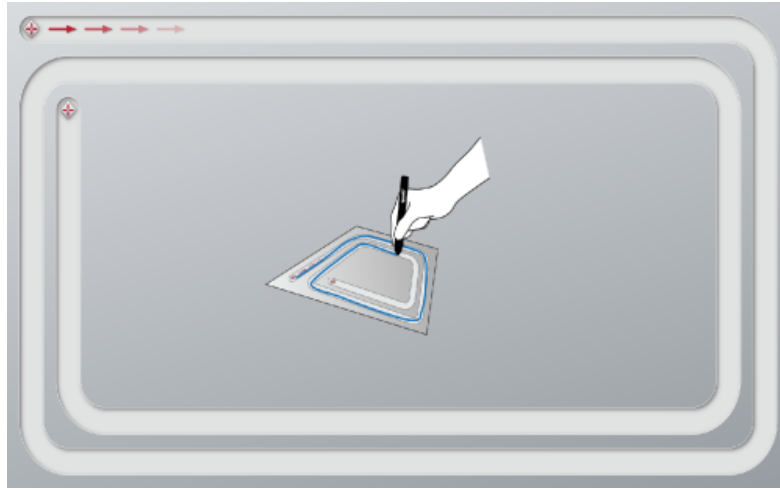

2. With a pen tray pen, press the first target.
3. Keeping the pen on the interactive whiteboard surface, draw along the track until you reach the second target. Keep the pen in the track, regardless of where the digital ink appears.
4. When you reach the second target, lift the pen from the surface.
5. If the calibration window remains open, the cameras require further calibration. Trace your pen around the track a second or even a third time until the calibration window closes.

The orientation screen appears.

## Orienting your interactive whiteboard

After you install SMART Product Drivers on your computer and have completed the calibration procedure, an orientation screen appears. Orienting your interactive whiteboard ensures the greatest possible level of writing and touch accuracy. Orient your interactive whiteboard any time your projector or interactive whiteboard has been moved since you last used it, or whenever the mouse pointer isn't properly aligned with the pen or your finger when you touch the interactive surface.

### **To orient your interactive whiteboard**

1. On the interactive surface, click the **SMART software** icon in the notification area (Windows) or Dock (Mac), and then select **Orient**.

The *Orientation* screen opens.

2. Pick up a pen from the pen tray.

## CHAPTER 2

Connecting your interactive whiteboard to a computer

3. Beginning at the first target on the screen, touch the center of the target firmly with the tip of the pen and hold the pen steady until the target turns green. When you lift the pen the target moves to the next point.
4. Repeat step 3 on all the targets.
5. The *Orientation* screen closes.



## Chapter 3

# Using your interactive whiteboard

Using the Pen Tray .....	12
Pen tray buttons .....	12
Understanding the Select button's status light .....	13
Customizing the pen tray buttons .....	14
Using the Floating Tools toolbar .....	14
Using gestures, dual touch and dual write .....	15
Single-finger gestures .....	16
Selecting and deselecting an object (clicking) .....	16
Displaying menu options (right-clicking) .....	16
Dragging an object or scroll bar .....	16
Double-clicking .....	16
Displaying the next or previous page .....	17
Multi-finger gestures .....	17
Displaying menu options (right-clicking) .....	17
Enlarging an area or object .....	17
Reducing the scale of an object .....	17
Scrolling horizontally or vertically .....	18
Rotating an object .....	18
Best practices for gestures and tools .....	18
Updating your SMART software .....	19

When you touch your interactive whiteboard's surface, the interactive whiteboard registers the horizontal and vertical (or x and y) coordinates on the interactive surface. Your computer's mouse driver interprets those coordinates and moves the pointer to the corresponding point on the projected image.

### **WARNING**

Do not stand (or allow children to stand) on a chair to touch the surface of the SMART Board product. Instead, safely fix the product at the appropriate height on a wall or use a SMART floor stand.

## CHAPTER 3

### Using your interactive whiteboard

To open an application on your interactive whiteboard, press twice consecutively on the application's icon. When you press twice to open an application, it's the same as double-clicking your mouse to open an application on your computer. Similarly, each time you press once on the interactive surface, it's the same as a single left click.

#### NOTE

If necessary, move the mouse or touch the interactive whiteboard's surface or press any key on your keyboard to bring your computer out of standby mode.

## Using the Pen Tray

In addition to providing a convenient place to hold the included pens, the interactive pen tray on your SMART Board M680 or M685 interactive whiteboard has several controls and indicators.

#### NOTE

SMART Board M680V and M685V interactive whiteboards feature a durable pen ledge that holds the two included pens, rather than an interactive pen tray.

### Pen tray buttons

In the center of the pen tray, there are six buttons. The middle four change the color of digital ink that appears when you touch the screen. The buttons on either side of the pen color buttons default to the select (left button) and eraser (right button) functions. These buttons light up to indicate the current selected tool.

The buttons on the right side of the pen tray enable the right-click, on-screen keyboard and orientation functions.

## CHAPTER 3

### Using your interactive whiteboard

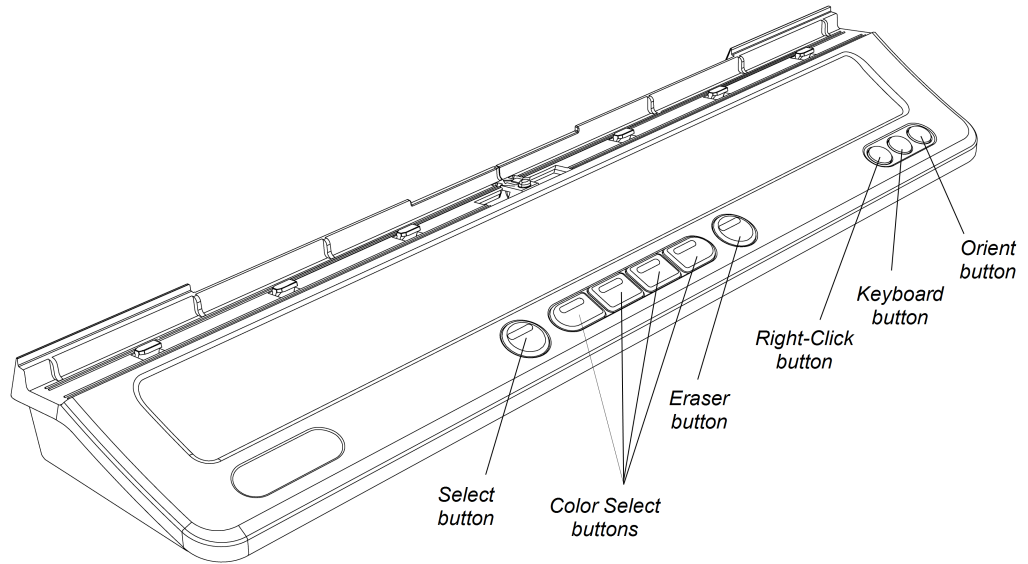

#### Understanding the Select button's status light

The Select button's light also indicates the status of the interactive whiteboard. The Select button's light is solid white when the system is working properly.

The following table shows the Select button's normal states. If the light's behavior doesn't match a state listed here, see *General troubleshooting* on page 23.

Select light state	Meaning
Flashing white	Your interactive whiteboard is receiving power and is communicating successfully with your computer's USB HID driver but SMART Product Drivers isn't installed.

 **NOTE**

In HID mode, interactive whiteboard tools such as the pens are unavailable, but you can move the mouse pointer and perform mouse functions by touching the interactive surface. The Right-Click button on the pen tray might work, depending on the version of operating system you're using. Neither the Keyboard nor the Orient button works in HID mode.

## CHAPTER 3

Using your interactive whiteboard

Select light state	Meaning
Solid white	Your interactive whiteboard is receiving power and is communicating successfully with SMART Product Drivers. When you press another pen tray button, the Select button's light turns off and the light on the button you pressed turns on.
Solid amber	The controller module is in service mode or the firmware is being updated.
Off	You have selected a non-standard digital ink color using SMART Notebook software or SMART Ink, your interactive whiteboard isn't receiving power or your interactive whiteboard is in Standby mode.

### Customizing the pen tray buttons

You can customize your pen tray button settings. For example, you can change line transparency, color and style; you can change the width of the eraser; and you can change the Keyboard and Right-Click button settings so that they perform another action.

#### To customize the pen tray button settings

1. Press the SMART software icon in the Windows notification area or Mac Dock, and then select **SMART Settings**.  
SMART settings opens.
2. Press **SMART Hardware Settings** and select your SMART Board interactive whiteboard.
3. Select **Pen and Button Settings** from the drop-down list, and then select the button you want to customize.
4. Follow the on-screen instructions.

For more information about customizing your settings, open the online Help by pressing the SMART software icon in the Windows notification area or Mac Dock, selecting **Help Center**, and then selecting **SMART Hardware Settings**.

## Using the Floating Tools toolbar

You must install and run SMART Product Drivers on your connected computer to have use of the Floating Tools toolbar. While you work on your interactive whiteboard, the toolbar floats over your desktop and any open application. Use your finger or the provided pen tray pens to select a tool from this customizable toolbar to click, write, erase and open SMART Notebook software on your interactive whiteboard.

For more information on how to use SMART Notebook software, see [smarttech.com/support](http://smarttech.com/support).

## CHAPTER 3

Using your interactive whiteboard

### To open the Floating Tools toolbar

Press the SMART software icon in the notification area (Windows) or Dock (Mac), and then press **Show Floating Tools**.

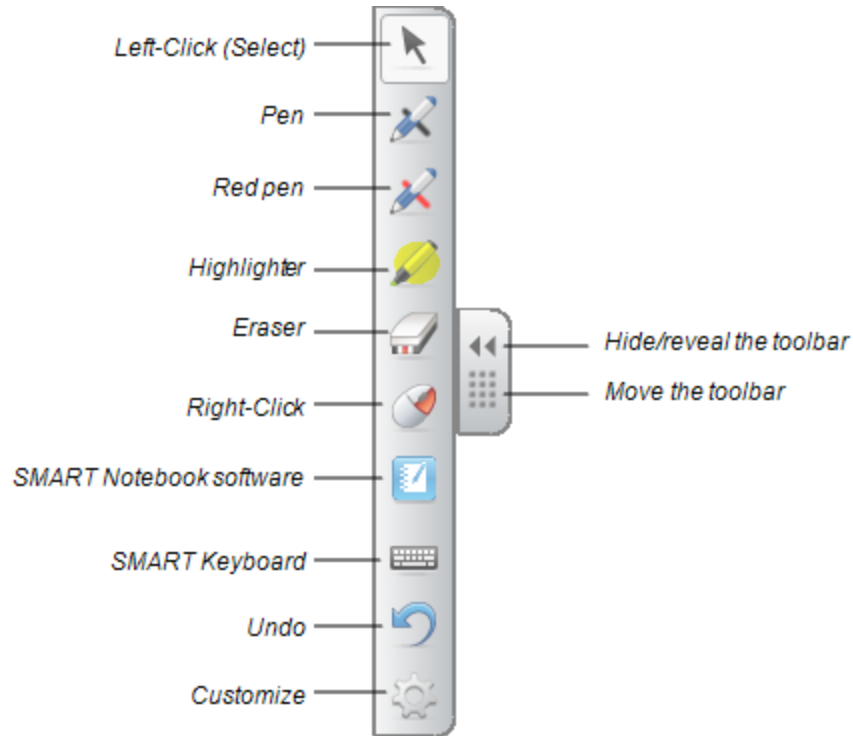

#### NOTES

- SMART Notebook software includes additional toolbars which allow you to control digital ink pens and other drawing tools.
- You can move this toolbar to either the left or right side of the screen.
- You can move this toolbar lower on your screen so younger students can reach it.
- You're unable to rotate this toolbar horizontally.

## Using gestures, dual touch and dual write

Your interactive whiteboard supports multitouch gestures, dual touch and dual write with your Windows or Mac computer. Some gestures might not work in all operating systems.

Multitouch gestures enable you to use pre-determined commands on your interactive whiteboard without using the keyboard or mouse. With a series of two-finger touches on your interactive whiteboard screen, you can navigate pages, change the look of an object and more.

## CHAPTER 3

Using your interactive whiteboard

Dual touch enables two users to touch the interactive whiteboard and to simultaneously perform mouse functions.

Dual write enables two users to use their fingers to write on the interactive whiteboard at the same time.

### Single-finger gestures

You can perform some gestures using one finger, including selecting an object and double-clicking.

Single-finger gestures include the following:

#### Selecting and deselecting an object (clicking)

Quickly press and release the interactive surface to select or deselect an object or option. This performs a standard mouse click.

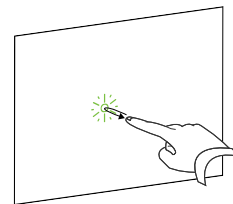

#### NOTE

This gesture starts applications if your operating system is set to start applications on a single click.

#### Displaying menu options (right-clicking)

Press and hold the screen with your finger.

In SMART Notebook software, Windows and Microsoft® Office programs, the right-click menu appears.

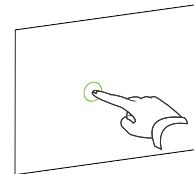

#### Dragging an object or scroll bar

Press and hold an object or scroll bar on the screen. Keep your finger on the screen and slowly move the object or scroll bar. When you reach the position you want, release your finger.

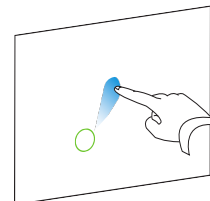

#### Double-clicking

Quickly press and release the interactive surface twice in the same spot. This performs a standard double-click.

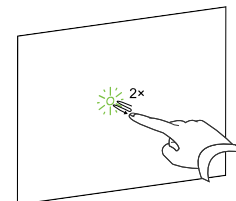

## CHAPTER 3

Using your interactive whiteboard

### NOTE

This gesture starts applications if your operating system is set to start applications on a double-click.

#### Displaying the next or previous page

Press the screen, and then quickly press again directly to the right of that point to display the next page.

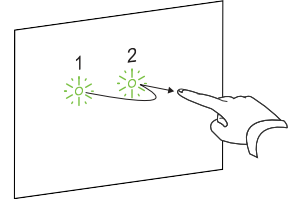

Press the screen, and then quickly press again directly to the left of that point to display the previous page.

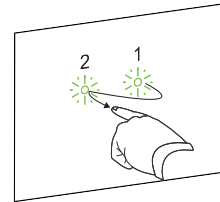

### Multi-finger gestures

You can perform some gestures using two or more fingers, including scaling, scrolling and manipulating objects. Multi-finger gestures include the following:

#### Displaying menu options (right-clicking)

Using two fingers on the same hand, press and hold the screen with your left finger and then press the screen once with your right finger.

Release your left finger from the screen, and then select a menu item with any finger.

#### Enlarging an area or object

Use one finger on each hand to press in the center of the area or object, and then drag your fingers away from each other.

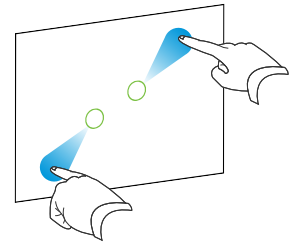

#### Reducing the scale of an object

Use one finger on each hand to press the screen at opposite ends of the area or object, and then drag your fingers toward each other.

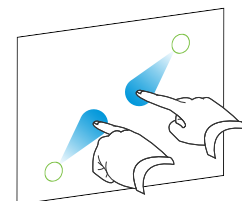

This gesture either scales an object on a page, or the entire page, depending on the application.

## CHAPTER 3

Using your interactive whiteboard

### Scrolling horizontally or vertically

Use two fingers on the same hand to press the screen.

Keeping your fingers on the screen, move up, down, left or right on the page. Release your fingers when you're satisfied with the view.

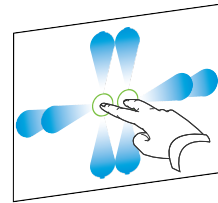

### Rotating an object

Place one finger on either side of the object you want to rotate. Keep one finger stationary, and quickly move your second finger around the object. Release your fingers from the screen when you're satisfied with the angle.

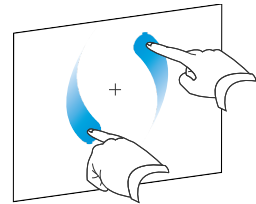

## Best practices for gestures and tools

Follow these guidelines when you use gestures and tools with your interactive product.

Hold your fingers perpendicular (90°) to the interactive surface at the contact point.

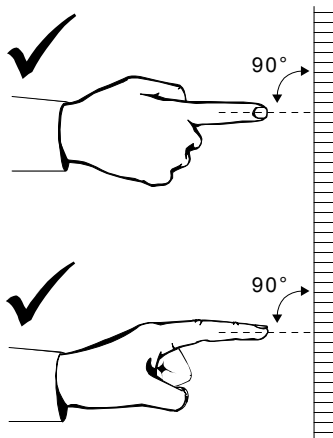



## CHAPTER 3

### Using your interactive whiteboard

Keep your thumb and other fingers away from the interactive surface. They can generate unintentional commands.

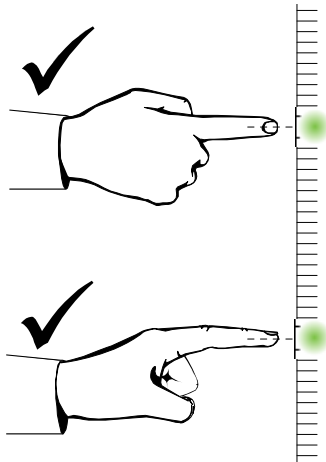

Keep your other hand, elbows and loose clothing away from the interactive surface. They can generate unintentional commands.

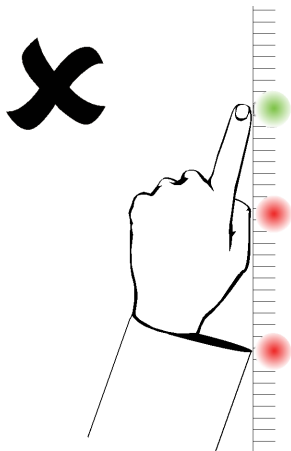

For “click” commands, quickly tap your finger on the interactive surface. Also, make sure you lift your finger far enough away from the interactive surface between presses so that your finger is out of the interactive whiteboard cameras’ view.

## Updating your SMART software

To update your SMART software, go to the SMART software download page or use SMART Product Update (SPU).

## CHAPTER 3

Using your interactive whiteboard

### To check for software updates

1. Click the SMART software icon in the Windows notification area or the Mac Dock, and then select **Check for Updates and Activation**.

The *SMART Product Update* dialog box appears listing the SMART software products installed on your computer.



#### NOTE

If you don't see the *Check for Updates and Activation* option, contact your network administrator.

2. Click the **Update** button beside the software you want to update.

Your SMART software updates automatically.

# Chapter 4

## Maintenance and troubleshooting

Tips for trouble-free performance .....	21
Cleaning your interactive whiteboard .....	22
General troubleshooting .....	23
Adjusting the projected image .....	23
Resetting your interactive whiteboard .....	23
Preventing USB cable issues .....	23
Troubleshooting tips .....	23
Troubleshooting using the status light .....	27
Transporting your interactive whiteboard .....	29
Contacting SMART Support .....	29

---

### Tips for trouble-free performance

Your SMART Board interactive whiteboard is durable, but take care to prevent any damage to it and its parts.

- Replace the pen when the nib wears out.
- Don't touch the interactive surface with sharp or pointed objects.
- Don't set up and use your interactive whiteboard in an area with excessive levels of dust, humidity or smoke.
- Don't use low-odor dry-erase markers because they can be very difficult to erase.
- Don't obstruct the cameras' view of the interactive whiteboard. For example, don't place magnets, stickers or adhesive tape on the interactive surface, or rest any objects, including your hand or the pens, in the recess at the bottom of the interactive surface because this interferes with the corner cameras' ability to detect your finger or pens on the interactive surface.

## CHAPTER 4

### Maintenance and troubleshooting

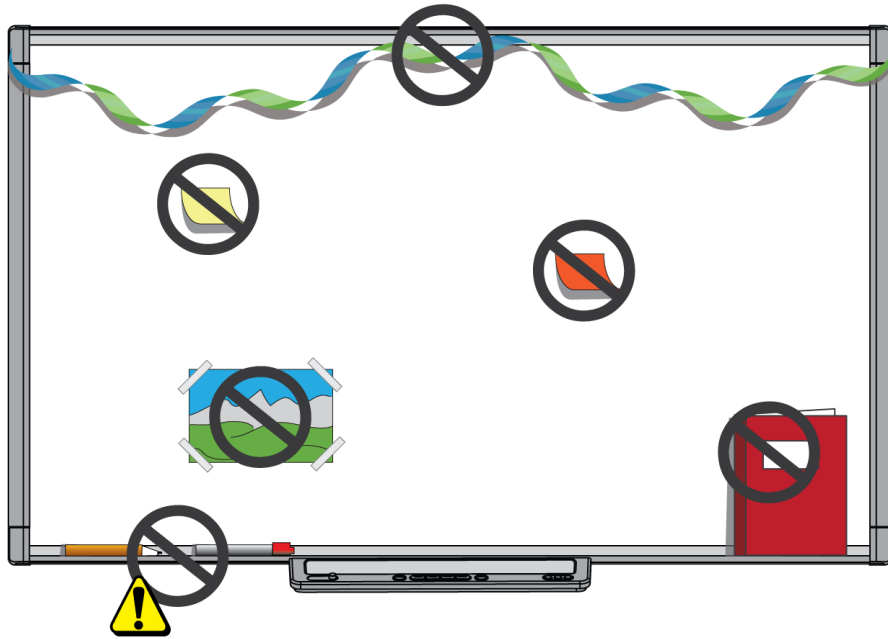

## Cleaning your interactive whiteboard

With proper care, your interactive whiteboard will provide years of trouble-free service. Follow these tips to keep your interactive whiteboard clean.

### CAUTION

Do not use harsh chemicals or abrasive cleaners on your interactive whiteboard.

### IMPORTANT

- Before you clean your interactive whiteboard, disconnect its USB and power cables.
- To view dirt or streaks more easily, set your projector to standby (lamp off) mode.
- To clean dust, dirt and finger grease, wipe the interactive surface with a damp cloth or sponge. Use mild soap, if required.
- Don't spray cleaner directly onto the interactive surface. Instead, spray a light amount of cleaner on a cloth and then gently wipe the interactive surface.
- Don't allow excess cleaner to flow onto the frame's reflective surfaces or the cameras in the corners of the frame.

## CHAPTER 4

### Maintenance and troubleshooting

- Don't touch the digital cameras located in the corners of the frame. Don't attempt to clean the digital cameras without specific instructions from SMART Technologies.
- If ink is accidentally used on your interactive whiteboard, remove the ink as soon as possible. Ink becomes more difficult to remove the longer it stays on the interactive surface.

## General troubleshooting

### Adjusting the projected image

If your projector isn't installed in a fixed location, you can correct many image problems by shifting your projector so that the projected image fits squarely on the interactive surface. Optimally, each side of the image should extend almost to the edge of the interactive surface.

For more information on your projector, go to [smarttech.com/support](http://smarttech.com/support).

### Resetting your interactive whiteboard

You can reset your interactive whiteboard by disconnecting and then reconnecting the power cable. This turns the power off and back on, restarting all components of your interactive whiteboard.

### Preventing USB cable issues

To troubleshoot some common cable routing issues, try disconnecting accessories such as USB hubs and USB extension cables that are connected to your interactive whiteboard.

The basic system consists of the SMART Board M600 series interactive whiteboard, a USB cable, a power cable, computer hardware, a computer operating system and SMART Product Drivers. You can try isolating and replacing each component to identify the cause of the connectivity issue.

### Troubleshooting tips

This section describes some symptoms, causes and solutions for problems that you could experience with your interactive whiteboard.

Try the troubleshooting tips in the following table to quickly resolve most issues with your product.



#### NOTE

These procedures vary, depending on your operating system and your system preferences.

## CHAPTER 4

### Maintenance and troubleshooting

Symptoms	Cause	Solution
No image is projected on your interactive whiteboard, or a “No Input” message appears.	Your projector isn’t receiving a video signal.	Check the video cable connections. Ensure that the correct video input is selected on your projector. Ensure that your projector is on, and that it’s connected to a power source. If you’re using a laptop computer, turn on the external video connection. Refer to your laptop’s user’s guide for more information.
	Your computer is in standby mode.	Move the mouse, or touch the interactive surface or any key on your keyboard to bring your computer out of standby mode.
	Your computer is off.	Turn on your computer (or press your computer’s reset button), and then log on as usual.
The projected image is blurry, too large or doesn’t completely fill your interactive whiteboard’s screen.	Your projector’s position, zoom and focus settings aren’t adjusted.	Adjust the projector’s position, zoom and focus settings. Refer to your projector’s user’s guide for more information.
	Your computer’s video resolution settings don’t match your projector’s native resolution.	Consult your projector’s user’s guide for the correct computer video resolution, and then go to Windows control panel or Mac System Preferences to change the computer video resolution to match your projector.

## CHAPTER 4

### Maintenance and troubleshooting

Symptoms	Cause	Solution
The SMART software icon doesn't appear in the notification area (Windows) or dock (Mac).	SMART Board Tools isn't running.	Start SMART Board Tools. For Windows computers, select <b>Start &gt; All Programs &gt; SMART Technologies &gt; SMART Board Tools 2013</b> . For Mac computers, select <b>Finder &gt; Applications &gt; SMART Technologies &gt; Board Tools</b> .
	SMART Product Drivers isn't installed	Install SMART Product Drivers on your computer. For details about installing SMART Product Drivers, see <i>Installing SMART Product Drivers</i> on page 8.
The orientation procedure doesn't proceed to the second point.	Your computer could be sending input to an application other than the interactive whiteboard's orientation screen.	Press ALT+TAB on your keyboard to change your operating system's focus to the interactive whiteboard's orientation screen. Alternatively, open SMART settings and select <b>Orient/Align the SMART Product</b> .

## CHAPTER 4

### Maintenance and troubleshooting

Symptoms	Cause	Solution
The interactive surface doesn't respond when you touch it, the pointer moves erratically or gaps appear when you draw or write.	Your interactive whiteboard isn't oriented.	Orient your interactive whiteboard. For more information about orienting your interactive whiteboard, see <i>Orienting your interactive whiteboard</i> on page 9.
	SMART Board Tools isn't running.	Start SMART Board Tools. For Windows computers, select <b>Start &gt; All Programs &gt; SMART Technologies &gt; SMART Board Tools 2013</b> . For Mac computers, select <b>Finder &gt; Applications &gt; SMART Technologies &gt; Board Tools</b> .
	SMART Product Drivers isn't installed.	Install SMART Product Drivers on your computer. For details about installing SMART Product Drivers, see <i>Installing SMART Product Drivers</i> on page 8.
	Not all components of SMART Product Drivers are installed on your computer.	Remove SMART Product Drivers from your computer, and then install SMART Product Drivers again.
	A camera is obscured.	Remove any object attached to the interactive surface or resting in the bottom bezel behind the pen tray.



## CHAPTER 4

### Maintenance and troubleshooting

Symptoms	Cause	Solution
There is a small red × on the SMART software icon.	SMART Product Drivers is unable to detect your interactive whiteboard.	Ensure that the USB cable is connected from your computer to your interactive whiteboard and that the USB cable isn't longer than 5 m (16').
	SMART Board service isn't running.	Start SMART Board service: <ol style="list-style-type: none"><li>1. In the notification area (Windows) or Dock (Mac), press the SMART software icon, and then press <b>SMART Settings</b>. SMART Settings opens.</li><li>2. Select <b>About Software and Product Support &gt; Tools &gt; Diagnostics</b>. The <i>SMART Board Diagnostics</i> window opens.</li><li>3. Select <b>Service &gt; Start</b>.</li><li>4. Close the <i>SMART Board Diagnostics</i> window, and then close SMART Settings.</li></ol>

### Troubleshooting using the status light

If your interactive whiteboard has an active pen tray (models SBM680 and SBM685), you can also use the Select button's status light to help you identify and resolve issues with your product. Refer to *Using the Pen Tray* on page 12 for information on the status light's states during normal operation.



#### NOTE

The pen ledge on SMART Board models SBM680V and SBM685V doesn't have a status light.

## CHAPTER 4

### Maintenance and troubleshooting

Status light	Cause	Solution
Off	Your interactive whiteboard isn't receiving power or the USB cable is unplugged.	Reset your interactive whiteboard by disconnecting and then reconnecting the power cable at the wall outlet. Check that the USB cable is connected securely.
	Your computer is in Sleep mode or the computer is off.	Touch the interactive whiteboard surface to wake up your computer or turn your computer on.
	You have selected a non-standard digital ink color using SMART Notebook software or SMART Ink.	Press a pen tray button to select a standard color or tool.
Solid amber	The controller module is in service mode or the firmware is being updated.	Wait for the firmware update to finish.
Flashing white	SMART Board service isn't running.	Start SMART Board service. To determine whether the SMART Board service is running, open SMART Settings and check the message that appears at the bottom.
	SMART Product Drivers isn't installed.	Install SMART Product Drivers on your computer. For details about installing SMART Product Drivers, see <i>Installing SMART Product Drivers</i> on page 8.

A solid white status light indicates that the interactive whiteboard is working properly. However, if the pen tray tools don't work as expected, try the following to resolve the issue.

- If another user reassigned the pen, eraser or other button functions, the tools might not work as expected. You can return them to normal operation using SMART Settings to change the SMART hardware settings.
- Reset the interactive whiteboard by disconnecting the power cable at the wall outlet, and connecting it again.
- Calibrate the cameras to ensure that they accurately track your fingers and the pens (see *Calibrating your interactive whiteboard* on page 8).

## Transporting your interactive whiteboard

Save your original SMART Board interactive whiteboard packaging so that it's available if you need to transport your interactive whiteboard. When required, repack your interactive whiteboard with all of the original packaging. This packaging was designed with optimal shock and vibration protection.

## Contacting SMART Support

SMART Support welcomes your call. However, if you experience difficulty with your SMART product, consider contacting your authorized SMART reseller ([smarttech.com/wheretobuy](http://smarttech.com/wheretobuy)) first. Your reseller can often resolve the issue without delay.

Before you contact SMART Support, ensure the following:

- You know the serial number of your interactive whiteboard.
- Your computer specifications and operating system meet the minimum requirements for SMART Product Drivers.
- The USB and power cables are connected properly to your computer and interactive whiteboard.
- Device drivers are installed on your operating system.
- The interactive surface and bezels aren't optically obstructed.
- You oriented your interactive whiteboard.

### **■ To determine your interactive whiteboard's serial number**

Look on the lower right edge of your interactive whiteboard's frame when you're facing the front of your interactive whiteboard. The serial number is also on the back of the interactive whiteboard.

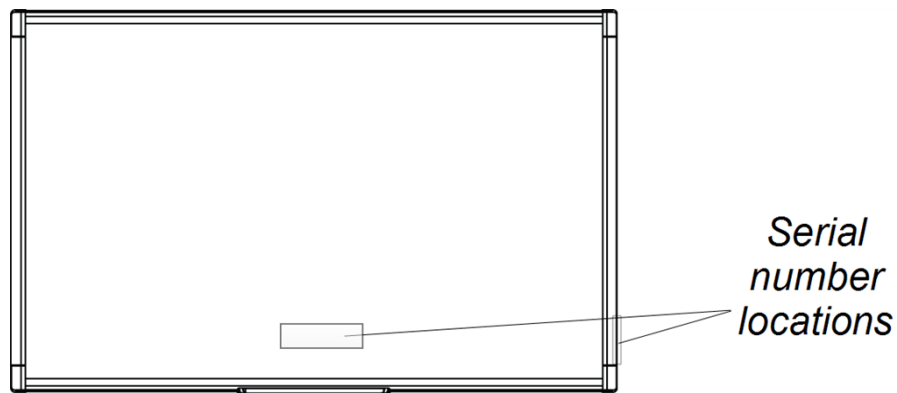



## Appendix A

# Hardware environmental compliance

SMART Technologies supports global efforts to ensure that electronic equipment is manufactured, sold and disposed of in a safe and environmentally friendly manner. For your interactive whiteboard's environmental compliance information, see the specifications for your product located at [smarttech.com/SupportSBM600](https://smarttech.com/SupportSBM600).

## Waste Electrical and Electronic Equipment and Battery regulations (WEEE and Battery Directives)

Electrical and electronic equipment and batteries contain substances that can be harmful to the environment and to human health. The crossed-out wheeled bin symbol indicates that products should be disposed of in the appropriate recycling stream and not as regular waste.



## Batteries

Remote contains two zinc-carbon AAA batteries. Recycle or dispose of batteries properly.



# Index

## A

- accessories 5
- adjusting projected image 23
- aspect ratio 2

## B

- batteries 31

## C

- cleaning 22
  - erasing ink 23
- computer
  - connecting to interactive whiteboard 7
  - matching resolution to projector 7
  - refresh rate 7
  - system requirements 2
- contacting SMART Support 29

## D

- Digital Vision Touch (DViT) technology 2
- dual touch / dual write 2
- dust 21

## G

- gestures 15
  - best practices 18
  - multi-finger 17
  - single-finger 16

## H

- humidity 21

## I

- installation
  - connecting to computer 7
  - SMART Product Drivers 8

## M

- maintenance 21
- multitouch gestures 2, 15

## O

- orientation 9

## P

- parts
  - accessories 5
  - pen tray 12
  - Pen tray 2
  - projector
    - adjusting image 23
    - resolution 7

## R

- replacement parts 5
- resetting your interactive whiteboard 23
- resolution
  - computer 7

## INDEX

projector 7

## S

serial number 29

SMART Board M600 interactive whiteboard

    features 2

    how it works 3

    resetting 23

SMART Ink 3

SMART Notebook software 1, 3

SMART Product Drivers

    floating tools 14

    installing 8

    orienting your interactive whiteboard 9

SMART software

    updating 19

SMART Support 29

## T

transporting 29

troubleshooting 23

## U

USB cable 4

## W

WEEE and Battery Directives 31





SMART Technologies

[smarttech.com/support](https://smarttech.com/support)

[smarttech.com/contactsupport](https://smarttech.com/contactsupport)

[smarttech.com/kb/170410](https://smarttech.com/kb/170410)