

SMART Board® M600 series interactive whiteboards

USER GUIDE

SBM680 | SBM685 | SBM680E | SBM685E | SBM680V | SBM685V

Was this document helpful?
smarttech.com/docfeedback/170410

SMART®



Learn more

This guide and other resources for SMART Board M600 and M600V series interactive whiteboards are available in the Support section of the SMART website (smarttech.com/support). Scan this QR code to view these resources on your mobile device.

FCC warning

This equipment has been tested and found to comply with the limits for a Class A digital device, pursuant to Part 15 of the FCC Rules. These limits are designed to provide reasonable protection against harmful interference when the equipment is operated in a commercial environment. This equipment generates, uses and can radiate radio frequency energy and, if not installed and used in accordance with the manufacturer's instructions, may cause harmful interference to radio communications. Operation of this equipment in a residential area is likely to cause harmful interference in which case the user will be required to correct the interference at his own expense.

Trademark notice

SMART Board, SMART Notebook, DVIT, SMART Ink, smarttech, the SMART logo and all SMART taglines are trademarks or registered trademarks of SMART Technologies ULC in the U.S. and/or other countries. Microsoft and Windows are either registered trademarks or trademarks of Microsoft Corporation in the U.S. and/or other countries. Mac is a trademark of Apple Inc., registered in the U.S. and other countries. All other third-party product and company names may be trademarks of their respective owners.

Copyright notice

© 2013–2019 SMART Technologies ULC. All rights reserved. No part of this publication may be reproduced, transmitted, transcribed, stored in a retrieval system or translated into any language in any form by any means without the prior written consent of SMART Technologies ULC. Information in this manual is subject to change without notice and does not represent a commitment on the part of SMART.

This product and/or use thereof covered by one or more of the following U.S. patents: smarttech.com/patents. Contents are subject to change without notice.
October 24, 2019

Important information

Before you install and use the SMART Board® M600 series interactive whiteboard, read and understand the safety warnings and precautions in this user's guide and the included warnings document. The included warnings document describes the safe and correct operation of the SMART Board interactive whiteboard and its accessories, helping you to prevent injuries and equipment damage.

NOTE

In this document, the term “interactive whiteboard” refers to the interactive whiteboard and its accessories and options.

Contents

Important information	i
Chapter 1: Introducing the SMART Board M600 series interactive whiteboard	1
Introduction	1
Features	2
Computer requirements	3
How does the SMART Board interactive whiteboard work?	3
Installation tips	4
Accessories and replacement parts	5
Chapter 2: Connecting a computer	7
Matching the computer's resolution to the projector's resolution	7
Installing SMART Product Drivers	7
Chapter 3: Calibrating and orienting the interactive whiteboard	9
Calibrating the interactive whiteboard	9
Orienting the interactive whiteboard	10
Chapter 4: Using the interactive whiteboard	13
Using the pen tray	14
Using SMART Ink	17
Using gestures, dual touch, and dual write	17
Updating SMART software	22
Chapter 5: Maintenance and troubleshooting	23
Tips for trouble-free performance	23
Cleaning the interactive whiteboard	24
General troubleshooting	25
Transporting the interactive whiteboard	31
Contacting SMART Support	31
Appendix A: Hardware environmental compliance	33
Waste Electrical and Electronic Equipment and Battery regulations (WEEE and Battery Directives)	33
Batteries	33

Chapter 1

Introducing the SMART Board M600 series interactive whiteboard

Introduction	1
Features	2
Pen tray or pen ledge	2
DViT technology	2
Multitouch gestures	2
Dual touch and dual write	2
Durable surface	3
Computer requirements	3
How does the SMART Board interactive whiteboard work?	3
Installation tips	4
Extending the USB cable	4
Avoiding electromagnetic interference	5
Accessories and replacement parts	5

Introduction

Your SMART product is a wall-mounted, front projection interactive whiteboard. It enables you to do everything that you can do at your computer—open and close applications, scroll through files, teach collaborative lessons, create or edit documents, visit websites, play video clips and more—by touching the interactive surface with your finger or the included pen. When you connect the interactive whiteboard to a computer and a projector, the computer image displays on the interactive surface. You can write over any application in digital ink, and then save these notes to a file in SMART Notebook® collaborative learning software for future reference and distribution.

The SMART Board M600 series interactive whiteboard is a full-speed USB 2.0 device with an external power supply. If the interactive whiteboard is part of a system with a SMART projector, the interactive whiteboard may receive power from the SMART projector. Otherwise, the interactive whiteboard receives power from a wall outlet through the included country-specific power supply and cable.

Features

The SMART Board M600 series interactive whiteboard is durable and reliable. It features a rugged, hardened interactive surface, two damage-resistant pens and SMART's proprietary DVIT® (Digital Vision Touch) technology. The SMART Board M680 interactive whiteboard measures 195.6 cm (77") diagonally and has a 4:3 aspect ratio, while the M685 interactive whiteboard measures 221 cm (87") diagonally and has a 16:10 aspect ratio.

Pen tray or pen ledge

Depending on your interactive whiteboard's model, it comes with a pen tray or pen ledge:

Models	Pen tray or pen ledge	Description
SBM680 SBM685	Pen tray	The pen tray connects to the interactive whiteboard and holds the two included pens. The pen tray features color select buttons to change digital ink colors. On-screen keyboard, right-click and orient features are available on the pen tray.
SBM680 (as part of projector system) SBM685 (as part of projector system) SBM680E SBM685E	Pen tray with projector controls	The pen tray connects to the interactive whiteboard and holds the two included pens. The pen tray features color select buttons to change digital ink colors. Power and volume controls are available on the pen tray, as are the on-screen keyboard, right-click and orient features.
SBM680V SBM685V	Pen ledge	The durable pen ledge holds the two included pens.

DViT technology

Four digital cameras, one in each of the interactive whiteboard's corners, track the position of your finger or the pen as it moves across the interactive surface.

Multitouch gestures

The interactive whiteboard supports multitouch gestures (Windows® and Mac only). You can use two fingers to resize an object on a page, to zoom in and out, to rotate an object and more.

Dual touch and dual write

The interactive whiteboard supports dual touch (Windows and Mac only). Two users can use their fingers to simultaneously perform mouse functions or write on the interactive whiteboard.

Durable surface

The interactive surface is scratch-resistant, dent-resistant and optimized for projection.

Computer requirements

To successfully power the interactive whiteboard and run SMART Product Drivers, your computer must meet certain minimum requirements. For a complete list of computer requirements, go to smarttech.com/downloads and browse to the latest SMART Notebook software release notes applicable to your computer's operating system.

How does the SMART Board interactive whiteboard work?

The interactive whiteboard functions as an input device for your computer, enabling you to work in any application on the connected computer. You need two additional components to use the interactive whiteboard: a computer and a digital projector. These components work together as follows:

- Your computer runs an application and sends the image to the projector.
- The projector casts the image onto the interactive whiteboard.
- The interactive whiteboard detects contact with its screen and sends each contact point to the connected computer.

If your interactive whiteboard includes a pen tray with control and tool selection buttons, use the pen tray buttons to select different tools. For example, when you press the left-click button, the interactive whiteboard interprets the touch of your finger as a mouse click and you can control the computer from the interactive whiteboard. When you pick up a pen and press one of the color buttons, digital ink appears, enabling you to write over the desktop or any open application.

When you install SMART Learning Suite, you can access all the features of the interactive whiteboard. SMART Learning Suite includes SMART Notebook® collaborative learning software, SMART Ink® and SMART Product Drivers.

With SMART Ink, a dynamic (floating) toolbar appears on the desktop. You can use this toolbar to change the pen's color, thickness or other properties temporarily, or use some of SMART Ink's tools such as screen capture, spotlight, screen shade, and so on. For more information, see *Using SMART Ink* on page 17.

You can download SMART software from smarttech.com/software. These web pages list the minimum hardware requirements for each software version. If SMART software is already installed on your computer, take this opportunity to upgrade the software to ensure compatibility.

Installation tips

For the installation instructions for the SMART Board M600 series interactive whiteboard, see the *SMART Board M600 series interactive whiteboard installation guide* (smarttech.com/kb/170429). If you purchased a floor stand, wall-mount or a system that includes a projector or other components, refer to the installation documents included with those components.

The optimal mounting height is 196 cm (77") from the floor to the center of the installation brackets. However, consider the general height of the user community when you choose a location for wall-mounting the interactive whiteboard and adjust accordingly.

Choose a location that's far from bright light sources, such as windows and strong overhead lighting. Infrared (IR) lighting can cause issues with the performance of the cameras and can lead to unintentional or missed touches.

Ensure that you use the correct mounting hardware for the wall type. You can also order the SMART Board interactive whiteboard [hardware kit](#) (Part No. 1020342) from your authorized SMART reseller.

Extending the USB cable

The USB cable included with the SMART Board M600 series interactive whiteboard is within the limit defined by the USB standard for maximum length. The interactive whiteboard includes a 16' (5 m) USB cable.

IMPORTANT

The combined length of USB cables connected from the interactive whiteboard to your computer should not exceed 16' (5 m).

However, if the provided cable isn't long enough to reach from your computer to the interactive whiteboard, you can use a bus-powered hub, such as the active USB extension cable (Part No. USB-XT) to extend the USB connection.

Avoiding electromagnetic interference

You can take some precautions to prevent electromagnetic interference (EMI) to the interactive whiteboard:

- Don't route USB cables parallel to power cables.
- Cross USB cables over power cables at a 90° angle to reduce the risk of interference on the USB cables.
- Don't route USB cables close to common sources of EMI, such as electric motors or fluorescent lighting ballasts.
- Don't bend USB cables sharply.
- Don't use USB plug adapters or passive USB wall plates.

Accessories and replacement parts

For a full list of optional accessories that you can order for your SMART Board M600 series interactive whiteboard, go to smarttech.com/accessories.

For a list of replacement parts for your SMART Board M600 series interactive whiteboard, refer to the service parts diagrams for your model.

Contact your authorized SMART reseller (smarttech.com/wheretobuy) to order accessories and standard replacement parts for the SMART Board M600 series interactive whiteboard.

Chapter 2

Connecting a computer

Matching the computer's resolution to the projector's resolution	7
Installing SMART Product Drivers	7

The SMART Board M600 series interactive whiteboard's USB interface enables you to connect the interactive whiteboard to a computer. The included USB cable provides a digital signal from the computer to the interactive whiteboard, and the included power supply provides power to the interactive whiteboard.

Matching the computer's resolution to the projector's resolution

Ensure that the resolution settings for the projector and computer match. If the computer's resolution doesn't match the projector's native resolution, the image won't fill the interactive surface properly and can shimmer or appear distorted.

Set the projector to its optimal image resolution by following the instructions included with the projector, and then set the computer's resolution to match. If you need help changing the computer's resolution, see the instructions included with your computer's operating system.

You might need to adjust the computer's refresh rate to obtain the best results. Set the computer to an initial refresh rate of 60 Hz, and then adjust this rate up or down to determine the ideal refresh rate. For more information on changing your computer's refresh rate, see the instructions included with the computer's operating system.

Installing SMART Product Drivers

You can install SMART Product Drivers on any computer that meets certain minimum operating specifications by downloading it from smarttech.com/downloads.

 **IMPORTANT**

You must install the latest version of SMART Product Drivers on your Windows or Mac computer in order to write in digital ink and to use touch on the interactive whiteboard's surface.

For a complete list of computer requirements, go to smarttech.com/downloads and browse to the latest SMART Notebook release notes applicable to your computer's operating system.

Chapter 3

Calibrating and orienting the interactive whiteboard

Calibrating the interactive whiteboard	9
Orienting the interactive whiteboard	10

Perform the brief calibration and user orientation procedures to ensure the interactive whiteboard interprets the location of your touch accurately.

Calibrating the interactive whiteboard

Digital cameras in the corners of the interactive whiteboard track the position of the pens and your finger on the interactive surface, and then send the information to the SMART software. SMART software interprets this information as mouse clicks, digital ink or ink removal in the appropriate location.

If you haven't used the interactive whiteboard before, you must perform a calibration. This process ensures that the cameras accurately track your finger and the pens on the interactive surface. If the system detects a problem with calibration, a warning bubble may also appear recommending that you perform a calibration.

To calibrate your interactive whiteboard

1. The first time you connect the interactive whiteboard, press the **Please calibrate the SMART Board interactive whiteboard** pop-up bubble that appears in the bottom right corner of the screen.

If the pop-up doesn't appear, click the SMART software icon in the Windows notification area or Mac Dock and select **SMART Settings > SMART Hardware Settings > Advanced > Calibrate**.

The calibration window opens.

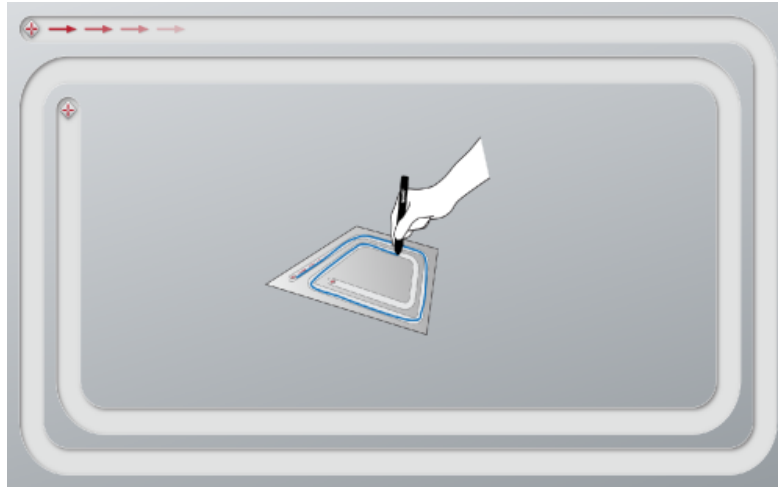

2. With a pen tray pen, press the first target.
3. Keeping the pen on the interactive whiteboard surface, draw along the track until you reach the second target. Keep the pen in the track, regardless of where the digital ink appears.
4. When you reach the second target, lift the pen from the surface.
5. If the calibration window remains open, the cameras require further calibration. Trace your pen around the track a second or even a third time until the calibration window closes.

The orientation screen appears.

Orienting the interactive whiteboard

After you install SMART Product Drivers on your computer and have completed the calibration procedure, an orientation screen appears. Orienting the interactive whiteboard ensures the greatest possible level of writing and touch accuracy. Orient the interactive whiteboard any time the projector or interactive whiteboard has been moved since you last used it or whenever the mouse pointer isn't properly aligned with the pen or your finger when you touch the interactive surface.

To orient your interactive whiteboard

1. On the interactive surface, click the **SMART software** icon in the notification area (Windows) or Dock (Mac), and then select **Orient**.

The *Orientation* screen opens.

2. Pick up a pen from the pen tray.

3. Beginning at the first target on the screen, touch the center of the target firmly with the tip of the pen and hold the pen steady until the target turns green. When you lift the pen, the target moves to the next point.
4. Repeat step 3 on all the targets.

The *Orientation* screen closes.

Chapter 4

Using the interactive whiteboard

Using the pen tray	14
Pen tray buttons	14
Understanding the Select button's status light	15
Customizing the pen tray buttons	16
Using SMART Ink	17
Using gestures, dual touch, and dual write	17
Single-finger gestures	18
Selecting and deselecting an object (clicking)	18
Displaying menu options (right-clicking)	18
Dragging an object or scroll bar	18
Double-clicking	19
Displaying the next or previous page	19
Multi-finger gestures	19
Displaying menu options (right-clicking)	19
Enlarging an area or object	20
Reducing the scale of an object	20
Scrolling horizontally or vertically	20
Rotating an object	20
Best practices for gestures and tools	20
Updating SMART software	22

When you touch the interactive whiteboard's surface, the interactive whiteboard registers the horizontal and vertical (or x and y) coordinates on the interactive surface. The computer's mouse driver interprets those coordinates and moves the pointer to the corresponding point on the projected image.

WARNING

Do not stand (or allow children to stand) on a chair to touch the surface of the SMART Board product. Instead, safely fix the product at the appropriate height on a wall or use a SMART floor stand.

To open an application on the interactive whiteboard, press twice consecutively on the application's icon. When you press twice to open an application, it's the same as double-clicking with the mouse to open an application on your computer. Similarly, each time you press once on the interactive surface, it's the same as a single left click.

NOTE

If necessary, move the mouse, touch the interactive whiteboard's surface or press any key on the keyboard to bring the computer out of standby mode.

Using the pen tray

In addition to providing a convenient place to hold the included pens, the interactive pen tray on the SMART Board M680 or M685 interactive whiteboard has several controls and indicators.

NOTES

- SMART Board M680V and M685V interactive whiteboards feature a durable pen ledge that holds the two included pens, rather than an interactive pen tray.
 - For information on the different types of pen tray and pen ledge for each model, see *Differentiating SMART Board M600 series interactive whiteboard pen trays* (smarttech.com/kb/171251).
-

Pen tray buttons

In the center of the pen tray, there are six buttons. The middle four change the color of digital ink that appears when you touch the screen. The buttons on either side of the pen color buttons default to the select (left button) and eraser (right button) functions. These buttons light up to indicate the current selected tool.

The buttons on the right side of the pen tray enable the right-click, on-screen keyboard and orientation functions.

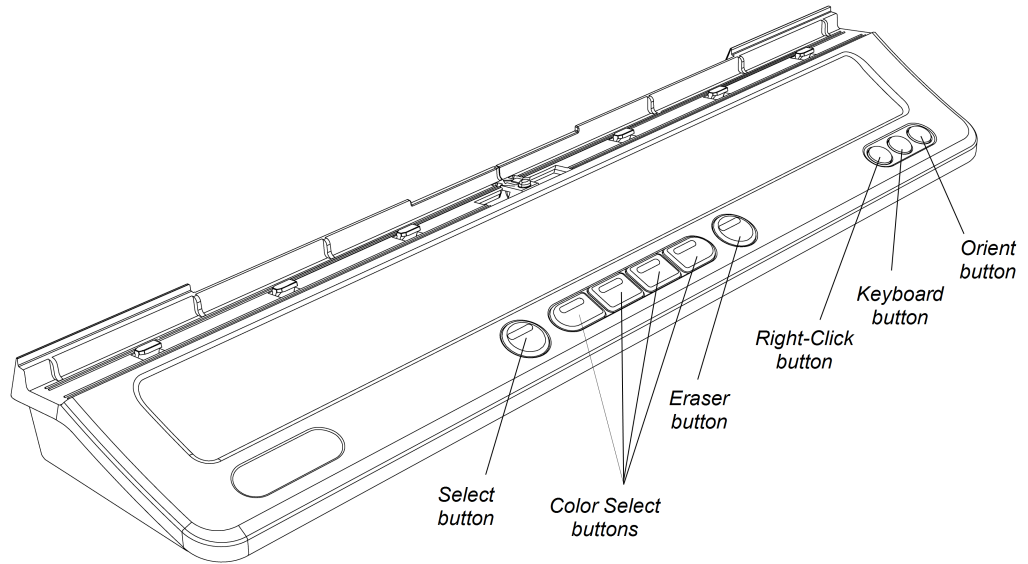

NOTE

If the interactive whiteboard is part of a projector system, the left side of the pen tray includes controls for power, volume, and input selection.

Understanding the Select button's status light

The Select button's light also indicates the status of the interactive whiteboard. The Select button's light is solid white when the system is working properly.

The following table shows the Select button's normal states. If the light's behavior doesn't match a state listed here, see *General troubleshooting* on page 25

Select light state	Meaning
Flashing white	<p>The interactive whiteboard is receiving power and is communicating successfully with the computer's USB HID driver, but SMART Product Drivers isn't installed.</p> <hr/> <p>NOTE</p> <p>In HID mode, interactive whiteboard tools such as the pens are unavailable, but you can move the mouse pointer and perform mouse functions by touching the interactive surface. The Right-Click button on the pen tray might work, depending on the version of operating system you're using. Neither the Keyboard nor the Orient button works in HID mode.</p> <hr/>
Solid white	<p>The interactive whiteboard is receiving power and is communicating successfully with SMART Product Drivers. When you press another pen tray button, the Select button's light turns off and the light on the button you pressed turns on.</p>
Solid amber	<p>The controller module is in service mode or the firmware is being updated.</p>
Off	<p>You have selected a non-standard digital ink color using SMART Notebook software or SMART Ink, the interactive whiteboard isn't receiving power or the interactive whiteboard is in Standby mode.</p> <p>If you're using a pen tray with projector controls, the SMART or Epson for SMART projector might not have activate the USB source switch in the pen tray. Make sure the projector's USB port mapping setting is set to turn on the correct USB port on the pen tray for the selected video source.</p>

NOTE

If all pen tray lights are lit, see [Resolving issues using the pen tray status light on the SMART Board M600 interactive whiteboard](#).

Customizing the pen tray buttons

You can customize the pen tray button settings. For example, you can change line transparency, color and style; you can change the width of the eraser; and you can change the Keyboard and Right-Click button settings so that they perform another action.

To customize the pen tray button settings

1. Press the SMART software icon in the Windows notification area or Mac Dock, and then select **SMART Settings**.

SMART settings opens.

2. Press **SMART Hardware Settings** and select your SMART Board interactive whiteboards.
3. Select **Pen and Button Settings** from the drop-down list, and then select the button you want to customize.
4. Follow the on-screen instructions.

For more information about customizing settings, open the online Help by pressing the SMART software icon in the Windows notification area or Mac Dock, selecting **Help Center**, and then selecting **SMART Hardware Settings**.

Using SMART Ink

If SMART Ink is installed on the connected computer, the dynamic (floating) toolbar for SMART Ink appears on the screen. You can use this toolbar to change the pen's color, thickness or other properties temporarily, or use some of SMART Ink's tools such as screen capture, spotlight, screen shade, and so on.



To learn more about using SMART Ink and its toolbar, visit the [SMART Ink support page](#). Here are a few quick links to get you started:

- [Turning SMART Ink on or off](#)
- [Open the toolbar](#)
- [Close the toolbar \(keep SMART Ink on, but hide the floating toolbar\)](#)
- [Using presentation tools, such as Spotlight, Magnifier, and Screen Shade](#)

NOTE

SMART Notebook software doesn't display the SMART Ink toolbar because it includes its own ink tools that you can use to write directly in your file.

Using gestures, dual touch, and dual write

The interactive whiteboard supports multitouch gestures, dual touch and dual write with a Windows or Mac computer. (Some gestures might not work in all operating systems.)

Multitouch gestures enable you to use pre-determined commands on the interactive whiteboard without using the keyboard or mouse. With a series of two-finger touches on the interactive whiteboard screen, you can navigate pages, change the look of an object and more.

Dual touch enables two users to touch the interactive whiteboard and to simultaneously perform mouse functions. They can also use their fingers to write on the interactive whiteboard at the same time.

Single-finger gestures

You can perform some gestures using one finger, including selecting an object and double-clicking.

Single-finger gestures include the following:

Selecting and deselecting an object (clicking)

Quickly press and release the interactive surface to select or deselect an object or option. This performs a standard mouse click.

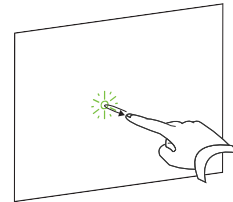

NOTE

This gesture starts applications if your computer's operating system is set to start applications on a single click.

Displaying menu options (right-clicking)

Press and hold the screen with your finger.

In SMART Notebook software, Windows and Microsoft® Office programs, the right-click menu appears.

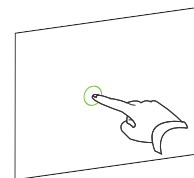

Dragging an object or scroll bar

Press and hold an object or scroll bar on the screen. Keep your finger on the screen and slowly move the object or scroll bar. When you reach the position you want, release your finger.

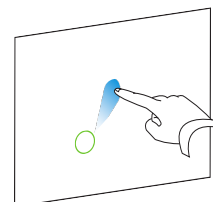

Double-clicking

Quickly press and release the interactive surface twice in the same spot. This performs a standard double-click.

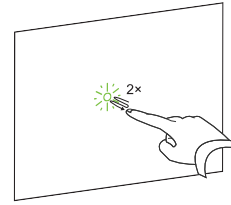

NOTE

This gesture starts applications if your computer's operating system is set to start applications on a double-click.

Displaying the next or previous page

Press the screen, and then quickly press again directly to the right of that point to display the next page.

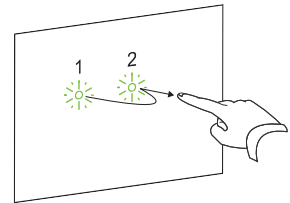

Press the screen, and then quickly press again directly to the left of that point to display the previous page.

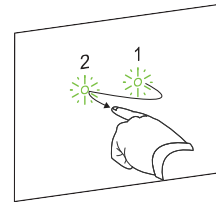

Multi-finger gestures

You can perform some gestures using two or more fingers, including scaling, scrolling and manipulating objects. Multi-finger gestures include the following:

Displaying menu options (right-clicking)

Using two fingers on the same hand, press and hold the screen with one finger and then press the screen directly to the right of that point with a second finger.

Release the first finger from the screen, and then select a menu item with any finger.

Enlarging an area or object

Use one finger on each hand to press in the center of the area or object, and then drag your fingers away from each other.

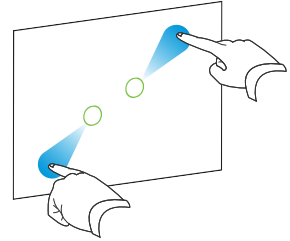

Reducing the scale of an object

Use one finger on each hand to press the screen at opposite ends of the area or object, and then drag your fingers toward each other.

This gesture scales an object on a page or the entire page, depending on the application.

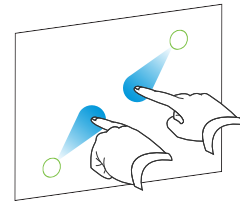

Scrolling horizontally or vertically

Use two fingers on the same hand to press the screen.

Keeping your fingers on the screen, move up, down, left or right on the page. Release your fingers when you're satisfied with the view.

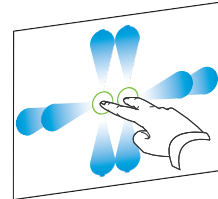

Rotating an object

Place one finger on either side of the object you want to rotate. Keep one finger stationary, and quickly move your second finger around the object. Release your fingers from the screen when you're satisfied with the angle.

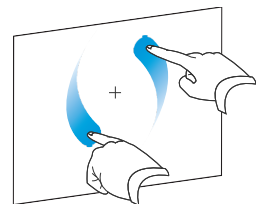

Best practices for gestures and tools

Follow these guidelines when you use gestures and tools with the interactive product.

Hold your fingers perpendicular (90°) to the interactive surface at the contact point.

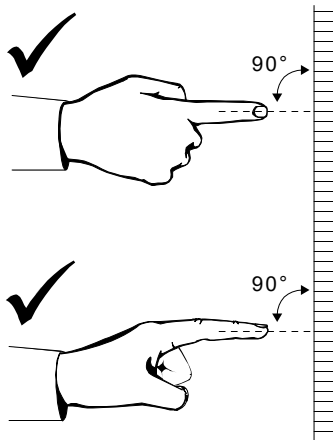

Keep your thumb and other fingers away from the interactive surface. They can generate unintentional commands.

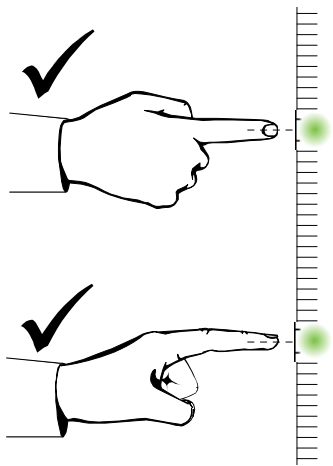

Keep your other hand, elbows and loose clothing away from the interactive surface. They can generate unintentional commands.

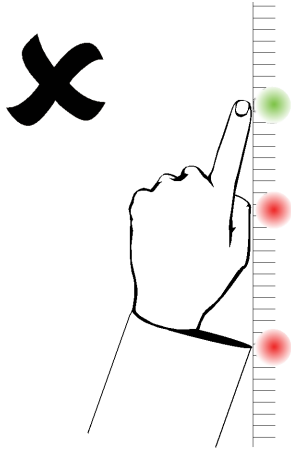

For “click” commands, quickly tap your finger on the interactive surface. Also, make sure you lift your finger far enough away from the interactive surface between presses so that your finger is out of the interactive whiteboard cameras’ view.

Updating SMART software

To update the computer’s SMART software, go to the SMART software download page or use SMART Product Update (SPU).

To check for software updates

1. Click the SMART software icon in the Windows notification area or the Mac Dock, and then select **Check for Updates and Activation**.

The *SMART Product Update* dialog box appears listing the SMART software products installed on your computer.

NOTE

If you don’t see the *Check for Updates and Activation* option, contact the network administrator.

2. Click the **Update** button beside the software you want to update.

The SMART software updates automatically.

Chapter 5

Maintenance and troubleshooting

Tips for trouble-free performance	23
Cleaning the interactive whiteboard	24
General troubleshooting	25
Adjusting the projected image	25
Resetting the interactive whiteboard	25
Preventing USB cable issues	25
Troubleshooting tips	25
Troubleshooting using the status light	29
Transporting the interactive whiteboard	31
Contacting SMART Support	31

Tips for trouble-free performance

The SMART Board interactive whiteboard is durable, but take care to prevent any damage to it and its parts.

- Replace the pen when the nib wears out.
- Don't touch the interactive surface with sharp or pointed objects.
- Don't set up and use the interactive whiteboard in an area with excessive levels of dust, humidity or smoke.
- Don't use low-odor dry-erase markers. They can be very difficult to erase.

- Don't obstruct the cameras' view of the interactive whiteboard. For example, don't place magnets, stickers or adhesive tape on the interactive surface or rest any objects, including your hand or the pens, in the recess at the bottom of the interactive surface. This interferes with the corner cameras' ability to detect your finger or pens on the interactive surface.

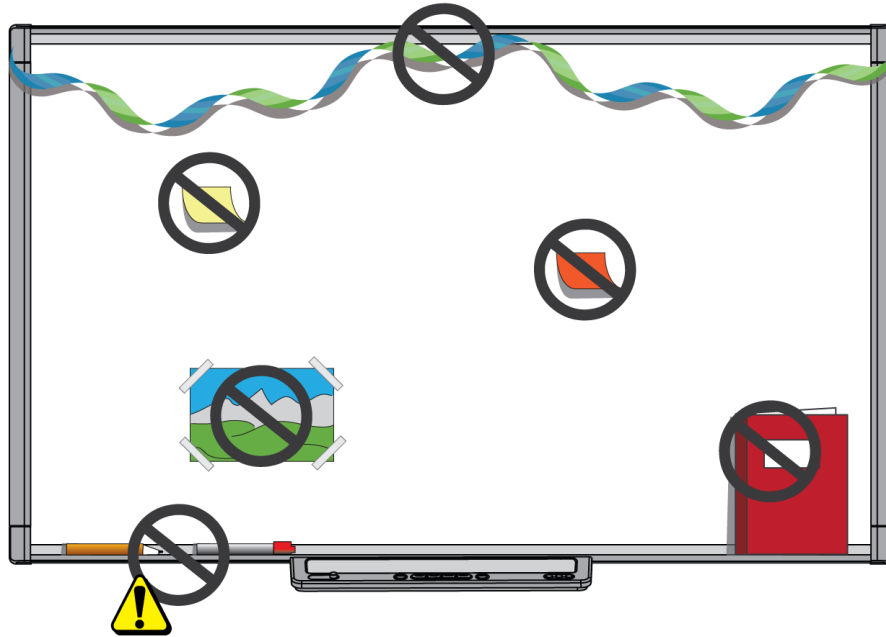

Cleaning the interactive whiteboard

With proper care, the interactive whiteboard will provide years of trouble-free service. Follow these tips to keep the interactive whiteboard clean.

CAUTION

- Do not use harsh chemicals or abrasive cleaners on the interactive whiteboard.
 - Don't spray cleaner directly onto the interactive surface. Instead, spray a light amount of cleaner on a cloth and then gently wipe the interactive surface.
 - Don't allow excess cleaner to flow onto the frame's reflective surfaces or the cameras in the corners of the frame. Cleaners that contact the reflective surface, camera optics or electronic components can damage or degrade the product's performance.
-

! **IMPORTANT**

- Before you clean the interactive whiteboard, disconnect its USB and power cables.
 - To view dirt or streaks more easily, turn the projector off or set it to standby (lamp off) mode.
-
- To clean dust, dirt and finger grease, wipe the interactive surface with a damp cloth or sponge. Use mild soap, if required.
 - Don't touch the digital cameras located in the corners of the frame. Don't attempt to clean the digital cameras without specific instructions from SMART Technologies.
 - If ink is accidentally used on the interactive whiteboard, remove the ink as soon as possible. Ink becomes more difficult to remove the longer it stays on the interactive surface.

General troubleshooting

Adjusting the projected image

If the projector isn't installed in a fixed location, you can correct many image problems by shifting the projector so that the projected image fits squarely on the interactive surface. Optimally, each side of the image should extend almost to the edge of the interactive surface.

For more information about the projector, go to smarttech.com/support. If you're using an M680E or M685E interactive whiteboard with an Epson® projector, consult the projector's documentation.

Resetting the interactive whiteboard

You can reset the interactive whiteboard by disconnecting and then reconnecting the power cable. This turns the power off and back on, restarting all the interactive whiteboard's components.

Preventing USB cable issues

To troubleshoot some common cable routing issues, try disconnecting accessories, such as USB hubs and USB extension cables, that are connected to the interactive whiteboard.

The basic system consists of the SMART Board M600 series interactive whiteboard, a USB cable, a power cable, computer hardware, a computer operating system and SMART Product Drivers. You can try isolating and replacing each component to identify the cause of the connectivity issue.

Troubleshooting tips

This section describes some symptoms, causes and solutions for problems that you could experience with the interactive whiteboard.

Try the troubleshooting tips in the following table to quickly resolve most issues with the product.

NOTE

These procedures vary, depending on your computer's operating system and system preferences.

Symptoms	Cause	Solution
No image is projected on the interactive whiteboard, or a "No Input" message appears.	The projector isn't receiving a video signal.	Check the video cable connections. Ensure that the correct video input is selected on the projector. Ensure that the projector is on, and that it's connected to a power source. If you're using a laptop computer, turn on the external video connection. Refer to your laptop's user's guide for more information.
	The computer is in standby mode.	Move the mouse, or touch the interactive surface or any key on your keyboard to bring the computer out of standby mode.
	The computer is off.	Turn on the computer (or press the computer's reset button), and then log on as usual.
The projected image is blurry, too large or doesn't completely fill the interactive whiteboard's screen.	The projector's position, zoom and focus settings aren't adjusted.	Adjust the projector's position, zoom and focus settings. Refer to the projector's user's guide for more information.
	The computer's video resolution settings don't match the projector's native resolution.	Consult the projector's user's guide for the correct computer video resolution, and then go to Windows control panel or Mac System Preferences to change the computer video resolution to match your projector.

Symptoms	Cause	Solution
The SMART software icon doesn't appear in the notification area (Windows) or dock (Mac).	SMART Board Tools isn't running.	Start SMART Board Tools. For Windows computers, select Start > All Programs > SMART Technologies > SMART Board Tools 2013 . For Mac computers, select Finder > Applications > SMART Technologies > Board Tools .
	SMART Product Drivers isn't installed	Install SMART Product Drivers on your computer. For details about installing SMART Product Drivers, see <i>Installing SMART Product Drivers</i> on page 7.
The orientation procedure doesn't proceed to the second point.	The computer could be sending input to an application other than the interactive whiteboard's orientation screen.	Press ALT+TAB on the keyboard to change your operating system's focus to the interactive whiteboard's orientation screen. Alternatively, open SMART settings and select Orient/Align the SMART Product .

Symptoms	Cause	Solution
<p>The interactive surface doesn't respond when you touch it, the pointer moves erratically, or gaps appear when you draw or write.</p>	<p>The interactive whiteboard isn't oriented.</p>	<p>Orient the interactive whiteboard. For more information about orienting the interactive whiteboard, see <i>Orienting the interactive whiteboard</i> on page 10.</p>
	<p>SMART Board Tools isn't running.</p>	<p>Start SMART Board Tools. For Windows computers, select Start > All Programs > SMART Technologies > SMART Board Tools 2013. For Mac computers, select Finder > Applications > SMART Technologies > Board Tools.</p>
	<p>SMART Product Drivers isn't installed.</p>	<p>Install SMART Product Drivers on your computer. For details about installing SMART Product Drivers, see <i>Installing SMART Product Drivers</i> on page 7.</p>
	<p>Not all components of SMART Product Drivers are installed on your computer.</p>	<p>Remove SMART Product Drivers from your computer, and then install SMART Product Drivers again.</p>
	<p>A camera is obscured.</p>	<p>Remove any object attached to the interactive surface or resting in the bottom bezel behind the pen tray.</p>

Symptoms	Cause	Solution
There is a small red × on the SMART Board icon.	SMART Product Drivers is not detecting the interactive whiteboard.	Ensure that the USB cable is connected from your computer to the interactive whiteboard and that the USB cable isn't longer than 16' (5 m).
	SMART Board service isn't running.	Start SMART Board service: <ol style="list-style-type: none">1. In the notification area (Windows) or Dock (Mac), press the SMART software icon, and then press SMART Settings. SMART Settings opens.2. Select About Software and Product Support > Tools > Diagnostics. The <i>SMART Board Diagnostics</i> window opens.3. Select Service > Start.4. Close the <i>SMART Board Diagnostics</i> window, and then close SMART Settings.

Troubleshooting using the status light

If the interactive whiteboard has an active pen tray (models SBM680, SBM680E, SBM685 and SBM685E), you can also use the Select button's status light to help you identify and resolve issues with the interactive whiteboard. Refer to *Using the pen tray* on page 14 for information on the status light's states during normal operation.

NOTE

The pen ledge on SMART Board models SBM680V and SBM685V doesn't have a status light.

Status light	Cause	Solution
Off	The interactive whiteboard isn't receiving power or the USB cable is unplugged.	Reset the interactive whiteboard by disconnecting and then reconnecting the power cable at the wall outlet. Check that the USB cable is connected securely.
	The computer is in Sleep mode or the computer is off.	Touch the interactive whiteboard surface to wake up the computer or turn the computer on.
	You have selected a non-standard digital ink color using SMART Notebook software or SMART Ink.	Press a pen tray button to select a standard color or tool.
Solid amber	The controller module is in service mode or the firmware is being updated.	Wait for the firmware update to finish.
Flashing white	SMART Board service isn't running.	Start SMART Board service. To determine whether the SMART Board service is running, open SMART Settings and check the message that appears at the bottom.
	SMART Product Drivers isn't installed.	Install SMART Product Drivers on the computer. For details about installing SMART Product Drivers, see <i>Installing SMART Product Drivers</i> on page 7.

A solid white status light indicates that the interactive whiteboard is working properly. However, if the pen tray tools don't work as expected, try the following to resolve the issue.

- If another user reassigned the pen, eraser or other button functions, the tools might not work as expected. You can return them to normal operation using SMART Settings to change the SMART hardware settings.
- Reset the interactive whiteboard by disconnecting the power cable at the wall outlet and connecting it again.
- Calibrate the cameras to ensure that they accurately track your fingers and the pens (see *Calibrating the interactive whiteboard* on page 9).

Transporting the interactive whiteboard

Save the original SMART Board interactive whiteboard packaging so that it's available if you need to transport the interactive whiteboard. When required, repack the interactive whiteboard with all of the original packaging. This packaging was designed to provide the best possible protection against shock and vibration.

Contacting SMART Support

SMART Support welcomes your call. However, if you experience difficulty with your SMART product, consider contacting your authorized SMART reseller (smarttech.com/wheretobuy) first. Your reseller can often resolve the issue without delay.

Before you contact SMART Support, ensure the following:

- You know the serial number of the interactive whiteboard.
- The computer specifications and operating system meet the minimum requirements for SMART Product Drivers.
- The USB and power cables are connected properly to the computer and interactive whiteboard.
- Device drivers are installed on the computer's operating system.
- The interactive surface and bezels aren't obstructed.
- You have oriented the interactive whiteboard.

To determine the interactive whiteboard's serial number

Look on the lower right edge of the interactive whiteboard's frame when you're facing the front of the interactive whiteboard. The serial number is also on the back of the interactive whiteboard.

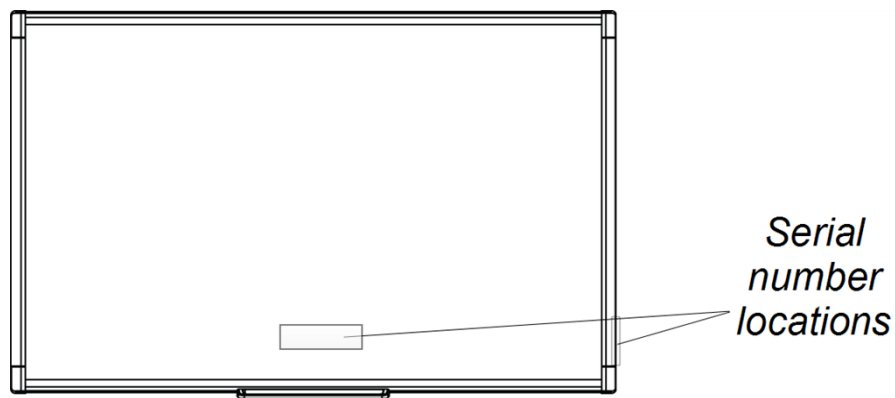

Appendix A

Hardware environmental compliance

SMART Technologies supports global efforts to ensure that electronic equipment is manufactured, sold and disposed of in a safe and environmentally friendly manner. For information about the interactive whiteboard's environmental compliance, see the specifications for your product located at smarttech.com/SupportSBM600.

Waste Electrical and Electronic Equipment and Battery regulations (WEEE and Battery Directives)

Electrical and electronic equipment and batteries contain substances that can be harmful to the environment and to human health. The crossed-out wheeled bin symbol indicates that products should be disposed of in the appropriate recycling stream and not as regular waste.



Batteries

Remote contains two zinc-carbon AAA batteries. Recycle or dispose of batteries properly.

SMART TECHNOLOGIES

smarttech.com/support

smarttech.com/contactsupport

smarttech.com/kb/170410